

# **WFS709TP ProSafe Smart Wireless Switch Hardware Installation Guide**

**NETGEAR®**

**NETGEAR, Inc.**  
4500 Great America Parkway  
Santa Clara, CA 95054 USA

202-10264-01  
May 2007

## Technical Support

Please refer to the support information card that shipped with your product. By registering your product at <http://www.netgear.com/register>, we can provide you with faster expert technical support and timely notices of product and software upgrades.

NETGEAR, INC. Support Information

Phone: 1-888-NETGEAR, for US & Canada only. For other countries, see your Support information card.

E-mail: [support@netgear.com](mailto:support@netgear.com)

North American NETGEAR website: <http://www.netgear.com>

## Trademarks

NETGEAR and the NETGEAR logo are registered trademarks of NETGEAR, Inc. in the United States and/or other countries. Other brand and product names are trademarks or registered trademarks of their respective holders. Information is subject to change without notice.

## Statement of Conditions

In the interest of improving internal design, operational function, and/or reliability, NETGEAR reserves the right to make changes to the products described in this document without notice.

NETGEAR does not assume any liability that may occur due to the use or application of the product(s) or circuit layout(s) described herein.

## Certificate of the Manufacturer/Importer

It is hereby certified that the WFS709TP ProSafe™ Smart Wireless Switch has been suppressed in accordance with the conditions set out in the BMPT-AmtsblVfg 243/1991 and Vfg 46/1992. The operation of some equipment (for example, test transmitters) in accordance with the regulations may, however, be subject to certain restrictions. Please refer to the notes in the operating instructions.

The Federal Office for Telecommunications Approvals has been notified of the placing of this equipment on the market and has been granted the right to test the series for compliance with the regulations.

## Bestätigung des Herstellers/Importeurs

Es wird hiermit bestätigt, daß das WFS709TP ProSafe Smart Wireless Switch gemäß der im BMPT-AmtsblVfg 243/1991 und Vfg 46/1992 aufgeführten Bestimmungen entstört ist. Das vorschriftsmäßige Betreiben einiger Geräte (z.B. Testsender) kann jedoch gewissen Beschränkungen unterliegen. Lesen Sie dazu bitte die Anmerkungen in der Betriebsanleitung.

Das Bundesamt für Zulassungen in der Telekommunikation wurde davon unterrichtet, daß dieses Gerät auf den Markt gebracht wurde und es ist berechtigt, die Serie auf die Erfüllung der Vorschriften hin zu überprüfen.

## Regulatory Compliance Information

This section includes user requirements for operating this product in accordance with National laws for usage of radio spectrum and operation of radio devices. Failure of the end user to comply with the applicable requirements may result in unlawful operation and adverse action against the end user by the applicable National regulatory authority.

**NOTE:** This product's firmware limits operation to only the channels allowed in a particular Region or Country. Therefore, all options described in this user's guide may not be available in your version of the product.

## United States

### FCC Class A

This equipment has been tested and found to comply with the limits for a Class A digital device, pursuant to Part 15 of the FCC Rules. These limits are designed to provide reasonable protection against harmful interference when the equipment is operated in a commercial environment. This equipment generates, uses, and can radiate radio frequency energy and, if not installed and used in accordance with the instruction manual, may cause harmful interference to radio communications. Operation of this equipment in a residential area is likely to cause harmful interference in which case the user will be required to correct the interference at their own expense.

Any changes or modifications not expressly approved by the party responsible for compliance could void the user's authority to operate this equipment.

This product is UL Listed (UL60950).

## Canada

This digital apparatus does not exceed the Class A limits for radio noise emissions from digital apparatus as set out in the interference-causing equipment standard entitled "Digital Apparatus," ICES-003 of the Department of Communications.

Cet appareil numérique respecte les limites de bruits radioélectriques applicables aux appareils numériques de Classe A prescrites dans la norme sur le matériel brouilleur: "Appareils Numériques," NMB-003 édictée par le ministère des Communications.

This product complies with CAN/CSA C22.2 No 60950 standards.

## Europe

The WFS709TP ProSafe Smart Wireless Switch is compliant with the following EU Council Directives: 89/336/EEC and LVD 73/23/EEC. Compliance is verified by testing to the following standards: EN55022 Class A, EN55024, and EN60950.



**Warning:** This is a Class A product. In a domestic environment, this product may cause radio interference in which case the user may be required to take adequate measures

## Japan

This equipment is in the Class A category (information equipment to be used in commercial and/or industrial areas) and conforms to the standards set by the Voluntary Control Council for Interference by Data Processing Equipment and Electronic Office Machines that are aimed at preventing radio interference in commercial and/or industrial areas. Consequently, when this equipment is used in a residential area or in an adjacent area thereto, radio interference may be caused to equipment such as radios and TV receivers.

## VCCI - Class A

この装置は、情報処理装置等電波障害自主規制協議会（VCCI）の基準に基づくクラス A 情報技術装置です。この装置を家庭環境で使用すると電波妨害を引き起こすことがあります。この場合には使用者が適切な対策を講ずるよう要求されることがあります。

## Korea

### Class A

주의	A급 기기 이 기기는 업무용으로 전자파 적합 등록을 한 기기이 오니 판매자 또는 사용자는 이 점을 주의하시기 바라며 만약 잘못 판매 또는 구입하였을 때에는 가정용으로 교환하시기 바랍니다.
----	--

## Australia/New Zealand

This product complies with AS/NZS CISPR 22 Class A standards.

## Rest of World

This product complies with CISPR 22 Class A standards

## Lithium Battery Safety Notice

This product contains a lithium battery which is replaceable only by a trained technician.

	<b>Caution:</b> The lithium battery may explode if it is incorrectly replaced. A trained technician should replace the battery with the same or equivalent type battery recommended by the manufacturer. Dispose of used batteries according to the manufacturer's instructions
--	---

## European Union RoHS



Netgear products comply with the EU Restriction of Hazardous Substances Directive 2002/95/EC (RoHS). EU RoHS restricts the use of specific hazardous materials in the manufacture of electrical and electronic equipment. Specifically, restricted materials under the RoHS Directive are Lead (including Solder used in printed circuit assemblies), Cadmium, Mercury, Hexavalent Chromium, and Bromine compounds of PBB and PBDE. Some Netgear products are subject to the exemptions listed in RoHS Directive Annex 7 (Lead in solder used in printed circuit assemblies). Products and packaging will be marked with the "RoHS" label shown at the left indicating conformance to this Directive.

## China RoHS



Netgear products comply with China environmental declaration requirements and are labeled with the "EFUP 50" label shown at the left.

### 有毒有害物质声明

### Hazardous Materials Declaration

部件名称 (Parts)	有毒有害物质或元素 (Hazardous Substances)					
	铅 Lead (Pb)	汞 Mercury (Hg)	镉 Cadmium (Cd)	六价铬 Chromium VI Compounds (Cr <sup>6+</sup> )	多溴联苯 Polybrominated Biphenyls (PBB)	多溴二苯醚 Polybrominated Diphenyl Ether (PBDE)
电路板 PCA Board	X	○	○	○	○	○
机械组件 Mechanical Subassembly	X	○	○	○	○	○
○: 表示该有毒有害物质在该部件所有均质材料中的含量均在SJ/T11363-2006标准规定的限量要求以下。 This component does not contain this hazardous substance above the maximum concentration values in homogeneous materials specified in the SJ/T11363-2006 Industry Standard.						
X: 表示该有毒有害物质至少在该部件的某一均质材料中的含量超出SJ/T11363-2006标准规定的限量要求。 This component does contain this hazardous substance above the maximum concentration values in homogeneous materials specified in the SJ/T11363-2006 Industry Standard.						
对销售之日的所售产品, 本表显示, 供应链的电子信息技术产品可能包含这些物质。 This table shows where these substances may be found in the supply chain of electronic information products, as of the date of sale of the enclosed product.						
此标志为针对所涉及产品的环保使用期标志, 某些零部件会有一个不同的环保使用期(例如, 电池单元模块)贴在其产品上。 此环保使用期限只适用于产品是在产品手册中所规定的条件下工作。 The Environment-Friendly Use Period (EFUP) for all enclosed products and their parts are per the symbol shown here. The Environment-Friendly Use Period is valid only when the product is operated under the conditions defined in the product manual.						

## Product and Publication Details

<b>Model Number:</b>	WFS709TP
<b>Publication Date:</b>	May 2007
<b>Product Family:</b>	Wireless
<b>Product Name:</b>	WFS709TP ProSafe Smart Wireless Switch
<b>Home or Business Product:</b>	Business
<b>Language:</b>	English
<b>Publication Part Number:</b>	202-10264-01
<b>Publication Version Number:</b>	1.0

# Contents

## About This Manual

Conventions, Formats, and Scope .....	ix
How to Use This Manual .....	x
How to Print this Manual.....	x
Revision History.....	xi

## Chapter 1.

### Introduction

WFS709TP ProSafe Smart Wireless Switch Overview .....	1-1
Front and Rear View .....	1-2
System Indicator LEDs .....	1-2
Fast Ethernet Ports .....	1-3
GE Uplink Port .....	1-5
Serial Console Port .....	1-5
Fans/Heat Exhaust .....	1-6
Rack Mounting Brackets .....	1-6
Power Input Socket .....	1-6
Task Overview .....	1-6
NETGEAR Smart Wireless Components .....	1-6
Deployment Summary .....	1-7

## Chapter 2.

### Installing the Chassis

Pre-Installation Checklist .....	2-1
Precautions .....	2-2
Requirements .....	2-3
Mounting the Chassis .....	2-4
Connecting Power .....	2-6
Verifying the Installation .....	2-7

**Appendix A.**  
**Cables and Connector Pinouts**

Fast Ethernet Network Ports ..... A-1  
    RJ-45 Pinouts ..... A-1  
    Cables ..... A-1  
GE Uplink Port ..... A-2  
    1000BASE-T (Copper) GE Cable ..... A-2  
Serial Console Port ..... A-3  
    Port and Adapter Pinouts ..... A-3  
    Console Terminal Settings ..... A-4

**Appendix B.**  
**Specifications**

Physical ..... B-1  
Environmental ..... B-1  
Operational ..... B-2

**Appendix C.**  
**Related Documents**



# About This Manual

The *WFS709TP ProSafe™ Smart Wireless Switch Hardware Installation Guide* describes how to install the WFS709TP ProSafe Smart Wireless Switch. The information in this manual is intended for trained technicians responsible for installing this product.

## Conventions, Formats, and Scope

---

The conventions, formats, and scope of this manual are described in the following paragraphs:

- **Typographical Conventions.** This manual uses the following typographical conventions:

<i>Italic</i>	Emphasis, books, CDs, file and server names, extensions
<b>Bold</b>	User input, IP addresses, GUI screen text
Fixed	Command prompt, CLI text, code
<i>italic</i>	URL links

- **Formats.** This manual uses the following formats to highlight special messages:

	<b>Note:</b> This format is used to highlight information of importance or special interest.
---	--

	<b>Tip:</b> This format is used to highlight a procedure that will save time or resources.
---	--

	<b>Warning:</b> Ignoring this type of note may result in a malfunction or damage to the equipment.
---	--



**Danger:** This is a safety warning. Failure to take heed of this notice may result in personal injury or death.

- **Scope.** This manual is written for the WFS709TP according to these specifications:

Product Version	WFS709TP ProSafe Smart Wireless Switch
Manual Publication Date	May 2007

For more information about network, wireless, and firewall technologies, see the links to the NETGEAR website in [Appendix C, “Related Documents”](#).







**Note:** Product updates are available on the NETGEAR, Inc. website at <http://www.netgear.com/support>.

## How to Use This Manual

---

The HTML version of this manual includes the following:

- Buttons,  and , for browsing forwards or backwards through the manual one page at a time
- A  button that displays the table of contents and an  button. Double-click on a link in the table of contents or index to navigate directly to where the topic is described in the manual
- A  button to access the full NETGEAR, Inc. online knowledge base for the product model
- Links to PDF versions of the full manual and individual chapters

## How to Print this Manual

---

To print this manual, choose one of the following options:

- **Printing a Page from HTML.** Each page in the HTML version of the manual is dedicated to a major topic. Select File > Print from the browser menu to print the page contents.

- **Printing from PDF.** Your computer must have the free Adobe Acrobat reader installed in order to view and print PDF files. The Acrobat reader is available on the Adobe website at <http://www.adobe.com>.
  - **Printing a PDF Chapter.** Use the *PDF of This Chapter* link at the top left of any page.
    - Click the *PDF of This Chapter* link at the top left of any page in the chapter you want to print. The PDF version of the chapter you were viewing opens in a browser window.
    - Click the print icon in the upper left of your browser window.
  - **Printing a PDF version of the Complete Manual.** Use the *Complete PDF Manual* link at the top left of any page.
    - Click the *Complete PDF Manual* link at the top left of any page in the manual. The PDF version of the complete manual opens in a browser window.
    - Click the print icon in the upper left of your browser window.



**Tip:** If your printer supports printing two pages on a single sheet of paper, you can save paper and printer ink by selecting this feature.

## Revision History

---

Part Number	Version Number	Date	Description
202-10264-01	1.0	May 2007	Initial NETGEAR release.



# Chapter 1

## Introduction

The WFS709TP ProSafe Smart Wireless Switch is a full-featured wireless switch that centrally manages NETGEAR access points, delivering integrated wireless mobility, security, and converged services for both wired and wireless users.

This chapter contains the following topics:

- [“WFS709TP ProSafe Smart Wireless Switch Overview”](#)
- [“Front and Rear View”](#)
- [“Task Overview”](#)

Once you are familiar with the system, you can begin the installation process described in the next chapter.

### **WFS709TP ProSafe Smart Wireless Switch Overview**

---

The following list identifies the key features of the WFS709TP ProSafe Smart Wireless Switch:

- Supports up to 16 access points.
- Eight 10/100 Mbps Fast Ethernet (FE) ports with Power over Ethernet (PoE) capability.
- One Gigabit Ethernet (GE) uplink port.
- One serial console port.
- Built-in RF planning tool.
- Wireless Intrusion Detection and Protection.
- Advanced security features such as 802.1x, support for EAP-PEAP, EAP-TLS, EAP-TTLS, 802.11i, MAC address, SSID, and location-based authentication.
- Unifies wireless and wired access without compromising on security, mobility, or performance.
- Provides centralized management and monitoring of the wireless infrastructure.
- High-speed Layer-2/Layer-3 packet forwarding.

- 1U chassis can be mounted in a standard 19-inch network equipment rack.
- The firmware can be easily upgraded as future software releases are made available. You can install upgrades using HTTP.

## Front and Rear View

The standard version of the WFS709TP ProSafe Smart Wireless Switch contains a 1000BASE-T copper Gigabit Ethernet (GE) connector. Figure 1-1 shows the front and rear views of the switch.

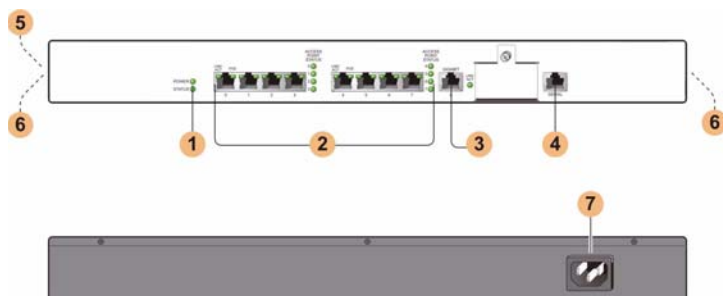

Figure 1-1

### System Indicator LEDs 1

The system LEDs, located on the front of the switch, display the status of system power and operation.

Table 1-1. System LEDs

LED	State	Description
Power	Green	WFS709TP is receiving proper power.
	Off	WFS709TP is powered off.
Status	Green	WFS709TP has booted and is functioning properly.
	Off	WFS709TP is booting, loading software, or has failed. Note: This LED remains off until you perform the initial setup described in the document <i>Installation Guide: WFS709TP ProSafe Smart Wireless Switch</i> .

## Fast Ethernet Ports 2

Use the network to connect access points (APs) as well as wired LAN segments. The ports provide 10/100 Mbps Fast Ethernet (FE) connectivity, and can provide power and serial connectivity to compatible devices.

### Power over Ethernet

Each FE port supports IEEE 802.3af Power over Ethernet (PoE).

When a compatible POE device such as the NETGEAR WAGL102 or WGL102 access point is connected to a network port, the port can provide operating power to that device through the connected Ethernet cable. This allows APs to be installed in areas where electrical outlets are unavailable, undesirable, or not permitted, such as in the plenum and air-handling spaces. The network ports automatically detect when compatible PoE devices are connected and require power.

Special cables and adapters may be necessary to use PoE features with some equipment. See [Appendix A, “Cables and Connector Pinouts”](#) for port and cable specifications.

### Port and LED Locations

Figure 1-2 shows the FE ports and the location of the port LEDs.

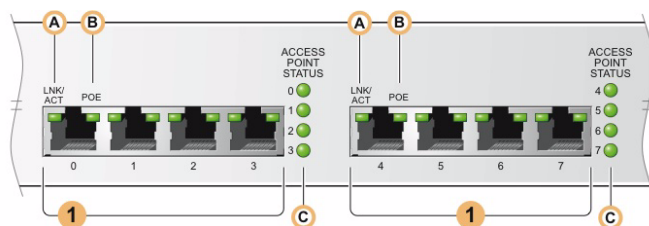

Figure 1-2

**FE Network Ports 1** ! The eight FE ports are split into two four-port blocks and numbered 0 through 7. Each FE port has three informational, multi-color LEDs. These LEDs are:

- LNK/ACT A
- POE B
- ACCESS POINT STATUS C

**Port LNK/ACT LEDs.** Each FE port has its own LNK/ACT LED on the upper-left side of the port. During operation, these LEDs provide the following Ethernet link status information:

Status	Description
Off	No Ethernet link on the port.
Green	An Ethernet link has been established on the port, but no data is currently being transmitted or received.
Flashing Green	The port is transmitting or receiving data. The flashing rate is proportional to the network activity.
Amber	The Ethernet link on the port is encountering errors.

**Port PoE LEDs.** Each FE port has its own PoE LED on the upper-right side of the port. This LED provides the following PoE status information:

Status	Description
Off	The port is disabled, or the attached device has not requested power. PoE is not being provided by the port.
Green	PoE is being provided to the attached device.
Amber	The attached device has requested power, but POE is not being provided by the port.

**ACCESS POINT STATUS LEDs.** Each FE port has an identically numbered Access Point Status LED that represents the status of APs connected to that port on the WFS709TP ProSafe Smart Wireless Switch. During operation, the LEDs provide the following AP status information:

Status	Description
Red (solid)	An AP on this port has failed (highest precedence).
Red (flashing)	An air monitor on this port has detected an unsecured AP. The AP is attached to your network but is not listed in the security policies. If security policies are enabled, clients are not granted access to your network through the unsecured AP.
Green (flashing)	An air monitor on this port has detected interference. The interfering device (AP or other radio source) has been detected by your valid APs, but has no wired presence on your network.
Amber (solid)	Load balancing is enabled on this port, or an AP has reached the maximum number of clients it is configured to support.
Green (solid)	All detected APs on this port are operating as expected.
Off	No AP is detected on the port (lowest precedence).



The LED states are listed in order of precedence (highest to lowest). If more than one AP is connected to the port, the state with the highest precedence is displayed.

## GE Uplink Port 3

The WFS709TP ProSafe Smart Wireless Switch provides one Gigabit Ethernet (GE) 10/100/1000 Mbps 1000BASE-T copper port for high-bandwidth connection between the switch and the wired LAN. The port automatically senses and negotiates speed, duplex, and MDI/MDX settings.

Figure 1-3 shows the following callouts:

- Gigabit Ethernet port 1
- LNK/ACT LED, which provides the following information: 2

Status	Description
Off	No Ethernet link on the port.
Green	An Ethernet link has been established on the port, but no data is currently being transmitted or received.
Flashing Green	The port is transmitting or receiving data. The flashing rate is proportional to your network activity.

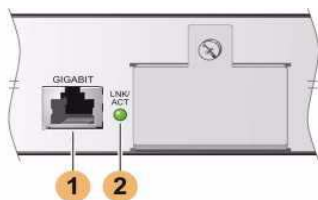

Figure 1-3

See “GE Uplink Port” on page A-2 for cable specifications.



**Note:** The Gigabit interface is not user-replaceable. Do not remove the port cover plate.

## Serial Console Port 4

Use this port to connect a local management console. This connection can be used to access the text-based command-line interface (CLI) for initial configuration of the WFS709TP.

The port accepts an RS-232 serial cable with an RJ-45 male connector. See [“Serial Console Port” on page A-3](#) for more port and cable specifications.

## Fans/Heat Exhaust 5

Three independent fans located on the side of the chassis promote proper air circulation for cooling the WFS709TP ProSafe Smart Wireless Switch.

During operation, the air vents on the left and right sides of the chassis must remain unobstructed by cables or mounting equipment. For proper air circulation, leave at least 10 cm (4 inches) of clearance on the left and right of the chassis.

## Rack Mounting Brackets 6

Mounting brackets are attached to each side of the chassis.

## Power Input Socket 7

The power input socket on the chassis rear panel accepts a power cord with a standard IEC320 connector. For proper safety and performance, the power cord must be rated to 10 A and must conform to grounded electrical standards in the country in which the switch operates.

## Task Overview

---

As with any full-featured network equipment, deployment may involve multiple components as well as various individuals in your organization. As the network manager, you should become familiar with the components and deployment summary outlined in the following sections.

## NETGEAR Smart Wireless Components

Familiarize yourself with these three major components:

- **WFS709TP Switch.** This is an enterprise-class switch into which multiple access points (APs) are connected and controlled. NETGEAR Wireless Access Points designed for small and mid-sized businesses with enterprise-class features can function as either access points or air monitors.

- **Wireless Access Point.** The NETGEAR WAGL102 and WGL102 are designed for this solution, and provide the best features and easiest integration. Several other NETGEAR access point products can be repurposed to work with the WFS709TP. Refer to the NETGEAR support site for a list of which NETGEAR APs can be repurposed, and for instructions on how to do so. For full instructions on changing the switch's default values, refer to the *WFS709TP ProSafe Smart Wireless Switch Software Administration Manual*. The *Resource CD* provides a link to this manual, or you can download it from <http://www.netgear.com/support>.
- **WFS709TP Software.** This software integrates the switch and APs to provide load balancing, rate limiting, self healing, authentication, mobility, encryption, and centralization for monitoring and upgrades. This software is integrated into the switch and access point.

## Deployment Summary

This section outlines the tasks involved in deploying the WFS709TP ProSafe Smart Wireless Switch.



**Note:** You can download the *WFS709TP ProSafe Smart Wireless Switch Software Administration Manual* from the NETGEAR website at <http://www.netgear.com/support>.

### 1. Physical installation of the WFS709TP ProSafe Smart Wireless Switch

Installation requires a trained technician who is experienced with handling and installing similar equipment. This phase involves the following tasks:

- Transport, unpack, and mount the switch in a suitable rack environment.
- Attach power and a console.
- Boot the system and perform the initial power-on test, examining the LEDs and console messages to ensure proper operation.

[Chapter 2, “Installing the Chassis”](#) in this document provides the necessary instructions.

### 2. Initial configuration of the WFS709TP ProSafe Smart Wireless Switch

Configuration requires someone who understands the company's wired network and has experience with the physical and logical management and configuration of routers, switches, servers, and clients. This phase involves the following tasks:

- Use the console to perform initial configuration of the WFS709TP.
- Attach the WFS709TP to the network.

### 3. Planning the location of access points and air monitors

You can manually determine the locations for APs, or use a Web browser to access the switch's built-in RF Plan tool and perform the following tasks:

- Define the physical site parameters.
- Determine how many access points are needed and where they should be located.
- Simulate network failures and recovery characteristics, and adjust placement if necessary.

#### 4. Physical installation of the Wireless Access Points

Refer to the document *Installation Guide: WFS709TP ProSafe Smart Wireless Switch* and to the documentation included with your access points.

#### 5. Advanced configuration of the WFS709TP ProSafe Smart Wireless Switch

Configuration requires someone who understands the company's network and has experience managing routers, switches, servers, and clients. The following tasks are involved:

- Configure the planned network features via the Web interface.
- Test and verify the deployment.

The *WFS709TP ProSafe Smart Wireless Switch Software Administration Manual* provides information and examples of the switch's more advanced features.

# Chapter 2

## Installing the Chassis

This chapter covers the following topics

- “Pre-Installation Checklist”
- “Precautions”
- “Requirements”
- “Mounting the Chassis”
- “Connecting Power”
- “Verifying the Installation”



**Warning:** Installation should be performed by a trained technician.

### Pre-Installation Checklist

---

Inspect the package to ensure that the following components shipped with your WFS709TP ProSafe Smart Wireless Switch:

- WFS709TP ProSafe Smart Wireless Switch
- Four 12-24 screws for attaching the chassis to an equipment rack
- AC power cord rated to at least 10 A with IED320 connector
- RS-232 serial cable with RJ-45 male connectors and serial adapter to connect the serial cable to a terminal or PC with a DB-9 serial port
- Ethernet cable
- *Installation Guide: WFS709TP ProSafe Smart Wireless Switch* (Quick Install Guide)
- *Resource CD*
- Support Information Card
- Warranty Card

During installation, you will need a Phillips or cross-head screwdriver.



**Note:** There should be another person available to help position the chassis.

## Precautions

---

Observe the following precautions during installation:

- Hazardous energy is always present while the WFS709TP is plugged into an electrical outlet. Remove all rings, jewelry, and other potentially conductive material before working with this product.
- Never insert foreign objects into the chassis or any other component, even when the WFS709TP is unpowered or unplugged.
- Main power is fully disconnected from the WFS709TP by unplugging the power cord from the power outlet. For safety reasons, verify that the power outlet and plug are within easy reach of the operator.
- Do not handle electrical cables which are not insulated. This includes any network cables.
- To minimize electrical hazard, keep water and other fluids away from the product.
- Comply with electrical grounding standards during all phases of installation and operation of the product. Do not allow the WFS709TP chassis, network ports, power source, or mounting brackets to contact any device, cable, object, or person attached to a different electrical ground. Also, never connect the device to external storm grounding sources.
- Installation or removal of the chassis must be performed in a static-free environment. The proper use of anti-static body straps and mats is strongly recommended.
- Do not ship or store this product near strong electromagnetic, electrostatic, magnetic, or radioactive fields.
- Do not disassemble the chassis. This product has no internal serviceable parts. When service or repair is needed, see [“Technical Support” on page ii](#).

## Requirements

---

The WFS709TP ProSafe Smart Wireless Switch is shipped with mounting brackets already attached so that you can mount the chassis into a standard 19-inch equipment rack.



**Note:** The four 12-24 screws included with the WFS709TP are intended for securing the chassis to the rack. Some racks require different sized screws which are not included. Make sure that you have the correct screws or fasteners for your rack system before attempting to mount the chassis.

The WFS709TP, like other network and computing devices, requires compliance with operational specifications:

- Reliable power
  - Make sure that your electrical outlet is compatible with the WFS709TP. For power requirements, see [Appendix B, “Specifications”](#).
  - Power cords must be rated to 10 A and must conform to grounded electrical standards in the country in which the WFS709TP operates.
  - Use of a power line conditioner or Uninterruptible Power Supply (UPS) can decrease or mitigate problems caused by power service fluctuations. Make sure that the output of any power shaping device is compatible with the WFS709TP power supply.
- Cool, non-condensing ventilation
  - For operating environment information, see [Appendix B, “Specifications”](#).
  - Where a large number of electrical devices are running in the same area, additional air conditioning or air circulation equipment may be required.
- Ample space
  - For proper air circulation, leave at least 10 cm (4 inches) clearance for the vents on the left and right of the chassis.
  - Leave additional space in front and back of the chassis to access power cords, network cables, and indicator LEDs.
- Limited electromagnetic interference

For best operation, keep the WFS709TP and all cords and cables at least 0.7 meters (2 feet) from fluorescent lighting fixtures, and 2 meters (6 feet) from photocopiers, radio transmitters, electric generators, and other sources of strong electromagnetic interference. See also [Appendix B, “Specifications”](#).

## Mounting the Chassis

---

This section provides instructions for installing the WFS709TP ProSafe Smart Wireless Switch.

1. Make sure that your rack environment meets the installation requirements listed on [page 2-3](#).
2. Attach the WFS709TP to the rack, as described in the following section



**Warning:** To avoid personal injury or damage to equipment, get help in lifting and positioning the WFS709TP. Also, do not install the WFS709TP where instability or uneven mechanical loading may occur.



**Note:** For proper operation, make sure your rack environment is in compliance with the operating temperatures described in [Appendix B, “Specifications”](#).

- Position the chassis in the equipment rack and align the brackets' mounting holes with the corresponding holes in your rack frame ([Figure 2-1 on page 2-5](#)).



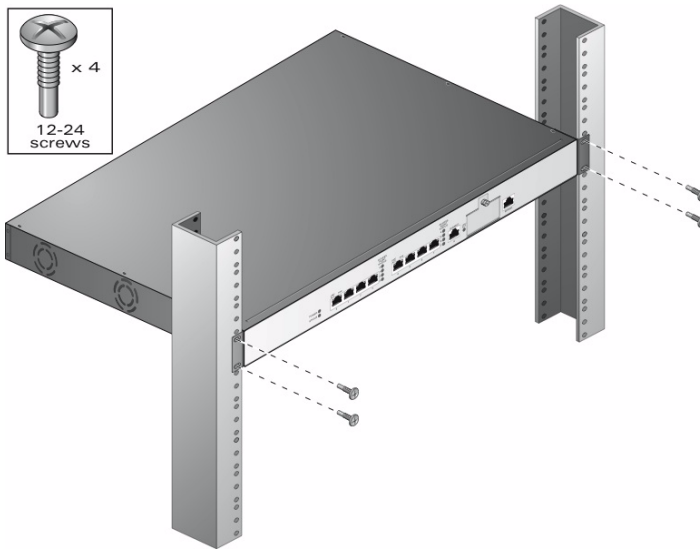

**Figure 2-1**

- Use a Phillips or cross-head screwdriver to secure the chassis to the rack with two 12-24 screws (included) for each mounting bracket.



**Note:** Some racks require different screws which are not included. Make sure that you use the correct screws or fasteners for your rack system.

3. Ensure that there is adequate clearance around the chassis ([Figure 2-2 on page 2-6](#)).
  - For proper air circulation, leave at least 10 cm (4 inches) clearance for the vents on the left and right of the chassis.
  - Allow additional space in front and back of the chassis to access power cords, network cables, and indicator LEDs.

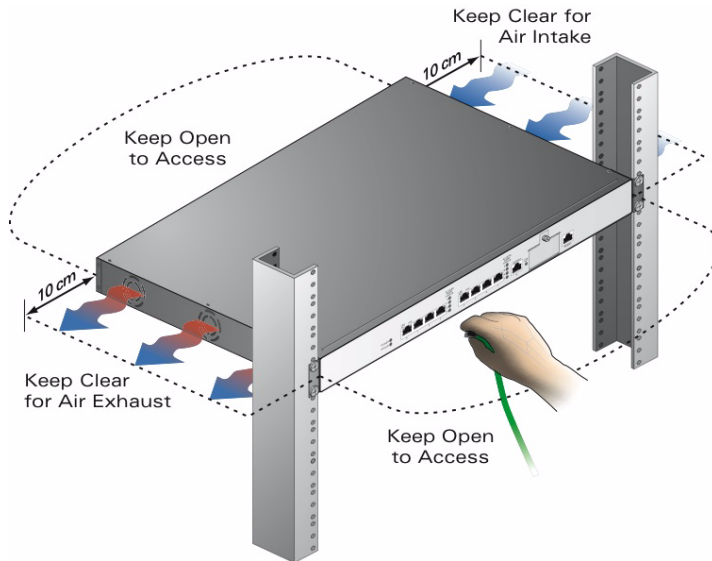

Figure 2-2

## Connecting Power

---



**Warning:** This procedure should be performed by a trained technician.

1. Make sure you understand the procedure and all precautions.

Before beginning, read the entire procedure. Make sure you understand all the precautions in these steps, as well as those listed on [page 2-2](#).

2. Make sure that your site's electrical system is compatible with the WFS709TP. See [Appendix B, "Specifications"](#).



**Note:** Use of a power line conditioner or Uninterruptible Power Supply (UPS) can decrease or mitigate problems caused by power service fluctuations. Make sure that the output of any power shaping device is compatible with the WFS709TP power supplies.

3. Make sure that the power supply can handle the connected Power over Ethernet (PoE) devices.

	<b>Note:</b> The total power drawn by all connected PoE devices must not exceed 100 Watts. For power ratings for NETGEAR APs, refer to the access point installation guide.
---	---

4. Attach the power cord to the power input socket at the back of the chassis.

Plug an appropriate power cord into the power input socket. Use the included power cord if it is compatible with your electrical outlet. Otherwise, replace the power cord with the type appropriate for your country. The power input socket accepts a power cord with a standard IEC320 connector.

	<b>Warning:</b> For proper safety and performance, the power cord must be rated to 10 A and conform to grounded electrical standards in the country where the product is operated.
---	--

5. Attach the power cord to a proper electrical outlet to power up the WFS709TP.

	<b>Warning:</b> For safety reasons, make sure the power outlet and plug are within easy reach of the operator and can be quickly disconnected if necessary.
---	---

Once power is connected, the WFS709TP automatically turns on and you can perform the power-on test.

## Verifying the Installation

---

After the WFS709TP ProSafe Smart Wireless Switch is installed and connected to power, verify the following:

1. Check that the Power LED lights solid green immediately upon power up and remains solid green during and after boot.

	<b>Note:</b> The Status LED remains off until you perform the initial setup.
---	--

For more information on LED behavior, see [“System Indicator LEDs”](#) on page 1-2.

2. Check the fans to verify they are working.

You should be able to hear the fans operating and feel significant airflow blowing from the chassis vents at each of the three fan positions.



**Warning:** If one or more fans do not work, immediately shut down and contact NETGEAR.

3. Connect appropriate network cables (see [Appendix A, “Cables and Connector Pinouts”](#) for port and cable information).
4. Perform the initial setup as described in *Installation Guide: WFS709TP ProSafe Smart Wireless Switch*.

# Appendix A

## Cables and Connector Pinouts

This appendix describes cables and connector pinouts for ports on the WFS709TP ProSafe Smart Wireless Switch.

### Fast Ethernet Network Ports

#### RJ-45 Pinouts

The RJ-45 female connector pinouts are shown in [Figure A-1](#):

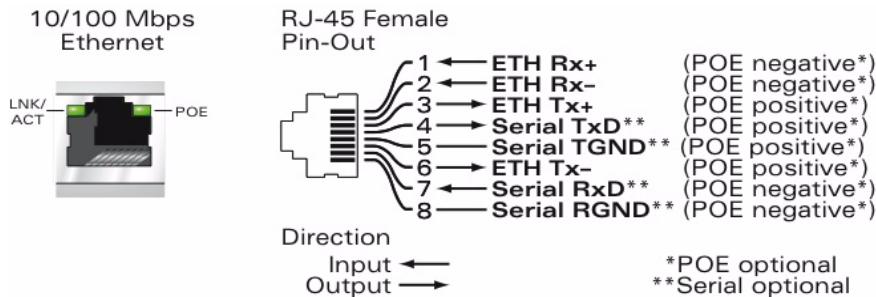

Figure A-1

#### Cables

The type of cable required for each port depends on the device being connected.



**Note:** Refer to the document *Installation Guide: ProSafe Wireless Access Point* for information about specific power requirements.

- **Direct connection to a POE-compatible device**

This requires a 4- or 8-conductor Category 5 UTP Ethernet cable with an RJ-45 male connector. A straight-through cable is required to preserve POE voltage polarity.

For PoE, the port should be connected directly to the intended device with no intervening hubs, routers, switches, or other network equipment.

- **Connection to a regular 10/100 Mbps Ethernet segment**

This requires a 4- or 8-conductor Category 5 UTP Ethernet cable with an RJ-45 male connector. The port detects MDI/MDX and automatically adjusts for straight-through or crossover cables.

The maximum length for FE cables is 100 meters (325 feet).

Cables that run through plenums or air-handling spaces as described in NEC (2002) Article 300.22(C) should be suitable under NEC Article 800.50 and marked accordingly for use in plenums and air-handling spaces with regard to smoke propagation, such as CL2-P, CL3-P, MPP, or CMP.



**Note:** Be sure to install cables in accordance with all applicable local regulations and practices.

## GE Uplink Port

---

### 1000BASE-T (Copper) GE Cable

Table A-1 lists the cable characteristics for the 1000BASE-T GE uplink port.

**Table A-1. Copper GE Cable Characteristics**

Item	Specification
Cable	Category 5 UTP
Connector	RJ-45
Range	Up to 100 m (325 feet)

## Serial Console Port

The serial console port is located on the front panel of the WFS709TP. This port is for connecting a local management console and can be used to access the text-based command-line interface (CLI) to configure, manage, and troubleshoot the switch.



**Warning:** Do not connect access points to the serial console port. The serial port is designed to connect to RS-232-only devices. Non-RS-232 devices such as APs will cause the WFS709TP to fail and can cause damage.

## Port and Adapter Pinouts

The serial console port's RJ-45 female connector accepts an RS-232 serial cable with a male connector. Pinouts are shown in [Figure A-2](#):

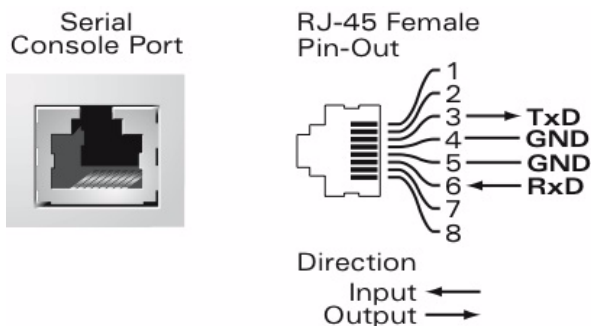

Figure A-2

To connect the required RS-232 serial cable to a terminal with a DB-9 male port, use the included adapter. Pinouts are shown in [Figure A-3](#):

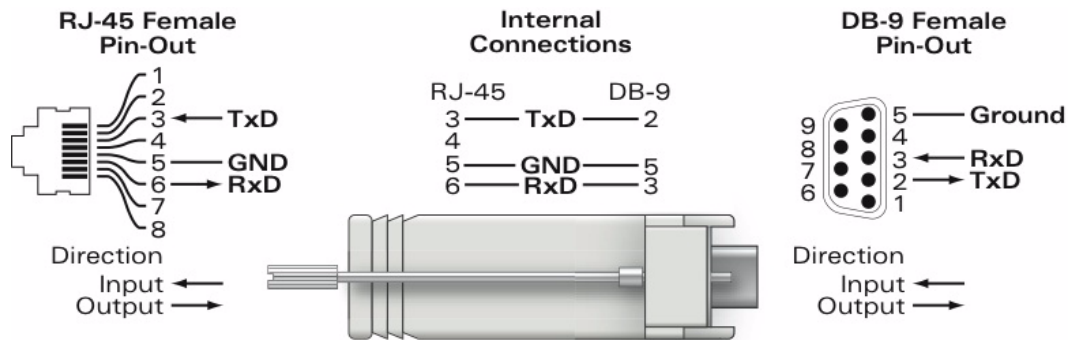

Figure A-3

## Console Terminal Settings

[Table A-2](#) contains the settings for a console terminal connected to the serial port.

Table A-2. Console Terminal Settings

Baud Rate	Data Bits	Parity	Stop Bits	Flow Control
9600	8	None	1	None



# Appendix B Specifications

## Physical

---

**Table B-1. Physical Specifications**

Item	Specification
Physical Dimensions:	
Size	Height 4.45 cm (1.75 inches) Width 44.2 cm (17.4 inches) Depth 33.0 cm (13.0 inches)
Weight	4.5 kg (10 lb)
Shipping Dimensions:	
Size	Height 25.4 cm (10 inches) Width 60.96 cm (24 inches) Depth 55.88 cm (22 inches)
Weight	8.62 kg (19 lb)

## Environmental

---

**Table B-2. Environmental Specifications**

Item	Specification
Temperature	Operating: 0 to 40 °C (32 to 104 °F) Storage: 0 to 50 °C (32 to 122 °F)
Humidity	5% to 95% (non-condensing)
Altitude	Up to 10,000 feet (3048 m)

## Operational

---

**Table B-3. Operational Specifications**

Item	Specification
Power Consumption	170 Watts, maximum
AC Input Voltage	90~132VAC, 180-264VAC, auto-sensing
AC Input Current	4A @ 110VAC
AC Input Frequency	47-63 Hz
Output Voltage	48VDC 802.3af (maximum aggregate power draw for PoE is 100 Watts)
Standards	IEEE 802.1x, IEEE 802.3 10BASE-T, IEEE 802.3u 100BASE-TX, IEEE 802.3ab 1000BASE-T

# Appendix C

## Related Documents

This appendix provides links to reference documents you can use to gain a more complete understanding of the technologies used in your NETGEAR product.

<b>Document</b>	<b>Link</b>
Internet Networking and TCP/IP Addressing	<a href="http://documentation.netgear.com/reference/enu/tcpip/index.htm">http://documentation.netgear.com/reference/enu/tcpip/index.htm</a>
Wireless Communications	<a href="http://documentation.netgear.com/reference/enu/wireless/index.htm">http://documentation.netgear.com/reference/enu/wireless/index.htm</a>
Preparing a Computer for Network Access	<a href="http://documentation.netgear.com/reference/enu/wsdhcp/index.htm">http://documentation.netgear.com/reference/enu/wsdhcp/index.htm</a>
Glossary	<a href="http://documentation.netgear.com/reference/enu/glossary/index.htm">http://documentation.netgear.com/reference/enu/glossary/index.htm</a>



## Free Manuals Download Website

<http://myh66.com>

<http://usermanuals.us>

<http://www.somanuals.com>

<http://www.4manuals.cc>

<http://www.manual-lib.com>

<http://www.404manual.com>

<http://www.luxmanual.com>

<http://aubethermostatmanual.com>

Golf course search by state

<http://golfingnear.com>

Email search by domain

<http://emailbydomain.com>

Auto manuals search

<http://auto.somanuals.com>

TV manuals search

<http://tv.somanuals.com>