

# VANGUARD®

## INFRARED VENT-FREE NATURAL GAS HEATER OWNER'S OPERATION AND INSTALLATION MANUAL

VN1800ITB  
and  
VN2550ITB

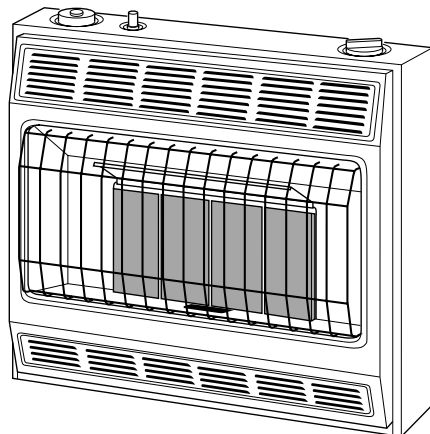

**WARNING:** If the information in this manual is not followed exactly, a fire or explosion may result causing property damage, personal injury, or loss of life.

- Do not store or use gasoline or other flammable vapors and liquids in the vicinity of this or any other appliance.
- **WHAT TO DO IF YOU SMELL GAS**
  - Do not try to light any appliance.
  - Do not touch any electrical switch; do not use any phone in your building.
  - Immediately call your gas supplier from a neighbor's phone. Follow the gas supplier's instructions.
  - If you cannot reach your gas supplier, call the fire department.
- Installation and service must be performed by a qualified installer, service agency, or the gas supplier.

**WARNING:** Improper installation, adjustment, alteration, service, or maintenance can cause injury or property damage. Refer to this manual for correct installation and operational procedures. For assistance or additional information consult a qualified installer, service agency, or the gas supplier.

**WARNING:** This is an unvented gas-fired heater. It uses air (oxygen) from the room in which it is installed. Provisions for adequate combustion and ventilation air must be provided. Refer to *Air For Combustion and Ventilation* on page 4 of this manual.

This appliance may be installed in an aftermarket\*, permanently located, manufactured (mobile) home, where not prohibited by local codes.

This appliance is only for use with the type of gas indicated on the rating plate. This appliance is not convertible for use with other gases.

\*Aftermarket: Completion of sale, not for purpose of resale, from the manufacturer

**Save this manual for future reference.**

# VANGUARD

## VENT-FREE NATURAL GAS HEATER

### SAFETY INFORMATION

#### WARNINGS

**IMPORTANT:** Read this owner's manual carefully and completely before trying to assemble, operate, or service this heater. Improper use of this heater can cause serious injury or death from burns, fire, explosion, electrical shock, and carbon monoxide poisoning.

** DANGER:** Carbon monoxide poisoning may lead to death!

**Carbon Monoxide Poisoning:** Early signs of carbon monoxide poisoning resemble the flu, with headaches, dizziness, or nausea. If you have these signs, the heater may not be working properly. **Get fresh air at once!** Have heater serviced. Some people are more affected by carbon monoxide than others. These include pregnant women, persons with heart or lung disease or anemia, those under the influence of alcohol, and those at high altitudes.

**Natural Gas:** Natural gas is odorless. An odor-making agent is added to natural gas. The odor helps you detect a natural gas leak. However, the odor added to natural gas can fade. Natural gas may be present even though no odor exists.

Make certain you read and understand all warnings. Keep this manual for reference. It is your guide to safe and proper operation of this heater.

** WARNING:** Any change to this heater or its controls can be dangerous.

** WARNING:** Do not use any accessory not approved for use with this heater.

**Due to high temperatures, the appliance should be located out of traffic and away from furniture and draperies.**

**Do not place clothing or other flammable material on or near the appliance. Never place any objects on the heater.**

**Surface of heater becomes very hot when running heater. Keep children and adults away from hot surface to avoid burns or clothing ignition. Heater will remain hot for a time after shut-down. Allow surface to cool before touching.**

**Carefully supervise young children when they are in the same room with heater.**

**Make sure grill guard is in place before running heater.**

**Keep the appliance area clear and free from combustible materials, gasoline, and other flammable vapors and liquids.**

1. This appliance is only for use with the type of gas indicated on the rating plate. This appliance is not convertible for use with other gases.
2. If you smell gas
  - Shut off gas supply.
  - Do not try to light any appliance.
  - Do not touch any electrical switch; do not use any phone in your building.
  - Immediately call your gas supplier from a neighbor's phone. Follow the gas supplier's instructions.
  - If you cannot reach your gas supplier, call the fire department
3. This heater shall not be installed in a bedroom or bathroom.
4. Always run heater with plaque control knob at the 1, 2, 3, or 4 locked positions. Never set control knob between locked positions. Poor combustion and higher levels of carbon monoxide may result.
5. This heater needs fresh, outside air ventilation to run properly. This heater has an Oxygen Depletion Sensing (ODS) safety shutoff system. The ODS shuts down the heater if not enough fresh air is available. See *Air for Combustion and Ventilation*, pages 4 through 6.
6. Keep all air openings in front and bottom of heater clear and free of debris. This will insure enough air for proper combustion.
7. If heater shuts off, do not relight until you provide fresh, outside air. If heater keeps shutting off, have it serviced.
8. Before using furniture polish, wax, carpet cleaner or similar products, turn heater off. If heated, the vapors from these products may create a white powder residue within burner box or on adjacent walls or furniture.
9. Do not run heater
  - where flammable liquids or vapors are used or stored
  - under dusty conditions
10. Do not use heater if any part has been under water. Immediately call a qualified service technician to inspect the room heater and to replace any part of the control system and any gas control which has been under water.
11. Turn off and unplug heater and let cool before servicing. Only a qualified service person should service and repair heater.
12. Operating heater above elevations of 4,500 feet could cause pilot outage.

# OWNER'S MANUAL

## PRODUCT IDENTIFICATION

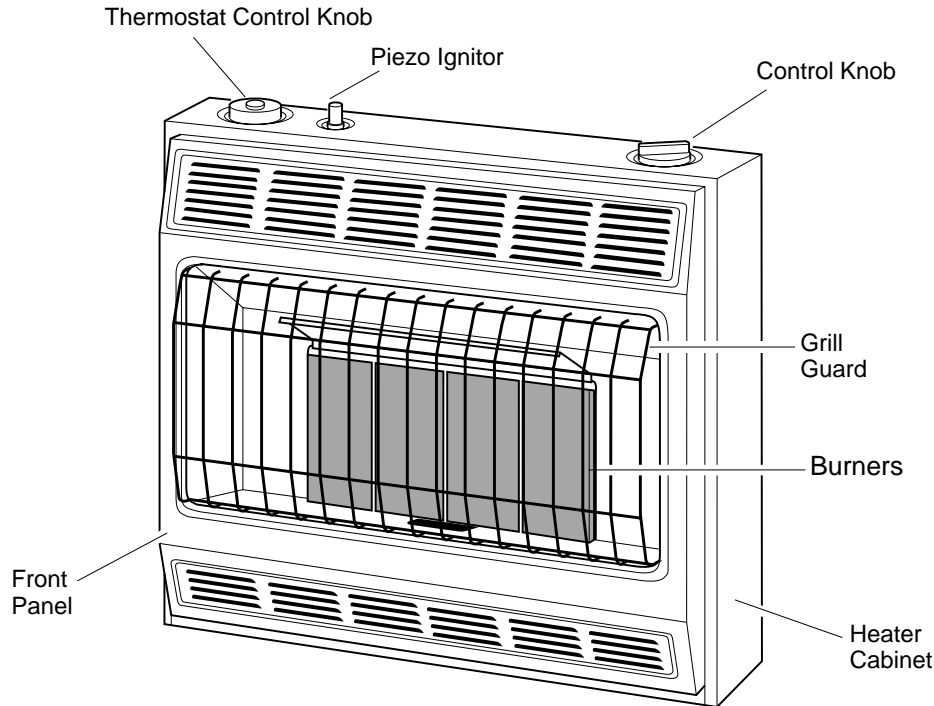

Figure 1 - Vent-Free Natural Gas Heater (Model VN2550ITB Shown)

## LOCAL CODES

Install and use heater with care. Follow all local codes. In the absence of local codes, use the latest edition of *National Fuel Gas Code ANS Z223.1*, also known as NFPA 54\*.

\*Available from:

American National Standards Institute, Inc.  
1430 Broadway  
New York, NY 10018

National Fire Protection Association, Inc.  
Batterymarch Park  
Quincy, MA 02269

## UNPACKING

1. Remove heater from carton.
2. Remove all protective packaging applied to heater for shipment.
3. Check heater for any shipping damage. If heater is damaged, promptly inform dealer where you bought heater.

## PRODUCT FEATURES

### SAFETY DEVICE

This heater has a pilot with an Oxygen Depletion Sensing (ODS) safety shutoff system. The ODS/pilot is a required feature for vent-free room heaters. The ODS/pilot shuts off the heater if there is not enough fresh air.

### PIEZO IGNITION SYSTEM

This heater has a piezo ignitor. This system requires no matches, batteries, or other sources to light heater.

### THERMOSTATIC HEAT CONTROL

This heater has a thermostat sensing bulb and thermostat control. This results in the greatest heater comfort. This can also result in lower gas bills.

# VANGUARD

## VENT-FREE NATURAL GAS HEATER

### AIR FOR COMBUSTION AND VENTILATION

**⚠ WARNING: This heater shall not be installed in a confined space or unusually tight construction unless provisions are provided for adequate combustion and ventilation air. Read the following instructions to insure proper fresh air for this and other fuel-burning appliances in your home.**

Today's homes are built more energy efficient than ever. New materials, increased insulation, and new construction methods help reduce heat loss in homes. Home owners weather strip and caulk around windows and doors to keep the cold air out and the warm air in. During heating months, home owners want their homes as airtight as possible.

While it is good to make your home energy efficient, your home needs to breathe. Fresh air must enter your home. All fuel-burning appliances need fresh air for proper combustion and ventilation.

Exhaust fans, fireplaces, clothes dryers, and fuel burning appliances draw air from the house to operate. You must provide adequate fresh air for these appliances. This will insure proper venting of vented fuel-burning appliances.

### PROVIDING ADEQUATE VENTILATION

The following are excerpts from *National Fuel Gas Code. NFPA 54/ANS Z223.1, Section 5.3, Air for Combustion and Ventilation.*

All spaces in homes fall into one of the three following ventilation classifications:

1. Unusually Tight Construction
2. Unconfined Space
3. Confined Space

The information on pages 4 through 6 will help you classify your space and provide adequate ventilation.

### Unusually Tight Construction

The air that leaks around doors and windows may provide enough fresh air for combustion and ventilation. However, in buildings of unusually tight construction, you must provide additional fresh air.

**Unusually tight construction is defined as construction where:**

- a. **walls and ceilings exposed to the outside atmosphere have a continuous water vapor retarder with a rating of one perm ( $6 \times 10^{-11}$  kg per pa-sec- $m^2$ ) or less with openings gasketed or sealed *and***
- b. **weather stripping has been added on openable windows and doors *and***
- c. **caulking or sealants are applied to areas such as joints around window and door frames, between sole plates and floors, between wall-ceiling joints, between wall panels, at penetrations for plumbing, electrical, and gas lines, and at other openings.**

**If your home meets all of the three criteria above, you must provide additional fresh air. See *Ventilation Air From Outdoors*, page 6.**

**If your home does not meet all of the three criteria above, proceed to *Determining Fresh-Air Flow for Heater Location*, page 5.**

### Confined and Unconfined Space

The *National Fuel Gas Code ANS Z223.1* defines a confined space as a space whose volume is less than 50 cubic feet per 1,000 Btu per hour ( $4.8 \text{ m}^3$  per kw) of the aggregate input rating of all appliances installed in that space and an unconfined space as a space whose volume is not less than 50 cubic feet per 1,000 Btu per hour ( $4.8 \text{ m}^3$  per kw) of the aggregate input rating of all appliances installed in that space. Rooms communicating directly with the space in which the appliances are installed\*, through openings not furnished with doors, are considered a part of the unconfined space.

This heater shall not be installed in a confined space or unusually tight construction unless provisions are provided for adequate combustion and ventilation air.

\* Adjoining rooms are communicating only if there are doorless passageways or ventilation grills between them.

## AIR FOR COMBUSTION AND VENTILATION

**Continued**

### DETERMINING FRESH-AIR FLOW FOR HEATER LOCATION

#### Determining if You Have a Confined or Unconfined Space

Use this worksheet to determine if you have a confined or unconfined space.

**Space:** Includes the room in which you will install heater plus any adjoining rooms with doorless passageways or ventilation grills between the rooms.

1. Determine the volume of the space (length x width x height).

Length x Width x Height = \_\_\_\_\_ cu. ft. (volume of space)

*Example:* Space size 20 ft. (length) x 16 ft. (width) x 8 ft. (ceiling height) = 2560 cu. ft. (volume of space)

If additional ventilation to adjoining room is supplied with grills or openings, add the volume of these rooms to the total volume of the space.

2. Divide the space volume by 50 cubic feet to determine the maximum Btu/Hr the space can support.

\_\_\_\_\_ (volume of space) ÷ 50 cu. ft. = (Maximum Btu/Hr the space can support)

*Example:* 2560 cu. ft. (volume of space) ÷ 50 cu. ft. = 51.2 or 51,200 (maximum Btu/Hr the space can support)

3. Add the Btu/Hr of all fuel burning appliances in the space.

Vent-free heater \_\_\_\_\_ Btu/Hr

Gas water heater\* \_\_\_\_\_ Btu/Hr

Gas furnace \_\_\_\_\_ Btu/Hr

Vented gas heater \_\_\_\_\_ Btu/Hr

Gas fireplace logs \_\_\_\_\_ Btu/Hr

Other gas appliances\* + \_\_\_\_\_ Btu/Hr

Total = \_\_\_\_\_ Btu/Hr

*Example:*

Gas water heater	40,000	Btu/Hr	
Vent-free heater	+ 18,000	Btu/Hr	
Total	= 58,000	Btu/Hr	

\* Do not include direct-vent gas appliances. Direct-vent draws combustion air from the outdoors and vents to the outdoors.

4. Compare the maximum Btu/Hr the space can support with the actual amount of Btu/Hr used.

\_\_\_\_\_ Btu/Hr (maximum the space can support)

\_\_\_\_\_ Btu/Hr (actual amount of Btu/Hr used)

*Example:* 51,200 Btu/Hr (maximum the space can support)

58,000 Btu/Hr (actual amount of Btu/Hr used)

The space in the above example is a confined space because the actual Btu/Hr used is more than the maximum Btu/Hr the space can support. You must provide additional fresh air. Your options are as follows:

- A. Rework worksheet, adding the space of an adjoining room. If the extra space provides an unconfined space, remove door to adjoining room or add ventilation grills between rooms. See *Ventilation Air From Inside Building*, page 6.
- B. Vent room directly to the outdoors. See *Ventilation Air From Outdoors*, page 6.
- C. Install a lower Btu/Hr heater, if lower Btu/Hr size makes room unconfined.

If the actual Btu/Hr used is less than the maximum Btu/Hr the space can support, the space is an unconfined space. You will need no additional fresh air ventilation.

**⚠ WARNING: If the area in which the heater may be operated is smaller than that defined as an unconfined space or if the building is of unusually tight construction, provide adequate combustion and ventilation air by one of the methods described in the *National Fuel Gas Code, ANS Z223.1, Section 5.3* or applicable local codes.**

*Continued*

# VANGUARD

## VENT-FREE NATURAL GAS HEATER

### AIR FOR COMBUSTION AND VENTILATION

*Continued*

#### VENTILATION AIR

##### Ventilation Air From Inside Building

This fresh air would come from an adjoining unconfined space. When ventilating to an adjoining unconfined space, you must provide two permanent openings: one within 12" of the ceiling and one within 12" of the floor on the wall connecting the two spaces (see options 1 and 2, Figure 2). You can also remove door into adjoining room (see option 3, Figure 2). Follow the *National Fuel Gas Code NFPA 54/ANS Z223.1, Section 5.3, Air for Combustion and Ventilation* for required size of ventilation grills or ducts.

**⚠ WARNING: Rework worksheet, adding the space of the adjoining unconfined space. The combined spaces must have enough fresh air to supply all appliances in both spaces.**

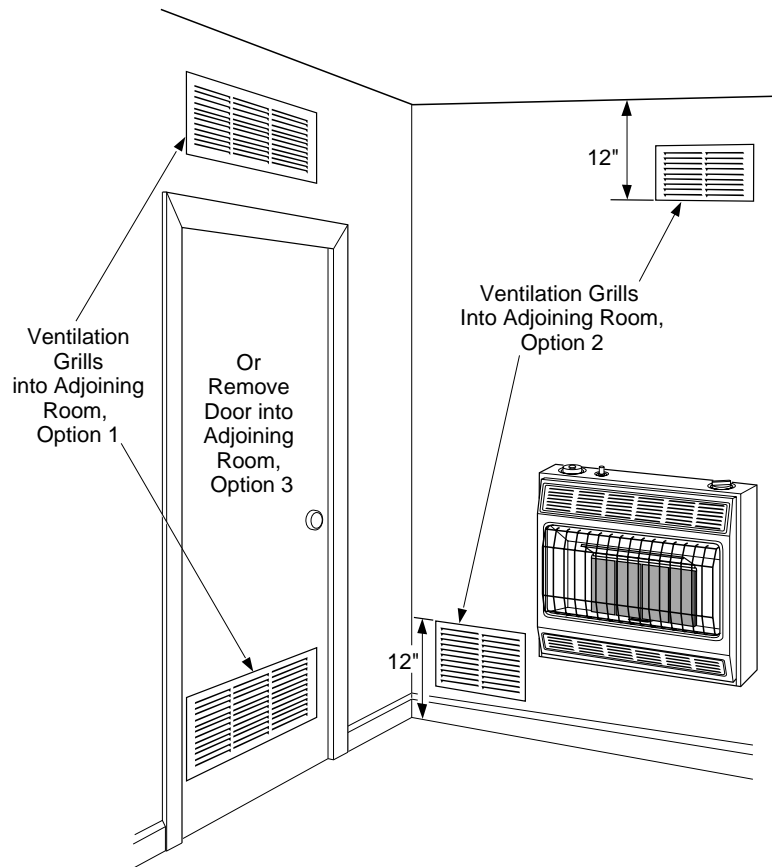

Figure 2 - Ventilation Air from Inside Building

##### Ventilation Air From Outdoors

Provide extra fresh air by using ventilation grills or ducts. You must provide two permanent openings: one within 12" of the ceiling and one within 12" of the floor. Connect these items directly to the outdoors or spaces open to the outdoors. These spaces include attics and crawl spaces. Follow the *National Fuel Gas Code NFPA 54/ANS Z223.1, Section 5.3, Air for Combustion and Ventilation* for required size of ventilation grills or ducts.

**IMPORTANT:** Do not provide openings for inlet or outlet air into attic if attic has a thermostat-controlled power vent. Heated air entering the attic will activate the power vent.

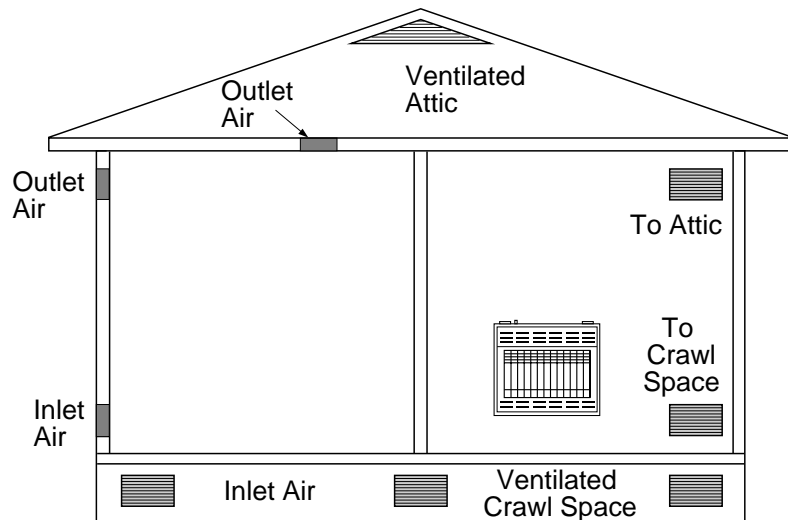

Figure 3 - Ventilation Air from Outdoors

## INSTALLATION

**NOTICE:** This heater is intended for use as supplemental heat. Use this heater along with your primary heating system. Do not install this heater as your primary heat source. If you have a central heating system, you may run system's circulating blower while using heater. This will help circulate the heat throughout the house. In the event of a power outage, you can use this heater as your primary heat source.

**WARNING:** A qualified service person must install heater. Follow all local codes.

## CHECK GAS TYPE

Use only natural gas. If your gas supply is not natural, do not install heater. Call dealer where you bought heater for proper type heater.

## INSTALLATION ITEMS

Before installing heater, make sure you have the items listed below.

- piping (check local codes)
- sealant (resistant to propane/LP gas)
- equipment shutoff valve \*
- ground joint union
- test gauge connection \*
- sediment trap
- tee joint
- pipe wrench

\* A CSA/AGA design-certified equipment shutoff valve with 1/8" NPT tap is an acceptable alternative to test gauge connection. Purchase the optional CSA/AGA design-certified equipment shutoff valve from your dealer. See *Accessories*, page 23.

## LOCATING HEATER

This heater is designed to be mounted on a wall.

**WARNING:** Maintain the minimum clearances shown in Figure 4. If you can, provide greater clearances from floor, ceiling, and joining wall.

You can locate heater on floor, away from a wall. An optional floor mounting stand is needed. Purchase the floor mounting stand from your dealer. See *Accessories*, page 23.

**WARNING:** Never install the heater

- in a bedroom or bathroom
- in a recreational vehicle
- where curtains, furniture, clothing, or other flammable objects are less than 36 inches from the front, top, or sides of the heater
- as a fireplace insert
- in high traffic areas
- in windy or drafty areas

**CAUTION:** If you install the heater in a home garage

- heater pilot and burner must be at least 18 inches above floor
- locate heater where moving vehicle will not hit it

**CAUTION:** This heater creates warm air currents. These currents move heat to wall surfaces next to heater. Installing heater next to vinyl or cloth wall coverings or operating heater where impurities (such as tobacco smoke, aromatic candles, cleaning fluids, oil or kerosene lamps, etc.) in the air exist, may discolor walls.

**IMPORTANT:** Vent-free heaters add moisture to the air. Although this is beneficial, installing heater in rooms without enough ventilation air may cause mildew to form from too much moisture. See *Air for Combustion and Ventilation*, pages 4 through 6.

For convenience and efficiency, install heater

- there there is easy access for operation, inspection, and service
- in coldest part of room

An optional fan kit is available from your dealer. See *Accessories*, page 23. If planning to use fan, locate heater near an electrical outlet.

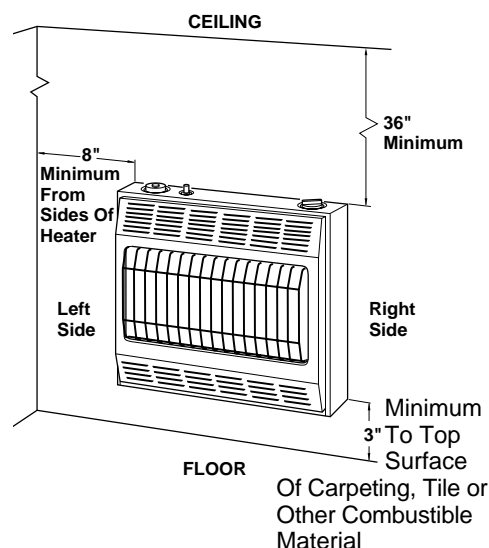

Figure 4 - Mounting Clearances As Viewed From Front of Heater

# VANGUARD

## VENT-FREE NATURAL GAS HEATER

### INSTALLATION

#### Continued

#### THERMOSTAT SENSING BULB

The thermostat sensing bulb has been placed inside the heater for protection during shipping.

#### Locating Thermostat Sensing Bulb

1. Remove front panel of heater (see Figure 7).
2. Locate thermostat sensing bulb just under the burner assembly.

**IMPORTANT:** Attach thermostat sensing bulb to the back of heater for proper operation.

#### Attaching Thermostat Sensing Bulb

1. Remove thermostat sensing bulb from holders inside heater. Route through slot opening in bottom of heater.
2. Place clamp on thermostat sensing bulb as shown in Figure 5. Clamp is provided in hardware package.
3. Snap clamp into upper mounting hole as shown in Figure 5. Mounting hole is located on lower left edge of heater. Make sure the thermostat sensing bulb is pointing up.

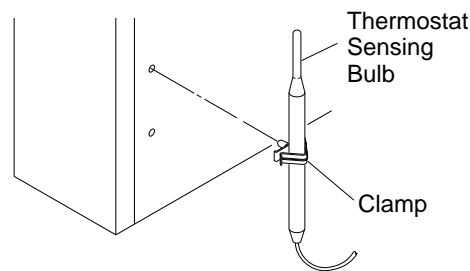

Figure 5 - Attaching Thermostat Sensing Bulb

#### INSTALLING HEATER TO WALL

#### Mounting Bracket

Locate mounting bracket in heater carton. Remove mounting bracket from heater carton.

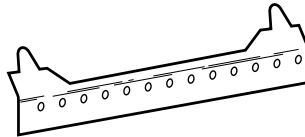

Figure 6 - Mounting Bracket

#### Removing Front Panel Of Heater

1. Remove two screws near bottom corners of front panel.
2. Lift straight up on grill guard until it stops. Grill guard will slide up about 1/4".
3. Pull bottom of front panel forward, then down.

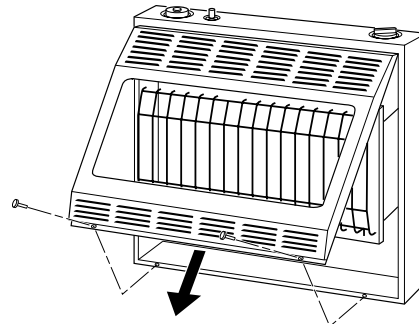

Figure 7 - Removing Front Panel Of Heater

#### Methods For Attaching Mounting Bracket To Wall

Only use last hole on each end of mounting bracket to attach bracket to wall. These two holes are 16 inches apart from their centers. Attach mounting bracket to wall in one of two ways.

1. Attaching to wall stud
2. Attaching to wall anchor

**Attaching To Wall Stud:** This method provides the strongest hold. Insert mounting screws through mounting bracket and into wall studs.

**Attaching To Wall Anchor:** This method allows you to attach mounting bracket to hollow walls (wall areas between studs) or to solid walls (concrete or masonry).

Decide which method better suits your needs. Either method will provide a secure hold for the mounting bracket.

#### Marking Screw Locations

1. Tape mounting bracket to wall where heater will be located. Make sure mounting bracket is level.

**WARNING:** Maintain minimum clearances shown in Figure 8. If you can, provide greater clearances from floor and joining wall.

2. Mark screw locations on wall (see Figure 8).

**Note:** Only mark last hole on each end of mounting bracket. Insert mounting screws through these holes only.

3. Remove tape and mounting bracket from wall.

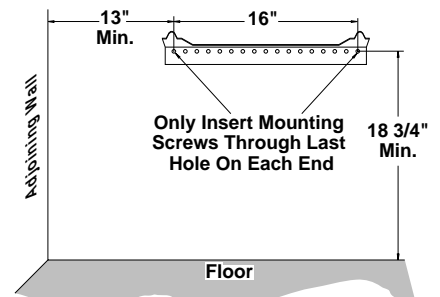

Model VN2550ITB

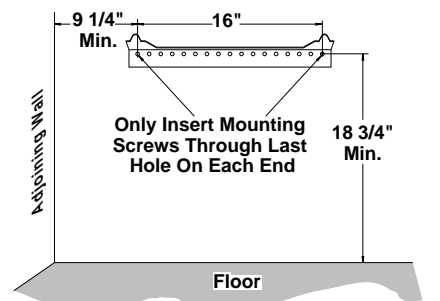

Model VN1800ITB

Figure 8 - Mounting Bracket Clearances



## INSTALLATION

### Continued

#### Attaching Mounting Bracket To Wall

**Note:** Wall anchors, mounting screws, and spacers are in hardware package. The hardware package is provided with heater.

#### Attaching To Wall Stud Method

For attaching mounting bracket to wall studs

1. Drill holes at marked locations using 9/64" drill bit.
2. Place mounting bracket onto wall. Line up last hole on each end of bracket with holes drilled in wall.
3. Insert mounting screws through bracket and into wall studs.
4. Tighten screws until mounting bracket is firmly fastened to wall studs.

#### Attaching To Wall Anchor Method

For attaching mounting bracket to hollow walls (wall areas between studs) or solid walls (concrete or masonry)

1. Drill holes at marked locations using 5/16" drill bit. For solid walls (concrete or masonry), drill at least 1" deep.
2. Fold wall anchor as shown in Figure 9.
3. Insert wall anchor (wings first) into hole. Tap anchor flush to wall.
4. For thin walls (1/2" or less), insert red key into wall anchor. Push red key to "pop" open anchor wings.  
**IMPORTANT:** Do not hammer key! For thick walls (over 1/2" thick) or solid walls, do not pop open wings.
5. Place mounting bracket onto wall. Line up last hole on each end of bracket with wall anchors.
6. Insert mounting screws through bracket and into wall anchors.
7. Tighten screws until mounting bracket is firmly fastened to wall.

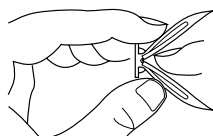

**Figure 9 - Folding Anchor**

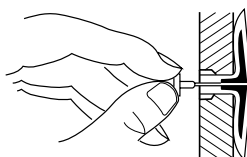

**Figure 10 - Popping Open Anchor Wings For Thin Walls**

#### Placing Heater On Mounting Bracket

1. Locate two horizontal slots on back panel of heater.
2. Place heater onto mounting bracket. Slide horizontal slots onto stand-out tabs on mounting bracket.

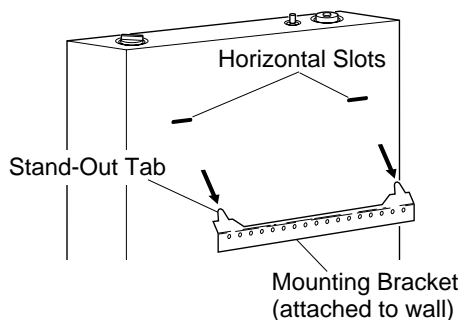
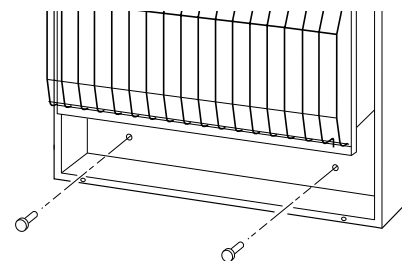

**Figure 11 - Mounting Heater Onto Mounting Bracket**

#### Installing Bottom Mounting Screws

1. Locate two bottom mounting holes. These holes are near bottom on back panel of heater (see Figure 14).
2. Mark screw locations on wall.
3. Remove heater from mounting bracket.
4. If installing bottom mounting screws into hollow or solid wall, install wall anchors. Follow steps 1 through 4 under *Attaching To Wall Anchor Method*. If installing bottom mounting screw into wall stud, drill holes at marked locations using 9/64" drill bit.
5. Replace heater onto mounting bracket.
6. Place spacers between bottom mounting holes and wall anchor or drilled hole.
7. Hold spacer in place with one hand. With other hand, insert mounting screw through bottom mounting hole and spacer. Place tip of screw in opening of wall anchor or drilled hole.
8. Tighten both screws until heater is firmly secured to wall. Do not over tighten.

**Note:** Do not replace front panel at this time. Replace front panel after making gas connections and checking for leaks (see pages 10 and 11).



**Figure 12 - Installing Bottom Mounting Screws**

# VANGUARD

## VENT-FREE NATURAL GAS HEATER

### INSTALLATION

#### Continued

#### CONNECTING TO GAS SUPPLY

**⚠ WARNING:** This appliance requires a 3/8" NPT (National Pipe Thread) inlet connection to the pressure regulator.

**⚠ WARNING:** A qualified service person must connect heater to gas supply. Follow all local codes.

**⚠ WARNING :** Never connect heater to private (non-utility) gas wells. This gas is commonly known as well-head gas.

**IMPORTANT:** Check gas line pressure before connecting heater to gas line. Gas line pressure must be no greater than 14 inches of water. If gas line pressure is higher, heater regulator damage could occur.

**⚠ CAUTION:** Use only new, black iron or steel pipe. Internally-tinned copper tubing may be used in certain areas. Check your local codes. Use pipe of large enough diameter to allow proper gas volume to heater. If pipe is too small, undue loss of pressure will occur.

#### Typical Inlet Pipe Diameters

VN1800ITB 3/8" or greater

VN2550ITB 1/2" or greater

Installation must include equipment shutoff valve, union, and plugged 1/8" NPT tap. Locate NPT tap within reach for test gauge hook up. NPT tap must be upstream from heater (see Figure 13).

**IMPORTANT:** Install an equipment shutoff valve in an accessible location. The equipment shutoff valve is for turning on or shutting off the gas to the appliance. Apply pipe joint sealant lightly to male threads. This will prevent excess sealant from going into pipe. Excess sealant in pipe could result in clogged heater valves.

**⚠ CAUTION:** Use pipe joint sealant that is resistant to liquid petroleum (LP) gas.

Install sediment trap in supply line as shown in Figure 13. Locate sediment trap where it is within reach for cleaning. Locate sediment trap where trapped matter is not likely to freeze. A sediment trap traps moisture and contaminants. This keeps them from going into heater controls. If sediment trap is not installed or is installed wrong, heater may not run properly.

**IMPORTANT:** Hold pressure regulator with wrench when connecting it to gas piping and/or fittings.

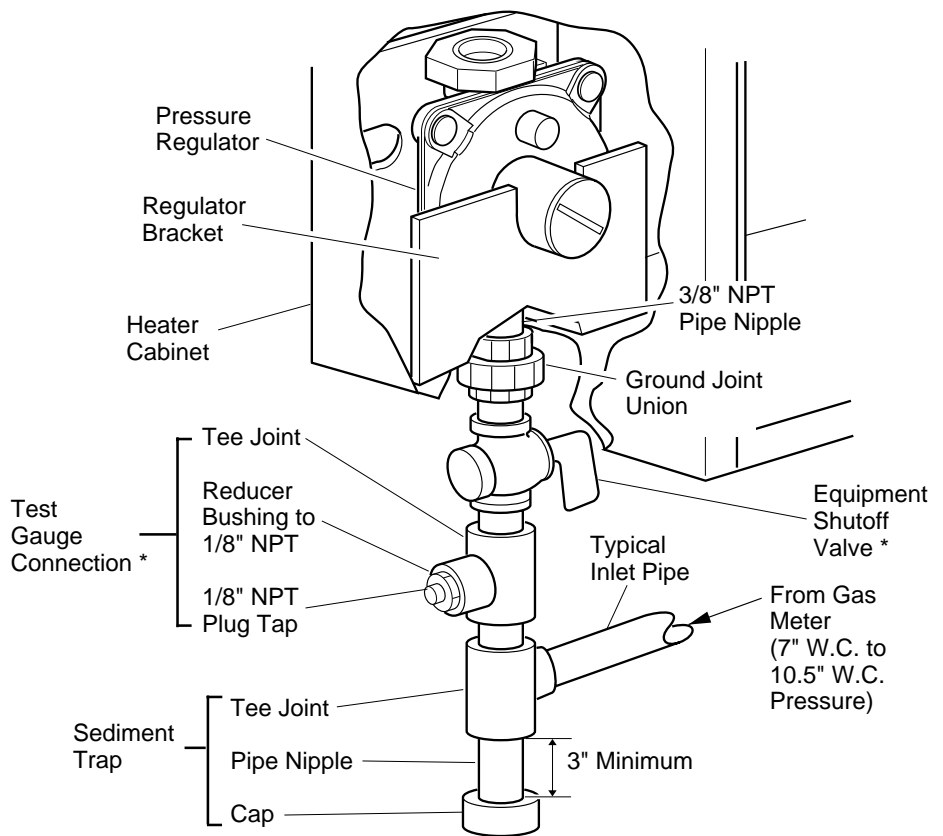

**Figure 13 - Gas Connection**

\* A CSA/AGA design-certified equipment shutoff valve with 1/8" NPT tap is an acceptable alternative to test gauge connection. Purchase the optional CSA/AGA design-certified equipment shutoff valve from your dealer. See *Accessories*, page 23.

## INSTALLATION

### Continued

### CHECKING GAS CONNECTIONS

**⚠ WARNING:** Test all gas piping and connections for leaks after installing or servicing. Correct all leaks at once.

**⚠ WARNING:** Never use an open flame to check for a leak. Apply a mixture of liquid soap and water to all joints. Bubbles forming show a leak. Correct all leaks at once.

### Pressure Testing Gas Supply Piping System

#### Test Pressures In Excess Of 1/2 PSIG (3.5 kPa)

1. Disconnect appliance with its appliance main gas valve (control valve) and equipment shutoff valve from gas supply piping system. Pressures in excess of 1/2 psig will damage heater regulator.
2. Cap off open end of gas pipe where equipment shutoff valve was connected.
3. Pressurize supply piping system by either using compressed air or opening main gas valve located on or near gas meter.
4. Check all joints of gas supply piping system. Apply mixture of liquid soap and water to gas joints. Bubbles forming show a leak.
5. Correct all leaks at once.
6. Reconnect heater and equipment shutoff valve to gas supply. Check reconnected fittings for leaks.

#### Test Pressures Equal To or Less Than 1/2 PSIG (3.5 kPa)

1. Close equipment shutoff valve (see Figure 14).
2. Pressurize supply piping system by either using compressed air or opening main gas valve located on or near gas meter.
3. Check all joints from gas meter to equipment shutoff valve (see Figure 15). Apply mixture of liquid soap and water to gas joints. Bubbles forming show a leak.
4. Correct all leaks at once.

### Pressure Testing Heater Gas Connections

1. Open equipment shutoff valve (see Figure 14).
2. Open main gas valve located on or near gas meter.
3. Make sure control knob of heater is in the OFF position.
4. Check all joints from equipment shutoff valve to control valve (see Figure 15). Apply mixture of liquid soap and water to gas joints. Bubbles forming show a leak.
5. Correct all leaks at once.
6. Light heater (see *Operating Heater*, pages 12 and 13). Check the rest of the internal joints for leaks.
7. Turn off heater (see *To Turn Off Gas to Appliance*, page 13).
8. Replace front panel.

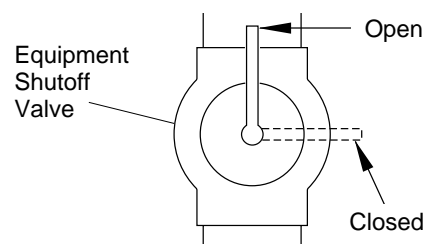

**Figure 14 - Equipment Shutoff Valve**

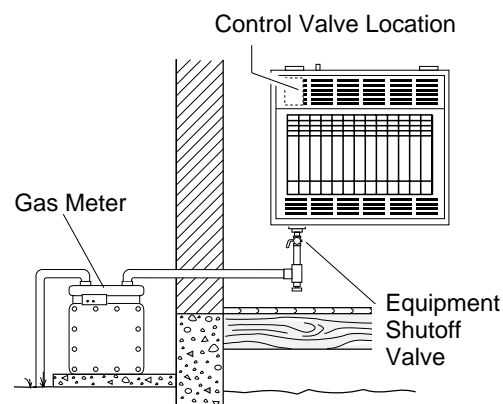

**Figure 15 - Checking Gas Joints**

# VANGUARD

## VENT-FREE NATURAL GAS HEATER

### OPERATING HEATER

#### FOR YOUR SAFETY READ BEFORE LIGHTING



**⚠ WARNING:** If you do not follow these instructions exactly, a fire or explosion may result causing property damage, personal injury or loss of life.

- A. This appliance has a pilot which must be lighted by hand. When lighting the pilot, follow these instructions exactly.
- B. **BEFORE LIGHTING** smell all around the appliance area for gas. Be sure to smell next to the floor because some gas is heavier than air and will settle on the floor.

#### WHAT TO DO IF YOU SMELL GAS

- Do not try to light any appliance.
  - Do not touch any electric switch; do not use any phone in your building.
  - Immediately call your gas supplier from a neighbor's phone. Follow the gas supplier's instructions.
  - If you cannot reach your gas supplier, call the fire department.
- C. Use only your hand to push in or turn the gas control knob. Never use tools. If the knob will not push in or turn by hand, don't try to repair it, call a qualified service technician or gas supplier. Force or attempted repair may result in a fire or explosion.
  - D. Do not use this appliance if any part has been under water. Immediately call a qualified service technician to inspect the appliance and to replace any part of the control system and any gas control which has been under water.

### LIGHTING INSTRUCTIONS

1. **STOP!** Read the safety information at the top column 1.
2. Make sure equipment shutoff valve is fully open.
3. Turn thermostat control knob on left side of heater clockwise  to the OFF position.
4. Wait five minutes to clear out any gas. Then smell for gas, including near the floor. If you smell gas, **STOP!** Follow "B" in the safety information at the top of column 1. If you don't smell gas, go to the next step.
5. Turn thermostat control knob on left side of heater counterclockwise  to the PILOT position. Press in thermostat control knob for 5 seconds.

**Note:** You may be running this heater for the first time after hooking up to gas supply. If so, you may need to press in thermostat control knob for 30 seconds. This will allow air to bleed from the gas system.

- If thermostat control knob does not pop up when released, contact a qualified service person or gas supplier for repairs.

6. Keep thermostat control knob pressed in while pushing down and releasing the ignitor button. This will light pilot. If necessary, continue to press ignitor button until pilot lights.

If pilot does not light

- turn thermostat control knob clockwise  to the OFF position
- repeat steps 5 and 6

If pilot does not stay lit after several tries

- refer to *Troubleshooting*, pages 15 through 17
- contact a qualified service person or gas supplier

Until repairs are made, light pilot with match. To light pilot with match, see *Manual Lighting Procedure*, page 13

7. Keep thermostat control knob pressed in for 30 seconds after lighting pilot. After 30 seconds, release control knob.

**Note:** If pilot goes out, repeat steps 3 through 7. This heater has a safety interlock system. Wait one minute before lighting pilot again.

8. Turn thermostat control knob counterclockwise  to the desired heating level. The plaque directly above the pilot should light.

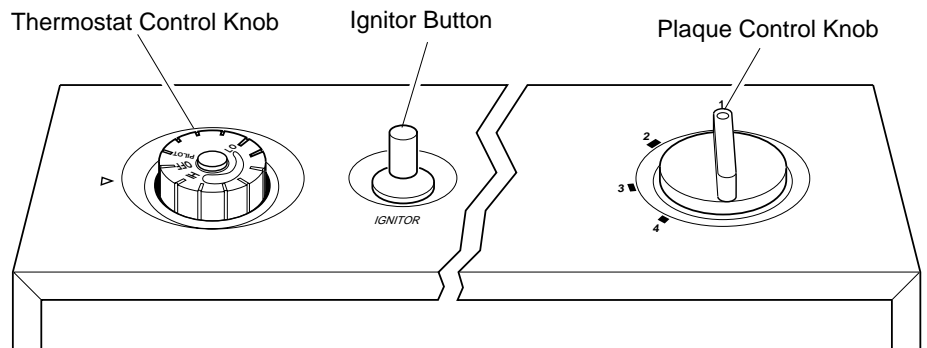

Figure 16 - Thermostat Control Knob In The OFF Position

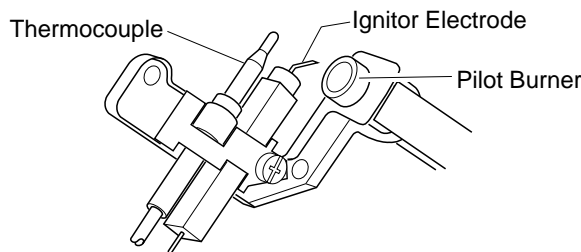

Figure 17 - Pilot

## OPERATING HEATER

*Continued*

### TO SELECT HEATING LEVEL

**⚠ WARNING:** When running heater, set control knob at the 1, 2, 3, or 4 locked positions. Never set control knob between locked positions. Poor combustion and higher levels of carbon monoxide may result.

**⚠ CAUTION:** Do not try to adjust heating levels by using the equipment shutoff valve.

1. Slightly press in plaque control knob on right side of heater and turn counterclockwise  to the desired position.

**IMPORTANT:** Release downward pressure while turning control knob. Control knob will lock at the desired position.

2. Turn thermostat control knob on left side of heater to any setting between LO and HI. **Note:** When burners cycle on, or from LO to HI, a “click” will be heard. When the burners light, a “whoosh” noise will be heard.

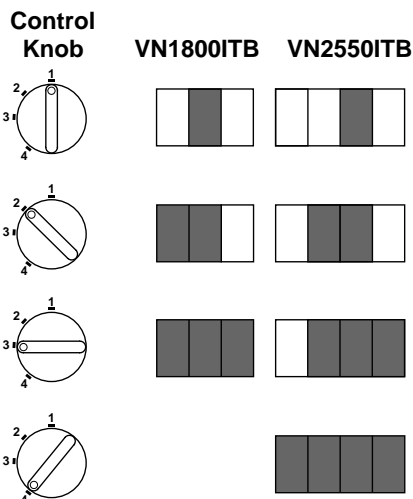



Figure 18 - Burner Patterns

### TO TURN OFF GAS TO APPLIANCE

#### Shutting Off Heater

1. Turn thermostat control knob clockwise  to the OFF position.
2. Turn off all electric power to the appliance if service is to be performed.

#### Shutting Off Burner Only (pilot stays lit)

Turn thermostat control knob clockwise  to the PILOT position.

### THERMOSTAT OPERATION

Since the thermostat measures the temperature of air near the heater cabinet, this may not always agree with room temperature (depending on housing construction, installation location, room size, open air temperatures, etc.). Frequent operation of your heater will enable you to determine your own comfort levels.

### MANUAL LIGHTING PROCEDURE

1. Follow steps 1 through 5 under *Lighting Instructions*, page 12.
2. With thermostat control knob pressed in, strike match. Hold match to pilot until pilot lights.
3. Keep thermostat control knob pressed in for 30 seconds after lighting pilot. After 30 seconds, release control knob. Follow step 8 under *Lighting Instructions*, page 12.

# VANGUARD

## VENT-FREE NATURAL GAS HEATER

### INSPECTING BURNER

Check pilot flame pattern and burner flame pattern often.

#### PILOT FLAME PATTERN

Figure 19 shows a correct pilot flame pattern. Figure 20 shows an incorrect pilot flame pattern. The incorrect pilot flame is not touching the thermocouple. This will cause the thermocouple to cool. When the thermocouple cools, the heater will shut down.

If pilot flame pattern is incorrect, as shown in Figure 20

- turn heater off (see *To Turn Off Gas to Appliance*, page 13)
- see *Troubleshooting*, pages 15 through 17

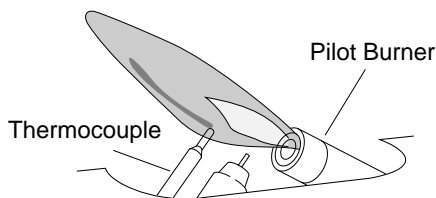

Figure 19 - Correct Pilot Flame Pattern

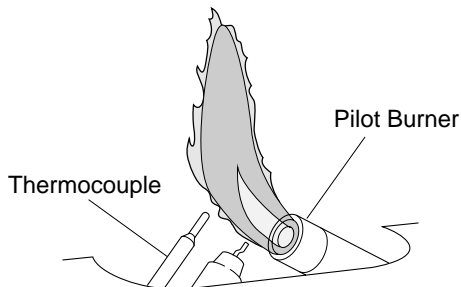

Figure 20 - Incorrect Pilot Flame Pattern

#### BURNER FLAME PATTERN

Figure 21 shows a correct burner flame pattern. Figure 22 shows an incorrect burner flame pattern.

If burner flame pattern is incorrect, as shown in Figure 22

- turn heater off (see *To Turn Off Gas to Appliance*, page 13)
- see *Troubleshooting*, pages 15 through 17

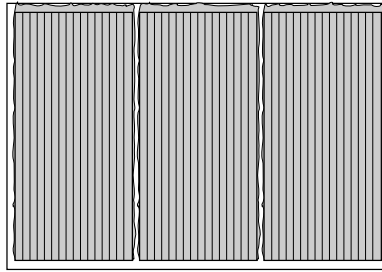

Figure 21 - Correct Burner Flame Pattern

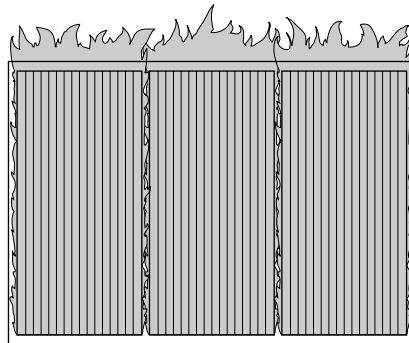

Figure 22 - Incorrect Burner Flame Pattern

### CLEANING AND MAINTENANCE

**WARNING:** Turn off heater and let cool before cleaning.

**CAUTION:** You must keep control areas, burner, and circulating air passageways of heater clean. Inspect these areas of heater before each use. Have heater inspected yearly by a qualified service person. Heater may need more frequent cleaning due to excessive lint from carpeting, bedding material, pet hair, etc.

#### ODS/PILOT AND BURNER ORIFICE

- Use a vacuum cleaner, pressurized air, or small, soft bristled brush to clean.

#### CLEANING BURNER PILOT AIR INLET HOLE

We recommend that you clean the unit every 2,500 hours of operation or every three months.

We also recommend that you keep the burner tube and pilot assembly clean and free of dust and dirt. To clean these parts we recommend using compressed air no greater than 30 PSI. Your local computer store, hardware store, or home center may carry compressed air in a can. You can use a vacuum cleaner in the blow position. If using compressed air in a can, please follow the directions on the can. If you don't follow directions on the can, you could damage the pilot assembly.

1. Shut off the unit, including the pilot. Allow the unit to cool for at least thirty minutes.
2. Inspect burner, pilot for dust and dirt.
3. Blow air through the ports/slots and holes in the burner.

Clean the pilot assembly also. A yellow tip on the pilot flame indicates dust and dirt in the pilot assembly. There is a small pilot air inlet hole about two inches from where the pilot flame comes out of the pilot assembly (see Figure 23). With the unit off, lightly blow air through the air inlet hole. You may blow through a drinking straw if compressed air is not available.

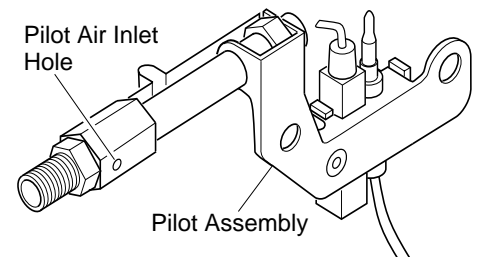

Figure 23 - Pilot Inlet Air Hole

### CABINET

#### Air Passageways

- Use a vacuum cleaner or pressurized air to clean.

#### Exterior

- Use a soft cloth dampened with a mild soap and water mixture. Wipe the cabinet to remove dust.

# OWNER'S MANUAL

## TROUBLESHOOTING

*Note:* For additional help, visit DESA International's technical service web site at [www.desatech.com](http://www.desatech.com).

*Note:* All troubleshooting items are listed in order of operation.

**⚠ WARNING:** Turn off and unplug heater and let cool before servicing. Only a qualified service person should service and repair heater.

**⚠ CAUTION:** Never use a wire, needle, or similar object to clean ODS/pilot. This can damage ODS/pilot unit.

OBSERVED PROBLEM	POSSIBLE CAUSE	REMEDY
When ignitor button is pressed in, there is no spark at ODS/pilot	<ol style="list-style-type: none"> <li>Ignitor electrode positioned wrong</li> <li>Ignitor electrode broken</li> <li>Ignitor electrode not connected to ignitor cable</li> <li>Ignitor cable pinched or wet</li> <li>Broken ignitor cable</li> <li>Bad piezo ignitor</li> <li>Piezo ignitor nut is loose</li> </ol>	<ol style="list-style-type: none"> <li>Replace ignitor</li> <li>Replace ignitor</li> <li>Reconnect ignitor cable</li> <li>Free ignitor cable if pinched by any metal or tubing. Keep ignitor cable dry</li> <li>Replace ignitor cable</li> <li>Replace control valve (piezo is part of control valve)</li> <li>Tighten nut holding piezo ignitor. Nut is located inside heater cabinet at top</li> </ol>
When ignitor button is pressed in, there is a spark at ODS/pilot but no ignition	<ol style="list-style-type: none"> <li>Gas supply turned off or equipment shutoff valve closed</li> <li>Control knob not fully pressed in while pressing ignitor button (non-thermostat models only) Thermostat control knob not fully pressed in while pressing ignitor button (thermostat models only)</li> <li>Air in gas lines when installed</li> <li>ODS/pilot is clogged</li> <li>Gas regulator setting is not correct</li> <li>Thermostat control knob not in pilot position</li> </ol>	<ol style="list-style-type: none"> <li>Turn on gas supply or open equipment shutoff valve</li> <li>Fully press in control knob while pressing ignitor button (non-thermostat models only) Fully press in thermostat control knob while pressing ignitor button (thermostat models only)</li> <li>Continue holding down control knob. Repeat igniting operation until air is removed</li> <li>Clean ODS/pilot (see <i>Cleaning and Maintenance</i>, page 14) or replace ODS/pilot assembly</li> <li>Replace gas regulator</li> <li>Turn thermostat control knob to pilot position</li> </ol>
ODS/pilot lights but flame goes out when control knob is released	<ol style="list-style-type: none"> <li>Control knob not fully pressed in</li> <li>Control knob not pressed in long enough</li> <li>Equipment shutoff valve not fully open</li> <li>Thermocouple connection loose at control valve</li> <li>Pilot flame not touching thermocouple, which allows thermocouple to cool, causing pilot flame to go out. This problem could be caused by one or both of the following: A) Low gas pressure B) Dirty or partially clogged ODS/pilot</li> <li>Thermocouple damaged</li> <li>Control valve damaged</li> <li>Safety interlock system has been triggered (thermostat models only)</li> </ol>	<ol style="list-style-type: none"> <li>Press in control knob fully</li> <li>After ODS/pilot lights, keep control knob pressed in 30 seconds</li> <li>Fully open equipment shutoff valve</li> <li>Hand tighten until snug, then tighten 1/4 turn more</li> <li>A) Contact local natural gas company B) Clean ODS/pilot (see <i>Cleaning and Maintenance</i>, page 14) or replace ODS/pilot assembly</li> <li>Replace thermocouple</li> <li>Replace control valve</li> <li>Wait one minute for safety interlock system to reset. Repeat ignition operation</li> </ol>

[www.desatech.com](http://www.desatech.com)

*Continued*

# VANGUARD

## VENT-FREE NATURAL GAS HEATER

### TROUBLESHOOTING

*Continued*

OBSERVED PROBLEM	POSSIBLE CAUSE	REMEDY
Burner(s) does not light after ODS/pilot is lit	<ol style="list-style-type: none"><li>1. Burner orifice(s) is clogged</li><li>2. Burner orifice(s) diameter is too small</li><li>3. Inlet gas pressure is too low</li></ol>	<ol style="list-style-type: none"><li>1. Clean burner orifice(s) (see <i>Cleaning and Maintenance</i>, page 14) or replace burner orifice(s)</li><li>2. Replace burner orifice(s)</li><li>3. Contact local natural gas company</li></ol>
Delayed ignition of burner(s)	<ol style="list-style-type: none"><li>1. Manifold pressure is too low</li><li>2. Burner orifice(s) is clogged</li></ol>	<ol style="list-style-type: none"><li>1. Contact local natural gas company</li><li>2. Clean burner orifice(s) (see <i>Cleaning and Maintenance</i>, page 14) or replace burner orifice(s)</li></ol>
Burner backfiring during combustion	<ol style="list-style-type: none"><li>1. Burner orifice(s) is clogged or damaged</li><li>2. Burner damaged</li><li>3. Gas regulator defective</li></ol>	<ol style="list-style-type: none"><li>1. Clean burner orifice(s) (see <i>Cleaning and Maintenance</i>, page 14) or replace burner orifice(s)</li><li>2. Replace burner</li><li>3. Replace gas regulator</li></ol>
Burner plaque(s) does not glow	<ol style="list-style-type: none"><li>1. Plaque damaged</li><li>2. Inlet gas pressure is too low</li><li>3. Control knob set between locked positions</li></ol>	<ol style="list-style-type: none"><li>1. Replace burner</li><li>2. Contact local natural gas company</li><li>3. Turn control knob until it locks at desired setting</li></ol>
Slight smoke or odor during initial operation	<ol style="list-style-type: none"><li>1. Residues from manufacturing processes</li></ol>	<ol style="list-style-type: none"><li>1. Problem will stop after a few hours of operation</li></ol>
Heater produces a clicking/ticking noise just after burner is lit or shut off	<ol style="list-style-type: none"><li>1. Metal expanding while heating or contracting while cooling</li></ol>	<ol style="list-style-type: none"><li>1. This is common with most heaters. If noise is excessive, contact qualified service person</li></ol>
White powder residue forming within burner box or on adjacent walls or furniture	<ol style="list-style-type: none"><li>1. When heated, vapors from furniture polish, wax, carpet cleaners, etc. turn into white powder residue</li></ol>	<ol style="list-style-type: none"><li>1. Turn heater off when using furniture polish, wax, carpet cleaners, or similar products</li></ol>



## TROUBLESHOOTING

*Continued*

**⚠ WARNING: If you smell gas**

- **Shut off gas supply.**
- **Do not try to light any appliance.**
- **Do not touch any electrical switch; do not use any phone in your building.**
- **Immediately call your gas supplier from a neighbor's phone. Follow the gas supplier's instructions.**
- **If you cannot reach your gas supplier, call the fire department.**

*IMPORTANT:* Operating heater where impurities in air exist may create odors. Cleaning supplies, paint, paint remover, cigarette smoke, cements and glues, new carpet or textiles, etc., create fumes. These fumes may mix with combustion air and create odors.

OBSERVED PROBLEM	POSSIBLE CAUSE	REMEDY
Heater produces unwanted odors	<ol style="list-style-type: none"> <li>1. Heater burning vapors from paint, hair spray, glues, etc. See <i>IMPORTANT</i> statement above</li> <li>2. Gas leak. <b>See Warning statement at top of page</b></li> </ol>	<ol style="list-style-type: none"> <li>1. Ventilate room. Stop using odor causing products while heater is running</li> <li>2. Locate and correct all leaks (see <i>Checking Gas Connections</i>, page 11)</li> </ol>
Heater shuts off in use (ODS operates)	<ol style="list-style-type: none"> <li>1. Not enough fresh air is available</li> <li>2. Low line pressure</li> <li>3. ODS/pilot is partially clogged</li> </ol>	<ol style="list-style-type: none"> <li>1. Open window and/or door for ventilation</li> <li>2. Contact local natural gas company</li> <li>3. Clean ODS/pilot (see <i>Cleaning and Maintenance</i>, page 14)</li> </ol>
Gas odor even when control knob is in OFF position	<ol style="list-style-type: none"> <li>1. Gas leak. <b>See Warning statement at top of page</b></li> <li>2. Control valve defective</li> </ol>	<ol style="list-style-type: none"> <li>1. Locate and correct all leaks (see <i>Checking Gas Connections</i>, page 11)</li> <li>2. Replace control valve</li> </ol>
Gas odor during combustion	<ol style="list-style-type: none"> <li>1. Foreign matter between control valve and burner</li> <li>2. Gas leak. <b>See Warning statement at top of page</b></li> </ol>	<ol style="list-style-type: none"> <li>1. Take apart gas tubing and remove foreign matter</li> <li>2. Locate and correct all leaks (see <i>Checking Gas Connections</i>, page 11)</li> </ol>
Moisture/condensation noticed on windows	<ol style="list-style-type: none"> <li>1. Not enough combustion/ventilation air</li> </ol>	<ol style="list-style-type: none"> <li>1. Refer to <i>Fresh Air for Combustion and Ventilation</i> requirements (page 4)</li> </ol>

# VANGUARD

## VENT-FREE NATURAL GAS HEATER

### ILLUSTRATED PARTS BREAKDOWN

VN1800ITB

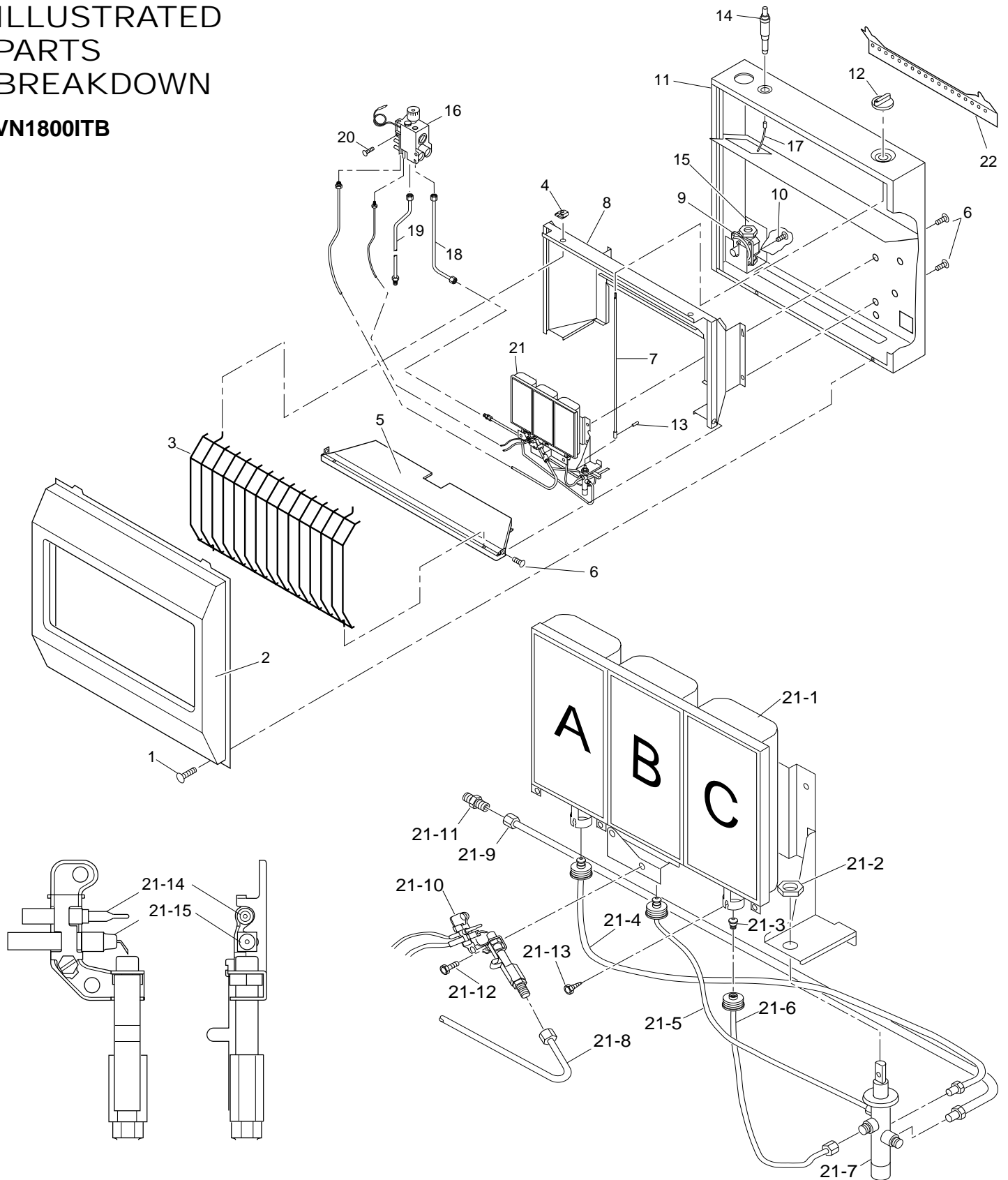

# OWNER'S MANUAL

## PARTS LIST

This list contains replaceable parts used in your heater. When ordering parts, follow the instructions listed under *Replacement Parts* on page 22 of this manual.

### VN1800ITB

KEY NO.	PART NUMBER	DESCRIPTION	QTY.
1	098304-01	Screw, #10 x 3/8"	2
2	098742-13	Front Panel	1
3	098238-06	Grill Guard	1
4	101108-01	Clip-Grill Guard	2
5	098198-03	Apron	1
6	M11084-26	Screw, #10 x 3/8"	9
7	098462-01	Control Rod Assembly	1
8	098457-01	Reflector Assembly	1
9	099415-08	Regulator	1
10	M11084-38	Screw, #8 x 3/8"	2
11	104617-01	Cabinet Assembly	1
12	098324-01	Control Knob	1
13	098325-01	Roll Pin	1
14	097159-04	Piezo Ignitor	1
15	100537-02	Regulator Bracket	1
16	098522-16	Thermostat Gas Valve	1
17	098271-03	Ignitor Cable	1
18	104224-01	SIT Tube	1
19	104197-01	Inlet Tube	1
20	099211-01	Hex-Head Screw	2
21	See Detail	Burner Assembly	1
21-1	099218-01	Burner	1
21-2	098508-01	Valve Retainer Nut	1
21-3	099056-03	Injector	3
21-4	099048-01	Tubing-Valve to Plaque A	1
21-5	099049-02	Tubing-Valve to Plaque B	1
21-6	099050-01	Tubing-Valve to Plaque C	1
21-7	100605-01	Control Valve	1
21-8	099387-06	Pilot Tubing	1
21-9	100616-01	Control Valve Tube	1
21-10	103594-06	ODS/Pilot	1
21-11	100615-01	Male Connector	2
21-12	M11084-26	Screw, #10 x 3/8"	2
21-13	M11084-37	Screw, #8 x 1/4"	3
21-14	098514-01	Thermocouple	1
21-15	106842-01	Ignitor Electrode	1
22	099066-01	Mounting Bracket	1
<b>PARTS AVAILABLE - NOT SHOWN</b>			
	100619-01	Thermostat Control Position Label	1
	100619-03	Control Position Label	1
	100642-01	Hardware Assembly	1



# OWNER'S MANUAL

## PARTS LIST

This list contains replaceable parts used in your heater. When ordering parts, follow the instructions listed under *Replacement Parts* on page 22 of this manual.

### VN2550ITB

KEY NO.	PART NUMBER	DESCRIPTION	QTY.
1	098304-01	Screw, #10 x 3/8"	2
2	098742-14	Front Panel	1
3	098238-07	Grill Guard	1
4	101108-01	Clip-Grill Guard	2
5	098198-04	Apron	1
6	M11084-26	Screw, #10 x 3/8"	9
7	098462-01	Control Rod Assembly	1
8	098457-05	Reflector Assembly	1
9	099415-08	Regulator	1
10	M11084-38	Screw, #8 x 3/8"	2
11	104617-02	Cabinet Assembly	1
12	098324-01	Control Knob	1
13	098325-01	Roll Pin	1
14	097159-04	Piezo Ignitor	1
15	100537-02	Regulator Bracket	1
16	098522-16	Thermostat Gas Valve	1
17	098271-03	Cable Ignitor	1
18	104224-01	SIT Tubing	1
19	104197-01	Inlet Tubing	1
20	099211-01	Hex-Head Screw	2
21	See Detail	Burner Assembly	1
21-1	099218-03	Burner	1
21-2	098508-01	Valve Retainer Nut	1
21-3	099056-06	Injector	4
21-4	100620-01	Tubing-Valve to Plaque A	1
21-5	100607-02	Tubing-Valve to Plaque B	1
21-6	100608-01	Tubing-Valve to Plaque C	1
21-7	100605-02	Control Valve	1
21-8	100616-02	Control Valve Tube	1
21-9	099387-06	Pilot Tubing	1
21-10	103594-07	ODS/Pilot	1
21-11	100606-01	Tubing - Valve to Plaque D	1
21-12	100615-01	Male Connector	2
21-13	M11084-37	Screw, #8 x 1/4"	4
21-14	M11084-26	Screw, #10 x 3/8"	2
21-15	098514-01	Thermocouple	1
21-16	106842-01	Ignitor Electrode	1
22	099066-01	Mounting Bracket	1
<b>PARTS AVAILABLE - NOT SHOWN</b>			
	100619-01	Thermostat Control Position Label	1
	100619-02	Control Position Label	1
	100642-01	Hardware Assembly	1

# VANGUARD

## VENT-FREE NATURAL GAS HEATER

### SPECIFICATIONS

	<b>VN1800ITB</b>	<b>VN2550ITB</b>
Btu (Variable)	6,600-18,000	7,000-25,500
Type Gas	Natural Only	Natural Only
Ignition	Piezo	Piezo
Pressure Regulator Setting	6" W.C.	6" W.C.
Inlet Gas Pressure (in. of water)		
Maximum	10.5"	10.5"
Minimum	7"	7"
Dimensions, Inches (H x W x D)		
Heater	23.5 x 18.5 x 8	23.5 x 25.9 x 8
Carton	25.8 x 21.3 x 10.1	25.8 x 28.7 x 10.1
Weight (pounds)		
Heater	24	32
Shipping	29	38

### TECHNICAL SERVICE

You may have further questions about installation, operation, or troubleshooting. If so, contact DESA International's Technical Service Department at 1-800-323-5190.

You can also visit DESA International's technical service web site at [www.desatech.com](http://www.desatech.com).

### SERVICE PUBLICATIONS

You can purchase a service manual from the address listed on the back page of this manual. Send a check for \$5.00 payable to DESA International.

### SERVICE HINTS

#### When Gas Pressure Is Too Low

- pilot will not stay lit
- burner(s) will have delayed ignition
- heater will not produce specified heat

#### When Gas Quality Is Bad

- pilot will not stay lit
- burner(s) will produce flames and soot
- heater will backfire when lit

You may feel your gas pressure is too low or gas quality is bad. If so, contact your local natural gas supplier.

### REPLACEMENT PARTS

*Note:* Use only original replacement parts. This will protect your warranty coverage for parts replaced under warranty.

#### PARTS UNDER WARRANTY

Contact authorized dealer from whom you purchased this product. If they are unable to supply original replacement part(s), call DESA International's Technical Service Department at 1-800-323-5190 for information.

When contacting your dealer or DESA International, have ready:

- your name
- your address
- model and serial numbers of your heater
- how heater was malfunctioning
- type of gas used (propane/LP or natural gas)
- purchase date

Usually, we will ask you to return the defective part to the factory.

#### PARTS NOT UNDER WARRANTY

Contact authorized dealers of this product. If they can't supply original replacement part(s), call DESA International's Parts Department at 1-800-972-7879 for referral information. When calling DESA International, have ready:

- model number of your heater
- the replacement part number

## ACCESSORIES

Purchase these heater accessories from your local dealer. If they can not supply these accessories, call DESA International's Parts Department at 1-800-972-7879 or write to the address listed on the back page of this manual for referral information.

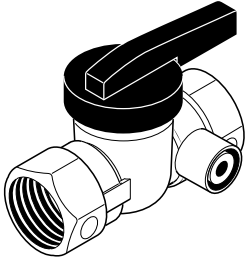

### EQUIPMENT SHUTOFF VALVE - GA5010

For all models. Equipment shutoff valve with 1/8" NPT tap.

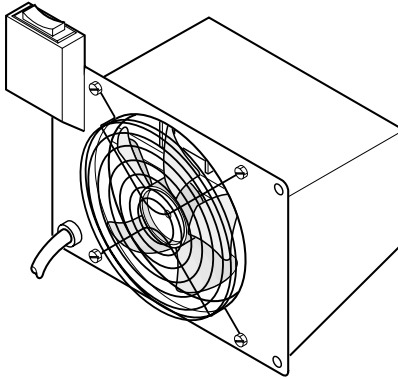

### FAN KITS - GA3100(A,B) AND GA3200T(A,B)

For all models. Provides better heat distribution. Makes heater more efficient. Complete installation and operating instructions included.

Manually-controlled - GA3100(A,B). Includes ON/OFF switch.

Thermostatically-controlled - GA3200T(A,B). Includes three settings: ON/OFF/AUTO.

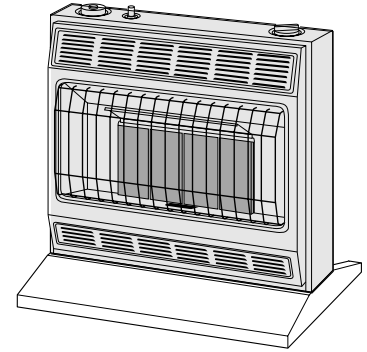

### FLOOR MOUNTING STAND

**Models VN1800ITB - GA4000B**  
**Models VN2550ITB - GA4010B**

For locating heater on the floor, away from a wall. Complete installation instructions provided with floor mounting stand.

# WARRANTY INFORMATION

KEEP THIS WARRANTY

Model _____
Serial No. _____
Date Purchased _____

Always specify model and serial numbers when communicating with the factory.

We reserve the right to amend these specifications at any time without notice. The only warranty applicable is our standard written warranty. We make no other warranty, expressed or implied.

## LIMITED WARRANTY VANGUARD VENT-FREE NATURAL GAS HEATERS

DESA International warrants this product to be free from defects in materials and components for four (4) years from the date of first purchase, provided that the product has been properly installed, operated and maintained in accordance with all applicable instructions. To make a claim under this warranty the Bill of Sale or cancelled check must be presented.

This warranty is extended only to the original retail purchaser. This warranty covers the cost of part(s) required to restore this heater to proper operating condition and an allowance for labor when provided by a DESA Authorized Service Center. Warranty part(s) MUST be obtained through authorized dealers of this product and/or DESA International who will provide original factory replacement parts. Failure to use original factory replacement parts voids this warranty. The heater MUST be installed by a qualified installer in accordance with all local codes and instructions furnished with the unit.

This warranty does not apply to parts that are not in original condition because of normal wear and tear, or parts that fail or become damaged as a result of misuse, accidents, lack of proper maintenance or defects caused by improper installation. Travel, diagnostic cost, labor, transportation and any and all such other costs related to repairing a defective heater will be the responsibility of the owner.

TO THE FULL EXTENT ALLOWED BY THE LAW OF THE JURISDICTION THAT GOVERNS THE SALE OF THE PRODUCT; THIS EXPRESS WARRANTY EXCLUDES ANY AND ALL OTHER EXPRESSED WARRANTIES AND LIMITS THE DURATION OF ANY AND ALL IMPLIED WARRANTIES, INCLUDING WARRANTIES OF MERCHANTABILITY AND FITNESS FOR A PARTICULAR PURPOSE TO FOUR (4) YEARS ON ALL COMPONENTS FROM THE DATE OF FIRST PURCHASE; AND DESA INTERNATIONAL'S LIABILITY IS HEREBY LIMITED TO THE PURCHASE PRICE OF THE PRODUCT AND DESA INTERNATIONAL SHALL NOT BE LIABLE FOR ANY OTHER DAMAGES WHATSOEVER INCLUDING INDIRECT, INCIDENTAL OR CONSEQUENTIAL DAMAGES.

Some states do not allow a limitation on how long an implied warranty lasts or an exclusion or limitation of incidental or consequential damages, so the above limitation on implied warranties, or exclusion or limitation on damages may not apply to you.

This warranty gives you specific legal rights, and you may also have other rights that vary from state to state.

For information about this warranty write:

**DESA**  
**INTERNATIONAL**

2701 Industrial Drive  
P.O. Box 90004  
Bowling Green, KY 42102-9004  
[www.desatech.com](http://www.desatech.com)



104246 01

NOT A UPC

104246-01  
Rev. E  
03/00

Patent Pending



## Free Manuals Download Website

<http://myh66.com>

<http://usermanuals.us>

<http://www.somanuals.com>

<http://www.4manuals.cc>

<http://www.manual-lib.com>

<http://www.404manual.com>

<http://www.luxmanual.com>

<http://aubethermostatmanual.com>

Golf course search by state

<http://golfingnear.com>

Email search by domain

<http://emailbydomain.com>

Auto manuals search

<http://auto.somanuals.com>

TV manuals search

<http://tv.somanuals.com>