

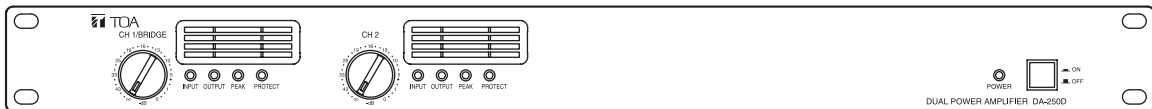

OPERATING INSTRUCTIONS

DUAL POWER AMPLIFIERS

DA-250D CU
DA-250DH CU



Note: The figure shows the DA-250D.

Thank you for purchasing TOA's Dual Power Amplifier.
Please carefully follow the instructions in this manual to ensure long, trouble-free use of your equipment.

TOA Corporation

TABLE OF CONTENTS

1. IMPORTANT SAFETY INSTRUCTIONS	3
2. SAFETY PRECAUTIONS	4
3. GENERAL DESCRIPTION	6
4. FEATURES	6
5. HANDLING PRECAUTIONS	6
6. INSTALLATION PRECAUTIONS	7
7. NOMENCLATURE AND FUNCTIONS	
Front	8
Rear	9
8. SETTINGS AND CONNECTIONS	10
8.1. Switch Settings and Speaker Connections	11
9. REMOVABLE TERMINAL PLUG CONNECTION	12
10. INPUT SENSITIVITY AND HIGH-PASS FILTER ON/OFF SETTINGS	13
11. PROTECTION OPERATION LIST	14
12. TAMPER-PROOF CAP ATTACHMENT	14
13. CLEANING THE FILTER	15
14. BLOCK DIAGRAMS	
14.1. DA-250D	16
14.2. DA-250DH	16
15. DIMENSIONAL DIAGRAM	17
16. SPECIFICATIONS	
16.1. DA-250D CU	18
16.2. DA-250DH CU	19

1. IMPORTANT SAFETY INSTRUCTIONS

- Read these instructions.
- Keep these instructions.
- Heed all warnings.
- Follow all instructions.
- Do not use this apparatus near water.
- Clean only with dry cloth.
- Do not block any ventilation openings. Install in accordance with the manufacturer's instructions.
- Do not install near any heat sources such as radiators, heat registers, stoves, or other apparatus (including amplifiers) that produce heat.
- Do not defeat the safety purpose of the polarized or grounding-type plug. A polarized plug has two blades with one wider than the other. A grounding type plug has two blades and a third grounding prong. The wide blade or the third prong are provided for your safety. If the provided plug does not fit into your outlet, consult an electrician for replacement of the obsolete outlet.
- Protect the power cord from being walked on or pinched particularly at plugs, convenience receptacles, and the point where they exit from the apparatus.
- Only use attachments/accessories specified by the manufacturer.
- Use only with the cart, stand, tripod, bracket, or table specified by the manufacturer, or sold with the apparatus. When a cart is used, use caution when moving the cart/apparatus combination to avoid injury from tip-over.



- Unplug this apparatus during lightning storms or when unused for long periods of time.
- Refer all servicing to qualified service personnel. Servicing is required when the apparatus has been damaged in any way, such as power-supply cord or plug is damaged, liquid has been spilled or objects have fallen into the apparatus, the apparatus has been exposed to rain or moisture, does not operate normally, or has been dropped.

FCC REQUIREMENTS

Note: This equipment has been tested and found to comply with the limits for a Class A digital device, pursuant to part 15 of the FCC Rules. These limits are designed to provide reasonable protection against harmful interference when the equipment is operated in a commercial environment. This equipment generates, uses, and can radiate radio frequency energy and, if not installed and used in accordance with the instruction manual, may cause harmful interference to radio communications. Operation of this equipment in a residential area is likely to cause harmful interference in which case the user will be required to correct the interference at his own expense.

- Reorient or relocate the receiving antenna.
- Increase the separation between the equipment and receiver.
- Connect the equipment into an outlet on a circuit different from that to which the receiver is connected.
- Consult the dealer or an experienced radio/TV technician for help.

- This Class A digital apparatus complies with Canadian ICES-003.
- Cet appareil numérique de la classe A est conforme à la norme NMB-003 du Canada.

2. SAFETY PRECAUTIONS

- Before installation or use, be sure to carefully read all the instructions in this section for correct and safe operation.
- Be sure to follow all the precautionary instructions in this section, which contain important warnings and/or cautions regarding safety.
- After reading, keep this manual handy for future reference.

Safety Symbol and Message Conventions

Safety symbols and messages described below are used in this manual to prevent bodily injury and property damage which could result from mishandling. Before operating your product, read this manual first and understand the safety symbols and messages so you are thoroughly aware of the potential safety hazards.



WARNING

Indicates a potentially hazardous situation which, if mishandled, could result in death or serious personal injury.



CAUTION

Indicates a potentially hazardous situation which, if mishandled, could result in moderate or minor personal injury, and/or property damage.



WARNING

When Installing the Unit

- Do not expose the unit to rain or an environment where it may be splashed by water or other liquids, as doing so may result in fire or electric shock.
- Use the unit only with the voltage specified on the unit. Using a voltage higher than that which is specified may result in fire or electric shock.
- Do not cut, kink, otherwise damage nor modify the power supply cord. In addition, avoid using the power cord in close proximity to heaters, and never place heavy objects -- including the unit itself -- on the power cord, as doing so may result in fire or electric shock.
- Be sure to replace the unit's terminal cover after connection completion. Because the voltage of up to 140 V is applied to the high impedance speaker terminals, never touch these terminals to avoid electric shock. (DA-250DH only)
- External wiring connected to the terminals marked with ⚡ requires installation by an instructed person. (DA-250DH only)
- The apparatus shall be connected to a mains socket outlet with a protective earthing connection.

When the Unit is in Use

- Should the following irregularity be found during use, immediately switch off the power, disconnect the power supply plug from the AC outlet and contact your nearest TOA dealer. Make no further attempt to operate the unit in this condition as this may cause fire or electric shock.

- If you detect smoke or a strange smell coming from the unit.
- If water or any metallic object gets into the unit
- If the unit falls, or the unit case breaks
- If the power supply cord is damaged (exposure of the core, disconnection, etc.)
- If it is malfunctioning (no tone sounds.)
- To prevent a fire or electric shock, never open nor remove the unit case as there are high voltage components inside the unit. Refer all servicing such as modification inside the unit to qualified service personnel.
- Do not place cups, bowls, or other containers of liquid or metallic objects on top of the unit. If they accidentally spill into the unit, this may cause a fire or electric shock.
- Do not insert nor drop metallic objects or flammable materials in the ventilation slots of the unit's cover, as this may result in fire or electric shock.
- Do not touch a plug during thunder and lightning, as this may result in electric shock.



CAUTION

When Installing the Unit

- Never plug in nor remove the power supply plug with wet hands, as doing so may cause electric shock.
- When unplugging the power supply cord, be sure to grasp the power supply plug; never pull on the cord itself. Operating the unit with a damaged power supply cord may cause a fire or electric shock.

- When moving the unit, be sure to remove its power supply cord from the wall outlet. Moving the unit with the power cord connected to the outlet may cause damage to the power cord, resulting in fire or electric shock. When removing the power cord, be sure to hold its plug to pull.
- Avoid installing the unit in humid or dusty locations, in locations exposed to the direct sunlight, near the heaters, or in locations generating sooty smoke or steam as doing otherwise may result in fire or electric shock.
- To avoid electric shocks, be sure to switch off the unit's power when connecting speakers.
- The unit is designed exclusively to be mounted in an equipment rack. Be sure to follow the instructions below when rack-mounting the unit. Failure to do so may cause a fire or personal injury.
 - Install the equipment rack on a stable, hard floor. Fix it with anchor bolts or take other arrangements to prevent it from falling down.
 - Be sure to use the screws with a diameter of over 5 mm (0.2") and length of over 12 mm (0.47") to mount the unit.
 - When connecting the unit's power cord to an AC outlet, use the AC outlet with current capacity allowable to the unit.
- Make sure that all volume controls are set to minimum position before power is switched on. Loud noise produced at high volume when power is switched on can impair hearing.
- Do not operate the unit for an extended period of time with the sound distorting. This is an indication of a malfunction, which in turn can cause heat to generate and result in a fire.
- Contact your TOA dealer as to the cleaning. If dust is allowed to accumulate in the unit over a long period of time, a fire or damage to the unit may result.
- If dust accumulates on the power supply plug or in the wall AC outlet, a fire may result. Clean it periodically. In addition, insert the plug in the wall outlet securely.
- Switch off the power, and unplug the power supply plug from the AC outlet for safety purposes when cleaning or leaving the unit unused for 10 days or more. Doing otherwise may cause a fire or electric shock.

An all-pole mains switch with a contact separation of at least 3 mm (0.12") in each pole shall be incorporated in the electrical installation of the building.

When the Unit is in Use

- With the High-pass filter jumper socket kept to the OFF position (factory preset), operating the unit for long periods of time while the Peak indicator is illuminated due to excessive input signal may damage the connected speakers, possibly resulting in fire. Operating the unit with the High-pass filter jumper socket set to the ON position may decrease the possibility of speaker damage or fire due to excessive input signal.



The lightning flash with arrowhead symbol, within an equilateral triangle, is intended to alert the user to the presence of uninsulated "dangerous voltage" within the product's enclosure that may be of sufficient magnitude to constitute a risk of electric shock to persons.

3. GENERAL DESCRIPTION

TOA's DA-250D and DA-250DH Dual Power Amplifiers feature high power handling capabilities and durability. The DA-250D is configured with 250 W x 2 channels (4 Ω output) and 170 W x 2 channels (8 Ω output), and the DA-250DH features a 250 W x 2 channels (19.6 Ω output) configuration.

Besides, each model's output is made available for bridge connection, allowing it to be used as a monaural amplifier of 500 W (8 Ω for DA-250D, 39.2 Ω for DA-250DH).

Their wide range of applications include stores and permanent sound systems.

4. FEATURES

- 1U rack mounting size*.
- Low power consumption and light weight.
- An input signal to Channel 1 can be routed to both channels 1 and 2, and the output level adjusted using the input level control for each channel.
- Electronically-balanced inputs.
- Input terminals employ removable terminal blocks to provide maximum connection ease.
- Input/output status LED indicators for each channel.
- Built-in protection circuitry disconnects the output when a short circuit, overload, or unusual temperature rise occurs.

* 1U size = 44.5 mm or 1.75" (reference size)

5. HANDLING PRECAUTIONS

- Keep the input cable away from the output cable. If installed close to each other, oscillation could occur.
- To avoid unit failures, never connect outputs of two or more units in parallel.
- Only connect speakers with an impedance equal to or greater than those specified. Connecting speakers with a smaller than specified impedance could cause damage to the unit.
- Periodically clean the filter located inside the ventilation panel on the unit's front panel. If the filter becomes clogged, heat will become trapped inside the enclosure.
- Install the unit in locations where the temperature is between -10 and $+40^{\circ}\text{C}$ (14°F and 104°F) and the moisture is less than 90%RH (no dew condensation must be formed).
- To clean, be sure to first switch off the unit's power, then wipe with a dry cloth. When the unit gets very dirty, use a cloth damped in a neutral cleanser. Never use benzene, thinner, alcohol, or chemically-treated cleaning cloth because such volatile liquids could deform or discolor the unit.

6. INSTALLATION PRECAUTIONS



CAUTION

Rack mounting screws are not supplied with the unit.

Be sure to use the screws with a diameter of over 5 mm (0.2") and length of over 12 mm (0.47") to mount the unit.

Failure to do so may cause personal injury.

- The supplied power supply cord is designed for exclusive use with this unit. Never use it with other equipment.
- When mounting the unit in an equipment rack, the inside of the rack must be sufficiently ventilated. To achieve sufficient ventilation, remove all panels on the rear of the rack.
- When mounting the unit in the rack, also mount a Perforated Panel larger than 1U in size*:
 - (1) at the top and the bottom of the rack, and
 - (2) above and below every 5 units.

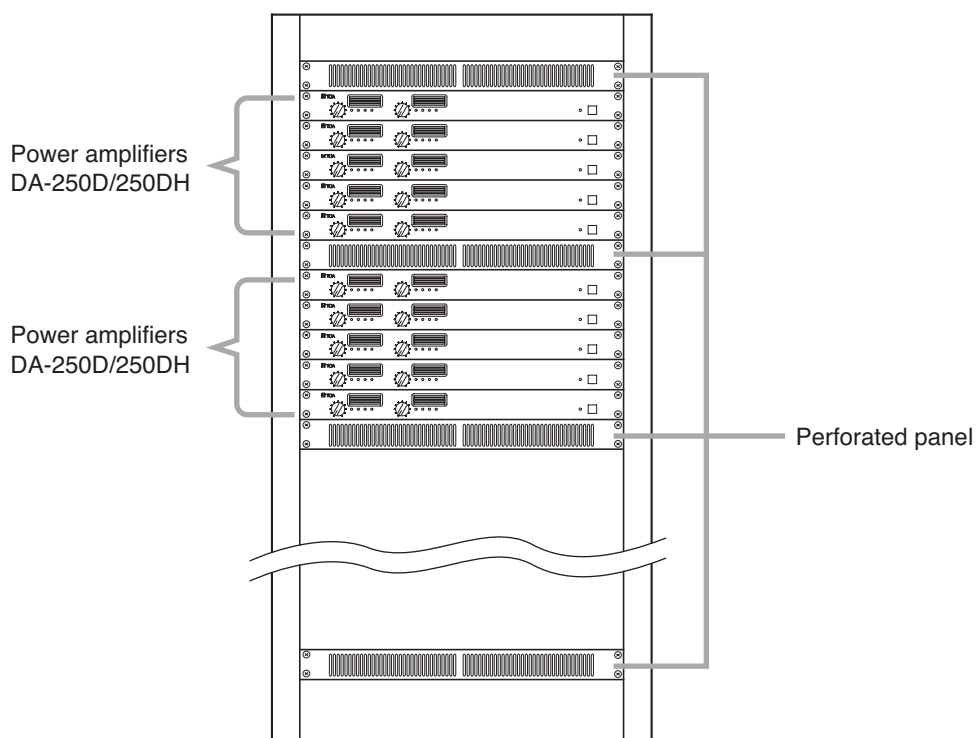

- Robust structure is one of the unit's main features. However, if the strength is particularly needed when installing the unit in the rack, use a supporting runner for the safety purposes.

* 1U size = 44.5 mm or 1.75" (reference size)

7. NOMENCLATURE AND FUNCTIONS

[Front]

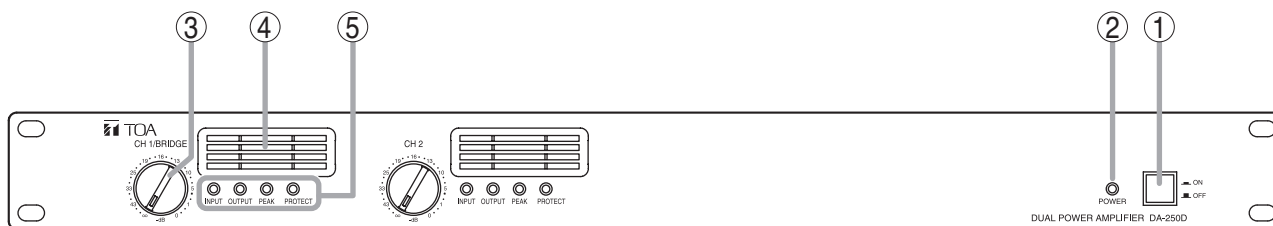

Note: The figure shows the DA-250D.

1. Power switch [ON / OFF]

Power is switched on and off with each depression of this switch.

2. Power indicator [POWER]

Lights blue when the power is switched on.

3. Input level controls [CH 1/BRIDGE, CH 2]

Adjust the input level of each channel.

When a bridge connection is made

When Channels 1 and 2 are bridge-connected (BRIDGE ON/OFF switch (9) is set to ON), the CH 1/BRIDGE level control adjusts the input levels of Channels 1 and 2. In this event, the CH 2 level control cannot be used.

4. Ventilation panel (Air Vent)

A filter is located inside the ventilation panel.
To clean the filter, remove the ventilation panel.
(See p. 15; Cleaning the Filter.)

5. Indicators [INPUT, OUTPUT, PEAK, PROTECT]

The indicators are as follows from left to right:

- **Input indicator [INPUT]**
Lights green regardless of the input level control setting when an input signal level exceeds about -20 dB.
- **Output indicator [OUTPUT]**
Lights yellow when an output level exceeds about 1 W at an 8Ω load (DA-250D) or 19.6Ω load (DA-250DH).
- **Peak indicator [PEAK]**
Lights red when an output signal clips (distortion occurs).
- **Protection indicator [PROTECT]**
Lights red when the protection circuitry is activated. (See p. 14; Protection Operation List.) When the power is switched on, this indicator lights for about 2 seconds and then extinguishes.

[Rear]

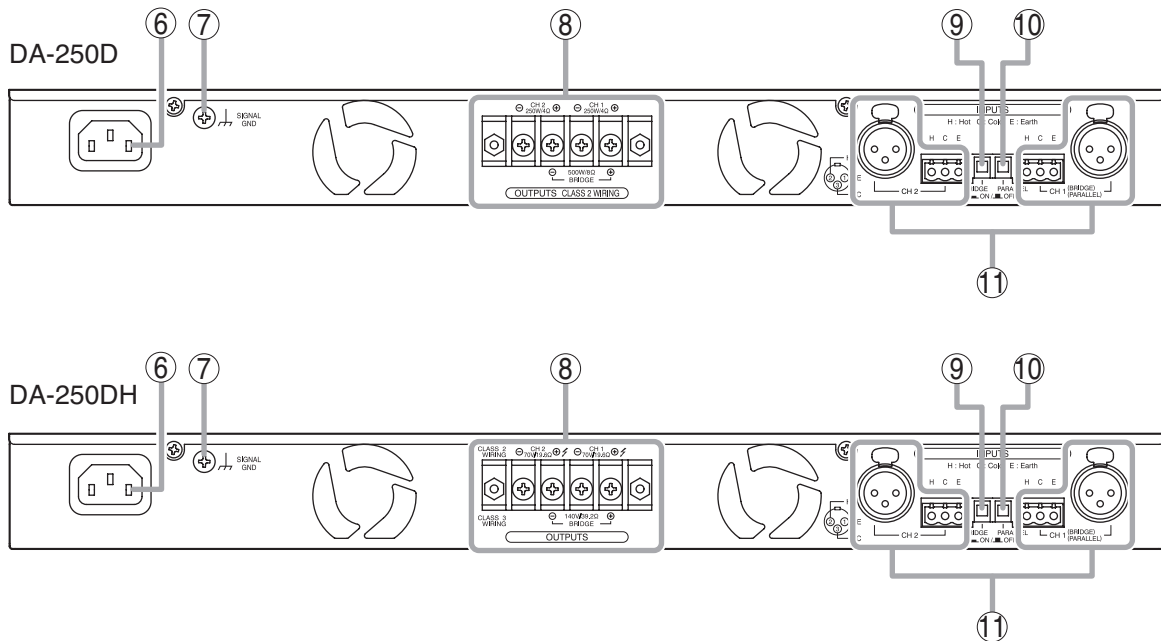

6. AC inlet

Connect the supplied power cord to this inlet.

7. Functional ground terminal [SIGNAL GND]

Hum noise may be generated when external equipment is connected to the unit. Connecting this terminal to the functional ground terminal of the external equipment may reduce the hum noise.

Note

This terminal is not for protective ground.

8. Speaker output terminals (with a terminal cover)

Connect speaker cables to these terminals.

9. BRIDGE ON/OFF switch

[BRIDGE, ON / OFF]

Used when bridge-connecting the unit's Channels 1 and 2.

(See p. 10; Settings and Connections.)

• 2-channel input mode

Set BRIDGE switch to OFF. (factory-preset)

• 1-channel input mode

Set BRIDGE switch to ON.

Note

Be sure to first turn off the power switch when changing the BRIDGE switch settings.

10. CH1 mode ON/OFF switch

[PARALLEL, ON / OFF]

Setting this switch to ON (pressed in) transmits the Channel 1 input signal to both channels 1 and 2. Output signal levels can be individually adjusted with each channel's input level control (3).

Note

Be sure to first turn off the power switch when changing the CH 1 mode switch settings.

11. Input terminals [INPUTS]

Electronically-balanced input terminals.

Each removable terminal block (3 pins) is internally connected in parallel to the corresponding XLR type connector.

• Removable terminal block (3 pins)

H: Hot, C: Cold, E: Earth

• XLR type male connector (XLR-3-31 equivalent)

Pin 1: Earth, Pin 2: Hot, Pin 3: Cold

Caution when using an XLR type plug

If a straight plug hits the rack's rear cover or wall behind the rack when it is used for connection, use the L-shaped plug instead.

8. SETTINGS AND CONNECTIONS

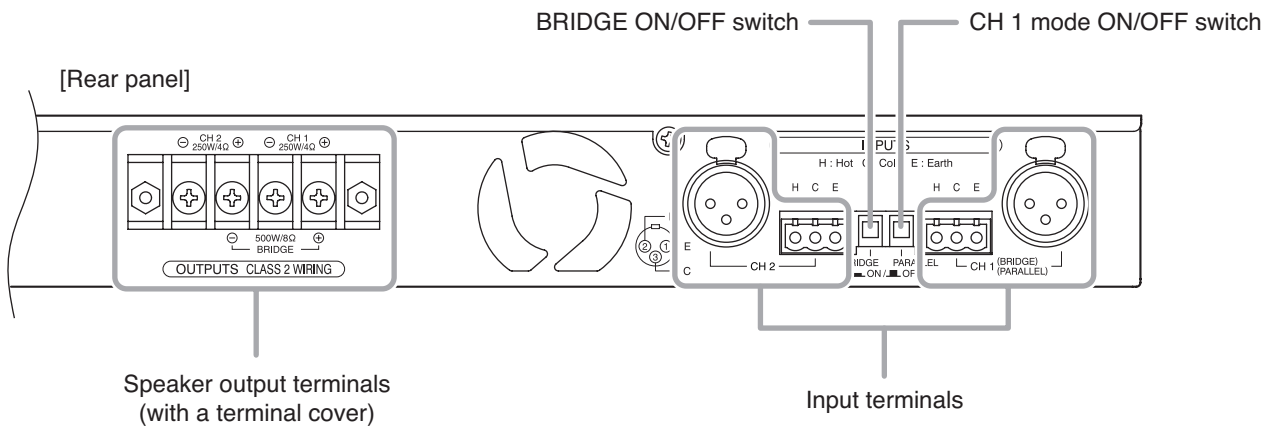

Note: The figure shows the DA-250D.

Step 1. Switch off the unit's power.

Step 2. Set the BRIDGE ON/OFF switch and CH 1 mode ON/OFF switch.

Step 3. Connect the sound source equipment to the Input terminals.

Note: Refer to p. 12 for the removable terminal plug connection.

Step 4. Connect speakers to the Speaker output terminals.

4-1. Unscrew the output terminal cover.

4-2. Strip 10 mm (0.39") of insulative jacket from the end of the speaker cable, as shown in the figure at right.

4-3. Connect speaker cables to the output terminals.

4-4. Replace the output terminal cover in place.

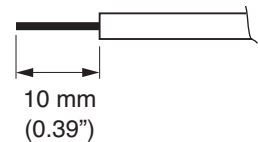

WARNING

Be sure to replace the unit's terminal cover after connection completion. Because high voltage is generated at the speaker output terminals, never touch these terminals to avoid electric shock. (DA-250DH only)

8.1. Switch Settings and Speaker Connections

[2 inputs - 2 outputs] (factory-preset)

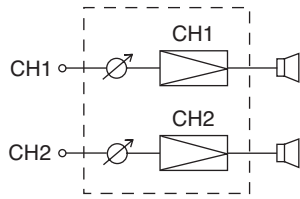

Switch	Setting
BRIDGE	OFF
CH 1 mode	OFF

Speaker output terminals

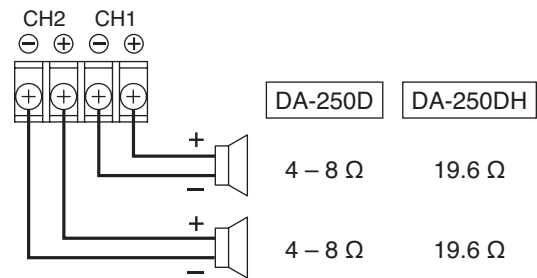

[1 input - 2 outputs]

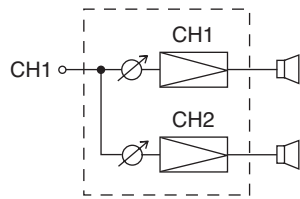

Switch	Setting
BRIDGE	OFF
CH 1 mode	ON

Speaker output terminals

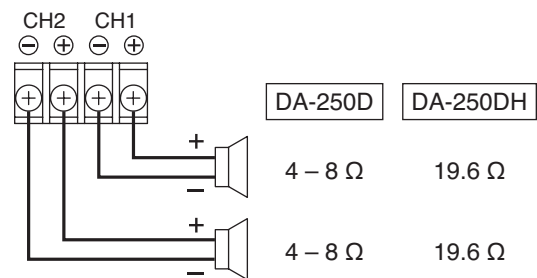

[1 input - 1 output]

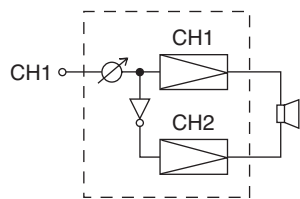

Switch	Setting
BRIDGE	ON
CH 1 mode	OFF

Speaker output terminals

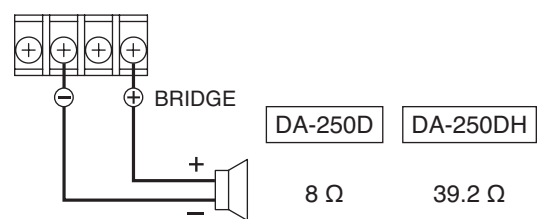

9. REMOVABLE TERMINAL PLUG CONNECTION

Cautions

- Be sure to use shielded cables for audio signal lines.
- Avoid soldering cable conductor, as contact resistance may increase when the cable is tightened and the solder is crushed, possibly resulting in an excessive rise in joint temperatures.
- Use cables of AWG 12 – 24.

Cable end treatment

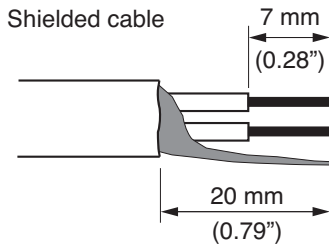

Connector connections

Step 1. Loosen the terminal screw, then insert the cable.

Step 2. Retighten the terminal screw. (Pull on the cable to ensure it is securely connected.)

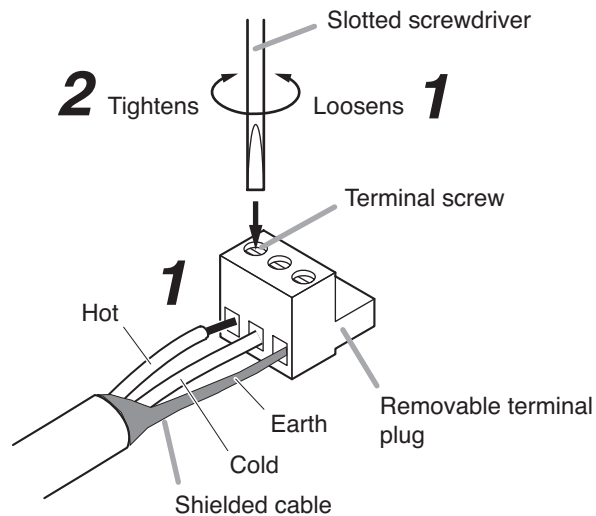

Tip

Recommended slotted screwdriver type: Screwdriver with blade that is 3 mm (0.12") in width

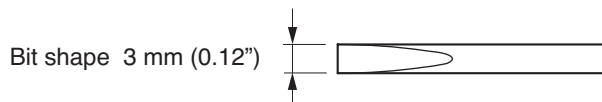

10. INPUT SENSITIVITY AND HIGH-PASS FILTER ON/OFF SETTINGS

The Input sensitivity can be set to +4 dB (factory-preset) or -10 dB for each channel.

Besides, only the DA-250DH employs the High-pass filter on each channel, which can be set to "ON" or "OFF."

CAUTION

These servicing instructions are for use by qualified personnel only. To avoid electric shock, do not perform any servicing other than that contained in the operating instructions unless you are qualified to do so. Refer all servicing to qualified service personnel.

Step 1. Unscrew 7 screws securing the top cover of the unit, then detach it.

Step 2. Change the jumper socket position to "+4 dB" or "-10 dB" for the Input sensitivity as illustrated below.

When a bridge connection is made;

Set the input sensitivity with the CH1 jumper socket when Channels 1 and 2 are bridge-connected. (Input sensitivity setting for the CH2 is disabled.)

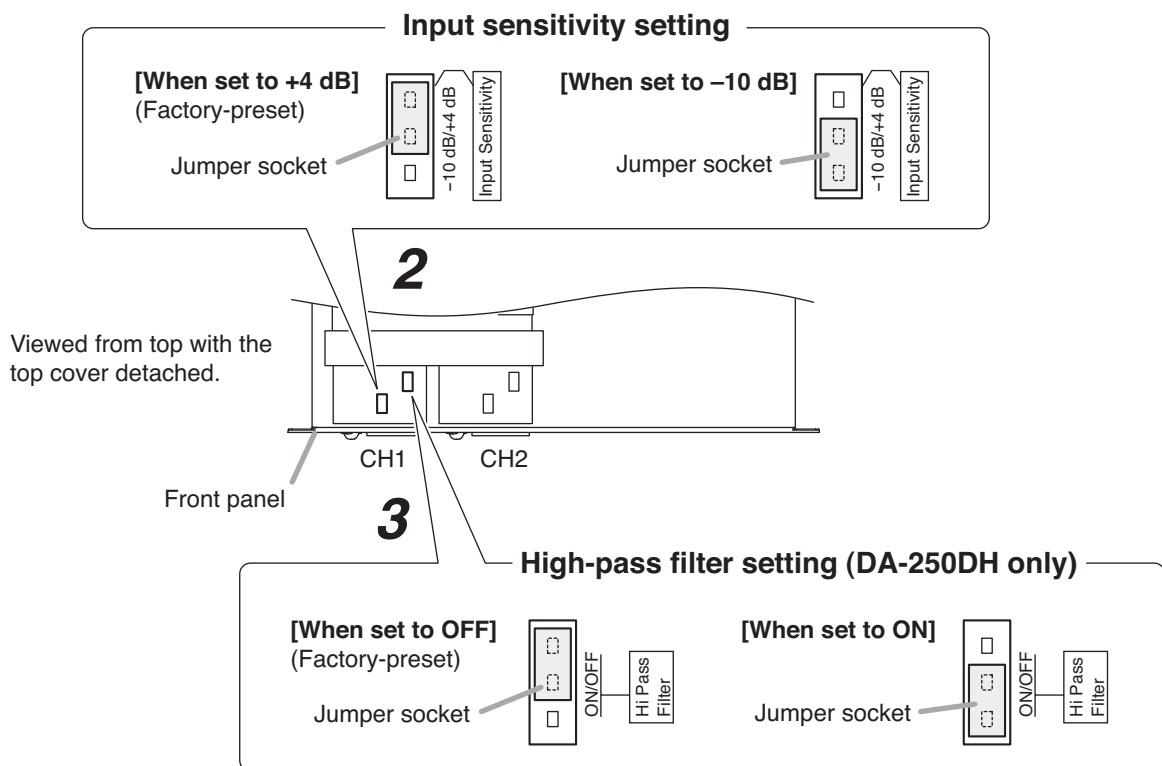

Step 3. Change the jumper socket position to "ON" or "OFF" for the High-pass filter as illustrated above. (DA-250DH only)

CAUTION

With the High-pass filter jumper socket kept to the OFF position (factory preset), operating the unit for long periods of time while the Peak indicator is illuminated due to excessive input signal may damage the connected speakers, possibly resulting in fire.

Operating the unit with the High-pass filter jumper socket set to the ON position may decrease the possibility of speaker damage or fire due to excessive input signal.

When a bridge connection is made;

Perform the same setting for both Channels 1 and 2.

Operating the unit with the different setting may cause unit failure.

Step 4. Replace the detached top cover.

11. PROTECTION OPERATION LIST

Failure	Protection	Operation Indicator	Remedy	Recovery
Overcurrent due to overload	Current limiter activated when impedance drops below the specified value.	Peak indicator lights.	Remove overload.	Connecting a correct load automatically restores normal operation.
Short circuit	Current limiter activated. Load is disconnected.	Protection indicator lights.	Check speakers and lines for short circuit.	Turn off the power switch. Correct the load, then switch on the power.
Rise in heat sink temperature (over 100°C)	Load disconnected.	Protection indicator lights.	Check the unit for correct ventilation and overload.	Operation automatically returns to normal when the temperature decreases.
Temperature rise inside the unit (over 80°C)	Built-in amplifier unit that caused the failure halted.	Four indicators of the corresponding channel extinguish.		
Abnormal DC voltage output	Load disconnected.	Protection indicator lights.	Contact the TOA dealer where the unit was purchased.	

12. TAMPER-PROOF CAP ATTACHMENT

To protect the input level control from accidental operation, it is recommended to replace the control knob with the supplied tamper-proof cap as illustrated.

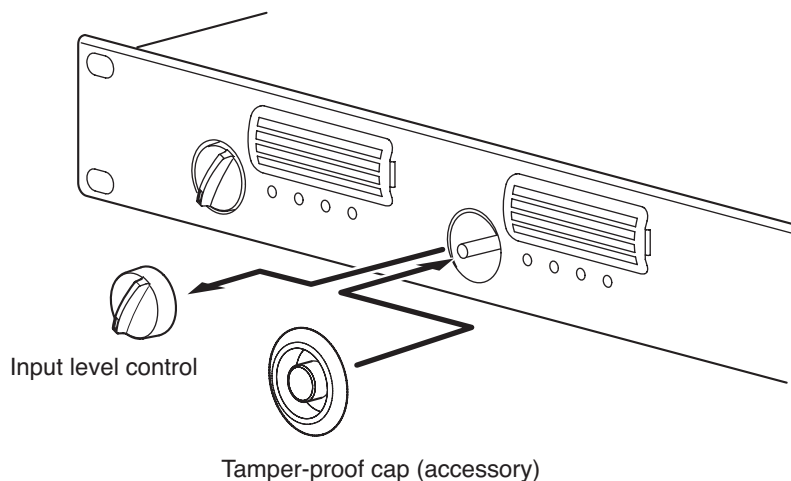

13. CLEANING THE FILTER

Step 1. Switch off the unit's power.

Step 2. Remove the ventilation panel as shown in the figure.

Step 3. Detach the filter inside the ventilation panel.

Step 4. Clear the filter of dust.

Step 5. Replace the filter and ventilation panel.

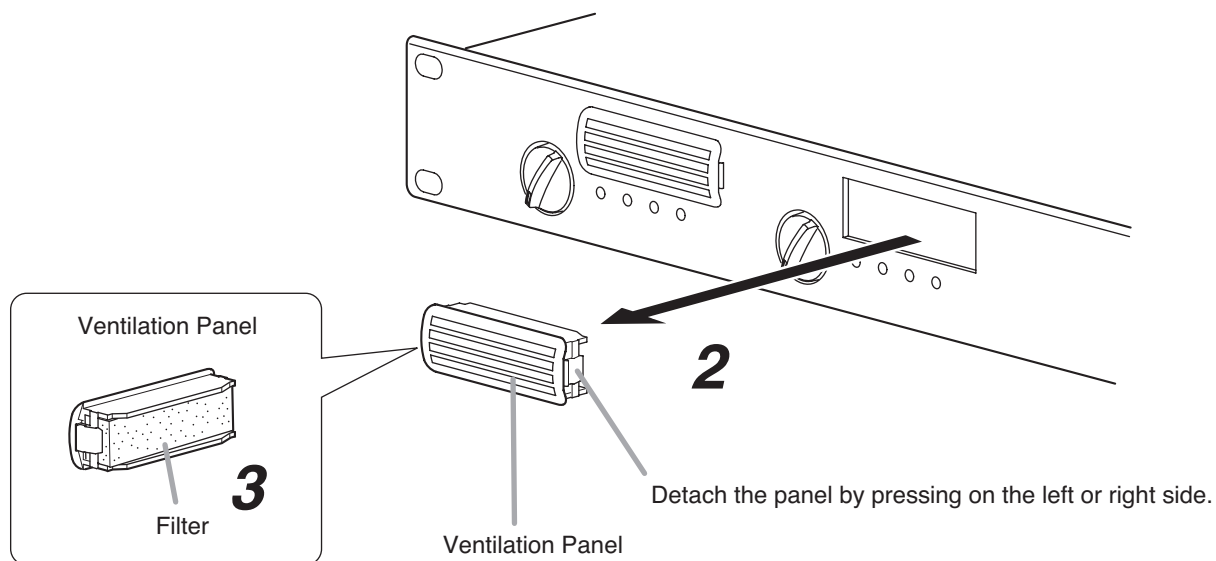

14. BLOCK DIAGRAMS

14.1. DA-250D

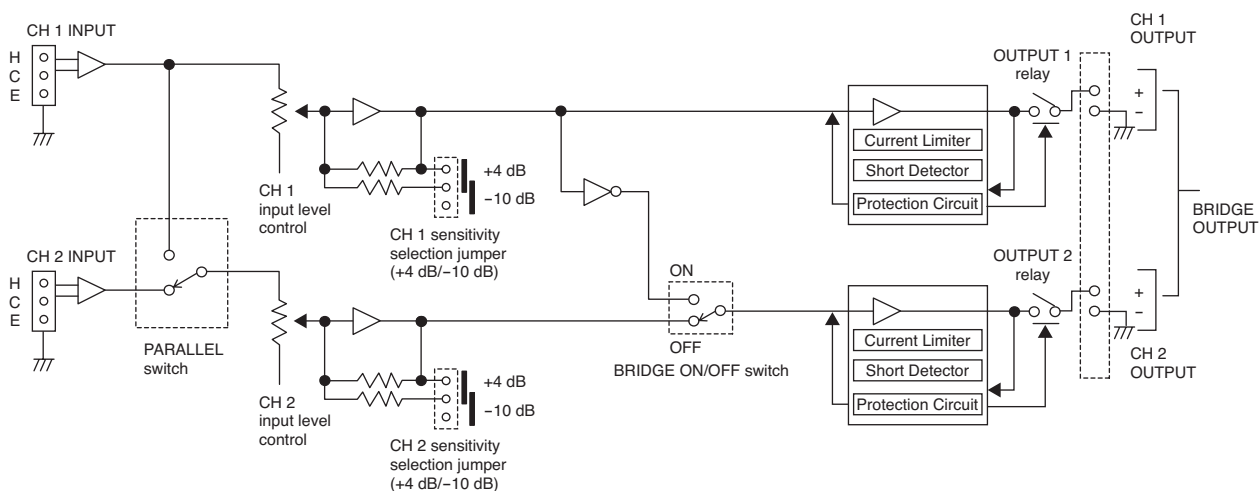

14.2. DA-250DH

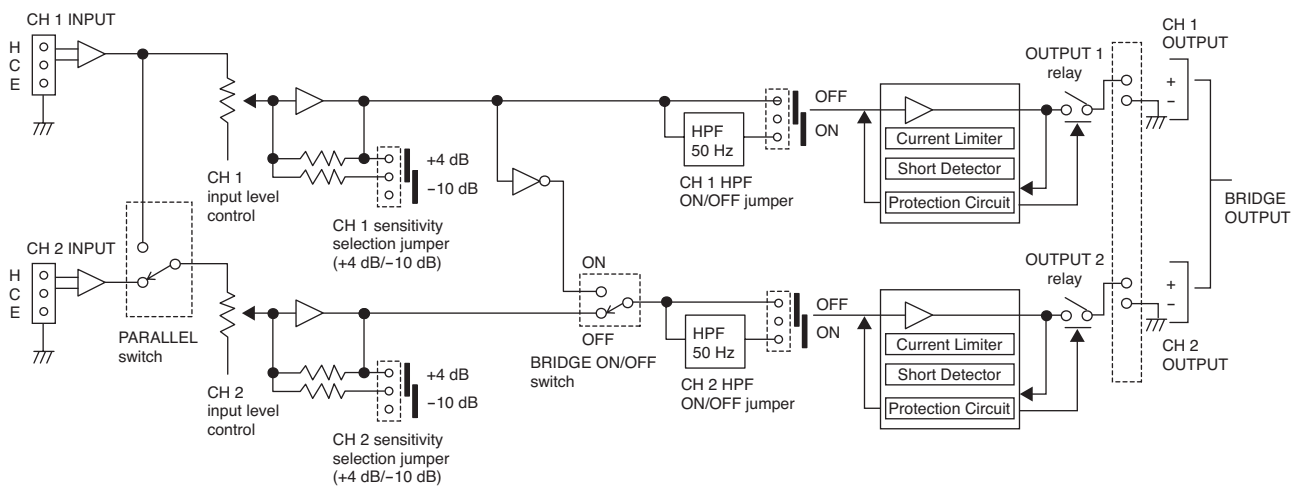

15. DIMENSIONAL DIAGRAM

Unit: mm (inches)

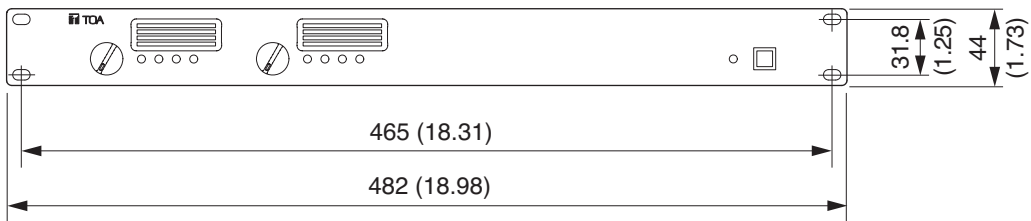
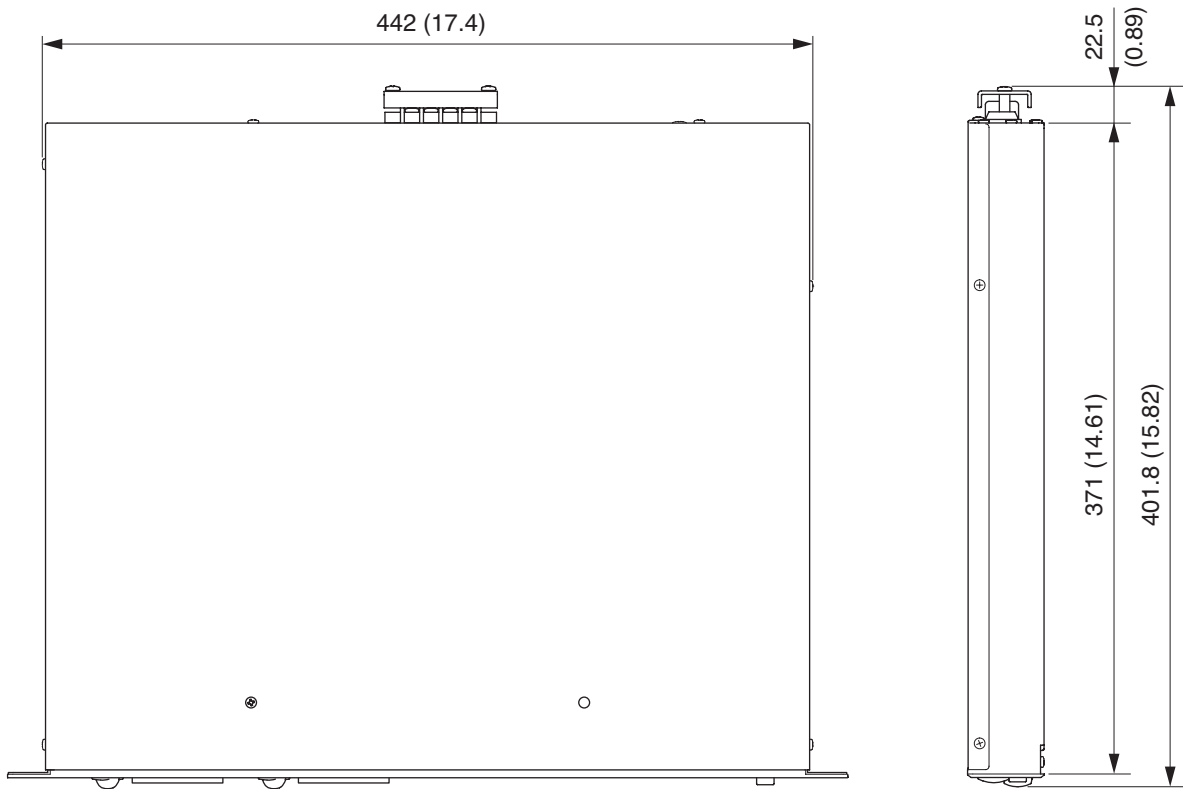

16. SPECIFICATIONS

16.1. DA-250D CU

Power Source	120 V AC, 50/60 Hz
Amplification system	Digital class D
Power Consumption	120 W (based on UL/CSA standards) 650 W (rated output 4 Ω x 2) 420 W (rated output 8 Ω x 2)
Input	2 circuits, +4 dB* (1.23 V, input level control in maximum position), 10 kΩ, electronically-balanced, removable terminal block (3 pins) CH 1 mode ON/OFF switch (ON: PARALLEL, OFF: Each ch)
Rated Output	2 channels: 250 W x 2 (4 Ω), 170 W x 2 (8 Ω) 1 channel (BRIDGE): 500 W (8 Ω) M4 screw terminal, distance between barriers: 8.8 mm (0.35")
Frequency Response	20 – 20,000 Hz (±1 dB)
Total Harmonic Distortion	0.1% (1 kHz), 0.3% (20 – 20,000 Hz)
Protection Circuit	Protection against excessive current flow due to overload, short circuit, unusual DC voltage output, and heat sink temperature rise (over 100°C)
S/N Ratio	100 dB (A-weighted)
Crosstalk	70 dB (A-weighted)
LED Indicator	Power (blue) x 1, Input (green) x 2, Output (yellow) x 2, Peak (red) x 2, Protect (red) x 2
Cooling	Forced air cooling
Operating Temperature	-10°C to +40°C (14°F to 104°F)
Operating Humidity	Under 90% RH (no condensation)
Finish	Panel: Aluminum, black, alumite Case: Plated steel sheet
Dimensions	482 (w) x 44 (h) x 401.8 (d) mm (18.98" x 1.73" x 15.82")
Weight	5 kg (11.02 lb)

* 0 dB = 0.775 V

Note: The design and specifications are subject to change without notice for improvement.

• Accessories

Power cord (2 m)	1
Removable terminal plug (3 pins)	2
Tamper-proof cap	2

16.2. DA-250DH CU

Power Source	120 V AC, 50/60 Hz
Amplification system	Digital class D
Power Consumption	120 W (based on UL/CSA standards) 580 W (rated output 19.6 Ω x 2)
Input	2 circuits, +4 dB* (1.23 V, input level control in maximum position), 10 kΩ, electronically-balanced, removable terminal block (3 pins) CH 1 mode ON/OFF switch (ON: PARALLEL, OFF: Each ch)
Rated Output	2 channels: 250 W x 2 (19.6 Ω) 1 channel (BRIDGE): 500 W (39.2 Ω) M4 screw terminal, distance between barriers: 8.8 mm (0.35")
Frequency Response	20 – 20,000 Hz (±1 dB): HPF OFF 50 – 20,000 Hz (–3 dB, +0 dB): HPF ON (selectable with the inner jumper)
Total Harmonic Distortion	0.1% (1 kHz), 0.3% (20 – 20,000 Hz): HPF OFF 0.1% (1 kHz), 0.3% (100 – 20,000 Hz): HPF ON
Protection Circuit	Protection against excessive current flow due to overload, short circuit, unusual DC voltage output, and heat sink temperature rise (over 100°C)
S/N Ratio	100 dB (A-weighted)
Crosstalk	70 dB (A-weighted)
LED Indicator	Power (blue) x 1, Input (green) x 2, Output (yellow) x 2, Peak (red) x 2, Protect (red) x 2
Cooling	Forced air cooling
Operating Temperature	–10°C to +40°C (14°F to 104°F)
Operating Humidity	Under 90% RH (no condensation)
Finish	Panel: Aluminum, black, alumite Case: Plated steel sheet
Dimensions	482 (w) x 44 (h) x 401.8 (d) mm (18.98" x 1.73" x 15.82")
Weight	5 kg (11.02 lb)

* 0 dB = 0.775 V

Note: The design and specifications are subject to change without notice for improvement.

• Accessories

Power cord (2 m)	1
Removable terminal plug (3 pins)	2
Tamper-proof cap	2



TOA Corporation

URL: <http://www.toa.jp/>

133-22-125-50

Free Manuals Download Website

<http://myh66.com>

<http://usermanuals.us>

<http://www.somanuals.com>

<http://www.4manuals.cc>

<http://www.manual-lib.com>

<http://www.404manual.com>

<http://www.luxmanual.com>

<http://aubethermostatmanual.com>

Golf course search by state

<http://golfingnear.com>

Email search by domain

<http://emailbydomain.com>

Auto manuals search

<http://auto.somanuals.com>

TV manuals search

<http://tv.somanuals.com>