

VENTURER

Dual Alarm Clock Radio for iPod

Model No.: CR3663i

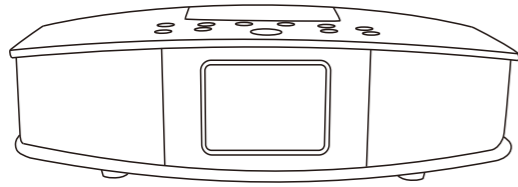

User's Guide

SAFETY PRECAUTIONS

FCC Information

This device complies with Part 15 of the FCC rules. Operation is subject to the following two conditions: (1) This device may not cause harmful interference, and (2) This device must accept any interference received, including interference that may cause undesired operation.

NOTE: This equipment has been tested and found to comply with the limits for a Class B digital device, pursuant to part 15 of the FCC Rules. These limits are designed to provide reasonable protection against harmful interference in a residential installation. This equipment generates, uses, and can radiate radio frequency energy and, if not installed and used in accordance with the instructions, may cause harmful interference to radio communications. However, there is no guarantee that interference will not occur in a particular installation. If this equipment does cause harmful interference to radio or television reception, which can be determined by turning the equipment off and on, the user is encouraged to try to correct the interference by one or more of the following measures:

- Reorient or relocate the receiving antenna.
- Increase the separation between the equipment and receiver.
- Connect the equipment into an outlet on a circuit different from that to which the receiver is connected.
- Consult the dealer or an experienced radio/TV technician for help.

WARNING: Changes or modifications to this unit not expressly approved by the party responsible for compliance could void the user authority to operate the equipment.

This class B digital apparatus complies with Canadian ICES-003.

CAUTION: The marking information is located at the bottom of the apparatus.

Warnings:

- The AC adaptor is used as disconnect device and it should remain readily operable during intended use. In order to disconnect the apparatus from the mains completely, the AC adaptor should be disconnected from the mains socket outlet completely.
- Minimum 10 cm (4 inches) distances around the apparatus for sufficient ventilation.
- Batteries shall not be exposed to excessive heat such as sunshine, fire or the like.
- The ventilation should not be impeded by covering the ventilation openings with items such as newspaper, table-cloths, curtains, etc.
- No naked flame sources such as lighted candles should be placed on the apparatus.

On Operation

Do not turn up the volume while listening to your iPod with no audio signals or very low level inputs. If you do so, the speakers may be damaged when the peak level of the sound is played.

On Use

Use the unit in moderate climates. Never use the unit where it would be subject to:

- Heat sources such as radiators or air ducts.
- Direct sunlight.
- Excessive dust.
- Moisture or rain.
- Mechanical vibration or shock.
- Uneven surface.
 - Do not place any heavy objects on top of the unit.
 - When the unit is used with an AC power adaptor, do not wrap the unit in a cloth, blanket, etc.. If you do so, the temperature inside and outside the unit may rise considerably, resulting in malfunctioning of the unit.
 - If the unit is brought directly from a cold to a warm location, or is placed in a very damp room, the moisture may condense on the lens inside the unit. Should this occur, the unit will not operate. In this case, remove the disc and leave the unit in a warm place for several hours until the moisture evaporates.
 - For the unit to operate at its best, it should not be subject to temperatures below 41°F (5°C) or above 95°F (35°C).

LOCATION OF CONTROLS

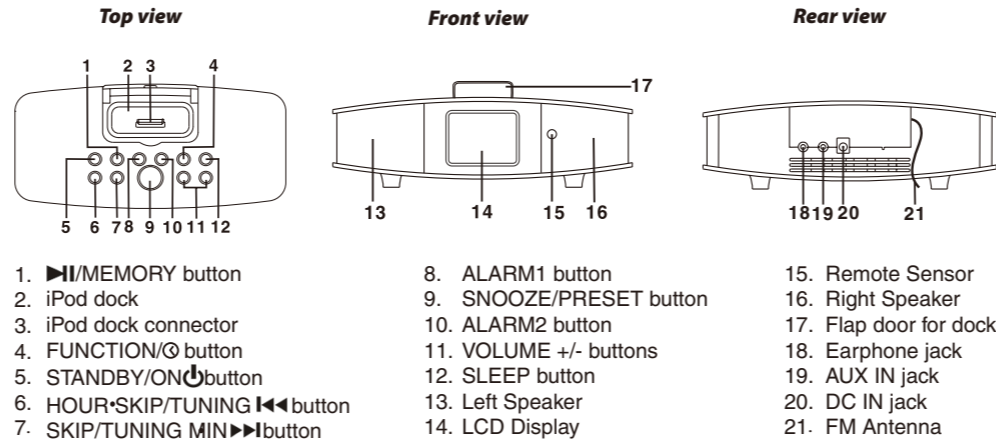

REMOTE CONTROL

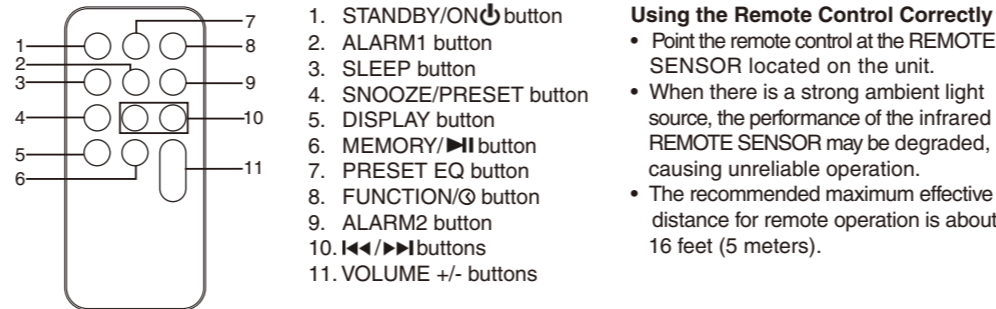

Using the Remote Control Correctly

- Point the remote control at the REMOTE SENSOR located on the unit.
- When there is a strong ambient light source, the performance of the infrared REMOTE SENSOR may be degraded, causing unreliable operation.
- The recommended maximum effective distance for remote operation is about 16 feet (5 meters).

To Change Battery

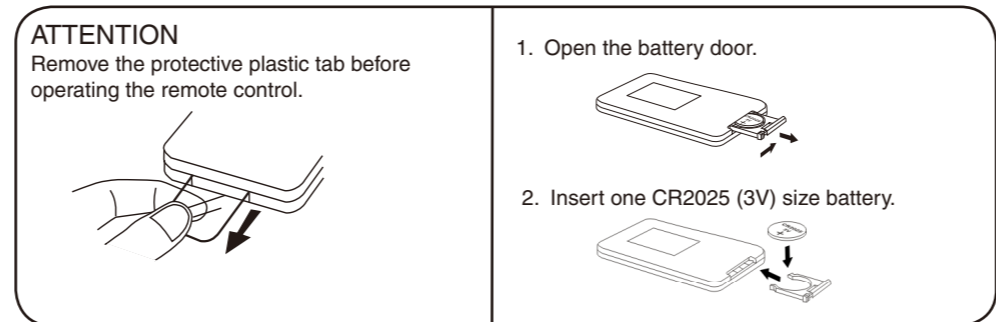

Battery Replacement

When the battery becomes weak, the operating distance of the remote control is greatly reduced and you will need to replace it.

Note: If the remote control is not going to be used for a long time, remove the battery to avoid damage caused by battery leakage corrosion.

WARNINGS:

- Do not dispose of battery in fire; battery may explode or leak.
- Battery shall not be exposed to excessive heat such as sunshine, fire or the like.
- Danger of explosion would be resulted if battery is incorrectly replaced. Replace only with the same or equivalent type of battery.

CAUTION: When discarding batteries, environmental problems must be considered and local rules or laws governing the disposal of these batteries must be strictly followed.

POWER SUPPLY

USING THE AC Adaptor

Using an AC adaptor which is not supplied with the unit may damage the unit. The supplied AC adaptor operates on AC 100V-240V~50/60Hz.

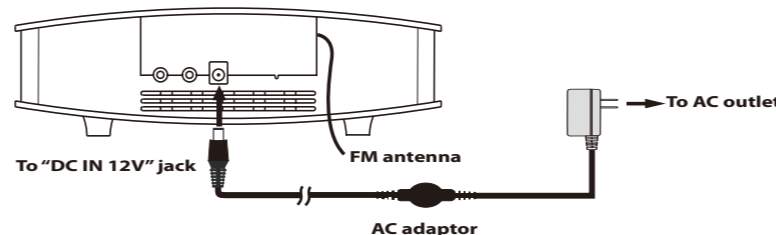

CAUTIONS:

- Before use, ensure the rated voltage of the adaptor matches your local voltage.
- The supplied AC adaptor is for use with this unit only. Do not use it with other equipment.
- If you are not going to use the unit for a long time, disconnect the AC adaptor from the wall outlet.
- Whenever the AC adaptor is plugged in to a wall outlet, electricity is running through the unit, even when the power switch is turned off.

POWER BACK-UP DURING POWER INTERRUPTION

Open the battery door and insert two "1.5V UM-4/AAA size" batteries into the battery compartment. Be sure to install two optional "1.5V UM-4/AAA size" batteries for the power back-up function. If the AC power supply is interrupted, the batteries supply power to keep the clock operating and the alarm times set.

- During power interruption, the clock function is still maintained. The alarm sound will not come on.
- These batteries are only for clock operation and alarm memory during power interruption. You cannot listen to the radio/iPod/AUX with the batteries.

WHEN TO REPLACE THE BATTERIES

To check the batteries' condition, unplug the AC adaptor from the wall outlet and plug it in again after a few minutes. If the displayed time is incorrect, replace the batteries with new ones.

WARNINGS:

- Danger of explosion if batteries are incorrectly replaced. Replace only with the same or equivalent type.
 - Be sure to install the batteries before unplugging the AC adaptor.
 - When the unit is going to be left unplugged for a long time, remove the batteries to avoid undue battery discharge and unit damage from battery leakage.
 - Do not dispose of battery in a fire; battery may explode or leak.
- CAUTION:** When discarding batteries, environmental problems must be considered and local rules or laws governing the disposal of these batteries must be strictly followed.

VOLUME ADJUSTMENT

TO ADJUST THE VOLUME

Adjust the VOLUME control to obtain the desired volume.

FOR PERSONAL LISTENING

Connect headphones (Ø3.5mm stereo mini plug) to the PHONES jack. Adjust the VOLUME control to obtain the desired volume. When headphones are connected, the speakers are automatically disconnected.

CLOCK SETTING

Setting the clock can only be done in STANDBY mode.

1. Press and hold the **FUNCTION/⊙** button until the hour and the minute digits blink.
2. Press the **HOUR/◀◀** button to adjust the desired hours.
3. Press the **MIN/▶▶** button to adjust the desired minutes.
4. Press the **FUNCTION/⊙** button once to confirm.

12:00 PM = NOON time. The "PM" indicator will light up.

Notes:

- In RADIO mode, press the **DISPLAY** button on the remote control to shuffle between the current radio station and the current time.
- In iPod/AUX mode, the current time is always shown on the display.

LISTENING TO THE RADIO

1. Press the **STANDBY/ON** button to turn the unit on.
2. Press the **FUNCTION/⊙** button to FM or AM band.
3. Press the **◀◀** or **▶▶** button to tune in to a station.
- Adjust the volume control to obtain the desired volume.

Searching for a Station Automatically

- Press and hold the **◀◀** or **▶▶** button until the tuner starts searching for a station, then release. After tuning into a station, the search stops.
- The search may not stop at a station with a very weak signal.

Presetting Stations

The unit can store a total of 20 stations in memory (10FM, 10AM). Presetting allows you to tune in to a station directly.

1. Tune in to a desired station.
2. Press the **►|/MEMORY** button. The preset number will blink and the "MEM" indicator will be shown on the display.
3. Press the **PRESET/SNOOZE** button to select the preset number.
4. Press the **►|/MEMORY** button again to store it in memory.
5. Repeat steps 1-4 to store other stations.

Tuning in to a Preset Station

1. Press the **PRESET/SNOOZE** button, the preset number and "MEM" will be shown on the display.
2. Press the **PRESET/SNOOZE** button repeatedly to select the preset number for your desired station.

For Better Reception

FM: Fully unwind the antenna wire. Extend the antenna wire and place it in the position that sounds best.

Note: Do not connect the FM antenna to an outside antenna.

When the reception is good, the "STEREO" indicator will appear on the display.

AM: Reposition the unit to get better AM reception.

Note: To prevent possible interference to the AM signal, please keep a certain distance (The AC adaptor cable's length) away from the main unit.

LISTENING TO YOUR IPOD

iPod Compatibility

The unit works with iPod mini (4GB, 6GB), iPod nano (1st generation) - 1GB, 2GB, 4GB, iPod 5th generation (video) - 30GB, 60GB, 80GB, iPod nano (2nd generation) - 2GB, 4GB, 8GB, iPod classic (80GB, 160GB), iPod nano 3rd generation (video) - 4GB, 8GB and iPod touch (8GB, 16GB, 32GB). Other iPod models (and other audio devices) are supported through the AUX IN jack on the unit back panel (see AUX IN CONNECTION section).

iPod Dock Adaptor

Before connecting your iPod, you need to install the appropriate iPod Dock Adaptor in the dock of the unit. Four iPod Dock Adaptors are included as shown below (if the adaptor is not supplied in the accessory, please use the adaptor that comes with your iPod.):

iPod Adaptor No.	iPod Description	Capacity
9	iPod 5th generation (video)	30GB
	iPod classic	80GB
10	iPod 5th generation (video)	60GB, 80GB
	iPod classic	160GB
13	iPod nano 3rd generation (video)	4GB, 8GB
14	iPod touch	8GB, 16GB, 32GB

Installing the iPod Dock Adaptor

- Choose the iPod Dock Adaptor that fits your iPod (if the adaptor is not supplied in the accessory, please use the adaptor that comes with your iPod).
- Lift up the iPod Dock flap door to approximately 90°.
- Insert your iPod Dock Adaptor into the dock until it sits firmly in place.

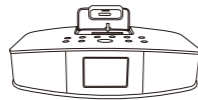
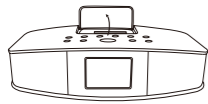

Removing the iPod Dock Adaptor

Remove the Dock Adaptor by gripping the inside with your thumb, then lifting out the adaptor using the friction between your thumb and the adaptor.

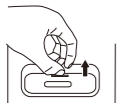

Inserting Your iPod

- Ensure the appropriate iPod Docking Adaptor is installed.

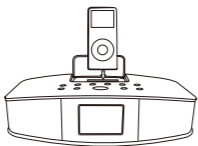

Start playback

- Press the **STANDBY/ON** button to turn on the unit.
- Press the **FUNCTION** button repeatedly until the indicator "iPod" appears on the display.
- Press the **MEMORY** button to start playing.

Notes:

- The iPod will charge automatically while docked in the cradle.
- To prevent possible interference to the AM signal, please switch off the iPod while the radio is playing.

Pausing Playback

- Press the **MEMORY** button.
- To resume playback, press the **MEMORY** button again.

Skipping to a Another Track

- Press the **SKIP** button to skip to the beginning of the current track or skip to previous track. Press the **SKIP** button to skip to the beginning of the next track.

Locating a Particular Point on a Track

- Keep either the **SKIP** or **SKIP** button pressed during playback, according to the desired direction, and release at the desired point.

Note: Please refer to the user's guide that was included with your iPod for more details.

AUX IN CONNECTION

Connecting to AUX IN for other sound sources

You can connect audio devices such as your iPod, CD players or MP3 players to the unit through the AUX IN jack. Use the Line-in cable (not supplied), connect the AUX IN jack on the back panel to the Line Out or Earphone jack of the other audio devices.

Listening to the Connected Device

- Press the **FUNCTION** button to AUX IN mode and "AUX" is shown on the display.
- Turn on the audio device you have attached to the AUX IN jack.

PRESET EQ

This system supports a variety of equalizers and sound effects.

During playback, press the **PRESET EQ** button on the remote control to select a desired music mode. Each time the **PRESET EQ** button is pressed, the music mode will be changed to the next one as follows:

OFF -> ROCK (ROCK) -> POP -> CLASSIC (CLASSIC)



DUAL ALARM SETTING

The unit should be in STANDBY mode to set alarm.

- The alarm can be set to activate twice a day by setting two different alarm times in ALARM1 and ALARM2.
- The unit can be set to "Buzzer", "Radio" or "iPod" alarm.

To Set Alarm 1

- Press the **ALARM1** button, the "AL" icon blinks on the display.
- Press the **ALARM1** button once again, then the "AL" icon, hour & minute digits blink on the display.
- Press the **HOUR** button to adjust the hours.
- Press the **MIN** button to adjust the minutes.
- Press the **FUNCTION** button to select "Buzzer", "FM", "AM", "iPod".
- Adjust the volume control to obtain the desired volume for the Alarm1.
- Press the **ALARM1** button again to confirm.
- The Alarm 1 indicator will light up.

Note: For the "Radio" Alarm, you should tune into your desired radio station before setting alarms-the alarm will turn on to the last station you tuned.

The clock radio will wake up to "Buzzer", "Radio", "iPod", when alarm timer reaches the preset time and then turns off automatically after 60 minutes.

TO SET ALARM 2

Setting the alarm for Alarm2 is the same as setting Alarm1 (Use the **ALARM2** button instead of the **ALARM1** button).

Note: If the Alarm1 & Alarm2 are set to the same time, the unit will activate once only.

TO TURN OFF ALARM

- Snooze (If you want to snooze a few more minutes)
 - Pressing the **SNOOZE** button will deactivate the sound for 9 minutes. You can repeat this function as many times as you like within 60 minutes from the preset alarm time.
- To stop alarm sound
 - Press the **STANDBY/ON** button to stop alarm sound, Alarm Mode will stay active-alarm will activate again in 24 hours.

TO CHANGE THE ALARM TIME

Set the alarm time again.

TO CANCEL ALARM MODE

After setting alarms, press and hold the **ALARM1** or **ALARM2** button for 2 seconds until the Alarm1 or Alarm2 indicator disappears.

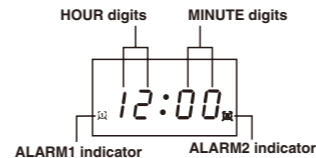

SLEEP TIMER SETTING

The sleep timer automatically turns the unit off after a certain time.

- While the unit is on, press the **SLEEP** button-the display will indicate "90".
- Press the **SLEEP** button repeatedly to select the desired sleep time as below:

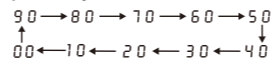

- After setting a desired sleep time, the "SLEEP" icon will be shown on the display.
- The unit will automatically turn off once it counts down the sleep time.

- To clear the preset sleep time, keep pressing the **SLEEP** button until "00" is shown. The "SLEEP" icon disappears.

TROUBLE SHOOTING GUIDE

PROBLEMS

CLOCK

Clock does not show the correct time.

Alarm does not come on at the preset time.

RADIO

Poor FM reception

Poor AM reception

iPod

iPod does not dock properly or does not install properly.

iPod does not respond to the speaker system.

ITEMS TO CHECK

- There has been an electrical power interruption. Reset the clock.

- Is the current time correctly set on the time display?
- Is the alarm time correctly set?

- Make sure FM antenna wire is unwound.
- Electrical interference in your home can cause poor reception. Move the unit away from sources of interference (especially those with motors and transformers).
- Reposition or turn the main unit for better reception.

- Remove your iPod from the dock and check for obstruction on the connectors in the dock and on your iPod. Make sure you are using the appropriate adaptor for your model of iPod.

- Make sure that your iPod is working properly before docking into the unit. Please refer to your iPod manual for details.

MAINTENANCE

Cleaning the Unit

- Do not use volatile chemicals on this unit. Clean by lightly wiping with a soft cloth.

Cleaning the LCD Screen

- Do not touch it with abnormal force or sharp-edged hardware.
- Use a soft, non-abrasive cloth (such as a camera lens cloth) to clean the LCD screen. If it is extremely dirty, do not apply the cleaning liquid directly to it. Moisten the cleaning cloth with the cleaning solution and wring out thoroughly, then clean it, and wipe with a dry cloth again.

Download from www.Somanuals.com. All Manuals Search And Download.

SPECIFICATIONS

DC: 12V --- 1.25A EXTERNAL DC SUPPLY
 BACKUP BATTERIES FOR CLOCK: 2x1.5V UM-4 OR AAA SIZE
 RADIO FREQUENCY: AM 520 ~ 1710KHz
 FM 87.5 ~ 108.0MHz

Design and specifications are subject to change without notice.

LIMITED WARRANTY

VENTURER ELECTRONICS ("VENTURER") makes the following limited warranty. This limited warranty extend to the original consumer purchaser and is limited to non-commercial use of the product.

Ninety (90) Day Parts & Labor Warranty

Venturer products purchased in the United States are warranted to be free from defects in materials or workmanship for a period of ninety (90) days from the date of their original retail purchase. If the unit fails to conform to this warranty, we will service the product using new or refurbished parts and products, at **VENTURER's** sole discretion.

During a period of ninety (90) days from the effective warranty date, **VENTURER** will provide, when needed, service labor to repair a manufacturing defect at its designated Service Center. To obtain warranty service in the United States, you must first call our **Customer Support Center at 1- 866 - 444 - 6478, 1- 800 - 252 - 6123, during the hours listed in the box below.** The determination of service will be made by **VENTURER** Customer Support. **PLEASE DO NOT RETURN YOUR UNIT TO VENTURER WITHOUT PRIOR AUTHORIZATION.** New or remanufactured replacements for defective parts or products will be used for repairs by **VENTURER** at its designated Service Center for ninety (90) days from the effective warranty date. Such replacement parts or products are warranted for an additional ninety (90) days from the date of repair or replacement. The Customer will be required to ship the unit to the Service Center indicated at the time Customer Support is contacted to make the necessary repairs. The customer is responsible for all transportation charges to the service facility.

Packaging and Shipping Instruction

When you send the product to the **VENTURER** service facility you must use the original carton box and packing material or an equivalent as designated by **VENTURER.**

LIMITED WARRANTY

Your Responsibility

- You must retain the original sale receipt to provide proof of purchase.
- These warranties are effective only if the product is purchased and operated in the U.S.A. or Canada.
- Warranties extend only to defects in material or workmanship, and do not extend to any product or parts which have been lost or discarded, or damage to product or parts caused by misuse, accident, improper operation or maintenance, or use in violation of instructions provided with the product, or to product which has been altered or modified without authorization of **VENTURER**, or to products or parts thereof which have had the serial number removed or changed.

Out of Warranty

In the event your product requires repair after the limited warranty period has expired, please contact our Customer Support Center at **1- 866 - 444 - 6478, 1- 800 - 252 - 6123 or www.venturer.com**
Hours: Monday-Thursday: 9-7, Friday: 9-5, Saturday: 9-12 EST
Important:
 You are responsible for any transportation, shipping or insurance relative to the return of the product to our Product Returns Center.

All warranties implied by state law, including the implied warranties of merchantability and fitness for a particular purpose, are expressly limited to the duration of the limited warranties set forth above. With the exception of any warranties implied by state law as hereby limited, the foregoing warranty is exclusive and in lieu of all other warranties, guarantees, agreements and similar obligations of manufacturer or seller with respect to the repair or replacement of any parts. In no event shall **VENTURER** be liable for consequential or incidental damages.

No person, agent, distributor, dealer or company is authorized to change, modify or extend the terms of these warranties in any manner whatsoever. The time within action must be commenced to enforce any obligation of **VENTURER** arising under the warranty or under any statute, or law of the United States or any state thereof, is hereby limited to ninety (90) days from the date of purchase. This limitation does not apply to implied warranties arising under state law.

This warranty gives you specific legal rights and you may also have other rights, which may vary from state to state. Some states do not allow limitations on how long an implied warranty lasts, when an action may be brought, or the exclusion or limitation of incidental or consequential damages, so the above provisions may not apply to you.

For more information on other products and services, please visit our web site at: **www.venturer.com**

Important: Also keep your "Bill of Sale" as proof of purchase.

Model no.Product name.....
 Type of set.....
 Serial no.Invoice no.
 Date purchased.....Dealer name.....

Free Manuals Download Website

<http://myh66.com>

<http://usermanuals.us>

<http://www.somanuals.com>

<http://www.4manuals.cc>

<http://www.manual-lib.com>

<http://www.404manual.com>

<http://www.luxmanual.com>

<http://aubethermostatmanual.com>

Golf course search by state

<http://golfingnear.com>

Email search by domain

<http://emailbydomain.com>

Auto manuals search

<http://auto.somanuals.com>

TV manuals search

<http://tv.somanuals.com>