

## CONNECTIONS (continued)

### B. CONNECTING THE VIDEO GAME SYSTEM

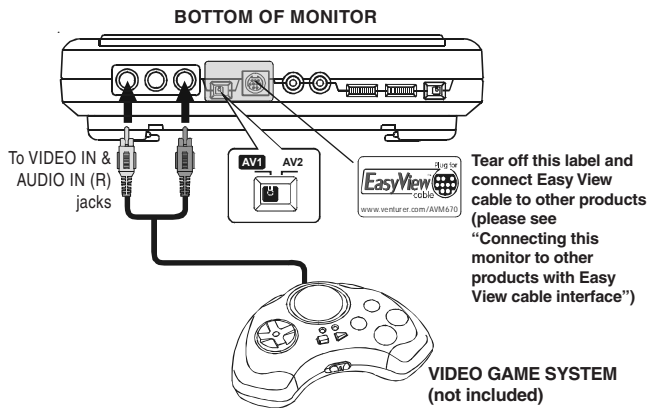

#### Playing a Video Game System

1. Turn on the monitor (the AV1 / AV2 switch in AV1 position).
2. Turn on the video game system and follow the instructions provided with it to play game.

### C. CONNECTING THIS MONITOR TO OTHER PRODUCTS WITH EASY VIEW CABLE INTERFACE

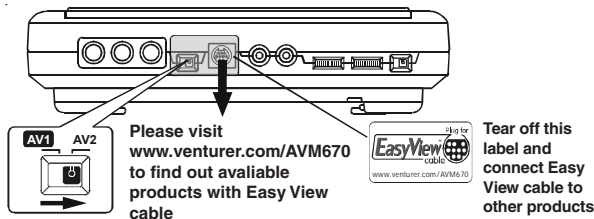

#### Watching an other product

1. Turn on the monitor, slide the AV1 / AV2 switch to AV2 position.
2. Turn on the other product and follow the instructions provided with it to playback.

## SCREEN VIEWING ANGLE ADJUSTMENT

The monitor is designed to allow users to have a comfortable viewing angle. The viewing angle can be adjusted as top -12°~+12°.

1. Push screen frame to adjust viewing angle.

**CAUTION:** Do not force the screen frame over its maximum viewing angle settings as stated above. Attempting this will result in damaging the monitor.

2. Hold the monitor and pull the stand backward until the monitor is stably stand as shown.

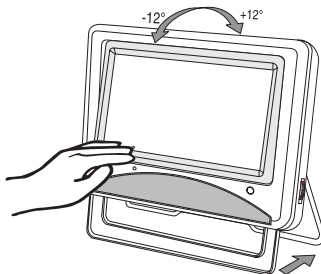

## USING HEADPHONES / EARPHONES

- Turn down the volume before connection, and then adjust the level.
- When headphones / earphones are connected on monitor, no sound will be output from the monitor's speakers.

#### Caution:

Avoid listening to sound at excessive levels which could be harmful to your ears.

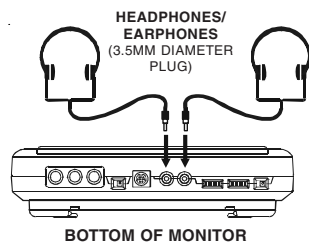

## MAINTENANCE

### CLEANING THE MONITOR

- Be sure to turn the monitor off and disconnect the AC adapter before maintaining the monitor.
- Wipe the monitor with a dry soft cloth.
- If the surfaces are extremely dirty, wipe clean with a cloth which has been dipped in a weak soap-and-water solution and wrung out thoroughly, then wipe with a dry cloth.
- Never use alcohol, benzine, thinner, cleaning fluid or other chemicals. Do NOT use compressed air to remove dust.

## Universal 7" Color TFT LCD Monitor

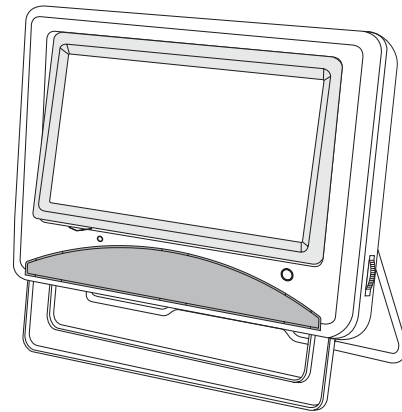

### Instruction manual

## NEED MORE HELP?

**DO NOT RETURN THIS TO THE STORE  
PLEASE CALL CUSTOMER SERVICE AT  
1-800-252-6123 (ET)  
OR VISIT ONLINE HELP AT <http://www.18002526123.com>**

## WARNING

TO PREVENT FIRE OR SHOCK HAZARD, DO NOT USE THIS PLUG WITH AN EXTENSION CORD, RECEPTACLE OR OTHER OUTLET UNLESS THE BLADES CAN BE FULLY INSERTED TO PREVENT BLADE EXPOSURE. TO PREVENT FIRE OR SHOCK HAZARD, DO NOT EXPOSE THIS APPLIANCE TO RAIN OR MOISTURE.



THE LIGHTNING FLASH WITH ARROWHEAD SYMBOL, WITHIN AN EQUILATERAL TRIANGLE, IS INTENDED TO ALERT THE USER TO THE PRESENCE OF UNINSULATED "DANGEROUS VOLTAGE" WITHIN THE PRODUCT'S ENCLOSURE THAT MAY BE OF SUFFICIENT MAGNITUDE TO CONSTITUTE A RISK OF ELECTRIC SHOCK TO PERSONS.

**CAUTION**  
RISK OF ELECTRIC SHOCK  
DO NOT OPEN

**WARNING:** TO REDUCE THE RISK OF ELECTRIC SHOCK, DO NOT REMOVE COVER (OR BACK) NO USER-SERVICEABLE PARTS INSIDE. REFER SERVICING TO QUALIFIED SERVICE PERSONNEL.



THE EXCLAMATION POINT WITHIN AN EQUILATERAL TRIANGLE IS INTENDED TO ALERT THE USER TO THE PRESENCE OF IMPORTANT OPERATING AND MAINTENANCE (SERVICING) INSTRUCTIONS IN THE LITERATURE ACCOMPANYING THE APPLIANCE.

## IMPORTANT SAFETY INSTRUCTIONS

- 1) Read these instructions.
- 2) Keep these instructions.
- 3) Heed all warnings.
- 4) Follow all instructions.
- 5) Do not use this apparatus near water.
- 6) Clean only with dry cloth.
- 7) Do not block any ventilation openings. Install in accordance with the manufacturer's instructions.
- 8) Do not install near any heat sources such as radiators, heat registers, stoves, or other apparatus (including amplifiers) that produce heat.
- 9) Do not defeat the safety purpose of the polarized or grounding-type plug. A polarized plug has two blades with one wider than the other. A grounding type plug has two blades and a third grounding prong. The wide blade or the third prong are provided for your safety. If the provided plug does not fit into your outlet, consult an electrician for replacement of the obsolete outlet.
- 10) Protect the power cord from being walked on or pinch particularly at plugs, convenience receptacles, and the point where they exit from the apparatus.
- 11) Only use attachments/accessories specified by the manufacturer.
- 12) Unplug this apparatus during lightning storms or when unused for long periods of time.
- 13) Refer all servicing to qualified service personnel. Servicing is required when the apparatus has been damaged in any way, such as power-supply cord or plug is damaged, liquid has been spilled or objects have fallen into the apparatus, the apparatus has been exposed to rain or moisture, does not operate normally, or has been dropped.
- 14) This appliance shall not be exposed to dripping or splashing water and that no object filled with liquid such as vases shall be placed on the apparatus.

## ACCESSORIES

### PLEASE CHECK AND IDENTIFY THE SUPPLIED ACCESSORIES.

- AC ADAPTER ..... X 1
- CAR POWER ADAPTER ..... X 1
- MOUNTING STRAP FOR MONITOR ..... X 1
- CARRYING BAG ..... X 1

## CONTROL REFERENCE GUIDE

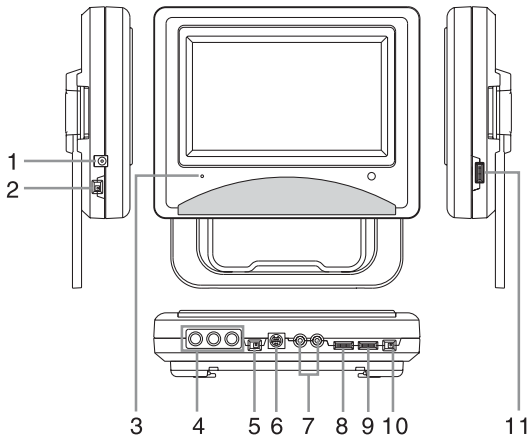

- |  |  |
|--|--|
| <p>1) DC IN 12V jack</p> <p>2) POWER ON/OFF switch</p> <p>3) POWER indicator<br/>When the Power ON/OFF switch to ON position, the light will illuminate.</p> <p>4) AV1 (VIDEO IN / AUDIO IN [L/R]) jacks</p> <p>5) AV1/AV2 switch</p> <p>6) AV2 (EASY VIEW CABLE) socket</p> <p>7) Headphone jacks</p> | <p>8) BRIGHTNESS control<br/>Adjust the relative lightness or darkness of the color.</p> <p>9) COLOR control<br/>Adjust for color intensity.</p> <p>10) SCREEN switch<br/>16:9 Wide-screen<br/>4:3 Pan screen</p> <p>11) VOLUME control<br/>Adjust the volume.</p> |
|--|--|

### INSTALLING THE MONITOR IN CAR

- Use supplied mounting straps installing the monitor onto the seat back in a car.

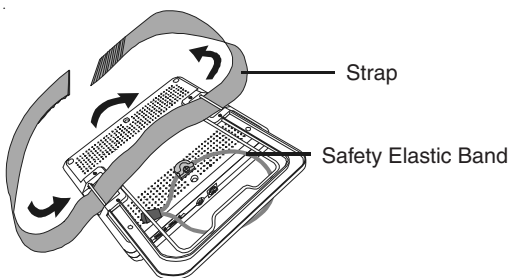

- 1) Loop the safety band around the headrest.

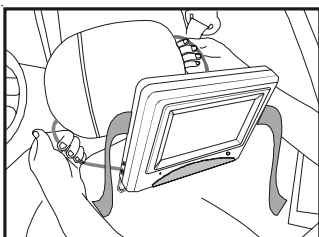

- 2) Tightly wrap the mounting strap around the headrest.

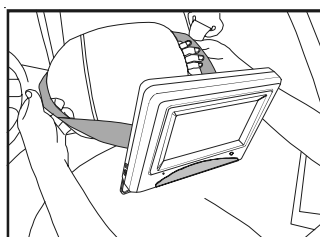

#### SAFETY WARNING!

- This monitor should never be used by the vehicle's driver or left unsecured in the vehicle while driving.
- If this monitor is being used in your vehicle, be sure that it is secured or held safely, and does not obstruct any safety device, including air bags or seat belts.
- All passengers should wear seat belts when using this monitor in a moving vehicle.
- If in doubt, please contact your vehicle manufacturer for further advice.

## POWER SUPPLY

### A. USING THE AC ADAPTER

This AC adapter operates on AC between 100V and 240V.

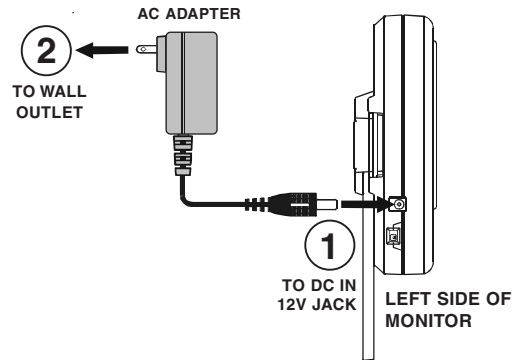

#### Cautions:

- The included AC adapter is for use with this monitor only. Do not use them with other equipment.
- When the monitor is not going to be used for long time, disconnect the AC adapter from the wall outlet.

### B. USING THE CAR POWER ADAPTER

The included car power adapter is designed for use with vehicles that have a 12V, negative ground electrical system.

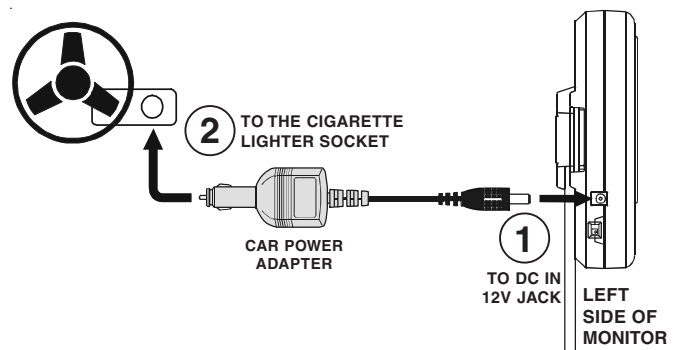

#### Cautions:

- Use this monitor only with the included car power adapter, use with other car power adapter could damage the monitor.
- The included car power adapter is for use with this monitor only. Do not use it with other equipment.
- In the interests of traffic safety, do not operate the monitor or view video software while driving the vehicle.
- Make sure the monitor is secured correctly to prevent it from falling inside the vehicle in the event of an accident.
- When the inside of the cigarette lighter socket is dirty with ashes or dust, the plug section may become hot due to poor contact. Be sure to clean the cigarette lighter socket before use.
- After use, disconnect the car power adapter from both the monitor and cigarette lighter socket.

## CONNECTIONS

### A. CONNECTING THE DVD PLAYER OR VCR

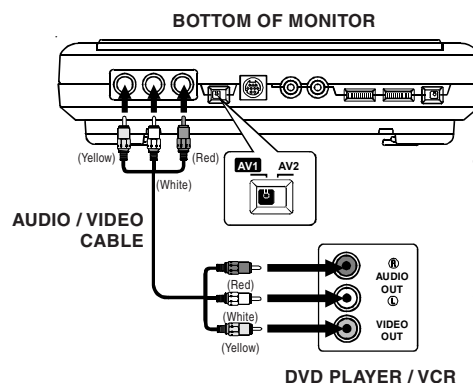

Tear off this label and connect Easy View cable to other products (please see "Connecting this monitor to other products with Easy View cable interface")

#### Watching a DVD player and VCR

- Turn on the monitor (the AV1 / AV2 switch in AV1 position).
- Turn on the DVD player or VCR and follow the instructions provided with it to playback.

**Note:** If you have a mono VCR, the volume level from the speakers will be low.

## Free Manuals Download Website

<http://myh66.com>

<http://usermanuals.us>

<http://www.somanuals.com>

<http://www.4manuals.cc>

<http://www.manual-lib.com>

<http://www.404manual.com>

<http://www.luxmanual.com>

<http://aubethermostatmanual.com>

Golf course search by state

<http://golfingnear.com>

Email search by domain

<http://emailbydomain.com>

Auto manuals search

<http://auto.somanuals.com>

TV manuals search

<http://tv.somanuals.com>