

**VENTURER**

Model: SHD7000

## HD DVD player

---

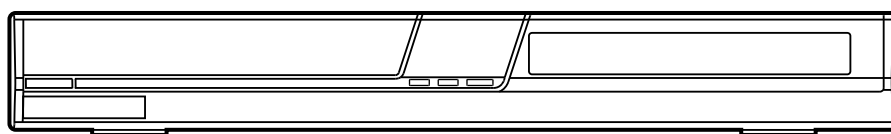

## Owner's Manual

---



# SAFETY PRECAUTIONS

The following marks and symbols are located on back of the unit.



The lightning flash with an arrowhead symbol, within the equilateral triangle, is intended to alert the user to the presence of uninsulated "dangerous voltage" within the product's enclosure that may be of sufficient magnitude to constitute a risk of electric shock to persons.



The exclamation point within the equilateral triangle is intended to alert the user to the presence of important operating and maintenance (servicing) instructions in this owner's manual.

## CAUTION:

To prevent direct exposure to laser beam, do not try to open the enclosure.

Visible and invisible laser radiation when open and interlocks defeated.

**DO NOT STARE INTO BEAM.**

## ▲ WARNING:

- TO REDUCE THE RISK OF FIRE OR ELECTRIC SHOCK, DO NOT REMOVE COVER (OR BACK). NO USER-SERVICEABLE PARTS INSIDE. REFER SERVICING TO QUALIFIED SERVICE PERSONNEL.
- TO PREVENT FIRE OR SHOCK HAZARD, DO NOT EXPOSE THIS APPLIANCE TO RAIN OR MOISTURE.

## CAUTIONS:

- USE OF CONTROLS OR ADJUSTMENTS OR PERFORMANCE OF PROCEDURES OTHER THAN THOSE SPECIFIED MAY RESULT IN HAZARDOUS RADIATION EXPOSURE.
- TO PREVENT ELECTRIC SHOCK, MATCH WIDE BLADE OF PLUG TO WIDE SLOT OF AC POWER OUTLET, THEN FULLY INSERT.

**This product contains a low power laser device.**



The symbol for Class II (Double Insulation)

**Warning:** The apparatus shall not be exposed to dripping or splashing and that no objects filled with liquid, such as vases, shall be placed on the apparatus.

## On Placement

- Do not use the unit in places that are extremely hot, cold, dusty, or humid.
- Do not restrict the airflow of the unit by placing it in a place with poor airflow, by covering it with a cloth, or by placing it on carpeting.

## On Safety

- When connecting or disconnecting the AC cord, grip the plug and not the cord itself. Pulling the cord may damage it and create a hazard.

## On Condensation

- When left in a heated room where it is warm and damp, water droplets or condensation may form inside the unit. When there is condensation inside the unit, the unit may not function normally. Let the unit stand for 1 to 2 hours before turning the power on or gradually heat the room and allow the unit to dry before use.

## Warning:

- Use only the power cord and batteries indicated in this manual. Do not dispose of batteries in a fire. They may explode. Check with local codes for possible special disposal instructions.
- Batteries shall not be exposed to excessive heat such as sunshine, fire or the like.

# SAFETY PRECAUTIONS

## **FCC Information**

This device complies with Part 15 of the FCC rules. Operation is subject to the following two conditions:

- (1) This device may not cause harmful interference, and
- (2) This device must accept any interference received, including interference that may cause undesired operation.

**NOTE:** This equipment has been tested and found to comply with the limits for a Class B digital device, pursuant to part 15 of the FCC Rules. These limits are designed to provide reasonable protection against harmful interference in a residential installation. This equipment generates, uses, and can radiate radio frequency energy and, if not installed and used in accordance with the instructions, may cause harmful interference to radio communications. However, there is no guarantee that interference will not occur in a particular installation. If this equipment does cause harmful interference to radio or television reception, which can be determined by turning the equipment off and on, the user is encouraged to try to correct the interference by one or more of the following measures:

- Reorient or relocate the receiving antenna.
- Increase the separation between the equipment and receiver.
- Connect the equipment into an outlet on a circuit different from that to which the receiver is connected.
- Consult the dealer or an experienced radio/TV technician for help.

This Class B digital apparatus complies with Canadian ICES-003.

Shielded cables must be used with this unit to ensure compliance with the Class FCC limits.



**WARNING:** Changes or modifications to this unit not expressly approved by the party responsible for compliance could void the user authority to operate the equipment.

## **Notes on Copyright**

It is forbidden by law to copy, broadcast, show, broadcast on cable, play in public, or rent copyrighted material without permission.

Apparatus Claims of U.S. Patent Nos. U.S. Patent Nos. 4,907,093; 5,315,448; and 6,516,132 licensed for limited viewing uses only.

This product incorporates copyright protection technology that is protected by U.S. patents and other intellectual property rights. Use of this copyright protection technology must be authorized by Macrovision, and is intended for home and other limited viewing uses only unless otherwise authorized by Macrovision. Reverse engineering or disassembly is prohibited.

Dolby and the double-D symbol are registered trademarks of Dolby Laboratories.

Manufactured under license from DTS, Inc. under one or more of the following U.S. Pat. No's: 5,451,942; 5,956,674; 5,974,380; 5,978,762; 6,226,616; 6,487,535 and other U.S. and world-wide patents issued and pending. "DTS" and "DTS Digital Surround" are registered trademarks of DTS, Inc. Copyright 1996, 2002-2006, DTS, Inc. All Rights Reserved.

HDMI, the HDMI logo and High-Definition Multimedia Interface are trademarks or registered trademarks of HDMI Licensing LLC.

SHARC and Melody are registered trademarks of Analog Devices, Inc.



are trademarks of DVD Format/Logo Licensing Corporation.

# IMPORTANT SAFETY INSTRUCTIONS

1. Read these instructions.
2. Keep these instructions.
3. Heed all warnings.
4. Follow all instructions.
5. Do not use this apparatus near water.
6. Clean only with a dry cloth.
7. Do not block any of the ventilation openings. Install in accordance with the manufacturer's instructions.
8. Do not install near any heat sources such as radiators, heat registers, stoves, or other apparatus (including amplifiers) that produce heat.
9. Do not defeat the safety purpose of the polarized or grounding-type plug. A polarized plug has two blades with one wider than the other. A grounding type plug has two blades and a third grounding prong. The wide blade or the third prong is provided for your safety. If the provided plug does not fit into your outlet, consult an electrician for replacement of the obsolete outlet.
10. Protect the power cord from being walked on or pinched particularly at plugs, convenience receptacles, and the point where they exit from the apparatus.
11. Only use attachments/accessories specified by the manufacturer.
12. Use only with the cart, stand, tripod, bracket, or table specified by the manufacturer, or sold with the apparatus. When a cart is used, use caution when moving the cart/apparatus combination to avoid injury from tip-over.
13. Unplug this apparatus during lightning storms or when unused for long periods of time.
14. Refer all servicing to qualified service personnel. Servicing is required when the apparatus has been damaged in any way, such as the power-supply cord or plug is damaged, liquid has been spilled or objects have fallen into the apparatus, the apparatus has been exposed to rain or moisture, does not operate normally, or has been dropped.



**Portable Cart Warning**

## ADDITIONAL SAFETY INSTRUCTIONS

15. Do not overload wall outlets; extension cords, or integral convenience receptacles as this can result in a risk of fire or electric shock.
16. Never expose the apparatus to dripping or splashing or place items such as vases, aquariums, any other item filled with liquid, or candles on top of the unit.
17. Keep your fingers well clear of the disc tray as it is closing. Neglecting to do so may cause serious personal injury.
18. Do not place anything on top of this unit.
19. Do not place the apparatus on amplifiers or equipment that may produce heat.
20. Never block or cover the slots or openings in the unit.  
Never place the unit:
  - on a bed, sofa, rug or similar surface;
  - too close to drapes, curtains, or walls; or
  - in a confined space such as a bookcase, built-in cabinet, or any other place with poor ventilation.The slots and openings are provided to protect the unit from overheating and to help maintain reliable operation.
21. Do not use a cracked, deformed, or repaired disc. These discs are easily broken and may cause serious personal injury and apparatus malfunction.
22. If the apparatus should emit smoke or an unusual odor, immediately disconnect the power cord from the wall outlet. Wait until the smoke or smell stops, then ask your dealer for a check and repair. Neglecting to do so may cause fire.
23. During thunderstorms, do not touch the connecting cables or the apparatus.

# PRECAUTIONS

## ***Notes on handling***

- Never disconnect the power cord from a wall outlet while the player is turned on, unless it is in an emergency. Doing so may cause malfunction.
- When shipping the player, the original shipping carton and packing materials come in handy. For maximum protection, repack the unit as it was originally packed at the factory.
- Do not use volatile liquids, such as insect spray, near the player. Do not leave rubber or plastic products in contact with the player for a long time. They will leave marks on the finish.
- The top and rear panels of the player may become warm after a long period of use. This is not a malfunction.

## ***When not in use***

- For usual absence  
Be sure to remove the disc from the player and turn off the power.
- Prolonged absence  
Unplug the player from a wall outlet. (This will stop the clock. Display "SETUP MENU" by pressing SETUP, and reset the clock.)

## ***Notes on locating***

- Place the player on a level surface. Do not use it on a shaky or unstable surface such as a wobbly table or inclined stand. The loaded disc may dislodge from its proper position and cause damage to the player. Before placing the player, make sure that the surface can stand the weight of the player. Never place the player in a high location to avoid damage to the product or person by an accidental fall of the player.
- When you place this player near a TV, radio, or VCR, the playback picture may become poor and the sound may be distorted depending on the condition and location of said equipment. In such an event, place the player as far away as practical from the TV, radio, or VCR.
- To avoid damage to this product, never place or store the unit in direct sunlight; hot, humid areas; or areas subject to excessive dust, oily smoke, cigarette smoke or vibration.

## ***About the volume level***

The volume level of some commercial HD DVD and DVD discs may seem lower than that of audio CDs, other software, etc. If you turn up the volume of the TV or amplifier to play such discs, be sure to turn it back down after playback finishes.

## ***About software***

Because of problems and errors that can occur during the creation of HD DVD, DVD and CD software and/or the manufacture of HD DVD, DVD and CD discs, Manufacturer cannot assure that this player will successfully play every disc bearing the HD DVD, DVD or CD logos. If you happen to experience any difficulty playing an HD DVD, DVD or CD disc on this player, please contact Customer Service.

## ***Some differences***

The HD DVD player operates more like a computer and differently than a standard DVD player. In addition to containing a microprocessor, it contains an operating system, random access memory (RAM), and an HD DVD drive. The operating system includes software that is transferred to the RAM when the machine is turned on and at other times during operation. This transfer can take time. Therefore, when you turn the HD DVD player on, it may take a little while before it is ready to use. Likewise, other functions may not be performed as quickly as they would on other AV equipment. Please take these factors into consideration as you use the HD DVD player.

# TABLE OF CONTENTS

<b>Safety Precautions</b> .....	1-2	<b>Customizing the Function Settings</b> .....	22-34
<b>Important Safety Instructions</b> .....	3	Picture .....	22-24
<b>Precautions</b> .....	4	Audio .....	24-26
<b>Table of Contents</b> .....	5	Language .....	27-28
<b>Features</b> .....	6-7	Ethernet .....	28-30
<b>Accessories</b> .....	8	General .....	31-34
<b>Remote Control</b> .....	8	<b>Troubleshooting Guide</b> .....	35
<b>Control Reference Guide</b> .....	9-11	<b>License Information on the Software Used in this HD DVD Player</b> .....	36-45
<b>Display</b> .....	12	<b>Maintenance</b> .....	46
<b>Setup</b> .....	13-16	<b>Specifications</b> .....	46
Check the Type of Video Input on Your TV ...	13		
Connecting to a TV .....	13		
Connecting to an Audio System .....	15		
LAN Connection .....	15		
Plugging in the Unit .....	16		
Turning on the Unit and TV .....	16		
<b>Playing a Disc</b> .....	17-19		
Playing a Disc .....	17		
Pausing Playback .....	17		
Playing Frame by Frame .....	17		
Stopping Playback .....	17		
Skipping to a Different Chapter/Track .....	17		
Fast Forward/Fast Reverse .....	17		
Resume Playback .....	17		
Slow-motion Play .....	18		
Angle Selection .....	18		
Subtitle Selection .....	18		
Audio Selection .....	18		
Repeat Playback .....	19		
<b>Special Functions</b> .....	20-21		
Display Function .....	20		
Locating a Specific Title .....	20		
Locating a Specific Chapter/Track .....	20		
Locating a Specific Time .....	21		
<b>HD DVD Playing Options in the Future</b> .....	21		

# FEATURES

## Disc Formats

The unit can play:

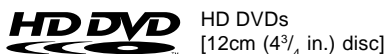

DVD VR mode recording  
(CPRM compatible discs supported.)  
DVD Video mode recording  
Finalized discs only.

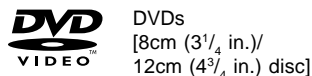

Audio CDs  
[8cm (3 1/4 in.) / 12cm (4 3/4 in.) disc]

**CD-R CD-RW** Compatible

## Region Management Information

Region Management Information: This unit is designed and manufactured to respond to the Region Management Information that is encoded on DVDs. If the region number printed on the DVD does not correspond to the region number of this unit, this unit cannot play that disc.



The region number of this unit is 1.

## Disc Function or Operation that is Not Available

When the "Ⓢ" symbol appears on the screen, it indicates that the function or operation attempted is not available at that time. This occurs because the DVD manufacturer determines the specific functions. Certain functions may not be available on some discs. Be sure to read the documentation provided with the DVD.

## Icons Used on DVDs

Sample Icons

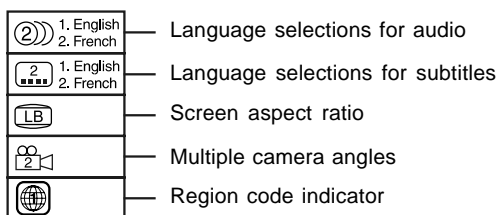

## Note:

- When playing a CD-G (Graphics) or CD EXTRA disc, the audio portion will be played, but the graphic images will not be shown.

## Titles, Chapters and Tracks

- DVDs are divided into "titles" and "chapters". If the disc has more than one movie on it, each movie would be a separate "title". "Chapters" are sections of titles.
- Audio CDs are divided into "tracks". A "track" is usually one song on an Audio CD.

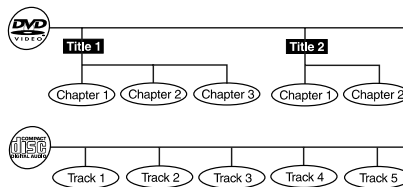

Note : Numbers identify each title, chapter, and track on a disc. Most discs have these numbers recorded on them, but some do not.

### Notes on Unauthorized Discs

You may not be able to play back some DVDs on this unit if they were purchased from outside your geographic area or made for business purposes.

# FEATURES

## ***Important notes about HD DVD***

HD DVD with high-definition content required for HD viewing. Viewing high-definition content and up-converting DVD content may require an HDCP capable DVI or HDMI input on your display device. Up-conversion of DVD content will result in near HD picture quality. Firmware update may be required for some interactive features depending on content, which may also require an always-on broadband internet connection. Some features may require additional bandwidth. Some recordable media may not be supported. Dolby Digital Plus, Dolby TrueHD and DTS support for up to 5.1 channels (DTS HD support for DTS core only) MP3/WMA audio files not supported. HDMI audio support for PCM only. Because HD DVD is a new format that makes use of new technologies, certain disc, digital connection and other compatibility and/or performance issues are possible. This may, in rare cases, include disc freezing while accessing certain disc features or functions, or certain parts of the disc not playing back or operating as fully intended. Some features subject to delayed availability. While every effort has been made at the time of publication to ensure the accuracy of the information provided herein, product specifications, configurations, system/component/options availability are all subject to change without notice.

Note: The firmware in this player can be updated. See page 34 for details.

## ***Notes on web-enabled network content***

Certain HD DVD discs may contain or have the capability of downloading studio-provided, web-enabled network content. To minimize any potential compatibility and/or connectivity issues, before viewing such content, it is recommended that you perform the firmware update process to ensure that your HD DVD player is using the latest firmware version. Do not unplug or turn off the player when downloading studio-provided, web-enabled network content. Doing so may cause data stored in the player's persistent storage to be lost.

## ***HD output jacks***

- An HDMI jack for connecting a single cable to output video and audio signals
- Component jacks

## ***Certain system requirements***

For high definition video playback:

- HD display (some discs may require HDCP capable input)
- HD DVD disc with HD content

For Dolby® Digital Plus and Dolby TrueHD multi-channel audio playback:

- A/V Receiver with HDMI™ multi-channel LPCM capable audio input and 5.1 channel speaker setup.

Before accessing, try updating this player's firmware. For details on how to update, see "Update (Firmware update)" on page 34.

This HD DVD player is manufactured under the HD DVD Format adopted by the DVD Forum. The DVD Forum approved AACPS (Advance Access Content System) as content protection system for HD DVD format like it approved CSS (Content Scramble System) for DVD format. Therefore, certain restrictions are imposed on play, analog signal output, etc. of AACPS protected contents. When you use pre-recorded contents, the contents may designate whether or not to apply such restrictions. As those restrictions may be adopted and/or changed and announced by AACPS after the production of this product, the operation of this product and restrictions thereon may vary depending on the time you purchase this product as well as during the life of this product.



# ACCESSORIES

**Please check and identify the included accessories.**

- Remote Control ..... x 1
- AAA 1.5V Battery (for remote control) ..... x 2
- AC Power Cord ..... x 1

## REMOTE CONTROL

### **Using the Remote Control**

- Point the remote control at the REMOTE SENSOR located on the unit.
- When there is a strong ambient light source, the performance of the infrared REMOTE SENSOR may be degraded, causing unreliable operation.
- The recommended effective distance for remote operation is about 16 feet (5 meters).

### **To Install Batteries**

1. Open the battery door.
2. Insert two AAA batteries.

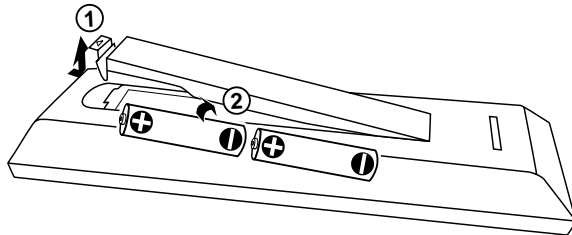

### **Battery Replacement**

When the batteries become weak, the operating distance of the remote control is greatly reduced and you will need to replace them.

**CAUTION:** Danger of explosion if battery is incorrectly replaced. Replace only with the same or equivalent type.

#### **Notes:**

- If the remote control is not going to be used for a long time, remove the batteries to avoid corrosion damage caused by battery leakage.
- Do not mix old and new batteries. Do not mix ALKALINE, standard (CARBON-ZINC) or rechargeable (NICKEL-CADMIUM) batteries.
- Always remove batteries as soon as they become weak.
- Weak batteries can leak and severely damage the remote control.
- **WARNING:** Do not dispose of batteries in a fire. Batteries may explode or leak.

# CONTROL REFERENCE GUIDE

## Remote Control

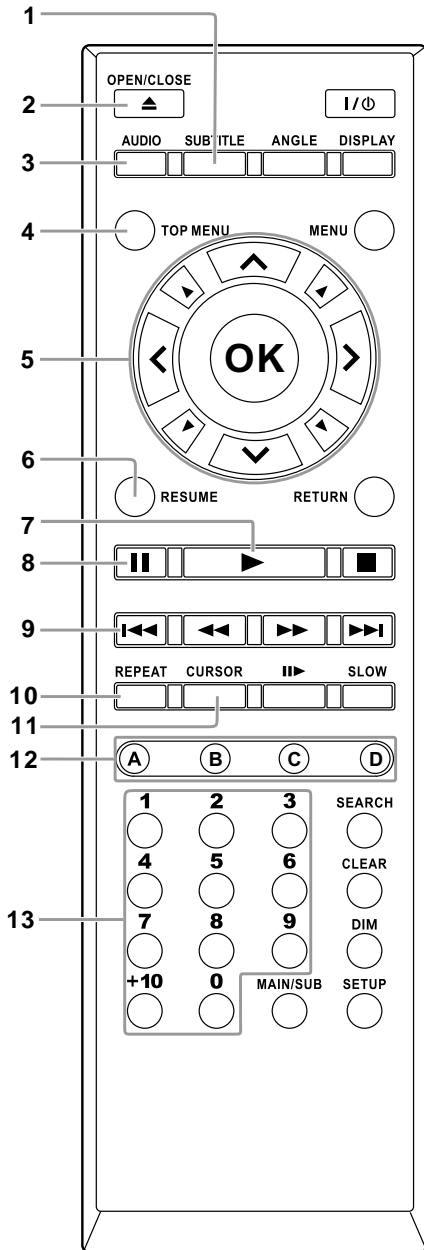

- 1) SUBTITLE Button**  
Press to select one of the subtitle languages programmed on a DVD.
- 2) ▲ OPEN/CLOSE Button**  
Press to open or close the disc tray.
- 3) AUDIO Button**  
Press to select one of the audio sound tracks programmed on a DVD or to select the audio output mode on an AUDIO CD.
- 4) TOP MENU Button**  
Press to open the Title Menu screen in stop mode.
- 5) Direction Buttons**  
Press to select a content or position to enter.
- 6) RESUME Button**  
Press to resume playback while playing an HD DVD.
- 7) ► PLAY Button**  
Press to start playback.
- 8) || PAUSE Button**  
Press to pause playback.
- 9) ◀◀ PREV Button**  
Press to move backwards through titles, chapters or tracks on a disc.
- 10) REPEAT Button**  
Press to display the repeat mode menu.
- 11) CURSOR Button**  
Press to set the 8 direction buttons to move the cursor during HD DVD playback.
- 12) A, B, C, D Buttons**  
Press to operate as indicated by the video display during HD DVD playback.
- 13) Number (0-10+) Buttons**  
Press to enter numbers.

# CONTROL REFERENCE GUIDE

## Remote Control

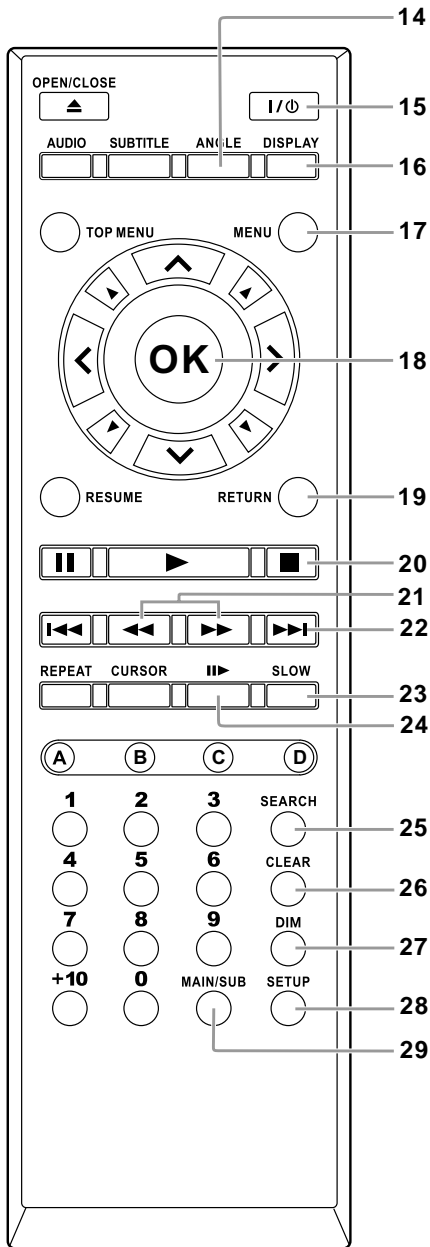

### 14) ANGLE Button

Press to switch the camera angle of the video presentation when scenes with multiple camera angles are recorded on a DVD.

### 15) I/⏻ STANDBY/ON Button

Press to turn on the unit and put it in standby mode.

### 16) DISPLAY Button

Press to change disc status information displayed on the TV screen.

### 17) MENU Button

Press to open and close the DVD menu.

### 18) OK Button

Press to confirm selections on a menu screen.

### 19) RETURN Button

Press to return to previous menu.

### 20) ■ STOP Button

Press to stop playback.

### 21) ⏮ / ⏭ Buttons

⏮ : Fast reverse playback.

⏭ : Fast forward playback.

### 22) ⏭ NEXT Button

Press to move forward through titles, chapters or tracks on a disc.

### 23) SLOW Button

Press to perform slow forward playback of DVDs.

### 24) ▶ Button

Press to play frame by frame.

### 25) SEARCH Button

Press to display a window to locate a title, chapter or track.

### 26) CLEAR Button

Press to clear entered information.

### 27) DIM Button

Press to change the brightness of the display on the player.

### 28) SETUP Button

Press to display the setup menu.

### 29) MAIN/SUB Button

For future functions which may become available by software update.

# CONTROL REFERENCE GUIDE

## Unit

### (Front View)

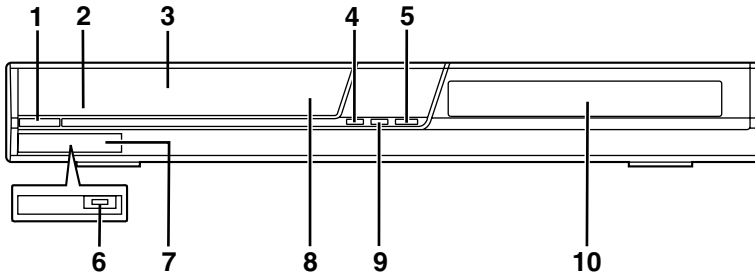

- 1) **I/O STANDBY/ON Button**  
Turns on the unit and puts it in standby mode.
- 2) **STANDBY/ON Indicator**  
Indicates whether the unit is ON or in STANDBY mode.  
Indicator RED: The unit is on standby.  
Indicator OFF: The unit is turned on.
- 3) **Front Panel Display**
- 4) **■ STOP Button**  
Stops playing a disc.
- 5) **▲ OPEN/CLOSE Button**  
Opens/closes the disc tray.
- 6) **Extension Port**  
For future functions.
- 7) **The door of the Extension Port**
- 8) **Remote Sensor**  
Receives the remote control unit signals.
- 9) **▶ PLAY Button**  
Starts or resumes playback of a disc.
- 10) **Disc Tray**  
Loads a disc into the disc drive.

## Unit

### (Rear View)

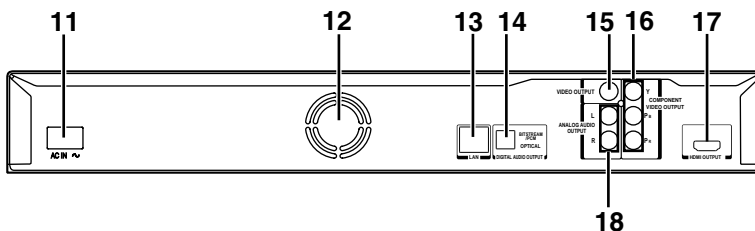

- 11) **AC IN Socket**  
Connect the supplied power cord.
- 12) **Ventilation Fan**
- 13) **LAN port**  
Use this to connect to a network with an always-on broadband connection.
- 14) **DIGITAL AUDIO OUTPUT BITSTREAM/PCM OPTICAL Jack**  
Outputs digital audio signals. Connect to a digital audio input on an amplifier equipped with digital audio decoder. When connecting the optional digital cable, fit the connector into the jack firmly.
- 15) **VIDEO OUTPUT Jack**  
Outputs video signals to a connected TV or amplifier.
- 16) **COMPONENT VIDEO OUTPUT Jacks**  
Outputs video signals to a connected TV or monitor.
- 17) **HDMI OUTPUT Jack**  
Outputs video/audio signals to connected TV, monitor or AV amplifier.
- 18) **ANALOG AUDIO OUTPUT Jacks**  
Outputs audio signals to a connected TV or AV amplifier.

# DISPLAY

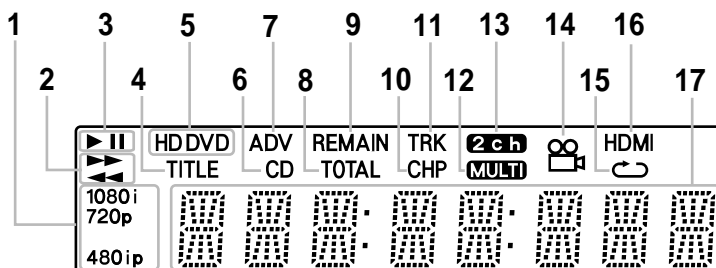

- |  |  |
|--|--|
| <p>1) Displays the video output format currently selected. (i: interlaced, p: progressive)</p> <p>2) ▶▶ : Fast forward playback.<br/>◀◀ : Fast reverse playback.</p> <p>3) ▶ : Playing<br/>II : Pausing</p> <p>4) Shows a title number.</p> <p>5) HD DVD: An HD DVD is loaded.<br/>DVD: A DVD is loaded.</p> <p>6) A CD is loaded.</p> <p>7) A disc that contains advanced content is loaded.</p> <p>8) Total playing time is displayed.</p> | <p>9) Remaining playing time is displayed.</p> <p>10) Shows a chapter number.</p> <p>11) Shows a track number.</p> <p>12) Multi channel sound is output.</p> <p>13) 2ch sound is output.</p> <p>14) Playing a scene recorded with multiple angles.</p> <p>15) Playing in repeat mode.</p> <p>16) HDMI connection is verified between the player and another device.</p> <p>17) Displays the total playing time of the disc, elapsed time, remaining time, title, chapter or track number, messages, etc.</p> |
|--|--|

## Dimming the display

Pressing the **DIM** button on the remote control changes the brightness of the display (Normal / Dimmed / Off).

- Turning off the power resets this setting.

# SETUP

## Check the Type of Video Input on Your TV

To view high definition content, use the HDMI OUTPUT jack or the COMPONENT VIDEO OUTPUT jacks to connect to a TV. Some discs may require use of the HDMI OUTPUT jack.

TV input	Connection to this player		Resolution from this player			
			HD (High Definition)		SD (Standard Definition)	
	Signal	Cable	1080i	720p	480p	480i
HDMI input (* Most recommended)	Video	HDMI cable	Yes	Yes	Yes	Yes
	Audio					
Component Video input	Video	Component Video cable	Yes*	Yes*	Yes*	Yes*
	Audio	Audio cable				
VIDEO input (Yellow)	Video	Composite Video cable	No	No	No	Yes
	Audio	Audio cable				

\* Some disc may prohibit output in this format. In this case, use the HDMI connection.

### \* Why HDMI connection is most recommended?

HD DVD and DVD video disc creators have the option to include copy protection instructions in their discs that prohibit the output of some standard video or high definition video (original 720p, 1080i or up-converted 480i or 480p) from the COMPONENT VIDEO OUTPUT jacks. If such instructions are present in the disc you are playing, you must use the HDMI OUTPUT jack to view the disc in a high definition format and the COMPONENT VIDEO OUTPUT jacks, if activated, will output video only in 480i or 480p resolution.

## Connecting to a TV

- **Connect the player directly to your TV. If you connect the player to a VCR, TV/VCR combination, video selector or AV amplifier, the playback picture may be distorted due to copy protection.**
- **Be sure to turn off the power and unplug both units from the wall outlet before making any connections.**

### Via HDMI Input

HDMI stands for High Definition Multimedia Interface. HDMI transfers digital audio and uncompressed digital video on a single cable. As a result, audio cables and video cables don't need to be connected separately to a device.

#### Notes:

- Refer to the owner's manual to the connected TV as well.
- When the HDMI connection is not verified, an error message appears on the front panel display. In this case, disconnect the HDMI cable then connect it again, or turn off the connected HDMI device then turn it on.

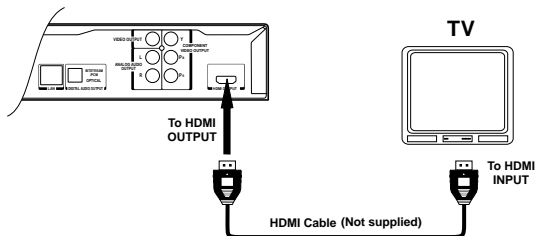

# SETUP

- HDMI output is digital only. DVI analog is not supported.
- HDMI is an evolving technology, so some devices may not operate properly with this player.
- To get the most possible benefit from Dolby Digital Plus, you should connect your HD DVD player to your AV receiver using its HDMI input. If your AV receiver has this type of input, make sure it is connected to your HD DVD player and that the input is set to use audio from HDMI (and not the SPDIF coaxial or optical input). If your AV receiver does not have an HDMI input, then the next best choice is to use the SPDIF (coaxial or optical) input on your AV receiver.
- If you use the SPDIF optical output or analog outputs to connect your audio system and have the "Digital Out HDMI" set to "Auto" or "PCM", the audio output level from these jacks will be reduced when listening to a multi-channel disc. To restore the audio output level, set "Digital Out HDMI" to "Downmixed PCM".

## Via Component Video Input

Some discs may be down converted or require HDMI connection.

Using a component video cable (not supplied), connect the Y VIDEO OUT jack (green plug) on your unit to the Y VIDEO IN jack on your TV, the P<sub>B</sub> VIDEO OUT jack (blue plug) on your unit to the P<sub>B</sub> VIDEO IN jack on your TV and the P<sub>R</sub> VIDEO OUT jack (red plug) on your unit to the P<sub>R</sub> VIDEO IN jack on your TV.

To use the analog sound output, connect these ANALOG AUDIO OUTPUT jacks to audio input jacks on your TV using the audio cable.

- \* To use the optical digital output, use an optical cable to connect this jack to an optical audio input on a device capable of processing a DTS bitstream or PCM audio (see "Connecting to an Audio System").

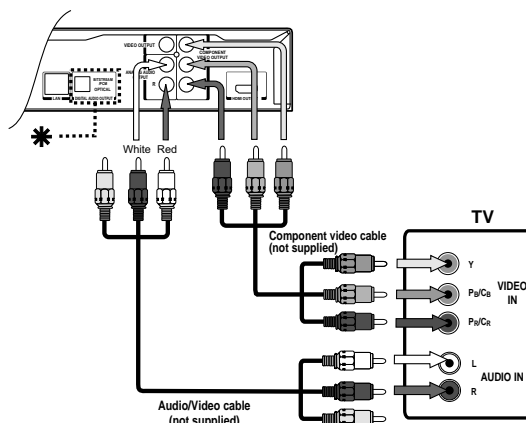

## RCA Audio/Video Cable

Use the Audio/Video cable (not supplied). Connect the VIDEO OUT and left/right AUDIO OUT jacks on the unit to the VIDEO IN and left/right AUDIO IN jacks on your TV.

480i output only regardless of the resolution settings or the connections of other output jack.

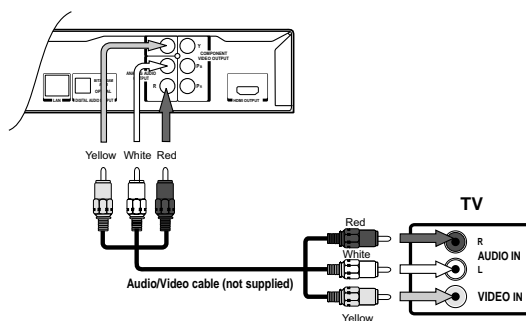

# SETUP

## Note:

This player supports simultaneous output of video on its HDMI and component video ports. However, some discs may restrict output of video on the component video ports when viewing high definition content or up-converted DVD content. The resolution on the HDMI output will be the same as the resolution output on the component video output. Thus, because the HDMI output can change automatically to match the maximum available resolution of your display, if you connect both the HDMI output and component output, the resolution on the component output will change if the HDMI output auto-adjusts.

## Connecting to an Audio System

### Via Optical Digital Output

You can listen to down-converted Dolby Digital Plus and Dolby TrueHD as well as Dolby Digital and DTS using a receiver with Dolby Digital and DTS decoding capabilities and an optical digital input.

To use the optical digital output, use an optical cable to connect this jack to an optical audio digital input on a device capable of processing a DTS bitstream or PCM audio.

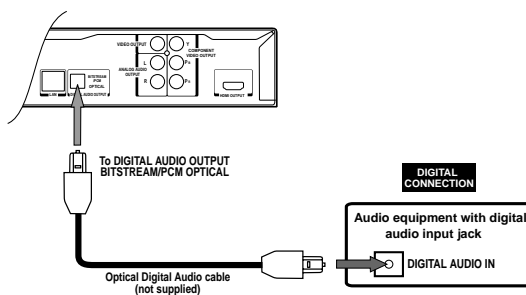

### Via Analog Audio Output

To use the analog sound output, connect the ANALOG AUDIO OUTPUT jacks to audio input jacks on your TV using the audio cable. Sound output is in 2ch format only.

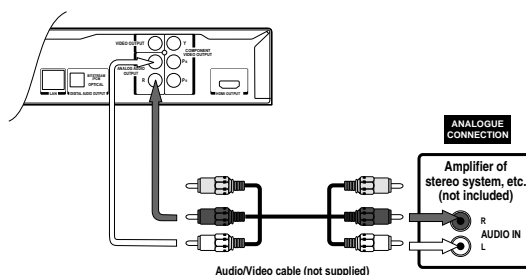

## LAN Connection

You may use the internet connection feature to update the player's firmware.

Some HD DVD discs may enable you to access special HD DVD sites, if you connect the player to the Internet via an always-on broadband connection. For example, if an HD DVD site includes content such as links to future movie trailers, you can watch the content on the player via the Internet. You do not need to connect to a PC to use this function.

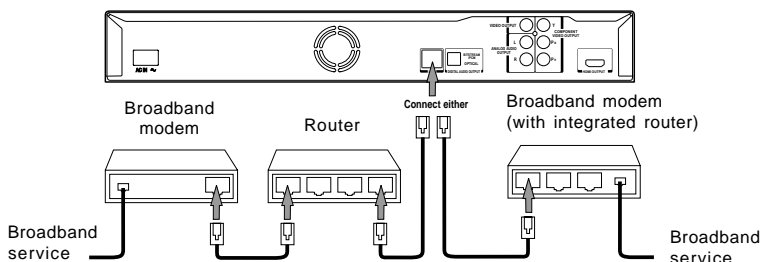

Use a commercially available straight LAN cable (Category 5/CAT 5 or better with RJ45 connector).



# SETUP

## **Caution**

- When plugging or unplugging the LAN cable, hold the plug portion of the cable.
- When unplugging the LAN cable, do not pull on it. Unplug the cord while pressing down on the lock.
- Do not connect a modular phone cable to the LAN port.
- Since there are various connection configurations, please follow the specifications of your telecommunication carrier or internet service provider.

## **Note:**

- Depending on the internet service provider (ISP), the number of devices that can receive internet service may be limited by the applicable terms of service. For details, contact your ISP.

## ***Plugging in the Unit***

After completing all connections, connect the supplied power cord to the AC IN socket then plug the AC power cord into the wall outlet.

While the AC power cord is connected, the unit is on standby and the STANDBY/ON indicator on the unit illuminates in red.



- Before plugging in the power cord, make sure the voltage of the unit matches your local voltage.
- Ensure all the components are connected correctly.
- When you are not going to use the unit for a long period of time, disconnect the power cord.

## ***Turning on the Unit and TV***





1. Press the **⏻ STANDBY/ON** button to turn on the unit. The STANDBY/ON indicator will turn off.
  2. Turn on the TV by pressing its POWER button.
  3. Select the channel on your TV corresponding to the VIDEO IN jack that the unit is connected to. See TV User Guide for more information.
- If you have connected the unit successfully, the DVD logo (start-up picture) will appear on your TV screen.

# PLAYING A DISC

This owner's manual explains the basic instructions of this unit. Some DVDs are produced in a manner that allows specific or limited operation during playback. Such as, the unit may not respond to all operating commands. This is not a defect in the unit. Refer to the instruction notes of discs.



"" may appear on the screen during operation. A "" means that the desired operation is not permitted by the unit or disc.

## Playing a Disc

1. Press the  **STANDBY/ON** button to turn on the unit.  
See **CUSTOMIZING THE FUNCTION SETTINGS** (page 22 to 34) before proceeding to step 2.
2. Press the  **OPEN/CLOSE** button. The disc tray opens.
3. Place a disc onto the disc tray with the label side facing up.
4. Press the  **OPEN/CLOSE** button. The disc tray closes.  
It takes a short while for your unit to load the disc. After loading, the unit will automatically bring you to the main menu of the DVD or start playback of the disc.
5. If the unit does not automatically start playing the DVD, press the  **PLAY** button.

Note: If a disc is already loaded into the DVD player, playback will begin from the location where you last stopped.

## Pausing Playback (Still Mode)



Press the  **PAUSE** button on the remote. To resume normal playback, press the  **PLAY** button.



## Playing Frame by Frame

Press the  **PAUSE** button to pause playback.



Press the  button repeatedly. Each time you press the  button, the picture advances one frame.

## Stopping Playback





Press the  **STOP** button at the location where you want to interrupt playback. To resume playback at the position where the disc was stopped, press the  **PLAY** button.

If you press the  **STOP** button twice, the unit's memory will be cleared and pressing the  **PLAY** button will reset the disc to the beginning.

## Skipping to a Different Chapter/Track

- Press the  button repeatedly to skip to the start of the current or previous chapter or track.
- Press the  button to skip to the next chapter or track.
- For an audio CD, use the number buttons (remote control only) to go directly to a track number.

## Fast Forward/Fast Reverse

1. Press the  /  button on the remote control when a disc is playing.
  - Four speeds are available. Each time the  /  button is pressed, the speed of fast scan changes in the following sequence:



2. Press the  **PLAY** button when you have reached the desired point to resume playback at normal speed.

## Notes:

- The DVD player mutes sound during reverse and forward scan of the disc.
- The fast playback speed may differ depending on the disc.

## Resume Playback

To resume playback from the location last stopped.

After stopping playback, press the **RESUME PLAY** button or the  **PLAY** button. If you want to return to the beginning, press the  **STOP** button, then press the  **PLAY** button.

- Resume feature can not function when:
  - You select a disc menu language or change the parental lock setting.
  - You open the disc tray.
- There may be a difference in the location where playback resumes depending on the disc.
- Some discs or scenes may not permit this operation.
- When the ADV indicator on the front panel illuminates, this feature is not available.

# PLAYING A DISC

## Slow-motion Play

1. Press the **SLOW** button on the remote in play mode.

- Three speeds are available. Each time the **SLOW** button is pressed, the speed of slow-motion playback changes in the following sequence:

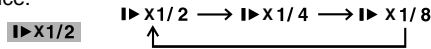

2. Press the **▶** PLAY button to return to normal playback speed.

## Angle Selection

Some DVDs contain scenes that have been shot from a number of different angles. For these discs, the same scene can be viewed from each of these different angles.

1. While you are playing a DVD with different angles recorded, press the **ANGLE** button to view the number of current angles available.
2. Press the **ANGLE** button repeatedly to change the scene to the next angle in those recorded.

- About two seconds later, playback continues from the new angle selected.
- If no button is pressed within 10 seconds, playback continues without changing the current angle.

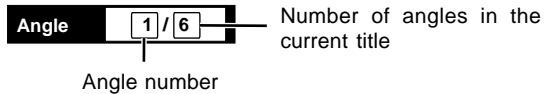

### Notes:

- This function can only be used for discs on which scenes shot from multiple angles have been recorded.
- If only one angle is recorded, " 1/1 " is displayed.

## Subtitle Selection

1. While a DVD is playing, press the **SUBTITLE** button to display the current language setting, as shown in the example below.

2. Press the **SUBTITLE** button repeatedly to select the desired subtitle language.

3. Press the **◀ / ▶** button to select **On** or **Off**.

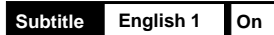

### Notes:

- If only one language is recorded, the language does not change.
- About two seconds later, playback continues with the new subtitle selected.
- The number of languages recorded differs depending on the disc.
- If no button is pressed within a few seconds, playback continues without changing the current subtitle.
- This function can only be used for discs on which subtitles have been recorded in multiple languages.
- On some DVDs, subtitles are activated from the main menu of the DVD. Press the **MENU** button to activate the main menu.

## Audio Selection

On some discs, the sound is recorded in two or more formats. Follow the directions below to select the type of playback.

1. While a disc is playing, press the **AUDIO** button to show the current audio format number.

2. Press the **AUDIO** button repeatedly to select the desired audio format.



### Notes:

- If only one audio format is recorded, the number does not change.
- Some DVDs allow you to change audio selections via the disc menu only. If this is the case, press the **MENU** button and choose the appropriate language on the disc menu.

# PLAYING A DISC

## Repeat Playback

1. Press the **REPEAT** button on the remote control.  
The repeat modes are listed.

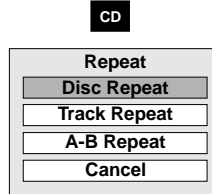
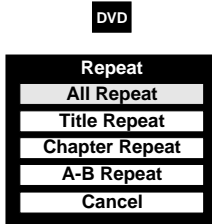

**Note:** The selections on the list vary depending on category or status of a disc.

2. Use the **▲** / **▼** buttons on the remote control to select the repeat mode.

**All Repeat:** Repeats the entire disc.

**Title Repeat:** Repeats the current title.

**Chapter Repeat:** Repeats the current chapter.

**Track Repeat:** Repeats the current track.

**Disc Repeat:** Repeats the entire disc.

**A-B Repeat:** Repeats the specified segment.

You can specify a segment to repeat. Select this and press the **OK** button on the remote control.

" **A B Repeat A Point** " appears.

Perform step 1) and 2) below and skip step 3.

- 1) While the above display appears, press the **OK** button on the remote control at the start point of the section you want to repeat.

The display changes to " **A B Repeat B Point** ".

- To cancel the setting, press the **REPEAT** button.

- 2) Press the **OK** button on the remote control at an end point of the section where you want to repeat.  
Playback returns to point A and repeats between A and B.

3. Press the **OK** button on the remote control.  
Repeat playback starts.

Notes:

- Some discs may not permit repeat playback operation.
- A-B repeat can only be used within the same title. If the start and end of the section to be repeated are in different titles, A-B repeat is cancelled.
- The A-B repeat function does not operate in scenes where different camera angles are recorded.
- You can cancel repeat playback by pressing the **■ STOP** button.

# SPECIAL FUNCTIONS

## Display Function

While the disc is playing, press the **DISPLAY** button on the remote control to display information on operation status. After confirming, press the **DISPLAY** button to turn off the display.

**DVD**

e.g.

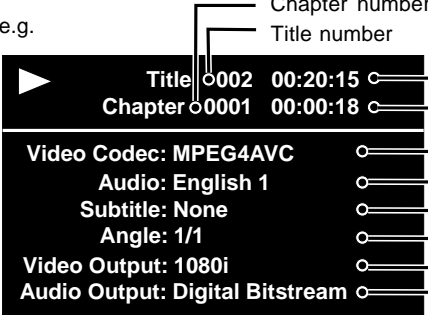

Labels for DVD display menu:

- Chapter number
- Title number
- Elapsed time of a title
- Elapsed time of a chapter
- Video codec
- Language setting
- Subtitle setting
- Angle number
- Definition
- Sound output setting

**CD**

e.g.

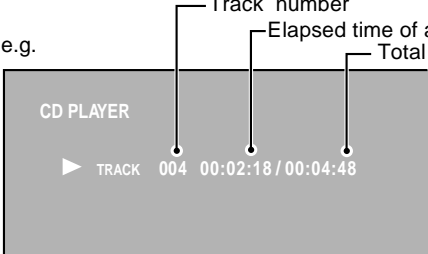

Labels for CD player display:

- Track number
- Elapsed time of a track
- Total time of a track

## Locating a Specific Title

- If a DVD contains title numbers, you can locate a specific title by directly selecting a title number.
- Press the **SEARCH** button on the remote control.
  - Use the ◀ or ▶ button to select title then press the corresponding number button(s) for the title you want.
  - Press the **ENTER** button to confirm. The Unit will start playback about 3 seconds later.

Search Title 1 Chapter ---- Time --:--:--

## Locating a Specific Chapter/Track

- If you know the chapter / track number you want to play, you can locate a specific chapter / track by directly selecting a chapter / track number.
- Press the **SEARCH** button on the remote control.
  - Use the ◀ or ▶ button to select chapter/track then press the corresponding number button(s) for the chapter/track you want.
  - Press the **ENTER** button to confirm. The Unit will start playback about 3 seconds later.

Search Title 1 Chapter ---- Time --:--:--

Search Track 002 Time --:--:--

# SPECIAL FUNCTIONS

## Locating a Specific Time

- You can move to a specific location by entering its corresponding time (hours, minutes, seconds).
1. Press the **SEARCH** button on the remote control.
  2. Use the ◀ or ▶ button to select chapter/track then press the corresponding number button(s) for the setting point you want.
  3. Press the **ENTER** button to confirm. The Unit will start playback about 3 seconds later.

Search Title 1 Chapter ---- Time -- : -- : --

### Notes :

- Pressing the **CLEAR** button on the remote control resets the numbers.
- Some discs may not respond to this process.
- Some scenes may not be located as precisely as you specified.

## HD DVD PLAYING OPTIONS IN THE FUTURE

### A/B/C/D Buttons (on the remote control)

Use these buttons as indicated by the video display during HD DVD playback. Depending on the disc contents, the functions of each button may differ.

### Cursor Controls (on the remote control)

Future HD DVDs may include game software and drawing software. If they do you can use the cursor function for some software.

1. Press the **CURSOR** button while a disc with support for cursor use is playing.
2. Use the eight direction buttons to move the cursor.  
Move the cursor to select the game target or selection item. For details on actual operations, also refer to the operations guide for the disc.

### Controller Port

The extension port may be used in the future for additional control options.

### Requirements for HD DVDs/Web-enabled network content

- An always-on broadband internet connection.
- An HD DVD containing or having the capability of downloading studio provided, web-enabled network content.

### Notes :

- To minimize any potential compatibility and/or connectivity issues, before attempting to view any studio provided, web-enabled network content, it is recommended that you perform the firmware update process to ensure that your HD DVD player is using the latest firmware version.
- If you wish to use a wireless network to connect the player, you will need to use a wireless LAN ethernet adapter to connect the player to the network.
- Some internet contents may require a higher bandwidth connection.
- Even if the player is properly connected and configured, some internet content may not operate properly because of internet congestion, the quality or bandwidth of your internet service, problems at the provider of the content or compatibility issues.
- Some internet connection operations may not be possible due to certain restrictions set by the Internet service provider (ISP) supplying your broadband Internet connection.
- A 10 Base-T or 100 Base-TX LAN port is required for connection to this player. If your internet service does not allow for such a connection, you will not be able to connect the player.
- A DSL modem is required to use DSL service and a cable modem is required to use cable modem service. Depending on the access method of and subscriber agreement with your ISP, you may not be able to use the internet connection feature contained in this player or you may be limited to the number of devices you can connect at the same time. (If your ISP limits subscription to one device, this player may not be allowed to connect when a PC is already connected.)
- The use of a "Router" may not be allowed or its usage may be limited depending on the policies and restrictions of your ISP. For details, contact your ISP directly.

# CUSTOMIZING THE FUNCTION SETTINGS

You can change the default settings to customize performance to your preference.

## Picture

### TV Shape

1. In STOP mode, press the **SETUP** button on the remote control.
2. Use the **▲** or **▼** button to select **Picture**, then press the **OK** button.
3. Use the **▲** or **▼** button to select **TV Shape**, then press the **OK** button.
4. Use the **▲** or **▼** button to select option (16:9, 4:3 or 4:3 Letter Box), then press the **OK** button.
5. Press the **SETUP** button to exit menu.

**16:9:** Select when a 16:9 wide TV is connected.

**4:3:** Select when a standard 4:3 TV is connected.

Displays pictures cropped to fill your TV screen. Both of the picture's sides are cut off.

**4:3 Letter Box:** Select when a standard 4:3 TV is connected.

Displays theatrical images with masking bars above and below the picture.

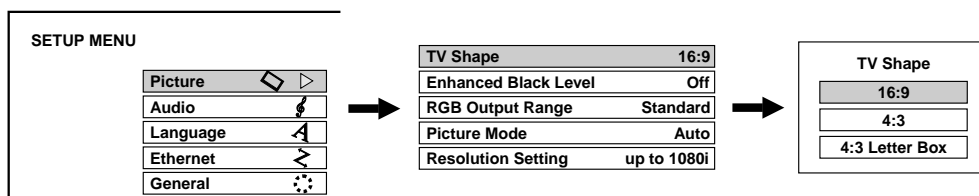

### Notes:

- When an HD DVD or a DVD has a particular picture shape, the contents may not be compatible with other picture shapes.
- DVDs containing 4:3 picture only always display 4:3 pictures regardless of the TV Shape setting.
- If "16:9" is selected while connecting a 4:3 TV, playback pictures may be distorted horizontally or shrink vertically. Make this setting according to your TV shape.
- Actual picture shape may depend on signal types of broadcasts or input sources, or settings on the connected TV. Refer to the owner's manual of your TV.

### Enhanced Black Level

1. In STOP mode, press the **SETUP** button on the remote control.
2. Use the **▲** or **▼** button to select **Picture**, then press the **OK** button.
3. Use the **▲** or **▼** button to select **Enhanced Black Level**, then press the **OK** button.
4. Use the **▲** or **▼** button to make adjustments, then press the **OK** button.
5. Press the **SETUP** button to exit menu.

**On:** To display deeper, richer black than in "Off" setting.

**Off:** Normal black level.

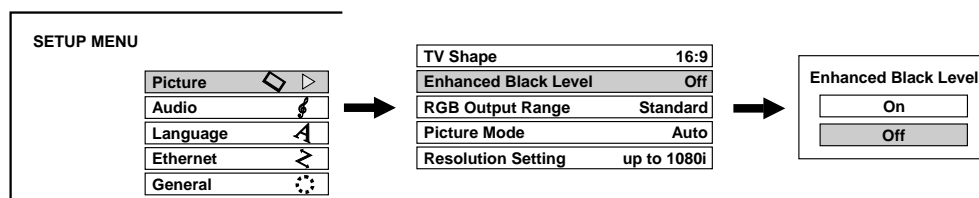

### Note:

- Effective only in 480i output from the COMPONENT VIDEO OUTPUT jacks or the VIDEO OUTPUT jack.

# CUSTOMIZING THE FUNCTION SETTINGS

## RGB Output Range

1. In STOP mode, press the **SETUP** button on the remote control.
2. Use the **▲** or **▼** button to select **Picture**, then press the **OK** button.
3. Use the **▲** or **▼** button to select **RGB Output Range**, then press the **OK** button.
4. Use the **▲** or **▼** button to select the options (Standard or Enhanced), then press the **OK** button.
5. Press the **SETUP** button to exit menu.

**Standard:** For a monitor of RGB range 16-235.

**Enhanced:** For a monitor of RGB range 0-255.

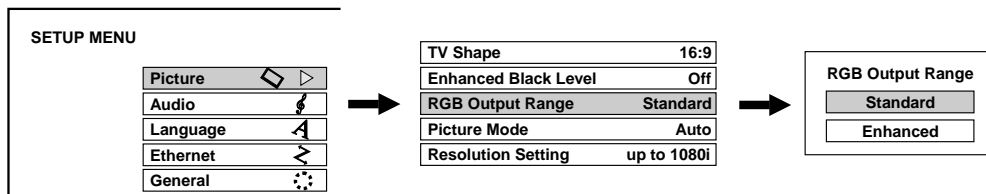

**Note:** If “Standard” pales black or “Enhanced” blackens too much, change the setting.

## Picture Mode

There are two types of source content in pictures recorded on DVDs: film content (pictures recorded from films at 24 frames per second) and video content (video signals recorded at 30 frames per second). Make this selection according to the type of content being viewed.

1. In STOP mode, press the **SETUP** button on the remote control.
2. Use the **▲** or **▼** button to select **Picture**, then press the **OK** button.
3. Use the **▲** or **▼** button to select **Picture Mode**, then press the **OK** button.
4. Use the **▲** or **▼** button to select an option (Film, Video or Auto), then press the **OK** button.
5. Press the **SETUP** button to exit menu.

**Film:** The player converts film content pictures to the appropriate progressive output format. Suitable for playback of film content pictures.

**Video:** The player filters video signal, and converts it to the appropriate progressive output format. Suitable for playback of video content pictures.

**Auto:** The player automatically detects source content, film or video, of playback source, and converts the signal to the appropriate progressive output format.

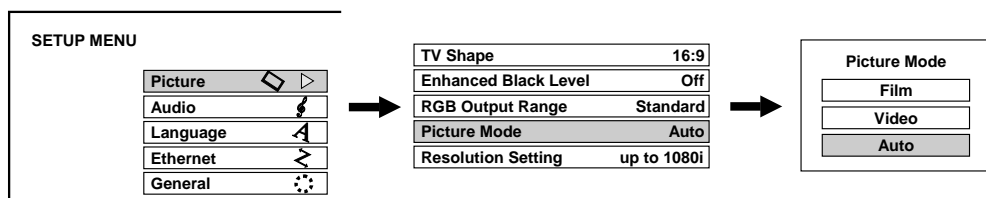

## Note:

- The player may not be able to detect the source (film or video) of some material. If you notice undesirable picture performance, try selecting “Film” or “Video”.



# CUSTOMIZING THE FUNCTION SETTINGS

## Resolution Setting

To select the resolution of the player's output according to the connected TV.

1. In STOP mode, press the **SETUP** button on the remote control.
2. Use the **▲** or **▼** button to select **Picture**, then press the **OK** button.
3. Use the **▲** or **▼** button to select **Resolution Setting**, then press the **OK** button.
4. Use the **▲** or **▼** button to make adjustments, then press the **OK** button.
5. Press the **SETUP** button to exit menu.

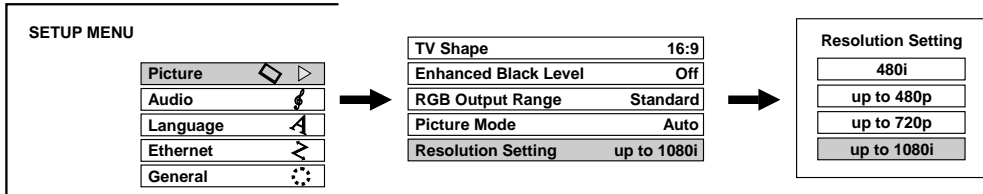

TV input	Resolution Setting
HDMI input	Select the resolution. e.g. <b>up to 1080i</b>
Component Video input	Select the resolution according to the performance of the connected TV.
VIDEO input (Yellow)	No need to set.

You may find that setting the output resolution of the player to match as closely as possible to the native resolution of your display provides the best picture performance (e.g. 720p for 720p and 1080i for 1080 or 1080p).

Note:

- In case the "Resolution Setting" menu disappears, make composite video (yellow) connection to restore it, then select the resolution that is compatible with the connected TV.

## Audio

### Digital Out SPDIF

To select the output sound format when connecting the DIGITAL AUDIO OUTPUT jack.

1. In STOP mode, press the **SETUP** button on the remote control.
2. Use the **▲** or **▼** button to select **Audio**, then press the **OK** button.
3. Use the **▲** or **▼** button to select **Digital Out SPDIF**, then press the **OK** button.
4. Use the **▲** or **▼** button to select the options (Bitstream or PCM), then press the **OK** button.
5. Press the **SETUP** button to exit menu.

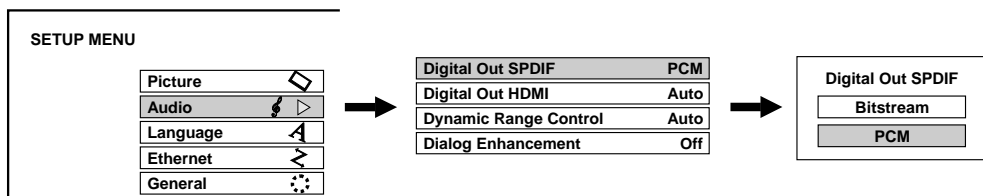

# CUSTOMIZING THE FUNCTION SETTINGS

## Bitstream:

**Select this when an AV receiver or processor equipped with built-in Dolby Digital, DTS or MPEG decoder is connected to this player.**

When you play a disc recorded in Dolby Digital Plus or Dolby TrueHD format, Dolby Digital sound is output. When you play a disc recorded in DTS-HD format, the sound is converted to a DTS bitstream. If the AV receiver or processor does not support DTS, select "PCM".

## PCM:

**Select this when a 2ch digital stereo amplifier is connected to this player.**

When you play an HD DVD or DVD recorded in Dolby Digital, Dolby Digital Plus, Dolby TrueHD, DTS-HD format, sound is converted into PCM (2ch) format.

## Digital Out HDMI

To select the output sound format when connecting the HDMI OUTPUT jack.

1. In STOP mode, press the **SETUP** button on the remote control.
2. Use the **▲** or **▼** button to select **Audio**, then press the **OK** button.
3. Use the **▲** or **▼** button to select **Digital Out HDMI**, then press the **OK** button.
4. Use the **▲** or **▼** button to select the options (Auto, PCM or Downmixed PCM), then press the **OK** button.
5. Press the **SETUP** button to exit menu.

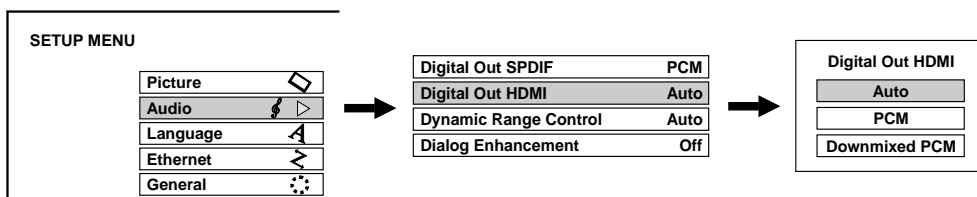

## Auto:

**Select this when an HDMI device equipped with built-in Dolby Digital, DTS, MPEG or a linear PCM decoder is connected to this player.**

When you play a disc recorded in Dolby Digital Plus or Dolby TrueHD or DTS-HD, PCM is output (core only for DTS-HD). When you play a disc recorded in Dolby Digital or DTS-HD format, digital audio signal (bitstream audio) is output. If a connected HDMI device does not support Dolby Digital, DTS or MPEG, sound is converted into linear PCM to output.

## PCM:

**Select this when an HDMI device that has multi channel input is connected to this player.**

When you play an HD DVD or DVD recorded in multi channel in Dolby Digital, Dolby Digital Plus, Dolby TrueHD, DTS or DTS-HD format, the sound is decoded and output in multi channel in linear PCM format.

## Downmixed PCM:

**Select this when a 2ch digital stereo AV receiver or processor is connected to this player.**

When you play a DVD recorded in Dolby Digital, DTS, MPEG1 or MPEG2 format, sound is converted into PCM (2ch) format to output.

## Note:

Setting "Auto" or "PCM" will reduce output level of multi channel sound from the ANALOG AUDIO OUTPUT jacks and the DIGITAL AUDIO OUTPUT BITSTREAM/PCM jack if you:

- view the playback picture on an HDMI TV connected to this player.
- play an HD DVD of a certain type, recorded in linear PCM format.

In this case, the output level will be restored by setting to "Downmixed PCM".

# CUSTOMIZING THE FUNCTION SETTINGS

## Dynamic Range Control

To turn on or off a function that makes faint sounds easier to hear even if you lower the volume during late hour playback.

1. In STOP mode, press the **SETUP** button on the remote control.
2. Use the **▲** or **▼** button to select **Audio**, then press the **OK** button.
3. Use the **▲** or **▼** button to select **Dynamic Range Control**, then press the **OK** button.
4. Use the **▲** or **▼** button to select the options (Auto, On or Off), then press the **OK** button.
5. Press the **SETUP** button to exit menu.

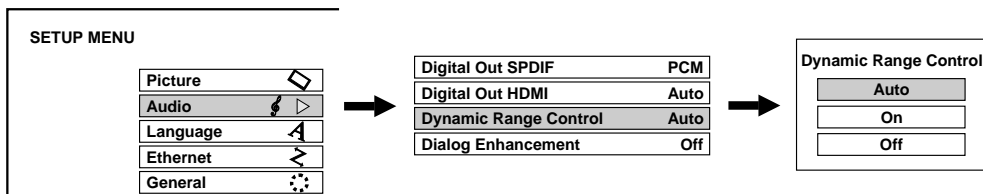

**Auto:** While playing an HD DVD recorded in Dolby TrueHD format, this function will be automatically enabled or disabled according to certain commands included in the content. For other discs, this function is enabled.

**On:** This function is enabled.

**Off:** This function is disabled.

## Dialog Enhancement

To turn on or off a function that increases dialog volume of a DVD.

1. In STOP mode, press the **SETUP** button on the remote control.
2. Use the **▲** or **▼** button to select **Audio**, then press the **OK** button.
3. Use the **▲** or **▼** button to select **Dialog Enhancement**, then press the **OK** button.
4. Use the **▲** or **▼** button to select the options (On or Off), then press the **OK** button.
5. Press the **SETUP** button to exit menu.

**On:** This function is enabled.

**Off:** This function is disabled.

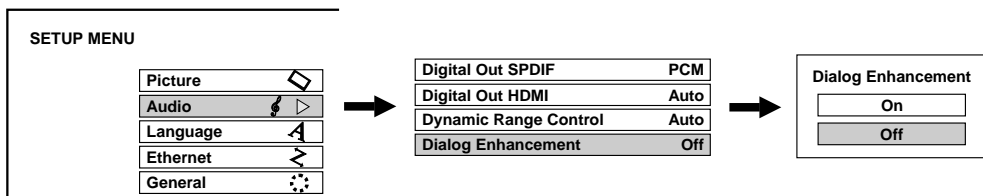

Notes:

- This function is effective only in playback of Dolby Digital recorded on HD DVDs or DVDs.
- The effect level of this function varies depending on the disc.

# CUSTOMIZING THE FUNCTION SETTINGS

## Language

### Disc Menu Language

To select a preferred language for disc menus.

1. In STOP mode, press the **SETUP** button on the remote control.
2. Use the ▲ or ▼ button to select **Language**, then press the **OK** button.
3. Use the ▲ or ▼ button to select **Disc Menu Language**, then press the **OK** button.
4. Use the ▲ or ▼ button to select the language, then press the **OK** button.  
The screen will change to your selected language immediately.
5. Press the **SETUP** button to exit menu.

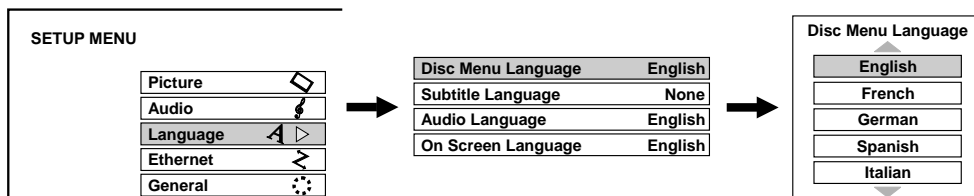

### Subtitle Language

To select a preferred language for disc menus.

1. In STOP mode, press the **SETUP** button on the remote control.
2. Use the ▲ or ▼ button to select **Language**, then press the **OK** button.
3. Use the ▲ or ▼ button to select **Subtitle Language**, then press the **OK** button.
4. Use the ▲ or ▼ button to select language, then press the **OK** button.
5. Press the **SETUP** button to exit menu.

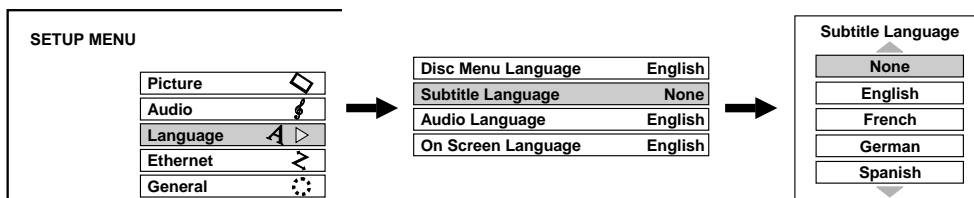

### Notes:

- Some discs may be set to display subtitles in a different language from that you selected, as the disc may contain alternate language.
- Some discs allow you to change subtitle selections via the disc menu only. In this case, press MENU button and choose the appropriate subtitle language from the selection on the disc menu.

# CUSTOMIZING THE FUNCTION SETTINGS

## Audio Language

To select a preferred language for disc menus.

1. In STOP mode, press the **SETUP** button on the remote control.
2. Use the **▲** or **▼** button to select **Language**, then press the **OK** button.
3. Use the **▲** or **▼** button to select **Audio Language**, then press the **OK** button.
4. Use the **▲** or **▼** button to select language, then press the **OK** button.
5. Press the **SETUP** button to exit menu.

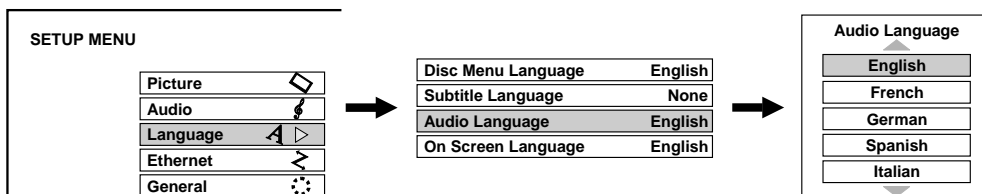

Note:

- Some discs may be played in a different language from that you selected, as the disc may contain alternate language.

## On Screen Language

To select a preferred language for disc menus.

1. In STOP mode, press the **SETUP** button on the remote control.
2. Use the **▲** or **▼** button to select **Language**, then press the **OK** button.
3. Use the **▲** or **▼** button to select **On Screen Language**, then press the **OK** button.
4. Use the **▲** or **▼** button to select language, then press the **OK** button.
5. Press the **SETUP** button to exit menu.

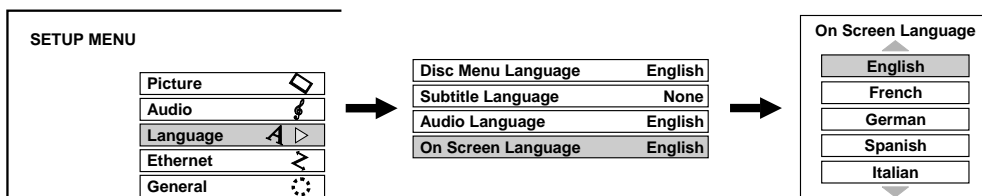

## Ethernet

Perform this setting if you connect the player to your LAN.

1. In STOP mode, press the **SETUP** button on the remote control.
2. Use the **▲** or **▼** button to select **Ethernet**, then press the **OK** button.
3. Use the **▲** or **▼** button to select the options (DHCP, Proxy Setting, Mac Address, NTP Server, Network Speed or Cookie Setting), then press the **OK** button.
4. Press the **SETUP** button to exit menu.

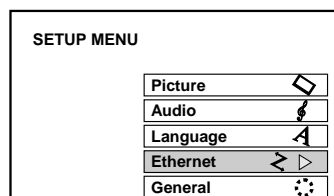

# CUSTOMIZING THE FUNCTION SETTINGS

## DHCP

To set your network information.

1. Set "DHCP" to "On" and press the **OK** button.
2. Set "DNS" to "On" and press the **OK** button.

The DNS server is obtained automatically from the DHCP server.

3. Select "Confirm", then press the **OK** button.

If the setup is successful, an IP address appears. Press the **OK** button.

DHCP	Off
Proxy Setting	Off
MAC Address	
NTP Server	Off
Network Speed	56kbps Modern
Cookie Setting	Accept

DHCP	
DHCP	<input checked="" type="radio"/> On <input type="radio"/> Off
IP Address	0 0 0 0
Subnet Mask	0 0 0 0
Gateway	0 0 0 0
DNS	<input checked="" type="radio"/> On <input type="radio"/> Off
DNS Server	0 0 0 0
Confirm	
OK Cancel	

Skipped when "DHCP" is set to "On".

Skipped when "DNS" is set to "On".

If the setup is not successful:

- a. Set "DHCP" to "Off" and press the **OK** button.
- b. Input the address using the number buttons.

**"IP Address"**: This sets a different address within the same subnet of the PC on your network.

e.g. if the IP address of the PC is 192.168.1.10, set 192.168.1.15 (or some other unused address.)

**"Subnet Mask"**: This sets the subnet mask of the network environment that will be connected.

e.g.: 255.255.255.0

**"Gateway"**: This sets the gateway used by the player (e.g.: 192.168.1.1).

**"DNS Server"**: This sets the DNS server to be used by the player (192.168.1.1).

- c. Select "OK", then press the **OK** button.

DHCP	
DHCP	<input type="radio"/> On <input checked="" type="radio"/> Off
IP Address	192 168 1 15
Subnet Mask	255 255 255 0
Gateway	192 168 1 1
DNS	<input type="radio"/> On <input checked="" type="radio"/> Off
DNS Server	192 168 1 1
Confirm	
OK Cancel	

## Proxy Setting

Enter the proxy server address when your provider requires proxy setting.

1. Set "Proxy" to "On" and press the **OK** button.
2. Enter the specified data from the provider.  
Refer to the instructions below for inputting characters (Server, Port).
3. Select "OK", then press the **OK** button.

DHCP	Off
Proxy Setting	Off
MAC Address	
NTP Server	Off
Network Speed	56kbps Modern
Cookie Setting	Accept



How to input characters	
<b>OK button:</b>	To begin or finish input.
<b>▲ / ▼ buttons:</b>	To select a character.
<b>◀ / ▶ buttons:</b>	To move to the next character.
<b>CLEAR button:</b>	To erase a character.
<b>Number buttons:</b>	To input a number.

Proxy Setting	
Proxy	<input checked="" type="radio"/> On <input type="radio"/> Off
Server	
Port	0
OK Cancel	

# CUSTOMIZING THE FUNCTION SETTINGS

## MAC Address

To display the MAC address of the player ( Fixed. No need to set.)

## NTP Server

Set "On" or "Off" and press the **OK** button.

**On:** The player automatically accesses an internet server to adjust time protocol.

**Off:** The player does not access an internet server to adjust its clock.

DHCP	Off
Proxy Setting	Off
MAC Address	
NTP Server	Off
Network Speed	56kbps Modern
Cookie Setting	Accept



NTP Server	
<input type="radio"/> On	
<input checked="" type="radio"/> Off	

## Network Speed

Select the speed and press the **OK** button.

DHCP	Off
Proxy Setting	Off
MAC Address	
NTP Server	Off
Network Speed	56kbps Modern
Cookie Setting	Accept



Network Speed	
28.8kbps Modern	33.6kbps Modern
56kbps Modern	64kbps ISDN
128kbps ISDN	256kbps DSL/Cable
384kbps DSL/Cable	512kbps DSL/Cable
768kbps DSL/Cable	1Mbps Cable
1.5Mbps T1	Over 10Mbps
Other	

Network Speed (Other)	
<input type="text" value="1"/>	kbps
<input type="button" value="OK"/>	<input type="button" value="Cancel"/>

For "Other" speeds:

- Select "Other" and press the **OK** button.
- Specify the speed by using the number buttons.
- Select "OK", then press the **OK** button.

## Cookie Setting

Select "Accept" or "Not Accept" and press the **OK** button.

Accept: Cookies are accepted.

Not Accept: Cookies are rejected.

This may disable some services on web pages.

DHCP	Off
Proxy Setting	Off
MAC Address	
NTP Server	Off
Network Speed	56kbps Modern
Cookie Setting	Accept



Cookie Setting	
<input checked="" type="radio"/> Accept	
<input type="radio"/> Not Accept	

# CUSTOMIZING THE FUNCTION SETTINGS

## General

### Parental Lock

HD DVDs and DVDs equipped with a Parental Lock function includes predetermined limitation levels. The limitation level or limitation method may differ depending on the disc. For example the whole contents of a disc may not be played back, or an extreme violent scene may be cut or replaced automatically by another scene.

### Important

Depending on the disc, it may not be evident whether the disc is compatible with the Parental Lock function. Make sure the Parental Lock function you set is activated correctly.

1. In STOP mode, press the **SETUP** button on the remote control.
2. Use the **▲** or **▼** button to select **General**, then press the **OK** button.
3. Use the **▲** or **▼** button to select **Parental Lock**, then press the **OK** button.
4. Enter a 4-digit password by using the number buttons, then press the **OK** button.

When you use the player for the first time, set a new 4-digit password. If you make a mistake entering your password, press the **CLEAR** button before pressing the **OK** button, and re-enter the correct password.

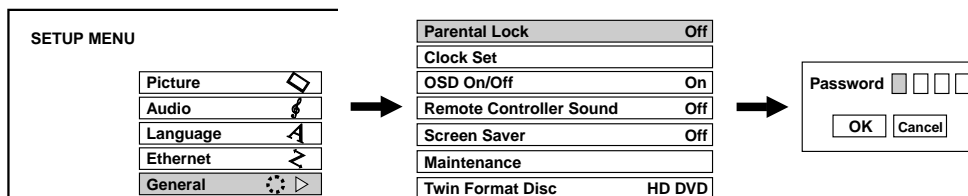

5. Set the details (using the **◀** or **▶** button to select the option: Lock, Area Code or Level.).

a) Select "On" or "Off" by pressing the **▲** or **▼** button.

#### On

Select this to activate Parental Lock function or to change the setting.

#### Off

Deactivate the Parental Lock function.

Skip to step 6.

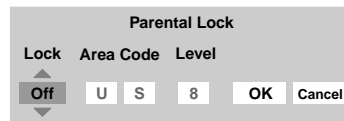

b) Press the **▲** or **▼** button to enter the code of a country/area whose standards were used to rate a disc, referring to the list below.

Country/Area	Code	Country/Area	Code	Country/Area	Code	Country/Area	Code
AUSTRALIA	AU	FRANCE	FR	NETHERLANDS	NL	SWEDEN	BE
BELGIUM	BE	GERMANY	DE	NORWAY	NO	SWITZERLAND	CH
CANADA	CA	INDONESIA	ID	PHILIPPINES	PH	TAIWAN	TW
CHINA	CN	ITALY	IT	RUSSIAN FEDERATION	RU	THAILAND	TH
CHINA HONGKONG	HK	JAPAN	JP	SINGAPORE	SG	UNITED KINGDOM	GB
DENMARK	DK	MALAYSIA	MY	SPAIN	ES	UNITED STATES	US
FINLAND	FI						

c) Select the desired limitation level.

Unless the Parental Lock function is set to "Off", a disc that has a higher limitation level than your selected limitation level cannot be played back. For example, if you select level 7, discs exceeding level 8 are locked and cannot be played back.

When "US" is selected, its limitation level corresponds to the following settings.

Level 7: NC-17 Level 6: R Level 4: PG13 Level 3: PG Level 1: G



# CUSTOMIZING THE FUNCTION SETTINGS

6. Select "OK" then press the **OK** button.

## To change the limitation level of the Parental Lock function

Follow steps 1-6 above.

## To change the password

- 1) At step 4, press the **STOP** button 4 times then press the **OK** button.  
The password is cleared.
- 2) Enter a new 4-digit password by using the number buttons.
- 3) Press the **OK** button.

## Clock Set

1. In **STOP** mode, press the **SETUP** button on the remote control.
2. Use the **▲** or **▼** button to select **General**, then press the **OK** button.
3. Use the **▲** or **▼** button to select **Clock Set**, then press the **OK** button.
4. Select your time zone using the **▲** or **▼** button, then press the **OK** button.
5. Enter the year using the number buttons, then press the **OK** button.
6. Set "Month", "Day" and "Time" in the same manner as step 5 above.
7. Press the **◀** button then the **▼** button to select "OK", then press the **OK** button.

Parental Lock	Off
Clock Set	
OSD On/Off	On
Remote Controller Sound	Off
Screen Saver	Off
Maintenance	
Twin Format Disc	HD DVD



Clock Set	
Time Zone	(GMT-4:00) Atlantic Time
Year	2007
Month	01
Day	01
Time	01:00:00 AM
OK Cancel	

## OSD On/Off

To activate or deactivate the operational status display on the TV screen.

1. In **STOP** mode, press the **SETUP** button on the remote control.
2. Use the **▲** or **▼** button to select **General**, then press the **OK** button.
3. Use the **▲** or **▼** button to select **OSD On/Off**, then press the **OK** button.
4. Use the **▲** or **▼** button to select the options (On or Off), then press the **OK** button.
5. Press the **SETUP** button to exit menu.

Parental Lock	Off
Clock Set	
OSD On/Off	On
Remote Controller Sound	Off
Screen Saver	Off
Maintenance	
Twin Format Disc	HD DVD



OSD On/Off	
On	
Off	

# CUSTOMIZING THE FUNCTION SETTINGS

## Remote Controller Sound

1. In STOP mode, press the **SETUP** button on the remote control.
2. Use the **▲** or **▼** button to select **General**, then press the **OK** button.
3. Use the **▲** or **▼** button to select **Remote Controller Sound**, then press the **OK** button.
4. Use the **▲** or **▼** button to select the options (On or Off), then press the **OK** button.
5. Press the **SETUP** button to exit menu.

**On:** Turns on the beep sound.

**Off:** Turns off the beep sound.

Parental Lock	Off
Clock Set	
OSD On/Off	On
Remote Controller Sound	Off
Screen Saver	Off
Maintenance	
Twin Format Disc	HD DVD



Remote Controller Sound	
On	
Off	

## Screen Saver

1. In STOP mode, press the **SETUP** button on the remote control.
2. Use the **▲** or **▼** button to select **General**, then press the **OK** button.
3. Use the **▲** or **▼** button to select **Screen Saver**, then press the **OK** button.
4. Use the **▲** or **▼** button to select the options (Auto Power Off, On or Off), then press the **OK** button.
5. Press the **SETUP** button to exit menu.

**Auto Power Off:** Turns the player off if stop mode or picture pausing continues for about 20 minutes.

**On:** Activates the screen saver if stop mode or picture pausing continues for about 20 minutes.

**Off:** Deactivates the screen saver.

Parental Lock	Off
Clock Set	
OSD On/Off	On
Remote Controller Sound	Off
Screen Saver	Off
Maintenance	
Twin Format Disc	HD DVD



Screen Saver	
Auto Power Off	
On	
Off	

## Notes:

- To close the screen saver, press any button on the player or the remote control.
- When an HD DVD is used, this function activates only in stop mode.

# CUSTOMIZING THE FUNCTION SETTINGS

## Maintenance

1. In STOP mode, press the **SETUP** button on the remote control.
2. Use the **▲** or **▼** button to select **General**, then press the **OK** button.
3. Use the **▲** or **▼** button to select **Maintenance**, then press the **OK** button.
4. Use the **▲** or **▼** button to select the options (Initialize, Update <Firmware update> or Persistent Storage), then press the **OK** button.
5. Press the **SETUP** button to exit menu.

Parental Lock	Off
Clock Set	
OSD On/Off	On
Remote Controller Sound	Off
Screen Saver	Off
<b>Maintenance</b>	
Twin Format Disc	HD DVD



<b>Maintenance</b>
Initialize
Update
Persistent Storage

### Initialize:

To reset all the settings to factory set default.

### Update (Firmware update):

If you have broadband internet service you may obtain firmware updates over the internet using the LAN port on the back of your player.

- BEFORE BEGINNING THE FIRMWARE UPDATE PROCESS, BE SURE TO REMOVE ANY DISCS FROM YOUR PLAYER.
- Press SETUP and select "General" > "Maintenance". Follow the instructions on the screen.
- If a firmware update is available for your player, it will be downloaded. Once the firmware update download process has finished, the player's power will automatically switch off. You must wait until this process has finished.
- **DO NOT UNPLUG, TURN OFF, OR USE ANY OTHER FEATURE OF YOUR PLAYER DURING THE FIRMWARE UPDATE PROCESS.** Doing so will cause the writing of the firmware update to the player to be halted and the player may no longer operate properly.
- If no firmware update is available, the player will quickly exit the firmware update process.

### Persistent Storage:

To open the menu to control player's memory allocated for content.

The menu selections will vary depending on the content. Operate following the instructions displayed on your screen.

### Twin Format Disc

To select a layer to play, HD DVD or DVD of an HD DVD Twin Format Disc. (Not available if a disc is loaded.)

1. In STOP mode, press the **SETUP** button on the remote control.
2. Use the **▲** or **▼** button to select **General**, then press the **OK** button.
3. Use the **▲** or **▼** button to select **Twin Format Disc**, then press the **OK** button.
4. Use the **▲** or **▼** button to select the options (HD DVD or DVD), then press the **OK** button.
5. Press the **SETUP** button to exit menu.

Parental Lock	Off
Clock Set	Off
OSD On/Off	Off
Remote Controller Sound	Off
Screen Saver	Off
<b>Maintenance</b>	
Twin Format Disc	HD DVD



<b>Twin Format Disc</b>
HD DVD
DVD

**HD DVD:** Only the HD DVD layer is played.

**DVD:** Only the DVD layer is played.

Note: For combination discs, select the desired version by disc side (see label for information).

# TROUBLESHOOTING GUIDE

## **SYMPTOM**

## **CAUSE (AND REMEDY)**

No power.	<ul style="list-style-type: none"><li>• Ensure the AC power cord is connected.</li></ul>
No picture or abnormal color	<ul style="list-style-type: none"><li>• The region number of the disc doesn't match the region number of this unit.</li><li>• The TV is not set to receive HD DVD/DVD signal output.</li><li>• The video/HDMI cable is not connected securely.</li><li>• In case the menu of "Resolution Setting" disappears, make composite video (yellow) connection to restore it, then select the resolution that is compatible with the connected TV.</li></ul>
No sound is heard.	<ul style="list-style-type: none"><li>• The system is in Pause mode or in Slow-motion Play mode. Press the ► PLAY button to return to normal play mode.</li><li>• Set "Digital Out SPDIF" or "Digital Out HDMI" properly in accordance with the connected device and connection procedure.</li><li>• If using the optical digital output for a Dolby Digital Plus, Dolby TrueHD, DTS-HD or DTS soundtrack, be sure your AV receiver or processor is set to use the input connected to your player and is set to decode a DTS bitstream. If your AV receiver or processor does not support DTS, select PCM output on the player.</li><li>• Make sure the audio cable is connected securely.</li></ul>
Playback picture has noise.	<ul style="list-style-type: none"><li>• If video from the player is watched via a video recorder or on a TV with a built in video recorder, the copy guard may prevent images from being displayed properly. Be sure to connect the player directly to the TV.</li></ul>
The remote does not function.	<ul style="list-style-type: none"><li>• Remove any obstacles between the remote and the unit.</li><li>• Use the remote near the unit.</li><li>• Point the remote at the remote sensor on the unit.</li><li>• Replace the batteries in the remote.</li></ul>
The disc does not play.	<ul style="list-style-type: none"><li>• There is no disc inside ("No Disc" appears on the TV screen).</li><li>• Insert the disc correctly with the playback side facing down on the disc tray.</li><li>• Clean the disc.</li><li>• A non-VALID disc has been inserted. The unit and DVD disc region number are incompatible.</li><li>• If the disc is a DVD-RW or DVD-R disc, finalize the disc before attempting to play it with the player.</li><li>• If the disc includes parent lock support, playback is restricted while the parent lock of the player is set. Cancel Parental Lock or change the restriction level.</li><li>• Condensation may have formed inside the unit due to a sudden change in temperature. Wait approximately an hour for it to clear and try again.</li></ul>
Screen freezes and no buttons work.	<ul style="list-style-type: none"><li>• Pressing STANDBY/ON button on the player for approximately ten seconds forces the player to turn off. Turn the player off and then on again.</li></ul>
After powering on, "Clock Set" menu appears.	<ul style="list-style-type: none"><li>• The power supply to the player may have been disconnected. Reset the clock.</li></ul>

# LICENSE INFORMATION ON THE SOFTWARE USED IN THIS HD DVD PLAYER

This document is statement purpose only. Not concerned with operation of this product.

The software pre-installed in this HD DVD player consists of multiple, independent software components. Each software component is copyrighted by Manufacturer or a third party.

This HD DVD player uses software components that are distributed as freeware under a third-party end-user license agreement or copyright notice (hereinafter referred to as a "EULA").

Some EULAs require that the source code of the applicable component be disclosed as the condition for distributing the software component in executable format.

Some of the software components distributed under an EULA are made available for use by the user on the assumption that they are not copyrighted or warranted. These software components are licensed to the user free of charge and therefore not covered by any warranty within the scope of the applicable laws. These software components are not subject to any copyrights or other third-party rights and are provided in "as is" condition without any warranty, whether express or implied. "Warranty" here includes, but not limited to, an implied warranty for marketability or fitness for specific uses. All risks associated with the quality or performance of these software components are assumed by the user. Manufacturer shall not be liable whatsoever for any cost of repair or correction or other incidental expense incurred in connection with a defect found in any of these software components. Unless specified under the applicable laws or in a written agreement, a party who changes or redistributes the software with consent from the copyright holders or based on the aforementioned licenses shall not be held liable whatsoever for any loss arising from the use of or inability to use such software components. The same applies even when the copyright holders or relevant third parties have been informed of the possibility of such loss. "Loss" here includes normal, special, incidental and indirect loss (including, but not limited to, the loss of data or its accuracy; loss incurred by the user or any third party; and interface incompatibility with other software). Please read each EULA for details on the use conditions and items that must be observed regarding these software components.

The table below lists the software components pre-installed in this HD DVD player, which are subject to EULAs. The user should read the applicable EULAs carefully before using these software components. The EULAs are exhibited in their original text (English) as exactly written by the respective parties.

Pre-installed software	EULA	Pre-installed software	EULA
Linux Kernel Busybox	Exhibit A	OpenSSL	Exhibit C
glibc	Exhibit B	freetype	Exhibit D

## Exhibit A

### GNU GENERAL PUBLIC LICENSE Version 2, June 1991

Copyright © 1989, 1991 Free Software Foundation, Inc.  
59 Temple Place, Suite 330, Boston, MA 02111-1307 USA

Everyone is permitted to copy and distribute verbatim copies of this license document, but changing it is not allowed.

#### Preamble

The licenses for most software are designed to take away your freedom to share and change it. By contrast, the GNU General Public License is intended to guarantee your freedom to share and change free software – to make sure the software is free for all its users. This General Public License applies to most of the Free Software Foundation's software and to any other program whose authors commit to using it. (Some other Free Software Foundation software is covered by the GNU Library General Public License instead.) You can apply it to your programs, too.

When we speak of free software, we are referring to freedom, not price. Our General Public Licenses are designed to make sure that you have the freedom to distribute copies of free software (and charge for this service if you wish), that you receive source code or can get it if you want it, that you can change the software or

use pieces of it in new free programs; and that you know you can do these things.

To protect your rights, we need to make restrictions that forbid anyone to deny you these rights or to ask you to surrender the rights. These restrictions translate to certain responsibilities for you if you distribute copies of the software, or if you modify it.

For example, if you distribute copies of such a program, whether gratis or for a fee, you must give the recipients all the rights that you have. You must make sure that they, too, receive or can get the source code. And you must show them these terms so they know their rights.

We protect your rights with two steps: (1) copyright the software, and (2) offer you this license which gives you legal permission to copy, distribute and/or modify the software.

Also, for each author's protection and ours, we want to make certain that everyone understands that there is no warranty for this free software. If the software is modified by someone else and passed on, we want its recipients to know that what they have is not the original, so that any problems introduced by others will not reflect on the original authors' reputations.

Finally, any free program is threatened constantly by

# LICENSE INFORMATION ON THE SOFTWARE USED IN THIS HD DVD PLAYER

software patents. We wish to avoid the danger that redistributors of a free program will individually obtain patent licenses, in effect making the program proprietary. To prevent this, we have made it clear that any patent must be licensed for everyone's free use or not licensed at all.

The precise terms and conditions for copying, distribution and modification follow.

## GNU GENERAL PUBLIC LICENSE TERMS AND CONDITIONS FOR COPYING, DISTRIBUTION AND MODIFICATION

**0.** This License applies to any program or other work which contains a notice placed by the copyright holder saying it may be distributed under the terms of this General Public License. The "Program", below, refers to any such program or work, and a "work based on the Program" means either the Program or any derivative work under copyright law: that is to say, a work containing the Program or a portion of it, either verbatim or with modifications and/or translated into another language. (Hereinafter, translation is included without limitation in the term "modification".) Each licensee is addressed as "you".

Activities other than copying, distribution and modification are not covered by this License; they are outside its scope. The act of running the Program is not restricted, and the output from the Program is covered only if its contents constitute a work based on the Program (independent of having been made by running the Program). Whether that is true depends on what the Program does.

**1.** You may copy and distribute verbatim copies of the Program's source code as you receive it, in any medium, provided that you conspicuously and appropriately publish on each copy an appropriate copyright notice and disclaimer of warranty; keep intact all the notices that refer to this License and to the absence of any warranty; and give any other recipients of the Program a copy of this License along with the Program.

You may charge a fee for the physical act of transferring a copy, and you may at your option offer warranty protection in exchange for a fee.

**2.** You may modify your copy or copies of the Program or any portion of it, thus forming a work based on the Program, and copy and distribute such modifications or work under the terms of Section 1 above, provided that you also meet all of these conditions:

- a) You must cause the modified files to carry prominent notices stating that you changed the files and the date of any change.
- b) You must cause any work that you distribute or publish, that in whole or in part contains or is derived from the Program or any part thereof, to be licensed as a whole at no charge to all third parties under the terms of this License.
- c) If the modified program normally reads commands interactively when run, you must cause it, when started running for such interactive use in the most ordinary way, to print or display an announcement including an

appropriate copyright notice and a notice that there is no warranty (or else, saying that you provide a warranty) and that users may redistribute the program under these conditions, and telling the user how to view a copy of this License.

(Exception: if the Program itself is interactive but does not normally print such an announcement, your work based on the Program is not required to print an announcement.)

These requirements apply to the modified work as a whole. If identifiable sections of that work are not derived from the Program, and can be reasonably considered independent and separate works in themselves, then this License, and its terms, do not apply to those sections when you distribute them as separate works. But when you distribute the same sections as part of a whole which is a work based on the Program, the distribution of the whole must be on the terms of this License, whose permissions for other licensees extend to the entire whole, and thus to each and every part regardless of who wrote it.

Thus, it is not the intent of this section to claim rights or contest your rights to work written entirely by you; rather, the intent is to exercise the right to control the distribution of derivative or collective works based on the Program.

In addition, mere aggregation of another work not based on the Program with the Program (or with a work based on the Program) on a volume of a storage or distribution medium does not bring the other work under the scope of this License.

**3.** You may copy and distribute the Program (or a work based on it, under Section 2) in object code or executable form under the terms of Sections 1 and 2 above provided that you also do one of the following:

- a) Accompany it with the complete corresponding machine-readable source code, which must be distributed under the terms of Sections 1 and 2 above on a medium customarily used for software interchange; or,
- b) Accompany it with a written offer, valid for at least three years, to give any third party, for a charge no more than your cost of physically performing source distribution, a complete machine-readable copy of the corresponding source code, to be distributed under the terms of Sections 1 and 2 above on a medium customarily used for software interchange; or,
- c) Accompany it with the information you received as to the offer to distribute corresponding source code. (This alternative is allowed only for noncommercial distribution and only if you received the program in object code or executable form with such an offer, in accord with Subsection b above.)

The source code for a work means the preferred form of the work for making modifications to it. For an executable work, complete source code means all the source code for all modules it contains, plus any associated interface definition files, plus the scripts used to control compilation and installation of the executable. However, as a special

# LICENSE INFORMATION ON THE SOFTWARE USED IN THIS HD DVD PLAYER

exception, the source code distributed need not include anything that is normally distributed (in either source or binary form) with the major components (compiler, kernel, and so on) of the operating system on which the executable runs, unless that component itself accompanies the executable.

If distribution of executable or object code is made by offering access to copy from a designated place, then offering equivalent access to copy the source code from the same place counts as distribution of the source code, even though third parties are not compelled to copy the source along with the object code.

**4.** You may not copy, modify, sublicense, or distribute the Program except as expressly provided under this License. Any attempt otherwise to copy, modify, sublicense or distribute the Program is void, and will automatically terminate your rights under this License. However, parties who have received copies, or rights, from you under this License will not have their licenses terminated so long as such parties remain in full compliance.

**5.** You are not required to accept this License, since you have not signed it. However, nothing else grants you permission to modify or distribute the Program or its derivative works. These actions are prohibited by law if you do not accept this License. Therefore, by modifying or distributing the Program (or any work based on the Program), you indicate your acceptance of this License to do so, and all its terms and conditions for copying, distributing or modifying the Program or works based on it.

**6.** Each time you redistribute the Program (or any work based on the Program), the recipient automatically receives a license from the original licensor to copy, distribute or modify the Program subject to these terms and conditions. You may not impose any further restrictions on the recipients' exercise of the rights granted herein. You are not responsible for enforcing compliance by third parties to this License.

**7.** If as a consequence of a court judgment or allegation of patent infringement or for any other reason (not limited to patent issues), conditions are imposed on you (whether by court order, agreement or otherwise) that contradict the conditions of this License, they do not excuse you from the conditions of this License. If you cannot distribute so as to satisfy simultaneously your obligations under this License and any other pertinent obligations, then as a consequence you may not distribute the Program at all. For example, if a patent license would not permit royalty-free redistribution of the Program by all those who receive copies directly or indirectly through you, then the only way you could satisfy both it and this License would be to refrain entirely from distribution of the Program. If any portion of this section is held invalid or unenforceable under any particular circumstance, the balance of the section is intended to apply and the section as a whole is intended to apply in other circumstances.

It is not the purpose of this section to induce you to infringe any patents or other property right claims or to contest validity of any such claims; this section has the

sole purpose of protecting the integrity of the free software distribution system, which is implemented by public license practices. Many people have made generous contributions to the wide range of software distributed through that system in reliance on consistent application of that system; it is up to the author/donor to decide if he or she is willing to distribute software through any other system and a licensee cannot impose that choice.

This section is intended to make thoroughly clear what is believed to be a consequence of the rest of this License.

**8.** If the distribution and/or use of the Program is restricted in certain countries either by patents or by copyrighted interfaces, the original copyright holder who places the Program under this License may add an explicit geographical distribution limitation excluding those countries, so that distribution is permitted only in or among countries not thus excluded. In such case, this License incorporates the limitation as if written in the body of this License.

**9.** The Free Software Foundation may publish revised and/or new versions of the General Public License from time to time. Such new versions will be similar in spirit to the present version, but may differ in detail to address new problems or concerns.

Each version is given a distinguishing version number. If the Program specifies a version number of this License which applies to it and "any later version", you have the option of following the terms and conditions either of that version or of any later version published by the Free Software Foundation. If the Program does not specify a version number of this License, you may choose any version ever published by the Free Software Foundation.

**10.** If you wish to incorporate parts of the Program into other free programs whose distribution conditions are different, write to the author to ask for permission. For software which is copyrighted by the Free Software Foundation, write to the Free Software Foundation; we sometimes make exceptions for this. Our decision will be guided by the two goals of preserving the free status of all derivatives of our free software and of promoting the sharing and reuse of software generally.

## NO WARRANTY

**11.** BECAUSE THE PROGRAM IS LICENSED FREE OF CHARGE, THERE IS NO WARRANTY FOR THE PROGRAM, TO THE EXTENT PERMITTED BY APPLICABLE LAW. EXCEPT WHEN OTHERWISE STATED IN WRITING THE COPYRIGHT HOLDERS AND/OR OTHER PARTIES PROVIDE THE PROGRAM "AS IS" WITHOUT WARRANTY OF ANY KIND, EITHER EXPRESSED OR IMPLIED, INCLUDING, BUT NOT LIMITED TO, THE IMPLIED WARRANTIES OF MERCHANTABILITY AND FITNESS FOR A PARTICULAR PURPOSE. THE ENTIRE RISK AS TO THE QUALITY AND PERFORMANCE OF THE PROGRAM IS WITH YOU. SHOULD THE PROGRAM PROVE DEFECTIVE, YOU ASSUME THE COST OF ALL NECESSARY SERVICING, REPAIR OR CORRECTION.

**12.** IN NO EVENT UNLESS REQUIRED BY APPLICABLE LAW OR AGREED TO IN WRITING WILL ANY COPYRIGHT HOLDER, OR ANY OTHER PARTY WHO MAY MODIFY AND/

# LICENSE INFORMATION ON THE SOFTWARE USED IN THIS HD DVD PLAYER

OR REDISTRIBUTE THE PROGRAM AS PERMITTED ABOVE, BE LIABLE TO YOU FOR DAMAGES, INCLUDING ANY GENERAL, SPECIAL, INCIDENTAL OR CONSEQUENTIAL DAMAGES ARISING OUT OF THE USE OR INABILITY TO USE THE PROGRAM (INCLUDING BUT NOT LIMITED TO LOSS OF DATA OR DATA BEING RENDERED INACCURATE OR LOSSES SUSTAINED BY YOU OR THIRD PARTIES OR A FAILURE OF THE PROGRAM TO OPERATE WITH ANY OTHER PROGRAMS), EVEN IF SUCH HOLDER OR OTHER PARTY HAS BEEN ADVISED OF THE POSSIBILITY OF SUCH DAMAGES.

## END OF TERMS AND CONDITIONS

How to Apply These Terms to Your New Programs

If you develop a new program, and you want it to be of the greatest possible use to the public, the best way to achieve this is to make it free software which everyone can redistribute and change under these terms.

To do so, attach the following notices to the program. It is safest to attach them to the start of each source file to most effectively convey the exclusion of warranty; and each file should have at least the "copyright" line and a pointer to where the full notice is found.

<One line to give the program's name and a brief idea of what it does.>

Copyright © 19yy <name of author>

This program is free software; you can redistribute it and/or modify it under the terms of the GNU General Public License as published by the Free Software Foundation; either version 2 of the License, or (at your option) any later version.

This program is distributed in the hope that it will be useful, but WITHOUT ANY WARRANTY; without even the implied warranty of MERCHANTABILITY or FITNESS FOR A PARTICULAR PURPOSE. See the GNU General Public License for more details.

You should have received a copy of the GNU General Public License along with this program; if not, write to the Free Software Foundation, Inc., 59 Temple Place, Suite 330, Boston, MA 02111-1307 USA

Also add information on how to contact you by electronic and paper mail. If the program is interactive, make it output a short notice like this when it starts in an interactive mode:

Gnomovision version 69, Copyright © 19yy name of author Gnomovision comes with ABSOLUTELY NO WARRANTY; for details type `show w'. This is free software, and you are welcome to redistribute it under certain conditions; type `show c' for details.

The hypothetical commands `show w' and `show c' should show the appropriate parts of the General Public License. Of course, the commands you use may be called something other than `show w' and `show c'; they could even be mouse-clicks or menu items – whatever suits your program. You should also get your employer (if you work as a programmer) or your school, if any, to sign a "copyright disclaimer" for the program; if necessary. Here is a sample; alter the names:

Yoyodyne, Inc., hereby disclaims all copyright interest in the program `Gnomovision' (which makes passes at compilers) written by James Hacker.

<signature of Ty Coon>, 1 April 1989 Ty Coon, President of Vice

This General Public License does not permit incorporating your program into proprietary programs. If your program is a subroutine library, you may consider it more useful to permit linking proprietary applications with the library. If this is what you want to do, use the GNU Library General Public License instead of this License.

## Exhibit B

### GNU LESSER GENERAL PUBLIC LICENSE Version 2.1, February 1999

Copyright ©1991, 1999 Free Software Foundation, Inc. 59 Temple Place, Suite 330, Boston, MA 02111-1307 USA Everyone is permitted to copy and distribute verbatim copies of this license document, but changing it is not allowed.

[This is the first released version of the Lesser GPL. It also counts as the successor of the GNU Library Public License, version 2, hence the version number 2.1.]

#### Preamble

The licenses for most software are designed to take away your freedom to share and change it. By contrast, the GNU General Public Licenses are intended to guarantee your freedom to share and change free software – to make sure the software is free for all its users.

This license, the Lesser General Public License, applies to some specially designated software packages – typically libraries – of the Free Software Foundation and other

authors who decide to use it. You can use it too, but we suggest you first think carefully about whether this license or the ordinary General Public License is the better strategy to use in any particular case, based on the explanations below.

When we speak of free software, we are referring to freedom of use, not price. Our General Public Licenses are designed to make sure that you have the freedom to distribute copies of free software (and charge for this service if you wish); that you receive source code or can get it if you want it; that you can change the software and use pieces of it in new free programs; and that you are informed that you can do these things.

To protect your rights, we need to make restrictions that forbid distributors to deny you these rights or to ask you to surrender these rights. These restrictions translate to certain responsibilities for you if you distribute copies of the library or if you modify it.

For example, if you distribute copies of the library, whether gratis or for a fee, you must give the recipients all the



# LICENSE INFORMATION ON THE SOFTWARE USED IN THIS HD DVD PLAYER

rights that we gave you. You must make sure that they, too, receive or can get the source code. If you link other code with the library, you must provide complete object files to the recipients, so that they can relink them with the library after making changes to the library and recompiling it. And you must show them these terms so they know their rights.

We protect your rights with a two-step method: (1) we copyright the library, and (2) we offer you this license, which gives you legal permission to copy, distribute and/or modify the library.

To protect each distributor, we want to make it very clear that there is no warranty for the free library. Also, if the library is modified by someone else and passed on, the recipients should know that what they have is not the original version, so that the original author's reputation will not be affected by problems that might be introduced by others.

Finally, software patents pose a constant threat to the existence of any free program. We wish to make sure that a company cannot effectively restrict the users of a free program by obtaining a restrictive license from a patent holder. Therefore, we insist that any patent license obtained for a version of the library must be consistent with the full freedom of use specified in this license.

Most GNU software, including some libraries, is covered by the ordinary GNU General Public License. This license, the GNU Lesser General Public License, applies to certain designated libraries, and is quite different from the ordinary General Public License. We use this license for certain libraries in order to permit linking those libraries into non-free programs.

When a program is linked with a library, whether statically or using a shared library, the combination of the two is legally speaking a combined work, a derivative of the original library. The ordinary General Public License therefore permits such linking only if the entire combination fits its criteria of freedom. The Lesser General Public License permits more lax criteria for linking other code with the library.

We call this license the "Lesser" General Public License because it does Less to protect the user's freedom than the ordinary General Public License. It also provides other free software developers Less of an advantage over competing non-free programs. These disadvantages are the reason we use the ordinary General Public License for many libraries. However, the Lesser license provides advantages in certain special circumstances.

For example, on rare occasions, there may be a special need to encourage the widest possible use of a certain library, so that it becomes a de-facto standard. To achieve this, non-free programs must be allowed to use the library. A more frequent case is that a free library does the same job as widely used non-free libraries. In this case, there is little to gain by limiting the free library to free software only, so we use the Lesser General Public License.

In other cases, permission to use a particular library in non-free programs enables a greater number of people to

use a large body of free software. For example, permission to use the GNU C Library in non-free programs enables many more people to use the whole GNU operating system, as well as its variant, the GNU/Linux operating system.

Although the Lesser General Public License is Less protective of the users' freedom, it does ensure that the user of a program that is linked with the Library has the freedom and the wherewithal to run that program using a modified version of the Library.

The precise terms and conditions for copying, distribution and modification follow. Pay close attention to the difference between a "work based on the library" and a "work that uses the library". The former contains code derived from the library, whereas the latter must be combined with the library in order to run.

## **GNU LESSER GENERAL PUBLIC LICENSE TERMS AND CONDITIONS FOR COPYING, DISTRIBUTION AND MODIFICATION**

**0.** This License Agreement applies to any software library or other program which contains a notice placed by the copyright holder or other authorized party saying it may be distributed under the terms of this Lesser General Public License (also called "this License"). Each licensee is addressed as "you".

A "library" means a collection of software functions and/or data prepared so as to be conveniently linked with application programs (which use some of those functions and data) to form executables.

The "Library", below, refers to any such software library or work which has been distributed under these terms. A "work based on the Library" means either the Library or any derivative work under copyright law: that is to say, a work containing the Library or a portion of it, either verbatim or with modifications and/or translated straightforwardly into another language. (Hereinafter, translation is included without limitation in the term "modification".)

"Source code" for a work means the preferred form of the work for making modifications to it. For a library, complete source code means all the source code for all modules it contains, plus any associated interface definition files, plus the scripts used to control compilation and installation of the library.

Activities other than copying, distribution and modification are not covered by this License; they are outside its scope. The act of running a program using the Library is not restricted, and output from such a program is covered only if its contents constitute a work based on the Library (independent of the use of the Library in a tool for writing it). Whether that is true depends on what the Library does and what the program that uses the Library does.

**1.** You may copy and distribute verbatim copies of the Library's complete source code as you receive it, in any medium, provided that you conspicuously and appropriately publish on each copy an appropriate copyright notice and disclaimer of warranty; keep intact all the notices that refer to this License and to the absence of any warranty; and distribute a copy of this License along with the Library.

# LICENSE INFORMATION ON THE SOFTWARE USED IN THIS HD DVD PLAYER

You may charge a fee for the physical act of transferring a copy, and you may at your option offer warranty protection in exchange for a fee.

**2.** You may modify your copy or copies of the Library or any portion of it, thus forming a work based on the Library, and copy and distribute such modifications or work under the terms of Section 1 above, provided that you also meet all of these conditions:

- a) The modified work must itself be a software library.
- b) You must cause the files modified to carry prominent notices stating that you changed the files and the date of any change.
- c) You must cause the whole of the work to be licensed at no charge to all third parties under the terms of this License.
- d) If a facility in the modified Library refers to a function or a table of data to be supplied by an application program that uses the facility, other than as an argument passed when the facility is invoked, then you must make a good faith effort to ensure that, in the event an application does not supply such function or table, the facility still operates, and performs whatever part of its purpose remains meaningful.

(For example, a function in a library to compute square roots has a purpose that is entirely well-defined independent of the application. Therefore, Subsection 2d requires that any application supplied function or table used by this function must be optional: if the application does not supply it, the square root function must still compute square roots.)

These requirements apply to the modified work as a whole. If identifiable sections of that work are not derived from the Library, and can be reasonably considered independent and separate works in themselves, then this License, and its terms, do not apply to those sections when you distribute them as separate works. But when you distribute the same sections as part of a whole which is a work based on the Library, the distribution of the whole must be on the terms of this License, whose permissions for other licensees extend to the entire whole, and thus to each and every part regardless of who wrote it.

Thus, it is not the intent of this section to claim rights or contest your rights to work written entirely by you; rather, the intent is to exercise the right to control the distribution of derivative or collective works based on the Library.

In addition, mere aggregation of another work not based on the Library with the Library (or with a work based on the Library) on a volume of a storage or distribution medium does not bring the other work under the scope of this License.

**3.** You may opt to apply the terms of the ordinary GNU General Public License instead of this License to a given copy of the Library. To do this, you must alter all the notices that refer to this License, so that they refer to the ordinary GNU General Public License, version 2, instead of to this License. (If a newer version than version 2 of the ordinary GNU General Public License has appeared, then you can specify that version instead if you wish.) Do

not make any other change in these notices.

Once this change is made in a given copy, it is irreversible for that copy, so the ordinary GNU General Public License applies to all subsequent copies and derivative works made from that copy.

This option is useful when you wish to copy part of the code of the Library into a program that is not a library.

**4.** You may copy and distribute the Library (or a portion or derivative of it, under Section 2) in object code or executable form under the terms of Sections 1 and 2 above provided that you accompany it with the complete corresponding machine-readable source code, which must be distributed under the terms of Sections 1 and 2 above on a medium customarily used for software interchange.

If distribution of object code is made by offering access to copy from a designated place, then offering equivalent access to copy the source code from the same place satisfies the requirement to distribute the source code, even though third parties are not compelled to copy the source along with the object code.

**5.** A program that contains no derivative of any portion of the Library, but is designed to work with the Library by being compiled or linked with it, is called a "work that uses the Library". Such a work, in isolation, is not a derivative work of the Library, and therefore falls outside the scope of this License.

However, linking a "work that uses the Library" with the Library creates an executable that is a derivative of the Library (because it contains portions of the Library), rather than a "work that uses the library". The executable is therefore covered by this License. Section 6 states terms for distribution of such executables.

When a "work that uses the Library" uses material from a header file that is part of the Library, the object code for the work may be a derivative work of the Library even though the source code is not. Whether this is true is especially significant if the work can be linked without the Library, or if the work is itself a library. The threshold for this to be true is not precisely defined by law.

If such an object file uses only numerical parameters, data structure layouts and accessors, and small macros and small inline functions (ten lines or less in length), then the use of the object file is unrestricted, regardless of whether it is legally a derivative work. (Executables containing this object code plus portions of the Library will still fall under Section 6.)

Otherwise, if the work is a derivative of the Library, you may distribute the object code for the work under the terms of Section 6. Any executables containing that work also fall under Section 6, whether or not they are linked directly with the Library itself.

**6.** As an exception to the Sections above, you may also combine or link a "work that uses the Library" with the Library to produce a work containing portions of the Library, and distribute that work under terms of your choice, provided that the terms permit modification of the work for the customer's own use and reverse engineering for debugging such modifications.

# LICENSE INFORMATION ON THE SOFTWARE USED IN THIS HD DVD PLAYER

You must give prominent notice with each copy of the work that the Library is used in it and that the Library and its use are covered by this License. You must supply a copy of this License. If the work during execution displays copyright notices, you must include the copyright notice for the Library among them, as well as a reference directing the user to the copy of this License. Also, you must do one of these things:

- a) Accompany the work with the complete corresponding machine-readable source code for the Library including whatever changes were used in the work (which must be distributed under Sections 1 and 2 above); and, if the work is an executable linked with the Library, with the complete machine-readable "work that uses the Library", as object code and/or source code, so that the user can modify the Library and then relink to produce a modified executable containing the modified Library. (It is understood that the user who changes the contents of definitions files in the Library will not necessarily be able to recompile the application to use the modified definitions.)
- b) Use a suitable shared library mechanism for linking with the Library. A suitable mechanism is one that (1) uses at run time a copy of the library already present on the user's computer system, rather than copying library functions into the executable, and (2) will operate properly with a modified version of the library, if the user installs one, as long as the modified version is interface-compatible with the version that the work was made with.
- c) Accompany the work with a written offer, valid for at least three years, to give the same user the materials specified in Subsection 6a, above, for a charge no more than the cost of performing this distribution.
- d) If distribution of the work is made by offering access to copy from a designated place, offer equivalent access to copy the above specified materials from the same place.
- e) Verify that the user has already received a copy of these materials or that you have already sent this user a copy.

For an executable, the required form of the "work that uses the Library" must include any data and utility programs needed for reproducing the executable from it. However, as a special exception, the materials to be distributed need not include anything that is normally distributed (in either source or binary form) with the major components (compiler, kernel, and so on) of the operating system on which the executable runs, unless that component itself accompanies the executable.

It may happen that this requirement contradicts the license restrictions of other proprietary libraries that do not normally accompany the operating system. Such a contradiction means you cannot use both them and the Library together in an executable that you distribute.

7. You may place library facilities that are a work based on the Library side-by-side in a single library together with other library facilities not covered by this License, and

distribute such a combined library, provided that the separate distribution of the work based on the Library and of the other library facilities is otherwise permitted, and provided that you do these two things:

- a) Accompany the combined library with a copy of the same work based on the Library, uncombined with any other library facilities. This must be distributed under the terms of the Sections above.
- b) Give prominent notice with the combined library of the fact that part of it is a work based on the Library, and explaining where to find the accompanying uncombined form of the same work.

8. You may not copy, modify, sublicense, link with, or distribute the Library except as expressly provided under this License. Any attempt otherwise to copy, modify, sublicense, link with, or distribute the Library is void, and will automatically terminate your rights under this License. However, parties who have received copies, or rights, from you under this License will not have their licenses terminated so long as such parties remain in full compliance.

9. You are not required to accept this License, since you have not signed it. However, nothing else grants you permission to modify or distribute the Library or its derivative works. These actions are prohibited by law if you do not accept this License. Therefore, by modifying or distributing the Library (or any work based on the Library), you indicate your acceptance of this License to do so, and all its terms and conditions for copying, distributing or modifying the Library or works based on it.

10. Each time you redistribute the Library (or any work based on the Library), the recipient automatically receives a license from the original licensor to copy, distribute, link with or modify the Library subject to these terms and conditions. You may not impose any further restrictions on the recipients' exercise of the rights granted herein. You are not responsible for enforcing compliance by third parties with this License.

11. If, as a consequence of a court judgment or allegation of patent infringement or for any other reason (not limited to patent issues), conditions are imposed on you (whether by court order, agreement or otherwise) that contradict the conditions of this License, they do not excuse you from the conditions of this License. If you cannot distribute so as to satisfy simultaneously your obligations under this License and any other pertinent obligations, then as a consequence you may not distribute the Library at all. For example, if a patent license would not permit royalty-free redistribution of the Library by all those who receive copies directly or indirectly through you, then the only way you could satisfy both it and this License would be to refrain entirely from distribution of the Library.

If any portion of this section is held invalid or unenforceable under any particular circumstance, the balance of the section is intended to apply, and the section as a whole is intended to apply in other circumstances.

It is not the purpose of this section to induce you to infringe any patents or other property right claims or to

# LICENSE INFORMATION ON THE SOFTWARE USED IN THIS HD DVD PLAYER

contest validity of any such claims; this section has the sole purpose of protecting the integrity of the free software distribution system which is implemented by public license practices. Many people have made generous contributions to the wide range of software distributed through that system in reliance on consistent application of that system; it is up to the author/donor to decide if he or she is willing to distribute software through any other system and a licensee cannot impose that choice. This section is intended to make thoroughly clear what is believed to be a consequence of the rest of this License.

**12.** If the distribution and/or use of the Library is restricted in certain countries either by patents or by copyrighted interfaces, the original copyright holder who places the Library under this License may add an explicit geographical distribution limitation excluding those countries, so that distribution is permitted only in or among countries not thus excluded. In such case, this License incorporates the limitation as if written in the body of this License.

**13.** The Free Software Foundation may publish revised and/or new versions of the Lesser General Public License from time to time. Such new versions will be similar in spirit to the present version, but may differ in detail to address new problems or concerns. Each version is given a distinguishing version number. If the Library specifies a version number of this License which applies to it and "any later version", you have the option of following the terms and conditions either of that version or of any later version published by the Free Software Foundation. If the Library does not specify a license version number, you may choose any version ever published by the Free Software Foundation.

**14.** If you wish to incorporate parts of the Library into other free programs whose distribution conditions are incompatible with these, write to the author to ask for permission. For software which is copyrighted by the Free Software Foundation, write to the Free Software Foundation; we sometimes make exceptions for this. Our decision will be guided by the two goals of preserving the free status of all derivatives of our free software and of promoting the sharing and reuse of software generally.

## NO WARRANTY

**15.** BECAUSE THE LIBRARY IS LICENSED FREE OF CHARGE, THERE IS NO WARRANTY FOR THE LIBRARY, TO THE EXTENT PERMITTED BY APPLICABLE LAW. EXCEPT WHEN OTHERWISE STATED IN WRITING THE COPYRIGHT HOLDERS AND/ OR OTHER PARTIES PROVIDE THE LIBRARY "AS IS" WITHOUT WARRANTY OF ANY KIND, EITHER EXPRESSED OR IMPLIED, INCLUDING, BUT NOT LIMITED TO, THE IMPLIED WARRANTIES OF MERCHANTABILITY AND FITNESS FOR A PARTICULAR PURPOSE. THE ENTIRE RISK AS TO THE QUALITY AND PERFORMANCE OF THE LIBRARY IS WITH YOU. SHOULD THE LIBRARY PROVE DEFECTIVE, YOU ASSUME THE COST OF ALL NECESSARY SERVICING, REPAIR OR CORRECTION.

**16.** IN NO EVENT UNLESS REQUIRED BY APPLICABLE LAW OR AGREED TO IN WRITING WILL ANY COPYRIGHT

HOLDER, OR ANY OTHER PARTY WHO MAY MODIFY AND/OR REDISTRIBUTE THE LIBRARY AS PERMITTED ABOVE, BE LIABLE TO YOU FOR DAMAGES, INCLUDING ANY GENERAL, SPECIAL, INCIDENTAL OR CONSEQUENTIAL DAMAGES ARISING OUT OF THE USE OR INABILITY TO USE THE LIBRARY (INCLUDING BUT NOT LIMITED TO LOSS OF DATA OR DATA BEING RENDERED INACCURATE OR LOSSES SUSTAINED BY YOU OR THIRD PARTIES OR A FAILURE OF THE LIBRARY TO OPERATE WITH ANY OTHER SOFTWARE), EVEN IF SUCH HOLDER OR OTHER PARTY HAS BEEN ADVISED OF THE POSSIBILITY OF SUCH DAMAGES.

## END OF TERMS AND CONDITIONS

How to Apply These Terms to Your New Libraries

If you develop a new library, and you want it to be of the greatest possible use to the public, we recommend making it free software that everyone can redistribute and change. You can do so by permitting redistribution under these terms (or, alternatively, under the terms of the ordinary General Public License).

To apply these terms, attach the following notices to the library. It is safest to attach them to the start of each source file to most effectively convey the exclusion of warranty; and each file should have at least the "copyright" line and a pointer to where the full notice is found.

<one line to give the library's name and a brief idea of what it does.>

Copyright © <year> <name of author>

This library is free software; you can redistribute it and/ or modify it under the terms of the GNU Lesser General Public License as published by the Free Software Foundation; either version 2 of the License, or (at your option) any later version.

This library is distributed in the hope that it will be useful, but WITHOUT ANY WARRANTY; without even the implied warranty of MERCHANTABILITY or FITNESS FOR A PARTICULAR PURPOSE. See the GNU Lesser General Public License for more details.

You should have received a copy of the GNU Lesser General Public License along with this library; if not, write to the Free Software Foundation, Inc., 59 Temple Place, Suite 330, Boston, MA 02111-1307 USA

Also add information on how to contact you by electronic and paper mail.

You should also get your employer (if you work as a programmer) or your school, if any, to sign a "copyright disclaimer" for the library, if necessary. Here is a sample; alter the names: Yoyodyne, Inc., hereby disclaims all copyright interest in the library 'Frob' (a library for tweaking knobs) written by James Random Hacker.

<signature of Ty Coon>, 1 April 1990

Ty Coon, President of Vice

That's all there is to it!

# LICENSE INFORMATION ON THE SOFTWARE USED IN THIS HD DVD PLAYER

## Exhibit C

### LICENSE ISSUES

The OpenSSL toolkit stays under a dual license, i.e. both the conditions of the OpenSSL License and the original SSLeay license apply to the toolkit.

See below for the actual license texts. Actually both licenses are BSD-style Open Source licenses. In case of any license issues related to OpenSSL please contact openssl-core@openssl.org.

#### OpenSSL License

Copyright © 1998-2002 The OpenSSL Project. All rights reserved.

Redistribution and use in source and binary forms, with or without modification, are permitted provided that the following conditions are met:

1. Redistributions of source code must retain the above copyright notice, this list of conditions and the following disclaimer.
2. Redistributions in binary form must reproduce the above copyright notice, this list of conditions and the following disclaimer in the documentation and/or other materials provided with the distribution.
3. All advertising materials mentioning features or use of this software must display the following acknowledgment: "This product includes software developed by the OpenSSL Project for use in the OpenSSL Toolkit. (<http://www.openssl.org/>)"
4. The names "OpenSSL Toolkit" and "OpenSSL Project" must not be used to endorse or promote products derived from this software without prior written permission. For written permission, please contact openssl-core@openssl.org.
5. Products derived from this software may not be called "OpenSSL" nor may "OpenSSL" appear in their names without prior written permission of the OpenSSL Project.
6. Redistributions of any form whatsoever must retain the following acknowledgment: "This product includes software developed by the OpenSSL Project for use in the OpenSSL Toolkit (<http://www.openssl.org/>)"

THIS SOFTWARE IS PROVIDED BY THE OpenSSL PROJECT "AS IS" AND ANY EXPRESSED OR IMPLIED WARRANTIES, INCLUDING, BUT NOT LIMITED TO, THE IMPLIED WARRANTIES OF MERCHANTABILITY AND FITNESS FOR A PARTICULAR PURPOSE ARE DISCLAIMED. IN NO EVENT SHALL THE OpenSSL PROJECT OR ITS CONTRIBUTORS BE LIABLE FOR ANY DIRECT, INDIRECT, INCIDENTAL, SPECIAL, EXEMPLARY, OR CONSEQUENTIAL DAMAGES (INCLUDING, BUT NOT LIMITED TO, PROCUREMENT OF SUBSTITUTE GOODS OR SERVICES; LOSS OF USE, DATA, OR PROFITS; OR BUSINESS INTERRUPTION) HOWEVER CAUSED AND ON ANY THEORY OF LIABILITY, WHETHER IN CONTRACT, STRICT LIABILITY, OR TORT (INCLUDING NEGLIGENCE OR OTHERWISE) ARISING IN ANY WAY OUT OF THE USE OF THIS SOFTWARE, EVEN IF ADVISED OF THE POSSIBILITY OF SUCH DAMAGE.

This product includes cryptographic software written by Eric Young ([ey@cryptsoft.com](mailto:ey@cryptsoft.com)). This product includes software written by Tim Hudson ([tjh@cryptsoft.com](mailto:tjh@cryptsoft.com)).

#### Original SSLeay License

Copyright ©1995-1998 Eric Young ([ey@cryptsoft.com](mailto:ey@cryptsoft.com)) All rights reserved.

This package is an SSL implementation written by Eric Young ([ey@cryptsoft.com](mailto:ey@cryptsoft.com)).

The implementation was written so as to conform with Netscapes SSL.

This library is free for commercial and non-commercial use as long as the following conditions are aheared to. The following conditions apply to all code found in this distribution, be it the RC4, RSA, lhash, DES, etc., code; not just the SSL code. The SSL documentation included with this distribution is covered by the same copyright terms except that the holder is Tim Hudson ([tjh@cryptsoft.com](mailto:tjh@cryptsoft.com)).

Copyright remains Eric Young's, and as such any Copyright notices in the code are not to be removed.

If this package is used in a product, Eric Young should be given attribution as the author of the parts of the library used. This can be in the form of a textual message at program startup or in documentation (online or textual) provided with the package.

Redistribution and use in source and binary forms, with or without modification, are permitted provided that the following conditions are met:

1. Redistributions of source code must retain the copyright notice, this list of conditions and the following disclaimer.
  2. Redistributions in binary form must reproduce the above copyright notice, this list of conditions and the following disclaimer in the documentation and/or other materials provided with the distribution.
  3. All advertising materials mentioning features or use of this software must display the following acknowledgement: "This product includes cryptographic software written by Eric Young ([ey@cryptsoft.com](mailto:ey@cryptsoft.com))"
- The word 'cryptographic' can be left out if the rouines from the library being used are not cryptographic related :-).
4. If you include any Windows specific code (or a derivative thereof) from the apps directory (application code) you must include an acknowledgement: "This product includes software written by Tim Hudson ([tjh@cryptsoft.com](mailto:tjh@cryptsoft.com))"

THIS SOFTWARE IS PROVIDED BY ERIC YOUNG "AS IS" AND ANY EXPRESS OR IMPLIED WARRANTIES, INCLUDING, BUT NOT LIMITED TO, THE IMPLIED WARRANTIES OF MERCHANTABILITY AND FITNESS FOR A PARTICULAR PURPOSE ARE DISCLAIMED. IN NO EVENT SHALL THE AUTHOR OR CONTRIBUTORS BE LIABLE FOR ANY DIRECT, INDIRECT, INCIDENTAL, SPECIAL, EXEMPLARY, OR CONSEQUENTIAL DAMAGES (INCLUDING, BUT NOT LIMITED TO, PROCUREMENT OF SUBSTITUTE GOODS OR SERVICES; LOSS OF USE, DATA, OR PROFITS; OR BUSINESS INTERRUPTION) HOWEVER CAUSED AND ON ANY THEORY OF LIABILITY, WHETHER IN CONTRACT, STRICT LIABILITY, OR TORT (INCLUDING NEGLIGENCE OR OTHERWISE) ARISING IN ANY WAY OUT OF THE USE OF THIS SOFTWARE, EVEN IF ADVISED OF THE POSSIBILITY OF SUCH DAMAGE.

The licence and distribution terms for any publically available version or derivative of this code cannot be changed. i.e. this code cannot simply be copied and put under another distribution licence [including the GNU Public Licence.]

# LICENSE INFORMATION ON THE SOFTWARE USED IN THIS HD DVD PLAYER

## **Exhibit D**

Portions of this software are copyright © 2005 The FreeType Project ([www.freetype.org](http://www.freetype.org)). All rights reserved.

- This product includes software developed by the OpenSSL project.
- Reverse engineering, disassembling, decompiling, dismantling, or otherwise attempting to analyze or modify the software included in this product is prohibited.

# MAINTENANCE

## ***Cleaning the Disc***

A defective or soiled disc inserted into the unit can cause sound to drop out during playback. Handle the disc by holding its inner and outer edges.

- Do NOT touch the surface of the unlabeled side of the disc.
- Do NOT stick paper or tape on the surface.
- Do NOT expose the disc to direct sunlight or excessive heat.
- Clean the disc before playback. Wipe the disc from the center outward with a cleaning cloth.
- NEVER use solvents such as benzene or alcohol to clean the disc.
- Do NOT use irregular shaped discs (example: heart shaped, octagonal, etc.). They may cause malfunctions.

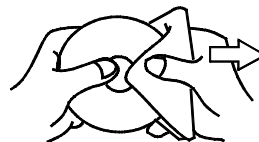

## ***Cleaning the Unit***

- Be sure to turn the unit off and disconnect the AC power cord before cleaning the unit.
- Wipe the unit with a dry soft cloth. If the surfaces are extremely dirty, wipe clean with a cloth that has been dipped in a weak soap-and-water solution and wrung out thoroughly. Then wipe with a dry cloth.
- Never use alcohol, benzene, thinner, cleaning fluid or other chemicals. Do NOT use compressed air to remove dust.

## ***Important Note***

Before transporting the unit, remove the disc from the disc compartment.

# SPECIFICATIONS

Power source:

AC 120V ~ 60Hz

**Specifications and external appearance are subject to change without notice.**

Printed in China  
811-HD7091W011



## Free Manuals Download Website

<http://myh66.com>

<http://usermanuals.us>

<http://www.somanuals.com>

<http://www.4manuals.cc>

<http://www.manual-lib.com>

<http://www.404manual.com>

<http://www.luxmanual.com>

<http://aubethermostatmanual.com>

Golf course search by state

<http://golfingnear.com>

Email search by domain

<http://emailbydomain.com>

Auto manuals search

<http://auto.somanuals.com>

TV manuals search

<http://tv.somanuals.com>