

Digital Picture Frame

with **128MB**
Internal Memory

Operating Instructions

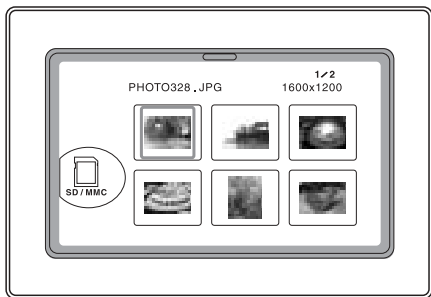

VPF810DL-CHER
VPF1010DL-BRW / VPF1010DL-BLK

Need More Help?

DO NOT RETURN THIS PRODUCT TO THE STORE

Please visit online help at <http://www.1800customersupport.com/V7>

SAFETY PRECAUTIONS



 The lightning flash with an arrowhead symbol, within the equilateral triangle, is intended to alert the user to the presence of uninsulated "dangerous voltage" within the product's enclosure that may be of sufficient magnitude to cause an electric shock.

CAUTION: TO REDUCE THE RISK OF ELECTRIC SHOCK, DO NOT REMOVE COVER (OR BACK). NO USER-SERVICEABLE PARTS INSIDE. REFER SERVICING TO QUALIFIED SERVICE PERSONNEL.

 The exclamation point within the equilateral triangle is intended to alert the user to the presence of important operating and maintenance (servicing) instructions in this owner's manual.

WARNING

TO PREVENT FIRE OR SHOCK HAZARD, DO NOT EXPOSE THIS APPLIANCE TO RAIN OR MOISTURE. DO NOT PLACE OBJECTS FILLED WITH LIQUIDS ON OR NEAR THIS UNIT.

On Placement

- Do not use the unit in places that are extremely hot, cold, dusty or humid.
- Do not restrict the airflow of the unit by placing it in a place with poor airflow, by covering it with a cloth, or by placing it on carpeting.
- Keep the stand of the unit clear from cables. Cables could pull the unit to the floor.
- The unit should not be exposed to excessive heat such as sunshine, fire or the like.

On Safety

- When connecting or disconnecting the AC power adapter, grip the plug and not the cord itself. Pulling the cord may damage it and create a hazard.
- When you are not going to use the unit for a long period, disconnect the AC power adapter.

Temperature and Humidity Limitations

- Operating temperature: 0°C ~ 45°C (32°F ~ 113°F)
- Humidity: 20% ~ 80%

Rating Plate Location

- The rating plate is located on the back of the unit.



WARNING: Should any trouble occur, disconnect the AC power adapter and refer servicing to a qualified technician.



Stop the unit before connecting or disconnecting a memory card or USB flash drive. Do NOT connect or disconnect external equipment when the unit is playing, copying or deleting files.



"⊗" may appear on the screen during operation. A "⊗" means that the desired operation is not permitted by the unit.

IMPORTANT SAFETY INSTRUCTIONS

1. Read these instructions.
2. Keep these instructions.
3. Heed all warnings.
4. Follow all instructions.
5. Do not use this apparatus near water.
6. Clean only with a dry cloth.
7. Do not block any of the ventilation openings. Install in accordance with the manufacturer's instructions.
8. Do not install near any heat sources such as radiators, heat registers, stoves, or other apparatus (including amplifiers) that produce heat.
9. Do not defeat the safety purpose of the polarized or grounding-type plug. A polarized plug has two blades with one wider than the other. A grounding type plug has two blades and a third grounding prong. The wide blade or the third prong is provided for your safety. When the provided plug does not fit into your outlet, consult an electrician for replacement of the obsolete outlet.
10. Protect the power cord from being walked on or pinched particularly at plugs, convenience receptacles, and the point where they exit from the apparatus.
11. Only use attachments/accessories specified by the manufacturer.
12. Use only with a cart, stand, tripod, bracket, or table specified by the manufacturer, or sold with the apparatus. When a cart is used, use caution when moving the cart/apparatus combination to avoid injury from tip-over.
13. Unplug this apparatus during lightning storms or when unused for long periods.
14. Refer all servicing to qualified service personnel. Servicing is required when the apparatus has been damaged in any way, such as the power-supply cord or plug is damaged, liquid has spilled or objects have fallen into the apparatus, the apparatus has been exposed to rain or moisture, does not operate normally, or has been dropped.



Portable
Cart Warning

FCC Statements

This device complies with the Part 15 of the FCC rules. Operation is subject to the following two conditions:

- (1) This device may not cause harmful interference, and
- (2) This device must accept any interference received, including interference that may cause undesirable operation.

NOTE: This equipment has been tested and found to comply with the limits for a Class B digital device, pursuant to Part 15 of the FCC Rules. These limits are designed to provide reasonable protection against harmful interference in a residential installation. This equipment generates, uses and can radiate radio frequency energy and, if not installed and used in accordance with the instructions, may cause harmful interference to radio communications.

However, there is no guarantee that interference will not occur in a particular installation. If this equipment does cause harmful interference to radio or television reception, which can be determined by turning the equipment off and on, the user is encouraged to try to correct the interference by one or more of the following measures:

- Reorient or relocate the receiving antenna.
- Increase the separation between the equipment and receiver.
- Connect the equipment into an AC power outlet on a circuit different from that to which the receiver is connected.
- Consult the dealer or an experienced radio/TV technician for help.

Warning: Changes or modifications to this unit not expressly approved by the party responsible for compliance could void the user's authority to operate the equipment.

THIS CLASS B DIGITAL APPARATUS COMPLIES WITH CANADIAN ICES-003.

QUICK START GUIDE

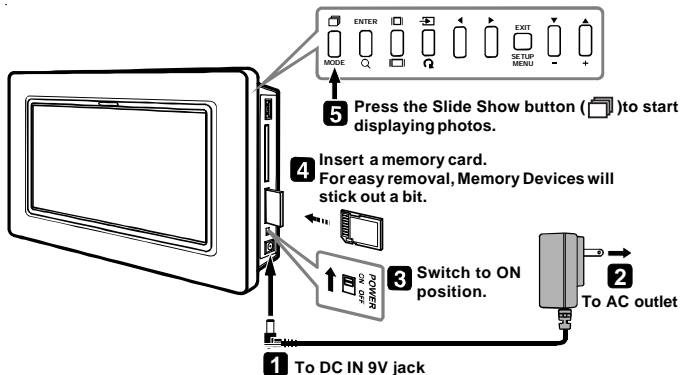

TABLE OF CONTENTS

<i>Safety Precautions</i>	2	<i>Photo Viewing Setup Menu</i>	12
<i>Important Safety Instructions</i>	3	Full Screen	12
<i>Quick Start Guide</i>	4	Photo Slide Show Effect	12
<i>Table of Contents</i>	4	Photo Slide Show Speed	12
<i>Accessories</i>	5	On-screen Language	12
<i>Remote Control</i>	5	<i>Listening to Music</i>	13
<i>Control Reference Guide</i>	6	Listening to Music	13
<i>Control Function & Display Icon</i> ...	7	Music Repeat	13
<i>Installation</i>	8	<i>Watching Video Files</i>	14
Using the Stand	8	Watching Video Files	14
Mounting on the Wall	8	Video Repeat	14
<i>Power Supply</i>	9	<i>Copying / Deleting Media Files</i> ...	15
<i>Inserting Memory Devices</i>	10	Copying Files	15
<i>Viewing Photos</i>	11	Deleting Files	15
Viewing Photos Slide Show	11	<i>Troubleshooting Guide</i>	18
Viewing Photos	11	<i>Maintenance</i>	16
		Cleaning the Unit	16
		Cleaning the LCD Screen	16

ACCESSORIES

Please check and identify the supplied accessories.

• To order accessories visit web site (<http://www.1800customersupport.com/V7>)

- AC Power Adapter x 1
- Remote Control x 1

REMOTE CONTROL

Using the Remote Control

- Point the remote control at the REMOTE SENSOR located on the unit.
- When there is a strong ambient light source, the performance of the infrared REMOTE SENSOR may be degraded, causing unreliable operation.
- The recommended effective distance for remote operation is about 16 feet (5 meters).

Remove the plastic sheet before using the remote control.

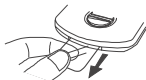

TO CHANGE REMOTE BATTERY

1. Open the battery door.



2. Insert one CR2025 (3V) size battery.



BATTERY REPLACEMENT

When the battery becomes weak, the operating distance of the remote control will be greatly reduced and you will need to replace the battery.

NOTE:

- If the remote control is not going to be used for a long time, remove the battery to avoid damage caused by battery leakage corrosion.



WARNING:

Do not dispose of the battery in a fire. It may leak and/or explode.

CAUTION:

Danger of explosion if battery is incorrectly replaced. Replace only with the same or equivalent type.

PLACEMENT

rear of the unit

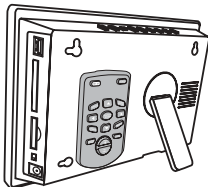



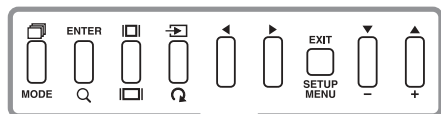



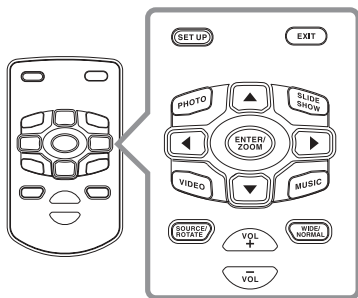
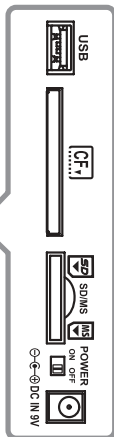
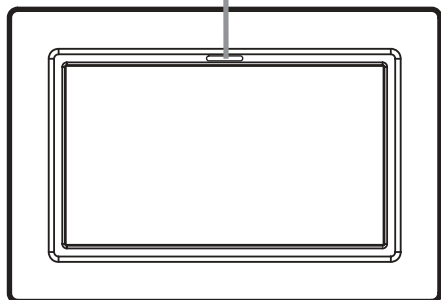





CONTROL REFERENCE GUIDE



Remote Sensor



CONTROL FUNCTION & DISPLAY ICON

Unit	Remote Control	Function
	SLIDE SHOW	Display photo in a slide show
MODE		Selects Photo, Video or Audio playback mode.
ENTER	ENTER	Confirms the selection on the setup menu. Play/Pause/Resume playback in Photo/Video/Audio mode.
	ZOOM	Magnifies image in single photo mode.
	WIDE / NORMAL	Changes to original or full screen.
	SOURCE	Selects source to playback (Internal Memory, USB, CF, SD/MMC/MS Pro/xD).
	ROTATE	Rotates images in single photo mode.
		Selects the previous/next or left/right item.
EXIT	EXIT	Stops/returns to the previous menu/screen.
SETUP MENU	SET UP	Enter and exits the setup menu.
		Select the up/down item.
	VOL + / VOL -	Adjusts the volume level for audio and video files.
	PHOTO	Directly selects Photo playback mode.
	VIDEO	Directly selects Video playback mode.
	MUSIC	Directly selects Audio playback mode.
USB		USB Flash Drive Port
		Compact Flash card slot
		Secure Digital Card (SD), Multi Media Card (MMC), Memory Stick Pro (MS Pro) or Extreme Digital (xD) card slot
POWER		Turns on/off the unit.
DC IN 9V		Connect AC power adapter from DC jack to a power outlet.



Up



Invalid



Zoom in



Set up (Menu)



Video



Down



Play



Volume



Photo



Music



Left



Pause



Enter



Slide Show



Card



Right



Stop



Exit



Rotate



Internal Memory



USB Flash Drive



Compact Flash



Secure Digital Card
Multi Media Card



Extreme Digital



Memory Stick Pro

INSTALLATION

Using the Stand

The unit can be placed either horizontally or vertically to fit the photos on display.

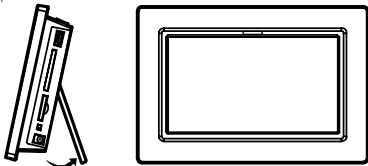

You can rotate the stand as shown below to stand the unit vertically.

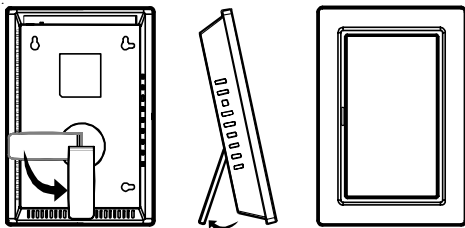

Mounting on the Wall

The unit can be mounted either horizontally or vertically on the wall by the mounting holes on the back of the unit.

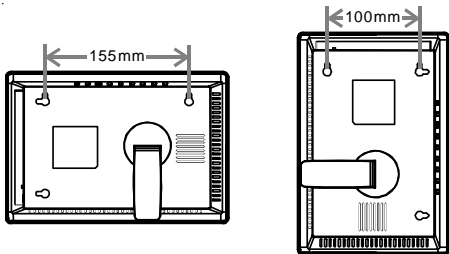



Caution:

- Mounting the unit requires special skills that should only be performed by qualified personnel. You should not attempt to do the work yourself.
- Make sure that the wall mount is being fixed securely enough so that it meets safety standards.

POWER SUPPLY

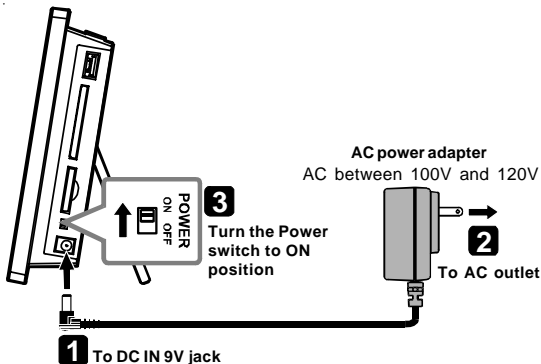
RIGHT SIDE OF UNIT



- After turning on the unit, if there is no memory card or USB flash drive connected to the unit, it will display media files stored on the internal memory () of the unit.
- When a memory card or/and USB flash drive is/are inserted, it will display media files from the recently connected media or device in a last-in, first-display order.
- You can press the **SOURCE** () button to switch among different Memory Devices.

Caution:

- The AC power adapter included with this unit is for its use only. Do not use it with other equipment.
- Turn off the unit before unplugging the AC power adapter from the unit to avoid the unit being damaged.
- When the unit is not going to be used for a long time, disconnect the AC power adapter from the AC power outlet.

Important:

- Be sure to use it near the wall outlet. If a malfunction occurs, disconnect the plug from the wall outlet at once.
- When the AC power adapter is plugged in, the apparatus is not completely disconnected from the main power source, even when the unit is turned off.

Warning:

The AC power adapter is used as the disconnect device. It shall remain readily operable and should not be obstructed during intended use. To completely disconnect the apparatus from the main power supply, the AC power adapter of the apparatus should be disconnected from the AC power outlet completely.

INSERTING MEMORY DEVICES



Stop the unit before connecting or disconnecting a memory card or USB flash drive. Do NOT connect or disconnect external equipment when the unit is playing, coping or deleting files.

The unit is compatible with the following Memory Devices (sources):

- USB Flash Drive
- Compact Flash (CF)
- Secure Digital Card (SD)
- Multi Media Card (MMC)
- Memory Stick Pro (MS Pro)
- Extreme Digital (xD)

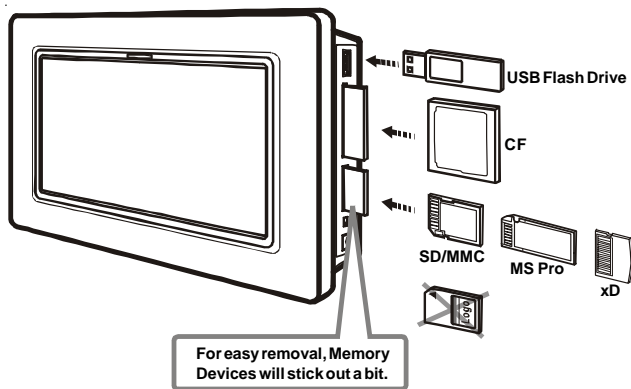



Note:



- You can insert one USB flash drive, one CF card and one SD/MMC/MS Pro/xD card at the same time. Select different source by pressing the **SOURCE** () button in stop mode.
- If you cannot easily insert the memory card, you may have inserted it incorrectly. Flip over the card and try again.
- It does not support a USB hard disk mass storage device, multi-card reader or other USB computer peripheral.
- Insert any compatible memory card/USB flash drive with the front label facing the rear of the product. Do not force the memory card into the memory card slot.

VIEWING PHOTOS

Slide Show

1. Press the **SOURCE** () button to select photo source.
2. Start slide show: press the **SLIDE SHOW** () button.
3. Stop slide show: press the **ENTER** or **EXIT** button.

Slide Show with Music background

1. Press the **SOURCE** () button to select music source.
 2. Press the **MUSIC** button to select music mode.
 3. Use the **▼ / ▲** buttons to highlight a music file, then press the **ENTER** button to start music playback.
 4. Press the **SLIDE SHOW** () button to enter slide show with the music background.
 5. Stop slide show: press the **ENTER** or **EXIT** button.
- Press the **- VOL +** buttons to adjust volume.
 - You can only playback music and photos storing on same Memory Device only.

Viewing Photos

1. Press the **SOURCE** () button to select photo source.

Thumbnail screen

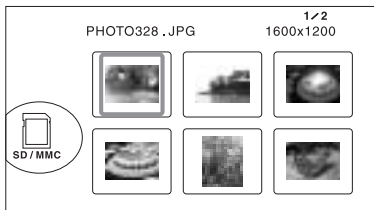

Note:
JPEG and BMP photos
are supported.





2. Use the **◀ / ▶ / ▼ / ▲** buttons to select the photo, then press the **ENTER** button to playback the photo.
 3. Press the **EXIT** button to return to thumbnail display.
- Press the **WIDE / NORMAL** () button to change screen size between full screen or original screen.
 - Press the **ROTATE** () button to rotate the photo by 90°
 - Press the **ZOOM** () button to enlarge in the photo.

PHOTO VIEWING SETUP MENU

1. Press the **EXIT** button to stop photo playback.
2. Press the **SETUP MENU** button to enter setup menu.
3. Use the **▼ / ▲** buttons to highlight your selection, then press the **ENTER** button to confirm.
4. Use the **▼ / ▲** buttons to select the options, press the **ENTER** button to confirm the selection.
5. Press the **EXIT** button to exit the setup menu.

Full Screen

This option allows you to choose how your photos fit on the display.

- On: to display photos in full screen automatically.
- Off: to display photos in its original aspect ratio.
- You can press the **WIDE/NORMAL** ( / ) button to change between full screen and original screen.

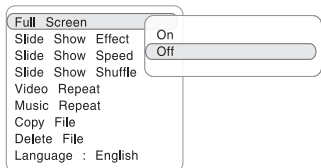

Slide Show Effect

This option allows you to choose the animation effect during slide show mode:

Off, Fade, Shutter, Cross Comb, Mask, Brick, Dissolve, Bar, Expansion or Random.

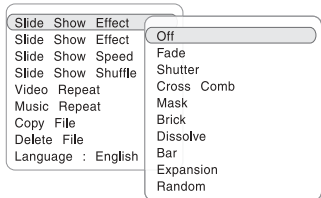

Slide Show Speed

This option allows you to choose the time elapsed between each photo during slide show playing.

You are able to set the slide show speed to: 3, 5, 10 or 20 seconds

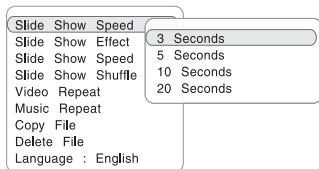

Slide Show Shuffle

This option allows you to choose the shuffle On or Off for slide show.

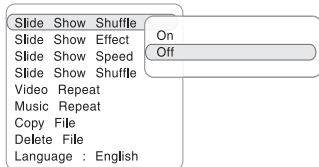

On-screen Language

Choose your preferred language.

You are able to set the language to: English, French, Spanish or German.

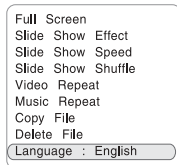

LISTENING TO MUSIC

Listening to Music

1. Press the **SOURCE** () button to select music source.
2. Press and hold (few seconds) the **MUSIC** button to select MUSIC mode.

Music files appear.

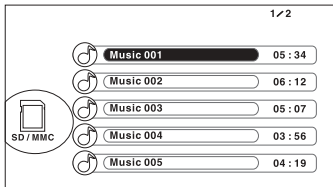

Note:

Support .mp3 music file.

3. Use the **▼ / ▲** buttons to highlight a music file, then press the **ENTER** button to start playback.

During music playback:

- Press the **◀ / ▶** buttons to perform fast forward/reverse.
- Press the **ENTER** button to pause playback, press the **ENTER** button again to resume playback.
- Press the **SLIDE SHOW** () button to enter photo slide show mode with the music background.
- Press the **PHOTO** button to enter photo mode with the music background.
- Press the **EXIT** button to stop music playback.
- Press the **SETUP MENU** button to enter setup menu. (In the setup menu, you can customize the settings, copy or delete files, etc.)

Music Repeat

1. Press the **EXIT** button to stop music playback.
2. Press the **SETUP MENU** button to enter setup menu.
3. Press the **▼ / ▲** buttons to highlight Music Repeat.
4. Press the **ENTER** button to display the selections.
5. Press the **▼ / ▲** buttons to highlight One, All or Off.
6. Press the **ENTER** button to confirm the selection.
7. Press the **EXIT** button to exit the setup menu.

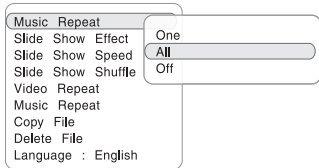

WATCHING VIDEO FILES

Watching Video Files

1. Press the **SOURCE** () button to select video source.
2. Press and hold (few seconds) the **VIDEO** button to select VIDEO mode.

Video files appear.

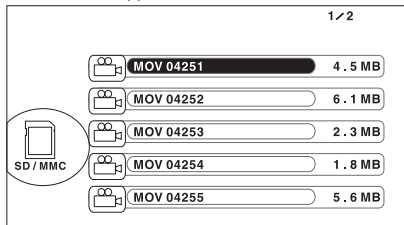

Note:

Support .avi video file.

3. Use the **▼** / **▲** buttons to highlight a video file you want to play, then press the **ENTER** button to start playback.

During video playback:

- Press the **◀** / **▶** buttons to perform fast forward/reverse.
- Press the **ENTER** button to pause playback, press the **ENTER** button again to resume playback.
- Press the **EXIT** button to stop video playback.
- Press the **SETUP MENU** button to enter setup menu. (In the setup menu, you can customize the settings, copy or delete files, etc...)

Video Repeat

1. Press the **EXIT** button to stop video playback.
2. Press the **SETUP MENU** button to enter setup menu.
3. Press the **▼** / **▲** buttons to highlight Video Repeat.
4. Press the **ENTER** button to display the selections.
5. Press the **▼** / **▲** buttons to highlight One, All or Off.
6. Press the **ENTER** button to confirm the selection.
7. Press the **EXIT** button to exit the setup menu.

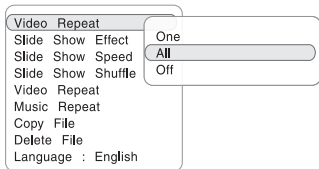

COPYING / DELETING MEDIA FILES

Copying Files

You can copy media files among the internal memory, memory card or USB device.

1. Press the **EXIT** button to stop photo, music or video playback.
2. Use the **▼**, **▲**, **◀**, **▶** buttons to highlight copy media file.
3. Press the **SETUP MENU** button to enter setup menu.
4. Press the **▼** / **▲** buttons to highlight Copy File.
5. Press the **ENTER** button to display the available device for copying file to (Make sure to connect the other memory card or USD device first.)
6. Press the **▼** / **▲** buttons to select an available device for coping file to, then press the **ENTER** button again to confirm the selection.
7. Press the **ENTER** button to confirm "Yes". The selected file will be copied to the internal memory. (If select "No", then press the **ENTER** button to abort copying.)
8. Repeat steps 2 - 7 to copy more files.
9. Press the **EXIT** button to exit the setup menu.

"To NAND" means copy file to the internal memory ().

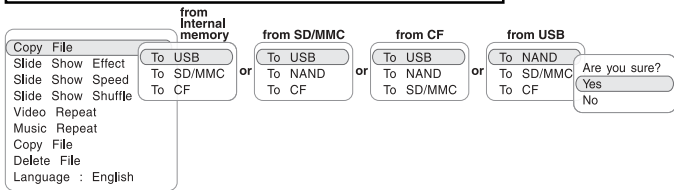

Note:

- When copying media files from other source to a memory card, make sure the memory card is not in writing-protect mode (or it is not locked).
- When copying files to the internal memory, if a warning message shows up indicating no free space for more media files, you may need to remove some already stored media files first before copying more media files. Please see the **Deleting Files** section below.

Deleting Files

1. Press the **EXIT** button to stop music, video playback or photo slide show.
2. Use the **▼**, **▲**, **◀**, **▶** buttons to highlight the media file that you want to delete.
3. Press the **SETUP MENU** button to enter setup menu.
4. Press the **▼** / **▲** buttons to highlight the File to be deleted.
5. Press the **ENTER** button to confirm. Then press the **ENTER** button again to confirm "Yes". The selected file will be deleted (or press the **▼** / **▲** buttons to select "No", and then press the **ENTER** button to abort deleting).
6. Repeat steps 2 - 5 to delete more files.
7. Press the **EXIT** button to exit the setup menu.

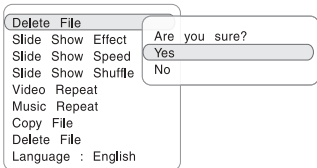

TROUBLESHOOTING GUIDE

SYMPTOM CAUSE (AND REMEDY)

- | | |
|----------------------------------|---|
| Screen freezes. | <ul style="list-style-type: none">• Turn off the unit and unplug the AC power adapter, then reinsert the AC power adapter and turn on the unit again. |
| No power. | <ul style="list-style-type: none">• Ensure that the AC power adapter is connected correctly. |
| Cannot read the memory card. | <ul style="list-style-type: none">• Ensure the memory card is not damaged.• Ensure the media files are under the root directory of the memory card.• Ensure the memory card is inserted to the unit correctly.• Pull out the memory card and insert it again. |
| Cannot read the USB flash drive. | <ul style="list-style-type: none">• Ensure the USB flash drive is not damaged.• Ensure the media files are under the root directory of the USB drive drive.• Ensure the USB flash drive is connected to the unit correctly.• Pull out the USB flash drive and insert it again. |
| Cannot play photos. | <ul style="list-style-type: none">• Ensure there are photos stored in the memory card / USB flash drive or internal memory.• The size of the photo is too large. |
| Photo display is not correct. | <ul style="list-style-type: none">• Press the WIDE / NORMAL button to adjust the screen aspect ratio. Many digital cameras take photos in 4:3 aspect ratio but some in 16:9 aspect ratio. Select a proper screen aspect ratio to view your photo. |

MAINTENANCE

Cleaning the Unit

- Be sure to turn off the unit, disconnect the power adapter and remove all external connections before cleaning the unit.
- Wipe the unit with a dry soft cloth. If the surfaces are extremely dirty, wipe clean with a cloth that has been dipped in a weak soap-and-water solution and wrung out thoroughly, then wipe with a dry cloth.
- Never use alcohol, benzene, thinner, cleaning fluid or other chemicals. Do NOT use compressed air to remove dust.

Cleaning the LCD Screen

- Be sure to turn off the unit, disconnect the power adapter and remove all external connections before cleaning the LCD screen.
- Take good care of the LCD screen. The LCD screen is made of glass and is sensitive to abnormal force or hardware with sharp edges.
- If fingerprints or dust accumulate on the LCD screen, use a soft, non-abrasive cloth (such as a camera lens cloth) to clean the LCD screen.
- If the LCD screen is extremely dirty, and you want to use the LCD Cleaning Kit sold at various retail outlets, do NOT apply the cleaning liquid directly to the LCD screen. Moisten the cleaning cloth with the cleaning solution and wring out thoroughly, then clean the LCD screen, and wipe with a dry cloth again.

Free Manuals Download Website

<http://myh66.com>

<http://usermanuals.us>

<http://www.somanuals.com>

<http://www.4manuals.cc>

<http://www.manual-lib.com>

<http://www.404manual.com>

<http://www.luxmanual.com>

<http://aubethermostatmanual.com>

Golf course search by state

<http://golfingnear.com>

Email search by domain

<http://emailbydomain.com>

Auto manuals search

<http://auto.somanuals.com>

TV manuals search

<http://tv.somanuals.com>