

VENTURER

PLV16198

19" Digital LCD TV

INSTRUCTION MANUAL

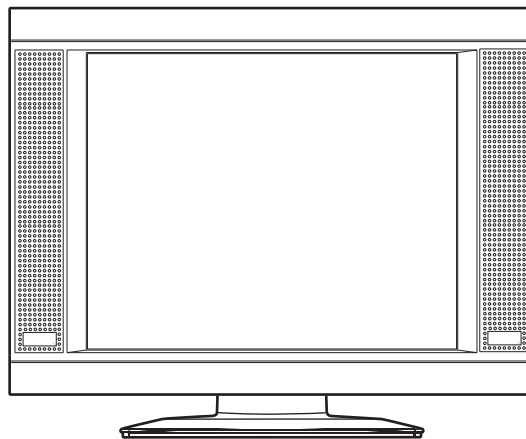

Need more Help?

DO NOT RETURN THIS PRODUCT TO THE STORE

Please visit online help at
<http://www.venturer.com>

SAFETY PRECAUTIONS



 The lightning flash with arrowhead symbol, within an equilateral triangle, is intended to alert the user to the presence of uninsulated "dangerous voltage" within the product's enclosure that may be of sufficient magnitude to constitute a risk of electric shock to persons.

 The exclamation point within an equilateral triangle is intended to alert the user to the presence of important operating and maintenance (servicing) instructions in the literature accompanying the appliance.

 The symbol for Class II (Double Insulation)

CAUTION:

- DANGER OF EXPLOSION IF BATTERY IS INCORRECTLY REPLACED. REPLACE ONLY WITH THE SAME OR EQUIVALENT TYPE.
- **TO PREVENT ELECTRIC SHOCK, MATCH WIDE BLADE OF PLUG TO WIDE SLOT OF WALL OUTLET, THEN FULLY INSERT.**
- USE OF CONTROLS OR ADJUSTMENTS OR PERFORMANCE OF PROCEDURES OTHER THAN THOSE SPECIFIED MAY RESULT IN HAZARDOUS RADIATION EXPOSURE.



WARNING:

- TO PREVENT FIRE OR SHOCK HAZARD, DO NOT EXPOSE THIS UNIT TO RAIN OR MOISTURE. DO NOT PLACE OBJECTS FILLED WITH LIQUIDS ON OR NEAR THIS UNIT.
- SHOULD ANY TROUBLE OCCUR, DISCONNECT THE AC POWER CORD AND REFER SERVICING TO A QUALIFIED TECHNICIAN.

PLACEMENT INFORMATION

- Do not use this unit in places that are extremely hot, cold, dusty or humid.
- Do not restrict the airflow of this unit by placing it somewhere with poor air flow, by covering it with a cloth, by placing it on bedding or carpeting.

SAFETY INFORMATION

- When connecting or disconnecting the AC power cord, grip the plug and not the cord itself. Pulling the cord may damage it and create a hazard.
- When you are not going to use the unit for a long period of time, disconnect the AC power cord.

CONDENSATION INFORMATION

- When left in a heated room where it is warm and damp, water droplets or condensation may form inside the equipment. When there is condensation inside the unit, the unit may not function normally. Let the unit stand for 1-2 hours before turning the power on or gradually heat the room and let the unit dry before use.

RATING PLATE LOCATION

The rating plate is located on the rear of the unit.

FCC STATEMENTS

NOTE: This unit has been tested and found to comply with the limits for a Class B digital device, pursuant to Part 15 of the FCC Rules. These limits are designed to provide reasonable protection against harmful interference in a residential installation. This unit generates, uses and can radiate radio frequency energy and, if not installed and used in accordance with the instructions, may cause harmful interference to radio communication. However, there is not guarantee that interference will not occur in a particular installation. If this unit does cause harmful interference to radio or television reception, which can be determined by turning the unit off and on, the user is encouraged to try to correct the interference by one or more of the following measures:

- Reorient or relocate the receiving antenna.
- Increase the separation between the unit and receiver.
- Connect the unit into a wall outlet on a circuit different from that to which the receiver is connected.
- Consult the dealer or an experienced radio/TV technician for help.



WARNING: Changes or modifications to this unit not expressly approved by the party responsible for compliance could void the user authority to operate the unit.

E - 1

IMPORTANT SAFETY INSTRUCTIONS

- 1) Read these instructions.
- 2) Keep these instructions.
- 3) Heed all warnings.
- 4) Follow all instructions.
- 5) Do not use this apparatus near water.
- 6) Clean only with a dry cloth.
- 7) Do not block any ventilation openings. Install in accordance with the manufacturer's instructions.
- 8) Do not install near any heat sources such as radiators, heat registers, stoves, or other apparatus (Including amplifiers) that produce heat.
- 9) Do not defect the safety purpose of the polarized or grounding-type plug. A polarized plug has two blades with one wider than the other. A grounding type plug has two blades and a third grounding prong. The wide blade or the third prong is provided for your safety. If the provided plug does not fit into your wall outlet, consult an electrician for replacement of the obsolete outlet.
- 10) Protect the power cord from being walked on or pinched particularly at plugs, convenience receptacles, and the point where they exit from the apparatus.
- 11) Only use attachments / accessories specified by the manufacturer.
- 12) Use only with the cart, stand, tripod, bracket, or table specified by the manufacturer, or sold with the apparatus. When a cart is used, use caution when moving the cart / apparatus combination to avoid injury from tip-over. 
- 13) Unplug this apparatus during lightning storms or when unused for long periods of time.
- 14) Refer all servicing to qualified service personnel. Servicing is required when the apparatus has been damaged in any way, such as the power cord or plug is damaged, liquid has been spilled or objects have fallen into the apparatus, the apparatus has been exposed to rain or moisture, does not operate normally, or has been dropped.

TABLE OF CONTENTS

<p>SAFETY PRECAUTIONS 1</p> <p>IMPORTANT SAFETY INSTRUCTIONS 2</p> <p>TABLE OF CONTENTS 2</p> <p>QUICK INSTALLATION 3-4</p> <p>ACCESSORIES 5</p> <p>GETTING STARTED 5</p> <p>REMOTE CONTROL REFERENCE GUIDE 6</p> <p>CONTROL REFERENCE GUIDE 7</p> <p>CONNECTIONS 8-11</p> <p style="padding-left: 20px;">Connecting a TV Antenna / Cable / Satellite 8</p> <p style="padding-left: 20px;">Connecting an A / V Device 8</p> <p style="padding-left: 20px;">Connecting Devices with a Composite (Yellow RCA-Type) Video Output 9</p> <p style="padding-left: 20px;">Connecting Devices with a Composite (Yellow RCA-Type) Video Input 9</p>	<p style="padding-left: 20px;">Connecting a High-Definition (HD) Source 10</p> <p style="padding-left: 20px;">Connecting a PC 10</p> <p style="padding-left: 20px;">Connecting an Audio Amplifier 11</p> <p style="padding-left: 20px;">Connecting the AC Power Cord 11</p> <p>USING HEADPHONES 11</p> <p>TV SETUP 12-16</p> <p style="padding-left: 20px;">Picture Menu 12</p> <p style="padding-left: 20px;">Audio Menu 12</p> <p style="padding-left: 20px;">TIME Menu 13</p> <p style="padding-left: 20px;">Set Up Menu 13-14</p> <p style="padding-left: 20px;">Parental Menu 14-15</p> <p style="padding-left: 20px;">TV Menu 16</p> <p>MAINTENANCE 17</p> <p>TROUBLESHOOTING GUIDE 17</p>
---	--

QUICK INSTALLATION

ATTACHING THE BASE STAND

- Before attaching (or detaching) the stand, unplug the AC cord from the AC input terminal.

WARNING: The LCD display is very fragile and must be protected at all times when attaching the base stand. Be sure that nothing hard or sharp, or anything that could scratch or damage the LCD display, comes in contact with it. Do NOT place pressure on the front of the unit at any time because the screen could crack.

CAUTIONS:

- Attach the base stand in the correct direction.
 - Incorrect installation of the stand may result in the unit falling over.
 - Be sure to follow the instructions.
1. Confirm 4 screws (silver screws x2 & black screws x2) are supplied with the unit.
 2. Lay the unit down on a flat surface, so the backside is facing up, making sure to place a soft cushioned material (such as a pillow or thick piece of foam) beneath the screen.
 3. Attach the BASE STAND to the opening on the rear of the unit.
 4. Insert and tighten the four screws (supplied) into the holes as shown below.

Note: To detach the base stand, perform the steps in reverse order.

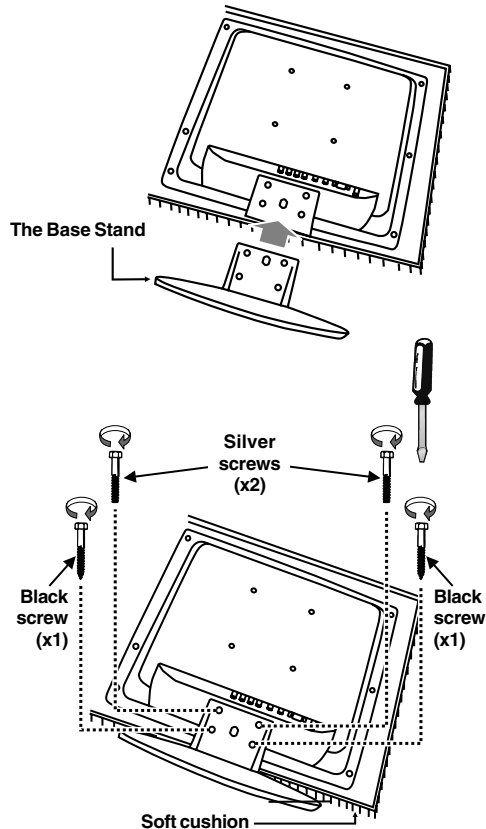

MOUNTING ON THE WALL

This unit is VESA-compliant, and is designed to be wall-mounted with a VESA-compliant 3 15/16" x 3 15/16" (100mm x 100mm) mounting kit designed for flat-panel TVs (sold separately). Mount this unit according to the directions included with the mounting kit.

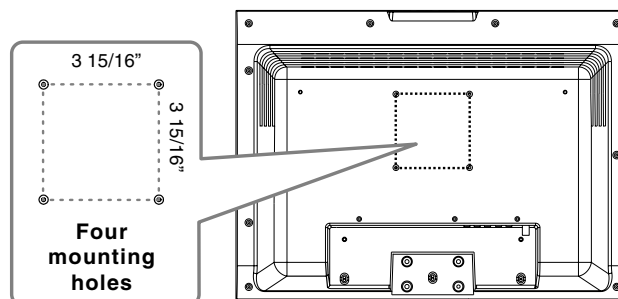

QUICK INSTALLATION

When you turn on your television set for the first time, be sure to place it on a solid stable surface. To avoid danger, do not expose the TV to water, or a heat source (e.g. lamp, candle, radiator). Do not obstruct the ventilation grid at the rear and be sure to leave sufficient gaps around the unit as shown.

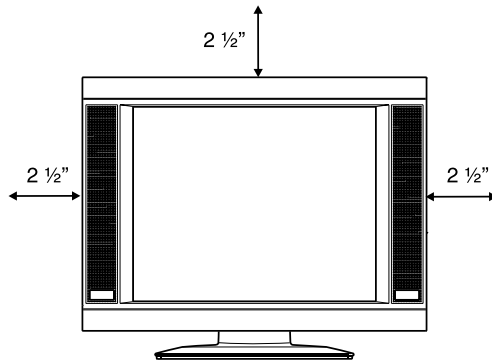

TURNING ON THE UNIT FOR THE FIRST TIME

The first time you turn on the unit, the unit will enter Setup mode. You can easily follow the prompt message on the screen to complete basic TV settings.

Make sure the RF aerial has been connected properly to the **TV ANTENNA** input jack on the rear of the system.

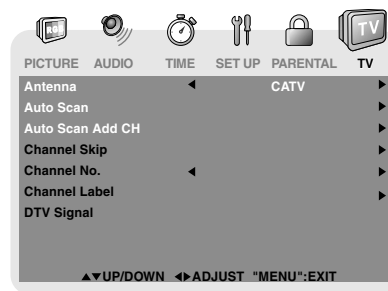
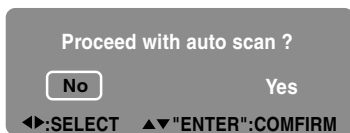

1. Press the </> button to select Yes. Press the **ENTER** button to proceed with the initial setup.
2. Use the ▲ / ▼ button to select Antenna, then press the </> button to select Air or CATV.



3. Use the ▲ / ▼ button to select Auto Scan, then press the ► button to enter auto scan menu. Use the ▲ / ▼ button to select Start to Scan, and press the ► button to begin scanning (If you selected CATV on Step 2, you need to select Cable System before Start to Scan). The system will automatically start to scan and preset all available TV channels.
4. After scanning has finished, the system will return to the first TV channel scanned.

ACCESSORIES

Please check and identify the supplied accessories.

- Remote Control x 1
- "AAA" Batteries (for remote control) x 2
- Screws (for base stand) x 4

GETTING STARTED

USING THE REMOTE CONTROL

- Point the remote control at the remote sensor located on the unit.
- When there is a strong ambient light source, the performance of the infrared remote sensor may be degraded, causing unreliable operation.
- The recommended effective distance for remote operation is about 16 feet (5 meters).

TO INSTALL BATTERIES

1. Open the battery door.
2. Insert 2 "AAA" batteries.

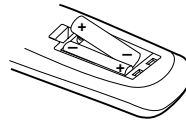
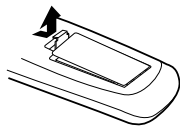

BATTERY REPLACEMENT

When the batteries become weak, the operating distance of the remote control is greatly reduced and you will need to replace the batteries.

CAUTION:
Danger of explosion if battery is incorrectly replaced.

NOTES:

- If the remote control is not going to be used for a long time, remove the batteries to avoid damage caused by battery leakage corrosion.
- Do not mix old and new batteries. Do not mix ALKALINE, standard (CARBON-ZINC) or rechargeable (NICKEL-CADMIUM) batteries.
- Always remove batteries as soon as they become weak.
- Weak batteries can leak and severely damage the remote control.

WARNING : Do not dispose of batteries in a fire. Batteries may explode or leak.

Many universal remote controls have a "learning" feature. We recommend you use this feature to program the remote control.

For any questions or problems related to programming a universal remote control, you must contact the customer service department of the universal remote control manufacturer for assistance, or refer to the instructions included with the universal remote control. We cannot offer assistance in programming universal remote controls.

REMOTE CONTROL REFERENCE GUIDE

REMOTE CONTROL

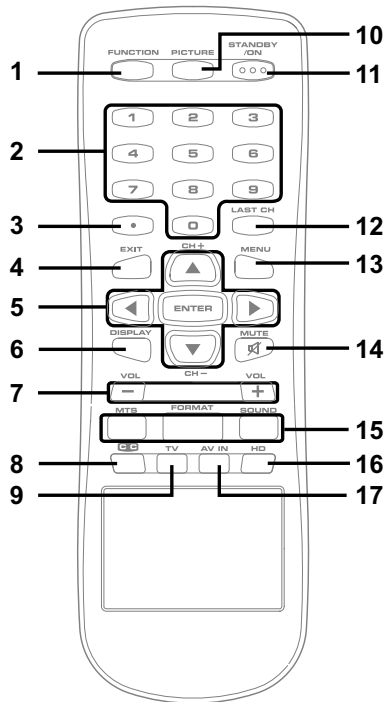

1. **FUNCTION Button**
Press to switch between TV/AV In/YUV In/PC In.
2. **Number (0 - 9) Buttons**
3. **[dot] Button**
Press to enter digital sub-channels (i.e. 11.3 or 12.7)
4. **EXIT Button**
Press to exit the TV SET UP menu and return directly to normal viewing.
5. **CURSOR (▲, ▼, ◀, ▶) Buttons**
Press to highlight selections on a menu screen and adjust certain settings.
ENTER Button
Press to confirm selections on a menu screen.
CH + / CH - Buttons
Press to change the TV channels.
6. **DISPLAY button**
Press to show that input you are watching (TV/AV In/YUV In/PC In).
7. **VOLUME (- / +) Buttons**
Press to adjust the volume level.
8. **CC Button**
Press to activate the Closed Captioning feature. This function only works on programs broadcasted with captions.
9. **TV Button**
Press to switch to TV mode.
10. **PICTURE Button**
Press to select from preset screen display settings to match the type of show you are watching (Standard/Soft/Movie/Personal).
11. **⏻ STANDBY / ON Button**
Press to turn ON the unit or put it in STANDBY (OFF) mode.
12. **LAST CH Button**
Press to switch repeatedly between the last two channels displayed.
13. **MENU Button**
Press to display the on-screen TV menu.
14. **MUTE  Button**
Press to turn off the sound.
15. **MTS Button**
Press to select between MONO sound, STEREO sound and Secondary Audio Program (SAP).
FORMAT Button
Press to select the picture format (Full/Zoom/Auto/4:3).
SOUND Button
Press to select from preset sound settings to match the type of show you are watching (Standard/Music/Movie/Personal).
16. **HD Button**
Press to switch to source connected to YUV in (component) inputs.
17. **AV IN Button**
Press to switch to source connected to AV (composite) inputs.

CONTROL REFERENCE GUIDE

FRONT AND SIDE VIEWS

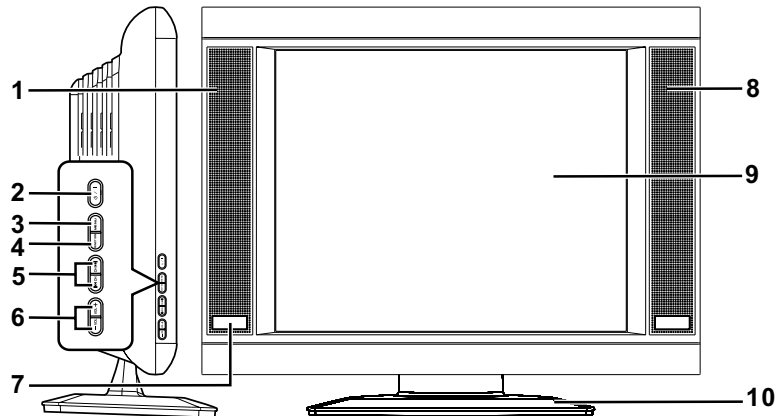

- | | |
|---|--|
| <ol style="list-style-type: none"> 1. Left Speaker 2. ⏻/I Button
Turns the unit on and off. 3. MENU Button
Enters the on-screen TV menu. 4. FUNCTION Button
Selects TV/AV In/YUV In/PC In. 5. ▲ CH ▼ Buttons
Confirms selections on the TV menu screen and changes the TV channels. | <ol style="list-style-type: none"> 6. - VOL + Controls
Adjusts the volume level. 7. Remote Sensor
Receives the remote control signal. Standby Indicator 8. Right Speaker 9. Color LCD Screen 10. Removable Stand |
|---|--|

REAR VIEW

- 11) AC Power Cord
- 12) VIDEO OUT Jack - AV OUT
- 13) AUDIO OUT Jacks (Left/Right) - AV OUT
- 14) VIDEO IN Jack - AV IN
- 15) AUDIO IN Jacks (Left/Right) - AV IN
- 16) MONITOR/VGA Jack - PC IN
- 17) AUDIO Jack - PC IN
- 18) Component VIDEO IN Jacks (Y/PB/PR) - YUV IN
- 19) AUDIO IN Jacks (Left/Right) - YUV IN
- 20) S-VIDEO Jack - AV IN
- 21) HEADPHONES Jack
- 22) TV Antenna Terminal

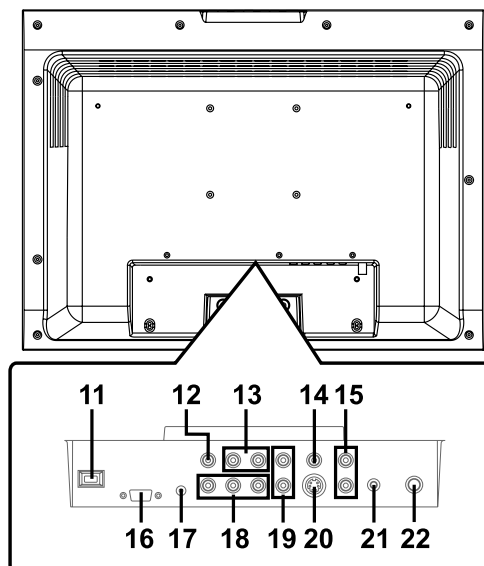

E - 7

CONNECTIONS

CONNECTING A TV ANTENNA / CABLE / SATELLITE

To view television channels correctly, a signal must be received from one of the following sources:

- An indoor or outdoor aerial antenna
- A cable system
- A satellite system

Connecting a Digital Antenna

The tuner in this TV receives ATSC TV signals from an antenna. This digital TV can receive standard (SDTV) and high definition (HDTV) over the air broadcasts.

Connecting an Analog Antenna or Device

The tuner in this TV receives NTSC TV signals, analog cable signals or the RF output from a satellite receiver, VCR or cable box.

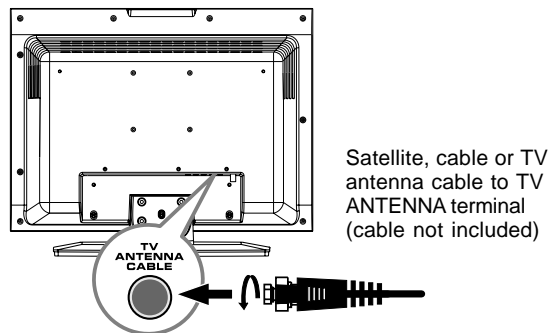

CONNECTING AN AV DEVICE

To connect other equipment such as a VCR, camcorder, satellite system or cable, etc.:

Connecting a VCR / Camcorder / Satellite System / Cable

Connect the AUDIO and S-VIDEO cable (not included) as shown.

Make sure you connect the cable from the other equipment (AUDIO OUT and S-VIDEO OUT) to this unit (AUDIO IN and S-VIDEO IN).

NOTE:
Please refer to the user manual for the other equipment for more information.

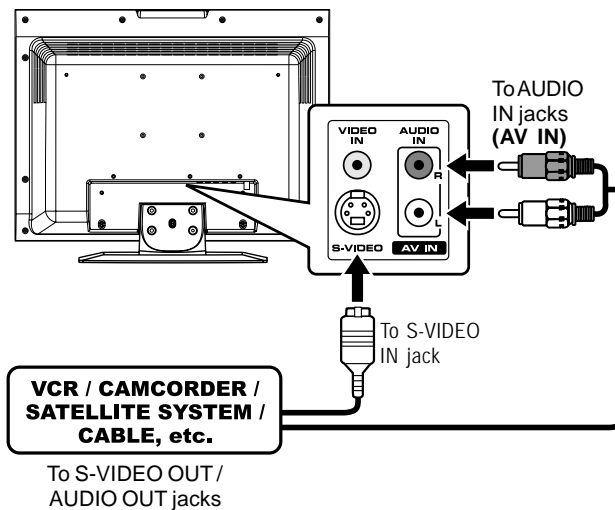

CONNECTIONS

CONNECTING DEVICES WITH A COMPOSITE (YELLOW RCA-TYPE) VIDEO OUTPUT

To connect A/V devices such as a VCR, video game system or camcorder:

Connecting a VCR / Video Game System / Camcorder

Connect the AUDIO / VIDEO cable (not included) as shown.

Make sure you connect the cable from the other equipment (**AUDIO** and **VIDEO OUT**) to this unit (**AUDIO** and **VIDEO IN**).

NOTE:

Please refer to the user manual for the other equipment for more information.

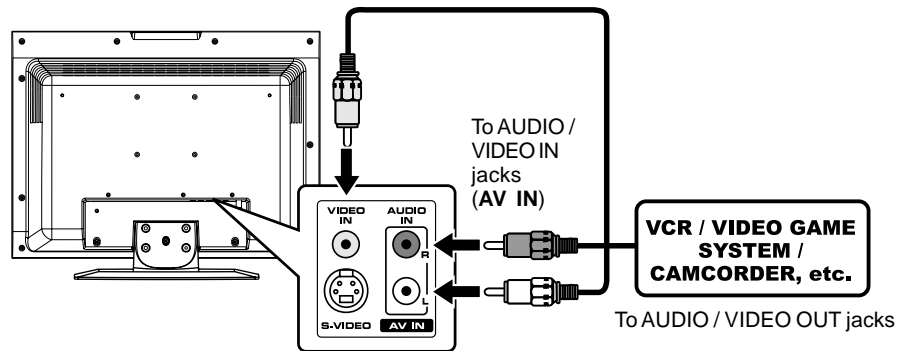

CONNECTING DEVICES WITH A COMPOSITE (YELLOW RCA-TYPE) VIDEO INPUT

To connect A/V devices such as a VCR, PVR or camcorder:

Connecting a VCR / PVR / Camcorder

Connect the AUDIO / VIDEO cable (not included) as shown:

Make sure you connect the cable from the other equipment (**AUDIO** and **VIDEO IN**) to this unit (**AUDIO** and **VIDEO OUT**).

NOTE:

Please refer to the user manual for the other equipment for more information.

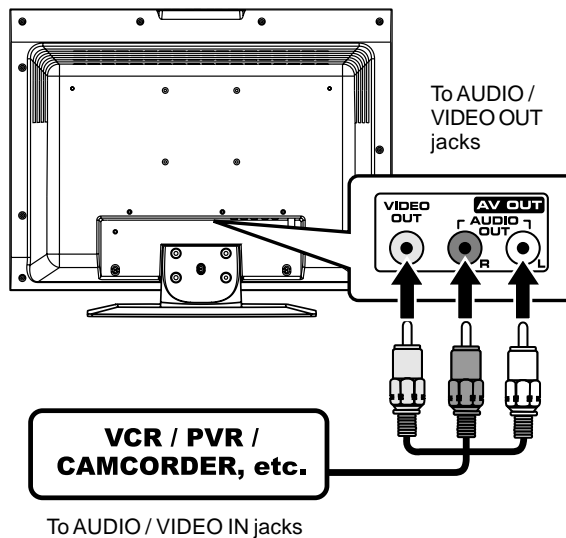

CONNECTIONS

CONNECTING A HIGH-DEFINITION (HD) SOURCE

High-Definition (HD) devices with component video output must be connected to the YUV input. Connect the component video cable and audio cable (not included) as shown. Make sure you connect the component video cable and audio cable from the other equipment (**COMPONENT VIDEO OUT** and **AUDIO OUT**) to this unit (**COMPONENT VIDEO IN** and **AUDIO IN - YUV IN**).

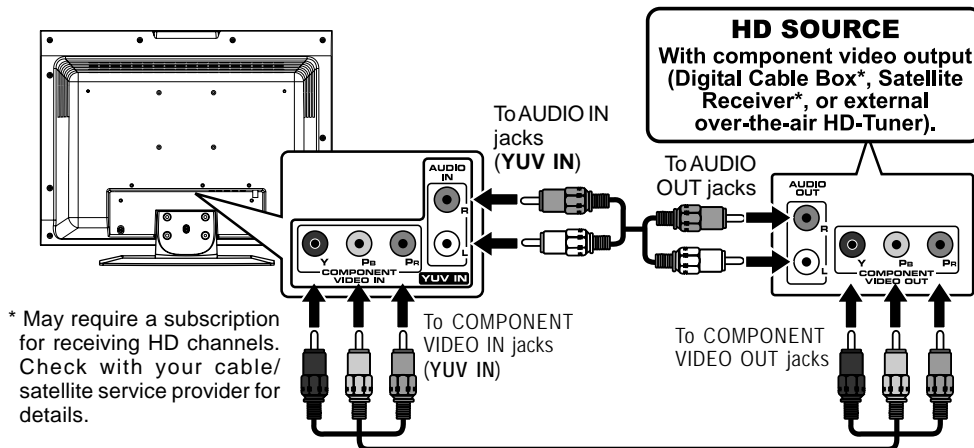

NOTE:

When connecting a DVD player to the television, the picture resolution is solely dependent upon the resolution supported by the DVD player attached. DVD player resolutions vary from 480i to 1080i, and this unit can support DVD players up to a maximum resolution of 1080i.

CONNECTING A PC

Connect the 15-pin D-SUB PC/VGA connector from your computer to the 15-pin D-SUB PC/VGA input on this unit using a monitor cable and audio cable (not included) as shown.

Make sure you connect the cable from the computer (**PC Connector** and **AUDIO - PC OUT**) to this unit (**MONITOR / VGA** and **AUDIO - PC IN**).

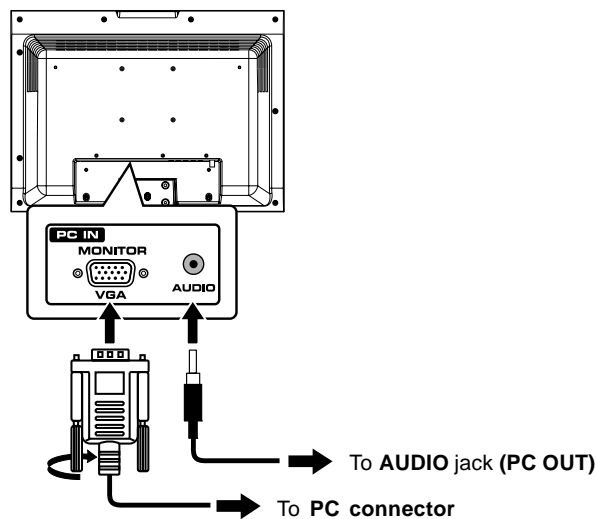

CONNECTIONS

CONNECTING AN AUDIO AMPLIFIER

This connection allows you to use an audio amplifier and external speakers.

Connect the AUDIO cable (not included) as shown.

Make sure you connect the cable from the other equipment (**AUDIO IN**) to this unit (**AUDIO OUT**).

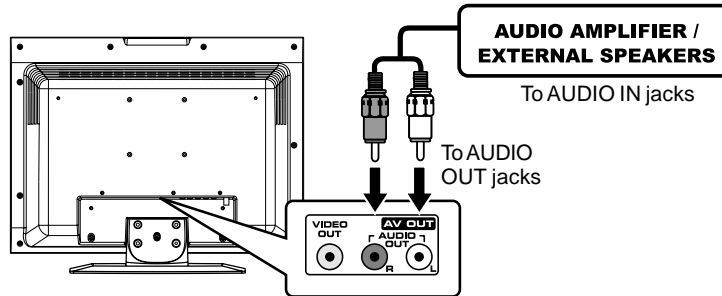

CONNECTING THE AC POWER CORD

- Connect the AC power cord into a wall outlet.
- Press the **STANDBY / ON** button on the left side of the unit or use the remote control to turn on the unit.

NOTES:

- **TO PREVENT ELECTRIC SHOCK, MATCH WIDE BLADE OF PLUG TO WIDE SLOT OF WALL OUTLET, THEN FULLY INSERT.**
- When the AC power cord is plugged in, the unit is not completely disconnected from the main power, even when the power is turned off.
- Be sure the AC power cord is disconnected and all functions are off before making connections.
- Make sure all components are connected correctly.
- When you are not going to use the unit for a long period of time, disconnect the AC power cord.

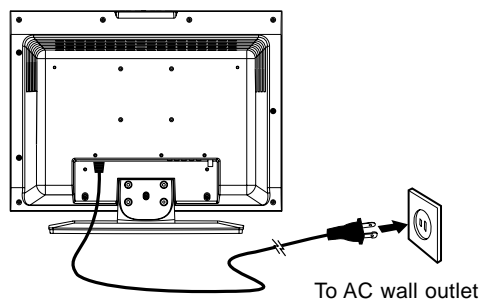

USING HEADPHONES

- Turn down the volume before connecting headphones to the unit, then adjust the volume to your desired level.
- When headphones are connected, no sound will come from the front speakers.

NOTE:

Avoid listening to sound at high levels for prolonged periods of time. This may be harmful to you and may cause hearing loss.

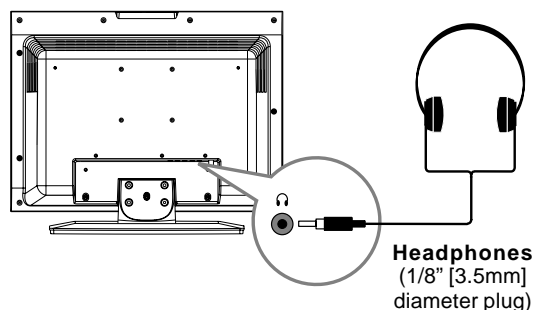

E - 11

TV SETUP

Note: Some settings on the menu screen may not activate depending on which mode the unit is currently in (TV/AV/YUV/PC).

PICTURE MENU

1. Press the **TV MENU** button.
2. Press the **▼** button to enter **PICTURE** settings.
3. Use the **▲** or **▼** button to select the options (**Picture Mode, Contrast, Brightness, Sharpness, Tint or Color**). Adjust them using the **◀** or **▶** button (The screen will change to your desired setting).
4. Repeat step 3 to adjust other options.
5. To exit the MAIN MENU and return to the normal screen, press the **EXIT** or **TV MENU** button repeatedly.

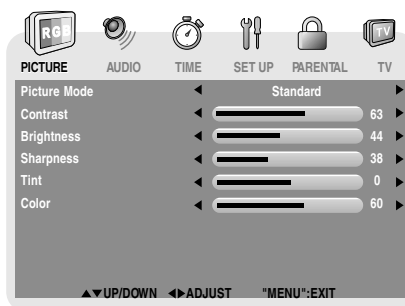

Picture Mode: Select from preset screen display settings to match the type of show you are watching (Standard, Soft, Movie and Personal). Select Personal mode to recall your custom settings on contrast, brightness, sharpness, tint and color.

Contrast : Adjust to sharpen the picture quality. The black portions of the picture become richer in darkness and the white become brighter.

Brightness : Adjust the brightness of the picture. Brighten or darken the whole picture.

Sharpness : Adjust the sharpness level to improve detail in the picture.

Tint : Adjust the tint of the picture (Toward purple / Toward green).

Color : Adjust the color of the picture.

AUDIO MENU

1. Press the **TV MENU** button.
2. Use the **◀** or **▶** button to select **AUDIO**, then press the **▼** button to enter the AUDIO settings.
3. Use the **▲** or **▼** button to select the options (**Sound Mode, Bass, Treble Balance, Audio Language or MTS**). Adjust them using the **◀** or **▶** button.
4. Repeat step 3 to adjust other options.
5. To exit the MAIN MENU and return to the normal screen, press the **EXIT** or **TV MENU** button

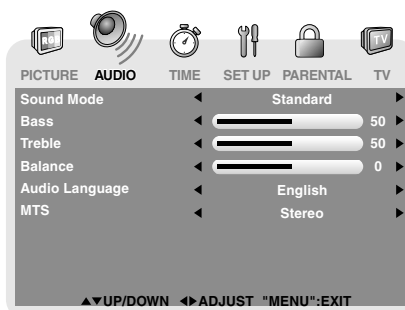

Note: Experiment with different sound settings until you find the settings you prefer.

Sound Mode : Select from preset sound settings (Standard, Music, Movie or Personal) to match the type of show you are watching. Select Personal mode to recall your custom settings on bass, treble and balance.

Bass : Adjust the bass range.

Treble : Adjust the treble range.

Balance : Adjust the balance level toward the left or right speakers.

Audio Language : Select from English / Spanish / French (available for digital channels if multiple audio languages are broadcasted).

MTS (Multi Channel Television Sound) : Select Stereo / SAP (Secondary Audio Program) / Mono.

Note:

The SAP (Secondary Audio Programs) feature allows a TV station to broadcast other information, which could be audio in another language.

TV SETUP

TIME MENU

1. Press the **TV MENU** button.
2. Use the ◀ or ▶ button to select **TIME**, then press the ▼ button to enter the TIME settings.
3. Use the ▲ or ▼ button to select the options (**OSD Duration, Sleep Timer, Time Zone or Day Saving Time**). Adjust them using the ◀ or ▶ button.
4. Repeat step 3 to adjust other options.
5. To exit the MAIN MENU and return to the normal screen, press the **EXIT** or **TV MENU** button repeatedly.



OSD (On Screen Display) Duration : Select the length of time the On Screen Menu is displayed: 15 Sec / 30 Sec / 45 Sec / 60 Sec.

Sleep Timer : Select the length of time before the unit automatically changes to Standby Mode: Off -> 5 Minutes -> 10 Minutes -> 15 Minutes -> 30 Minutes -> 60 Minutes -> 90 Minutes -> 120 Minutes -> Off.

Time Zone : Select the time zone from Eastern / Central / Mountain / Pacific / Alaska / Hawaii.

Day Saving Time : Select On to activate daylight savings time.

Clock : Displays the current time.

SET UP MENU

1. Press the **TV MENU** button.
2. Use the ◀ or ▶ button to select **SET UP**, then press the ▼ button to enter the SET UP settings.
3. Use the ▲ or ▼ button to select the options (**OSD Language, Color Mode, PC Set Up, Closed Caption or Restore Setting**). Adjust them using the ◀ or ▶ button (The screen will change to your desired setting); or press the ▶ button to go into the detailed settings.
4. Press the **MENU** button to return to the previous menu.
5. Repeat steps 3 and 4 to adjust other options.
6. To exit the MAIN MENU and return to the normal screen, press the **EXIT** or **TV MENU** button repeatedly.

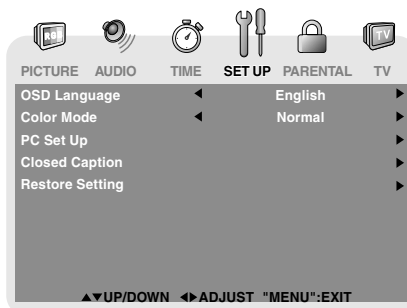

OSD (On Screen Display) Language : Select On-screen menu language from English / French / Spanish.

Color Mode : Adjust the three color temperature of the picture. Choose from Normal (balanced), Warm (red white), or Cool (blue white) modes.

Restore Setting : If you reset the TV to the factory settings, all your present settings on PICTURE and AUDIO will be erased and replaced by the factory's default settings.

TV SETUP

PC Set Up (in PC mode only)

- Resolution : 1280 x 1024 max
- Refresh Frequency : 60Hz max

H - Pos : Center the image by moving it left or right.

V - Pos : Center the image by moving it up or down.

Clock : Adjusts the display clock to change width of the image.

Phase : Adjusts the image if there is flicker of screen letters, color misalignment, or blurring.

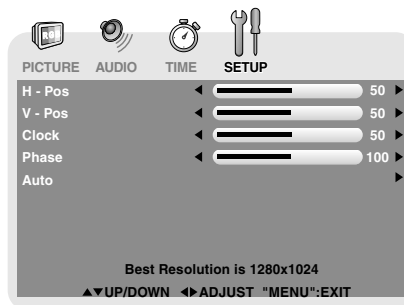

Closed Caption

Note:

This function only works on ATSC programs broadcast with captions.

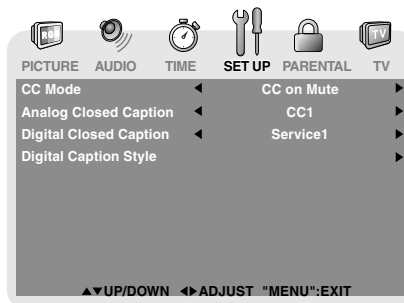

CC Mode : Select closed caption On, Off or CC on Mute.

Analog Closed Caption : Select the analog closed caption or turn it off.

Digital Closed Caption : Select the digital closed caption or turn it off.

Digital Caption Style : Select As Broadcaster to use the default digital caption style of the broadcaster. Select Custom to activate the caption style items and set your desired detailed settings.

PARENTAL MENU

Password

1. Press the **TV MENU** button.
2. Use the ◀ or ▶ button to select **PARENTAL**, then press the ▼ button to enter the PARENTAL settings. The menu locked screen will be displayed.
3. Enter a 4-digit password. Once entered, the screen will enter the Parental menu. The preset password is 0000.



If you forget the password,
enter " 8888 " to unlock parental
control.

TV SETUP

Parental

1. Use the ▲ or ▼ button to select various Parental settings. Adjust them using the ◀ or ▶ button, or press the ▶ button to go into the detailed settings.
2. Press the TV MENU button to return to the previous menu.
3. Repeat steps 1 - 2 to adjust other options.
4. To exit the MAIN MENU and return to the normal screen, press the EXIT or TV MENU button repeatedly.

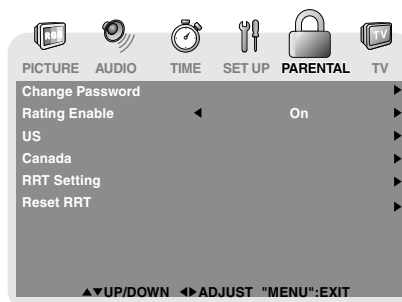

Rating Enable: Select On to edit the following parental items. Select Off to disable parental control.

US : Set TV and MPAA ratings.

Canada : Set Canada English and Canada French ratings.

RRT Setting : Set Rating Region Table.

Reset RRT : Reset Rating Region Table to the default settings.

U.S. TV Ratings	TV-Y : Recommended for all children. TV-Y7 : Recommended for all children age 7 and above. TV-G : General Audience. TV-PG : Parental Guidance Suggested. TV-14 : Parental Strongly Cautioned. TV-MA : Mature Audience Only.
U.S. MPAA Ratings	N/A : Not rated. G : GENERAL AUDIENCES, Suitable for all ages. PG : PARENTAL GUIDANCE SUGGESTED - Some material may not be suitable for children. PG-13 : PARENTS STRONGLY CAUTIONED - Some material may be inappropriate for children under 13. R : RESTRICTED, Under 17 requires accompanying parent or adult guardian for viewing in movie theaters. NC-17 : No one 17 or under admitted in movie theaters, X : Adults Only.
Canadian English Ratings	E : Exempt. C : Children. C8+ : Recommended for children age 8 and older. G : GENERAL AUDIENCES, Suitable for all ages. PG : PARENTAL GUIDANCE SUGGESTED - Some material may not be suitable for children. 14+ : Viewers 14 years and older. 18+ : Adult Programming.
Canadian French Ratings	E : Exempt. G : GENERAL AUDIENCES, Suitable for all ages. 8 ans+ : Not recommended for young children. 13 ans+ : Not suitable for children under the age of 13. 16 ans+ : Not suitable for children under the age of 16. 18 ans+ : Adult Programming.

TV SETUP

TV MENU (For TV Mode Only)

1. Press the **TV MENU** button.
2. Use the ◀ or ▶ button to select **TV**, then press the ▼ button to enter the TV settings.
3. Use the ▲ or ▼ button to select the options (**Antenna**, **Auto Scan**, **Auto Scan Add CH**, **Channel Skip**, **Channel No.**, **Channel Label** or **DTV Signal**). Adjust them using the ◀ or ▶ button, or press the ▶ button to go into the detailed settings.
4. Press the **TV MENU** button to return to the previous menu.
5. Repeat steps 3 and 4 to adjust other options.
6. To exit the MAIN MENU and return to the normal screen, press the **EXIT** or **TV MENU** button repeatedly.

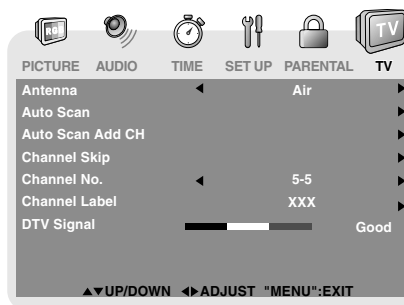

- Antenna** : Air (over-the-air broadcasts, Ch 2-69) or CATV (cable/satellite broadcasts, CH 1-135) mode is available.
- Auto Scan** : Search for usable stations and store them in memory.
- Auto Scan Add CH** : Search for more usable stations and add them in memory. The stations stored before are still kept.
- Channel Skip** : Skip weak channels and the channels you do not like.
- Channel No.** : Select a different TV channel.
- Channel Label** : Display and edit the channel label.
- DTV Signal** : Display the signal strength (for digital TV channels only).

Channel Skip

1. Use the ▲ or ▼ button to select a channel (Press the ▶ button to select the last channel of the page; press again to go to the next page. Press the ◀ button to select the first channel of the page; press again to go to the previous page).
2. Press the **ENTER** button to shift between On / Off (Select On to skip the selected channel. The channel will not appear when you press the **CH** ^ / **CH** ∨ Button).

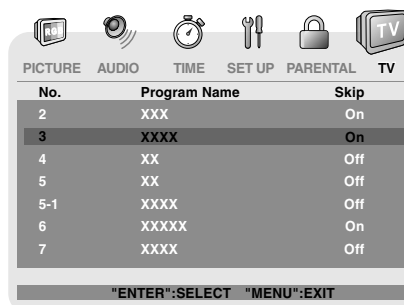

Channel Label

You can edit a label for each channel.

1. Use the ▲ or ▼ button to select the number or letter. Use the ◀ or ▶ button to move and edit the next character. Press the **ENTER** button to confirm.
2. After editing, the Channel and Channel Label will be displayed on the screen when you press the **DISPLAY** button.

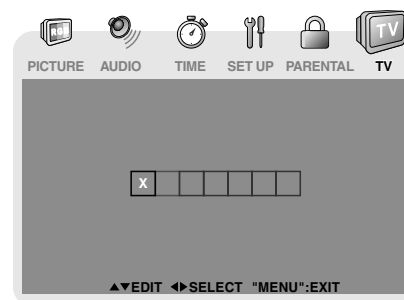

MAINTENANCE

CLEANING THE UNIT

- Be sure to turn the unit off and disconnect the AC power cord before cleaning the unit.
- Wipe the unit with a dry soft cloth. If the surfaces are extremely dirty, wipe clean with a cloth that has been dipped in a weak soap-and-water solution and wrung out thoroughly. Then wipe it with a dry cloth.
- Never use alcohol, benzene, paint-thinner, cleaning fluid or other chemicals. Do NOT use compressed air to remove dust.

TROUBLESHOOTING GUIDE

SYMPTOM

CAUSE (AND REMEDY)

No power.

- Make sure the AC power cord is connected.
- The unit is not turned on.

The remote does not function.

- Remove any obstacles between the remote and the unit.
- Use the remote near the unit.
- Point the remote at the remote sensor on the unit.
- Replace the batteries in the remote with new ones.

TV

Bad Picture (snow, multiple images, distortion, blurry)

- Check the location of the antenna and adjust it if necessary.
- Make sure the antenna cable is firmly connected.
- Make sure all input cables are firmly connected.

Black and white picture.

- Check the PICTURE MENU within the TV SETUP MENU.
- Check to make sure the program you are watching is broadcast in Color and not black and white.

No picture or sound.

- Make sure the unit is plugged in and turned on.
- Make sure TV mode is selected.
- Try a new channel to check for possible station trouble.
- Make sure the antenna is connected properly.
- Increase the volume.
- Make sure the antenna or audio video source device is working properly.
- Make sure all cables are firmly connected.
- Check for local interference.

Colored patches of picture.

- Make sure there are no unshielded electrical devices nearby that are causing interference.
- Turn the unit off for 30 minutes, then try it again.

Unit : INCH

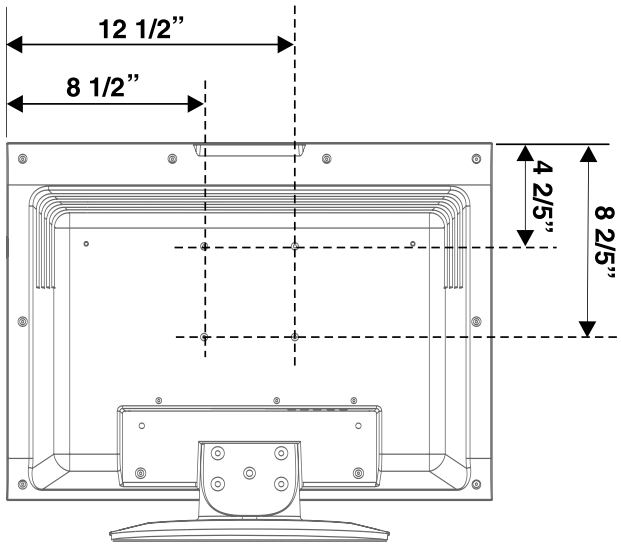
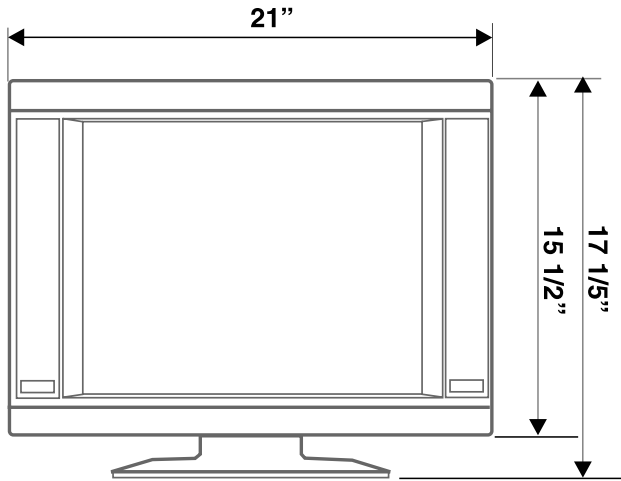
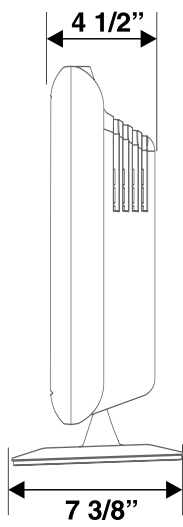

VENTURER ELECTRONICS ("VENTURER") makes the following limited warranty. This limited warranty extend to the original consumer purchaser and is limited to non-commercial use of the product.

Ninety (90) Day Parts & Labor Warranty

VENTURER products purchased in the United States are warranted to be free from defects in materials or workmanship for a period of ninety (90) days from the date of their original retail purchase. If the unit fails to conform to this warranty, we will service the product using new or refurbished parts and products, at **VENTURER's** sole discretion.

During a period of ninety (90) days from the effective warranty date, **VENTURER** will provide, when needed, service labor to repair a manufacturing defect at its designated Service Center. To obtain warranty service in the United States, you must first call our **Customer Support Center at (800) 252-6123, during the hours listed in the box below.** The determination of service will be made by **VENTURER** Customer Support. **PLEASE DO NOT RETURN YOUR UNIT TO VENTURER WITHOUT PRIOR AUTHORIZATION.** New or remanufactured replacements for defective parts or products will be used for repairs by **VENTURER** at its designated Service Center for ninety (90) days from the effective warranty date. Such replacement parts or products are warranted for an additional ninety (90) days from the date of repair or replacement. The Customer will be required to ship the unit to the Service Center indicated at the time Customer Support is contacted to make the necessary repairs. The customer is responsible for all transportation charges to the service facility.

Packaging and Shipping Instruction

When you send the product to the **VENTURER** service facility you must use the original carton box and packing material or an equivalent as designated by **VENTURER.**

LIMITED WARRANTY

Your Responsibility

- (1) You must retain the original sale receipt to provide proof of purchase.
- (2) These warranties are effective only if the product is purchased and operated in the U.S.A. or Canada.
- (3) Warranties extend only to defects in material or workmanship, and do not extend to any product or parts which have been lost or discarded, or damage to product or parts caused by misuse, accident, improper operation or maintenance, or use in violation of instructions provided with the product, or to product which has been altered or modified without authorization of **VENTURER,** or to products or parts thereof which have had the serial number removed or changed.

Out of Warranty

In the event your product requires repair after the limited warranty period has expired, please contact our Customer Support Center at **1-800-252-6123** or **www.venturer.com.**
Hours: Monday–Thursday: 9–7, Friday: 9–5, Saturday: 9–12 EST.

Important:

You are responsible for any transportation, shipping or insurance relative to the return of product to our Product Returns Center.

All warranties implied by state law, including the implied warranties of merchantability and fitness for a particular purpose, are expressly limited to the duration of the limited warranties set forth above. With the exception of any warranties implied by state law as hereby limited, the foregoing warranty is exclusive and in lieu of all other warranties, guarantees, agreements and similar obligations of manufacturer or seller with respect to the repair or replacement of any parts. In no event shall **VENTURER** be liable for consequential or incidental damages.

No person, agent, distributor, dealer or company is authorized to change, modify or extend the terms of these warranties in any manner whatsoever. The time within action must be commenced to enforce any obligation of **VENTURER** arising under the warranty or under any statute, or law of the United States or any state thereof, is hereby limited to ninety (90) days from the date of purchase. This limitation does not apply to implied warranties arising under state law.

This warranty gives you specific legal rights and you may also have other rights, which may vary, from state to state. Some states do not allow limitation on how long an implied warranty lasts, when an action may be brought, or the exclusion or limitation of incidental or consequential damages, so the above provisions may not apply to you. Important: Also keep your "Bill of Sale" as proof of purchase.

Model no.	Product name
Type of set	
Serial no.	Invoice no.
Date purchased	Dealer name

For more information on other products and services, please visit our web site at **www.venturer.com**

©2007 VENTURER Electronics Inc.

Printed in China
811-P16191W020

Free Manuals Download Website

<http://myh66.com>

<http://usermanuals.us>

<http://www.somanuals.com>

<http://www.4manuals.cc>

<http://www.manual-lib.com>

<http://www.404manual.com>

<http://www.luxmanual.com>

<http://aubethermostatmanual.com>

Golf course search by state

<http://golfingnear.com>

Email search by domain

<http://emailbydomain.com>

Auto manuals search

<http://auto.somanuals.com>

TV manuals search

<http://tv.somanuals.com>