

# VENTURER

## 19" LCD TV

PLV76198E

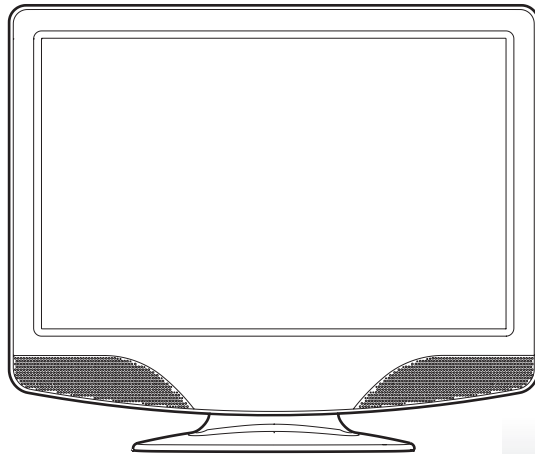

### OWNER'S MANUAL

# SAFETY PRECAUTIONS

	<b>CAUTION</b> <b>RISK OF ELECTRIC SHOCK</b> <b>DO NOT OPEN</b>	
<b>DO NOT EXPOSE THIS UNIT TO RAIN OR MOISTURE</b> <b>AVIS RISQUE DE CHOC ÉLECTRIQUE -NE PAS OUVRIR</b>		
<b>WARNING: TO REDUCE THE RISK OF ELECTRIC SHOCK, DO NOT REMOVE COVER (OR BACK). NO USER-SERVICEABLE PARTS INSIDE. REFER SERVICING TO QUALIFIED PERSONNEL.</b>		



The lightning flash with an arrowhead symbol, within the equilateral triangle, is intended to alert the user to the presence of uninsulated "dangerous voltage" within the product's enclosure that may be of sufficient magnitude to cause an electric shock.



The exclamation point within the equilateral triangle is intended to alert the user to the presence of important operating and maintenance (servicing) instructions in this owner manual.



The symbol for Class II (Double Insulation)

## CAUTION:



- DANGER OF EXPLOSION IF BATTERY IS INCORRECTLY REPLACED. REPLACE ONLY WITH THE SAME OR EQUIVALENT TYPE.
- TO PREVENT ELECTRIC SHOCK, MATCH WIDE BLADE OF PLUG TO WIDE SLOT OF WALL OUTLET, THEN FULLY INSERT.
- USE OF CONTROLS OR ADJUSTMENTS OR PERFORMANCE OF PROCEDURES OTHER THAN THOSE SPECIFIED MAY RESULT IN HAZARDOUS RADIATION EXPOSURE.

## WARNING:

- To reduce the risk of fire or shock hazard, do not expose this unit to rain or moisture.
- Main plug is used as disconnect device and it should remain readily operable during intended use.
- The unit shall not be exposed to dripping or splashing and that no objects filled with liquids, such as vases, shall be placed on unit.
- In order to disconnect the unit from the mains completely, the AC power cord should be disconnected from the mains socket outlet completely.
- Battery shall not be exposed to excessive heat such as sunshine, fire or the like.

## PLACEMENT INFORMATION

- Do not use this unit in places which are extremely hot, cold, dusty or humid.
- Do not restrict the air flow of this unit by placing it somewhere with poor air flow, by covering it with a cloth, by placing it on bedding or carpeting.

## SAFETY INFORMATION

- When connecting or disconnecting the AC power cord, grip the plug and not the cord itself. Pulling the cord may damage it and create a hazard.
- When you are not going to use the unit for a long period of time, disconnect the AC power cord.

## CONDENSATION INFORMATION

- When left in a heated room where it is warm and damp, water droplets or condensation may form inside the equipment. When there is condensation inside the unit, the unit may not function normally. Let the unit stand for 1-2 hours before turning the power on or gradually heat the room and let the unit dry before use.

## RATING PLATE LOCATION

The rating plate is located on the rear of the unit.

## FCC STATEMENTS

This device complies with Part 15 of the FCC Rules. Operation is subject to the following two conditions: (1) This device may not cause harmful interference, and (2) This device must accept any interference received, including interference that may cause undesired operation.

This equipment has been tested and found to comply with the limits for a Class B digital device, pursuant to Part 15 of the FCC Rules. These limits are designed to provide reasonable protection against harmful interference in a residential installation. This unit generates, uses and can radiate radio frequency energy and, if not installed and used in accordance with the instructions, may cause harmful interference to radio communication. However, there is not guarantee that interference will not occur in a particular installation. If this unit does cause harmful interference to radio or television reception, which can be determined by turning the unit off and on, the user is encouraged to try to correct the interference by one or more of the following measures:

- Reorient or relocate the receiving antenna.
- Increase the separation between the unit and receiver.
- Connect the unit into an outlet on a circuit different from that to which the receiver is connected.
- Consult the dealer or an experienced radio/TV technician for help.
- Shielded cables must be used with this unit to ensure compliance with the Class B FCC limit.
- This television receiver provides display of television closed captioning in accordance with Section 15.119 of the FCC rules.



WARNING: Changes or modifications to this unit not expressly approved by the party responsible for compliance could void the user authority to operate the unit.

# IMPORTANT SAFETY INSTRUCTIONS

- 1) Read these instructions.
- 2) Keep these instructions.
- 3) Heed all warnings.
- 4) Follow all instructions.
- 5) Do not use this apparatus near water.
- 6) Clean only with a dry cloth.
- 7) Do not block any ventilation openings. Install in accordance with the manufacturer's instructions.
- 8) Do not install near any heat sources such as radiators, heat registers, stoves, or other apparatus (Including amplifiers) that produce heat.
- 9) Do not defeat the safety purpose of the polarized or grounding-type plug. A polarized plug has two blades with one wider than the other. A grounding type plug has two blades and a third grounding prong. The wide blade or the third prong is provided for your safety. If the provided plug does not fit into your wall outlet, consult an electrician for replacement of the obsolete outlet.
- 10) Protect the power cord from being walked on or pinched particularly at plugs, convenience receptacles, and the point where they exit from the apparatus.
- 11) Only use attachments / accessories specified by the manufacturer.
- 12) Use only with the cart, stand, tripod, bracket, or table specified by the manufacturer, or sold with the apparatus. When a cart is used, use caution when moving the cart / apparatus combination to avoid injury from tip-over.
- 13) Unplug this apparatus during lightning storms or when unused for long periods of time.
- 14) Refer all servicing to qualified service personnel. Servicing is required when the apparatus has been damaged in any way, such as the power cord or plug is damaged, liquid has been spilled or objects have fallen into the apparatus, the apparatus has been exposed to rain or moisture, does not operate normally, or has been dropped.



# TABLE OF CONTENTS

<b>SAFETY PRECAUTIONS .....</b>	<b>2</b>	<b>INSTALLATION .....</b>	<b>11</b>
<b>IMPORTANT SAFETY INSTRUCTIONS .....</b>	<b>3</b>	INSTALLING / REMOVING THE BASE STAND .....	11
<b>TABLE OF CONTENTS .....</b>	<b>4</b>	MOUNTING ON THE WALL .....	11
<b>QUICK INSTALLATION .....</b>	<b>5</b>	<b>TV SETUP .....</b>	<b>12-13</b>
TURNING ON THE UNIT FOR THE FIRST TIME .....	5	PICTURE MENU .....	12
<b>ACCESSORIES .....</b>	<b>6</b>	AUDIO MENU .....	12
<b>GETTING STARTED .....</b>	<b>6</b>	TV MENU .....	13
USING THE REMOTE CONTROL .....	6	SETUP MENU .....	13
<b>CONTROL REFERENCE GUIDE .....</b>	<b>7-8</b>	<b>TROUBLESHOOTING GUIDE....</b>	<b>14</b>
REMOTE CONTROL .....	7	<b>MAINTENANCE .....</b>	<b>14</b>
TV .....	8	<b>LIMITED WARRANTY .....</b>	<b>15-16</b>
<b>CONNECTIONS .....</b>	<b>9-10</b>		
CONNECTING A TV ANTENNA / CABLE / SATELLITE .....	9		
CONNECTING TO A VCR / CAMCORDER / VIDEO GAME SYSTEM / CABLE / SATELLITE SYSTEM .....	9		
CONNECT THE POWER CORD .....	10		
<b>USING HEADPHONES .....</b>	<b>10</b>		

# QUICK INSTALLATION

When you turn on your television set for the first time, be sure to place it on a solid stable surface. To avoid danger, do not expose the TV to water, or a heat source (e.g. lamp, candle, radiator). Do not obstruct the ventilation grid at the rear and be sure to leave sufficient gaps around the unit as shown.

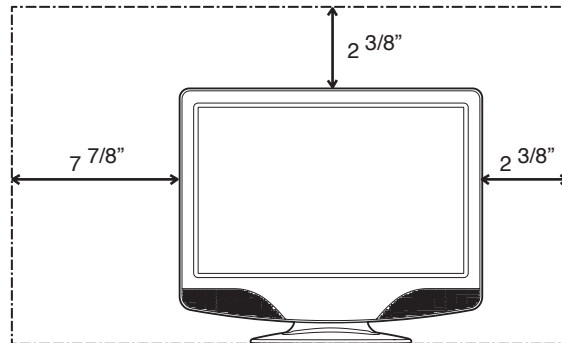

1. Connect an antenna or Cable TV COAX cable to the TV's antenna input jack.
2. Connect the power cord.
3. Press the **⏻** / ON button to turn on the unit.
4. Use the **▲** / **▼** button to highlight **OSD Language**, then press the **ENTER** or **▶** button to select the menu language from English / Español / Français.
5. Press the **▲** / **▼** button to highlight Antenna, then use the **ENTER** or **▶** button to select "Air", "Cable STD", "Cable HRC", "Cable IRC" or "Cable Auto".
6. Use the **▲** / **▼** button to highlight Auto Scan, then press the **ENTER** or **▶** button to confirm.
7. The unit will immediately search all channels for those with adequate signal strength and store those channels with signals in memory. The unit will take a few minutes to finish auto scan and after this is completed, the unit will switch to the first channel found.

If you subscribe to Cable TV Service, we recommend you pick "Cable Auto", however you might find you get improved results using "Cable STD", "Cable IRC", or "Cable HRC" - these are different standards used by various Cable Systems.

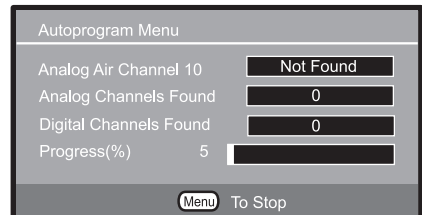
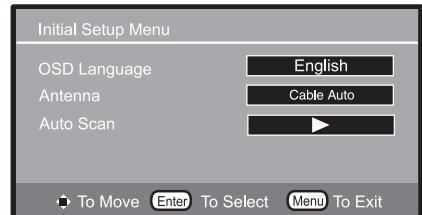

## TURNING ON THE UNIT FOR THE FIRST TIME

The first time you turn on the unit, the unit will enter the setup mode. You can easily follow the prompt message on the screen to complete basic TV settings.

Make sure the TV antenna or CATV cable has been connected properly to the TV antenna input jack on the rear of the system.

# ACCESSORIES

## PLEASE CHECK AND IDENTIFY THE SUPPLIED ACCESSORIES.

- Remote control (with batteries) ..... x 1

# GETTING STARTED

## USING THE REMOTE CONTROL

- Point the remote control at the remote sensor located on the unit.
- When there is a strong ambient light source, the performance of the infrared remote sensor may be degraded, causing unreliable operation.
- The recommended effective distance for remote operation is about 16 feet (5 meters).

## TO INSTALL THE BATTERIES

1. Open the battery door.

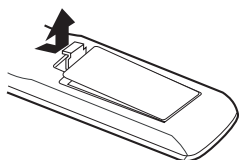

2. Insert 2xAAA batteries

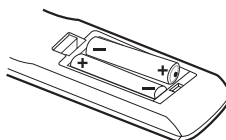

## BATTERY REPLACEMENT

When the batteries become weak, the operating distance of the remote control is greatly reduced and you will need to replace the batteries.



### CAUTION:

Danger of explosion if battery is incorrectly replaced. Replace only with the same or equivalent type.

### NOTES

- If the remote control is not going to be used for a long time, remove the batteries to avoid damage caused by battery leakage corrosion.
- Do not mix old and new batteries. Do not mix ALKALINE, standard (CARBON-ZINC) or rechargeable (NICKEL-CADMIUM) batteries.
- Always remove batteries as soon as they become weak.
- Weak batteries can leak and severely damage the remote control.



### WARNING:

- Do not dispose of batteries in a fire. Batteries may explode or leak.
- Batteries shall not be exposed to excessive heat such as sunshine, fire or the like.

# CONTROL REFERENCE GUIDE

## REMOTE CONTROL

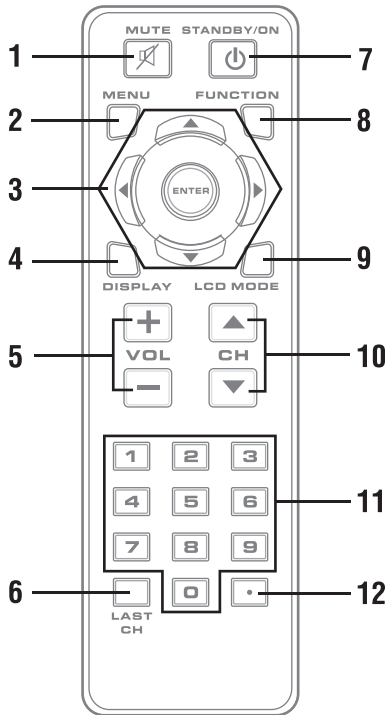

- 1) MUTE Button  
Press to turn off the sound.
- 2) MENU Button  
Press to display the on-screen menu or switch back to the previous menu screen.
- 3) CURSOR (▲, ▼, ◀, ▶) Buttons  
Use to highlight selections on a menu screen and adjust certain settings.  
ENTER Button  
Confirm selection on a menu screen.
- 4) DISPLAY Button  
Press to display information on the current channel.
- 5) VOL + / VOL - Button  
Press to increase/decrease the volume.
- 6) LAST CH  
Press to switch repeatedly between the last two channels displayed.
- 7) STANDBY/ON Button  
Press to turn ON the unit or put it in STANDBY (OFF) mode.
- 8) FUNCTION Button  
Press to switch between TV / AV.
- 9) LCD MODE Button  
Press to Select from preset screen display settings to match the type of show you are watching.
- 10) CH ▲ / CH ▼ Buttons  
Press to select the channel upward or downward.
- 11) NUMERIC Buttons  
Press to enter numbers or go directly to a specific channel.
- 12) • [dot] Button  
Press to enter digital sub-channels with the numeric buttons (i.e. 11.3 or 12-1).

# CONTROL REFERENCE GUIDE

## TV

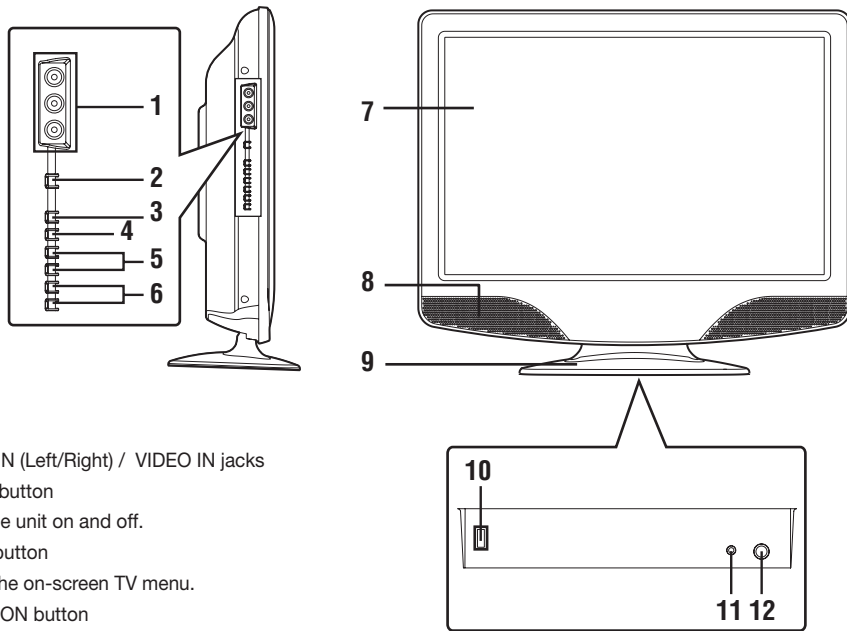

1. AUDIO IN (Left/Right) / VIDEO IN jacks
2. **⏻** / ON button  
Turns the unit on and off.
3. MENU button  
Enters the on-screen TV menu.
4. FUNCTION button  
Selects TV / AV.
5. CH **▲** / CH **▼** buttons  
Press to confirm selections on the TV menu screen and **▲** / **▼** to change TV channels.
6. VOL + / VOL - controls  
Adjusts the volume level and highlights selections (Left & Right) on the TV menu screen.
7. Color LCD screen
8. Remote sensor  
Point the remote control here.  
Standby indicator
9. Removable stand
10. Power cord
11. Headphones jack
12. TV ANTENNA terminal  
Connects a TV antenna or CATV cable.



# CONNECTIONS

## CONNECTING A TV ANTENNA

To view television channels correctly, a signal must be received from one of the following sources:

- An indoor or outdoor aerial antenna
- A cable system
- A satellite system

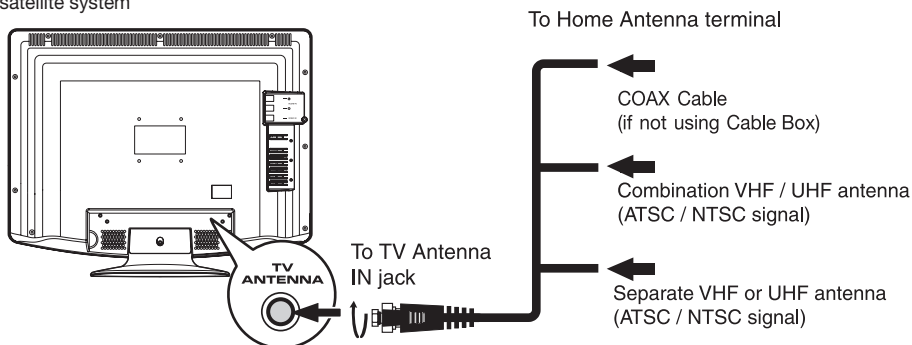

### NOTE

For optimal reception of over-the-air TV broadcasts, we recommend that you use an external fixed antenna. If using an indoor antenna, please ensure that you purchase an antenna with sufficient ability to receive signals in your home. Orientation and location of the antenna is typically critical for best results – you may find that placement of the antenna near a window, or in an elevated location, improves performance.

## CONNECTING TO A VCR / CAMCORDER / VIDEO GAME SYSTEM / CABLE / SATELLITE SYSTEM

Connect an AUDIO / VIDEO cable (not included) as shown:

Make sure you connect the cable from the AUDIO/VIDEO OUT jack of the other equipment to AUDIO/VIDEO IN jack of this unit.

### NOTE

Please refer to the connected equipment's user manual for more information.

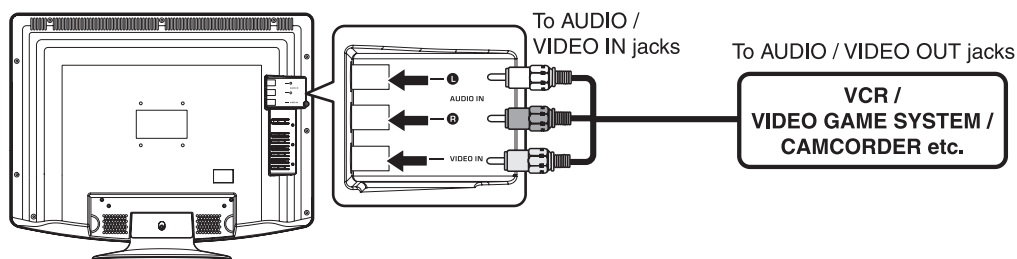

# CONNECTIONS

## CONNECT THE POWER CORD

- Connect the AC power cord into a wall outlet.
- Press the  / I button on the unit or remote control to turn on the unit.

### NOTE

- Be sure the AC power cord is disconnected and all functions are off before making connections.
- Make sure that all the components are connected correctly.
- **To prevent electrical shock, match wide blade of plug to wide slot of wall outlet, then fully insert.**
- When you are not going to use the unit for a long period of time, disconnect the power cord.

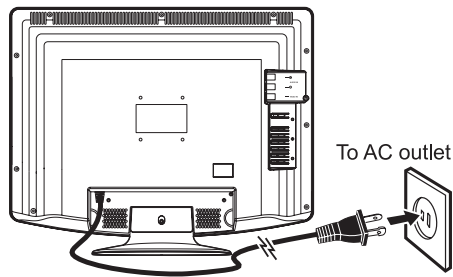

# USING HEADPHONES/EARPHONES

- Turn down the volume before connecting headphones/earphones to the unit, then adjust the volume to your desired level.
- When headphones/earphones are connected, no sound will come from the front speakers.

### NOTE

Avoid listening to sound at high levels for prolonged periods of time. This may be harmful to you and may cause hearing loss.

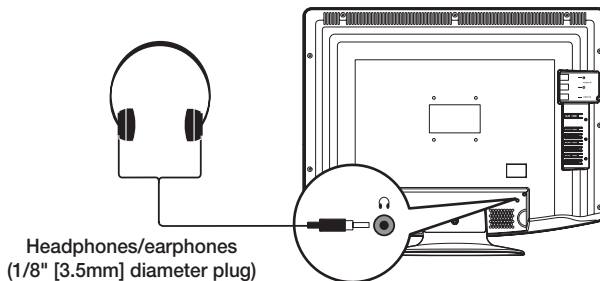

GB - 10

# INSTALLATION

## INSTALLING / REMOVING THE BASE STAND

**WARNING:** The LCD Display is very fragile, and must be protected at all times when removing the base stand. Be sure that no hard or sharp object, or anything that could scratch or damage the LCD display, comes into contact with it.

**Do NOT** exert pressure on the front of the unit at any time because the screen could crack.

1. Disconnect all cables or cords connected to the unit.
2. Lay the unit down on a flat surface with the back side facing up. Please make sure to place a soft cushioned material (such as a pillow or thick piece of foam) beneath the screen.

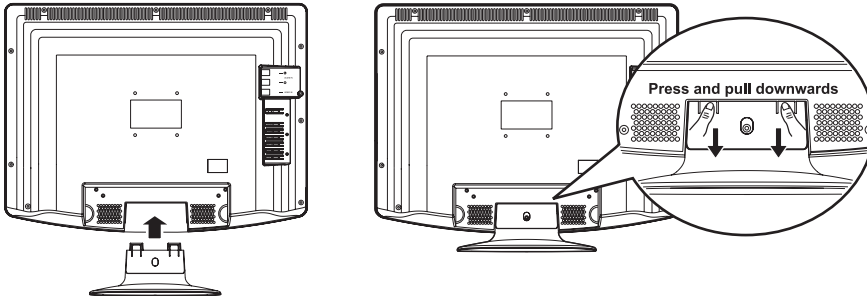

3. To install the base stand, place the base stand on the mounting slot, push the stand till it locks.
4. To remove the base stand, keep pressing the locking area of the base stand and pull downwards to release the base stand.

## MOUNTING ON THE WALL

This unit is VESA-compliant, and is designed to be wall-mounted with a VESA-compliant 3" x 3" (75mm x 75mm) mounting kit designed for flat-panel TVs (sold separately). Mount this unit according to the instructions included in the mounting kit.

### NOTE

Remove the base stand before mounting the unit on the wall.

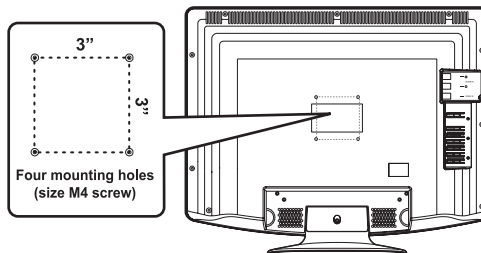

# TV SETUP

## PICTURE MENU

1. Press the MENU button.
2. Press ENTER or ► button to highlight Picture Mode.
3. Use the ▲ or ▼ button to select other options (Contrast, Brightness, Sharpness, Color, Tint, Aspect Ratio & Color Temperature).
4. Use the ENTER or ► button to make adjustment. The screen will adjust to your selected setting immediately.
5. Repeat steps 3 to 4 to adjust other options.
6. Press ◀ button to return to the previous menu.
7. To exit the TV SETUP MENU and return to the normal screen, press the MENU button.

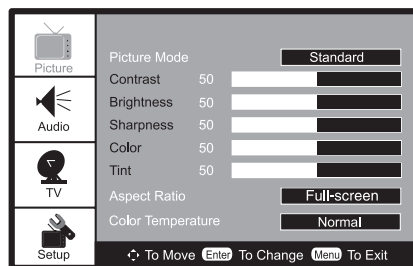

- Picture Mode:** Select from preset screen display settings to match the type of show you are watching (Standard, Soft, Movie & Personal).
- Contrast:** Adjust the contrast of picture. The dark portions of the picture become richer in darkness and the light portions become brighter.
- Brightness:** Adjust to brighten or darken the whole picture.
- Sharpness:** Adjust the sharpness level to improve detail in the picture.
- Color:** Adjust the color of the picture.
- Tint:** Adjust natural skin tones in the picture quality.
- Aspect Ratio:** Select from preset aspect ratio to match the type of show you are watching (Full-screen, 4:3, Zoom, Wide & Auto\*). \*Auto is for DTV only.
- Color Temperature:** Adjust the 3 color temperature of the picture. Choose from Normal (balanced), Warm (red white) or Cool (blue white) modes.

## AUDIO MENU

1. Press the MENU button.
2. Use the ▲ or ▼ button to select Audio setting.
3. Press ENTER or ► button to highlight Audio Mode, then use the ▲ or ▼ button to select other options (Audio Language, MTS, Bass, Treble & Balance).
4. Use the ENTER or ► button to make adjustment.
5. Repeat steps 3 to 4 to adjust other options.
6. Press ◀ button to return to the previous menu.
7. To exit the TV SETUP MENU and return to the normal screen, press the MENU button.

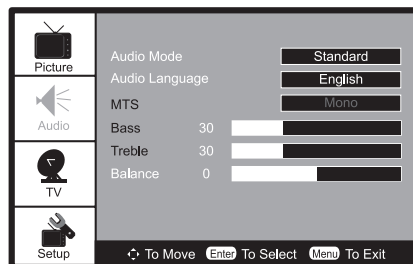

- Audio Mode:** Select from preset audio settings (Standard, Movie, Music & Personal) to match the type of show you are watching.
- Audio Language:** Select from English / Spanish / French. (Available for digital channels if multiple audio languages are broadcasted.)
- MTS (Multi Channel Television Sound):** Select Stereo / SAP (Secondary Audio Program) / Mono.
- Bass:** Adjust the bass range.
- Treble:** Adjust the treble range.
- Balance:** Adjust the balance level toward the left or right speakers.

### Note:

Some TV stations broadcast audio in more than one language, the SAP (Secondary Audio Programs) feature allows you to listen to this, if available.

# TV SETUP

## TV MENU

1. Press the MENU button.
2. Use the ▲ or ▼ button to select TV setting.
3. Press ENTER or ► button to highlight Antenna, then use the ▲ or ▼ button to select other options (DTV Signal, Auto Scan, Auto Scan Add CH, Channel Skip & Channel Labels).
4. Use the ENTER or ► button to make adjustment. The screen will adjust to your selected setting immediately.
5. Repeat steps 3 to 4 to adjust other options.
6. Press ◀ button to return to the previous menu.
7. To exit the TV SETUP MENU and return to the normal screen, press the MENU button.

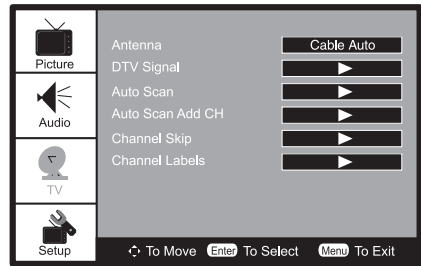

## NOTE

- Channel No. : 2-69 Channel for Air, 1-135 Channel for CATV.
- Antenna : Select "Air, Cable STD, Cable HRC, Cable IRC & Cable Auto" to receive over-the-air signal / cable signal.
- DTV Signal : Display the signal strength (for digital TV channels only).
- Auto Scan : Search for available stations and store them in memory.
- Auto Scan Add CH : Search for more available stations and add them in memory. The stations stored before are still kept.
- Channel Skip: Skip weak channels and the channels you don't like.
- Channel Labels : Display and edit the channel label.

## SETUP MENU

1. Press the MENU button.
2. Use the ▲ or ▼ button to select Setup setting.
3. Press ENTER or ► button to highlight Time Setting, then use the ▲ or ▼ button to select other options (Time Setting, Sleep Timer, Password Setting, Parental Control, Closed Caption, OSD Language & Reset).
4. Use the ENTER or ► button to make adjustment.
5. Repeat steps 3 to 4 to adjust other options.
6. Press ◀ button to return to the previous menu.
7. To exit the TV SETUP MENU and return to the normal screen, press the MENU button.

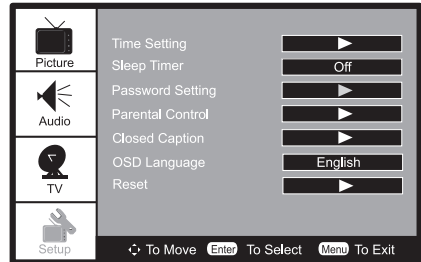

- Time Setting: Select to set the time manually or automatically.
- Sleep Timer: Set the LCD TV to turn itself off within a certain time (Off / 5 min / 10 min / 15 min / 30 min / 60 min / 90 min / 120 min).
- Password Setting: Enter a 4-digit password. Once entered, the screen will prompt you to enter new password and confirm your new password.
- Parental Control: Enter the 4-digit password to set the parental control. (If you forgot the password, enter "8888" to unlock the parental control.)
- OSD Language : Select the menu language from English / Español / Français.
- Reset : Reset the default settings.

## CLOSED CAPTION

Note : This function only works on programs broadcast with captions.

- CC Mode : Select closed caption On, Off or CC on Mute.
- Analog Closed Caption : Select the analog closed caption.
- Digital Closed Caption : Select the digital closed caption.
- Digital Caption Style : Select Custom to activate the caption style items and set your desired detailed settings.

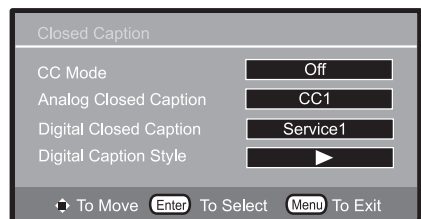

# TROUBLESHOOTING GUIDE

## SYMPTOM

## CAUSE (AND REMEDY)

No power.

- Check that the AC power cord is connected.
- The unit is not turned on.

The remote does not function.

- Remove any obstacles between the remote and the unit.
- Use the remote near the unit.
- Point the remote at the remote sensor on the unit.
- Replace the batteries in the remote with new ones.

## TV

Bad Picture (snow, multiple images, distortion, blurry)

- Check the location of the antenna and adjust it if necessary.
- Make sure the antenna cable is firmly connected.
- Make sure all input cables are firmly connected.

Black and white picture.

- Check the PICTURE MENU within the TV SETUP MENU.
- Check to make sure the program you are watching is broadcast in Color and not Black & White.

No picture or sound.

- Make sure the unit is plugged in and turned on.
- Make sure TV mode is selected.
- Try a new channel to check for possible station trouble.
- Make sure the antenna is connected properly.
- Increase the volume.
- Make sure the antenna or audio video source device is working properly.
- Make sure all cables are firmly connected.
- Check for local interference.

Colored patches of picture.

- Make sure there are no unshielded electrical devices nearby that are causing interference.
- Turn off the unit for 30 minutes, then try again.

Specifications and appearance are subject to change without notice.

# MAINTENANCE

## CLEANING THE UNIT

- Be sure to turn the unit off and disconnect the AC power cord before maintaining the unit.
- Wipe the unit with a dry soft cloth. If the surfaces are extremely dirty, wipe clean with a cloth that has been dipped in a weak soap-and-water solution and wrung out thoroughly. Wipe with a dry cloth.
- Never use alcohol, benzine, thinner, cleaning fluid or other chemicals. Do NOT use compressed air to remove dust.

# LIMITED WARRANTY

VENTURER ELECTRONICS ("VENTURER") makes the following limited warranty. This limited warranty extends to the original consumer purchaser and is limited to non-commercial use of the product.

## **NINETY (90) DAY PARTS & LABOR WARRANTY**

VENTURER products purchased in the United States are warranted to be free from defects in materials or workmanship for a period of ninety (90) days from the date of their original retail purchase. If the unit fails to conform to this warranty, we will service the product using new or refurbished parts and products, at VENTURER's sole discretion.

During a period of ninety (90) days from the effective warranty date, VENTURER will provide, when needed, service labor to repair a manufacturing defect at its designated Service Center. To obtain warranty service in the United States, you must first call our Customer Support Center at 1-866-444-6478 or 1-800-252-6123, during the hours listed in the box below. The determination of service will be made by VENTURER Customer Support. **PLEASE DO NOT RETURN YOUR UNIT TO VENTURER WITHOUT PRIOR AUTHORIZATION.** New or remanufactured replacements for defective parts or products will be used for repairs by VENTURER at its designated Service Center for ninety (90) days from the effective warranty date. Such replacement parts or products are warranted for an additional ninety (90) days from the date of repair or replacement. The Customer will be required to ship the unit to the Service Center indicated at the time Customer Support is contacted to make the necessary repairs. The customer is responsible for all transportation charges to the service facility.

## **PACKAGING AND SHIPPING INSTRUCTION**

When you send the product to the VENTURER service facility you must use the original carton box and packing material or an equivalent as designated by VENTURER.

## **LIMITED WARRANTY**

Your Responsibility

- (1) You must retain the original sales receipt to provide proof of purchase.
- (2) These warranties are effective only if the product is purchased and operated in the U.S.A. or Canada.
- (3) Warranties extend only to defects in material or workmanship, and do not extend to any product or parts which have been lost or discarded, or damage to product or parts caused by misuse, accident, improper operation or maintenance, or use in violation of instructions provided with the product, or to product which has been altered or modified without authorization of VENTURER, or to products or parts thereof which have had the serial number removed or changed.

## **OUT OF WARRANTY**

In the event your product requires repair after the limited warranty period has expired, please contact our Customer Support Center at **1-866-444-6478, 1-800-252-6123 or [www.venturer.com](http://www.venturer.com).**

**Hours: Monday-Thursday: 9am - 7pm, Friday: 9am - 5pm, Saturday: 9am - Noon, Eastern time.**

Important: You are responsible for any transportation, shipping or insurance relative to the return of product to our Product Returns Center.



# LIMITED WARRANTY

All warranties implied by state law, including the implied warranties of merchantability and fitness for a particular purpose, are expressly limited to the duration of the limited warranties set forth above. With the exception of any warranties implied by state law as hereby limited, the foregoing warranty is exclusive and in lieu of all other warranties, guarantees, agreements and similar obligations of manufacturer or seller with respect to the repair or replacement of any parts. In no event shall VENTURER be liable for consequential or incidental damages.

No person, agent, distributor, dealer or company is authorized to change, modify or extend the terms of these warranties in any manner whatsoever. The time within action must be commenced to enforce any obligation of VENTURER arising under the warranty or under any statute, or law of the United States or any state thereof, is hereby limited to ninety (90) days from the date of purchase. This limitation does not apply to implied warranties arising under state law.

This warranty gives you specific legal rights and you may also have other rights, which may vary, from state to state. Some states do not allow limitation on how long an implied warranty lasts, when an action may be brought, or the exclusion or limitation of incidental or consequential damages, so the above provisions may not apply to you.

For more information on other products and services, please visit our web site at [www.venturer.com](http://www.venturer.com).

Important: Also keep your "Bill of Sale" as proof of purchase.

Serial no..... Invoice no.....  
Date purchased ..... Dealer name .....

FOR SERVICE AND REPAIR, PLEASE VISIT [www.venturer.com](http://www.venturer.com)



As concerns grow about the environmental impact of outdated electronic products, Venturer Electronics is committed to being a part of the solution. Free of charge, Venturer Electronics customers can return qualifying units to us for recycling. For more details, please visit our website at [www.venturer.com/recycle](http://www.venturer.com/recycle) or call 1-800-252-6123.

811-761991W030  
Printed in China





## Free Manuals Download Website

<http://myh66.com>

<http://usermanuals.us>

<http://www.somanuals.com>

<http://www.4manuals.cc>

<http://www.manual-lib.com>

<http://www.404manual.com>

<http://www.luxmanual.com>

<http://aubethermostatmanual.com>

Golf course search by state

<http://golfingnear.com>

Email search by domain

<http://emailbydomain.com>

Auto manuals search

<http://auto.somanuals.com>

TV manuals search

<http://tv.somanuals.com>