

COMDIAL®

DXP, DXP *Plus*, and FX Series
Digital Communications Systems

Impact • *Impact*
SCS

LCD Speakerphone
System Reference Manual

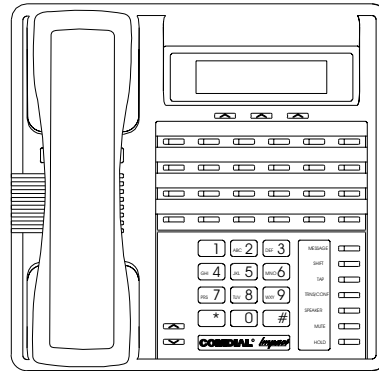
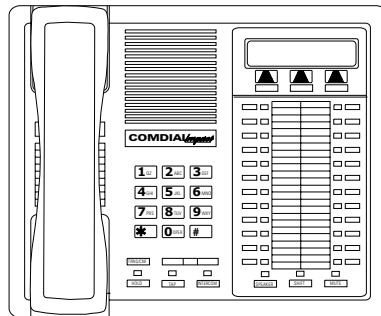

This reference manual applies to the following system and telephone models:

System Models:

- DXP systems with software 12A and later.
- DXP Plus systems with software 12A and later.
- FX Series with software 12A and later.

Telephone Models:

- Impact 8012S-** Rev. A and later.
- Impact 8024S-** Rev. A and later.
- Impact SCS 8324S-** Rev. A and later.
- Impact SCS 8312S-** Rev. A and later.
- Impact SCS 8324F-** Rev. A and later.

Contact your Comdial dealer for updates of this as well as other Comdial publications.



* Tri-Level Compression is a registered trademark of ACS Wireless, INC.

Comdial's Quality Management System Is Certified To The ISO 9001 Standard.

Comdial® strives to design the features in our communications systems to be fully interactive with one another. However, this is not always possible, as the combinations of accessories and features are too varied and extensive to insure total feature compatibility. Accordingly, some features identified in this publication will not operate if some other feature is activated.

Comdial® disclaims all liability relating to feature non-compatibility or associated in any way with problems which may be encountered by incompatible features. Notwithstanding anything contained in this publication to the contrary, Comdial® makes no representation herein as to the compatibility of features.

2/12/97

Contents

1 Introducing The LCD Speakerphone 1-1

1.1 Using This Guide 1-1

1.2 Using Your Speakerphone 1-3

1.3 Understanding The Display Abbreviations 1-8

1.4 Knowing Your Speakerphone's Functions 1-12

1.5 Understanding What The Lights Mean 1-14

1.6 Adjusting The Telephone Pedestal 1-16

2 Answering Calls 2-1

2.1 Answering Outside Calls 2-1

2.2 Answering Intercom Calls 2-2

2.3 Answering Calls at Monitored Stations 2-3

2.4 Answering Night-Transferred Calls 2-4

2.5 Making A Call Pick-Up 2-5

2.6 Responding To A Subdued
Off-Hook Voice Voice Announcement 2-6

3 Making Calls 3-1

3.1 Dialing Manually 3-1

3.2 Dialing Automatically 3-2

3.3 Using Dial By Name 3-3

3.4 Redialing A Previously Dialed Number 3-4

3.5 Using Line Groups 3-8

3.6 Waiting For A Line (Queuing) 3-9

3.7 Making Intercom Calls 3-10

3.8 Camping On At A Busy Station and
Waiting For An Automatic Callback 3-11

3.9 Camping On At An Idle Station and
Waiting For An Automatic Callback 3-12

3.10 Camping On At A Busy Station
And Waiting For An Answer 3-12

3.11 Overriding A Call Or A Do Not Disturb
Condition At Another Telephone 3-13

3.12 Making A Subdued Off-Hook Voice
Announcement (SOHVA) 3-14

4	Placing Calls On Hold.....	4-1
4.1	Holding Calls.....	4-1
4.2	Handling Hold Recalls.....	4-4
4.3	Parking Calls.....	4-5
4.4	Handling Park Recalls.....	4-6
5	Transferring Calls.....	5-1
5.1	Transferring Calls—Screened.....	5-1
5.2	Transferring Calls—Unscreened.....	5-3
5.3	Making A Hot Transfer.....	5-4
5.4	Transferring Calls Using Quick Transfer.....	5-5
6	Conferencing Calls.....	6-1
6.1	Conferencing Telephones Together.....	6-1
7	Using The Other Telephone Features.....	7-1
7.1	Adjusting The Display Contrast.....	7-1
7.2	Blocking Voice-Announce Calls.....	7-1
7.3	Displaying Status Of Busy Lines And Stations (Busy Button Inquiry).....	7-2
7.4	Displaying Button Functions (Button Query).....	7-3
7.5	Diverting Incoming Calls To Another Station.....	7-3
7.6	Entering Account Codes.....	7-4
7.7	Entering Authorization Codes.....	7-5
7.8	Forwarding Calls.....	7-6
7.9	Listening To A Call Over The Telephone Speaker.....	7-7
7.10	Making A Call Non-Private (Privacy Release).....	7-8
7.11	Monitoring A Conversation Between Two Telephones (Service Observing).....	7-9
7.12	Muting Your Telephone.....	7-10
7.13	Sending A Paging Announcement.....	7-10
7.14	Setting A Do Not Disturb Condition At Your Station.....	7-12
7.15	Setting The Volume Control.....	7-13
7.16	Setting Your Personal Ringing Tones.....	7-15
7.17	Switching The Dialing Mode Between Pulse And Tone.....	7-16
7.18	Using Background Music.....	7-16

7.19	Using Direct Inward System Access (DISA)	7-17
7.20	Using The Auxiliary Jack	7-20
7.21	Using The Tracker Paging System	7-22
7.22	Using E And M Tie Lines	7-24
7.23	Call Forward Outside System	7-26
7.24	Mark Problem Line	7-28
7.25	Automatic Set Relocation	7-29
7.26	Using The IMIST Module	7-30
7.27	Using The Caller ID Feature	7-31
8	Sending And Receiving Non-Verbal Messages	8-1
8.1	Lighting The Message-Waiting Light	8-1
8.2	Sending LCD Messages	8-3
8.3	Sending Response Messages	8-5
9	Programming Your Telephone	9-1
9.1	Programming For Speed Dialing	9-1
9.2	Storing Speed Dial Numbers	9-2
9.3	Storing DSS Numbers	9-3
9.4	Using The Feature Buttons	9-5
9.5	Storing The Response Message Button	9-7
9.6	Storing Access Codes	9-8
9.7	Setting A Reminder Alert	9-9
10	Using The Attendant Features	10-1
10.1	Creating LCD Messages	10-1
10.2	Disabling A Station	10-5
10.3	Disabling A Telephone Line	10-6
10.4	Enabling Or Disabling Message Waiting	10-7
10.5	Naming The System Telephones	10-8
10.6	Naming The Telephone Lines	10-12
10.7	Printing Station Message Detailed Accounting (SMDA) Reports	10-15
10.8	Setting The Night Transfer Of Ringing Mode	10-18
10.9	Setting The System Clock	10-19
10.10	Storing The System Speed Dial Numbers	10-20

10.11 Transferring The Attendant Calls To The Alternate Attendant Telephone	10-22
10.12 Using The Overflow Transfer	10-23
10.13 Using The Digital Voice Announce Option	10-24
10.14 Using The Special Attendant Buttons	10-30
10.15 Viewing The System Status Log	10-33
10.16 Operating Your Telephone With A DSS/BLF Console	10-35
11 Troubleshooting Your Telephone	11-1
Index	Index-1
Quick Reference Guide	Quick Reference-1

1

Introducing The LCD Speakerphone

1.1 Using This Guide

This user's guide describes your LCD speakerphone and tells you how to use it.

The sections in this introductory chapter help you become familiar with your speakerphone's controls and indicators. The remaining sections are titled as follows:

- 1.2 Using Your Speakerphone
- 1.3 Understanding the Display Abbreviations
- 1.4 Knowing Your Speakerphone's Functions
- 1.5 Understanding What The Lights Mean

The operation chapters define often-used features and provide instructions for their use. These chapters are titled as follows:

- 2 **Answering Calls**
- 3 **Making Calls**
- 4 **Placing Calls On Hold**
- 5 **Transferring Calls**
- 6 **Conferencing Calls**

The special-purpose features of the telephone are grouped into one chapter:

- 7 **Using The Other Telephone Features**

Your telephone provides several non-verbal ways to communicate using lights and indicators. The descriptions of these methods are provided in a separate chapter:

8 Sending And Receiving Non-Verbal Messages

You can program many of the buttons on your telephone to enhance the unit's versatility and usability. These programming instructions are found in the following chapter:

9 Programming Your Telephone

For your convenience, a troubleshooting chart is provided in the following chapter:

10 Using The Attendant Features

If you operate an attendant station, you will use the special features provided in the following chapter:

11 Troubleshooting Your Telephone

There is a quick reference chart in the following chapter:

Appendix A Quick Reference Guide

1.2 Using Your Speakerphone

When using your speakerphone, the microphone and loudspeaker are farther away from you than when you use a handset. Both the signal from the loudspeaker and the signal to the microphone must be strengthened. When microphones and loudspeakers are close together (such as in a speakerphone), additional amplification typically generates a ringing sound (public address systems do this if the volume is too high or the microphone is too close to a loudspeaker).

NOTE: The 8324F-** speakerphone can function in the full-duplex or half-duplex mode. Both sets of guidelines (section 1.2.1 and section 1.2.2) are applicable to the 8324F-**. The 8012S-**, 8024S-**, 8324S-**, and 8312S-** speakerphones only function in the half-duplex mode—only section 1.2.2, Speakerphone User Guidelines, apply to these telephones.

1.2.1 Using A Full-Duplex Speakerphone

The *Impact SCS* 8324F-** speakerphone uses the latest full-duplex speakerphone technology. (Full-duplex technology enables both parties on a speakerphone call to speak simultaneously—half-duplex speakerphones allow only one person to speak at a time.) The 8324F-** will operate in either full-duplex or half-duplex mode depending on the current line conditions. For example, satellite calls or calls with a delay involved may prevent the telephone from operating in full-duplex mode.

At the beginning of each call the telephone must perform a “speech training” test. To achieve optimum performance from the full-duplex speakerphone, Comdial recommends that each user in turn speak about 10 consecutive words to allow the telephone to “train” itself. Note that during the “speech training” test, the speakerphone is operating in half-duplex mode.

Depending on the telephone line conditions and the type of speakerphone at the other end, it may not be possible for the 8324F-** to operate in full-duplex mode. If the speakerphone at the other end is a half-duplex speakerphone and both parties are in speakerphone mode, the half-duplex speakerphone is the controlling factor, preventing the 8324F-** from operating in full-duplex mode.

NOTE: Pressing any button (mute, hold, etc.) on the speakerphone while in full-duplex mode causes the system to perform the “speech training” test again. For example, if you press MUTE while in full-duplex mode, when you release the call from mute, the system will perform the entire “speech training” test again.

1.2.2 Speakerphone User Guidelines

*NOTE: The speakerphone user guidelines in this section do not apply to the Impact SCS 8324F-** when it is operating in full-duplex mode. However, when the 8324F-** is in half-duplex mode or in “speech training” mode, the following guidelines are applicable.*

- Both parties can not talk at the same time. You must wait for silence out of your loudspeaker before talking. You must stop talking to hear the other party.
- Background noise may prevent the sound-activated switches from operating properly. Avoid placing the speakerphone where it will detect sounds from typewriters, keyboards, printers, paging systems, and other equipment.
- Speak slightly louder than normal and with a clear, authoritative voice. For the microphone to best detect your voice, speak within three feet of it and face the telephone.
- Raising the volume of the loudspeaker makes it easier for the sound-activated switches in your telephone to select the distant party’s voice. Lowering the volume of the loudspeaker makes it easier for the switches to select your voice.
- Since the system takes several seconds to provide the best switching, constant sound patterns—such as elongating your words and playing externally-supplied music—may prevent the sound-activated switches from operating properly.
- Place the telephone on a hard surface and away from table edges. Do not place the telephone in corners or enclosures. Do not let obstructions come between you and the microphone. Rooms with hard, flat surfaces that reflect sound may affect the sound-activated switches.

- If you are using a handset and the other party is using a speakerphone, avoid breathing heavily into your microphone. Avoid other sounds that may affect the distant telephone's sound-activated switches.
- In some situations, such as when either you or the distant party are in a noisy environment, you may have to lift your handset to ensure a clear conversation.
- When both you and the distant party use speakerphones, the sound-activated switches can occasionally detect both voices simultaneously, thus blocking out both voices.
 - **To manually place a call using your speakerphone,**
 1. Press the **INTERCOM** or line button.
 2. Dial the number.
 3. When party answers, speak toward the telephone.
 - **To automatically dial a number using your speakerphone,**
 1. Press the preprogrammed speed dial or DSS button and speak toward the telephone when your party answers.
 - **To answer a call with your speakerphone,**
 1. Press the **INTERCOM** or line button with flashing red or orange light.
 2. Speak toward the telephone to answer the call.
 3. To end a call with your speakerphone, just press **SPEAKER**.

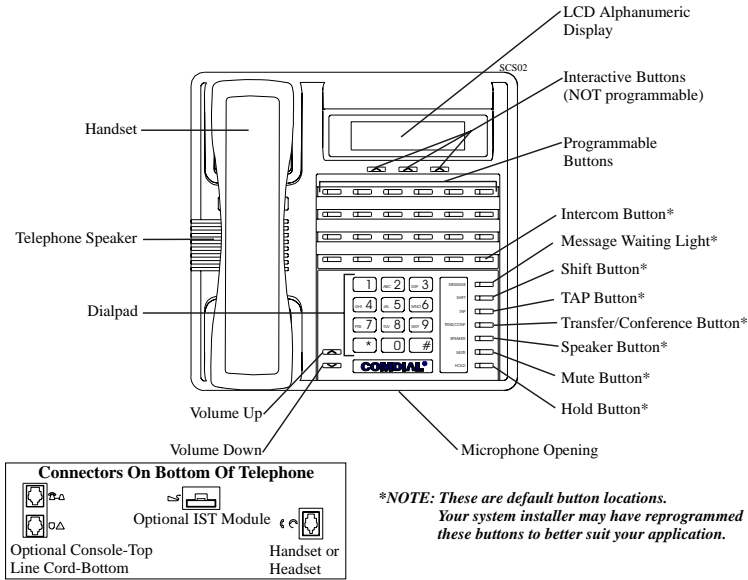

Impact SCS 8324F-** and Impact SCS 8324S-**

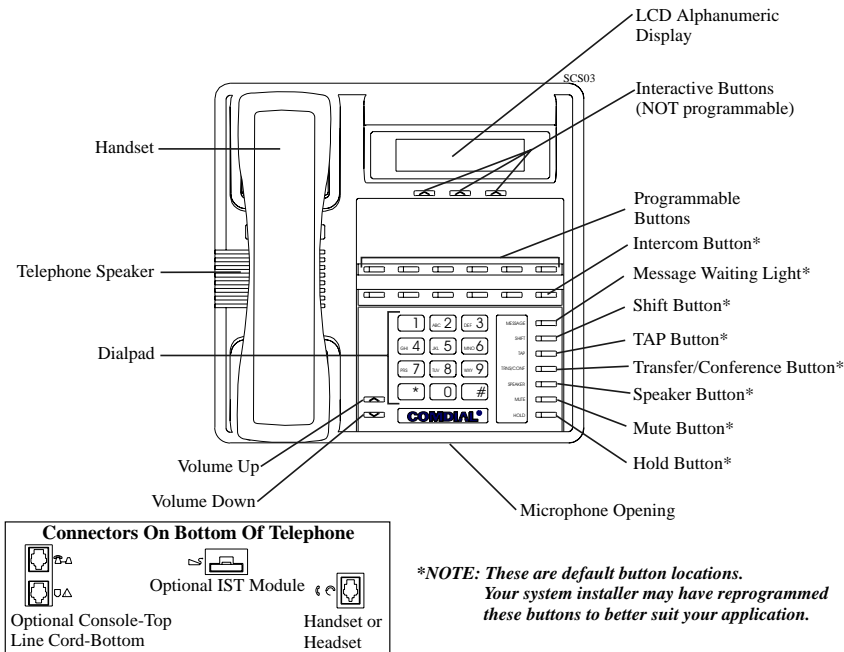

Impact SCS 8312S-**

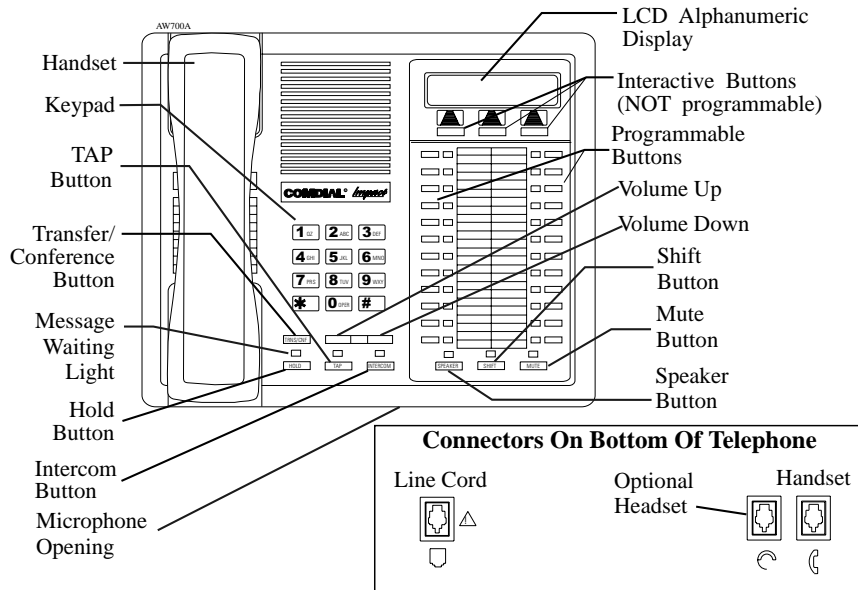

Impact 8024S-** LCD Speakerphone

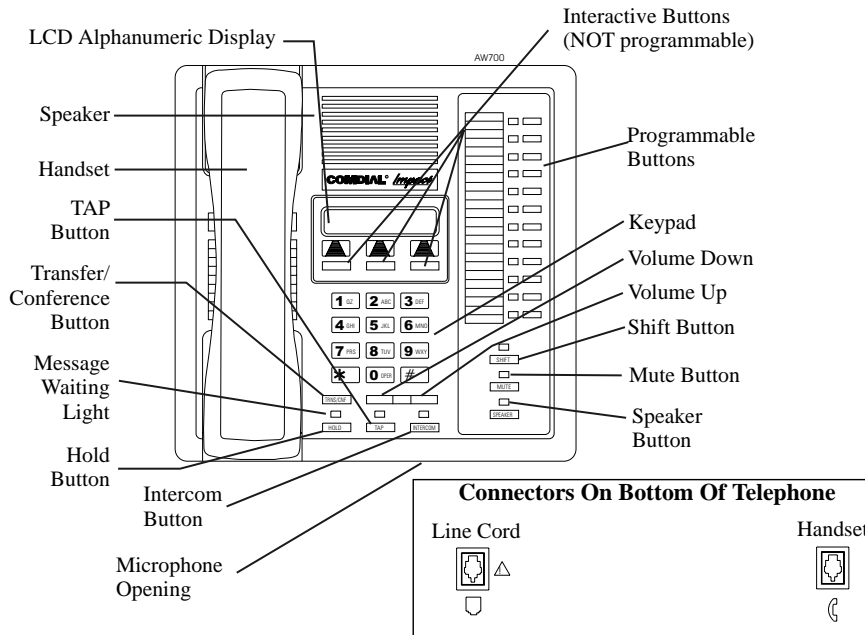

Impact 8012S-** LCD Speakerphone

1.3 Understanding The Display Abbreviations

This chart identifies the interactive button abbreviations that appear in your display.

Abbreviation	Feature	Definition
ACCT	Account	Stores a button that enables account code entry.
ALERT	Set Reminder	Sets two reminder alerts that will sound at your station at specified times.
ALL	All Calls Forward	Route all of your calls to a different station location.
ANS	Answer	Answers a call ringing at your station.
APAGE*	Auxiliary Pager	Stores a button that selects auxiliary paging speaker operation through the auxiliary jack.
ARECD*	Auxiliary Recorder	Stores a button that selects tape recorder operation through the auxiliary jack.
ARING*	Auxiliary Ringer	Stores a button that selects auxiliary ringer operation through the auxiliary jack.
ARDL	Automatic Redial	Redials a busy call once a minute for 10 minutes.
BKSP	Backspace	While programming a speed dial number, backspace erases an incorrect entry.
CALL	Call	Calls a station that turned on your message waiting light.
CAMP	Camp On	Has system call you when busy station becomes idle. When chosen as a feature, stores a button that enables the function.
CFWD	Call Forward	Forwards all of your calls to a different station location. When chosen as a feature, stores a button that enables the function

Abbreviation	Feature	Definition
CALLBK	I Will Call Back	Respond to a SOHVA call with a non-verbal message.
CLEAR	Clear Features	Stores a button that clears a currently active or engaged feature.
CLR	Clear	Cancels a call forward condition.
CONF	Conference	Establishes a conference.
DARK	Dark (contrast)	Makes LCD screen darker.
DISP	Display	Adjusts the contrast of your LCD screen.
DND	Do Not Disturb	Makes your station appear busy to other stations. When chosen as a feature, stores a button that enables the function.
DSS	Direct Station Select	Stores a personal intercom number at a DSS button.
EXIT	Exit Selection	Ends a current programming session.
FEAT	Feature	Presents several different features you can store at programmable buttons for later use.
GPLSN	Group Listen	When chosen as a feature, stores a button that enables loud speaker broadcast of distant party's voice.
HDSET	Headset	When chosen as a feature, stores a button that enables headset operation.
HAVE HOLD	Ask Caller To Hold	Send a non-verbal response to a SOHVA caller so he or she will know to place the outside caller on hold.
LIGHT	Light (contrast)	Makes the LCD screen lighter.

Abbreviation	Feature	Definition
MSG	Message	Turns on message waiting light at another station.
MUSIC	Background Music	Turn on the background music at your station. When chosen as a feature, stores a button that enables the function.
NEXT	Next Display	Shows the next display.
NoANS	No Answer/Forward	Forwards calls that ring at your station but receive no answer.
OPTIONS	Options	Selects interactive button features.
OVER	Override	Overrides either a do-not-disturb condition or a busy signal at a station you have called.
PAGE	Paging Zone	When chosen as a feature, stores a button that provides one-button access to paging.
PARK	Park Orbit	When chosen as a feature, stores a button that provides one-button parking of calls.
PCKUP	Pick Up	When chosen as a feature, stores a button that allows you to pick up a call ringing elsewhere.
PERS	Personal	Route your personal intercom calls to a different station location.
PRIV	Privacy	When chosen as a feature, stores a button that releases privacy for a current call.
QUERY	Button Query	Displays program status of any button.
RECON	Reconnect	Reconnect you to a transferred call.
RING	Ring Tone	Select different ringing tones.

Abbreviation	Feature	Definition
SAVE	Save Number	Permanently saves last number you dialed. When chosen as a feature, stores a button that provides the function.
SDIAL	Speed Dial	Programs a number for one-button calling.
SEND	Send Transfer	Re-transfers a previously transferred call that returned to your station.
SET	Set Feature	Enable call forwarding.
SOHVA	Secure Off-Hook Voice Announce	Sends a subdued off-hook voice announcement to another station.
SRC	Music Source	Selects which music source will supply background music.
TAKE MSG	Take A Message	Send a non-verbal response to a SOHVA caller so he or she will know to take a message from an outside party.
VAB	Voice Announce Block	Inhibits your station from receiving a SOHVA. Also, blocks voice calls sent over the speaker. When chosen as a feature, stores a button that provides the function.

**Available only on 8024S.*

1.4 Knowing Your Speakerphone's Functions

Your speakerphone provides many versatile features for your use. These features are explained in terms of what they allow you to do. Refer to section 1.5 *Understanding What The Lights Mean* for information about the lights associated with your telephone's buttons.

Alphanumeric Display (Liquid Crystal Display—LCD)

- Displays time, day, date, and active call information
- Keeps you apprised of the status of your telephone
- Provides programming prompts

Auxiliary Jack (available only on Impact 8024S)

- Allows you to connect a headset, an external amplified ringer, a tape recorder, or an external paging amplifier to your telephone

Hold Button

- Places a line or intercom call on hold
- Stores pauses in number sequences during programming
- Scans or scrolls through calls placed on hold (when hold light is flashing) in order to access, with the TAP button, a call other than the last one placed on hold (information about each held call appears in your display as you scroll through them)
- Scrolls through LCD response messages

Interactive Buttons

- Provide quick and easy access to system features
- Provide straightforward button programming without dialing codes (the interactive buttons themselves, however, are not programmable)

Intercom Button

- Selects an intercom line
- Allows you to initiate many of the telephone's features

Message-Waiting Light

- Indicates that a message awaits pick up

Microphone Opening

- Allows hands-free operation of speakerphone (speak clearly toward microphone opening)

Mute Button

- Keeps the person on the line from hearing your conversation

Programmable Buttons And Associated Status Lights

- Allow you to store numbers for automatic dialing functions
- Allow you to store telephone extension numbers for Direct Station Selection (DSS)
- Indicate which lines are either in use, ringing, or on hold

Shift Button

- Allows you to enter a second tier for storing and/or automatically dialing speed dial numbers. That is, you can store two speed dial numbers at every programmable button location—one in the regular tier and one in the second tier. You activate the shift function by pressing this button and turning the shift light on before storing or automatically dialing a speed dial number from the second tier.

Speaker

- Sounds distant party's voice
- Sounds ringing and call-in-progress tones

Speaker Button

- Turns your speaker on or off
- Disconnects a call when you are on a handsfree call
- Ends or cancels programming

TAP Button

- Recalls dial tone or generates a hookflash
- Retrieves held calls or last call placed on hold

Transfer/Conference Button

- Transfers calls
- Sets up conference calls

Volume Control

- Regulates the volume of the ringer, speaker, handset, headset, background music, and group listening mode

1.5 Understanding What the Lights Mean

The lights (LEDs) on your LCD speakerphone indicate the status of lines, features, and intercoms.

Next to a Direct Station Select (DSS) button:

- Steady red = station is in use.
- Flashing red = station is receiving a call.
- Winking red with repetitive off = message-waiting light set for you by station associated with that DSS button.

Next to a line button:

- Steady green = this is your line, either on-hook (in a handsfree mode) or off-hook, when the line is active.
- Steady red = another station is using this line.
- Flashing red = a call is coming in on this line.
- Flashing orange = this line will be answered when you lift the handset.
- Winking green with repetitive off periods = your line is on hold.
- Winking red = the call has been placed on hold by another station.
- Fluttering orange = your line has recalled from hold.
- Fluttering red = the line put on hold by another station has recalled.

Next to a fixed feature or programmable feature button:

- Steady red = the feature is on.
- Steady off = the feature is off.

Next to an intercom button:

- Steady green with a quick flash = you are using your intercom.
- Fluttering red = an LCD message is set on your telephone for others to receive when calling.
- Flashing orange = someone is calling your extension or a call is being transferred to you.

Above the HOLD button:

- Fast flashing red = message awaits pick up.
- Winking green with repetitive off periods = a line is on hold at your station.

Above the SPEAKER button:

- On steady (with the telephone on hook and busy) = speakerphone mode is active.
- On steady (with telephone on hook and idle) = background music is turned on.
- Flashing = feature viewing and programming is in progress.

Above the MUTE button:

On steady = called party cannot hear your conversation.

1.6 Adjusting The Telephone Pedestal (Models 8312S, 8324S, and 8324F only)

Your telephone has an adjustable pedestal to allow you to select the most comfortable viewing angle. When you receive the telephone, the pedestal is in its lowest position—flush against the pedestal.

- **To adjust the pedestal,**
 1. Grasp the rear of the pedestal base firmly with one hand while lifting the rear portion of the telephone upward with your other hand
 2. While pivoting the telephone upward with one hand, pivot the telephone supporting arms upward with your other hand while feeling for the notches under the telephone. Notice there are three sets of notches under the telephone corresponding to the three positions available.
 3. When the telephone is at the desired height, find the closest pair of notches and place the supporting arms in the notches. Press down slightly on the telephone until you feel the supporting arms snap into place.

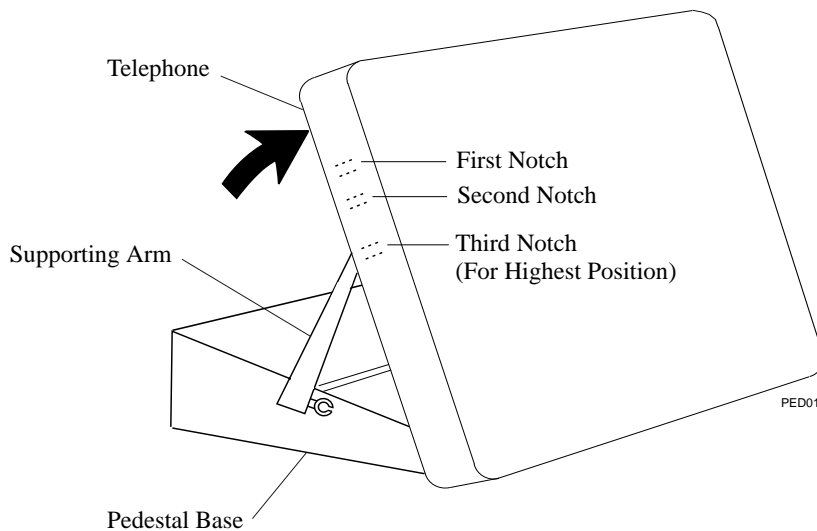

Adjusting The Pedestal

2

Answering Calls

NOTE: Throughout this book, all references to fixed buttons are printed in upper case bold type, for example “Press the **INTERCOM** button.” All references to interactive buttons are printed in upper case bold italic type, for example “Press the ***OPTIONS*** button.”

2.1 Answering Outside Calls

A call that rings on an outside line will sound long, single-tone bursts and will light the line status light. If the installer enabled ringing line preference at your station, an orange light flashes next to the line that your station will answer when you lift the handset; a red light will flash for any other ringing line.

- **When you hear outside ringing and observe a flashing light, answer the call as follows:**
 1. Lift handset or press line button and speak toward telephone if light is orange,
—OR—
press button of ringing line if flashing light is red, and speak toward the telephone (lift handset if privacy is desired).

When a call rings at your station, the ringing line number or name appears in the display along with the options *ANS* (Answer) and *DND* (Do Not Disturb).

- **To answer the call for which information appears in your display,**
 1. Press *ANS*. (Pressing *DND* stops your telephone from ringing but continues to send a ringing tone to the caller). The associated BLF will continue to flash until the caller disconnects.

- **After you have answered an outside call at your station, your LCD will display *HOLD*, *TRANS*, and *CONF*:**
 1. Press ***HOLD*** to place the call on hold at your station,
—OR—
press ***TRANS*** to initiate a transfer to another station, then dial the station number, announce the call or hang up to complete the transfer,
—OR—
press ***CONF*** to initiate a conference call.

2.2 Answering Intercom Calls

An intercom call is one that is made from one system telephone to another. An intercom party can voice-announce through your speaker instead of ringing your telephone, or an intercom party can ring your telephone (intercom ringing sounds two short ring bursts).

You can block voice-announce calls if you wish. See the discussion titled *Blocking Voice Announce Calls* for details.

- **When you hear intercom ringing followed by a caller's voice,**
 1. Speak toward the telephone to answer, or lift handset if privacy is desired.
- **When you hear intercom ringing (two short ring bursts),**
 1. Press **INTERCOM** and speak toward telephone; lift handset if privacy is desired.

When an intercom call rings at your station, the number or name of the originating station appears in the display, along with the options **ANS** (Answer) and **DND** (Do Not Disturb).

- **To answer the call for which information appears in your display,**
 1. Press **ANS**. (Pressing **DND** stops the ringing, sets a Do Not Disturb condition at your telephone, and sends a DND tone to the caller. The intercom light continues to flash).

2.3 Answering Calls At Monitored Stations

Your telephone may have the personal intercom number of another telephone appearing at a button location. You can use the light associated with this button to monitor the status of that telephone, and you can press the button to make a call to that telephone if you wish. The associated light is known as the Busy Lamp Field (BLF) light, and the button is known as the Direct Station Select (DSS) button.

If the installer arranged for your telephone to have the station monitoring feature, the BLF light shows activity status at the monitored telephone.

- **To monitor another telephone,**
 1. Observe the BLF light indications next to the personal intercom appearance (DSS) button:
 - Off = idle,
 - Flashing = ringing,
 - On = busy or on hold.

NOTE: If you do not have the station monitoring feature, the BLF light shows just the following information: Off = idle, On = busy.

- **To call an idle monitored station or to answer one that is ringing,**
 1. Note the BLF light condition.
 2. Press assigned DSS button.
 3. Lift the handset to talk.

NOTE: If you place this call on hold or if you transfer it to another telephone, the BLF light flashes a hold signal. You can retrieve the call by pressing TAP.

2.4 Answering Night-Transferred Calls

The system attendant can transfer incoming calls to a particular station or stations for off-hour ringing. Additionally, the installer can program the system for night-answer zones (up to four) with a loud bell associated with each zone. The loud bell sounds when the night transfer of ringing feature directs incoming calls to a zone. The installer may choose different night-answer dialing codes than those default values detailed in this procedure. When in doubt, ask your system attendant what codes are active at your site.

- **If your telephone rings,**
 1. Press line button with flashing light.
 2. Lift handset to talk.

- **When you hear loud ringing anywhere in the system,**
 1. Lift handset.
 2. Press **INTERCOM**.
 3. Dial **65** through **68** to select ringing zone (1-4) that the bell is in,
—OR—
dial **69** to answer any ringing zone.

NOTE: This feature is known as Trunk Access From Any Station (TAFAS).

2.5 Making A Call Pick-Up

The installer often arranges several telephones together in a user group. If your telephone is so arranged, you can answer calls that are ringing at other stations within your particular group. Also, you can answer a call that is ringing at any telephone in the system if you know the telephone's extension number.

- **To answer a call that is ringing within your group,**
 1. Press **INTERCOM**.
 2. Dial # **4**.
 3. Speak toward telephone to answer call. Lift handset if privacy is desired.
- **To answer a call that is ringing at any telephone in the system,**
 1. Press **INTERCOM**.
 2. Dial * **4**.
 3. Dial extension number of ringing telephone.
 4. Speak toward telephone to answer call. Lift handset if privacy is desired.

If you have programmed a **PICK UP** button on your telephone (see "Storing The Feature Buttons" in the chapter titled *Programming Your Telephone* in this guide), you may make a call pick-up (either within your group or at a specific station inside or outside your group) using that button.

- **To answer a call ringing at any other station in your group,**
 1. Press preprogrammed group **PICK UP** button.
- **To answer a call ringing at a specific station (either inside or outside your group),**
 1. Press preprogrammed direct **PICK UP** button.
 2. Press DSS or dial extension of ringing telephone.

2.6 Responding To A Subdued Off-Hook Voice Announcement

Your installer can set your LCD speakerphone to receive a Subdued Off-Hook Voice Announcement (SOHVA). This feature allows an intercom caller to break into your call by making an announcement through your handset receiver. (This means that if you are on a speakerphone call, you cannot receive a SOHVA call.) The distant party that you are currently talking to cannot hear the announcement made by the SOHVA caller.

Please note that you can receive a SOHVA call even if you are using your headset; however, the distant party may be able to hear the SOHVA as it is made.

- **You can respond to a SOHVA in one of three ways:**
 - **Verbally:** Press and hold the **REPLY** button and speak into handset. Distant party cannot hear response. To return to distant party after your reply is complete, release the **REPLY** button.
 - **Non-verbally (Response Messaging):** If the announcing station has an LCD speakerphone, press **MSG** (message), then press **HAVE HOLD** (have the caller hold), or **TAKE MSG** (take a message). The message appears in the display of the telephone making the SOHVA call and then that telephone is automatically disconnected from your telephone. (If the telephone to which you attempt to send a non-verbal message is not an LCD telephone, no message is sent and that station is immediately disconnected from the call.)
 - **Blocking the SOHVA:** You can block a SOHVA to your station by pressing **BLOCK** when the SOHVA is initiated. The SOHVA call is then disconnected.

3**Making Calls****3.1 Dialing Manually**

You can manually dial a number over any telephone line you select. Or, if the installer assigned a prime line or the idle line preference feature to your LCD speakerphone, it will automatically select a line for use when you lift the handset.

- **To dial an outside number manually,**
 1. Press line button to select line (remember: selecting a line is not necessary if a prime line or idle line preference feature is assigned to your telephone and if you lift the handset or press **SPEAKER** to begin the call).
 2. Listen for dial tone.
 3. Dial number.
 4. Lift handset if privacy is desired.

3.2 Dialing Automatically

This feature provides one- or two-button speed dialing using programmable buttons at which you have previously stored numbers. Two levels of number storage are available at each storage location, and you can use one or both levels as needed. Further, since you usually store a line choice as part of a speed dial number, line selection is automatic with speed dialing. This user's guide discusses button programming in a separate section. Refer to it when you are ready to store numbers at the programmable buttons.

There are two types of speed dial numbers: (1) numbers that you store for your own use (personal speed dial numbers), and (2) numbers that the system attendant stores for everyone's use (system speed dial numbers).

- **To automatically dial a speed dial number stored at one of the programmable buttons on your station,**
 1. Press preprogrammed speed dial button (line selection is usually a part of the stored speed dial number),
—OR—
press preprogrammed **SHIFT** button, then press preprogrammed button (to choose number stored as a second choice at that button).

With your station idle, you can automatically dial a personal or system speed dial number stored at a dial pad location.

- **To speed dial a personal speed dial number stored at the dial pad,**
 1. While on hook, press speed dial number on dial pad (**0-9**).
- **To speed dial a system speed dial number stored at the dial pad,**
 2. While on hook, press * and then dial system speed dial number (**000-999**).

NOTE: *If you are already on a line, you must press **SHIFT** before dialing the personal or system speed dial numbers that are stored at the dial pad. Also, if a speed dial's preselected line is in use, the speed dial will not engage.*

NOTE: *On some earlier systems, the available system speed dial codes are *100-*299 and *100-*599.*

3.3 Using Dial By Name

The Dial By Name feature provides an index of names for you to search through. When you select a name in the index, the system will automatically dial that person's extension number.

- **To use Dial By Name,**
 1. Press **OPTIONS** to enter the dial by name menu.
 2. From the dial by name menu,
Press **INT** button for intercom calling.
—OR—
Press **EXT** for speed dial calling.
 3. Dial digits corresponding to the letters in the name you want to locate (for example, dial 266 for Comdial). There is no limit to the number of digits you can dial.
1 = QZ 2 = ABC 3 = DEF
4 = GHI 5 = JKL 6 = MNO
7 = PRS 8 = TUV 9 = WXY
 4. The display shows the first existing name match to the dialed digits or shows a **No Match** message if the system can not find a match.
 5. Press **NEXT** to display the subsequent names in the index until you reach the name you need.
 6. Press **DIAL** to call the displayed location.
 7. If the display says **No Match**, press **PREV** or enter new digits to search for a new name.

3.4 Redialing A Previously Dialed Number

If the last number you have called is busy or is not answering, you can redial it once or initiate automatic redialing. The system will support automatic redialing for up to 10 numbers.

You can permanently save the first 16 digits of the last manually dialed number for later redial by using the SAVE interactive button or by using a **SAVED NUMBER REDIAL** button that you or your system installer has preprogrammed.

If a distant party tells you an important telephone number and you want to immediately save it for later redial, you can use the **SAVED NUMBER REDIAL** button to permanently save the first 16 digits of that number.

You will overwrite a temporary system-saved number with subsequent dialing activity; however, a permanently saved number remains available until you overwrite it by saving a different number at the same storage location.

3.4.1 Redialing The Last-Dialed Number

- **To redial the last-dialed number,**
 1. Press **SPEAKER** (or hang up handset) to disconnect current ringing or busy tone.
 2. Press # or press the key.
 3. Listen for ringing or busy tone over the telephone speaker:
 - Ringing tone:** When party answers, speak toward telephone to answer call. Lift handset, if privacy is desired.
 - Busy tone:** Press **SPEAKER** to disconnect.

3.4.2 Using The Automatic Redial Feature

If your station has the multiple automatic redial feature enabled, you can place up to 10 numbers in your telephone's redial queue. Your telephone will redial the numbers one at a time, in the order you placed them in the queue, until (a) the call is answered, (b) you cancel the automatic redial feature for a particular number, or (c) your telephone has dialed the number a preprogrammed number of times (set by your system installer).

- **To use the automatic redial feature to redial a busy or unanswered number,**
 1. While on the call, press **ARDL** or press the **AUTOMATIC REDIAL** button programmed by your installer.
 2. The system repeatedly dials the number until you cancel the feature or the system has dialed the number a preprogrammed number of times (determined by your system installer).
 3. The **AUTOMATIC REDIAL** light flashes between redials and turns on steady during redialing.
 4. When the distant party answers the call, press the **ARDL** button or the **AUTOMATIC REDIAL** button while on the call to cancel automatic redialing,
—OR—
if your installer has enabled answer supervision on your line, the system automatically cancels automatic redialing and turns the **AUTOMATIC REDIAL** light off.
 5. If your system installer has enabled the redial multiple numbers feature, you can have up to 10 numbers in your redial queue. To add numbers to your redial queue, repeat step 1 in the above procedure.

- **To scroll through numbers in your redial queue if your telephone is currently idle,**
 1. Press the **ARDL** button or the **AUTOMATIC REDIAL**.
The display shows the last number dialed.
 2. To remove the number from the redial queue, press **REMOVE**,
—OR—
to scroll to the next number in the queue, press **NEXT**,
—OR—
to exit from the redial queue, press **EXIT**.

- To interrupt the redialing procedure so that you can scroll through numbers in your redial queue,

NOTE: *You can only do this if the multiple automatic redial numbers feature is enabled and you currently have more than one number in your redial queue.*

1. While your telephone is in the process of dialing a number, press the **ARDL** button or the **AUTOMATIC REDIAL** button twice. This treats the number as answered, cancels automatic redialing for that number, and puts the number back in the automatic redial queue.
The display shows the last number dialed.
2. To remove the number from the redial queue, press **REMOVE**,
—OR—
to scroll to the next number in the queue, press **NEXT**,
—OR—
to exit from the redial queue, press **EXIT**.

- To cancel the automatic redial feature,

1. Perform any user activity at the station (go on-hook, press the speaker button, etc.),
—OR—
press # **72** to delete all numbers from the redial queue,
—OR—
press the **ARDL** or **AUTOMATIC REDIAL** button while the number you wish to remove from the redial queue is ringing.

NOTE: *The system allows only ten numbers in the redial queue. In order to add a number to a full redial queue, you must first remove one of the numbers from the queue.*

3.4.3 Storing Numbers For Redial

- **To permanently store a number you've just dialed,**
 1. Press **SAVE**.
 2. Select unused programmable button location.
 3. Press **SPEAKER**.
- **To permanently store a number you've just dialed (alternate method),**
 1. Dial number.
 2. Press preprogrammed **SAVED NUMBER REDIAL** button.
- **To dial the saved number,**
 1. Press **SPEAKER** or lift handset.
 2. Press button where number is saved,
—OR—
press **SAVE NUMBER REDIAL** button.
- **To store a number while you are on a call,**
 1. Press **SAVE NUMBER REDIAL** button twice (note that the display prompts you to dial a number).
 2. Dial the number that you wish to save (the system immediately saves the number for later redial—it does not dial it over the line you are on now).
- **To later redial the saved number,**
 1. Press line button to select a line.
 2. Press **SAVE NUMBER REDIAL** button (system automatically dials the number that you saved earlier).

3.5 Using Line Groups

Some systems have telephone lines arranged into line groups. These line groups are available at each telephone. Your attendant can tell you how your system is arranged. When line groups are available for your use, you may access them for outside calling instead of pressing a line button to select an individual line for use.

- **If your system has line groups, access them as follows:**

1. Press **INTERCOM**.
2. Dial desired line group access code:*
 - 9** = line group 1
 - 80** through **89** = line groups 2 through 11
 - 60** through **64** = line groups 12 through 16—OR—
 - press preprogrammed line group button.
3. Listen for outside dial tone.
4. Dial desired number.
5. Lift handset to talk.

** These are the default system codes. Your installer may have reprogrammed them to better suit your application.*

3.6 Waiting For A Line (Queuing)

If all the lines in a line group are busy, you can place your telephone in a queue to await an idle line. When you share a line with another telephone and the line is busy, you can place your telephone in a queue to await the idle line.

- **To queue for a line group,**
 1. Press **INTERCOM**.
 2. Dial the line group access code.
 3. Hear busy tone.
 4. Dial * 6.

- **If you have line appearance for a particular line and wish to queue for it,**
 1. Note the busy status light (LED).
 2. Press **INTERCOM**.
 3. Dial * 6.
 4. Press line button.
 5. When line group is free, your telephone sounds several short tone bursts. When you hear this, lift handset, hear dial tone, and place call.

- **To cancel line queuing or line group queuing,**
 1. Press **INTERCOM**.
 2. Dial # 6 and hang up.

3.7 Making Intercom Calls

You can dial an intercom extension manually from the dial pad or automatically using a direct station select (DSS) button that you have previously programmed. There are two methods for making an intercom call. One causes the called telephone to ring. The other causes your voice to sound out at the called telephone. Your installer can set the system to deliver either tone-first or voice-first calling.

Keep in mind that whatever the system setting, a called party can set a voice announce block condition at his or her telephone to prevent all voice announce calls. Furthermore, if he or she blocks voice announce, the system also blocks SOHVA calls.

(The following instructions assume a tone-first setting. Any user can change a call to voice announce signaling for that call simply by pressing the INTERCOM button again after dialing the extension number or by pressing the DSS button again.)

- **To manually cause the other telephone to ring (tone calling),**
 1. Press **INTERCOM**.
 2. Dial extension number (called telephone will ring).
- **To tone call automatically,**
 1. Press **DSS** button (called telephone will ring).

(The following instructions assume a voice-first default setting. Any user can change a call to a tone signaling for that call simply by pressing the INTERCOM button again after dialing the extension number or by pressing the DSS button again.)

- **To voice announce manually,**
 1. Press **INTERCOM**.
 2. Dial extension number.
 3. Speak your announcement.
- **To voice announce automatically,**
 1. Press **DSS** button.
 2. Speak your announcement.

3.8 Camping On At A Busy Station And Waiting For An Automatic Callback

If you call another station and receive a busy signal or a Do Not Disturb tone, you can press a button that will cause the system to ring your telephone when the station is available. This is called “camping on at a station.” Please note that you can camp on to only one station at a time.

- **To camp on at any busy station,**
 1. Press **CAMP**.
 2. Your telephone immediately hangs up. When the station you called becomes available, your telephone will ring with five short tone bursts.

- **When you hear five short tone bursts,**
 1. Press **INTERCOM**. The other telephone will start ringing.
 2. If you do not press **INTERCOM** after the ring back tones within the time limit set by the installer, the call back is canceled at that time; however, you can cancel automatic call back at any time before your telephone sounds the tone bursts.

- **To cancel the call back before your telephone sounds the tone bursts,**
 1. Press **INTERCOM** and dial # 6.

- **To camp on at a station with a Do Not Disturb condition set,**
 1. Press **CAMP**. A call back will occur when called station is no longer set in the Do Not Disturb mode.

3.9 Camping On At An Idle Station And Waiting For An Automatic Callback

If you call another station and hear ringing but receive no answer, you can press a button that will cause the system to ring your telephone when any activity is initiated at that station.

- **To camp on at a station for which you hear ringing but receive no answer,**
 1. Press **CALLBK** button. Callback will occur after any activity is initiated at dialed station. You may cancel the camp-on condition at any time by pressing **INTERCOM** and dialing # 6.

NOTE: This feature is not applicable to calls you make in the voice announce mode.

3.10 Camping On At A Busy Station And Waiting For An Answer (Call Waiting)

If the telephone you have called is busy, you can send a call-waiting tone to the telephone and wait on the line for an answer (you must be using the handset for this feature to work).

- **To activate call waiting when you hear a busy signal,**
 1. Dial * 6 (called party hears tone).
 2. Wait on line for reply.
 3. Called party can place the current call on hold or disconnect from the call to answer your call-waiting tone, or choose to ignore your call-waiting tone and continue current conversation.
- **To cancel call waiting,**
 1. Press **INTERCOM**, then dial # 6.
 2. Hang up or press **SPEAKER** to end.

- **To answer a call-waiting tone if you receive one while on a call,**
 1. Hear short tone burst in receiver.
 2. Either place current call on hold or complete call and hang up (waiting call will ring at your telephone).
 3. Lift handset to answer call.

You may, of course, choose to ignore the call-waiting tone and remain on the line with your original caller.

3.11 Overriding A Call Or A Do Not Disturb Condition At Another Telephone (Executive Override)

You can override a call in progress or a Do Not Disturb condition at another telephone if the system installer has enabled the executive override feature at your telephone. (If the feature is not enabled through programming, an error tone will sound and screen options will remain displayed.)

- **To override an in-progress call at another telephone,**
 1. Make intercom call and hear a busy signal.
 2. Dial * 03 (all parties will hear several tone bursts).
 3. Join in-progress call.

- **To override a Do Not Disturb condition at another station,**
 1. Press *OVER* to disable the Do Not Disturb condition at the called station.
 2. Speak your announcement (if in voice-first mode) or hear ring-back tone (if in tone-first mode).

NOTE: This action disables DND condition at the other telephone until DND is reset.

3.12 Making A Subdued Off-Hook Voice Announcement (SOHVA)

You can make a subdued voice announcement to another station that is off-hook and busy on a call if the system is arranged to provide this feature. You decide whether to deliver a SOHVA message, camp on at that station, set a message-waiting indicator, or hang up when you hear an intercom busy tone.

- **Make a SOHVA announcement using the SOHVA button as follows:**
 1. Make intercom call and hear busy tone. If called station is on outside line, ring-back tone is heard, but SOHVA is still available.
 2. Decide whether to interrupt.
 3. If you decide not to interrupt the called party, hang up,
—OR—
to interrupt, press **SOHVA** and hear several quick tone bursts.
 4. Make announcement (busy tone means that the called telephone is in speakerphone mode and you cannot make announcement, that your SOHVA has been denied through system programming, or that the called party has blocked your SOHVA).
 5. Wait on line for reply (either verbal or LCD reply).

NOTE: You cannot control how the announcement is received. This depends upon whether or not the called party is using a headset and how his or her station is programmed. For example, if the called party has set their station to call forward to voice mail or to another station not in the SOHVA group, your announcement will not be received.

4**Placing Calls On Hold****4.1 Holding Calls**

You can place a call on hold and retrieve it later. With a regular hold, you can pick up the held call at your telephone or another user can pick the call up at a telephone sharing the held call line. With an exclusive hold condition, you or another user must pick up the held call at your telephone; no other telephone has access to it. You can answer and place on hold a call that is on a line that does not appear at your telephone (a call that is parked or transferred to you, for instance).

After a call has been on hold for the period of time (set by the system installer), the system will cause four quick tone bursts to sound at your telephone, and speed up the flash rate of the line button light. If the call is on exclusive hold, it will revert to manual hold recall after a timeout period.

When you answer a call on a group intercom and place it on hold, the system keeps the call on hold on the group intercom. This means that you or any other user can pick up this call at any station that has access to the group intercom.

The installer can add a directed station hold feature to your telephone. With this feature, you can pick up the held call that has been on hold the longest length of time at another telephone. This feature also allows you to place a call on hold at another telephone in a manner that makes that call appear to have been on hold there for a longer period of time than any other held call.

- **To place a call on hold,**
 1. Press **HOLD**.

- **To retrieve a held call,**
 1. Press line button of the held call (with flashing light),
—OR—
press **TAP**.

***NOTE:** Unless you use your **HOLD** button to scroll through the calls on hold, **TAP** always retrieves the last number placed on hold, regardless of whether you have line appearance for the line on which the call is holding.*

- **To place a call on exclusive hold,**
 1. Press **HOLD** twice.

- **To retrieve exclusive hold,**
 1. Press line button of held call (with flashing light),
—OR—
press **TAP** (if station does not have line appearance).

- **To place a call on directed station hold,**
 1. Answer call.
 2. Press **INTERCOM**.
 3. Dial ***90**.
 4. Dial extension number of station to receive held call.
 5. Hang up.

- **To retrieve a held call at another station,**
 1. Press **INTERCOM**.
 2. Dial **#90**.
 3. Dial extension number of station to receive held call.
 4. Answer call.

Often, you will have more than one call on hold at your station. You know you can retrieve the last call placed on hold simply by pressing **TAP**; however, if you do not have line appearance for a line on which another call is holding, the system provides a way for you to access that call before servicing the last call you placed on hold.

- **To scan your held calls and retrieve a specific one:**
 1. Repeatedly press **HOLD** to scan held call list.
 2. Press **TAP** to retrieve call.

For example, if five calls are holding and you wish to retrieve the second call you placed on hold, press **HOLD** three times to scroll from held call #5 through call #4, call #3, and then to call #2, then press **TAP** to retrieve call #2.

4.2 Handling Hold Recalls

After a call has been on hold for the period of time (set by the installer of your system), the system will cause four quick hold recall tone bursts to sound at your telephone and the flash rate of the line button becomes faster.

If the call is on exclusive hold, it will revert to manual hold after the hold recall period (you will hear four short tone bursts at 12-second intervals). Calls that revert to manual hold can be picked up from any telephone with line appearance for the recalling line (or you can use the group or directed pick up buttons **GPKUP** or **DPKUP**).

- **If a held line is recalling,**
 1. Answer/retrieve recall.
 2. Press **HOLD** to place the call on hold at your station and restart HOLD timer,
—OR—
press **ANS** to retrieve the call.

4.3 Parking Calls

You can place a call on hold in the system so that it can be answered from any station that does not have a line appearance for the call. You accomplish this by placing the call in one of nine park orbits, where the call remains until it is answered. If the call is not answered within a specified period of time, the system will send it back to your station for service (this is known as a park recall).

When you press a personal or group intercom button and dial a code to retrieve a parked call, the system removes it from the park orbit and places it at your station on the intercom that you selected.

You can preprogram a **PARK** button at your telephone (see section 9.5 *Using The Feature Buttons*) and use it to simplify your call parking efforts.

- **To park a call in orbit,**
 1. While on the call, press **INTERCOM**.
 2. Press *,
—OR—
press **TRANSFER/CONFERENCE**, if intercom call.
 3. Dial code for park orbit (**91-99** for orbit 1-9).
 4. Remember the code for later use or make it known to those who need to know it in order to retrieve the call.
- **To park a call using a preprogrammed PARK button,**
 1. While on the call, press the preprogrammed **PARK** button (the system places the call in a preselected park orbit and lights the **PARK** light).
- **To retrieve a call that was placed on hold in the system (parked),**
 1. From any station, press **INTERCOM**.
 2. Press #.
 3. Dial code for orbit (**91-99** for orbit 1-9),
—OR—
press preprogrammed **PARK** button.

4.4 Handling Park Recalls

When a parked call times out of the system, it will return to your telephone in the form of a park recall (you will hear four short tone bursts at 12-second intervals). Your LCD will indicate that the call is a park recall and will identify the orbit from which the recall originated.

- **To answer a park recall,**
 1. Press *ANS*. The call will then connect to your station.
- **To place a park recall on hold at your station,**
 1. Press *HOLD*. If the call remains on hold for a period of time, it will ring back to your telephone as a hold recall.
- **To re-park a park recall and restart the park timer,**
 1. Answer/retrieve call.
 2. Press *PARK* (the call will then be placed back in its original park orbit and will remain there until it is answered or until it recalls again).

5**Transferring Calls****5.1 Transferring Calls—Screened**

You can answer a call at your LCD speakerphone and transfer it to another telephone. If you first identify the caller to the party receiving the transfer (giving that user the opportunity to prepare for the call), you have made a *screened transfer*.

If the telephone to which you are transferring the call is busy, you must recover the call yourself or choose one of several options that may be available at your station. Also, if a transferred call is not answered after a certain length of time (as set by the installer), it recalls to your telephone. Again, you have several options for servicing the returning call.

- **To screen and transfer a call to another telephone in the system,**
 1. Answer call.
 2. Press **TRANSFER/CONFERENCE** (call is automatically placed on hold).
 3. Dial extension number of telephone to receive transfer or press **DSS** button for that extension.
 4. When intercom party answers, announce call.
 5. Press **SPEAKER** to disconnect (if in speakerphone mode), or hang up.
 6. The intercom party then has the call (if he or she answered the screened transfer with the handset). If you announce the transfer over the speaker, the intercom party's telephone will ring with the transferred call after you hang up.

- **If the intercom party is busy, take one of the following steps (if made available at your telephone by installer programming):**
 1. Press ***RECON*** to reconnect the call to your station.
 2. Press ***SOHVA*** to interrupt the call and tell the intercom party that a call awaits.
 3. Press ***MSG*** to leave a message-waiting indication at the called station.

- **If the intercom party does not answer their telephone when ringing, take one of the following steps:**
 1. Press ***RECON*** to reconnect the call to your station.
 2. Press ***MSG*** to leave a message-waiting indication at the station.

5.2 Transferring Calls—Unscreened

You can answer a call at your LCD speakerphone and transfer it to another telephone. If you transfer the call without first announcing it, you have made an unscreened transfer.

If the telephone to which you are transferring the call is busy, you must recover the call yourself or choose one of several options that may be available at your station. Also, if a transferred call is not answered after a certain length of time (as set by the installer), it recalls to your telephone. Again, you have several options for servicing the returning call.

- **To transfer an unscreened call to another system telephone,**
 1. Answer call.
 2. Press **TRANSFER/CONFERENCE** (call is automatically placed on hold).
 3. Dial extension number of telephone to receive transfer or press **DSS** button for that extension.
 4. Press **SPEAKER** to disconnect (if in speakerphone mode), or hang up. The transfer will ring at the called telephone.

NOTE: Unscreened transfers ring at busy telephones and wait to be answered.

- **If an unscreened transfer call is not answered and recalls to your telephone, you can take one of the following steps:**
 1. Press **HOLD** to place the call on hold at your telephone.
 2. Press **ANS** to return to the call.
 3. Press **SEND** to retry the transfer.

5.3 Making A Hot Transfer

A hot transfer is a type of screened transfer. To perform a hot transfer, you voice announce the transfer over the speaker of the telephone that you want to receive the transfer, and release the call to that telephone. The system handles the release in a way that does not require the called party to retrieve the call (the call does not ring at the station).

This feature is useful for transferring calls to people who need to work in a handsfree mode. Once you announce the call and the system completes the transfer, the person receiving the transfer can simply begin speaking toward his or her speakerphone to answer the call.

If you make a hot transfer to a monitor telephone, you can voice announce the call over the telephone's speaker, but the person receiving the outside line transfer will need to lift the handset to answer the call (the telephone will not ring after the announcement is made).

Please note that you can not make a hot transfer to a telephone if its user has enabled the Voice Announce Block feature. This telephone will automatically ring with the transfer requiring the intercom party to answer it as either a screened or an unscreened transfer.

- **To make a hot transfer to another telephone in the system,**
 1. Answer call.
 2. Press **TRANSFER/CONFERENCE** (the call is automatically placed on hold).
 3. Dial extension number of telephone to receive the transfer or press the DSS button for that extension.
 4. Announce call.
 5. Press **TRANSFER/CONFERENCE**.
 6. Press **SPEAKER** to disconnect (if in speakerphone mode) or hang up. The person receiving the transfer then has the call.

5.4 Transferring Calls Using Quick Transfer

When the quick transfer method has been programmed by the installer, it allows you to do an automatic screened or unscreened transfer of an incoming line call without pressing the **TRANSFER/CONFERENCE** button. The transfer occurs automatically whenever you answer a call and then dial the intercom number for the transfer location.

- **To do a quick screened transfer,**
 1. Answer call.
 2. Dial intercom number for transfer location.
 3. When party at transfer location answers, announce call.
 4. Hang up, press **RELEASE**, or press **SPEAKER** button.
- **To do a quick unscreened transfer,**
 1. Answer call.
 2. Dial intercom number for transfer location.
 3. Hang up, press **RELEASE**, or press **SPEAKER** button.

This page remains blank intentionally.

6**Conferencing Calls****6.1 Conferencing Telephones Together**

When you join your LCD speakerphone together with several other telephones on the same call, the result is called conferencing. When using the DXP system, you can make conference calls that involve up to five parties, including you as the originating party, in any combination of outside lines and intercom parties. For example, you can conference three outside lines and two intercom parties, or four outside lines and one intercom party, or five intercom parties—the combinations are up to you. When using the DXP *Plus* or FX Series system, you can include up to seven parties (in various combinations) in a conference call.

If you are involved in a conference call with two outside lines, you can drop out of this established conference call and leave the outside lines in the conference with each other. This is known as an unsupervised conference call.

- **To set up a conference call that includes any combination of outside lines and intercom parties,**
 1. Make first call.
 2. Press **CONF**; call is placed on hold automatically.
 3. Select next line and make next call.
 4. Press **CONF** to establish conference.
 5. Press **TRANSFER/CONFERENCE** button to add more parties.

- **To continue conversation on remaining line after other outside lines have dropped out of conference,**
 1. Press **HOLD**.
 2. Press the line button of the remaining party.

- **To retrieve a line from hold and bring that party back into the conference,**
 1. Press **TRANSFER/CONFERENCE**.
 2. Press line button.
 3. Press **TRANSFER/CONFERENCE**.

NOTE: If all the conference circuits are busy, you will not be able to add a party to the conference.

- **To drop out of a conference call you initiated involving outside lines (creating an unsupervised conference),**
 1. Dial # (lines remain lighted and in use until one or both outside parties disconnect; when only one party drops out of an unsupervised conference, the other party remains on hold until he hangs up or the line is answered).
- **To rejoin an unsupervised conference between two outside lines,**
 1. Press **TAP**.

NOTE: Conference volume levels depend upon the quality of the external lines.

7

Using The Other Telephone Features

7.1 Adjusting The Display Contrast

You can adjust the contrast of the display to darken or lighten it for best viewing.

- **To adjust the display contrast,**
 1. Press *OPTIONS*.
 2. Press *NEXT* until the DISP option appears.
 3. Press *DISP*. Your display will read “Contrast Level”.
 4. Press *LIGHT* or *DARK* once for each degree of change desired.
 5. Press *SPEAKER* to end.

7.2 Blocking Voice-Announce Calls

You can prevent voice announcements from sounding over your telephone speaker if you wish. This feature also blocks subdued off-hook voice announcements.

- **To block voice-announced calls,**
 1. Press *OPTIONS*.
 2. Press *VAB*.
 3. Press *ON*.
 4. Press *SPEAKER* to end.

- **To un-block voice-announced calls,**
 1. Press *OPTIONS*.
 2. Press *VAB*.
 3. Press *OFF*.
 4. Press *SPEAKER* to end.

7.3 Displaying Status Of Busy Lines and Stations (Busy Button Inquiry)

You can use this installer-provided feature to identify the station that is busy on a line or the line on which a station is busy. The system presents the station or line information on your display for 10 seconds after you request it. If your station does not have this feature, the system presents busy information on the display without identifying the line or the station.

- **To identify the station that occupies a busy line,**
 1. Press button for busy line.
 2. Read your display for intercom number of station that is busy on line.
- **To identify the line that a busy station occupies,**
 1. Press DSS button for busy station.
 2. Read your display for the busy station's line number.

7.4 Displaying Button Functions (Button Query)

You can cause the display to identify the function of each button on your telephone. This is useful when the installer has assigned your programmable buttons for special-purpose tasks and you need to remind yourself of the button's feature.

- **To button query your telephone,**
 1. Press **OPTIONS**.
 2. Press **NEXT** five times until the **QUERY** option appears.
 3. Press **QUERY**.
 4. Press the button in question.
 5. Read the displayed information (display will hold for few seconds before the telephone returns to idle).

7.5 Diverting Incoming Calls To Another Station

Call diverting permits you to send an incoming call to another station that you have previously designated. You can divert an incoming call to the designated station whether you are busy or idle. You must program a **CALL FORWARD** button (using the instructions in the programming section) on your LCD speakerphone to serve as a call divert button.

- **To identify the station to receive diverted calls,**
 1. Press **INTERCOM**.
 2. Dial ***55**.
 3. Dial extension number of station to receive diverted call.
- **To divert calls to the designated station,**
 1. Hear ringing and/or see flashing line status light.
 2. Press **FWD-A** (system immediately forwards ringing call to station you designated).

7.6 Entering Account Codes

If the installer has arranged your system for account code entry*, your display may prompt you to enter an account code before dialing or after answering a call. Depending upon how the installer has programmed your system, these account codes may be “forced”(mandatory) for dialing outside numbers.

*System must be activated through installer programming to accept account codes.

NOTE: You can program a button on your telephone that will make the account code entry process quicker. Refer to the programming section of this user’s guide for details.

- **To enter account code on an incoming call,**
 1. Press **INTERCOM**, then dial * **0 4** (call is automatically placed on hold),
—OR—
press preprogrammed **ACCOUNT CODE** button (the call in process is not interrupted).
 2. Dial account code. Your telephone automatically returns to the call after you’ve dialed the complete account code.

- **To enter account code on an outgoing call,**
 1. Press line button (the display will prompt for “Account Code” if programmed to do so).
 2. Press **INTERCOM** (call is automatically placed on hold).
 3. Dial * **0 4**,
—OR—
press preprogrammed **ACCOUNT CODE** button (the call in process is not interrupted).
 4. Dial account code.
 5. Listen for dial tone and dial number you are calling.

NOTE: If you hear an error tone after you have dialed your account code, check the number for validity.

7.7 Entering Authorization Codes

Authorization codes give you a *walking class of service* option. *Walking class of service* provides you with the mobility to use your class of service (COS) features, prime line assignments, and exception numbers on any telephone in the system. This means that you will not be limited by features that are available to the particular telephone that you happen to be using. Authorization codes are associated with your personal intercom number and are assigned to you by your installer when he or she programs the system. When you enter your assigned authorization code at any system telephone, the code alerts the system to make your normal features available to you. This means that you can use the telephone for anything allowed by your personal intercom number; however, you cannot disturb the last number redial stored there by the normal user. Once you access your telephone features, they remain in effect until any idle time exceeds the authorization code time-out period. If your telephone includes an installer-programmed **LOCK** button, you can press it and then dial your authorization code to deny other users access to lines and features at your LCD speakerphone.

- **To activate walking class of service,**
 1. Select system telephone to use.
 2. Press **INTERCOM**.
 3. Dial **#08**.
 4. Dial your authorization code.

- **To lock your telephone,**
 1. Press **LOCK**.
 2. Dial your authorization code.

NOTE: *If you wait longer than two seconds to dial a digit after you press the LOCK button, that pause, and any others that you might include, becomes part of the lock code. However, before you can enter a pause, you must begin the code with a digit. The telephone display will show a (-) to represent a pause as part of the code as you enter it. You must allow for any pauses at any location that you inserted them in the number string when you unlock your telephone. This feature provides you with a method for creating a very effective lock and unlock password.*

- **To unlock your telephone,**
 1. Press **LOCK**.
 2. Dial your authorization code (remember, include any pauses that you inserted when you locked your telephone).

7.8 Forwarding Calls

You can permanently forward the calls that normally ring at your telephone to another telephone. You can forward just your prime line and intercom calls, or you can forward all of your calls. To remind you that your calls are being forwarded, your telephone will sound a short ring burst each time the system forwards a call.

You can also forward calls that ring at your telephone but receive no answer; this feature is valuable if you are frequently away from your desk for short periods of time and find it inconvenient to permanently forward your calls every time you leave. The system installer sets the number of rings that sound at your telephone before the system forwards the calls.

- **To forward your calls,**
 1. Press **OPTIONS**.
 2. Press **NEXT** until the CFWD option appears.
 3. Press **CFWD**.
 4. Press **SET**.
 5. Press **PERS** to forward prime line and intercom calls,
—OR—
press **ALL** to forward all calls,
—OR—
press **NO ANS** to forward calls that ring at your station but receive no answer after a preprogrammed number of rings (then press **PERS** to forward your prime line and intercom calls or press **ALL** to forward all calls that ring with no answer at your telephone).
 6. Dial extension number of telephone to receive your forwarded calls.
 7. Press **SPEAKER** to end.

- **To cancel call forwarding,**
 1. Press *OPTIONS*.
 2. Press *NEXT* until the CFWD option appears.
 3. Press *CFWD*.
 4. Press *CLR* to disable call forwarding.
 5. Press *SPEAKER* to end.

7.9 Listening To A Call Over The Telephone Speaker (Group Listening)

You can turn on the speaker in your LCD speakerphone while you have the handset lifted if you wish. The distant party's voice then sounds over the speaker as well as over the handset; however, only your handset microphone is active.

This *group listening* feature also works if you are using your headset (only the headset microphone will be active).

Refer to the chapter on programming for instructions on how to program the **GROUP LISTEN** button.

- **To activate group listening while on a call,**
 1. Press the preprogrammed **GROUP LISTEN** button.

NOTE: *To activate the group listening feature, press **SPEAKER** for two seconds.*

- **To cancel group listening,**
 1. Press the preprogrammed **GROUP LISTEN** button again.

NOTE: *You should cancel Group Listening before hanging up the handset to end the call.*

7.10 Making A Call Non-Private (Privacy Release)

It is often the case that telephones will share line appearance for one or more lines. When a person in the group uses a line for which others have the same line appearance, the system keeps the call private (others cannot join the conversation by pressing the line button of the line being used).

That person can make the call non-private by pressing the preprogrammed **PRIVACY RELEASE** button, allowing other telephones (with line appearance for the line being used) to join the call. Privacy returns to the line when the call is completed.

Refer to the chapter on programming for instructions on how to program the **PRIVACY RELEASE** button.

- **To release privacy from your telephone while on a call,**
 1. Press preprogrammed **PRIVACY RELEASE** button. (The light associated with the **PRIVACY RELEASE** button will remain on steady when your telephone is in a non-private mode.)

If another party wishes to join the call, they must press the active line button on their telephone.

7.11 Monitoring A Conversation Between Two Telephones (Service Observing)

If your LCD speakerphone provides the installer-programmed *service observing* feature, you can use it to monitor a conversation or activity at another telephone in an undetected manner. You can use this feature while you are in the speakerphone mode or off-hook.

- **To monitor another station at any time,**
 1. Press **INTERCOM**.
 2. Dial **# 0 3**.
 3. Dial extension number of telephone to be monitored.
 4. Press **SPEAKER** to end monitoring.

- **If you have an installer-programmed SERVICE OBSERVE button on your telephone and wish to monitor a station,**
 1. Press **SERVICE OBSERVE** button.
 2. Dial extension or press DSS of station you wish to observe.
 3. Press **SPEAKER** to end monitoring.

7.12 Muting Your Telephone

By using the **MUTE** button, you can block transmission of your voice to the distant party. You can do this whether you are using the handset or the speaker. For example, if someone comes into your office to talk to you and you do not want this conversation to interrupt the distant party, press the **MUTE** button. The **MUTE** button light turns on when you press it and turns off when you press it again.

- **To mute your telephone,**
 1. Press **MUTE** (MUTE function and light turn on). You can still hear the distant party, but he or she cannot hear you.
- **To speak to the distant party,**
 1. Press **MUTE** again (MUTE function and light turn off).

7.13 Sending A Paging Announcement

Your system provides an all-call or a zone page feature that you access by dialing special codes. This arrangement sounds your voice announcement through the telephone speakers. All-call sounds the announcement through all telephones, while zone paging sounds the announcement only through those telephones located in a specific area. Check with your system administrator to determine the type of paging and access method you should use. If your day-to-day operation requires that you send many paging announcements, you can program a special all-call/zone paging button to give quick access to the feature. See the programming section of this user's guide for details.

Your installer can arrange your system with an external paging unit that you access by pressing a line button or by dialing a special code. This unit sounds the voice announcement over an external speaker unit. Check with your system administrator for specific information on how to operate with such an arrangement.

- **To send a paging announcement,**
 1. Lift handset.
 2. Press **INTERCOM**, then dial **70-77** for zones 1-8 (in the default mode, zone 1 (code 70) provides an all-call function),
—OR—
press a preprogrammed **PAGE** button.
 3. Make announcement.
 4. Remain on line if awaiting a reply (known as a meet-me page),
—OR—
hang up handset.

At times other telephone users may page you with instructions to meet them on line. This is known as a meet-me page. You can go to the nearest telephone, dial a code, and be in contact with the paging party.

- **To reply to a meet-me page,**
 1. Lift handset of nearest telephone.
 2. Press **INTERCOM**.
 3. Dial **78**.
 4. Meet paging party on line.

7.14 Setting A Do Not Disturb Condition At Your Station

This feature keeps calls from ringing at your LCD speakerphone and makes your station appear to be busy to intercom calls. If your installer has programmed your station to have this feature, you can enable it as needed.

Generally, callers cannot override this feature. They hear two quick tone bursts every two seconds when they call a telephone that is set to the do not disturb mode. However, the installer may program some telephones with the ability to override a do not disturb condition at another telephone.

You can program a permanent do not disturb button to provide yourself with quick access to this feature if you wish. See the programming section of this user's guide for details.

- **To enable DND, proceed as follows:**
 1. Press *OPTIONS*.
 2. Press *NEXT* until the DND option appears.
 3. Press *DND*.
 4. Press *ON*.
 5. Press *EXIT*.
 6. Press *SPEAKER* to end.

- **To disable the DND condition,**
 1. Repeat the above procedure, but press *OFF* instead of *ON* at step 4.

- **To set a do not disturb condition at your telephone when a call rings at your station,**
 1. Hear ringing and notice incoming call information in display.
 2. Select *DND* option. Ringing will stop, caller will hear the do not disturb tone, and your telephone will remain in DND until you disable the feature (described above).

- **To override a do not disturb condition at another telephone, use the procedure detailed in section 3.10.**

7.15 Setting The Volume Control

The volume control on your telephone is a multipurpose control you can use to set the volume (loudness) of the ringer, the speaker, the handset, the headset, background music, and the group listening mode. You can either press and hold down the **VOLUME UP** or **VOLUME DOWN** button to automatically step through the volume levels for each mode, or you can press the switch once for each change in volume you desire.

You may adjust the loudness of the distant party at any time during a call whether you are listening over the speaker, the headset, the handset or the group listen mode by pressing the **VOLUME UP** or **VOLUME DOWN** button. When the call ends, the system resets the loudness of all future calls to the programmed (default) setting.

You can set a permanent loudness level for any volume control setting. When loudness is at desired level, dial ****7** or press **VOLSV** button (if programmed). The level will remain at this loudness (referred to as the default setting) until you change the setting.

NOTE: *Impact SCS 8324S-**, 8324F-**, and 8312S-** telephones support the optional ICVOL-** handset. The ICVOL-** is an amplified handset with its own volume control, making it useful in noisy environments. For ordering information, contact your Comdial dealer.*

- **There are four ringer loudness levels (plus an off position). Set these levels as follows:**
 1. While your telephone is on-hook and idle, press the **VOLUME UP** or **VOLUME DOWN** button once for each change in loudness you desire. The ringer sounds once for each change as an example of the current setting. Your selection becomes the new default setting and will result in your telephone ringing at that level for all future calls (until you change the default by repeating the above procedure).

NOTE: *If you set the ringer to the “off” position, your telephone will sound a short ring burst once for each call you receive at your station while the ringer is off.*

- **There are eight *speaker* loudness levels. Set these levels for the current call as follows:**
 1. While on a call and in speakerphone mode, press the **VOLUME UP** or **VOLUME DOWN** button once for each change in loudness that you desire.

 - **There are at least eight *handset* loudness levels that you can set for the current call as follows:**
 1. While on a call and in handset mode, press the **VOLUME UP** or **VOLUME DOWN** button once for each change in loudness that you desire.

 - **There are eight *headset* loudness levels that you can set for the current call as follows:**
 1. While on a call and in headset mode, press the **VOLUME UP** or **VOLUME DOWN** button once for each change in loudness that you desire.
- NOTE: On telephone models 8024S-** and 8012S-** your installer may have turned on the “high handset volume” feature, providing 13 handset/headset volume levels instead of 8.***
- **There are eight *group listening* loudness levels. Set the level for the current call as follows:**
 1. While on a call and in the group listening mode, press **VOLUME UP** or **VOLUME DOWN** button once for each change in loudness you desire.

 - **There are eight *background music* loudness levels. To set the level,**
 1. While background music is on at your station, press **VOLUME UP** or **VOLUME DOWN** button once for each change in loudness you desire. This level will remain set for background music until you change it again, even if you turn off the feature and then reactivate it.

- **To set a permanent speaker, headset, handset, or group listening loudness for all future calls,**
 1. Press **INTERCOM**.
 2. Activate speaker, headset, handset, or group listen mode to be affected.
 3. While in that mode, press **VOLUME UP** or **VOLUME DOWN** button to adjust loudness.
 4. Dial ****7** or press a preprogrammed **SAVE** button to hold the loudness at the last setting for all future calls (until you change the default again).
 5. Repeat this procedure in each mode until you've set all default volume levels.

7.16 Setting Your Personal Ringing Tones

You can choose one of eight different ring tones for your telephone. Often, when several telephones are located close together, each user chooses a different personal ring tone.

- **To select one of the ring tones, proceed as follows:**
 1. Press **OPTIONS**.
 2. Press **NEXT** until the **RING** option appears.
 3. Press **RING**.
 4. Press **UP** or **DOWN** to choose ring tone in display (a new tone will sound at each up or down press).
 5. Press **EXIT** to return to main display.
 6. Press **SPEAKER** to end.

The next time your telephone rings, you will hear the new ring tone.

7.17 Switching The Dialing Mode Between Pulse And Tone

If the telephone service in your locality is pulse (rotary dialing), the installer arranges your telephone to dial in this manner. If you need to send tones during a dialing sequence (for example, to send bank-by-telephone tones), you can convert to tone dialing mode while dialing. The system will switch back to pulse dialing when you end your call.

You can store a # as part of a speed dial number to cause an automatic switch from pulse to tone where needed in a number sequence.

- **To convert to tone dialing at any time during dialing or while on an active call,**
 1. Press #.

7.18 Using Background Music

If the telephone system supplies background music, you can turn it on at your LCD speakerphone while it is on-hook and idle. The system automatically turns background music off during calls and voice announcements.

- **To turn the music on,**
 1. Press **OPTIONS**.
 2. Press **MUSIC**.
 3. Press **SET**.
 4. Select **SRC 1** or **SRC 2** for the music source (the system is equipped to provide music from two sources, but this feature must be enabled by the installer).
 5. Press **SPEAKER** to end (the **SPEAKER** light turns on when background music is on).
 6. Adjust music volume with the volume buttons.

- To turn the music off,
 1. Press *OPTIONS*.
 2. Press *MUSIC*.
 3. Press *CLR*.
 4. Press **SPEAKER** to end (the SPEAKER light turns off when background music is off).

7.19 Using Direct Inward System Access (DISA)

This feature allows you to call into the digital communications system from an external telephone. You can call directly to intercom extensions and talk to the intercom parties or, if the system includes a voice mail option, leave messages for them if they are not available. When you call the DISA telephone number and dial your authorization code, the system treats your call as it would treat one coming from a system telephone and permits you to use many of the same features that you can use when you are calling from your assigned station. (Authorization codes are associated with personal or group intercom numbers and are assigned to you by your installer when he or she programs the system.) If you use your DISA access to make a call through the system and out on an outside line, the system applies all the toll restriction and automatic route selection to the call that the installer has programmed for the line that you are using. If you dial an incorrect authorization code, or the system is busy with other DISA calls, you will either hear an error tone, or the system will automatically route your call to one of the following areas (as determined by your system installer):

- a designated station where you can talk to the system attendant,
- a digital voice announce that will prompt you to take additional action,
- a proprietary voice mail station where you will be prompted to leave a message.

The system allows you three tries at dialing your authorization code before it routes your call as detailed above.

Some systems provide voice prompts to DISA callers and other systems do not. If you encounter voice prompts when you call on the DISA line, follow the prompt directions to complete your call.

Further, some systems with voice prompt enhancement, provide a one-digit menu that prompts you to dial a single digit to reach available departments, use system features, or obtain operator assistance.

NOTE: DISA is not recommended for use on loop start lines without disconnect supervision. While DISA will function, Comdial will not be liable for its performance under any condition where disconnect supervision is not provided.

Comdial has taken reasonable steps in the design of all product features, including DISA, which protect against unauthorized or fraudulent access to, or use of, a system, or which protect against unauthorized, fraudulent or unaccounted-for access to, or use of, long distance lines. However, no system is entirely invulnerable or immune from unauthorized or fraudulent access or use, or unaccounted-for access or use, and therefore Comdial disclaims any and all liability, and makes no warranty, express or implied, relating to unauthorized or fraudulent access or use, or unaccounted-for access or use.

- **To make a DISA call to an intercom number,**
 1. Dial number for DISA line (listen for voice prompt if available).
 2. Dial extension number.
 3. If station does not answer or is busy you will either hear busy tone or hear voice prompt if available. If you dial an invalid number, you will hear error tone.
 4. If voice prompt provides dialing codes, dial proper code for services such as: track, message waiting, or voice mail.
- **To make a DISA call to use system features,**
 1. Dial number for DISA line (listen for voice prompt if available),
 2. Dial authorization code (listen for voice prompt if available; otherwise, hear stutter-style dial tone—remember, the system gives you only three tries to dial your code correctly),
 3. Dial feature code and listen for acknowledgment tone.

NOTE: If you are selecting a line group through DISA for outside calling, you can raise the audio level on this line when needed. Do this before you select the line by dialing **7, and then dialing 1 for 0 dB, 2 for +3dB, or 3 for +6dB of gain. In some cases, added gain can introduce circuit instability that presents itself as a singing sound, which can interfere with dialing and voice communications. If you experience this condition, select a lower gain setting.

System Features Available To DISA Callers	Default Dialing Code
Account code entry	*04
Automatic route selection access	9
Call waiting on busy	*6
Do not disturb override	*03
Intercom dialing/call announcing	nnnn
Message wait off*	#3
Message waiting set*	*3
Personal speed dial*	*01
System speed dial	*01*
Tracker access**	*8
Tracker page orbit retrieval**	#8
Trunk group access	9, 80-89, 60-64
Zone paging	70-77
<p><i>* You must have an assigned personal intercom number to use this feature.</i></p> <p><i>** Your system must provide the Tracker option to activate this feature.</i></p>	

7.20 Using The Auxiliary Jack

NOTE: Only the 8024S telephone has an auxiliary jack. All other model telephones use the handset jack to plug in a headset.

The auxiliary jack provides an interface for a headset, a tape recorder, an external ringer or an external pager. You or your system installer can connect any one of these auxiliary devices as you need them. You must program one of the programmable buttons on your telephone to serve as an enable/disable button for each auxiliary device you plan to connect to your LCD speakerphone. The system will activate only the device that it identifies in the display, and will activate only one device at any time.

The ***headset mode*** allows you to operate your telephone with a headset instead of as a speakerphone or with the handset.

NOTE: The recorder, external ringer, or pager requires external power.

The ***recorder mode*** allows you to send your voice and that of the distant party to a tape recorder.

NOTE: A recording device requires a special peripheral cord for connection. See your system installer for details.

The ***ringer mode*** allows an external speaker to sound the ringing of your telephone.

The ***pager mode*** allows an external paging device to sound all voice announcements (all-call, zone paging, voice announced intercom calls) sent to your telephone.

CAUTION

With the exception of a headset microphone, do not connect the audio output of any external device to the auxiliary jack. Also, do not connect the tip and ring leads of a telephone line to the auxiliary jack. Do not connect any devices to the auxiliary jack other than those mentioned above.

- **Program the enable/disable buttons (at any blank programmable button location) as follows:**
 1. Press *OPTIONS*.
 2. Press *NEXT* until the FEAT option appears.
 3. Press *FEAT*.
 4. Press *NEXT* until the APAGE or ARECD options appear.
 5. Press *APAGE* or *ARECD* to choose pager or recorder,
—OR—
press *NEXT* until the ARING or HDSET options appear.
 6. Press *ARING* or *HDSET* to choose external ringer or headset.
 7. Press blank programmable button location to serve as enable/disable button for the feature you've selected.
 8. Press *SPEAKER* to quit,
—OR—
press *FEAT* and follow the previous steps if you wish to add enable/disable buttons for other auxiliary devices.
- **To enable an auxiliary mode,**
 1. Press enable/disable button to enable mode. Light associated with button turns on and display denotes feature.
- **To disable an auxiliary mode,**
 1. Press enable/disable button. Light associated with button will turn off and display no longer denotes the feature.

7.21 Using The Tracker Paging System

The Tracker Paging System option allows you to send call back and parked call messages to Tracker pagers assigned to station extension numbers.

Along with the parked call message, the system parks the call in orbit for retrieval by the paged party. The type of message that the system delivers (either alphanumeric or numeric-only) is dependent upon the Tracker pager model in use at the station.

When outside callers call into a system that has both a Tracker Paging option and a voice mail option installed, the system gives these callers the option of either leaving a message or tracking the person that they are calling.

If you have a Tracker pager assigned to your personal intercom number, you can receive messages that someone else sends you. The system automatically installs the Tracker pager for your use; however, you can disable it when you do not wish to receive paged messages and when you leave at the end of your day. Of course, if you do disable your Tracker pager at the end of your day, be sure to enable it at the beginning of your next day.

Your LCD speakerphone includes an interactive **TRACK** button; however, if your day-to-day operation includes extensive Tracker usage, such as in an attendant function, your installer may include a **TRACK** button at a programmable button location.

- **To track a called party after receiving a ring—no answer,**
 1. Make an intercom call to someone and receive no answer.
 2. Press **TRACK**.
 3. Hear confirmation beep (Tracker page accepted) or hear busy tone (Tracker page not accepted).
 4. Press **SPEAKER** to end.

- **To track a called party without first calling them,**
 1. Press installer-programmed **TRACK** button (or press **INTERCOM** and dial ***8**).
 2. Dial extension number.
 3. Hear confirmation beep (Tracker page accepted) or hear busy tone (Tracker page not accepted).
 4. Press **SPEAKER** to end.

- **To use Tracker to transfer a call to a park orbit for retrieval and transmit the call's park orbit code and caller ID information (if available),**
 1. Answer call and press **TRANS**.
 2. Dial extension number.
 3. If the called station does not answer or is busy, press **TRACK**.
 4. Hear confirmation beep (Tracker page accepted) or hear busy tone (Tracker page not accepted).
 5. Press **SPEAKER** button to end.
- ***NOTE: Tracker parked calls will recall to your station after a pre-programmed time-out. You can either place the call into another Tracker page orbit or retrieve the call for servicing.***
- **To retrieve a call that you parked using the Tracker option,**
 1. Press **HOLD** button to scroll your held calls, (display shows *Page* and extension number of each parked call).
 2. Press **TAP** to retrieve the displayed parked call.
- **If you receive a parked call message on your Tracker pager,**
 1. Go to any system station.
 2. Press **INTERCOM**.
 3. Dial Tracker pager displayed orbit code (**#800-#899**).
 4. Retrieve call.
- **To enable or disable a Tracker pager at your station,**
 1. Press **INTERCOM**.
 1. Dial ***06** to disable,
—OR—
dial ***07** to enable.
 2. Press **SPEAKER** to end.

7.22 Using E and M Tie Lines

E & M tie line operation is typically used in applications where one group of users often need to call parties located in one or more remote locations. In these applications, your system is directly tied to another similar system at the remote site(s).

If your system has been configured for tie line operation, the procedures you use to place calls, transfer calls, and set up conference calls differ slightly from other types of connections. These procedures are described in this section.

- **To make a call on an E & M tie line,**
 1. Dial the E & M access code that was assigned by the installer,
—OR—
if your system has been configured by the installer to use Automatic Route Selection (ARS), dial the ARS access code (9).
 2. Wait until you hear a dial tone, then dial the intercom number for the party you wish to reach at the remote site. You will hear a fast busy signal if you dialed an invalid number.

- **To transfer a call over an E & M tie line,**
 1. Answer the incoming call.
 2. Press **CONF**.
 3. Dial the E & M access code that was assigned by the installer,
—OR—
if your system has been configured by the installer to use Automatic Route Selection (ARS), dial the ARS access code (9).
 4. Wait until you hear a dial tone, then dial the intercom number for the distant party to whom you are transferring the call.
 5. If you are doing a screened transfer, stay on the line until the called party answers so that you can announce the call,
—OR—
hang up (unscreened transfer). If the called party does not answer, the call will return to you after the transfer recall timer expires.

NOTE: After transferring the call to the remote end of the E & M tie line, you will have created an unattended conference, and your telephone will appear as though it were on hold.

6. Press **TAP** button to rejoin the transferred call.
7. After rejoining the conference, press **#** to place the call on hold again (creating another unattended conference) or hang up to terminate the call.
 - * *You can eliminate this step if the installer has configured your system for quick transfer and you are accessing the E & M line with a group access code.*

If one of the parties does not hang up or you have not terminated the call, the call will return to you when the line-to-line connection timer expires.

- **To set up a conference call on an E & M tie line,**
 1. Make first call.
 2. Press **CONF**; call is placed on hold automatically.
 3. Select next line and make next call.
 4. Press **CONF** to establish conference.
 5. Press **TRANSFER/CONFERENCE** button to add more parties for up to a 7-party conference (including yourself).
- **To continue conversation on remaining line after other outside lines have dropped out of conference,**
 1. Press the line button of the remaining party.
- **To retrieve a line from hold and bring that party back into the conference,**
 1. Press **TRANSFER/CONFERENCE**.
 2. Press line button.
 3. Press **TRANSFER/CONFERENCE**.

NOTE: *If all the conference circuits are busy, you will not be able to add a party to the conference.*

- **To drop out of a conference call between you and two outside lines (creating an unsupervised conference),**
 1. Hand up (lines remain lighted and in use until one or both outside parties disconnect).
- **To rejoin an unsupervised conference between two outside lines,**
 1. Press **TAP**.

***NOTE:** Conference volume levels depend upon the quality of the external lines.*

7.23 Call Forward Outside System

The Call Forward Outside System (CFOS) feature allows you to forward incoming or transferred line calls to telephone numbers outside the system. The CFOS feature forwards calls over any available outbound line or line groups and does not use any conference circuits. Since CFOS involves outbound calls, those calls are subject to all line access, toll restriction, and automatic route selection restrictions normally imposed on your calls. The CFOS feature is useful if you need to forward your after-hours calls to an alternate site such as your home or cellular telephone.

- **To activate CFOS with your LCD speakerphone,**
 1. In succession, press *OPTIONS*, *CFWD*, *SET*, and *NEXT*.
 2. Notice that the *CFOS* option now shows in the display.
 3. Press *CFOS*.
 4. Select outbound line (press line button, dial appropriate code, or do nothing and let previously selected line remain in effect). If you want to change the destination, you must enter something for the outbound line.
 5. Select forward destination (dial number, press speed dial button, or do nothing and let previously selected destination remain in effect).
 6. Press **SPEAKER** to end (display shows CFOS).

- **To deactivate CFOS,**
 1. Press **CFOS** interactive button,
—OR—
press **CFOS** preprogrammed button or press **INTERCOM** and dial * **56**.

- **To join an active CFOS call from the CFOS-enabled station,**
 1. Note flashing **HOLD** light indicating active CFOS call, and press **TAP**. Join CFOS-forwarded party and CFOS destination in a conference call.

Comdial has taken reasonable step in the design of all product features, including CFOS , which protect against unauthorized or fraudulent access to, or use of, a system, or which protect against unauthorized, fraudulent or unaccounted-for access to, or use of, long distance lines. However, no system is entirely invulnerable or immune from unauthorized or fraudulent access or use, or unaccounted-for access or use, and therefore Comdial disclaims any and all liability, and makes no warranty, express or implied, relating to unauthorized or fraudulent access or use, or unaccounted-for access or use.

7.24 Mark Problem Line

Your programmer can arrange the system so that you can mark a line that is not functioning properly. You do this by pressing a pre-programmed **MARK** button or by dialing a feature code of your choice. After you have marked a particular line a programmed number of times, the system takes the line out of service (unless programmed to prevent this from happening). When the system takes the line out of service, it logs the condition and triggers an alarm. The printed error log will then show which line is out of service and so will the displayed error log. An out of service line is only out of service for line group use; it is available for direct selection or prime line access. Further, an out of service line is available for all inbound calls unless it is a DID line. You can not mark a line during a conference call or if you are calling in as a DISA caller.

The system manager can use the line disable feature at the programmer's station to restore service on the out of service line.

- **To mark a line,**

1. Press the **MARK** button on your telephone,

—OR—

press **INTERCOM** and dial a code of your choice.

(The system will not accept your choice if it conflicts with an existing feature code or intercom number.)

NOTE: When you mark a line during an active call, the system records the mark for the active line. If you take marking action during an idle condition, the system records the mark for the last active line (this includes lines that are presently on hold).

7.25 Automatic Set Relocation

If your installer has equipped your system with automatic set relocation, when you move your telephone to a new location, the system will give you a choice (through a display prompt) as to whether you want to keep your previous programming or use the programming in the new location.

- **To maintain the extension number and programming features from the old location,**
 1. Connect the telephone line cord to the new jack.
 2. Note the flashing HOLD light and press the **HOLD** button while the light is still flashing (your telephone immediately assumed the features from the previous location),
—OR—
do nothing until the HOLD light stops flashing (your telephone automatically assumes the features from the previous location).
- **To assume the extension number and programming features from the new location,**
 1. Connect the telephone line cord to the new jack.
 2. Note the flashing HOLD light and press the # button while the light is still flashing (your telephone immediately assumes the features from the new location).

7.26 Using The IMIST Module

Impact SCS 8324F-**, 8324S-**, and 8312S-** speakerphones equipped with the optional IMIST module can support an IST device (modem, FAX machine, industry-standard telephone, etc.) in addition to the LCD speakerphone. Depending on system programming, the IST device may be used to make outgoing calls and receive incoming calls.

The functionality of the IMIST module depends on the type of system you are using.

- The IMIST module will function on a DXP system with the appropriate digital station board, but the IMIST module will not have its own extension number and will not function simultaneously with the speakerphone.
- On a DXP *Plus* system, the IMIST module will function simultaneously with the speakerphone and have its own extension number if your system has the appropriate digital station board and memory board. If your system does not have the optional enhanced memory board, the IMIST module will function like the one on the DXP system described above.
- On an FX Series system, the speakerphone and IMIST module can function simultaneously and the IMIST module has its own extension number.

NOTE: *The IMIST module does not provide voltage to light a message waiting light. Message waiting lights on devices plugged into the IMIST module will not function.*

If you have any other questions about IST devices, refer to GCA70-237, *Industry-Standard Telephone Station User's Guide*.

NOTE: *The IMIST module has a separate power supply. The wall transformer is a UL and CSA approved Class 2 device operating from 120 Vac, 60 Hz, 16 watts and provides an output of 24 Vac at 450 mA. For replacement, order Comdial P/N DIU-PTR.*

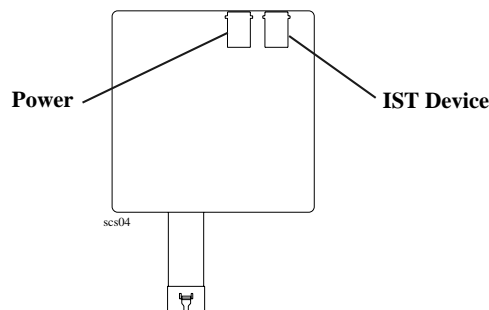

IMIST Module

7.27 Using The Caller ID Feature

The Caller ID feature allows you to view incoming call numbers before you answer them. Incoming call numbers flash in the lower half of the LCD. If you answer the call, the number appears in the upper half of the LCD.

The system also stores numbers that ring on your line but receive no answer. The system indicates that it has stored ring-no answer numbers by causing the CID light on your telephone to flash. Pressing the **CID** button allows you to view the stored numbers one at time. Pressing the **SAVED NUMBER REDIAL** button causes the system to dial the displayed number. If the call has been returned by someone else, pressing the * key reveals who returned the call. Everyone sharing your line can scroll through the stored numbers and choose which calls to return.

NOTE: *If your system installer has not programmed a **SAVED NUMBER REDIAL** button, refer to section 9.4, Using The Feature Buttons, for instructions on programming this button.*

- **To scroll through ring-no answer numbers stored on your system,**
 1. If your CID light is flashing, the system has unreturned ring-no answer numbers stored in memory.
 2. To view the list of unreturned ring-no answer number, press the preprogrammed **CID** button on your telephone. Your LCD will display the calling number, date, and time the call came in. The most recent call appears first in the list.
 3. Press the **CID** button each time you wish to display the next most recent ring-no answer call to your line.
 4. To dial one of the numbers in the redial queue, press the **SAVED NUMBER REDIAL** button. The system will automatically dial the number.

Depending on your system programming, when a call is returned it might remain in the ring-no answer queue or the system might delete it from the ring-no answer queue. Your system installer can tell you how the feature is programmed. If the system is programmed to leave a returned number in the redial queue, the display will show a * next to numbers that have been returned.

- **To determine who viewed the number and returned the call,**
 1. Press *.

This page remains blank intentionally.

8

Sending And Receiving Non-Verbal Messages

8.1 Message Waiting Light and Messaging

If the system installer designates your LCD speakerphone as a *central message desk* or programs it to have message-wait originate ability, you can turn on the message-waiting light of any other telephone. This light lets that telephone user know that you have a message for him or her. In addition to the message waiting light, leaving a message indication at a station that is a prime intercom, also causes the dial tone at that station to sound in a broken manner when the station user takes his or telephone off-hook.

If a telephone that receives a message has a DSS button that is programmed to call the station that left the message, the light next to that DSS button on the message-receiving station will flash.

- **To turn on the message-waiting light (and a broken dial tone) at another station that is idle or busy,**
 1. Press **INTERCOM**.
 2. Dial * 3.
 3. Dial extension number of station to be alerted. The message-waiting light of called station will flash.

- **You can also turn on the message-waiting light and broken dial tone at another station when that station is busy,**
 1. Hear the busy tone and remain on the line.
 2. Press **MSG**.
 3. Hang up.

- **To turn off the message waiting light at a busy or idle station,**
 1. Press **INTERCOM**.
 2. Dial # **3**.
 3. Dial extension number of station that was alerted. The message-waiting light of called station will turn off.

- **To turn off the message-waiting light during message-delivering conversation,**
 1. Press **INTERCOM** once if off-hook, twice if on-hook.

NOTE: Only the person who sent the message and the person receiving the message can turn the indicator off.

- **To receive a message at an alerted station,**
 1. Observe flashing message waiting light and the LCD message indicating who called for you.
 2. Press **CALL** to dial the messaging station automatically,
—OR—
press **CLEAR** to clear the message from your station.

8.2 Sending LCD Messages

You can set system-supplied messages at your station to be received and displayed by a calling LCD speakerphone. These messages give the caller information on your telephone status. Get a list of the available messages from the attendant and write them on the blank chart on the next page.

- **To turn on a message from your telephone,**

1. Press **INTERCOM**, then dial * **0 2**.
2. Dial the desired code number from your message list (01–30) on the next page. Alternately you can use the **HOLD** button to scroll through the available messages and dial # when you scroll to the message you want to use. If you use the default messages *Back at* and *Call*, add to them as follows:

For *Back at* message, dial the code for time numbers and colon from dialing codes table (for example, dial # **00 01 29 04 05** for the time 01:45).

For *Call* message, dial code for telephone number of where you'll be (for example, dial # **09 07 08 15 02 02 00 00** for the number 978-2200).

3. Press #, then press **SPEAKER** to end message.
4. Intercom light flashes.

- **To turn off the message and your intercom light,**

1. Press **INTERCOM**, then dial # **0 2**.

Dialing Code Table			
Character	Dialing Code	Character	Dialing Code
1	01	8	08
2	02	9	09
3	03	0	00
4	04	space	12
5	05	–	15
6	06	:	29
7	07		

LCD MESSAGE LIST (Write the attendant supplied messages here.)	
Dial Code	Message
01	Back at (default message 1)
02	Call (default message 2)
03	Ask them to hold (default message 3)
04	Take a message (default message 4)
05	I will call back (default message 5)
06	
07	
08	
09	
10	
11	
12	
13	
14	
15	
16	
17	
18	
19	
20	
21	
22	
23	
24	
25	
26	
27	
28	
29	
30	

8.3 Sending Response Messages

By programming one or more **RESPONSE MESSAGE** buttons on your LCD speakerphone, you can respond with a variety of messages to many calling situations. For example, if you call another station and receive a busy signal or no answer, you can send one of 30 system-supplied messages, or you can send the same message each time the situation arises. Further, you may at times receive intercom or SOHVA calls that you decide not to answer, and you can send a message to the display of the calling LCD speakerphone for the caller to read.

If you program a scrolling **RESPONSE MESSAGE** button at your telephone, you may use it to scroll through and select any of the system's messages to send, allowing you to send a different message every time. If you program a fixed **RESPONSE MESSAGE** button, you can send the same message every time in response to a situation, which saves you the trouble of scrolling to the message you want to send.

This section tells you how to use the **RESPONSE MESSAGE** button(s) to send messages to other LCD speakerphones. Refer to section 10.1 for instructions on programming the **RESPONSE MESSAGE** button(s).

- **To send an LCD message when you call and receive busy signal or no answer,**
 1. While still on the call, press the appropriate fixed **RESPONSE MESSAGE** button to send a preselected message (*Call [your name]*, for example) to the other telephone,
—OR—
while still on the call, press the scrolling **RESPONSE MESSAGE** button to scroll through the system-supplied messages.
 2. Press # when your display shows the message you wish to send (the message will then be displayed at the called telephone).

NOTE: *For the example in step 1, you would use default message 2. Your name would then be added from the station name programming done by the installer.*

- **To send an LCD message to a caller who has initiated a SOHVA or intercom call from another LCD telephone,**
 1. Hear the SOHVA tone or voice announcement in your handset or headset.
 2. Press the appropriate fixed **RESPONSE MESSAGE** button to send a preselected message (*I Will Call Back*, for example) to the calling telephone,
—OR—
while still on the call, press the scrolling **RESPONSE MESSAGE** button to scroll through the system-supplied messages.
 3. Press # when your display shows the message you wish to send (the message will then be displayed at the calling telephone and the SOHVA call will be terminated).

9

Programming Your Telephone

9.1 Programming For Speed Dialing

Speed dialing is a feature that lets you:

- store and dial lengthy numbers using one or two buttons,
- store and dial intercom numbers of frequently called telephones,
- store frequently used feature codes.

You can store numbers for speed dialing at the following locations:

- at any programmable button that is *not now assigned as a line button or other feature* by the system administrator or installer,
- at the keypad numbers 0–9 (primary level only),
- on a secondary level at any of the programmable button locations.

Before you begin programming, write down the intercom or outside line you will use and the number digits that you are storing. Then, as you program the speed dial numbers, write the first and second level numbers on your telephone's ID strips. You can also fill out the charts on the next page, if you wish, for a personal record of your stored numbers.

NOTE: *The Federal Communications Commission (FCC) requires that when programming emergency numbers and(or) making test calls to emergency numbers:*

- 1. Remain on the line and briefly explain to the dispatcher the reason for the call;*
- 2. Perform such activities in the off-peak hours, such as early morning or late evening.*

Speed Dial Numbers (Programmable Buttons)			
1		13	
2		14	
3		15	
4		16	
5		17	
6		18	
7		19	
8		20	
9		21	
10		22	
11		23	
12		24	

Personal Speed Dial Numbers (Keypad Buttons)			
1		6	
2		7	
3		8	
4		9	
5		10	

9.2 Storing Speed Dial Numbers

- To store an outside number as a speed dial number, follow the display prompts and proceed as follows:

NOTE: *Programming overwrites existing speed dial numbers at button locations.*

1. Press **OPTIONS**.
2. Press **NEXT** until **SDIAL** option appears.
3. Press **SDIAL** to choose speed dial programming.
4. Press programmable button or dial pad button (**0–9**) to choose storage location (remember, to access second level storage at a programmable button, press **SHIFT** first).
5. Make your speed dial route selection choice from the following list:
 - press line button to select outside line,
 - dial **00** to select prime line or last line used,
 - dial **01–16** to select line group,
 - press **INTERCOM** button or dial **8** to select intercom.
6. Dial number (up to 16 digits long—include * and # if needed).

NOTE: *You may need a pause between numbers to compensate for differences in response time between your system and the host system (ask your attendant about this). To store a pause, press **HOLD**, then continue dialing. If your system is behind a host system that needs a hookflash to access a feature, press **TAP** to store a hookflash, then continue dialing. If you need to erase the typed digits appearing in your display to correct them, press **BKSP** once for each digit to be removed.*

7. Press **SAVE** to store the number.
8. Press next location button and store next number, repeat previous steps until all numbers are stored,
—OR—
press **EXIT**.
10. Press **SPEAKER** to end.

9.3 Storing DSS Numbers

- To store an intercom number as a DSS number,

NOTE: *Storing DSS numbers at button locations will overwrite any previously stored numbers.*

1. Press **OPTIONS**.
2. Press **NEXT** until the DSS option appears.
3. Press **DSS**.
4. Press programmable button to choose DSS location.
5. Dial extension number.
6. Press next location button and store next DSS number.
7. Repeat the previous step until all DSS numbers are stored,
—OR—
press **EXIT**.
8. Press **SPEAKER** to end.

Write Your DSS Numbers On This Chart	

9.4 Using The Feature Buttons

You can create feature access buttons to make operation easier. To do this, use the interactive buttons to select the feature you want to store, and then store it on a programmable button (see the instructions on the next page).

Account Code Button (ACCT)—allows you to enter an account code for call record purposes.

Auxiliary Pager (APAGE)—selects external pager operation through the auxiliary jack.

Auxiliary Recorder (ARECD)—selects tape recorder operation through the auxiliary jack.

Auxiliary Ringer (ARING)—selects auxiliary ringer operation through the auxiliary jack.

Call Forward Button (CFWD)—allows you to forward all of your calls to another telephone.

Camp-On With Automatic Call Back (CAMP)—allows you to camp on to a station. The system calls you back as soon as the called station becomes idle or occupied.

Camp-On (Call Waiting) (CAMP)—when calling a busy station, this feature allows you to send a call waiting tone to the station and to wait on-line for a reply.

Clear Features (CLEAR)—clears a currently active or engaged feature.

Do Not Disturb Button (DND)—prevents other telephones from ringing your telephone.

Group Listen Button (GPLSN)—allows others to hear a conversation over the telephone speaker while you use the handset or headset; the distant party can hear only the conversation transmitted through the the handset or headset microphone.

Headset (HDSET)—enables headset operation through the auxiliary jack.

Music Button (MUSIC)—allows you to enable or disable background music; also allows you to choose from two pre-programmed music sources.

Page Button (PAGE)—provides one-button access to paging.

Park Button (PARK)—parks calls in preselected park orbit.

Pick-Up Button (PCKUP)—allows you to pick up a call ringing elsewhere in your system.

Privacy Release Button (PRIV)—releases privacy for current call.

Saved Number Redial Button (SAVE)—redials the last number saved at this button location (good for short-term storage).

Voice-Announce Block Button (VAB)—blocks voice announcements.

- **To create a feature access button,**
 1. Press **OPTIONS**.
 2. Press **NEXT** until the **FEAT** option appears.
 3. Press **FEAT**.
 4. Press **NEXT** repeatedly until desired feature choice is displayed.
 5. Press one of the buttons below the current display to choose desired selection.
 6. Respond to any menu prompts associated with feature (such as *all-call* or *zone 1 to 9* for **PAGE**).
 7. Press programmable button for storage location.
 8. Press **FEAT** again to program the next feature.
 9. Repeat last two steps until all features are programmed,
—OR—
press **EXIT** to end programming.
- **To clear a feature button assignment,**
 1. Repeat the above procedure, but press **CLEAR** before pressing storage location button.

9.5 Storing The Response Message Button

You may program a **RESPONSE MESSAGE** button, which allows you to send an LCD message to a caller who has initiated a SOHVA or intercom call from another LCD telephone, or to send an LCD message to another LCD telephone that you call and receive a busy signal or no answer.

There are two types of **RESPONSE MESSAGE** buttons you can program at your station:

- A scrolling **RESPONSE MESSAGE** button lets you choose from 30 system-supplied messages each time you press the button.
- One or more fixed **RESPONSE MESSAGE** buttons that will send the same preselected message every time you press it. If, for example, you know that you want to send the message *I Will Call Back* every time you receive a SOHVA you cannot respond to, program a fixed **RESPONSE MESSAGE** button with that message and label the button accordingly.

Before programming, obtain a list of system-supplied messages from your attendant or system installer so that you can choose an appropriate message.

- **To store a scrolling RESPONSE MESSAGE button, proceed as follows,**
 1. Press **INTERCOM**.
 2. Dial * * 6.
 3. Press programmable button for **RESPONSE MESSAGE** button location.
 4. Dial 00.
 5. Press # to save programming.
 6. Press **SPEAKER** to end.
 7. Label button location.

You may save as many different fixed **RESPONSE MESSAGE** buttons as you need.

- **To store a fixed RESPONSE MESSAGE button,**
 1. Press **INTERCOM**.
 2. Dial * * **6**.
 3. Press programmable button for **RESPONSE MESSAGE** button location.
 4. Dial message number (**01-30**) from list of messages.
 5. Press # to save programming.
 6. Press **SPEAKER** to end.
 7. Label button location.

NOTE: Your system installer can also program response messages.

9.6 Storing Access Codes

You can store feature access codes at programmable buttons to provide yourself with one-button access to features that you use quite often. To find your feature codes of interest, turn to the *Quick Reference Guide* that is located at the end of this publication.

Remember, your LCD speakerphone provides interactive buttons that eliminate almost every need for feature code dialing. Further, the installer may store frequently-used features at your telephone buttons and label the buttons with the feature's mnemonics. Finally, you can follow the instructions provided in section 9.4 to directly assign feature buttons without having to store their feature dialing codes.

- **To store an access code,**
 1. Press **INTERCOM**.
 2. Dial * * **3**.
 3. Press programmable button.
 4. Dial access code for feature (for example to create a call divert button, store ***55** plus an extension number).
 5. Press **SPEAKER** to end.
 6. Label button location.

9.7 Setting A Reminder Alert

You can set up to two reminder alerts to sound at your LCD speakerphone so that you will remember important regular events (a daily 10:00 meeting or a daily conference call, for example) or occasional events (classroom training, appointments, etc.).

When an alert sounds at the set time, you will hear four short tone bursts, which will continue until acted upon. If you are not at your station to hear the alert when it sounds, your telephone's ring tone will change to the alert tone for every incoming call until you respond to the alert.

- **To set a reminder alert at your telephone,**
 1. Press **OPTIONS**.
 2. Press **NEXT** until the ALERT option appears.
 3. Press **ALERT**.
 4. Press **1** or **2** to select available alert designation; if you have already programmed an alert for 1, press 2 to set a second alert condition.
 5. Press **ON** (press **OFF** to turn off an alert that has already been set).
 6. Dial reminder time using the numbers on the dial pad (remember to add a zero [0] before single digit times: 01 for one o'clock, 02 for 2 o'clock, etc.).
 7. Set **AM** or **PM**.
 8. Press **SAVE**.
 9. Press **SPEAKER** to quit.

- **To respond to an alert after it sounds,**
 1. Press **CLEAR** to turn off the alert,
—OR—
press **SET** to reset the alert for the same time the following day.

This page remains blank intentionally.

10**Using The Attendant Features****10.1 Creating The LCD Messages**

System users send and receive non-verbal messages for display on their LCD speakerphones. Users send these messages so that callers will know their status. LCD messages are either those that the DXP system provides or those that you create. The system provides five messages; you can add up to 25 customized messages. You can even store customized messages in place of the default messages if you wish, thus increasing the number of custom messages available. Distribute a list of the LCD messages to the system users for their reference.

- **To store the LCD messages, proceed as follows:**
 1. Write your messages on the chart on page 10-4 (each message can have up to 16 characters).
 2. Use the letter code table on page 10-3 to assign a number to each character.
 3. Write these numbers on the chart line beside the characters in your message.
 4. Press **INTERCOM**.
 5. Dial *** # 0 * 1 2**.
 6. Dial a message location number (01-30).
 7. If a message currently exists at selected location, dial **#** to clear it.
 8. Compose your messages by dialing the two-digit codes that relate to the letters.
 9. Dial **#** to save message.
 10. Repeat previous step until all messages are stored.
 11. Press **SPEAKER** to end.

Example: Create the LCD message “TAKE MESSAGE” and program it into message location number 3.

1. Press **INTERCOM**, dial * # 0 * 1 2.

2. Dial **0 3 #**.

3. Dial code numbers for message.

81 21 52 32 12 61 32 73 73 21 41 32

T A K E M E S S A G E

4. Dial # and press **SPEAKER** to end.

Letter Code Table For LCD Messages					
Character	Code	Character	Code	Character	Code
A	21	a	24	SPACE	12
B	22	b	25	;	17
C	23	c	26	/	18
D	31	d	34	"	19
E	32	e	35	.	27
F	33	f	36	,	28
G	41	g	44	:	29
H	42	h	45	1	01
I	43	i	46	2	02
J	51	j	54	3	03
K	52	k	55	4	04
L	53	l	56	5	05
M	61	m	64	6	06
N	62	n	65	7	07
O	63	o	66	8	08
P	71	p	74	9	09
Q	11	q	14	0	00
R	72	r	75		
S	73	s	76		
T	81	t	84		
U	82	u	85		
V	83	v	86		
W	91	w	94		
X	92	x	95		
Y	93	y	96		
Z	13	z	16		

LCD Message List													
Msg.	Message Text	Letter Codes											
—	Sample	7	3	2	4	6	4	7	4	5	6	3	5
01*	Back at												
02*	Call												
03*	Ask them to hold												
04*	Take a message												
05*	I will call back												
06													
07													
08													
09													
10													
11													
12													
13													
14													
15													
16													
17													
18													
19													
20													
21													
22													
23													
24													
25													
26													
27													
28													
29													
30													

* System generated message—you can store a custom message in its place as needed.

10.2 Disabling A Station

You can disable a station and make it unavailable for system use if it becomes unusable for some reason.

- **To disable a station,**
 1. Press **INTERCOM**.
 2. Dial *** # 0 * 5 2**.
 3. Dial station number as follows to choose station, dial **1001-1480** for stations 1-480.
 4. Press **#** to disable the station (LCD speakerphone displays a ***** to indicate it is disabled).
 5. Press **SPEAKER** to end.
- **To re-enable station,**
 1. Repeat the previous procedure.

10.3 Disabling A Telephone Line

You can disable a line and make it unavailable for system use if it becomes unusable for some reason.

- **To disable a line,**
 1. Press **INTERCOM**.
 2. Dial * # 0 * 3 2.
 3. Dial code as follows to choose line:
 - dial **1#-99#** for lines 1-99,
 - dial **100-128** for lines 100-128.

***NOTE:** If the desired line code is less than three digits, you must dial # once after you dial the line code. For example, dial 1# for line 1 or 19# for line 19.*

4. Press # to disable line (LCD speakerphone displays a * to indicate a disabled line).
 5. Press **SPEAKER** to end.
- **To re-enable line,**
 1. Repeat the previous procedure.

10.4 Enabling Or Disabling Message Waiting

You can enable or disable the message-waiting feature that was assigned to a user through their class of service (COS) programming.

- **Disable a user's message-waiting feature,**
 1. Press **INTERCOM**.
 2. Dial * # 0 * 4 1 7.
 3. Dial the user's COS number.
 4. Dial # to disable the user's message waiting feature.
 5. Press **SPEAKER** to end.

- **To re-enable the message-waiting feature for the originally assigned user,**
 1. Repeat the previous procedure.

10.5 Naming The System Telephones

You can assign a name that is either a personal name or a group name to each system telephone. This name can be up to seven letters in length and will show up in the user's display and/or in the called party's display. You can compose a valid name from any alpha-numeric character; however, the first character of a display name must be an alphabetic character. Typical names could be SRVC, MKTG 1, K SMITH.

When appropriate programming action has been taken by the installer, a second line showing the personal intercom number of the calling station is also displayed. A typical example could be:

M JONES
1482

- **Name the system telephones as follows:**
 1. Use letter code table (page 10-9) to compose names for all telephones requiring them (up to seven letters per name are allowed) and record the names on the station name record (pages 10-10 and 10-11).
 2. Press **INTERCOM**.
 3. Dial *** # 0 * 5 3**.
 4. Select telephone to be named by dialing the extension number (dial number plus # if extension number is less than four digits).
 5. Dial # to clear any current entry.
 6. Dial two-digit codes that correspond to letters in name (station names must begin with a letter).
 7. Dial # to save name or save cleared name.
 8. Dial next extension number (plus # if less than four digits), dial # to clear current entry, dial codes for letters, dial # to save.
 9. Repeat previous step until all telephones are named.
 10. Press **SPEAKER** to end.

Letter Code Table For LCD Messages					
Character	Code	Character	Code	Character	Code
A	21	a	24	SPACE	12
B	22	b	25	;	17
C	23	c	26	/	18
D	31	d	34	“	19
E	32	e	35	.	27
F	33	f	36	,	28
G	41	g	44	:	29
H	42	h	45	1	01
I	43	i	46	2	02
J	51	j	54	3	03
K	52	k	55	4	04
L	53	l	56	5	05
M	61	m	64	6	06
N	62	n	65	7	07
O	63	o	66	8	08
P	71	p	74	9	09
Q	11	q	14	0	00
R	72	r	75		
S	73	s	76		
T	81	t	84		
U	82	u	85		
V	83	v	86		
W	91	w	94		
X	92	x	95		
Y	93	y	96		
Z	13	z	16		

10.6 Naming The Telephone Lines

You can assign names to lines to aid users in identifying the proper line to use. A line name can be up to seven letters in length and will show up in the user's display.

- **Name the system telephones as follows:**

1. Use letter code table (page 10-13) to compose names for all lines requiring them (up to seven letters per name are allowed) and record the names on the line name record (page 10-14).
2. Press **INTERCOM**.
3. Dial * # 0 *3 3.
4. Dial code to choose line:
 - dial **1#-99#** for lines 1-99,
 - dial **100-128** for lines 100-128.

NOTE: *If the desired line code is less than three digits, you must dial # once after you dial the line code. For example, dial 1# for line 1 or 19# for line 19.*

5. Dial # to clear any current name.
6. Dial two-digit codes that correspond to letters in name (line names must begin with a letter).
7. Dial # to save name or cleared name.
8. Dial next line number (plus # if less than three digits), dial # to clear current entry, dial codes for letters, dial # to save.
9. Repeat previous step until all telephones are named.
10. Press **SPEAKER** to end.

Letter Code Table For LCD Messages					
Character	Code	Character	Code	Character	Code
A	21	a	24	SPACE	12
B	22	b	25	;	17
C	23	c	26	/	18
D	31	d	34	“	19
E	32	e	35	.	27
F	33	f	36	,	28
G	41	g	44	:	29
H	42	h	45	1	01
I	43	i	46	2	02
J	51	j	54	3	03
K	52	k	55	4	04
L	53	l	56	5	05
M	61	m	64	6	06
N	62	n	65	7	07
O	63	o	66	8	08
P	71	p	74	9	09
Q	11	q	14	0	00
R	72	r	75		
S	73	s	76		
T	81	t	84		
U	82	u	85		
V	83	v	86		
W	91	w	94		
X	92	x	95		
Y	93	y	96		
Z	13	z	16		

10.7 Printing Station Message Detailed Accounting (SMDA) Reports

The system collects detailed call activity data for all stations and makes this available to you in various SMDA reports printed on the system's printer.

The *all records report* includes all stored records and is not sorted by any particular group as are the station, line, and account reports. This report is arranged in chronological order.

The *station report* shows all calls that the station user has made and received along with totals and averages. This report is sorted by station number.

The *line report* shows the number of calls, total minutes busy, number of incomplete calls, and cost for each line. The line report also summarizes line group activity as well.

The *account code report* shows the same information as the station report except that the records are based upon each account code.

As an alternative to requesting specific reports as you want them, you can request the system to generate *automatic reports*. The type of report and time of day the report is to be printed is programmed by the installer.

You can view the number of free records or you can delete all stored records to insure that only the latest records are being stored or to provide a known starting point for record storage.

Finally, as the system's memory reaches 95% of capacity, all reports are printed automatically.

- **To obtain the all records printout,**
 1. Press **INTERCOM**.
 2. Dial ***# 0 * 8 2**.
 3. Dial **1**.
 4. Dial **#** to start printout.

- **To obtain station reports with call information sorted by stations,**
 1. Press **INTERCOM**.
 2. Dial ***# 0 * 8 2**.
 3. Dial **2**.
 4. Enter station number,
—OR—
dial # for all stations.
 5. Dial # to start printout.

- **To obtain line reports with call information sorted by lines,**
 1. Press **INTERCOM**.
 2. Dial ***# 0 * 8 2**.
 3. Dial **3**.
 4. Enter line number,
—OR—
dial # for all lines.
 5. Dial # to start printout.

- **To obtain account reports with call information sorted by account numbers,**
 1. Press **INTERCOM**.
 2. Dial *** # 0 * 8 2**.
 3. Dial **4**.
 4. Enter account code,
—OR—
dial # for all accounts.
 5. Dial # to start printout.

- **To obtain a printout of the automatic report (if programmed) regardless of time and date set by installer),**
 1. Press **INTERCOM**.
 2. Dial ***# 0 * 8 2**.
 3. Dial **6**.
 4. Dial **#** to print automatic report.

- **To delete past records from system memory (if allowed by system programming),**
 1. Press **INTERCOM**.
 2. Dial *** # 0 * 8 2**.
 3. Dial **7**.
 4. Dial **#** to delete past records.

- **To view number of free records,**
 1. Press **INTERCOM**.
 2. Dial ***# 0 * 8 2**.
 3. Dial **8**.

- **To abort reports,**
 1. Press **INTERCOM**.
 2. Dial ***# 0 * 8 2**.
 3. Dial **9**.
 4. Dial **#** to abort reports.

10.8 Setting The Night Transfer Of Ringing Mode

You can enable an operating mode that automatically transfers all incoming calls to a particular telephone or group of telephones for answering.

- **To enable or disable the night transfer of ringing mode,**
 1. Press **INTERCOM**.
 2. Dial ***# 0 * 0 3**.
 3. Dial **1** to enable the feature,
—OR—
dial **2** to disable the feature.
 4. Press **SPEAKER** to end.

NOTE: Your system installer can program a button on your telephone that will enable or disable night transfer of ringing with one touch. If you have this button, the BLF light next to the button will flutter when night transfer of ringing mode is enabled.

10.9 Setting The System Clock

The system clock provides a date and time for display at LCD speakerphones connected to the system.

- **To program the system clock for current date and time,**
 1. Press **INTERCOM**.
 2. Dial ***# 0 * 0 1**.
 3. Dial two digits (**01-12**) for month.
 4. Dial two digits (**01-31**) for day.
 5. Dial two digits (**00-99**) for year.
 6. Dial two digits (**00-23**) for hour.
Example: 8:15 PM = 2015 (enter 20 for hour)
 7. Dial two digits (**00-59**) for minute.
Example: 8:15 PM = 2015 (enter 15 for minute)
 8. Dial **#** to save.
 9. Press **SPEAKER** to end.

10.10 Storing The System Speed Dial Numbers

You can store up to 500 system speed dial numbers at your attendant telephone. Typically, these are numbers that are frequently called by many different users and emergency numbers that you want readily available to everyone. Distribute a list of these stored numbers to the system users.

- **To program system speed dial numbers,**
 1. Record the following information on the system speed dial record sheet:
 - ✓ the dialing code of the storage location (**000-999**),
 - ✓ the line that will be used to access each outside number,
 - ✓ the telephone numbers you are storing.
 2. Press **INTERCOM**.
 3. Dial *** # 0 * 0 2**.
 4. Dial code for storage location (**000-999**).
 5. Dial code to make your speed dial route selection choice from the following list:

NOTE: *If the code for the desired line is less than three digits, dial # once after you dial the line code. (For example, dial 1# for line 1 or 19# for line 19.) dial 1#-99# to select lines 1-99*

dial **1#-99#** to select lines 1-99,
dial **100-128** to select lines 100-128,
dial **801-816** to select line groups 1-16,
dial **000** to select prime or last line used,
dial **888** to select intercom.
 6. Dial the number to be stored (up to 32 digits long—include * and # if needed).

NOTE: *You may need a pause between numbers to compensate for differences in response time between your system and the host system. To store a pause, press **HOLD**, then continue dialing. If your system is behind a host system that needs a hookflash to access a feature, press **TAP** to store a hookflash, then continue dialing.*
 7. Press **TRANSFER/CONFERENCE** to store number.

8. Dial next storage location, store line choice and speed dial number, and press **TRANSFER/CONFERENCE**.
9. Repeat previous step until all numbers are stored.
10. Press **SPEAKER** to end.

NOTE: On some earlier systems, the available system speed dial codes are *100-*299 and *100-*599.

System Speed Dial Record Sheet								
(Copy this sheet if you need more record space.)								
Loc	Line	Number	Loc	Line	Number	Loc	Line	Number

Download from Wwww.Somanuals.com. All Manuals Search And Download.

10.11 Transferring The Attendant Calls To The Alternate Attendant Telephone

The system installer can arrange for another telephone to serve as an alternate attendant location. You can transfer all calls that would ring at your telephone to this alternate attendant telephone whenever you wish to do so.

- **To choose an alternate attendant's station to receive your forwarded calls,**
 1. Press **INTERCOM**.
 2. Dial *** # 0 * 0 4**.
 3. Dial your station number, then press **#**.
 4. Dial the number of the alternate attendant station, then press **#**.
 5. Press **SPEAKER** to end.

- **To transfer calls that would normally ring at your station to the alternate attendant you've selected,**
 1. Press the installer-programmed **ALTERNATE** button. (Your LCD will display "Alternate" and the extension number of the alternate attendant.)

- **To return ringing of calls to your telephone,**
 1. Press the installer-programmed **ALTERNATE** button again.

10.12 Using The Overflow Transfer

By using this feature during peak calling periods, calls that normally ring at your station will also ring at the overflow station. If the installer has programmed the **OVERFLOW** feature access button, you can press this button to select overflow transfer. You can either change the overflow station selected by the installer, or if none was selected, you can enter your own selection from your station.

- **To set the overflow transfer feature,**
 1. Press the installer-programmed **OVERFLOW** button. If an overflow attendant is programmed, the light next to the **OVERFLOW** button will illuminate, and incoming calls will ring at both stations.
- **To designate an overflow station,**
 1. Press **INTERCOM**.
 2. Dial *** # 0 * 0 5**.
 4. Dial overflow station number:
 - dial **1001–1480** for stations 1–480.
- **To cancel the overflow transfer feature,**
 1. Press the **OVERFLOW** button again.

10.13 Using The Digital Voice Announce Option

The Digital Voice Announce (DVA) is an optional external device. It stores pre-recorded announcements and messages and plays them for incoming callers during their calls.

You must record the messages that the DVA plays to the callers in one of two ways: either by delivering them from the telephone handset at your attendant station or by playing the contents of a professionally-supplied tape recording into the DVA memory (see your system installer for tape recorder connection details).

There are 13 unique messages. The first five (plus day and night routing messages) are divided into four separate message types. The total message time is two minutes and you can divide this time as necessary among all the messages or use the entire two minutes for one message if needed.

Because of the time constraints, it is a good practice to script your messages ahead of time so that you can read them aloud in a clear and concise manner as you store them in the DVA memory.

As the number of calls increase, you can add more DVAs to handle the additional callers. You can then record the same message on several DVAs by entering the replicate value (see step 6 on the following page).

- To record a DVA message,
 1. Press **INTERCOM**.
 2. Dial * # 0 * 0 6.
 3. Dial **1**.
 4. Choose voice source,
 - dial **1** to speak message into handset,
 - dial **2** to play tape into music-on-hold jack,
 - dial **3** to play tape into background music jack.
 5. Dial **10-43** to choose message type (see Table Of Messages on pages 164 and 165 for message type list).

NOTE: As soon as you perform the next step, the two-minute timer starts running. Be ready to speak your message or press the PLAY button on the tape recorder as soon as you dial the replicate choice.

6. Dial **1-9** to choose number of times to replicate message.
7. Speak your message (or press the **PLAY** button on the tape recorder when you're using pre-recorded messages).
8. Press # to end message.
9. Listen as system automatically plays the message for verification at your attendant station.
10. Press # to stop verification playback.
11. Repeat procedure until you've recorded all messages,
 - dial **10-43** to choose next message type,
 - dial **1-9** to choose replicate quantity (timer starts),
 - speak your message (or press the **PLAY** button on the tape recorder),
 - press # to end message,
 - hear automatic playback of message.

- **To play a previously recorded DVA message,**
 1. Press **INTERCOM**.
 2. Dial *** # 0 * 06**.
 3. Dial **2**.
 4. Dial **10-43** to choose message type (see Table Of Messages on pages 10-28 and 10-29 for message type list).
 5. Listen as system automatically plays the message for verification at your attendant station.
 6. Press **#** to stop verification playback.
 7. Dial **10-43** to choose next message type to hear.
 - **To copy a previously recorded DVA message,**
 1. Press **INTERCOM**.
 2. Dial *** # 0 * 0 6**.
 3. Dial **3**.
 4. Dial **10-43** to choose message type (see Table Of Messages on pages 10-28 and 10-29 for message type list).
 5. Dial **1-9** to choose number of times to copy message.
 6. Dial **10-43** to choose next message number and type.
- NOTE: If your installer has connected more than two DVAs to the system, the system automatically selects the DVA that will receive the copied message. Likewise, the system automatically selects the DVA that it uses for playing back the message to a caller. Additional DVAs become a shared resource for the system's memory and are not dedicated to particular lines.***
- **To delete a previously recorded DVA message,**
 1. Press **INTERCOM**.
 2. Dial **# 0 0 6**.
 3. Dial **4**.
 4. Dial **10-43** to choose message type (see Table Of Messages on pages 10-28 and 10-29 for message type list)—system prompts for confirmation.

5. Dial **937** to confirm delete,
—OR—
dial * to deny delete.
 6. Dial **10-43** to choose next message type to delete.
- **To completely erase all DVA messages (format the DVA),**
 1. Press **INTERCOM**.
 2. Dial * # **0 * 0 6**.
 3. Dial **5**.
 4. Dial **1-192** to choose DVA port (your installer can identify the DVA ports for you if necessary).
 5. Dial **937** to confirm formatting,
—OR—
dial * to deny formatting.
 6. Dial **1-192** to choose next DVA port to format.

Table Of DVA Messages Record DVA messages (types 10 through 25) here. (Copy this sheet if you need more record space.)		
Number*	Message Type	Message
10	Welcome Greeting 1	
11	Welcome Greeting 2	
12	Welcome Greeting 3	
13	Welcome Greeting 4	
14	Day Main Menu 1	
15	Day Main Menu 2	
16	Day Main Menu 3	
17	Day Main Menu 4	
18	Night Main Menu 1	
19	Night Main Menu 2	
20	Night Main Menu 3	
21	Night Main Menu 4	
22	Recall No Answer 1	
23	Recall No Answer 2	
24	Recall No Answer 3	
25	Recall No Answer 4	

* The numbers in the first column index messages within the system. (For example, enter 12 to record Welcome Greeting 3.) The numbers 1 through 4, appearing as part of the message-type name, group similar types of messages together. (For example, if your company has several departments you might assign all group 1 messages to the sales department and all group 2 messages to the customer service department.)

Table Of DVA Messages Record DVA messages (types 26 through 43) here. (Copy this sheet if you need more record space.)		
Number*	Message Type	Message
26	Recall Busy 1	
27	Recall Busy 2	
28	Recall Busy 3	
29	Recall Busy 4	
30	Please Hold	
31	Password Prompt	
32	Account Code	
33	Dial Feature	
34	Day Routing 1	
35	Day Routing 2	
36	Day Routing 3	
37	Day Routing 4	
38	Night Routing 1	
39	Night Routing 2	
40	Night Routing 3	
41	Night Routing 4	
42	Reminder Prompt	
43	Digit Collection	

Note 1: Number 42, Reminder Prompt is used in DISA applications to prompt callers, who are making a line to line connection through the DXP, to dial a code. This allows the caller to continue the connection. See your system installer for details.

Note 2: Number 43, Digit Collection is used in computer telephony applications to prompt callers to enter a string of digits such as a social security number. These digits access a data base causing data about the caller to be displayed on the called party's computer screen. See your system installer for details.

10.14 Using The Special Attendant Buttons

In addition to the many feature buttons the system can make available to any station, the DXP provides the attendant position with several special-purpose feature buttons to enhance call processing. These special-purpose buttons are described below:

Alternate Button: When an attendant presses this button, all calls normally routed to his or her telephone are then routed to an alternate attendant's telephone instead. In some cases, your alternate attendant will be able to route all calls to a third alternate attendant.

Both Button: This button provides a means for an attendant to establish a conference between the attendant's station, a current call, and the last call that was placed on hold.

Overflow Button: When an attendant presses this button, calls that normally ring at the attendant's telephone also ring at an overflow attendant's station.

Queue Button: When multiple calls are ringing or are on hold at an attendant's station, the system places them in a queue. The attendant can use this button to determine how many calls are queued awaiting service.

Serial Call Button: When a caller wishes to speak to more than one person, the attendant uses this button to place the caller in a serial mode of multiple transfers to each desired party. In the serial mode the system automatically transfers the caller to another party as soon as a present party hangs up. The system places the caller in the serial mode as soon as the attendant hangs up.

Test/Busy Button: This button provides the attendant with a means to test the status of specific lines. Attendants can use this button to determine whether individual lines are idle, busy or on hold. When this button is used, the line is seized if it was idle.

- **To forward all calls to an alternate attendant,**
 1. Press the installer-programmed **ALTERNATE** button. If an alternate attendant is programmed, the light next to the **ALTERNATE** button will illuminate and the LCD will indicate the location of the alternate attendant.

- **To cancel the alternate mode,**
 1. Press the **ALTERNATE** button again.

- **To establish a conference between the attendant station, a held call, and an active call,**
 1. Press the installer-programmed **BOTH** button.

- **If you wish to cancel the conference condition and return one of the lines to hold,**
 1. Press **HOLD**.
 2. Press the line button for the held call you wish to re-engage. The other line remains on hold at your telephone.

- **To direct incoming calls to an overflow attendant during peak calling periods,**
 1. Press the installer-programmed **OVERFLOW** button. If an overflow attendant is programmed, the light next to the **OVERFLOW** button will illuminate, and incoming calls will ring at both stations.

- **To cancel,**
 1. Press the **OVERFLOW** button again.

- **To determine how many calls are queued at the attendant position and awaiting service (on hold, parked, or ringing),**
 1. Press the installer-programmed **QUEUE** button. The display will indicate how many calls are in the ring queue and the hold queue, respectively. The displayed information remains in the LCD window momentarily.

NOTE: *Hold recalls, transfer recalls and park recalls are counted in the ring queue and not the hold queue.*

- **To place an active call in a serial transfer,**
 1. Press the installer-programmed **SERIAL** button (the LCD will read “0 SERIAL EXT:”, with the first digit indicating how many intercom numbers are already entered; the “EXT:” indicates a prompt for another intercom number to be placed in the serial).
 2. Dial intercom number or press associated DSS button.
 3. Repeat to add up to two more extensions to the serial.
 4. Press **SPEAKER** to end. Serial transfer begins.

- **To determine the status of individual lines (idle, busy or on hold),**
 1. Press the installer-programmed **TEST/BUSY** button (the LCD will display the prompt *Enter Line:*).
 2. Dial the line number to be tested (001–128). If the line is idle, you will hear a dial tone; if the line is busy, the LCD will display *Busy with xxx* ; if the line is on hold, the LCD will display *On Hold at xxx* (xxx = line number).

10.15 Viewing The System Status Log

The system status log gives you information about the status of your system. Status log entries include: system reset, parity (port number), (port number) removed, manual reset, and software reset. Your installer must program a **SYSTEM STATUS** button on your telephone to provide you with access to the log display. The light located next to the button serves as the **SYSTEM STATUS** light. If the light turns on, it alerts you to enter the log viewing mode by pressing the **SYSTEM STATUS** button.

If your system includes T1 telephone line service, your telephone may display a T1 status log as well as the system status log. The T1 status log entries include those transmission errors that exceed their installer-programmed thresholds.

The installer may arrange for the system to sound an external audible alarm (or turn on an external visual alarm) if certain alarm conditions occur with the T1 service— it is the installer's choice whether the external alarm is audible or visual. If a T1 alarm occurs, you must take action to turn off the alarm device.

View the status logs by scrolling through them using the interactive buttons on your telephone. Although you can view a status log and turn off the T1 alarm, your installer must turn off your **SYSTEM STATUS** light. After viewing a log (and also turning off the external T1 alarm if necessary), inform the system administrator or installer that a system status or T1 alarm condition has occurred, and describe to him or her the displayed log details.

- **To view the log,**
 1. Press the **SYSTEM STATUS** button (the button flashes red when the log contains entries).
 2. Press the **SYSTEM** interactive button to display the most recent system status log entry,
—OR—
press **T1** interactive button to display the most recent T1 log entry.
 3. Press the **INFO** interactive button to display the time and date of the current entry.
 4. Press the **REV** interactive button to display the previous entry.
 5. Press the **FWD** interactive button to display the next (more recent) entry.
- **To display the number of entries in the log,**
 1. Press the **#** button at any time.
- **To exit the log viewing mode,**
 1. Either press the **SPEAKER** button, press the hookswitch, or wait for the 15-second timeout.
- **To turn off the external T1 alarm,**
 1. Press **INTERCOM**.
 2. Dial **# 0 9**.
 3. Press **SPEAKER** to end.

10.16 Operating Your Telephone With A DSS/BLF Console

The IB64X, IB48X, and IB24X DSS/BLF consoles have additional buttons and status lights that extend the memory button capability of an adjacent companion telephone. The buttons can be programmed for automatic dialing (speed dial) or direct station selection (DSS) with busy lamp field (BLF) using the instructions provided previously in this guide.

When the installer assigns a DSS/BLF console to a station port, the system recognizes it as such and automatically clears (blanks) the console buttons so that you can store numbers at the buttons as you need them.

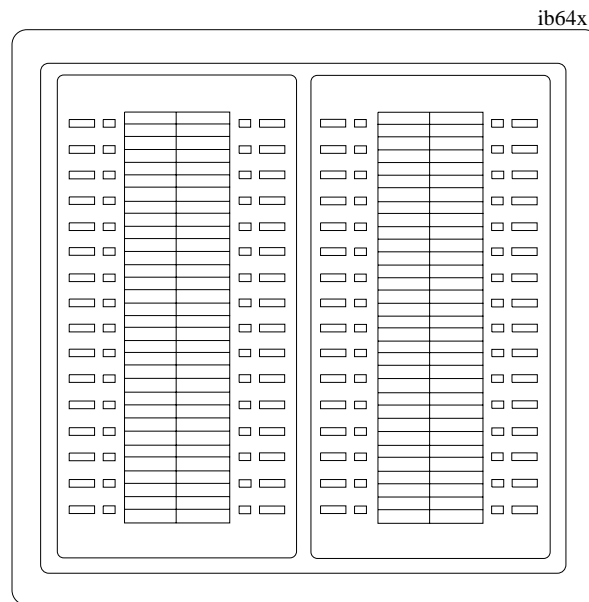

IB64X DSS/BLF Console

10.16.1 Accessing The Button Levels

The IB24X and IB48X DSS/BLF consoles have four levels of buttons, quadrupling the consoles' button capacity. The four buttons at the bottom of each console allow you to select which button level is currently active. To change button levels, press one of the buttons at the bottom of the console. The leftmost button activates level 1, the next button activates level 2, etc. A light beside the appropriate button lights to indicate which level is currently active.

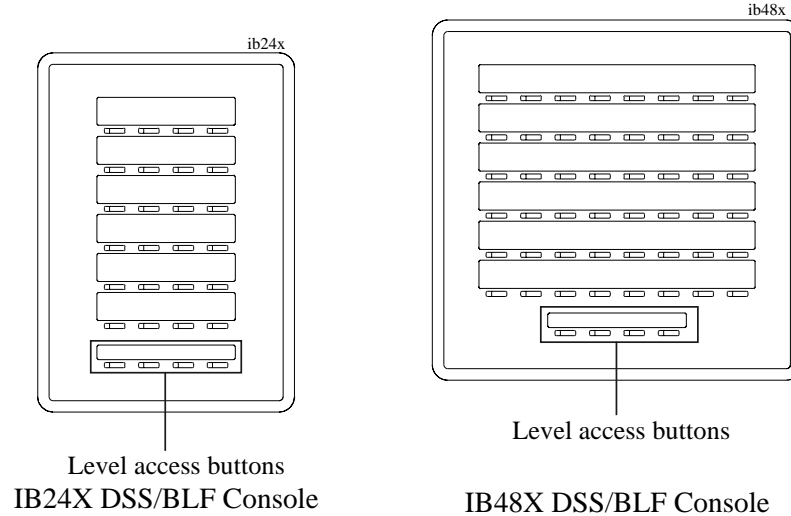

11

Troubleshooting Your Telephone

Symptom	Possible Cause
INTERCOM light flashing.	Your messaging is set. Press INTERCOM , then dial # 02 and hang up.
HOLD light flashing with no line on hold.	Another telephone has activated your message waiting light. Press INTERCOM and then press HOLD to retrieve message. This action will call party who activated light. Once you have received message, party who activated light (while still talking to you) must press INTERCOM to turn off the light.
MUTE light on.	MUTE is activated. To cancel, press MUTE .
SPEAKER light on steady.	Background music feature activated even though the system does not provide background music. To cancel, press INTERCOM then dial # 1 .
Error Tone (three steady tones)	May occur when incorrect buttons are pressed during speed dial programming. For example, if a button has a line assigned to it, or was not enabled for speed dial programming by the installer.
You can not receive a voice announce call.	Voice announce block has been activated. To cancel, press INTERCOM then dial # 2 .

This page remains blank intentionally.

Index

A	Section
Access Codes, Storing	9-8
Account Codes	7-4
Adjusting The Display Contrast	7-1
Adjusting The Telephone Pedestal	1-16
Answering Calls	2-1
Answering Calls At Monitored Stations	2-3
Answering Intercom Calls	2-2
Answering Night-Transferred Calls	2-4
Answering Outside Calls	2-1
Attendant Buttons, Using The Special	10-30
Attendant Features, Using The	10-1
Authorization Codes, Entering	7-5
Automatic Redial Feature	3-5 — 3-6
Automatic Set Relocation	7-29
Auxiliary Jack, Using The	7-20
B	
Blocking Voice-Announce Calls	7-1
Busy Button Inquiry	7-2
Busy Line And Station Status, Displaying	7-2
Button Functions, Displaying	7-3
Button Levels, Accessing On DSS/BLF Consoles	10-36
Button Query	7-3
C	
Call, Listening Over The	
Telephone Speaker (Group Listening)	7-7
Call, Making A Non-Private	7-8
Call, Overriding At Another Station	3-13
Call Pick-Up, Making A	2-5
Call Waiting	3-12
Caller ID Feature	7-31
Calls, Answering At Monitored Stations	2-3
Calls, Answering Intercom	2-2
Calls, Answering Night Transferred	2-4
Calls, Answering Outside	2-1
Calls, Blocking Voice Announce	7-1

Calls, Diverting To Another Station	7-3
Calls, Forwarding	7-6
Calls, Holding	4-1
Calls, Making	3-1
Calls, Making Intercom	3-10
Camping On At A Busy Station And Waiting For An Automatic Callback	3-11
Camping On At A Busy Station And Waiting For An Answer	3-12
Camping On At An Idle Station And Waiting For An Automatic Callback	3-12
Clock, Setting The System	10-19
Conferencing Calls	6-1
Conferencing Telephones Together	6-1
Contrast, Adjusting The Display	7-1
Creating LCD Messages	10-1

D

Dial By Name Feature	3-3
Dialing Automatically	3-2
Dialing Manually	3-1
Digital Voice Announce, Using The Option	10-24
Direct Inward System Access, Using	7-17
Disabling A Station	10-5
Disabling A Telephone Line	10-6
Display Abbreviations, Understanding The	1-8
Display Contrast, Adjusting The	7-1
Displaying Status Of Busy Lines And Stations	7-2
Displaying Button Functions (Button Query)	7-3
Diverting Incoming Calls To Another Station	7-3
Do Not Disturb Condition, Overriding A	3-13
Do Not Disturb Condition, Setting At Your Station	7-12
DSS/BLF Console Button Levels, Accessing	10-36
DSS/BLF Console, Operating With	10-35
DSS Numbers, Storing	9-4

E

Enabling Or Disabling Message Waiting	10-7
Entering Account Codes	7-4
Entering Authorization Codes	7-5

E and M Tie Lines, Using	7-24
F	
Feature Buttons, Storing The	9-5
Forwarding Calls	7-6
Full-Duplex Speakerphone, Using A	1-3
G	
Group Listening	7-7
H	
Handing Hold Recalls	4-4
Handling Park Recalls	4-6
Hold, Placing Calls On	4-1
Hold Recalls, Handling	4-4
Holding Calls	4-1
I	
IMIST Module	7-30
Intercom Calls, Answering	2-2
Intercom Calls, Making	3-10
Introducing The LCD Speakerphone	1-1
J	
Jack, Using The Auxiliary	7-20
K	
Knowing Your Speakerphone's Functions	1-12
L	
Last Number Redial	3-4
Lighting The Message Waiting Light	8-1
Lights, Understanding What They Mean	1-14
Line Groups, Using	3-8
Line Naming	10-12
Listening To A Call Over The Telephone Speaker	7-7
M	
Making a Subdued Off-Hook Voice Announcement	3-14
Making A Call Non-Private	7-8
Making A Call Pick-Up	2-5
Making A Hot Transfer	5-4
Making Calls	3-1

Making Intercom Calls	3-10
Message Waiting Light, Lighting The	8-1
Messages, Creating LCD	10-1
Messages, Sending And Receiving Non-Verbal Messages	8-1
Messages, Sending LCD	8-3
Messages, Sending Response	8-5
Monitoring A Conversation Between Two Telephones	7-9
Music, Using Background	7-16
Muting Your Telephone	7-10

N

Naming The System Telephones	10-8
Naming The Telephone Lines	10-12
Night Transfer Of Ringing Mode, Setting The	10-18
Night Transferred Calls, Answering	2-4

O

Outside Calls, Answering	2-1
Overriding A Call Or A Do Not Disturb Condition At Another Telephone	3-13

P

Paging, Sending A Announcement	7-10
Park Recalls, Handling	4-6
Parking Calls	4-5
Pedestal, Adjusting The Telephone	1-16
Personal Ring Tones, Setting Your	7-15
Placing Calls On Hold	4-1
Printing Station Message Detailed Accounting (SMDA) Reports	10-15
Privacy, Making A Call Non-Private	7-8
Privacy Release	7-8
Programming For Speed Dialing	9-1
Programming Your Telephone	9-1
Pulse And Tone, Switching The Dialing Mode	7-16

Q

Queuing	3-9
Quick Reference Guide	Quick Reference-1
Quick Transfer, Using	5-5

R

Redial Feature, Automatic 3-5 — 3-6

Redial Queue 3-5 — 3-6

Redialing A Previously Dialed Number. 3-4

Redialing A Saved Number 3-7

Redialing Last Dialed Number. 3-4

Relocation, Automatic Set 7-29

Reminder Alert, Setting A 9-9

Responding To A Subdued Off-Hook Voice Announcement. 2-6

Response Message Button, Storing The. 9-7

S

Saved Number Redial. 3-7

Sending A Paging Announcement 7-10

Sending And Receiving Non-Verbal Messages 8-1

Sending LCD Messages 8-3

Sending Response Messages 8-5

Service Observing 7-9

Set Relocation, Automatic 7-29

Setting A Do Not Disturb Condition At Your Station 7-12

Setting A Reminder Alert 9-9

Setting The Night Transfer Of Ringing Mode 10-18

Setting The System Clock 10-19

Setting The Volume Control 7-13

Setting Your Personal Ring Tones 7-15

Speakerphone, Introduction 1-1

Speakerphone User Guidelines 1-4

Speakerphone, Using Your 1-3

Speakerphone, Using A Full-Duplex 1-3

Speed Dial Numbers, Storing 9-3

Speed Dial Numbers, Storing The System. 10-20

Speed Dialing, Programming For. 9-1

Speakerphone's Functions, Knowing Your 1-12

Station Naming 10-8

Status Log, Viewing The System 10-33

Status Log, Viewing The T1 10-33

Storing Access Codes 9-8

Storing DSS Numbers 9-4

Storing Speed Dial Numbers 9-3

Storing The Feature Buttons. 9-5

Storing The Response Message Button 9-7
 Storing The System Speed Dial Numbers 10-20
 Switching The Dialing Mode Between Pulse And Tone 7-16
 System Status Log, Viewing The 10-33
 Subdued Off-Hook Voice Announcement, Making A 3-14
 Subdued Off-Hook Voice Announcement, Responding To 2-6
 Switching The Dialing Mode Between Pulse And Tone 7-16

T

T1 Status Log, Viewing The 10-33
 Telephone Line, Disabling A 10-6
 Telephone Pedestal, Adjusting 1-16
 Tracker Paging System, Using The 7-22
 Transfer, Making A Hot 5-3
 Transferring Calls 5-1
 Transferring Calls—Screened 5-1
 Transferring Calls—Unscreened 5-3
 Transferring The Attendant Calls To The
 Alternate Attendant Telephone. 10-22
 Transferring Calls Using Quick Transfer 5-5
 Troubleshooting Your Telephone 11-1

U

Understanding The Display Abbreviations 1-8
 Understanding What The Lights Mean 1-14
 Using A Full-Duplex Speakerphone 1-3
 Using Background Music. 7-16
 Using Direct Inward System Access 7-19
 Using E and M Tie Lines 7-24
 Using Line Groups 3-8
 Using Quick Transfer 5-5
 Using The Attendant Features 10-1
 Using The Auxiliary Jack. 7-20
 Using The Digital Voice Announce Option 10-24
 Using The Feature Buttons. 9-5
 Using The IMIST Module 7-30
 Using The Other Telephone Features. 7-1
 Using The Overflow Transfer. 10-12
 Using The Special Attendant Buttons 10-30
 Using The Tracker Paging System. 7-22

Using This Guide 1-1
Using Your Speakerphone 1-3

V

Viewing The System Status Log 10-33
Viewing The T1 status Log 10-33
Voice Announce Calls, Blocking 7-1
Volume Control, Setting The 7-13

W

Waiting For A Line 3-9

This page remains blank intentionally.



Appendix A

Quick Reference Guide

This chart provides you with a Quick Reference Guide of the feature dialing codes. If you wish, you can detach these pages and keep them near your telephone to serve as a stand alone reference. Chapter 8, *Programming Your Telephone*, describes a method to program these codes on your telephone at unused programmable buttons. Also, the installer may store features at your telephone buttons and label the buttons with the feature's mnemonics.

Feature	Enable Code	Disable Code	Button Mnemonic
Account Code	INTERCOM * 04 + account code		ACCT
All Call	INTERCOM 70		PAGE 1
Attendant Calling	INTERCOM 0		
Authorization Code	INTERCOM # 08 + authorization code		AUTH
Automatic Callback and Call Waiting	INTERCOM * 6	INTERCOM # 6	CAMP
Automatic Redialing			ARD
Background Music	INTERCOM * 11 or 12	INTERCOM # 1	MUSIC 1 MUSIC 2
Call Divert Station	INTERCOM * 55 + extension number		
Call Forward, Personal	INTERCOM * 51 + extension number	INTERCOM # 5	FWD-P
Call Forward, All Calls	INTERCOM * 52 + extension number	INTERCOM # 5	FWD-A

Feature	Enable Code	Disable Code	Button Mnemonic
Call Forward, Ring-No Answer, All Calls	INTERCOM * 54 + extension number	INTERCOM # 5	FWDRA
Call Forward, Ring-No Answer, Personal Calls	INTERCOM * 53 + extension number	INTERCOM # 5	FWDRP
Call Park, Orbit 91-99	INTERCOM * (91-99)		PARK 1-9
Call Park, Pickup	INTERCOM # 91-99		PARK 1-9
Call Pickup, Directed	INTERCOM * 4 + extension number		DPKUP
Call Pickup, Group	INTERCOM # 4		GPKUP
Clear Major Alarm Ring	INTERCOM # 09		
DISA Access	Installer Assigned		
Do Not Disturb	INTERCOM # 01		DND
Do Not Disturb Override	extension number + * 03		EXOVR
DSS Programming	INTERCOM ** 3		
Executive Override	extension number + * 03		EXOVR
Hold, Manual	HOLD		HOLD
Hold, Exclusive	HOLD + HOLD		HOLD
Hold, Directed	INTERCOM * 90		
Hold, Directed Pickup	INTERCOM # 90		
LCD Messaging	INTERCOM * 02 + message	INTERCOM # 02	LCDMS

Feature	Enable Code	Disable Code	Button Mnemonic
Line Group 1	INTERCOM 9		LNG01
Line Groups 2-11	INTERCOM 80-89		LNG02-11
Line Groups 12-16	INTERCOM 60-64		LNG 12-16
Line Pick Up From Any Station, Zones 1-4	INTERCOM 65-68		TAFS 1-4
Line Pick Up From Any Station, All Zones	INTERCOM 69		TAFS*
Meet-Me Answer Page	INTERCOM 78		MMEPG
Message Waiting	INTERCOM * 3 + extension number	INTERCOM * 3 + extension number	
Message Wait Retrieval	#00		
Night Transfer (Attendant Only)	INTERCOM * # 0* 0 3 1	INTERCOM * # 0* 0 3 1	NIGHT
Operator Access	INTERCOM 0		
Paging, All Call	INTERCOM 70		PAGE 1
Paging, Zones 2-8	INTERCOM 71-77		PAGE 2-8
Paging, Meet-Me	INTERCOM 78		MMEPG
Park Orbit Retrieve	INTERCOM #91-99		PARK 1-9
Park Orbit Send	INTERCOM *91-*99		PARK 1-9

Feature	Enable Code	Disable Code	Button Mnemonic
Personal Ringing Tones	INTERCOM ** 4 + tone code (1-8)		
Redial Last Dialed Number	#		
Remote Station Disable	INTERCOM * 05 + extension number	INTERCOM * 05 + extension number	
Response Message	INTERCOM ** 6 + button + 01-30		RSPnn (nn = 1-30, S)
Service Observing	INTERCOM # 03 + extension number		S-OBS
Speed Dial, Station	1-0		
Speed Dial, System	* 100 * 599		
Speed Dial, Programming	INTERCOM ** 1		
Station Lock	INTERCOM #04 + code		LOCK
Volume Save	INTERCOM ** 7		VOLSV
Voice-Announce Block	INTERCOM * 2	INTERCOM # 2	VABLK

NOTE: *The dialing codes provided in this quick reference guide are default values. Your system installer has the ability to renumber these codes.*

The following table details several unique dialing codes that are only applicable to single line proprietary and industry-standard telephones.

Feature	Enable Code
Pick Up Last Line	* 08
Broker's Call	* 07
Speed Dial Access Code	* 01
Saved Number Redial	* 06
Dial Saved Number	* 09
TAP Dialing Code	# #

NOTES

NOTES

NOTES

This manual has been developed by Comdial Corporation (the “Company”) and is intended for the use of its customers and service personnel. The information in this manual is subject to change without notice. While every effort has been made to eliminate errors, the Company disclaims liability for any difficulties arising from the interpretation of the information contained herein.

The information contained herein does not purport to cover all details or variations in equipment or to provide for every possible contingency to be met in connection with installation, operation, or maintenance. Should further information be desired, or should particular problems arise which are not covered sufficiently for the purchaser’s purposes, contact Comdial, Inside Sales Department, P.O. Box 7266, Charlottesville, Virginia 22906.



Printed in U.S.A.

GCA70-250.05
8/97

Free Manuals Download Website

<http://myh66.com>

<http://usermanuals.us>

<http://www.somanuals.com>

<http://www.4manuals.cc>

<http://www.manual-lib.com>

<http://www.404manual.com>

<http://www.luxmanual.com>

<http://aubethermostatmanual.com>

Golf course search by state

<http://golfingnear.com>

Email search by domain

<http://emailbydomain.com>

Auto manuals search

<http://auto.somanuals.com>

TV manuals search

<http://tv.somanuals.com>