

# COMDIAL®

DXP, DXP *Plus*, and FX Series  
Digital Communications Systems

*Impact* • *Impact*  
SCS

LCD Speakerphone  
Station User's Guide

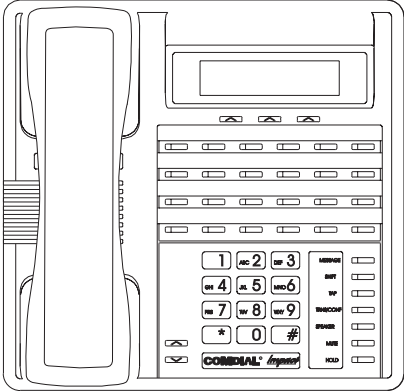
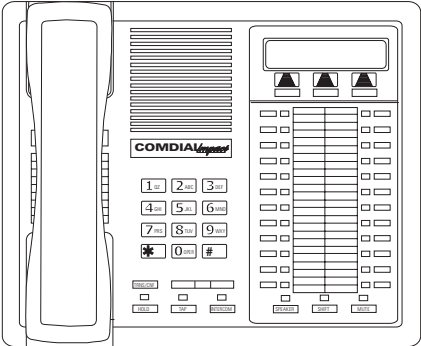

This user's applies to the following system and telephone models:

**System Models:**

- DXP systems with software 12A and later.
- DXP Plus systems with software 12A and later.
- FX Series with software 12A and later.

**Telephone Models:**

- Impact 8024S-\*\* Rev. A and later.
- Impact 8012S-\*\* Rev. A and later.
- Impact SCS 8324S-\*\* Rev. A and later.
- Impact SCS 8312S-\*\* Rev. A and later.
- Impact SCS 8324F-\*\* Rev. A and later.

If you need more information, consult GCA70–250, *LCD Speakerphone Reference Manual*.

Contact your Comdial dealer for updates of this as well as other Comdial publications.



\*Tri-level Compression is a registered trademark of ACS Wireless, Inc.

*Comdial's Quality Management System Is Certified To The ISO 9001 Standard.*

Comdial® strives to design the features in our communications systems to be fully interactive with one another. However, this is not always possible, as the combinations of accessories and features are too varied and extensive to insure total feature compatibility. Accordingly, some features identified in this publication will not operate if some other feature is activated.

Comdial® disclaims all liability relating to feature non-compatibility or associated in any way with problems which may be encountered by incompatible features. Notwithstanding anything contained in this publication to the contrary, Comdial® makes no representation herein as to the compatibility of features.

2/12/97

**Contents**

<b>1</b>	<b>Introducing The Telephone</b> .....	<b>1-1</b>
1.1	Understanding What The Lights Mean.....	1-1
1.2	Using The LCD Abbreviations .....	1-3
1.3	Using Your Speakerphone.....	1-7
1.4	Adjusting The Telephone Pedestal .....	1-12
<b>2</b>	<b>Answering Calls</b> .....	<b>2-1</b>
2.1	Answering Calls .....	2-1
2.2	Answering A Subdued Off- Hook Voice Announcement (SOHVA) .....	2-2
<b>3</b>	<b>Making Calls</b> .....	<b>3-1</b>
3.1	Making A Call.....	3-1
3.2	Accessing Lines .....	3-1
3.3	Using Last Number Redial .....	3-3
3.4	Using Speed Dial.....	3-6
3.5	Using Dial By Name.....	3-7
3.6	Making A Subdued Off- Hook Voice Announcement (SOHVA) .....	3-8
3.7	Making A Paging Announcement.....	3-9
3.8	Camping On At A Busy Station And Waiting For An Answer (Call Waiting).....	3-10
3.9	Camping On At An Idle Station And Waiting For An Automatic Callback.....	3-11
3.10	Camping On At A Busy Station And Waiting For An Automatic Callback.....	3-12
<b>4</b>	<b>Placing Calls On Hold</b> .....	<b>4-1</b>
4.1	Holding Calls.....	4-1
4.2	Using Call Park .....	4-3
<b>5</b>	<b>Sending And Receiving Non-Verbal Messages</b> .....	<b>5-1</b>
5.1	Using The Messaging Feature .....	5-1
5.2	Using LCD Messaging .....	5-2
5.3	Sending An LCD Message .....	5-3

<b>6</b>	<b>Transferring Calls</b> .....	<b>6-1</b>
6.1	Transferring Outside Calls .....	6-1
<b>7</b>	<b>Conferencing Calls</b> .....	<b>7-1</b>
7.1	Conferencing Stations Together .....	7-1
<b>8</b>	<b>Programming Your Telephone</b> .....	<b>8-1</b>
8.1	Storing DSS Numbers .....	8-1
8.2	Storing Feature Buttons .....	8-2
8.3	Storing A Response Message Button .....	8-2
8.4	Programming Speed Dial Numbers .....	8-3
8.5	Setting A Reminder Alert .....	8-5
<b>9</b>	<b>Using The Other Telephone Features</b> .....	<b>9-1</b>
9.1	Adjusting The Display Contrast .....	9-1
9.2	Blocking Voice-Announce Calls .....	9-1
9.3	Displaying Status Of Busy Lines And Stations (Busy Button Inquiry) .....	9-2
9.4	Displaying Button Functions (Button Query) .....	9-2
9.5	Diverting Incoming Calls To Another Station .....	9-3
9.6	Listening To A Call Over The Telephone Speaker (Group Listening) .....	9-3
9.7	Muting Your Telephone .....	9-4
9.8	Setting A Do Not Disturb Condition .....	9-4
9.9	Overriding A Call Or A Do Not Disturb Condition At Another Telephone (Executive Override) ..	9-5
9.10	Setting The Volume Control .....	9-6
9.11	Setting Your Personal Ringing Tones .....	9-9
9.12	Using Background Music .....	9-9
9.13	Using The IMIST Module .....	9-10
9.14	Using The Caller ID Feature .....	9-11

**10 Operating Your Telephone With A DSS/BLF Console**  
    10.1 Operating Your Telephone With A DSS/BLF Console . . 10-1

**Publication Index . . . . . Index-1**

**Quick Reference Guide . . . . . Quick Reference-1**

*This page remains blank intentionally.*

# 1

## Introducing The Telephone

Congratulations and thank you for using a Comdial telephone! This manual serves as a helpful guide for using your new telephone's many functions. If you should need more information about a particular function or on a function not listed in this guide, consult the LCD Speakerphone Reference Manual, GCA70–250 (your system attendant should have several copies).

### 1.1 Understanding What The Lights Mean

The lights on your telephone indicate the status of lines, features, and intercom.

— **Next to a Direct Station Select (DSS)/Busy Lamp Field (BLF) button:**

- **Steady red = station is in use.**
- **Flashing red = station is receiving a call.**
- **Winking red = message-waiting light set for you by station associated with that DSS button.**

— **Next to a line button:**

- **Steady green = line is in use at your station.**
- **Steady red = line is in use at another station.**
- **Flashing red = your line is ringing.**
- **Flashing orange = your line is ringing and will be answered when you lift the handset.**
- **Winking green = line is on hold at your station.**
- **Winking red = line is on hold at another station.**
- **Fluttering orange = line has recalled from hold at your station.**
- **Fluttering red = line has recalled from hold at another station.**

- Next to a fixed feature or programmable feature button:
  - Steady red = the feature is on.
  - Steady off = the feature is off.
  
- Next to an INTERCOM button:
  - Steady green with a quick flash = you are using your intercom.
  - Winking red = an LCD message is set on your telephone for others to receive when calling.
  - Flashing orange = another station is calling you.
  
- Above the HOLD button:
  - Fluttering red = message awaits pick up.
  - Winking green = a line is on hold at your station.
  
- Above the SPEAKER button:
  - On steady (with telephone on hook and busy) = speakerphone mode is active.
  - On steady (with telephone on hook and idle) = background music is active.
  - Flashing = feature viewing and programming is in progress.
  
- Above the MUTE button:
  - On steady = called party cannot hear your conversation.
  
- Above the SHIFT button:
  - On steady = shift mode is activated to allow access to second level speed dial numbers programmed at DSS button locations.



## **1.2 Using The LCD Abbreviations**

The following chart identifies the abbreviations on your LCD screen and provides a brief definition of each feature.

<b>Abbreviation</b>	<b>Feature</b>	<b>Definition</b>
<b>ACCT</b>	Account	Stores a button that enables account code entry.
<b>ALERT</b>	Set Reminder	Sets two reminder alerts that will sound at your station at specified times.
<b>ALL</b>	All Calls Forward	Routes all of your calls to a different station location.
<b>ANS</b>	Answer	Answers a call ringing at your station.
<b>APAGE*</b>	Auxiliary Pager	Stores a button that selects auxiliary paging speaker operation through the auxiliary jack.
<b>ARECD*</b>	Auxiliary Recorder	Stores a button that selects auxiliary recorder operation through the auxiliary jack.
<b>ARING*</b>	Auxiliary Ringer	Stores a button that selects auxiliary ringer operation through the auxiliary jack.
<b>ARDL</b>	Automatic Redial	Redials a busy call once a minute for 10 minutes.
<b>BKSP</b>	Backspace	While programming a speed dial number, backspace erases an incorrect entry.
<b>CALL</b>	Call	Calls a station that turned on your message waiting light.
<b>CFWD</b>	Call Forward	Forward all of your calls to a different station location. When chosen as a feature, stores a button that enables the function.

Abbreviation	Feature	Definition
<b>CAMP</b>	Camp On	Has system call you when busy station becomes idle. When chosen as a feature, stores a button that enables the function.
<b>CALLBK</b>	I Will Call Back	Respond to a SOHVA call with a non-verbal message.
<b>CLEAR</b>	Clear Features	Stores a button that clears a currently active or engaged feature.
<b>CLR</b>	Clear	Cancel a call forward condition.
<b>CONF</b>	Conference	Establishes a conference.
<b>DARK</b>	Dark (contrast)	Makes LCD screen darker.
<b>DISP</b>	Display	Adjusts the contrast of your LCD screen.
<b>DND</b>	Do Not Disturb	Makes your station appear busy to other stations. When chosen as a feature, stores a button that enables the function.
<b>DSS</b>	Direct Station Select	Store a personal intercom number at a DSS station.
<b>EXIT</b>	Exit Selection	Ends a current programming session.
<b>FEAT</b>	Feature	Presents several different features you can store at programmable buttons for later use.
<b>GPLSN</b>	Group Listen	When chosen as a feature, stores a button that enables loud speaker broadcast of distant party's voice.
<b>HDSET</b>	Headset	When chosen as a feature, stores a button that enables headset operation.

Abbreviation	Feature	Definition
<b>HAVE HOLD</b>	Ask Caller To Hold	Send a non-verbal response to a SOHVA caller so he or she will know to place the outside caller on hold.
<b>LIGHT</b>	Light (contrast)	Makes the LCD screen lighter.
<b>MSG</b>	Message	Turns on message-waiting light at another station.
<b>MUSIC</b>	Background Music	Turns on the background music at your station. When chosen as a feature, stores a button that enables the function.
<b>NEXT</b>	Next Display	Shows the next display.
<b>NoANS</b>	No Answer / Forward	Forwards calls that ring at your station but receive no answer.
<b>OPTIONS</b>	Options	Selects interactive button features.
<b>OVER</b>	Override	Overrides either a do-not-disturb condition or a busy condition at a station you have called.
<b>PAGE</b>	Paging Zone	When chosen as a feature, stores a button that provides one-button access to paging.
<b>PARK</b>	Park Orbit	When chosen as a feature, stores a button that one-button parking of calls.
<b>PCKUP</b>	Pickup	When chosen as a feature, stores a button that releases privacy for a current call.
<b>PERS</b>	Personal	Routes your personal intercom calls to a different station location.

Abbreviation	Feature	Definition
<b>PRIV</b>	Privacy	When chosen as a feature, stores a button that releases privacy for a current call.
<b>QUERY</b>	Button Query	Displays program status of any button.
<b>RECON</b>	Reconnect	Reconnects you to a transferred call.
<b>RING</b>	Ring Tone	Select different ringing tones.
<b>SAVE</b>	Save Number	Permanently saves last number you dialed. When chosen as a feature, stores a button that provides the function.
<b>SDIAL</b>	Speed Dial	Programs a number for one-button calling.
<b>SEND</b>	Send Transfer	Re-transfers a previously transferred call that returned to your station.
<b>SET</b>	Set Feature	Enable call forwarding.
<b>SOHVA</b>	Subdued Off-Hook Voice Announce	Sends a subdued off-hook voice announcement to another station.
<b>SRC</b>	Music Source	Selects which music source will supply background music.
<b>TAKE MSG</b>	Take A Message	Send a non-verbal response to a SOHVA caller so her or she will know to take a message from an outside party.

*\*Available only on 8024S-\*\*.\**

## **1.3 Using Your Speakerphone**

When using your speakerphone, the microphone and loudspeaker are farther away from you than when you use a handset. Both the signal from the loudspeaker and the signal to the microphone must be strengthened. When microphones and loudspeakers are close together (such as in a speakerphone), additional amplification typically generates a ringing sound (public address systems do this if the volume is too high or the microphone is too close to a loudspeaker).

***NOTE: The 8324F-\*\* speakerphone can function in the full-duplex or half-duplex mode. Both sets of guidelines (section 1.3.1 and section 1.3.2) are applicable to the 8324F-\*\*. The 8012S-\*\*, 8024S-\*\*, 8324S-\*\*, and 8312S-\*\* speakerphones only function in the half-duplex mode—only section 1.3.2, Speakerphone User Guidelines, apply to these telephones.***

### **1.3.1 Using A Full-Duplex Speakerphone**

The *Impact SCS* 8324F-\*\* speakerphone uses the latest full-duplex speakerphone technology. (Full-duplex technology enables both parties on a speakerphone call to speak simultaneously—half duplex speakerphones allow only one person to speak at a time.) The 8324F-\*\* will operate in either full-duplex or half-duplex mode depending on the current line conditions. For example, satellite calls or calls with a delay involved may prevent the telephone from operating in full-duplex mode.

At the beginning of each call, the telephone must perform a “speech training” test. To achieve optimum performance from the full-duplex speakerphone, Comdial recommends that each user in turn speak about 10 consecutive words to allow the telephone to “train” itself. Note that during the “speech training” test, the speakerphone is operating in half-duplex mode.

Depending on the telephone line conditions and the type of speakerphone at the other end, it may not be possible for the 8324F-\*\* to operate in full-duplex mode. If the speakerphone at the other end is a half-duplex speakerphone and both parties are in speakerphone mode, the half-duplex speakerphone is the controlling factor, preventing the 8324F-\*\* from operating in full-duplex mode.

***NOTE: Pressing any button (mute, hold, etc.) on the speakerphone while in full-duplex mode causes the system to perform the “speech training” test again. For example, if you press MUTE while in full-duplex mode, when you release the call from mute, the system will perform the entire “speech training” test again.***

### **1.3.2 Speakerphone User Guidelines**

***NOTE: The speakerphone user guidelines in this section do not apply to the Impact SCS 8324F-\*\* when it is operating in full-duplex mode. However, when the 8324F-\*\* is in half-duplex mode or in “speech training” mode, the following guideline are applicable.***

- Both parties cannot talk at the same time. You must wait for silence out of your loudspeaker before talking. You must stop talking to hear the other party.
- Background noise may prevent the sound-activated switches from operating properly. Avoid placing the speakerphone where it will detect sounds from typewriters, keyboards, printers, paging systems, and other equipment.
- Speak slightly louder than normal and with a clear, authoritative voice. For the microphone to best detect your voice, speak within three feet of it and face the telephone.
- Raising the volume of the loudspeaker makes it easier for the sound-activated switches in your telephone to select the distant party’s voice. Lowering the volume of the loudspeaker makes it easier for the switches to select your voice.
- Since the system takes several seconds to provide the best switching, constant sound patterns—such as elongating your words and playing externally-supplied music—may prevent the sound-activated switches from operating properly.
- Place the telephone on a hard surface and away from table edges. Do not place the telephone in corners or enclosures. Do not let obstructions come between you and the microphone. Rooms with hard, flat surfaces that reflect sound may affect the sound-activated switches.
- If you are using a handset and the other party is using a speakerphone, avoid breathing heavily into your microphone. Avoid other sounds that may affect the distant telephone’s sound-activated switches.
- In some situations, such as when either you or the distant party are in a noisy environment, you may have to lift your handset to ensure a clear conversation.
- When both you and the distant party use speakerphones, the sound-activated switches can occasionally detect both voices simultaneously, thus blocking out both voices.

- **To manually place a call using your speakerphone,**
  1. Press the **INTERCOM** or line button.
  2. Dial the number.
  3. When party answers, speak toward the telephone.
  
- **To automatically dial a number using your speakerphone,**
  1. Press the preprogrammed speed dial or DSS button and speak toward the telephone when your party answers.
  
- **To answer a call with your speakerphone,**
  1. Press the **INTERCOM** or line button with flashing red or orange light.
  2. Speak toward the telephone to answer the call.
  3. To end a call with your speakerphone, just press **SPEAKER**.

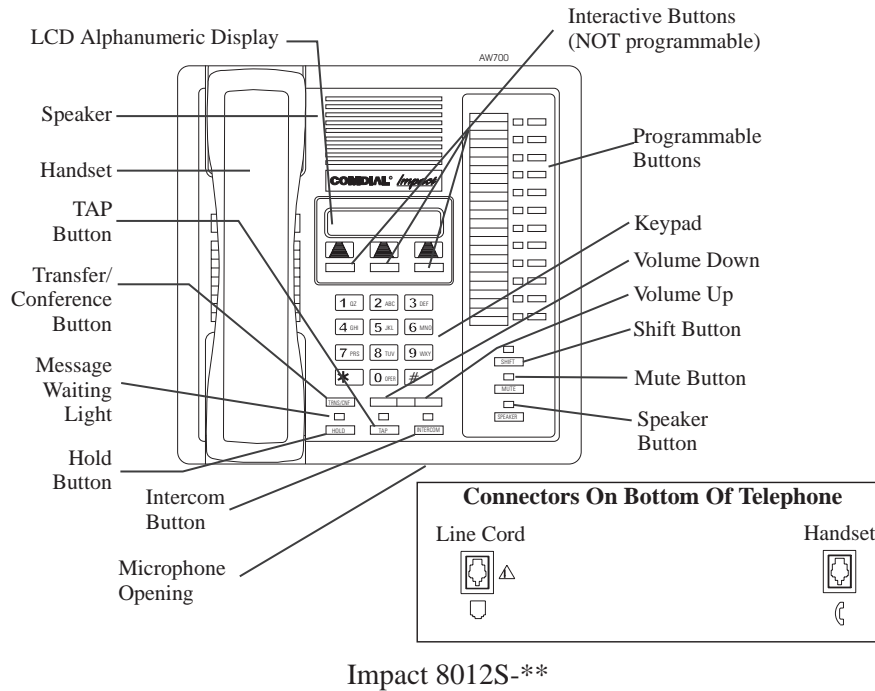
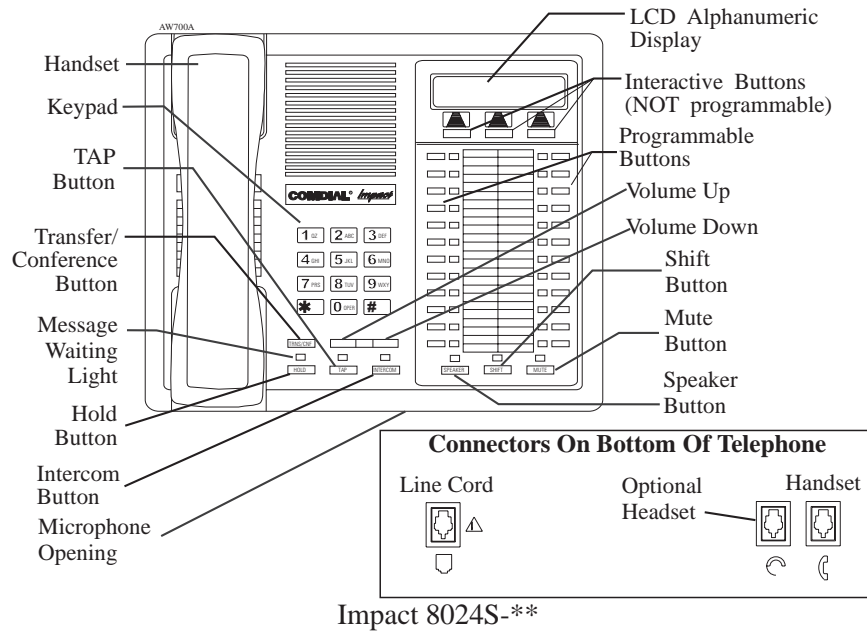

1 - 10 LCD Speakerphone Station User's Guide



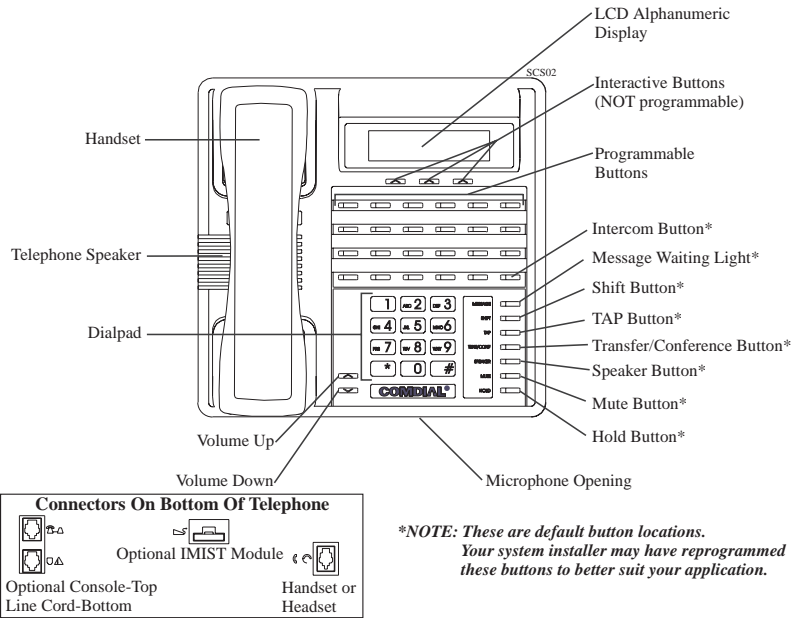

Impact SCS 8342F-XX

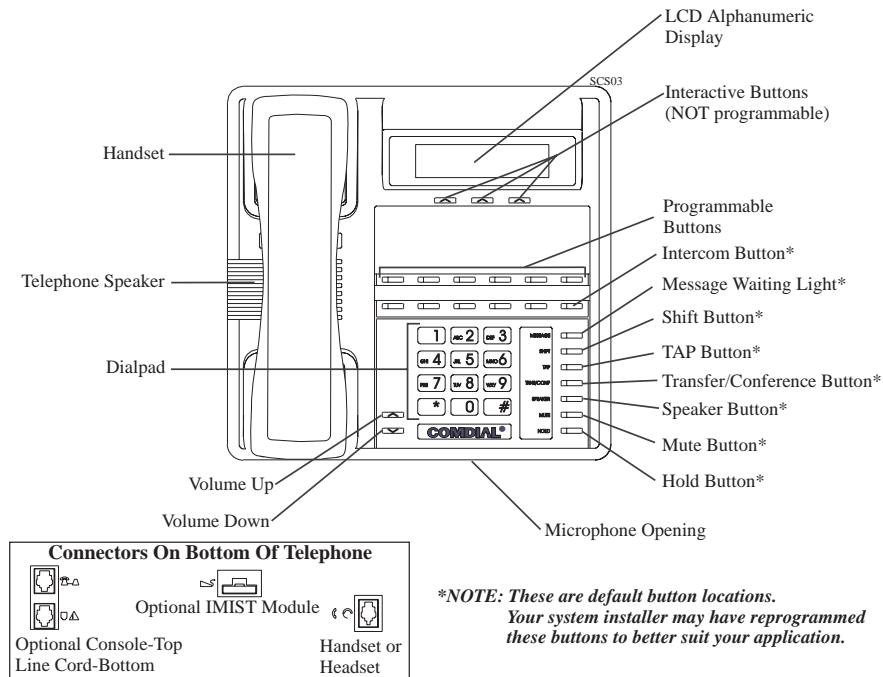

Impact SCS 8312S-\*\*

## 1.4 Adjusting The Telephone Pedestal (Models 8312S, 8324S, and 8324F only)

Your telephone has an adjustable pedestal to allow you to select the most comfortable viewing angle. When you receive the telephone, the pedestal is in its lowest position—flush against the pedestal.

- **To adjust the pedestal,**

1. Grasp the rear of the pedestal base firmly with one hand while lifting the rear portion of the telephone upward with your other hand
2. While pivoting the telephone upward with one hand, pivot the telephone supporting arms upward with your other hand while feeling for the notches under the telephone. Notice there are three sets of notches under the telephone corresponding to the three positions available.
3. When the telephone is at the desired height, find the closest pair of notches and place the supporting arms in the notches. Press down slightly on the telephone until you feel the supporting arms snap into place.

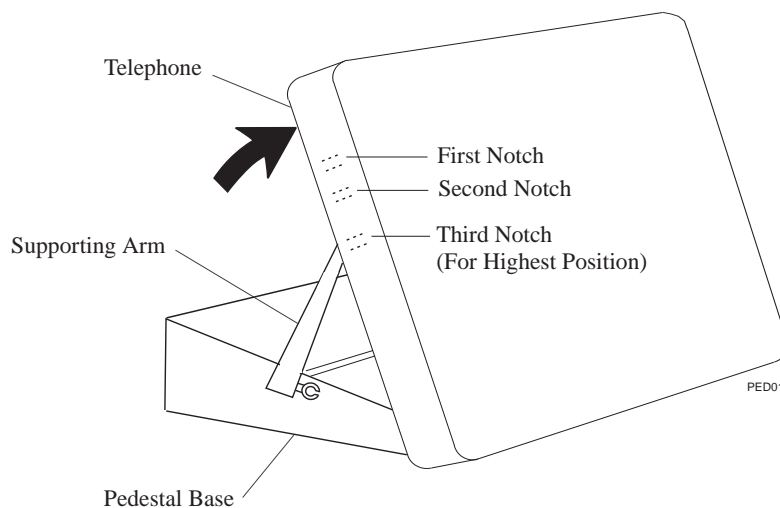

# 2

## Answering Calls

**NOTE:** *Throughout this book, all references to fixed buttons are printed in upper case bold type, for example “Press the INTERCOM button.” All references to interactive buttons are printed in upper case bold italic type, for example “Press the OPTIONS button.”*

### 2.1 Answering Calls

- **To answer a call ringing at your telephone,**
  1. If the light is flashing orange, lift handset,  
—OR—  
if the light is red, press the flashing line button and lift handset.
- **To answer a call using the speakerphone,**
  1. Press flashing line or **INTERCOM** button.
- **To answer a call that is ringing at any telephone,**
  1. Lift handset.
  2. Press **INTERCOM** and dial \*4 plus extension number of ringing telephone.
- **To answer a call that is ringing at a particular telephone in your group,**
  1. Hear ringing.
  2. Press **INTERCOM** and dial #4 (ringing station must be programmed in your call pickup group).
  3. Speak toward telephone to answer call. Lift handset if you desire privacy.

- **To answer a call that is ringing the loud ringer or night transfer station,**
  1. Hear ringing.
  2. Lift handset.
  3. Press **INTERCOM**.
  4. Dial **65** through **68** to select ringing zone (1-4) where the bell is located, or dial **69** to answer any ringing zone.

*NOTE: This feature is known as Trunk Access From Any Station (TAFAS).*

## **2.2 Answering A Subdued Off-Hook Voice Announcement (SOHVA)**

---

The installer may arrange your telephone to receive a subdued off-hook voice announcement (SOHVA). If so, an intercom caller may mix into your outside call and deliver a message to your telephone receiver for you to hear.

- **To respond verbally,**
  1. Press and hold **REPLY**.
  2. Speak into handset.
- **To respond non-verbally,**
  1. Press **MSG**.
  2. Press **HAVE HOLD, TAKE MSG** (Take Message), or **CALL BACK** depending on which message you want to leave.

*NOTE: Announcing station must have LCD speakerphone.*

- **To block a SOHVA,**
  1. Press **BLOCK** when calling party initiates SOHVA.

## **2.3 Forwarding Calls**

- **To forward calls made to your station,**
  1. Press **OPTIONS**.
  2. Press **NEXT** until the **CFWD** option appears.
  3. Press **CFWD**.
  4. Press **SET**.
  5. Press **PERS** to forward prime line and intercom calls,  
—OR—  
press **ALL** to forward all calls,  
—OR—  
press **NO ANS** to forward calls that ring at your station but receive no answer after a preprogrammed number of rings (then press **PERS** to forward your prime line and intercom calls or press **ALL** to forward all calls that ring with no answer at your telephone).
  
- **To forward calls that ring at your station but receive no answer,**
  1. Press **OPTIONS**.
  2. Press **NEXT** until the **CFWD** option appears.
  3. Press **CFWD**.
  4. Press **SET**.
  5. Press **NO ANS**.
  6. Press **PERS** to forward your prime line and intercom calls or press **ALL** to forward all calls that ring with no answer at your telephone (your system installer has already programmed how many times your telephone will ring before calls are forwarded).
  7. Press **SPEAKER** to end.

- **To cancel call forwarding,**
  1. Press ***OPTIONS***.
  2. Press ***NEXT*** until the ***CFWD*** option appears.
  3. Press ***CFWD***.
  4. Press ***CLR*** to disable call forwarding.
  5. Press ***SPEAKER*** to end.

**3****Making Calls****3.1 Making A Call**

- **To make a call,**
  1. Lift handset or press **SPEAKER**, select line (unless your telephone selects it for you) or select **INTERCOM**, and listen for dial tone.
  2. Either dial number, use speed dial feature, use redial feature, or press Direct Station Select (DSS) if making an intercom call.

**3.2 Accessing Lines**

***NOTE:** The dial codes shown in this manual are the default dialing codes. Your installer may have reprogrammed the codes to better suit your application.*

- **To access outside lines using the line group feature,**
  1. Press **INTERCOM**, then dial line group access code:
    - 9** = group 1,
    - 80-89** = groups 2 through 11,
    - 60-64** = groups 12 through 16.
  2. Listen for outside dial tone.
  3. Dial number.
  4. When called party answers, lift handset.

- **To queue for a line group if all lines are busy,**
  1. Press **INTERCOM** and dial line group access code (**9, 80-89**, or **60-64**).
  2. Hear busy tone and dial \* **6**.
  3. Hang up and wait for queuing ring-back.
- **To answer queuing ring-back,**
  1. Lift handset and hear dial tone for line.
- **To cancel queuing before it rings back at your telephone,**
  1. Lift handset.
  2. Press **INTERCOM** and dial # **6**.
  3. Hang up handset.
- **If you must enter an account code when making outside calls,**
  1. Select line.
  2. Press **INTERCOM** and dial \***04** (this places the call on hold),  
—OR—  
press preprogrammed **ACCOUNT CODE** button (this does not interrupt the call in progress).
  3. Dial your account number, hear outside dial tone, and dial outside number.
  4. When called party answers, lift handset.



### **3.3 Using Last Number Redial**

- **To redial the last number that you dialed at your telephone,**
  1. Press **SPEAKER** (or hang up handset) to disconnect current ringing or busy tone.
  2. Dial #.
  3. Listen for ringing or busy tone over the telephone's speaker. When called party answers, lift handset; if called party is busy, press **SPEAKER** to disconnect.
  
- **To automatically redial the last dialed number once a minute for 10 minutes,**
  1. Press **ARDL**.
  2. Listen for ringing or busy tone over the speaker.
  3. When called party answers, *lift the handset* (you must do this to disengage the redial feature).

### **3.3.1 Using The Automatic Redial Feature**

If your station has the multiple automatic redial feature enabled, you can place up to 10 numbers in your telephone's redial queue. Your telephone will redial the numbers one at a time, in the order you placed them in the queue, until (a) the call is answered, (b) you cancel the automatic redial feature for a particular number, or (c) your telephone has dialed the number a preprogrammed number of times (set by your system installer).

- **To use the automatic redial feature to redial a busy or unanswered number,**
  1. While on the call, press **ARDL** or press the **AUTOMATIC REDIAL** button programmed by your installer.
  2. The system repeatedly dials the number until you cancel the feature or the system has dialed the number a preprogrammed number of times (determined by your system installer).
  3. The **AUTOMATIC REDIAL** light flashes between redials and turns on steady during redialing.
  4. When the distant party answers the call, press the **ARDL** button or the **AUTOMATIC REDIAL** button while on the call to cancel automatic redialing,  
—OR—  
if your installer has enabled answer supervision on your line, the system automatically cancels automatic redialing and turns the **AUTOMATIC REDIAL** light off.
  5. If your system installer has enabled the redial multiple numbers feature, you can have up to 10 numbers in your redial queue. To add numbers to your redial queue, repeat step 1 in the above procedure.
  
- **To scroll through numbers in your redial queue if your telephone is currently idle,**
  1. Press the **ARDL** button or the **AUTOMATIC REDIAL**.  
The display shows the last number dialed.
  2. To remove the number from the redial queue, press **REMOVE**,  
—OR—  
to scroll to the next number in the queue, press **NEXT**,  
—OR—  
to exit from the redial queue, press **EXIT**.

- To interrupt the redialing procedure so that you can scroll through numbers in your redial queue,

*NOTE: You can only do this if the multiple automatic redial numbers feature is enabled and you currently have more than one number in your redial queue.*

1. While your telephone is in the process of dialing a number, press the **ARDL** button or the **AUTOMATIC REDIAL** button twice. This treats the number as answered, cancels automatic redialing for that number, and puts the number back in the automatic redial queue.  
The display shows the last number dialed.
2. To remove the number from the redial queue, press **REMOVE**,  
—OR—  
to scroll to the next number in the queue, press **NEXT**,  
—OR—  
to exit from the redial queue, press **EXIT**.

- To cancel the automatic redial feature,

1. Perform any user activity at the station (go on-hook, press the speaker button, etc.),  
—OR—  
press # **72** to delete all numbers from the redial queue,  
—OR—  
press the **ARDL** or **AUTOMATIC REDIAL** button while the number you wish to remove from the redial queue is ringing.

*NOTE: The system allows only ten numbers in the redial queue. In order to add a number to a full redial queue, you must first remove one of the numbers from the queue.*

### **3.4 Using Speed Dial**

- **To dial a speed dial number from a preprogrammed DSS button,**
  1. Press preprogrammed button. If you have programmed the number at the second level of a DSS button, press **SHIFT** before pressing button.
  2. When called party answers, lift handset.
- **To dial personal or system speed dial numbers from your keypad,**
  1. Dial desired code:
    - 0-9** = personal speed dial number,
    - \*000-\*999** = system speed dial number,if you are already on a line, press **HOLD**, then dial code.
  2. When called party answers, lift handset.

***NOTE: On some earlier systems, the available system speed dial codes are \*100-\*299 and \*100-\*599.***

### **3.5 Using Dial By Name**

The Dial By Name feature provides an index of names for you to search through. When you select a name in the index, the system will automatically dial that person's extension number.

- **To use Dial By Name,**

1. Press **OPTIONS** to enter the dial by name menu.
2. From the dial by name menu,  
Press **INT** button for intercom calling.  
—OR—  
Press **EXT** for speed dial calling.
3. Dial digits corresponding to the letters in the name you want to locate (for example, dial 266 for Comdial). There is no limit to the number of digits you can dial.  
1 = QZ    2 = ABC    3 = DEF  
4 = GHI    5 = JKL    6 = MNO  
7 = PRS    8 = TUV    9 = WXY
4. The display shows the first existing name match to the dialed digits or shows a **No Match** message if the system can not find a match.
5. Press **NEXT** to display the subsequent names in the index until you reach the name you need.
6. Press **DIAL** to call the displayed location.
7. If the display says **No Match**, press **PREV** or enter new digits to search for a new name.

### **3.6 Making A Subdued Off-Hook Voice Announcement (SOHVA)**

- **To make a SOHVA announcement using the preprogrammed SOHVA button,**
  1. Make intercom call and hear busy tone.
  2. Decide whether to interrupt.
  3. If you decide not to interrupt the called party, hang up.
  4. To interrupt, press preprogrammed **SOHVA** button and hear several quick tone bursts.
  5. Make announcement (busy tone means the called telephone is in speakerphone mode and you cannot make announcement, system programming has denied your SOHVA, or the called party has blocked your SOHVA).
  6. Wait on line for reply (either verbal or LCD reply).

***NOTE: You cannot control how the called party receives the announcement. This depends on whether the party is using a headset and on the programming of his or her station. For example, if the called party has set the station to forward to voice mail or to another station not in the SOHVA group, he or she will not receive your announcement.***

### **3.7 Making A Paging Announcement**

- **To send a paging announcement,**
  1. Lift handset.
  2. Press **INTERCOM**, then dial **70-77** for zones 1-8 [in the default mode code **70** (zone 1) provides an all-call function],  
—OR—  
press a preprogrammed **PAGE** button.
  3. Make announcement.
  4. Remain on line if awaiting a reply (known as a meet-me page),  
—OR—  
hang up handset.

At times other telephone users may page you with instructions to meet them on line. This is known as a meet-me page. You can go to the nearest telephone and dial a code to contact the paging party.

- **To reply to a *meet-me* page,**
  1. Lift handset of nearest telephone.
  2. Press **INTERCOM**.
  3. Dial **78**.
  4. Meet paging party on line.

### ***3.8 Camping On At a Busy Station And Waiting For An Answer (Call Waiting)***

If the telephone you have called is busy, you can send a call-waiting message to the telephone and wait on the line for an answer (you must be using the handset for this feature to work.)

- **To activate call waiting when you hear a busy signal,**
  1. Dial \* 6 (called party hears tone).
  2. Wait on line for reply.
  3. Called party can place the current call on hold or disconnect from the call to answer your call-waiting tone, or ignore you call-waiting tone and continue current conversation.
  
- **To cancel call waiting,**
  1. Press INTERCOM, then dial # 6.
  2. Hang up or press SPEAKER to end.
  
- **To answer a call-waiting tone if you receive one while on a call,**
  1. Hear short burst in handset receiver.
  2. You may choose to ignore the call-waiting tone and remain on line with your original caller,  
—OR—  
complete present call and hang up handset (waiting call will begin ringing). Lift handset to answer waiting call.



### ***3.9 Camping On At An Idle Station And Waiting For An Automatic Callback***

---

If you call another station and hear ringing but receive no answer, you can press a button that will cause the system to ring your telephone when the user at the called station initiates any telephone activity.

- **To camp on at a station for which you hear ringing but receive no answer,**
  1. Press **CALLBK** button.
  2. Callback will occur after the user at the called station initiates any telephone activity.
  
- **To cancel the camp-on condition at any time,**
  1. Press **INTERCOM** button and dial # **6**.

***NOTE: If you make a call in the voice announce mode and receive no answer at the called station, the CALLBK option is still available to you.***

### ***3.10 Camping On At A Busy Station And Waiting For An Automatic Callback***

---

- **To camp on at any busy station,**
  1. Press *CAMP*.
  2. Your telephone immediately disconnects. When the station you called becomes available, your telephone will ring with five short tone bursts.
  
- **When you hear five short tone bursts,**
  1. Press **INTERCOM**.
  2. The other telephone will start ringing. If you do not press **INTERCOM** within the time limit set by the installer, you cancel the callback at that time.
  
- **To cancel the callback before your telephone sounds the tone bursts,**
  1. Press **INTERCOM** and dial # 6.
  
- **To camp on at a station with a Do Not Disturb condition set,**
  1. Press *CAMP*.
  2. A callback will occur when the user at the called station disables the Do Not Disturb mode.

**4****Placing Calls On Hold****4.1 Holding Calls**

- **To place a call on hold,**
  1. Press **HOLD**.
  2. Hang up handset.
- **To return to a call that is on hold,**
  1. Lift handset and press line button with flashing light,  
—OR—  
press **TAP**.
- **To place a call on exclusive hold,**
  1. Press **HOLD** twice and hang up handset.
- **To retrieve an exclusive hold,**
  1. Press line button of held call (button with flashing light),  
—OR—  
press **TAP** (if station does not have line appearance).
- **To place a call on hold at another telephone,**
  1. While on line, press **INTERCOM** (system places call on hold).
  2. Dial \* **90**, then dial extension number of telephone to receive held call.
  3. Hang up handset.

- **To retrieve a held call at another station,**
  1. Lift handset.
  2. Press **INTERCOM** and dial # **90**.
  3. Dial extension number of station that has the held call,
  4. Answer call.
  
- **To answer a call at the extension receiving held call,**
  1. Lift handset.
  2. Press **INTERCOM** and dial # **90**.
  
- **To cancel directed call hold and retrieve the call,**
  1. Lift handset.
  2. Press **INTERCOM**, dial \***4**, then dial the extension number of the telephone to which you directed the call.
  3. Retrieve the call.
  
- **You can scan your held calls and retrieve a specific one,**
  1. Lift handset (if your station does not have prime line or idle line preference).
  2. Press **HOLD** repeatedly to scan held call list.
  3. Press **TAP** to retrieve desired call.

Example: If five calls are holding and you wish to retrieve the second call you placed on hold, press **HOLD** three times to scroll from held call #5 to call #4, to call #3, and to call #2, then press **TAP** to retrieve call #2.

## **4.2 Using Call Park**

- **To park a call,**
  1. When on a line, press **INTERCOM**.
  2. Dial \*, then dial park orbit access code (**91-99** for orbit **1-9**). If chosen orbit is busy, dial a different orbit number.
  3. Hang up handset.
  4. Remember the code for later use or make it known to those who need to know it in order to retrieve the call.

***NOTE: If no one retrieves the call within a programmable time limit, it reverts to the parking station as a standard held call. You can place only one call in an orbit at a time.***

- **To retrieve a parked call,**
  1. From any station, press **INTERCOM**.
  2. Dial #.
  3. Dial park orbit access code (**91-99**), or press preprogrammed **PARK** button.
  4. Answer call.

*This page remains blank intentionally.*

**5****Sending And Receiving  
Non-Verbal Messages****5.1 Using the Messaging Feature**

- **To turn on the message-waiting light and broken dial tone at an idle telephone,**
  1. Press **INTERCOM**.
  2. Dial \* 3.
  3. Dial extension number of the station you want to alert. The message-waiting light of that station will flash.
  
- **You can also turn on the message-waiting light and broken dial tone at another station when that station is busy,**
  1. Hear the busy tone and remain on the line.
  2. Press **MSG**.
  3. Hang up.
  
- **To turn off the message waiting light at a busy or idle station,**
  1. Press **INTERCOM**.
  2. Dial # 3.
  3. Dial extension number of alerted station. The message-waiting light of that station will turn off.

## ***5.2 Using LCD Messaging***

*NOTE: You can set system-supplied messages to display at any calling LCD speakerphone.*

- **To turn on LCD messaging,**
  1. Press **INTERCOM**.
  2. Dial \* **02**.
  3. Press # to clear current message if you have one stored.
  4. Dial message code number (**01–30**).
  5. Press # and then press **SPEAKER** to end message.
  6. **INTERCOM** light flashes.
  
- **To turn off LCD messaging and your INTERCOM light,**
  1. Press **INTERCOM**.
  2. Dial # **02**.



### **5.3 Sending An LCD Message**

- **To send an LCD message when you call and receive busy signal or no answer,**

1. While still on the call, press the appropriate fixed **RESPONSE MESSAGE** button to send a preselected message (*Call [your name]*, for example) to the other telephone,

—OR—

1. While still on the call, press the scrolling **RESPONSE MESSAGE** button to scroll through the system-supplied messages.
2. Press # when your display shows the message you wish to send (this displays the message at the called telephone).

- **To send an LCD message to a caller who has initiated a SOHVA or intercom call from another LCD telephone,**

1. Hear the SOHVA tone or voice announcement in your handset or headset.
2. Press the appropriate fixed **RESPONSE MESSAGE** button to send a preselected message (*I Will Call Back*, for example) to the calling telephone.

—OR—

1. While still on the call, press the scrolling **RESPONSE MESSAGE** button to scroll through the system-supplied messages.
2. Press # when your display shows the message you wish to send (this displays the message at the calling telephone and terminates the SOHVA call).

*This page remains blank intentionally.*

# 6

## Transferring Calls

### 6.1 Transferring Outside Calls

- **To announce a call before transferring it,**
  1. Answer outside call.
  2. Press **TRANSFER/CONFERENCE** (this places the call on hold).
  3. Dial station number, or press DSS button for that station.
  4. Upon answer, announce the call.
  5. Hang up the handset (this transfers the call), or if in speakerphone mode, press **SPEAKER** to disconnect.
  
- **To transfer a call without first announcing it,**
  1. Answer outside call.
  2. Press **TRANSFER/CONFERENCE** (this places the call on hold).
  3. Dial station number.
  4. Hang up handset, or if using speakerphone, press **SPEAKER** to disconnect. Call will re-ring your telephone if no one answers it within a preprogrammed time.
  
- **If you hear a busy signal or receive no answer,**
  1. Press **RECON** to return the call to your station.
  2. Press **SOHVA** to tell intercom party that a call awaits.
  3. Press **MSG** to leave a message-waiting indication at the called station.

- **To make a hot transfer,**
  1. Answer call.
  2. Press **TRANSFER/CONFERENCE** (this automatically places the call on hold).
  3. Dial extension number of telephone to receive the transfer or press the DSS button for that extension.
  4. Announce call.
  5. Press **TRANSFER/CONFERENCE**.
  6. Press **SPEAKER** to disconnect (if in speakerphone mode) or hang up. The person receiving the transfer has the call.
  
- **To do a quick screened transfer to intercom or tie line,**
  1. Answer call.
  2. Dial intercom number for transfer location.
  3. When party at transfer location answers, announce call.
  4. Hang up or press **RELEASE** button.
  
- **To do a quick unscreened transfer to intercom or tie line,**
  1. Answer call.
  2. Dial intercom number for transfer location.
  3. Hang up or press **RELEASE** button.

# 7

## Conferencing Calls

### 7.1 Conferencing Stations Together

- **To set up a conference call that includes any combination of outside lines and intercom parties,**
  1. Make first call.
  2. Press **TRANSFER/CONFERENCE** (this places the on hold).
  3. Select next line and make next call.
  4. Press **TRANSFER/CONFERENCE** to establish conference.
  5. Repeat the last three procedures to add up to two more parties for a 5-party conference (including yourself) when using the DXP system.

***NOTE:** When using a DXP Plus system, you can have up to seven parties (including yourself) on a conference call.*

- **To retrieve a line from hold and bring that party into the conference,**
  1. Press **TRANSFER/CONFERENCE**.
  2. Press line button.
  3. Press **TRANSFER/CONFERENCE**.

***NOTE:** If all conference circuits are busy, you will not be able to add a party to the conference. The message "Conference Full" will appear in your display.*

- **To continue conversation on remaining line after other outside lines have dropped out of conference,**

1. Press the line button of the remaining party.

- **To drop out of a conference call between you and two outside lines (creating an unsupervised conference),**

1. Dial # (lines remain lighted and in use until one or both outside parties disconnect; when only one party drops out of an unsupervised conference, the other party remains on hold until hanging up or reconnecting with you on line).

***NOTE: The installer must program your system to include this feature or it will not operate as described.***

- **To rejoin an unsupervised conference between two outside lines,**

1. Press **TAP**.

***NOTE: Conference volume levels depend upon the quality of the external lines.***



## ***Programming Your Telephone***

---

### ***8.1 Storing DSS Numbers***

- **To store extension numbers at DSS buttons,**
  1. Press ***OPTIONS***.
  2. Press ***NEXT*** until ***DSS*** option appears,
  3. Press ***DSS***.
  4. Press programmable button to choose storage location.
  5. Dial extension number.
  6. Press next programmable button and dial another extension number.
  7. Repeat previous step until finished then press ***EXIT***.
  8. Press ***SPEAKER*** to end.

## **8.2 Storing Feature Buttons**

- **To store special-purpose feature buttons,**
  1. Press *OPTIONS*.
  2. Press *NEXT* until *FEAT* option appears.
  3. Press *FEAT*.
  4. Press *NEXT* until the feature you want is displayed.
  5. Press desired feature button.
  6. Press programmable button to choose storage location.
  7. Press *FEAT* again to program another feature or *EXIT* to end.

*NOTE: To clear a feature button assignment, repeat this procedure, but press CLEAR before pressing storage location button.*

## **8.3 Storing A Response Message Button**

- **To store a scrolling RESPONSE MESSAGE button,**
  1. Press **INTERCOM**.
  2. Dial \* \* 6.
  3. Press programmable button for **RESPONSE MESSAGE** button location.
  4. Dial **00**.
  5. Press # to save programming.
  6. Press **SPEAKER** to end.
  7. Label button location.
- **To store a fixed RESPONSE MESSAGE button,**
  1. Press **INTERCOM**.
  2. Dial \* \* 6.
  3. Press programmable button for **RESPONSE MESSAGE** button location.



4. Dial message number (**01-30**) from list of messages provided by your system attendant or installer.
5. Press **#** to save programming.
6. Press **SPEAKER** to end.
7. Label button location.

## ***8.4 Programming Speed Dial Numbers***

- **To store an outside number as a speed dial number,**
  1. Press **OPTIONS**.
  2. Press **NEXT** until **SDIAL** option appears.
  3. Press **SDIAL** to choose speed dial programming.
  4. Press programmable button (or **1-0** on keypad) to choose storage location.

**NOTE:** *You can store another number at a second level of a programmable button by first pressing **SHIFT**.*

5. Press line button, or dial **01-16** to select line groups 1-16, or dial **00** for system to select line.
6. Dial number you want to store (maximum 16 digits). To store a hookflash in a number sequence, press **TAP**; press **HOLD** to store a pause (only if needed).
7. Press **SAVE**, press next programmable button, and dial another number to store.
8. Repeat previous step until finished, then press **EXIT**.
9. Press **SPEAKER** to end.

**NOTE:** *When you are programming emergency numbers and making test calls to emergency numbers, the Federal Communications Commission (FCC) requires that you do the following: (1) remain on the line and briefly explain to the dispatcher the reason for the call; (2) always make test calls during the off-peak hours, such as early morning or late evening.*

- **To store an intercom number as a speed dial number,**
  1. Press **INTERCOM**.
  2. Dial \* \* 1.
  3. Press the button you want to program.
  4. Press **INTERCOM**,  
—**OR**—  
press **8** to preselect intercom.
  5. Enter the intercom number you want to store (up to 16 digits that can include # and \*).
  6. Press **SPEAKER** to end.
  7. Repeat procedure for each speed dial number.

***NOTE: You cannot program pauses or hookflashes with intercom speed dial numbers, and the system will not accept \*#0# or \*#746\* as programming entries.***

## **8.5 Setting A Reminder Alert**

- **To set a reminder alert at your telephone,**
  1. Press *OPTIONS*.
  2. Press *NEXT* until the *ALERT* option appears.
  3. Press *ALERT*.
  4. Press **1** or **2** to select available alert designation; if you have already programmed an alert for 1, press **2** to set a second alert condition.
  5. Press *ON* (press *OFF* to turn off an alert that you have already set).
  6. Dial reminder time using the numbers on the dial pad [remember to add a zero (0) before single digit times: 01 for one o'clock, 02 for two o'clock, etc.].

**Example:** Set reminder time for ten minutes past three o'clock PM. Remember that the system only recognizes military time which is in the 24-hour format. In 24-hour format, hours in a day are represented by 00 (midnight) through 23 (11 o'clock PM) and minutes in an hour are represented by 00 through 59. Therefore, you would dial the example time as 1510.

7. Set *AM* or *PM*.
  8. Press *SAVE*.
  9. Press *SPEAKER* to end.
- **To respond to an alert after it sounds,**
    1. Press *CLEAR* to turn off the alert,  
—OR—  
press *SET* to reset the alert for the same time the following day.

*This page remains blank intentionally.*

**9****Using The Other Telephone Features****9.1 Adjusting The Display Contrast**

- **To adjust the display contrast,**
  1. Press *OPTIONS*.
  2. Press *NEXT* until the *DISP* option appears.
  3. Press *DISP*.
  4. Your display will read “**Contrast Level.**”
  5. Press *LIGHT* or *DARK* once for each degree of change desired.
  6. Press *SPEAKER* to end.

**9.2 Blocking Voice-Announce Calls**

- **To block voice-announce calls,**
  1. Press *OPTIONS*.
  2. Press *VAB*.
  3. Press *ON*.
  4. Press *SPEAKER* to end.
  
- **To un-block voice-announce calls,**
  1. Press *OPTIONS*.
  2. Press *VAB*.
  3. Press *OFF*.
  4. Press *SPEAKER* to end.

### ***9.3 Displaying Status Of Busy Lines And Stations (Busy Button Inquiry)***

---

- **To identify the station that occupies a busy line,**
  1. Press button for busy line.
  2. Read your display for intercom number of station that is busy on line.
  
- **To identify the line that a busy station occupies,**
  1. Press DSS button for busy station.
  2. Read your display for the line number of the busy station.

### ***9.4 Displaying Button Functions (Button Query)***

---

- **To cause the display to identify the function of each button on your telephone,**
  1. Press *OPTIONS*.
  2. Press *NEXT* until *QUERY* appears,  
—OR—  
dial \* \* 8.
  3. Press the button in question.
  4. Read the displayed information (display will hold for a few seconds before the telephone returns to idle).

## ***9.5 Diverting Incoming Calls To Another Station***

---

Call diverting permits you to send an incoming call to another station that you have previously designated. You can divert an incoming call to the designated station whether you are busy or idle. You must program a **CALL FORWARD** button (using the instructions in the programming section) on your LCD speakerphone to serve as a call divert button.

- **To identify the station to receive diverted calls,**
  1. Press **INTERCOM**.
  2. Dial **\*55**.
  3. Dial extension number of station to receive diverted call.
  4. Press **SPEAKER** to end.
  
- **To divert calls to the designated station,**
  1. Hear ringing or see flashing line status light.
  2. Press **CALL FORWARD** (system immediately forwards ringing call to station you designated).

## ***9.6 Listening To A Call Over The Telephone Speaker (Group Listening)***

---

- **To activate group listening while on a call,**
  1. Press the preprogrammed **GROUP LISTEN** button.
  
- **To cancel group listening,**
  1. Press the preprogrammed **GROUP LISTEN** button again.

**NOTE:** *You should cancel Group Listening before hanging up the handset to end the call.*

## **9.7 Muting Your Telephone**

- **To mute your telephone,**
  1. Press **MUTE** (MUTE light turns on). You can still hear distant callers, but they cannot hear you.
- **To speak to the distant party,**
  1. Press **MUTE** again (MUTE light turns on).

## **9.8 Setting A Do Not Disturb Condition**

- **To enable DND,**
  1. Press **OPTIONS**.
  2. Press **NEXT** until the **DND** option appears.
  3. Press **DND**.
  4. Press **ON**.
  5. Press **EXIT**.
  6. Press **SPEAKER** to end.
- **To disable the DND condition,**
  1. Repeat the above procedure, but press **OFF** instead of **ON**.
- **To set a Do Not Disturb condition at your telephone when a call rings at your station,**
  1. Hear ringing and notice incoming call information in display.
  2. Press **DND** option. Ringing will stop, caller will hear the Do Not Disturb tone, and your telephone will remain in DND until you disable the feature (described above).



### **9.9 Overriding A Call Or A Do Not Disturb Condition At Another Telephone (Executive Override)**

---

- **To override an in-progress call at another telephone,**
  1. Make intercom call and hear a busy signal.
  2. Dial \* 03 (all parties will hear several tone bursts).
  3. Join in-progress call.
  
- **To override a Do Not Disturb condition at another station,**
  1. Press **OVER** to disable the Do Not Disturb condition at the called station.
  2. Speak your announcement (if in voice-first mode) or hear ring-back tone (if in tone-first mode).

***NOTE: This action disables DND condition at the other telephone until the user at that station resets DND.***

## **9.10 Setting The Volume Control**

The volume control on your telephone is a multipurpose control you can use to set the volume of the ringer, speaker, handset, headset, background music, and the group listening mode. You can press the **VOLUME UP** or **VOLUME DOWN** button once for each change in loudness you desire.

You can adjust the loudness of the distant party at any time during a call whether you are listening over the speaker, the headset, the handset, or the group listen mode by pressing the **VOLUME UP** or **VOLUME DOWN** button. When the call ends, the system resets the loudness to the default setting.

You can change the default setting for any volume control setting by pressing **\*\* 7** when the loudness is at the desired level. The volume level remains at this setting until you select a new default.

***NOTE: Impact SCS 8324S-\*\*, 8324F-\*\*, and 8312S-\*\* telephones support the optional ICVOL-\*\* handset. The ICVOL-\*\* is an amplified handset with its own volume control, making it useful in noisy environments. For ordering information, contact your Comdial dealer.***

- **There are four *ringer* loudness levels (plus an off position). Set the level as follows:**
  1. While your telephone is on hook and idle, press the **VOLUME UP** or **VOLUME DOWN** button once for each change in loudness you desire. The ringer sounds once for each change as an example of the current setting. Your selection becomes the new default setting and will result in your telephone ringing at that level for all future calls (until you change the default by repeating the above procedure).
- NOTE: If you set the ringer to the “off” position, your telephone will sound a short ring burst once for each call you receive at your station while the ringer is off.*
- **There are eight *speaker* loudness levels. Set the level for the current call as follows:**
  1. While on a call and in speakerphone mode, press the **VOLUME UP** or **VOLUME DOWN** button once for each change in loudness you desire.
- **There are eight *background music* loudness levels. Set the level as follows:**
  1. While background music is on at your station, press the **VOLUME UP** or **VOLUME DOWN** button once for each change in loudness you desire. This level will remain set for background music until you change it again, even if you turn off the feature and then reactivate it.
- **There are eight *group listening* loudness levels. Set the level for the current call as follows:**
  1. While on a call and in the group listening mode, press the **VOLUME UP** or **VOLUME DOWN** button once for each change in loudness you desire.
- **There are eight *handset* loudness levels. Set the level for the current call as follows:**
  1. While on a call and in handset mode, press the **VOLUME UP** or **VOLUME DOWN** button once for each change in loudness you desire.

- **There are eight *headset* loudness levels. Set the level for the current call as follows:**
  1. While on a call and in headset mode, press the **VOLUME UP** or **VOLUME DOWN** button once for each change in loudness you desire.

*NOTE: On telephone models 8024S-\*\* and 8012S-\*\* your installer may have turned on the “high handset volume” feature, providing 13 handset/headset volume levels instead of 8.*
  
- **To set a permanent group listening, speaker, headset, or handset loudness level for all future calls,**
  1. Press **INTERCOM**.
  2. Activate speaker, headset, handset, or group listen mode that you want to affect.
  3. While in that mode, press the **VOLUME UP** or **VOLUME DOWN** button to adjust loudness.
  4. Dial \* \* 7 or press a preprogrammed **SAVE** button to hold the loudness at the last setting for all future calls (until you change the default again).
  5. Repeat this procedure in each mode until you have set all default volume levels.

### **9.11 Setting Your Personal Ringing Tones**

- **To select one of the ringing tones,**
  1. Press **OPTIONS**.
  2. Press **NEXT** until the **RING** option appears.
  3. Press **RING**.
  4. Press **UP** or **DOWN** to choose ring tone in display (a new tone will sound at each up or down press).
  5. Press **EXIT** to return to main display.
  6. Press **SPEAKER** to end.

### **9.12 Using Background Music**

- **To turn the music on,**
  1. Press **OPTIONS**.
  2. Press **MUSIC**.
  3. Press **SET**.
  4. Select **SRC 1** or **SRC 2** for the music source (the DXP system is equipped to provide music from two sources, but the installer must enable this feature).
  5. Press **SPEAKER** to end (the SPEAKER light turns on when background music is on).
  6. Adjust music volume with the volume button.
- **To turn the music off,**
  1. Press **OPTIONS**.
  2. Press **MUSIC**.
  3. Press **CLR**.
  4. Press **SPEAKER** to end (the SPEAKER light turns off when background music is off).

### 9.13 Using The IMIST Module

*Impact* SCS 8324F-\*\*, 8324S-\*\*, and 8312S-\*\* speakerphones equipped with the optional IMIST module can support an IST device (modem, FAX machine, industry-standard telephone, etc.) in addition to the LCD speakerphone. Depending on system programming, the IST device may be used to make outgoing calls and receive incoming calls.

The functionality of the IMIST module depends on the type of system you are using.

On a DXP system, the IMIST module does not have its own extension number and cannot function simultaneously with the speakerphone.

On a DXP *Plus* system, the IMIST module will function simultaneously with the speakerphone and have its own extension number *if* your system has revision 5 or later digital station board firmware. If your system has an earlier firmware revision, the telephone and IMIST module can not function simultaneously and the IMIST module will not have its own extension number.

On an FX Series system, the speakerphone and IMIST module can function simultaneously and the IMIST module has its own extension number.

**NOTE:** *The IMIST module does not provide voltage to light a message waiting light. Message waiting lights on devices plugged into the IMIST module will not function.*

If you have any other questions about IST devices, refer to GCA70-237, *Industry-Standard Telephone Station User's Guide*.

**NOTE:** *The IMIST module has a separate power supply. The wall transformer is a UL and CSA approved Class 2 device operating from 120 Vac, 60 Hz, 16 watts and provides an output of 24 Vac at 450 mA. For replacement, order Comdial P/N DIU-PTR.*

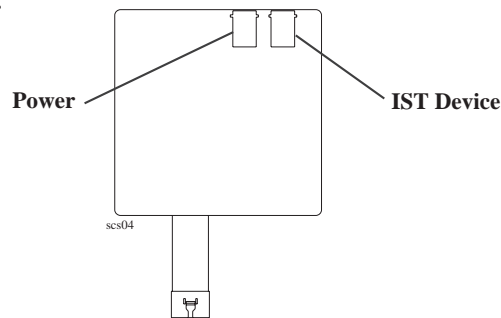

IMIST Module

## **9.14 Using The Caller ID Feature**

The Caller ID feature allows you to view incoming call numbers before you answer them. Incoming call numbers flash in the lower half of the LCD. If you answer the call, the number appears in the upper half of the LCD.

The system also stores numbers that ring on your line but receive no answer. The system indicates that it has stored ring-no answer numbers by causing the CID light on your telephone to flash. Pressing the **CID** button allows you to view the stored numbers one at time. Pressing the **SAVED NUMBER REDIAL** button causes the system to dial the displayed number. If the call has been returned by someone else, pressing the \* key reveals who returned the call. Everyone sharing your line can scroll through the stored numbers and choose which calls to return.

**NOTE:** *If your system installer has not programmed a SAVED NUMBER REDIAL button, refer to section 9.4, Using The Feature Buttons, for instructions on programming this button.*

- **To scroll through ring-no answer numbers stored on your system,**
  1. If your CID light is flashing, the system has unreturned ring-no answer numbers stored in memory.
  2. To view the list of unreturned ring-no answer number, press the preprogrammed **CID** button on your telephone. Your LCD will display the calling number, date, and time the call came in. The most recent call appears first in the list.
  3. Press the **CID** button each time you wish to display the next most recent ring-no answer call to your line.
  4. To dial one of the numbers in the redial queue, press the **SAVED NUMBER REDIAL** button. The system will automatically dial the number.

Depending on your system programming, when a call is returned it might remain in the ring-no answer queue or the system might delete it from the ring-no answer queue. Your system installer can tell you how the feature is programmed. If the system is programmed to leave a returned number in the redial queue, the display will show a \* next to numbers that have been returned.

- **To determine who viewed the number and returned the call,**
  1. Press \*.

*This page remains blank intentionally.*



**10*****Operating Your Telephone  
With A DSS/BLF Console******10.1 Operating Your Telephone  
With A DSS/BLF Console***

The IB64X, IB48X, and IB24X DSS/BLF consoles have additional buttons and status lights that extend the memory button capability of an adjacent companion telephone. The buttons can be programmed for automatic dialing (speed dial) or direct station selection (DSS) with busy lamp field (BLF) using the instructions provided previously in this guide.

When the installer assigns a DSS/BLF console to a station port, the system recognizes it as such and automatically clears (blanks) the console buttons so that you can store numbers at the buttons as you need them.

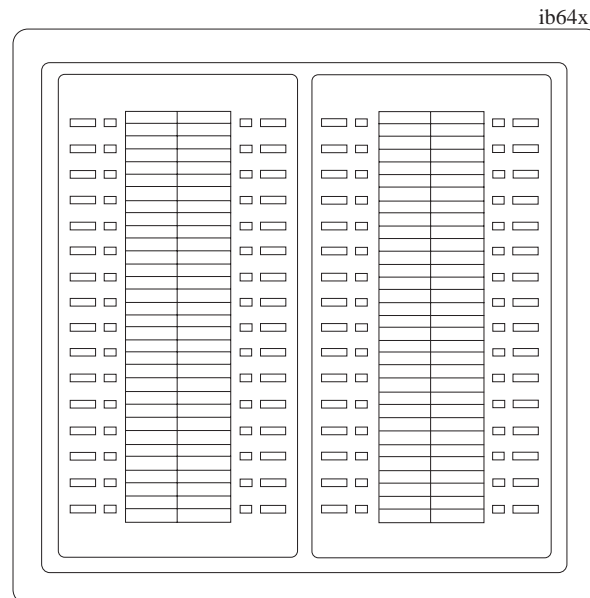

IB64X DSS/BLF Console

### 10.1.1 Accessing The Button Levels

The IB24X and IB48X DSS/BLF consoles have four levels of buttons, quadrupling the consoles' button capacity. The four buttons at the bottom of each console allow you to select which button level is currently active. To change button levels, press one of the buttons at the bottom of the console. The leftmost button activates level 1, the next button activates level 2, etc. A light beside the appropriate button lights to indicate which level is currently active.

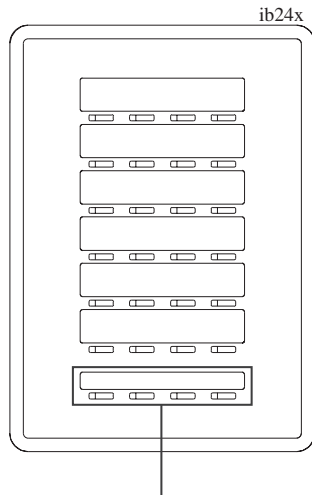

Level access buttons  
IB24X DSS/BLF Console

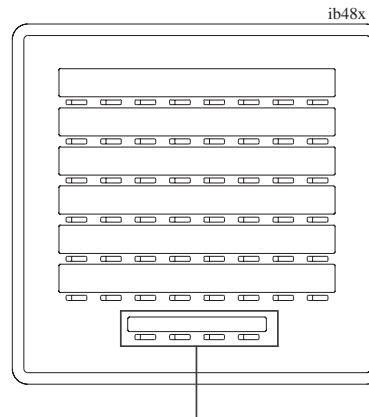

Level access buttons  
IB48X DSS/BLF Console

# 11

## Troubleshooting Your Telephone

Symptom	Possible Cause
INTERCOM light flashing.	Your messaging is set. Press INTERCOM, then dial # 02 and hang up.
HOLD light flashing with no line on hold.	Another telephone has activated your message waiting light. Press INTERCOM and then press HOLD to retrieve message. This action will call party who activated light. Once you have received message, party who activated light (while still talking to you) must press INTERCOM to turn off the light.
MUTE light on.	MUTE is activated. To cancel, press MUTE.
SPEAKER light on steady.	Background music feature activated even though the system does not provide background music. To cancel, press INTERCOM then dial # 1.
Error Tone (three steady tones)	May occur when incorrect buttons are pressed during speed dial programming. For example, if a button has a line assigned to it, or was not enabled for speed dial programming by the installer.
You can not receive a voice announce call.	Voice announce block has been activated. To cancel, press INTERCOM then dial # 2.

*This page remains blank intentionally.*

**Index**

<b>A</b>	<b>Section</b>
Accessing Lines .....	3-1
Adjusting Display Contrast .....	9-1
Adjusting The Telephone Pedestal .....	1-12
Answering A SOHVA .....	2-2
Answering Calls .....	2-1
Automatic Redial Feature .....	3-4 — 3-5
 <b>B</b>	
Background Music .....	9-9
Blocking Voice-Announce Calls .....	9-1
Button Levels, Accessing DSS/BLF .....	10-2
Button Programming .....	8-1 — 8-2
Button Query .....	9-2
Busy Button Inquiry .....	9-2
Busy Lines And Stations, Displaying Status .....	9-2
 <b>C</b>	
Call Park .....	4-3
Caller ID Feature .....	9-11
Calls, Answering .....	2-1
Calls, Blocking Voice Announce .....	9-1
Calls, Forwarding .....	2-3
Calls, Holding .....	4-1
Calls, Making .....	3-1
Calls, Transferring .....	6-1
Camping On At A Station .....	3-10 — 3-12
Conferencing Stations .....	7-1
Contrast, Adjusting .....	9-1
 <b>D</b>	
Dial By Name Feature .....	3-7
Dialing, Speed .....	3-6
Dialing, Last Number .....	3-3
Display Contrast, Adjusting .....	9-1
Displaying Button Functions .....	9-2
Displaying Status Of Busy Lines And Stations .....	9-2
Diverting Incoming Calls .....	9-3
Do Not Disturb, Overriding .....	9-5

---

Do Not Disturb, Setting .....	9-4
DSS/BLF Console .....	10-1
DSS/BLF Console, Accessing Buttons Levels .....	10-2
<b>F</b>	
Forwarding Calls .....	2-3
Full-Duplex Speakerphone, Using A .....	1-7
<b>G</b>	
Group Listening .....	9-3
<b>H</b>	
Holding Calls .....	4-1
<b>I</b>	
IMIST Module .....	9-10
Incoming Calls, Diverting .....	9-3
IST Dialing Codes .....	A-5
<b>L</b>	
Last Number Redial .....	3-3
LCD Abbreviations .....	1-3 — 1-6
LCD Messaging .....	5-2
Light Patterns .....	1-1
Lights, What They Mean .....	1-1
Listening To A Call Over The Telephone Speaker .....	9-3
<b>M</b>	
Making A Paging Announcement .....	3-9
Making A SOHVA .....	3-8
Making Calls .....	3-1
Messaging Feature .....	5-1
Messaging, LCD .....	5-2
Mute .....	9-4
<b>O</b>	
Operating Your Telephone With A DSS/BLF Console .....	10-1
Overriding A DND Condition .....	9-5
<b>P</b>	
Parking A Call .....	4-3
Paging Announcement, Making A .....	3-9
Pedestal, Adjusting The Telephone .....	1-12

- 
- Personal Ringing Tones, Setting ..... 9-9  
Programming Speed Dial Numbers ..... 8-3  
Programming Your Telephone ..... 8-1
- Q**  
Quick Reference Guide ..... Quick Reference-1
- R**  
Redial Feature, Automatic ..... 3-4 — 3-5  
Redialing Last Number ..... 3-3  
Reminder Alert, Setting A ..... 8-5
- S**  
Setting A Reminder Alert ..... 8-5  
SOHVA, Answering A ..... 2-2  
SOHVA, Making A ..... 3-8  
Speakerphone User Guidelines ..... 1-8  
Speakerphone, Using Your ..... 1-7  
Speed Dial ..... 3-6  
Speed Dial Numbers, Programming ..... 8-3  
Stations, Conferencing ..... 7-1
- T**  
Telephone Pedestal, Adjusting ..... 1-12  
Transferring Calls ..... 6-1
- U**  
Understanding What The Lights Mean ..... 1-1  
Using The IMIST Module ..... 9-10
- V**  
Voice Announce Calls, Blocking ..... 9-1  
Volume, Setting ..... 9-6

*This page remains blank intentionally.*





## ***Appendix A***

### ***Quick Reference Guide***

This chart provides you with a Quick Reference Guide of the feature dialing codes. If you wish, you can detach these pages and keep them near your telephone to serve as a stand alone reference. Chapter 8, *Programming Your Telephone*, describes a method to program these codes on your telephone at unused programmable buttons. Also, the installer may store features at your telephone buttons and label the buttons with the feature's mnemonics.

<b>Feature</b>	<b>Enable Code</b>	<b>Disable Code</b>	<b>Button Mnemonic</b>
Account Code	INTERCOM * 04 + account code		ACCT
All Call	INTERCOM 70		PAGE 1
Attendant Calling	INTERCOM 0		
Authorization Code	INTERCOM # 08 + authorization code		AUTH
Automatic Callback and Call Waiting	INTERCOM * 6	INTERCOM # 6	CAMP
Automatic Redialing			ARD
Background Music	INTERCOM * 11 or 12	INTERCOM # 1	MUSIC 1 MUSIC 2
Call Divert Station	INTERCOM * 55 + extension number		
Call Forward, Personal	INTERCOM * 51 + extension number	INTERCOM # 5	FWD-P
Call Forward, All Calls	INTERCOM * 52 + extension number	INTERCOM # 5	FWD-A

Feature	Enable Code	Disable Code	Button Mnemonic
Call Forward, Ring-No Answer, All Calls	INTERCOM * 54 + extension number	INTERCOM # 5	FWDRA
Call Forward, Ring-No Answer, Personal Calls	INTERCOM * 53 + extension number	INTERCOM # 5	FWDRP
Call Park, Orbit 91-99	INTERCOM * (91-99)		PARK 1-9
Call Park, Pickup	INTERCOM # 91-99		PARK 1-9
Call Pickup, Directed	INTERCOM * 4 + extension number		DPKUP
Call Pickup, Group	INTERCOM # 4		GPKUP
Clear Major Alarm Ring	INTERCOM # 09		
DISA Access	Installer Assigned		
Do Not Disturb	INTERCOM # 01		DND
Do Not Disturb Override	extension number + * 03		EXOVR
DSS Programming	INTERCOM ** 3		
Executive Override	extension number + *03		EXOVR
Hold, Manual	HOLD		HOLD
Hold, Exclusive	HOLD + HOLD		HOLD
Hold, Directed	INTERCOM * 90		
Hold, Directed Pickup	INTERCOM # 90		
LCD Messaging	INTERCOM * 02 + message	INTERCOM # 02	LCDMS

---

**2 – Quick Reference**

Feature	Enable Code	Disable Code	Button Mnemonic
Line Group 1	INTERCOM 9		LNG01
Line Groups 2-11	INTERCOM 80-89		LNG02-11
Line Groups 12-16	INTERCOM 60-64		LNG 12-16
Line Pick Up From Any Station, Zones 1-4	INTERCOM 65-68		TAFS 1-4
Line Pick Up From Any Station, All Zones	INTERCOM 69		TAFS*
Meet-Me Answer Page	INTERCOM 78		MMEPG
Message Waiting	INTERCOM * 3 + extension number	INTERCOM * 3 + extension number	
Message Wait Retrieval	#00		
Night Transfer (Attendant Only)	INTERCOM * # 0* 0 3 1	INTERCOM * # 0* 0 3 1	NIGHT
Operator Access	INTERCOM 0		
Paging, All Call	INTERCOM 70		PAGE 1
Paging, Zones 2-8	INTERCOM 71-77		PAGE 2-8
Paging, Meet-Me	INTERCOM 78		MMEPG
Park Orbit Retrieve	INTERCOM #91-99		PARK 1-9
Park Orbit Send	INTERCOM *91-*99		PARK 1-9

Feature	Enable Code	Disable Code	Button Mnemonic
Personal Ringing Tones	INTERCOM ** 4 + tone code (1-8)		
Redial Last Dialed Number	#		
Remote Station Disable	INTERCOM * 05 + extension number	INTERCOM * 05 + extension number	
Response Message	INTERCOM ** 6 + button + 01-30		RSPnn (nn = 1-30, S)
Service Observing	INTERCOM # 03 + extension number		S-OBS
Speed Dial, Station	1-0		
Speed Dial, System	* 100 * 599		
Speed Dial, Programming	INTERCOM ** 1		
Station Lock	INTERCOM #04 + code		LOCK
Volume Save	INTERCOM ** 7		VOLSV
Voice-Announce Block	INTERCOM * 2	INTERCOM # 2	VABLK

**NOTE:** The dialing codes provided in this quick reference guide are default values. Your system installer has the ability to renumber these codes.

The following table details several unique dialing codes that are only applicable to single line proprietary and industry-standard telephones.

<b>Feature</b>	<b>Enable Code</b>
Pick Up Last Line	* 08
Broker's Call	* 07
Speed Dial Access Code	* 01
Saved Number Redial	* 06
Dial Saved Number	* 09
TAP Dialing Code	# #

## **NOTES**

This manual has been developed by Comdial Corporation (the "Company") and is intended for the use of its customers and service personnel. The information in this manual is subject to change without notice. While every effort has been made to eliminate errors, the Company disclaims liability for any difficulties arising from the interpretation of the information contained herein.

The information contained herein does not purport to cover all details or variations in equipment or to provide for every possible contingency to be met in connection with installation, operation, or maintenance. Should further information be desired, or should particular problems arise which are not covered sufficiently for the purchaser's purposes, contact Comdial, Inside Sales Department, P.O. Box 7266, Charlottesville, Virginia 22906.

**COMDIAL**<sup>®</sup>  
Charlottesville, Virginia 22901-2829  
World Wide Web: <http://www.comdial.com/>

Printed in U.S.A.

GCA70-258.08  
8/97



## Free Manuals Download Website

<http://myh66.com>

<http://usermanuals.us>

<http://www.somanuals.com>

<http://www.4manuals.cc>

<http://www.manual-lib.com>

<http://www.404manual.com>

<http://www.luxmanual.com>

<http://aubethermostatmanual.com>

Golf course search by state

<http://golfingnear.com>

Email search by domain

<http://emailbydomain.com>

Auto manuals search

<http://auto.somanuals.com>

TV manuals search

<http://tv.somanuals.com>