

EDG-4508+

**8-Port Ethernet to
RS-232/422/485 Data Gateway**

EDG-4516+

**16-Port Ethernet to
RS-232/422/485 Data Gateway**

User Manual

Copyright

This documentation and the software included with this product are copyrighted 2004 by Advantech Co., Ltd. All rights are reserved. Advantech Co., Ltd. reserves the right to make improvements in the products described in this manual at any time without notice. No part of this manual may be reproduced, copied, translated or transmitted in any form or by any means without the prior written permission of Advantech Co., Ltd. Information provided in this manual is intended to be accurate and reliable. However, Advantech Co., Ltd. assumes no responsibility for its use, nor for any infringements of the rights of third parties which may result from its use.

Acknowledgments

PC-LabCard is a trademark of Advantech Co., Ltd. IBM and PC are trademarks of International Business Machines Corporation. MS-DOS and Windows are trademarks of Microsoft Corporation. Intel and Pentium are trademarks of Intel Corporation. All other product names or trademarks are properties of their respective owners.

CE Notification

The EDG-4508+ /4516+ series developed by Advantech Co., Ltd. has passed the CE test for environmental specifications when operated within an industrial enclosure . Therefore, in order to protect the EDG-4508+ / EDG-4516+ modules from being damaged by ESD (Electric Static Discharge), we strongly recommend that the use of CE-compliant industrial enclosure products when using any EDG module.

This manual covers the following models:

- EDG-4508+
- EDG-4516+
- EDG-4508R+
- EDG-4516R+

Part No. 2003450820 3rd Edition

Printed in Taiwan Dec. 2004

Product Warranty (2 years)

Advantech warrants to you, the original purchaser, that each of its products will be free from defects in materials and workmanship for two years from the date of purchase.

This warranty does not apply to any products which have been repaired or altered by persons other than repair personnel authorized by Advantech, or which have been subject to misuse, abuse, accident or improper installation. Advantech assumes no liability under the terms of this warranty as a consequence of such events.

Because of Advantech's high quality-control standards and rigorous testing, most of our customers never need to use our repair service. If an Advantech product is defective, it will be repaired or replaced at no charge during the warranty period. For out-of-warranty repairs, you will be billed according to the cost of replacement materials, service time and freight. Please consult your dealer for more details.

If you think you have a defective product, follow these steps:

1. Collect all the information about the problem encountered. (For example, CPU speed, Advantech products used, other hardware and software used, etc.) Note anything abnormal and list any onscreen messages you get when the problem occurs.
2. Call your dealer and describe the problem. Please have your manual, product, and any helpful information readily available.
3. If your product is diagnosed as defective, obtain an RMA (return merchandise authorization) number from your dealer. This allows us to process your return more quickly.
4. Carefully pack the defective product, a fully-completed Repair and Replacement Order Card and a photocopy proof of purchase date (such as your sales receipt) in a shippable container. A product returned without proof of the purchase date is not eligible for warranty service.
5. Write the RMA number visibly on the outside of the package and ship it prepaid to your dealer.

FCC Class A

This equipment has been tested and found to comply with the limits for a Class A digital device, pursuant to Part 15 of the FCC Rules. These limits are designed to provide reasonable protection against harmful interference when the equipment is operated in a commercial environment. This equipment generates, uses and can radiate radio frequency energy and, if not installed and used in accordance with the instruction manual, may cause harmful interference to radio communications. Operation of this equipment in a residential area is likely to cause harmful interference in which case the user will be required to correct the interference at his own expense.

Technical Support and Assistance

Step 1. Visit the Advantech web site at **www.advantech.com/support** where you can find the latest information about the product.

Step 2. Contact your distributor, sales representative, or Advantech's customer service center for technical support if you need additional assistance. Please have the following information ready before you call:

- Product name and serial number
- Description of your peripheral attachments
- Description of your software (operating system, version, application software, etc.)
- A complete description of the problem
- The exact wording of any error messages

Packing List

Before setting up the system, check that the items listed below are included and in good condition. If any item does not accord with the table, please contact your dealer immediately.

- EDG-4508+ or EDG-4516+ x 1
- CD-ROM for driver and utility x 1
- Rack mount kit, including 2 L-shape metal plates and 8 screws
- Power Cable x 1
- 30 cm Serial Connection Cable x 1
- Rubber Spacer x 4
- Terminal Connector x 1

Contents

Chapter 1 Overview	2
1.1 Introduction	2
1.2 Features.....	2
1.3 Specifications.....	3
1.4 Packing Checklist	3
Chapter 2 Getting Started	6
Figure 2.1: Installation Flow Chart	6
2.1 Understanding the EDG-4508+/4516+	7
2.2 Connecting Hardware	8
Figure 2.2: EDG-4508+/4516+ front panel	8
Figure 2.3: EDG-4508+/4516+ LED Indicator and Connector	8
Table 2.1: EDG-4508+/4516+ LED & Connector Definition	9
Figure 2.4: EDG-4508+/4516+ rear panel	10
2.2.1 Mounting Connection	10
Figure 2.5: Rack Mount	10
2.2.2 Network Connection	11
Figure 2.6: Ethernet Connector	11
2.2.3 Power Supply Connection	11
Figure 2.7: Power Switch and Connector with Fuse	11
2.2.4 Serial Port Connection	11
Figure 2.8: 8 Ports RS-232/485/422 Serial Connector for EDG-4508+	11
Figure 2.9: 16 Ports RS-232/485/422 Serial Connector for EDG-4516+	12
2.2.5 Ordering Information	12
2.3 Installation	13
2.3.1 Install/Uninstall Driver & Utility	13
Chapter 3 Configuration.....	18
3.1 Auto Search	18

3.2	Locating the EDG-4508+/4516+	20
3.3	Device System Configuration.....	21
3.4	Network Configuration.....	22
3.5	Port Configuration	23
3.6	Security Configuration	29
Chapter 4	Port Mapping Utility.....	32
4.1	Overview	32
4.2	Virtual Comport Setting	32
4.3	Inquiring Virtual Comport Setting	35
4.3.1	Upgrading EDG Series's Firmware Download	36
4.3.2	Self Test Function	37
4.3.3	Save the Configuration	40
Chapter 5	Web-Based Configuration.....	42
5.1	Overview	42
5.2	Access Web Page.....	42
5.3	Network Configuration.....	43
5.4	Port Configuration	44
5.5	DI/O Eevnt Configuration	45
5.6	Reset Configuration.....	46
Chapter 6	Console Configuration.....	48
6.1	Overview	48
6.2	Hyper Terminal Connection.....	48
6.3	Command List	50
Chapter 7	Universal Serial Device Gateway.....	58
7.1	EDG-4508+/4516+ Firmware updated procedure.....	58
	Figure 7.1:	59
	Figure 7.2:	59
	Figure 7.3:	60
	Figure 7.4:	60
	Figure 7.5:	61
	Figure 7.6:	61
	Figure 7.7:	62
	Figure 7.8:	62

Figure 7.9:	64
Figure 7.10:	65
Figure 7.11:	65
7.2 Network Architecture and Example Code	66
7.2.1 Polling Network Architecture	67
Figure 7.12:Network Architecture-Polling	67
Figure 7.13:Flow chart-Polling Network	67
7.2.2 Event-handling Network Architecture	69
Figure 7.14:Network architecture: Event-handling	69
Figure 7.15:Flow chart: Event-handling network	69
7.2.3 Peer-to-Peer Network Architecture	71
Figure 7.16:Network architecture: Peer-to-peer	71
Figure 7.17:Flow chart: Peer-to-Peer network	71
Figure 7.18:#1 EDG-4508+U Configuration Utility	72
Figure 7.19:#2 EDG-4508+U Configuration Utility	73
Figure 7.20:Key-in information of #2 EDG-4508+U	74
Figure 7.21:Key-in information of #1 EDG-4508+U	74
Figure 7.22:Communication parameters of #1 EDG-4508+U	75
Figure 7.23:Communication parameters of #2 EDG-4508+U	75
7.3 Web-Based Configuration for EDG-4508+U/4516+U	76
7.3.1 Access web page	76
7.3.2 Network Configuration	77
7.3.3 Port Configuration	78
7.3.4 DI/O Event Configuration	79
7.3.5 Reset Configuration	79
7.4 Console Configuration for EDG-4508+U/4516+U	79
7.4.1 Command List	79

Chapter 8 Event and DI/O Monitoring 86

8.1 Overview	86
8.2 Event and DI/O Monitoring	86
8.2.1 Polling Monitoring	86
8.2.2 Event Monitoring	87
8.2.3 DI Value Inverse Option	88
8.3 Programming I/O	90

Chapter 9 Troubleshooting.....	94
Appendix A	98
A.1 RS-232 Pin Assignment.....	98
A.2 RJ-48 Cable PIN Assignment.....	98

CHAPTER
1

Overview

Chapter 1 Overview

1.1 Introduction

This manual provides the necessary information to use EDG-4508+, EDG-4516+ and the rear-wired versions of these. The Advantech Ethernet Data Gateway series (EDG series) consists of fast and cost-effective data gateways between RS-232/422/485 and Ethernet interfaces.

EDG-4508+ and 4516+ are part of the Ethernet Data Gateway (EDG) family of multiple port modules. They provide reliable and cost-effective network connections for serial devices, allowing users to extend their limited COM ports without changing the architecture of their existing application (s). EDG immediately upgrades users' existing device to the Internet world.

EDG-4508+ and 4516+ provide 8 and 16 serial ports respectively, that can be easily configured. To increase the reliability of systems, EDG-4508+ and EDG-4516+ provide two significant functions:

- Auto-reconnection and IP access control.
- Support for transmission speeds up to 230 kbps (RS-485), meeting today's demand for high-speed data exchanges.

1.2 Features

- Supports 8/16 channels (8 Channels for EDG-4508+, 16 Channels for EDG-4516+)
- Supports RS-232/422/485
- 4 DI, 4 DO for alarm handling
- Redundant power supply (optional)
- Web-based configuration
- Auto-reconnection: automatic connection recovery to network
- LEDs for power status and all ports Tx/Rx monitoring
- Console mode configuration
- Supports front wiring access for EDG-4508+ and EDG-4516+, rear wiring access for EDG-4508R+ and EDG-4516R+

1.3 Specifications

- I/O controller: 16C654 or compatible (auto hardware flow control)
- LAN Speed: 100Base-TX (10/100 Mbps)
- Ethernet Connection: RJ-45
- Serial: RS-232, RS-422 and RS-485
- Serial Connection: RJ-48
- DI/O: programmable 4DI,4DO for extra control
- Signals: TxD, RxD, RTS, CTS, DTR, DSR, DCD, GND
- Speed: 50 ~ 230 kbps
- Data bits: 5, 6, 7, 8
- Stop bits: 1, 1.5, 2
- Parity: none, even, odd, space, mark
- Max. Windows Virtual Port: 255
- OS: Windows 98/NT/2000/XP
- Power requirements: 90 V AC ~ 260 V AC, 47 ~ 63 Hz (optional dual power supply for redundant use)
- Operating temperature: 0° ~ 55° C (32° ~ 131° F)
- Surge protection: 15,000 V ESD

1.4 Packing Checklist

- EDG-4508+ or EDG-4516+ x 1
- CD-ROM for driver and utility x 1
- Rack mount kit, include 2 L-shape metal plates and 8 screws
- Power Cable x 1
- 30cm Serial Connect Cable x 1
- Rubber Spacer x 4
- Terminal Connector x 1

CHAPTER
2

Getting Started

Chapter 2 Getting Started

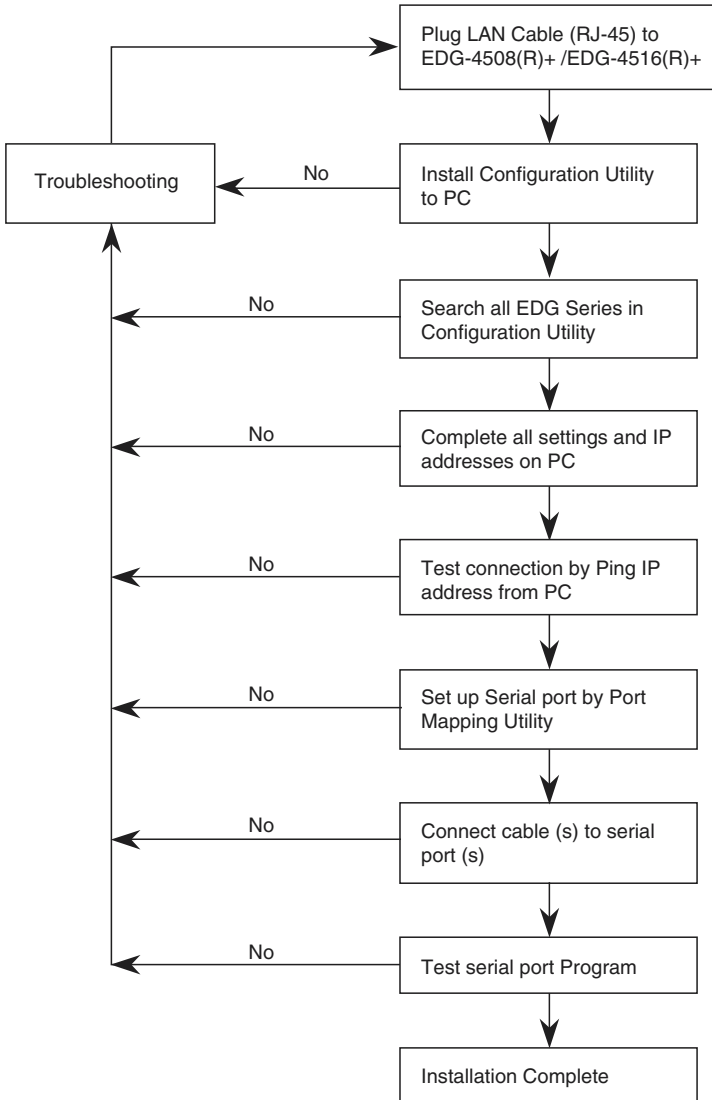

Figure 2.1: Installation Flow Chart

2.1 Understanding EDG-4508+ and EDG-4516+

EDG-4508+ and EDG-4516+ are advanced Ethernet data gateway units. They extend traditional COM ports of a PC to Ethernet access. Through Ethernet networking, users can control and monitor remote serial devices and equipment over LAN or WAN.

Since EDG-4508+ and EDG-4516+ are connected with the TCP/IP protocol, you will have to know fundamental facts about Ethernet networking to get the server setup correctly.

To allow for easier configuration, we provide several system configuration methods such as Configuration Utility, Web Configuration and Console mode Configuration. More details will be available in the following chapters.

2.2 Connecting Hardware

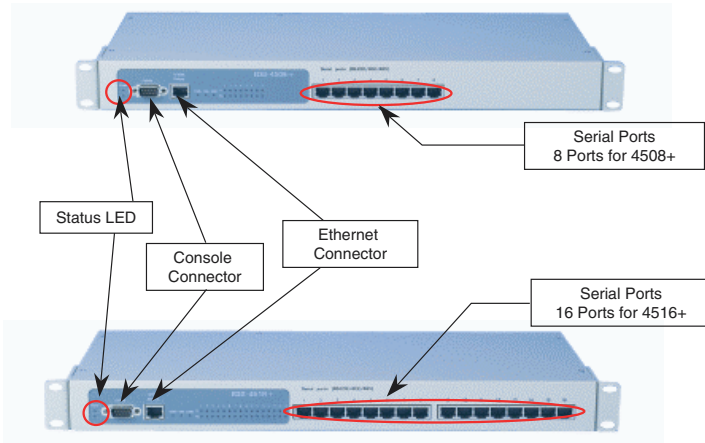

Figure 2.2: EDG-4508+/4516+ Front Panel

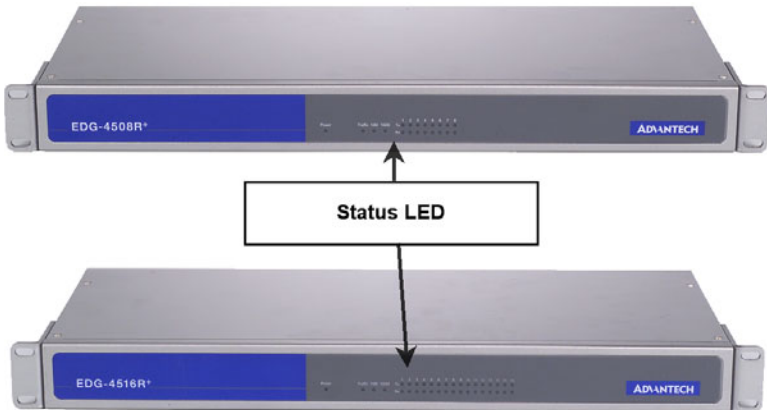

Figure 2.3: EDG-4508R+/4516R+ Front Panel

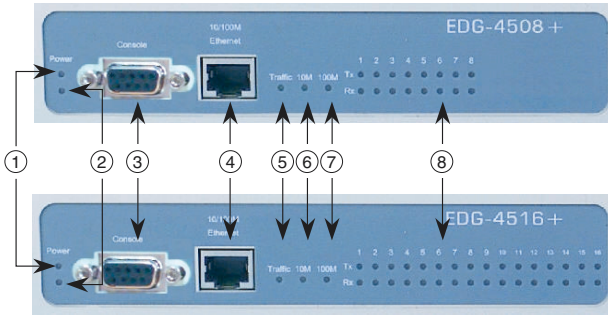

Figure 2.4: EDG-4508+/4516+ LED Indicators and Connectors

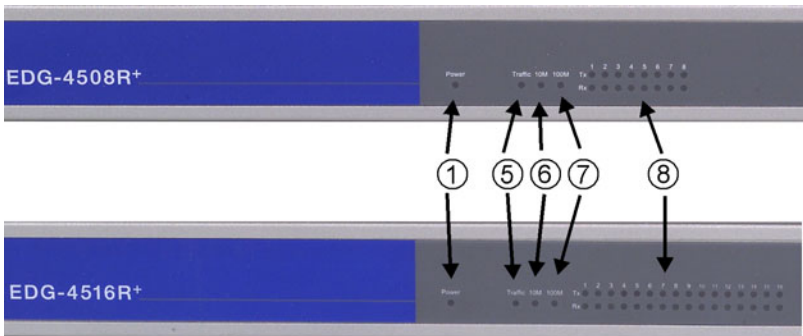

Figure 2.5: EDG-4508R+/4516R+ LED Indicators

Table 2.1: EDG-4508+/4516+ LED & Connector Definitions

Item	LED	Status	Description
①	Status	ON	Power on
		OFF	Power off or no power
		Flash	Status Heart Beat Monitoring
		Steady	Device Locate Function Enable
②	Status	Dual Power Indicator (Optional)	
③	Console	F Type Console connector for Console Configuration Use	
④	Ethernet	RJ-45 Ethernet Connector	
⑤	Traffic (Ethernet)	ON	Ethernet data being received/transmitted
		OFF	No data being received/transmitted
⑥	10M	ON	10 Mbps speed
		OFF	Invalid 10 Mbps network link
⑦	100M	ON	100 Mbps speed
		OFF	Invalid 100 Mbps network link
⑧	Tx (Port N) N = 1~ 8/16	ON	Serial port data being transmitted
		OFF	No data being transmitted
	Rx (Port N) N = 1~8/16	ON	Serial port data being received
		OFF	No data being received

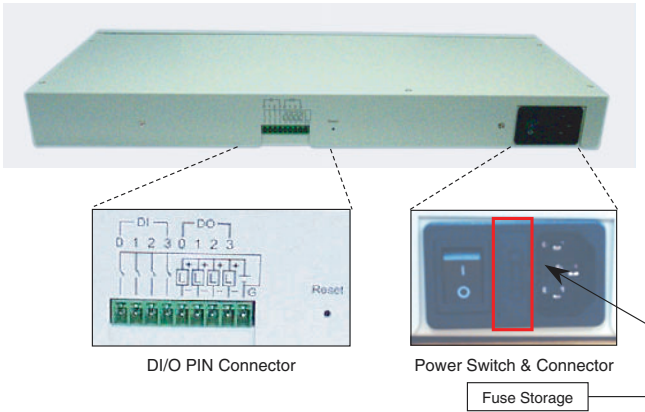

Figure 2.6: EDG-4508+/4516+ Rear Panel

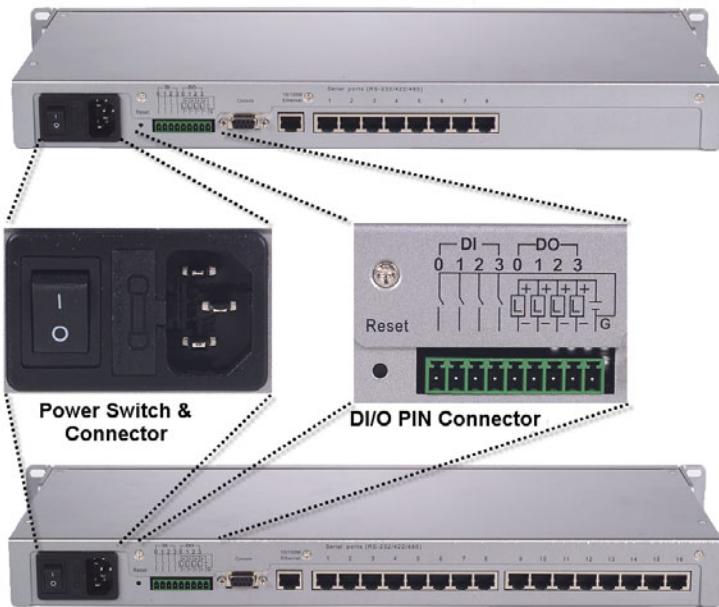

Figure 2.7: EDG-4508R+/4516R+ Rear Panel

2.2.1 Rack Mounting

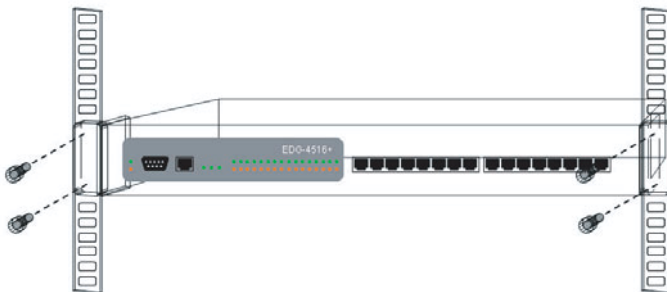

Figure 2.8: Rack Mounting

2.2.2 Network Connection

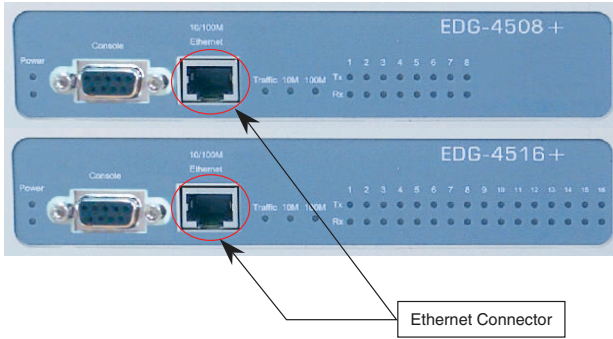

Figure 2.9: Ethernet Connector of EDG-4508+/4516+

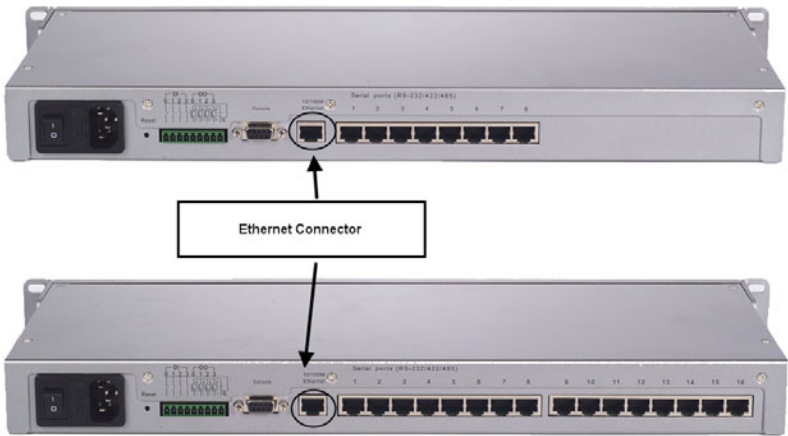

Figure 2.10: Ethernet Connector of EDG-4508R+/4516R+

2.2.3 Power Supply Connection

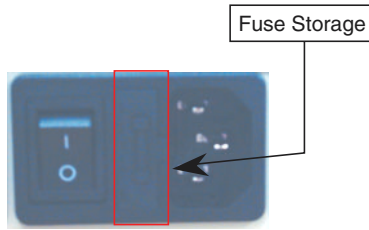

Figure 2.11: Power Switch and Connector with Fuse

2.2.4 Serial Port Connection



Figure 2.12: 8 Ports RS-232/485/422 Serial Connector for EDG-4508+



Figure 2.13: 16 Ports RS-232/485/422 Serial Connector for EDG-4516+

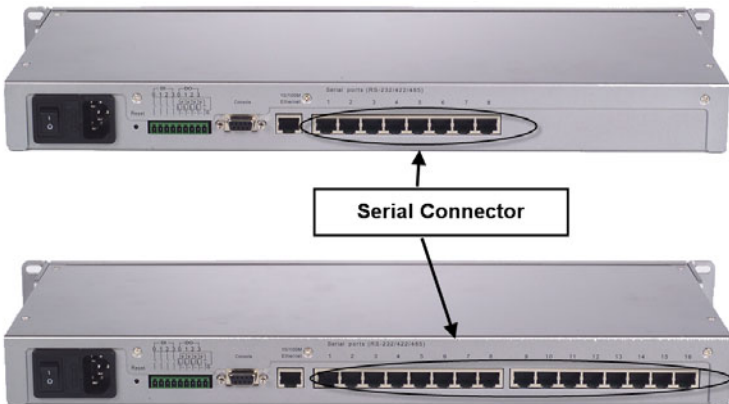

Figure 2.14: RS-232/485/422 Serial Connectors for EDG-4508R+/4516R+

2.2.5 Ordering Information

- **EDG-4504**
4-port Ethernet to RS-232/422/485 Data Gateway
- **EDG-4508+**
8-port Ethernet to RS-232/422/485 Data Gateway for front wiring access
- **EDG-4508R+**
8 port Ethernet to RS-232/422/485 Data Gateway for rear wiring access
- **EDG-4516+**
16-port Ethernet to RS-232/422/485 Data Gateway for front wiring access
- **EDG-4516R+**
15-port Ethernet to RS-232/422/485 Data Gateway for rear wiring access
- **Communication Cable RJ48 to DB9 30cm (1701090300)**
30 cm RJ48 to DB9 M-Type RS-232/422/485 Cable
- **Communication Cable RJ48 to DB9 100cm (1703091001)**
100 cm RJ48 to DB9 M-Type RS-232/422/485 Cable
- **Terminal Connector (1654909900)**
Terminal Connector for Test Usage

2.3 Installation

2.3.1 Install/Uninstall Driver & Utility

In order to use a PC and an Ethernet network to control serial devices connected to EDG-4508+/4516+, you must first have a host running Windows 98/NT/2000/XP. This type of application also requires the host to have an Ethernet card and the TCP/IP protocol installed. The following are the required steps for installing EDG-4508+/4516+.

1. Insert the Advantech industrial communication CD-ROM into the drive (e.g. D:\) on the host PC. Change the host computer's default drive from C: to D:
2. Use your Windows Explorer or the Windows Run command to execute the Setup program (the path for the Setup program on the CD-ROM should be D:\ EDG-4508(R)+_4516(R)+COMPPortUtility\SETUP.EXE, if your default CD-ROM drive is D:).
3. Upon executing the setup program, the Welcome Dialog Box will pop-up. Press the "Next" button to continue.

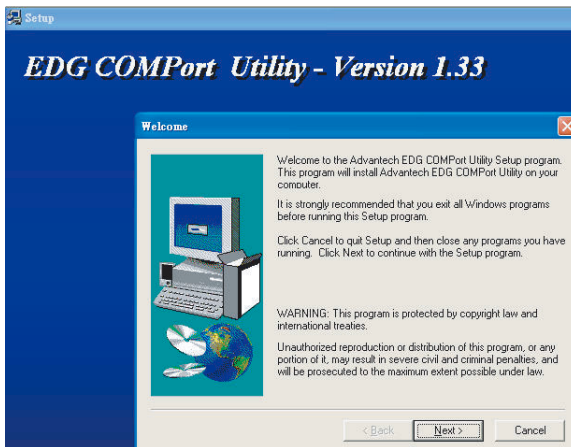

- Carefully read the Software License Agreement, and press "Next" to continue.

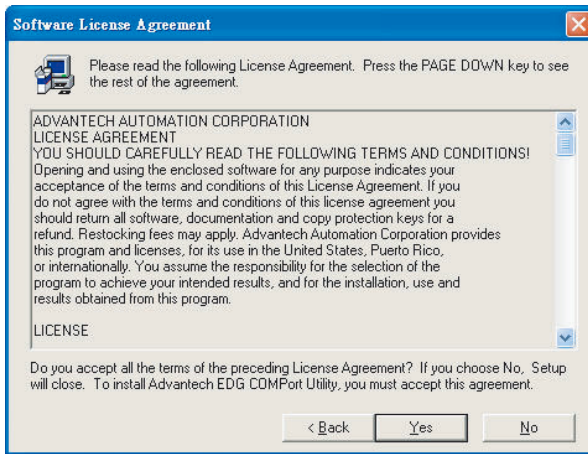

- The Setup program will specify a default installation path, C:\Program Files\Advantech\EDG COMPort Utility.

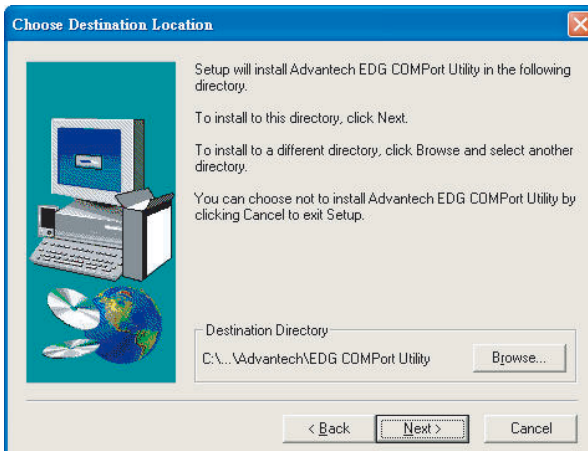

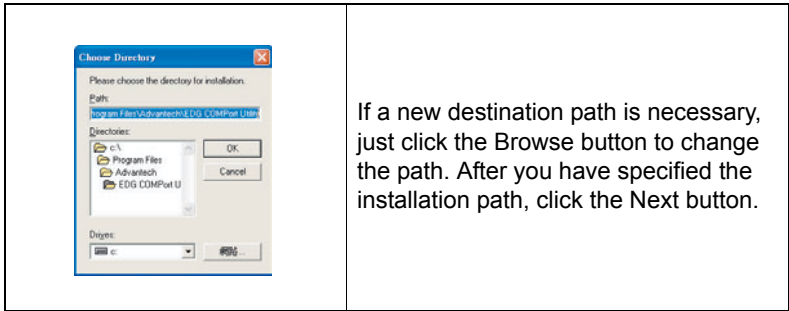

6. In this step, you may select a specific program folder or just use the default setting and press "Next".

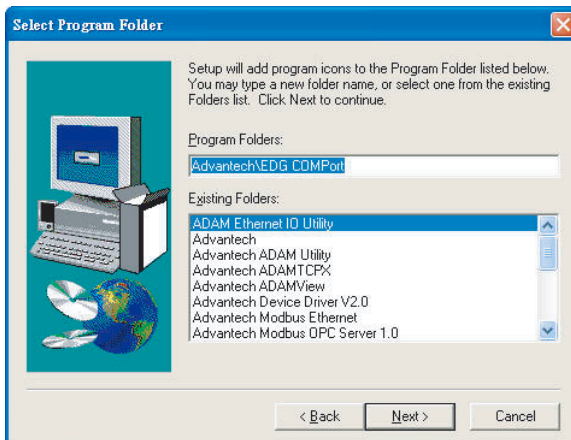

7. After setup has copied all program files to your computer, click the Finish button to finish the installation.

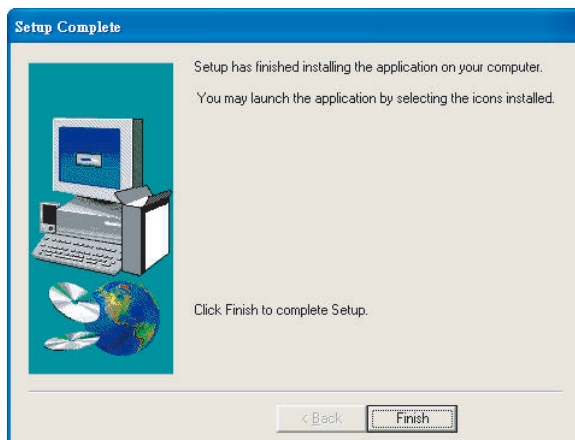

CHAPTER
3

Configuration

Chapter 3 Configuration

3.1 Auto Search

EDG-4508+ and EDG-4516+ provides an easy-to-use configuration utility to configure your Ethernet Data Gateway Device through an Ethernet connection. The utility provides an auto-search function to show your device(s) by simply executing the configuration utility program from the Start Menu as follows.

Start Menu --> All Program --> Advantech --> EDG COMPort

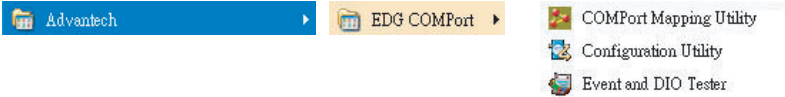

This EDG configuration utility will automatically search all the EDG devices on the network and show them on the left side of the utility. From here you can easily configure various parameters for TCP/IP configuration. (In this example, the system finds the Ethernet Data Gateway device for ADAM-4570 & EDG-4516+ in a local network)

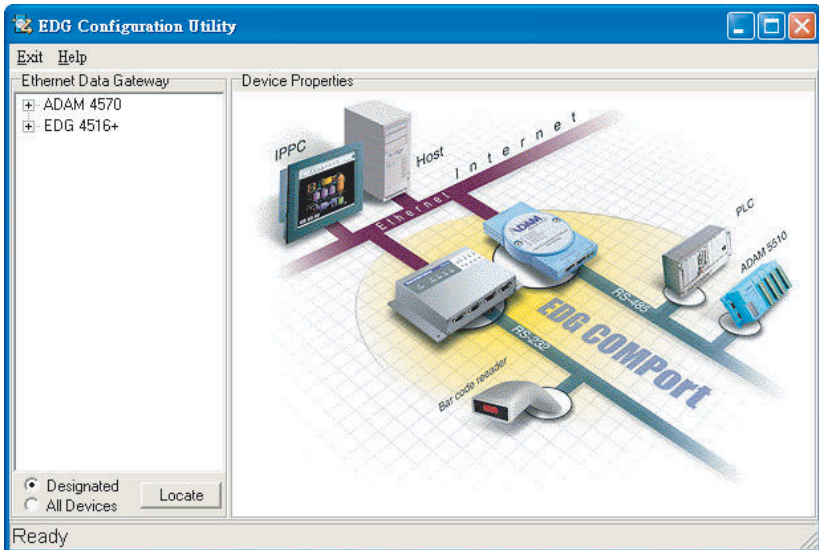

You can click on the device name to show the features of the specific device. Click on the "+" before the model name (e.g. EDG-4516+), and the utility will expand the tree structure to show the individual device name.

For Example, EDG Configuration Utility shows "ADAM000102030415" after expanding the tree structure.

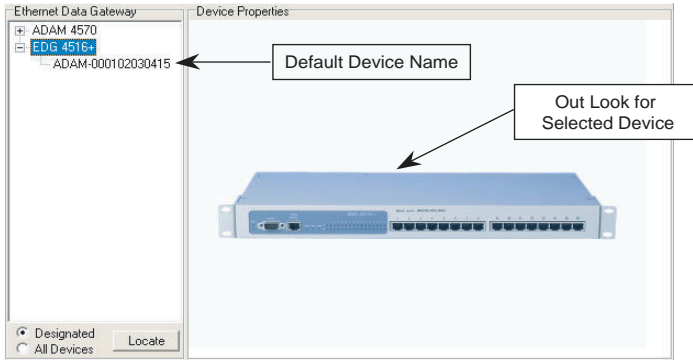

Note *When you run the EDG configuration utility for the first time, the default device name is "MAC ID". In this case, the device name "ADAM-000102030415" means the device "MAC ID" is "00 01 02 03 04 15". You can change the default device name in System Tag of Device Properties.*

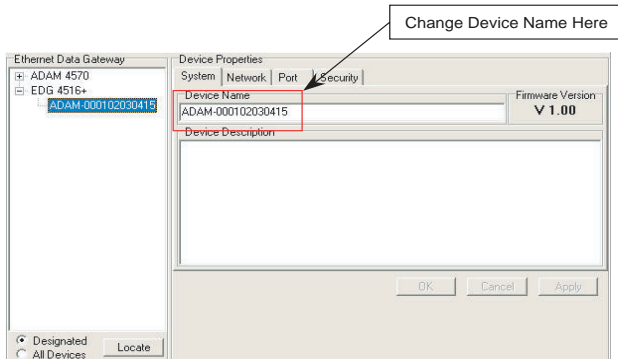

3.2 Locating EDG-4508+/4516+

The configuration utility provides a "Locate" function to assist you in finding a specific device. You can select the EDG Series as a group or just select one specific module, e.g. EDG-4508+ or EDG-4516+.

There are two different options for the Locate function

- (1) Designated: locates a specific device for you.
 1. Select "Designated" and click "Locate"
 2. The "Status" LED will remain steady for 8 minutes.
 3. If you choose another device and click on "Locate", the "Status" LED of the previous choice will return to the heart beat monitoring mode.
- (2) All Devices: To locate all devices for the system.
 1. Select "All Devices" and click "Locate"
 2. All "Status" LED devices will remain steady for 8 minutes.
 3. 8 minutes later or when someone enables the "Designated" Locate function, the "Status" LED will return to its default heart beat monitoring.

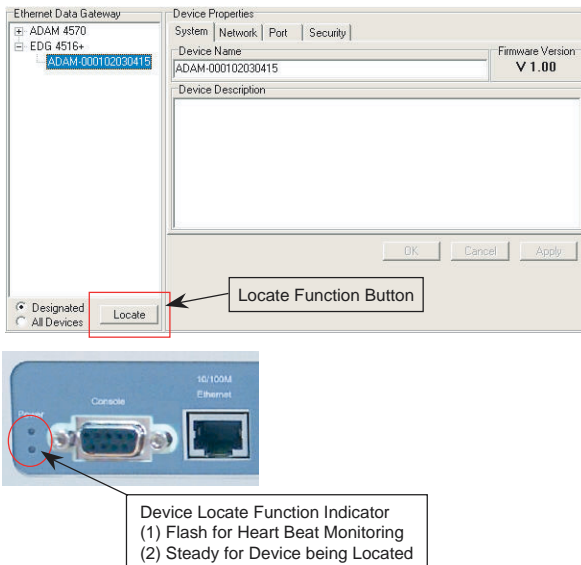

3.3 Device System Configuration

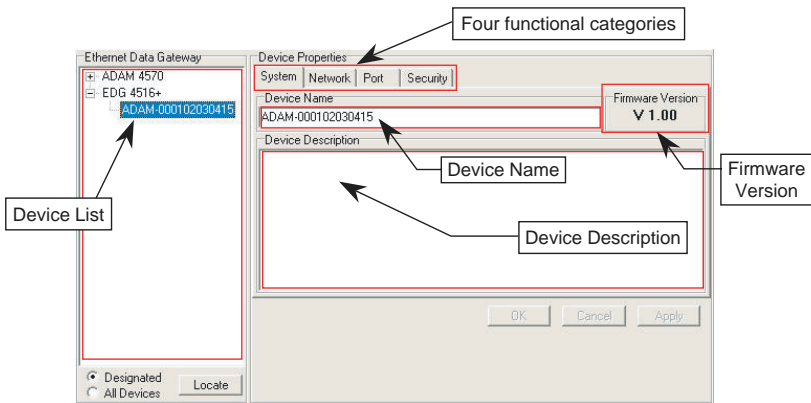

The configuration utility only searches for EDG-4508+ and EDG-4516+ on the local network, and cannot search beyond a router or gateway. Make sure that the EDG-4508+ or EDG-4516+ you want to monitor resides in the same local network segment as the host PC.

Ethernet Data Gateway

In this column, you will find a list of EDG products if you use the configuration utility to auto-search.

Device Name

The configuration utility provides a default name to distinguish the different EDG devices from each other. You can update the default device name based on your application. Please note that names are restricted to 128 characters, and it is usually best to choose a name you can remember.

Device Description

This field records the function, application and other information for each EDG device in more detail for easy management and maintenance. You can describe in your own words.

Firmware Version

In this field, the configuration utility presents the firmware version of the EDG Series (e.g. V 1.10). You might need to refer to the firmware version to determine what functions are available on the EDG device. For problems related to firmware version, please provide the firmware version number to our Customer Service.

3.4 Network Configuration

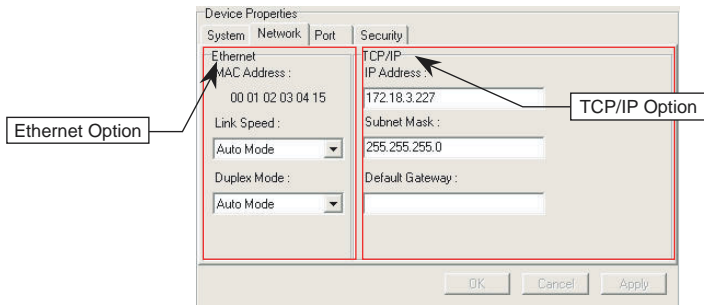

Ethernet Option

MAC Address

This does not need configuration.

Link Speed

This function will show the current linking speed to be either 10Mbps or 100Mbps. However, the utility will auto-detect the current transmission speed on the network segment and set the transmission speed for the device accordingly.

Duplex Mode

The utility will detect the current transmission mode (half-duplex or full-duplex) on the network segment, and set the transmission mode for the device accordingly.

TCP/IP Option

IP address, Subnet Mask, Default Gateway

The IP address identifies your EDG device on the global network. Each EDG device has the same default IP address 10.0.0.1. Obtain a specific IP address from your network administrator and then configure each EDG device with an individual IP address, related Subnet Mask and Gateway Setting.

Note *EDG devices do not support auto IP address configured by DHCP server.*

3.5 Port Configuration

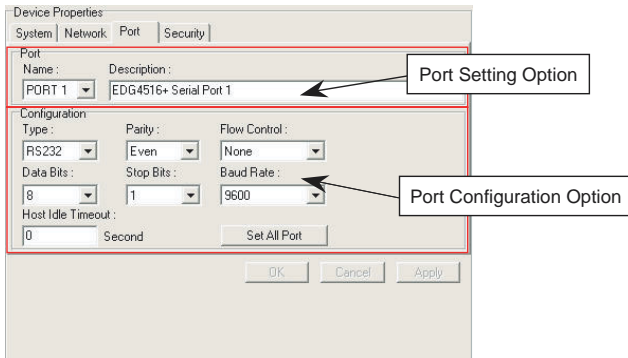

Port Setting

You can modify the description for individual port settings in the Port Setting Option.

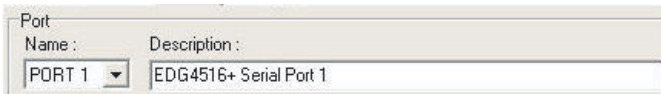

Name

Show Port Name

8 Ports for EDG-4508+

16 Ports for EDG-4516+

Description

Show individual description for each port.

You can change the description for your connected module to identify the connection from EDG Configuration Utility.

Port Configuration

You can modify port configuration in this Configuration Option such as Type, Parity, Flow Control, Data Bits, Stop Bits, Baud Rate and Host Idle Timeout.

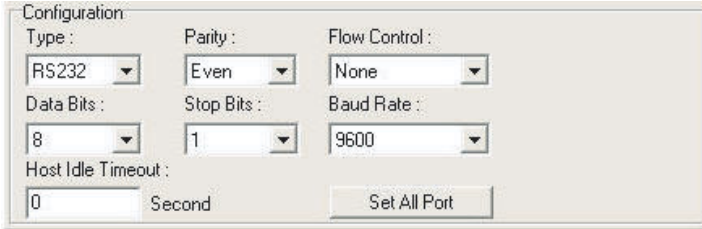

Configuration

Type :	Parity :	Flow Control :
RS232	Even	None
Data Bits :	Stop Bits :	Baud Rate :
8	1	9600
Host Idle Timeout :		
0	Second	Set All Port

Type

Serial Port Type

You can change the connection type for your module to: RS-232, RS-422 or RS-485.

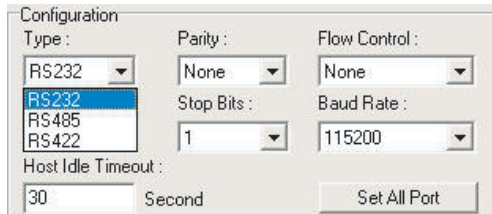

Configuration

Type :	Parity :	Flow Control :
RS232	None	None
RS485	Stop Bits :	Baud Rate :
RS422	1	115200
Host Idle Timeout :		
30	Second	Set All Port

Parity

Parity Check Type

You can follow the parity check type of your connected module. The following types are provided.

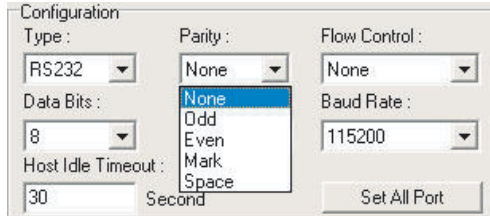

The screenshot shows a 'Configuration' dialog box with the following fields and values:

- Type: RS232
- Parity: None (dropdown menu is open showing options: None, Odd, Even, Mark, Space)
- Flow Control: None
- Data Bits: 8
- Baud Rate: 115200
- Host Idle Timeout: 30 Second
- Set All Port button

- None
- Odd
- Even
- Mark
- Space

Flow Control

Flow Control Type

You can choose the flow control type of your connected module. The following types are available.

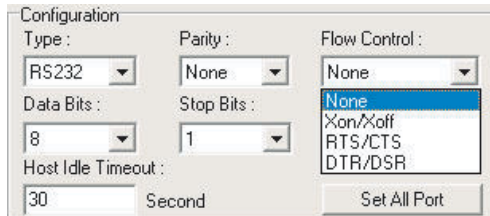

The screenshot shows a 'Configuration' dialog box with the following fields and values:

- Type: RS232
- Parity: None
- Flow Control: None (dropdown menu is open showing options: None, Xon/Xoff, RTS/CTS, DTR/DSR)
- Data Bits: 8
- Stop Bits: 1
- Host Idle Timeout: 30 Second
- Set All Port button

- None
- Xon/Xoff
- RTS/CTS
- DTR/DSR

Data Bits

Data Bits Type

You can choose the number of Data Bits of your connected module to be 5, 6, 7 or 8.

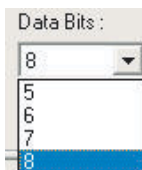

Stop Bits

Stop Bits Type

You can choose 1, 1.5 or 2 Stop Bits for your connected module



Baud Rate

Flow Control Type

You can choose the Baud Rate of your connected module. The following rates are available:



- 7,200
- 9,600
- 14,400
- 19,200
- 38,400
- 57,600
- 115,200
- 230,400

* Set All Port

Set All Port

The 'Set All Port' function helps you set all serial ports at one time. All you need is to set one port and click the "Set All Port" button. The other ports will then follow the first port that you have set up. This is faster than setting up 8 ports (4508+) or 16 ports (4516+) with the same settings.

Host Idle Timeout

The 'Host Idle Timeout' setting monitors the connection between the host and the device. If the 'Host Idle Timeout' setting time is reached, the device will release the resources allocated to the port mapping. This prevents a stalled host from affecting the connected device. .

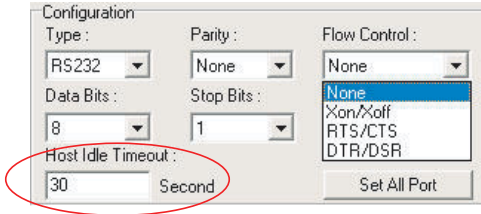

Note *Host Idle Timeout and Auto Reconnection Function Detail*

Host Provide
Auto Reconnection Function



Ethernet



EDG Device Support
Host Idle Timeout Detect Function

Auto Reconnection

An auto reconnection function is provided by the host. Under certain circumstances (such as: Ethernet connection failure, device power down or other device issues) the auto reconnection function will try to reconnect the assigned device.

3.6 Security Configuration

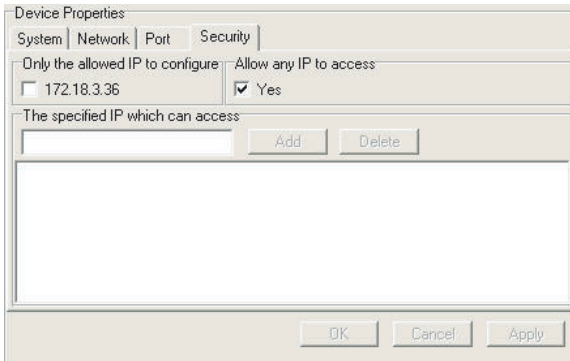

For security reasons, you are highly recommended to use EDG's security features. The EDG configuration utility provides security functions for the network structure.

Only configure the allowed IP

The system will auto detect the IP address for the currently connected computer. If you enable this function, only your local computer can access this EDG Device.

*If you use Dynamic IP Assignment by the DHCP Server, we suggest that this function is not enabled.

Allow any IP to access

If you enable this function, any IP address can access your device and there is **no access restriction**.

Specified IP can access EDG device

You can assign a specific IP address that have access to the EDG device. Assign the IP address and click on "Add" to add a specified IP or choose the IP address list below and click on "Delete" to remove the IP from the access list.

CHAPTER
4

Port Mapping Utility

Chapter 4 Port Mapping Utility

4.1 Overview

The purpose of the port mapping utility is to help you manage all ports on one Windows 98/NT/2000/ME/XP platform. The utility displays three types of ports: used ports, unused ports and EDG ports. Please follow the Virtual COM port setting steps.

4.2 Virtual COM Port Settings

1. Click "+" at "Unused Ports" to expand the unused port lists, and select the port that you want to configure.

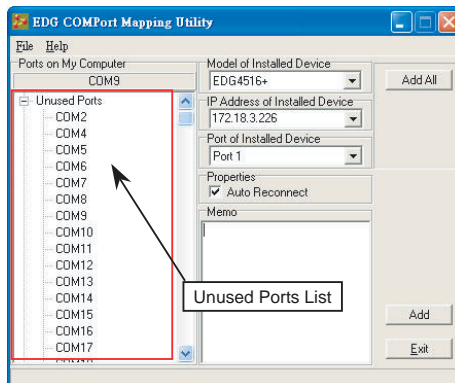
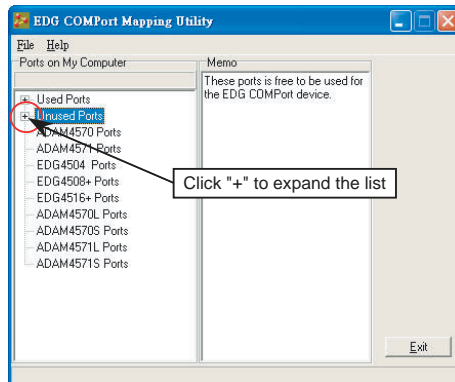

2. Click the ADD button to assign a COM port to an EDG device.

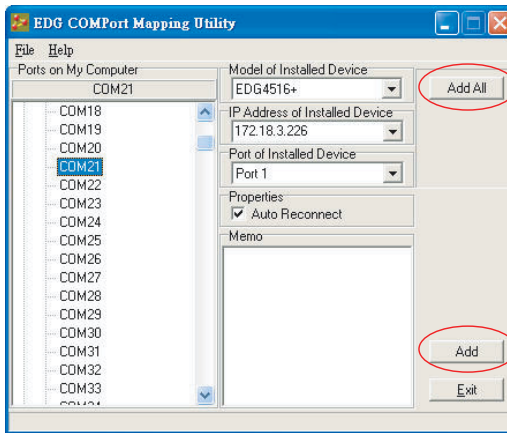

Module of Installed Device

You can choose between all connected EDG devices. In this example, "EDG-4516+" was chosen.

IP Address of Installed Device

Enter the IP address you assigned in chapter 3.4.

Port of Installed Device

Choose the port where you want to setup: 8 ports for EDG-4508+ and 16 ports for EDG-4516+.

Properties (Auto Reconnect Function)

Sometimes, the system may crash because the EDG device is interrupted or powered-off by accident. In such a situation, the host PC need to reconnect to the EDG device automatically.

EDG devices provide an "Auto-reconnect" function for this purpose. If the EDG device loses the connection to its host, the driver will automatically try to re-establish the connection. When the connection is working again, the host PC's commands will be automatically received by the EDG Series again. Reconfiguration is not necessary, so this function enhances the reliability of the system.

Memo

You can add a description to the port setting if necessary.

Add

Add

Click here to add a single port setting to your specification.

Add All

Add All

You can assign all ports to follow current settings by clicking the "Add All" button. This is more convenient than adding ports individually. For this example, we have selected COM21 and made all necessary settings for Port 1 of EDG-4516+. After clicking on the "Add All" button, the COM Port Mapping Utility will assign the COM21 ~ COM36 mapping to Port 1 ~ Port 16.

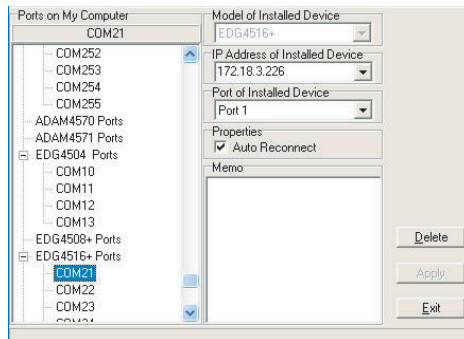

(COM21 is mapping to Port 1 of EDG-4516+)

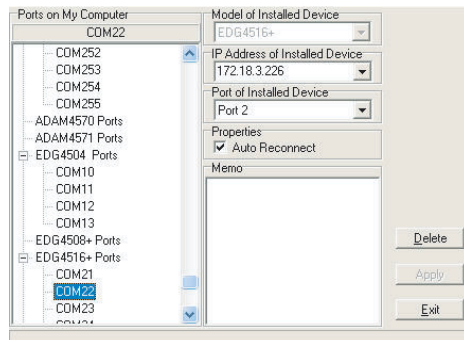

(COM22 is mapping to Port 2 of EDG-4516+)

Note

If you assigned a different COM port to the same EDG series module port, the following dialog box will remind you.



4.3 Inquiring Virtual COM Port Setting

You can check the virtual COM port setting by clicking on the EDG device's ports. In this case, COM11 is assigned to Port 1 of EDG-4516+.

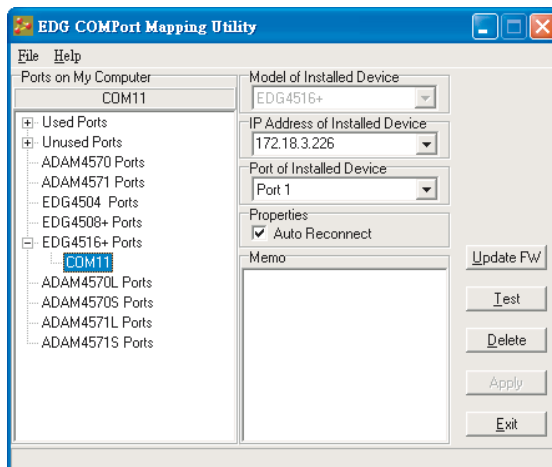

4.3.1 Updating EDG Firmware

Updating Firmware

Advantech continually upgrades its firmware. You can use the download function located on the Port Mapping utility to carry out the upgrade procedure. Please access Advantech's web site at <http://www.advantech.com> to download the required computer file and then follow these instructions.

1. Click on the Update FW icon in the toolbar.
2. Locate and then select the filename of the firmware that you have downloaded.

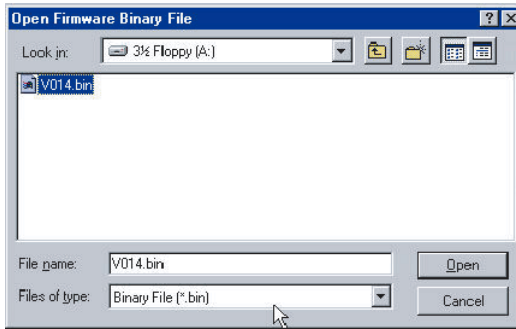

3. After the firmware has been downloaded into the EDG device, click the Reboot button.

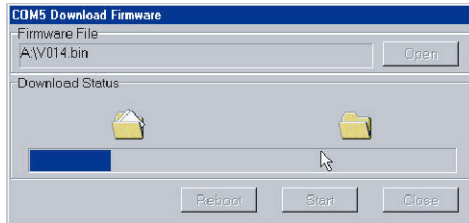

4. Restart the host PC so that it can recognize the updated firmware on the EDG device.

Note *After clicking the Reboot button, the configuration utility will **not** reboot the EDG device.*

4.3.2 Self Test Function

Test _Test

The purpose of this test is to confirm that the communication from the host PC to the EDG device is OK. When the test is selected, an external test will be performed to check that the connection signal between each port is working properly. For this test, you will need to connect each port to a Loopback tester. Refer to the following chart for specifications of this Loopback tester. The Loopback test only applies to RS-232 mode. It is divided in two parts: Signal test and Communication Parameters test.

1. Click on the Test button in the Port Mapping utility. A message will confirm that the loopback connector have already been connected with the EDG COM port. If ready, click the Start button to start the test.

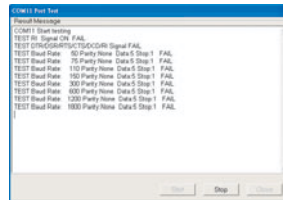
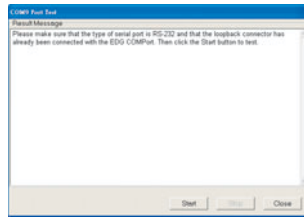
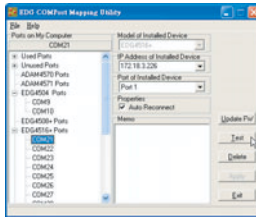

Test Fail (Without Loopback Connector)

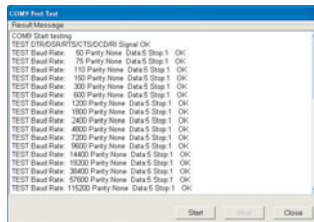

Test ok

Signal Test

- RTS->CTS: Checks the RTS and CTS signals between two ports.
- DTR->RI: Checks the DTR and RI signals between two ports.
- DTR->DSR: Checks the DTR and DSR signals between two ports.
- DTR->DCD: Checks the DTR and DCD signals between two ports.

Communication Parameters Test

- Baud rate: From 50 bps to 230 kbps
 - Data bits: 5, 6, 7, 8
 - Stop bits: 1, 1.5, 2
 - Parity: odd, even, none, space, mark
2. Click the OK button to return to the port mapping window. All the ports in the EDG Series are tested ok.

Delete

Delete

You can delete Port Mapping Setting by clicking the Delete button.

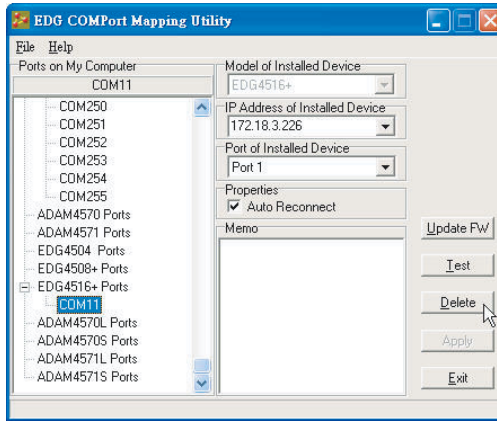

Apply

Apply

If any changes are made, please press the Apply button to confirm your modifications.

Exit

Exit

If you want to quit the utility, please click on the Exit button. If any changes are made in the COM Port Mapping setting, the system reboot requirement will show up. Please reboot your system to make sure your changes will work.

4.3.3 Save the Configuration

If you want to save or recover the configuration, you can select the "Import/Export" items.

1. a. Select "File"
- b. Select "Import" or "Export".

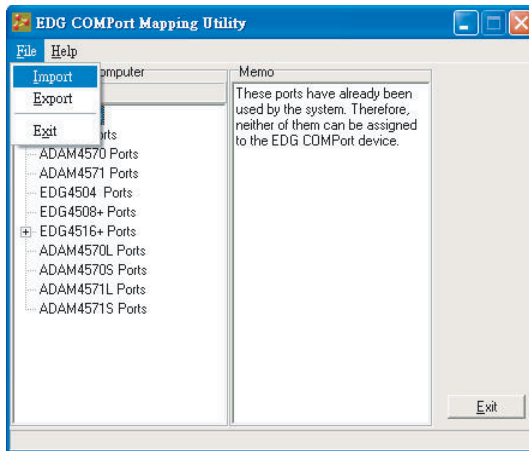

2. Save or open the configurations

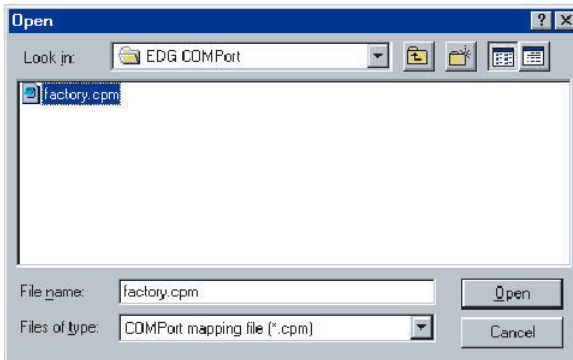

CHAPTER
5

**Web-Based
Configuration**

Chapter 5 Web-Based Configuration

5.1 Overview

EDG devices can be configured through a web interface. By using a standard web browser, the same procedure as with the Windows configuration utility can be used. In the browser's address field, enter the IP Address of your EDG device. The default IP setting is 10.0.0.1, but you should use the IP which you have previously assigned for this device. Once the IP is entered, you will be presented with the following windows.

5.2 Access Web Page

Step 1. Enter ID and Password

The default ID *and* password is **root**, key this into both fields..

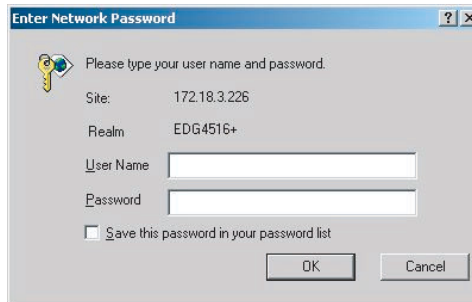

Step 2. Web Based Configuration Welcome

After authorization, the main configuration menu will be displayed.

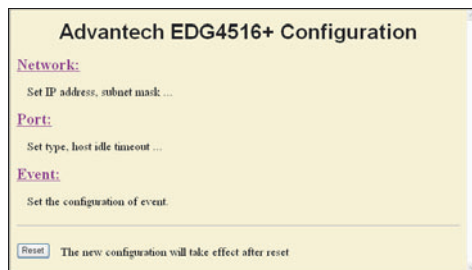

5.3 Network Configuration

Under network configuration, there are: MAC address, IP Address, Subnet Mask and Default Gateway. Enter the corresponding values for your network environment.

Step 1. Enter IP Address, Subnet Mask and Default Gateway

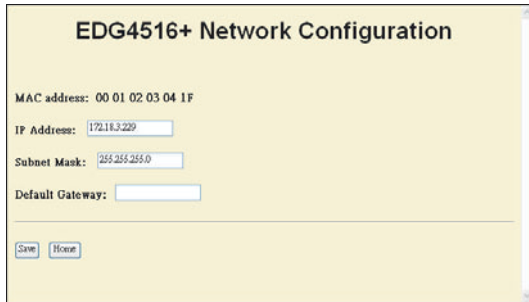

The screenshot shows a web browser window titled "EDG4516+ Network Configuration". The page has a light yellow background. At the top, it displays "MAC address: 00 01 02 03 04 1F". Below this, there are four input fields: "IP Address:" with the value "172.18.3.229", "Subnet Mask:" with the value "255.255.255.0", and "Default Gateway:" which is empty. At the bottom left, there are two buttons: "Save" and "Home".

Step 2. Press 'Save' to store the settings.

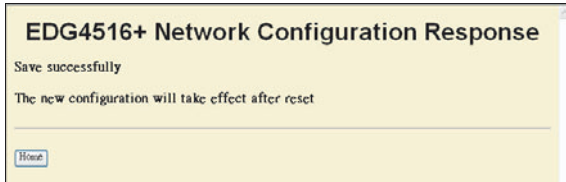

The screenshot shows a web browser window titled "EDG4516+ Network Configuration Response". The page has a light yellow background. It displays the text "Save successfully" and "The new configuration will take effect after reset". At the bottom left, there is a "Home" button.

Note *All new configurations will take effect after reset. The reset function is located on the main menu of the Web Configuration.*

5.4 Port Configuration

Under port configuration, you can assign the type and host idle timeout for individual ports.

Note *EDG-4508+ and EDG-4516+ provide RS-232 / RS-4852 / RS-422.*

EDG4516+ Port Configuration

	Type	Host Idle Timeout
Port 1	RS-422	30
Port 2	RS-422	30
Port 3	RS-485	30
Port 4	RS-232	30
Port 5	RS-232	30
Port 6	RS-232	30
Port 7	RS-232	30
Port 8	RS-232	30
Port 9	RS-232	30
Port 10	RS-232	30
Port 11	RS-232	30
Port 12	RS-232	30
Port 13	RS-232	30
Port 14	RS-422	30
Port 15	RS-422	30
Port 16	RS-422	30

EDG4516+ Port Configuration Response

Save successfully

The new configuration will take effect after reset

Note *The Host Time Out function is similar to the one in the Configuration Utility.*

5.5 DI/O Event Configuration

In event configuration, you can assign an DI event by enabling the check box and choosing the optimized action mode, Server IP and TCP Port for the active event.

EDG4516+ Event Configuration

	DI 0	DI 1	DI 2	DI 3	Action	Server	
Event 1	<input checked="" type="checkbox"/>	<input checked="" type="checkbox"/>	<input checked="" type="checkbox"/>	<input checked="" type="checkbox"/>	CHG	IP: 172.18.3.13	TCP Port: 5000
Event 2	<input type="checkbox"/>	<input type="checkbox"/>	<input type="checkbox"/>	<input type="checkbox"/>	L2H	IP:	TCP Port:
Event 3	<input type="checkbox"/>	<input type="checkbox"/>	<input type="checkbox"/>	<input type="checkbox"/>	L2H	IP:	TCP Port:
Event 4	<input type="checkbox"/>	<input type="checkbox"/>	<input type="checkbox"/>	<input type="checkbox"/>	L2H	IP:	TCP Port:

DI value inverse

DI 0, DI 1, DI 2, DI 3 Options for Event 1 will be activated when any one of DI signal meets the Action option. The event will be monitored on the Server and port of your assignment.

EDG4516+ Event Configuration Response

Save successfully

The new configuration will take effect after reset

<div style="border: 1px solid black; padding: 2px;"> <p style="text-align: center; margin: 0;">Action</p> <p style="margin: 0;">CHG</p> <p style="margin: 0;">L2H</p> <p style="margin: 0;">H2L</p> <p style="margin: 0; background-color: #007bff; color: white; text-align: center;">CHG</p> </div>	<p>Action Description</p> <p>L2H: Low to High</p> <p>H2L: High to Low</p> <p>CHG: Change</p>
--	--

5.6 Reset Configuration

All configurations will take effect after this reset step. Press the reset button and the system will give a reset response. It will take a few seconds to reconnect with the new values.

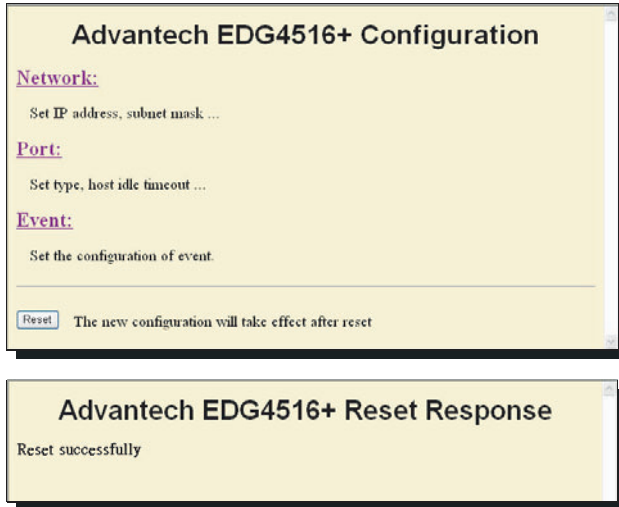

CHAPTER
6

Console Configuration

Chapter 6 Console Configuration

6.1 Overview

The purpose of the Console Configuration is to help you manage your device in console mode. One of the main functions of the console mode is to change the web configuration login password. You can use terminal software like Hyper Terminal, Telix and other related terminal software.

6.2 Hyper Terminal Connection

Step 1. Connecting the cable

You can connect to the EDG device's console port with a RS-232 DB9 M-type communication cable, with the other end connecting to the host's serial port. Make sure the connection is OK and then run the Hyper Terminal Program on your host.

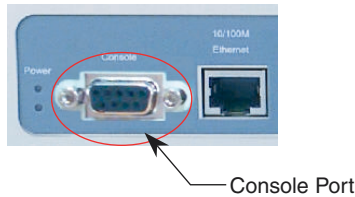

Step 2. Creating a new connection

You can create a new connection and assign a connection name for the console configuration.

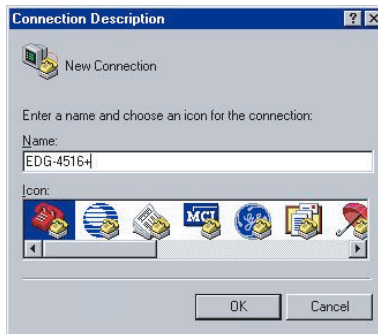

Step 3. Selecting a COM Port

Confirm that the console configuration works ok.



Step 4. COM Port Setting

To connect the EDG series for console configuration, the port setting should match the EDG series' default setting.

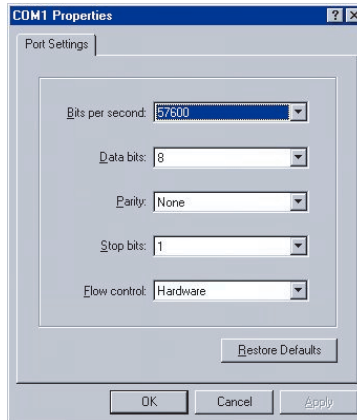

Console Configuration Default Setting

Baud Rate: 57600

Data Bits: 8

Parity: None

Stop bits: 1

Flow control: Hardware.

Step 5. Connecting Successfully

After connecting the device in console mode, you can simply type the "Help" command to show the Supported Command Lists

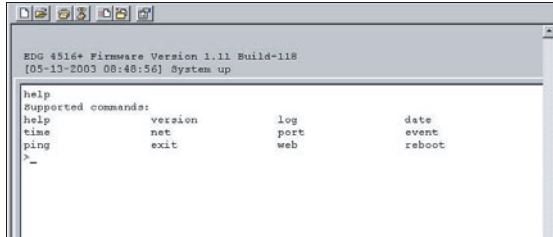

```
EDG 4516+ Firmware Version 1.11 Build-118
[05-13-2003 08:48:56] System up

help
supported commands:
help          version          log          date
time         net             port        event
ping         exit           web         reboot
>_
```

6.3 Command List

Command	Function
version	Displays the current firmware version
log	Displays the log file
date	Displays or sets the date
time	Displays or sets the time
net	Displays the net configuration
port	Displays the status of port(s)
event	Displays the configuration of event(s)
ping	Sends ICMP ECHO_REQUEST packets to network hosts
exit	Terminates shell session
web	Sets web password or saves web configuration
reboot	Reboots the system

- **version**

[Usage] version

[Function] displays the current firmware version

>version

Current version of firmware is 1.11-1.11

- **log**
 [Usage] log
 [Function] displays log file
 >log
 [05-09-2003 17:01:17] System up

- **date: displays or sets the date**
 [Usage] date
 [Function] displays the date
 >date
 Current date is 05-09-2003
 [Usage] date [mm-dd-yy [dse]]
 [Function] sets the date
 >date 06-09-03
 >date
 > Current date is 06-09-2003

- **time: displays or sets the time**
 [Usage] time
 [Function] displays the configuration
 >time
 Current time is 17:17:30

 [Usage] time [hh.mm.ss]
 [Function] sets the time
 >time 17:17:50
 >time
 Current time is 17:17:55

- **net**

[Usage] net

[Function] displays the configuration of net

>net

Current net is ip 172.18.3.226 gw 0.0.0.0 netmask 255.255.255.0

[Usage] net set ip d.d.d.d gw d.d.d.d netmask d.d.d.d

[Function] sets the configuration of net

>net set ip 172.18.3.227 gw 0.0.0.0 netmask 255.255.255.0

>net

Current net is ip 172.18.3.227 gw 0.0.0.0 netmask 255.255.255.0

[USAGE] net save

[FUNCTION] saves the configuration of net to system

Note *You should use the net save command to activate the changes.*

- **port**

[USAGE] port [nn | all]
[FUNCTION] displays the status of port(s)
>port all

The Port01 is type 422, idletime 30, idle
The Port02 is type 232, idletime 30, idle
The Port03 is type 232, idletime 30, idle
The Port04 is type 232, idletime 30, idle
The Port05 is type 232, idletime 30, idle
The Port06 is type 232, idletime 30, idle
The Port07 is type 232, idletime 30, idle
The Port08 is type 232, idletime 30, idle
The Port09 is type 232, idletime 30, idle
The Port10 is type 232, idletime 30, idle
The Port11 is type 232, idletime 30, idle
The Port12 is type 232, idletime 30, idle
The Port13 is type 232, idletime 30, idle
The Port14 is type 422, idletime 30, idle
The Port15 is type 422, idletime 30, idle
The Port16 is type 422, idletime 30, idle

[USAGE] port [nn | all] type [232|422|485]
[FUNCTION] sets the type of port(s)
>port 3 type 485
>port 3
The Port03 is type 485, idletime 30, idle

[USAGE] port [nn | all] idletime [0 - 4095]
[FUNCTION] sets the idle timeout of port(s)
>port 3 idletime 45
>port 3
The Port03 is type 485, idletime 45, idle

[USAGE] port save
[FUNCTION] saves the configuration of port to system

Note *You should use the net save command to activate the changes.*

- **event**

[USAGE] event [nn | all]

[FUNCTION] displays the configuration of event(s)

[USAGE] event nn iomap xx action [L2H|H2L|CHG] server d.d.d.d:d

[FUNCTION] sets the configuration of event

[USAGE] event [nn | all] clear

[FUNCTION] clears the configuration of event

>event 2 iomap f action L2H server 172.18.3.58:503

>event 2

The Event2 is iomap f action L2H server 172.18.3.58:503

>event 2 clear

>event all

The Event1 is iomap f action CHG server 172.18.3.58:502

The Event2 is disable

The Event3 is disable

The Event4 is disable

The inverse of DI value is off

[USAGE] event diinv [0|1]

[FUNCTION] sets the inverse of DI value on/off

>event diinv 1

>event all

The Event1 is iomap f action CHG server 172.18.3.58:502

The Event2 is disable

The Event3 is disable

The Event4 is disable

The inverse of DI value is on

>event diinv 0

>event all

The Event1 is iomap f action CHG server 172.18.3.58:502

The Event2 is disable

The Event3 is disable

The Event4 is disable

The inverse of DI value is off

[USAGE] event save

[FUNCTION] saves the configuration of event to system

Note *You should use the net save command to activate the changes.*

- **ping**

[USAGE] ping addr (addr: IP address of destination host)
[FUNCTION] Sends ICMP ECHO_REQUEST packets to network hosts

```
>ping 172.18.3.226  
32 bytes from 172.18.3.226: icmp_seq=0 ttl=64 time=1 ms  
32 bytes from 172.18.3.226: icmp_seq=1 ttl=64 time=1 ms  
32 bytes from 172.18.3.226: icmp_seq=2 ttl=64 time=1 ms  
32 bytes from 172.18.3.226: icmp_seq=3 ttl=64 time=1 ms
```

- **exit**

[USAGE] exit
[FUNCTION] Terminates shell session

```
>exit  
Bye!
```

- **web**

[USAGE] web password ****
[FUNCTION] sets the web password
>web password 1234
>web save
[USAGE] web save
[FUNCTION] saves the configuration of web to system
>web save

Note *You should use the web save command to activate the changes.*

- **reboot**

[USAGE] reboot
[FUNCTION] reboots the system
>reboot
EDG 4516+ Firmware Version 1.11 Build-118
[05-09-2003 18:25:57] System up

CHAPTER
7

Universal Serial Device Gateway

Chapter 7 Universal Serial Device Gateway

Advantech EDG-4508+/4516+ provides a mechanism that allows user to upgrade the firmware. After upgrading the firmware, EDG-4508+/4516+ will turn into universal serial device gateway and denominate "EDG-4508+U/4516+U". EDG-4508+U/4516+U allows nearly any device to serial ports to connect to the Ethernet and share networks quickly. It provides a fast, simple and cost-effective way to bring the advantages of remote management and data accessibility to thousands of devices that cannot connect to the network.

EDG-4508+U/4516+U supports standard networking application programming interface (API) such as WinSock and Socket, therefore, your serial devices can be used in most popular operating systems with EDG-4508+U/4516+U. Moreover, EDG-4508+U/4516+U allows the serial device to communicate with other devices by peer-to-peer without any intermediate host PCs and software programming, which saves cost and effort.

7.1 EDG-4508+/4516+ Firmware updated procedure

This session introduces how to update the firmware from EDG-4508+/4516+ to EDG-4508+U/4516+U. We will take EDG-4508+ as an example to explain the following procedure.

1. Execute the application "EDG serial download and testing utility". Select your model name and IP address, and then press "Download FW" button.
2. Click the "Open button" in the Window of "EDG-4508+ Download Firmware". Select the right firmware file (*.exf) to download to your EDG. (All of the firmware files are located in C:\\Program Files\\Advantech\\EDG COM Port Utility\\firmware\\ when you install the EDG COM port utility.)

File Name	Description
4508+Uv200.exf	The firmware of EDG-4508+U; version 2.0.
4508+v200.exf	The firmware of EDG-4508+; version 2.0.
4516+U200.exf	The firmware of EDG-4516+U; version 2.0
4516+v200.exf	The version of EDG-4516+; version 2.0

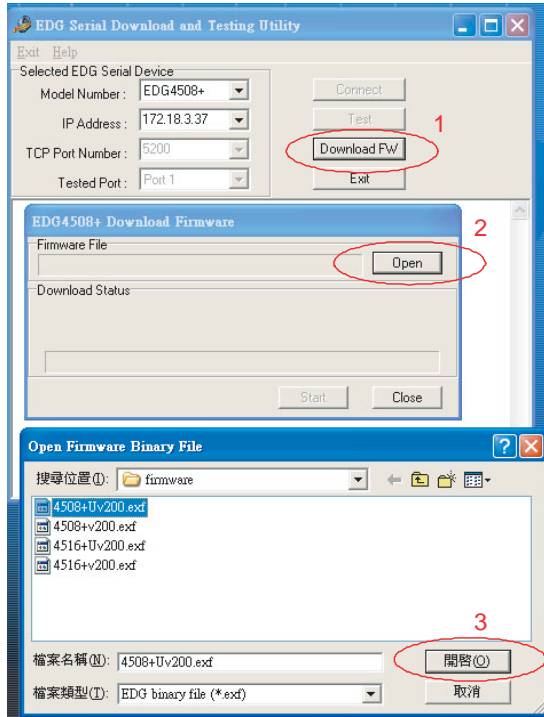

Figure 7.1:

3. Press "Start" button to start the firmware download procedure.

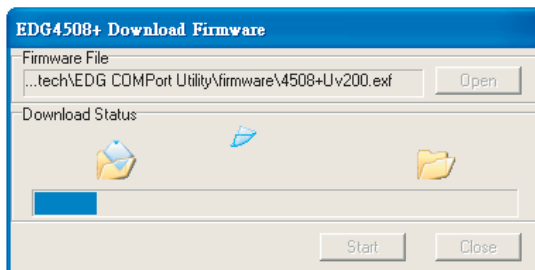

Figure 7.2:

4. When the firmware download procedure is done, you will discover the model name of the EDG Configuration Utility is changed from EDG-4508+ to EDG-4508+U. Besides, it will add a new function: "Setting" in EDG Configuration Utility instead of "Security". The "Setting" in EDG Configuration Utility allows user to configure the setting of EDG-4508+U/4516+U.

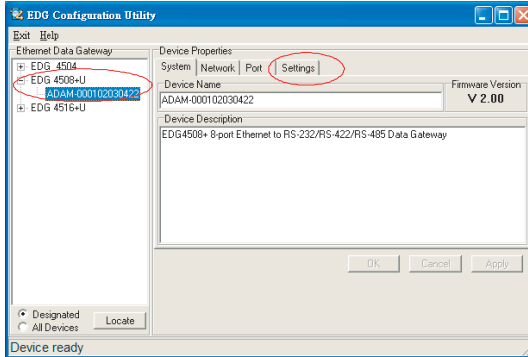

Figure 7.3:

5. Configure the setting of your EDG-4508+U. Press the "Settings" tag in the EDG Configuration Utility.

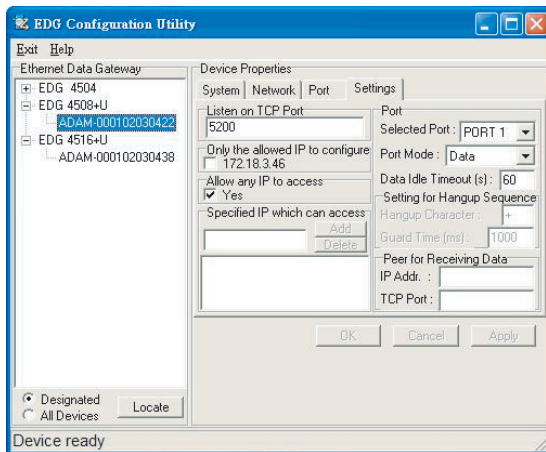

Figure 7.4:

TCP Port number

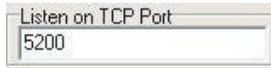

Figure 7.5:

The TCP port number represents the source port number in TCP connections, and is the number used to identify the channel for remote initiating connections. Range: 1-65535.

If an unknown caller wants to connect to the system and asks for some services, they need to define the TCP port to carry a long-term conversation.

Each node on a TCP/IP network has an IP address, and each IP address can allow connections on one or more TCP port. The well-known TCP ports are those that have been defined; for example, port 23 is used for Telnet connections. There are also custom sockets that users and developers define for their specific needs. The default TCP port of EDG-4508+U/4516+U is 5200. Opening a TCP session to port 5200 will form a raw TCP/IP connection to the serial port.

- Note
- 1: If the serial port is in use, the socket connection will be refused.*
 - 2: Timing between serial signals (such as DSR, RTS, and DCD) is not preserved, and the state of such signals is not readable.*

Only configure the authorized IP



Figure 7.6:

This option is enabled in order to protect all configuration settings from being changed inadvertently.

Allow any IP to access

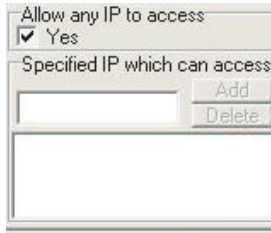

Figure 7.7:

If this option is enabled, any PC can access data from this EDG-4508+U/4516+U.

Specified IP which can access

If you do not want many PCs to have the access right, you can limit at most 32 PCs to access data from this EDG-4508+U/4516+U.

Port Mode

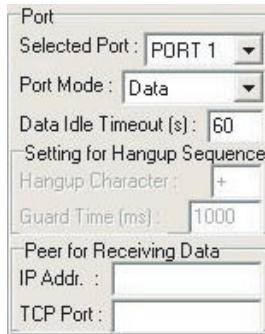

Figure 7.8:

The EDG-4508+U/EDG-4516+U supports "Data mode" communication. In this mode, serial devices that connect to the EDG-4508+U/EDG-4516+U can transmit data to another networking device. You only need to key-in the item "Peer for Receiving Data". The item "Setting for Hang-up Sequence" will become gray.

1. Select port 1 ~ port 8 if you are using EDG-4508+U. Select port 1 ~ port 16 if you are using EDG-4516+U.
2. Key-in the data idle time. The default is 60 seconds. If you want to keep connection continually, you can key-in "0". Data idle Time is the time period in which the device waits for data. If the EDG-4508+U/4516+U does not receive data over an established idle time, the EDG-4508+U/4516+U will disconnect temporarily. When the data comes to the EDG-4508+U/4516+U, it will reconnect automatically. Users do not need to reconnect.
3. Key-in another IP address of networking device which you want to connect.
4. Key-in another TCP port of networking device which you want to connect. If you want to connect to the port of another EDG-4508+U/4516+U, you have to note the following information.
 TCP port of EDG-4508+U/4516+U: &&&&
 TCP port of EDG-4508+U/4516+U's port1: &&&& +1
 TCP port of EDG-4508+U/4516+U's port2: &&&& +2
 For example:
 TCP port of EDG-4508+U/4516+U that you want to connect: 5220.
 TCP port of Port 1: 5220 +1=5221
 TCP port of Port 2: 5220 +2=5222
5. If you want to connect to a PC or any system, you have to key-in the TCP port of that PC or system.

How do you restore the firmware to EDG-4508+/4516+?

If you want to restore the firmware to EDG-4508+/4516+, please follow below procedure. The EDG-4508+ is taken as an example to explain the following procedure.

1. Execute the application "EDG serial download and testing utility". Select your model name and IP address, and then press "Download FW" button.
2. Click the "Open button" in the Window of "EDG-4508+ Download Firmware". Select the right firmware file (*.exf) to download to your EDG. (All of the firmware files are located in C:\\Program Files\\Advantech\\EDG COM Port Utility\\firmware\\ when you install the EDG COM port utility.)

File Name	Description
4508+Uv200.exf	The firmware of EDG-4508+U; version 2.0.
4508+v200.exf	The firmware of EDG-4508+; version 2.0.
4516+U200.exf	The firmware of EDG-4516+U; version 2.0
4516+v200.exf	The version of EDG-4516+; version 2.0

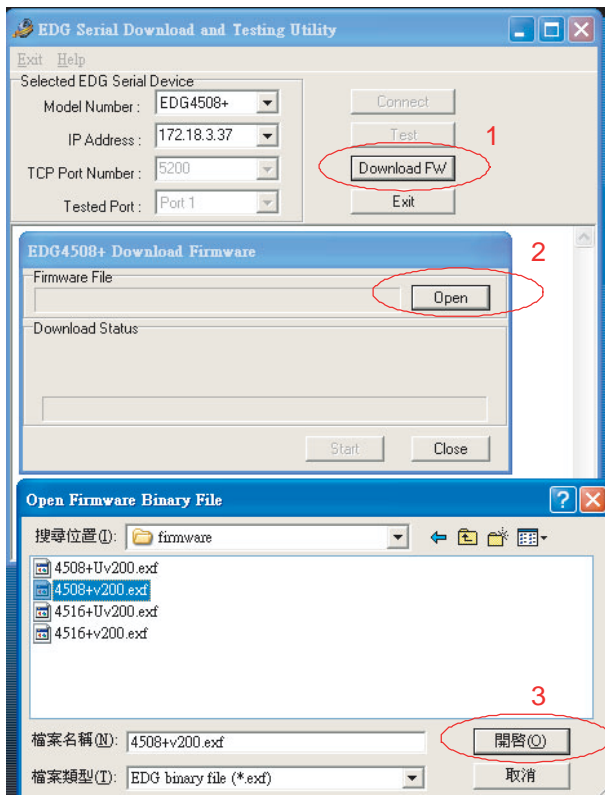

Figure 7.9:

3. Press "Start" button to start the firmware download procedure.

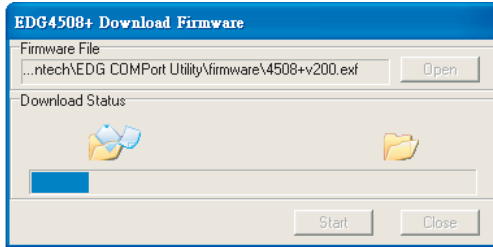

Figure 7.10:

4. When the firmware download procedure is done, you will discover the model name of the EDG Configuration Utility is changed from EDG-4508+U to EDG-4508+. Besides, the function "Security" of EDG Configuration Utility will be restored.

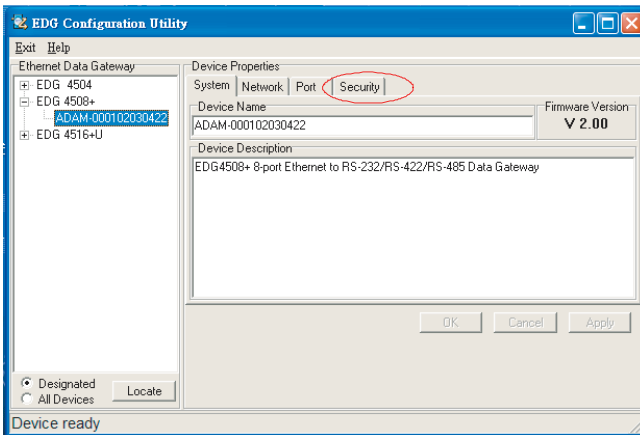

Figure 7.11:

7.2 Network Architecture and Example Code

The EDG-4508+U/4516+U is an advanced peer-to-peer data gateway unit. It extends traditional RS-232/422/485 interfaces to Ethernet network. Through networking, you can control and monitor remote serial devices either over a LAN or over the WAN. Since the EDG-4508+U/4516+U is connected through a TCP/IP network, you will need to know some basic facts about networking in order to get the server hooked up correctly.

The EDG-4508+U/4516+U provides three types of network architecture: polling, event handling and peer-to-peer. You can use the EDG-4508+U/4516+U in any operation system with standard networking API such as WinSock and Socket. If you want to develop application programs to access the EDG-4508+U/4516+U, the following illustrates several example codes for your reference. The three network types are: polling, event handling and peer-to-peer.

7.2.1 Polling Network Architecture

If you want to use host PC to poll the serial devices, which connect to EDG-4508+U/4516+U via Ethernet, you can use polling network architecture.

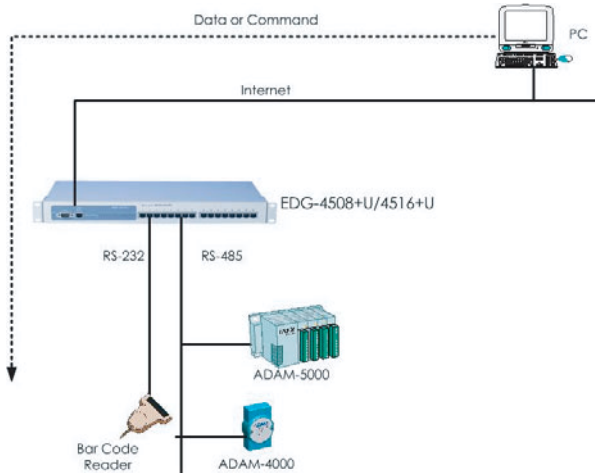

Figure 7.12: Network Architecture-Polling

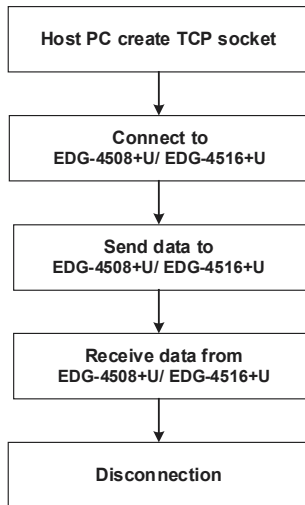

Figure 7.13: Flow chart-Polling Network

Example (EDG-4508+U):

```
SOCKADDR_IN Dst4508UAddr;
SOCKET Dst4508USock;
char RxData[10];
memset(&Dst4508UAddr, 0, sizeof(SOCKADDR_IN));
Dst4508UAddr.sin_family = AF_INET;
Dst4508UAddr.sin_addr.s_addr = inet_addr("10.0.0.1");
//Indicate the IP Address of EDG-4508+U that you want to connect.//
Dst4508UAddr.sin_port = htons(5201);
// Indicate which port of EDG-4508+U you want to access//
// TCP port no. of Port1 = TCP port +1//
// TCP port no. of Port2 = TCP port +2//
Dst4508USock = socket(AF_INET, SOCK_STREAM, 0));
// EDG-4508+U creates the TCP socket//
connect(Dst4508USock, (sockaddr *)&Dst4508UAddr,
sizeof(Dst4508UAddr));
//Connect to the EDG-4508+U//
send(Dst4508USock, "0123456789", 10, 0);
//Send data "0123456789" to the port of EDG-4508+U//
recv(Dst4508USock, RxData, 10, 0);
//Receive the data from the port of EDG-4508+U//
closesocket(Dst4508USock);
//Disconnect from the EDG-4508+U//
```

7.2.2 Event-handling Network Architecture

If an event occurs from serial devices connected to the EDG-4508+U/4516+U, the host PC can get the data via the Ethernet. You can use the event-handling network architecture.

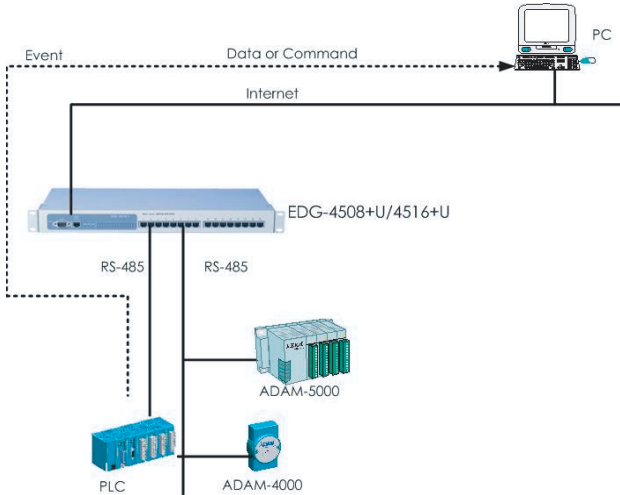

Figure 7.14: Network architecture: Event-handling

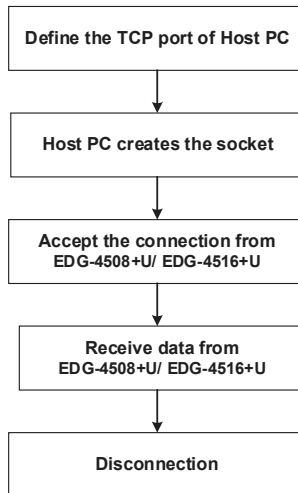

Figure 7.15: Flow chart: Event-handling network

Example (EDG-4508+U):

```
SOCKADDR_IN HostAddr;
SOCKET HostSock;
SOCKADDR_IN ClntAddr;
SOCKET ClntSock;
int ClntAddrLen;
char RxData[256];
memset(&HostAddr, 0, sizeof(SOCKADDR_IN));
HostAddr.sin_family = AF_INET;
HostAddr.sin_addr.s_addr = INADDR_ANY;
HostAddr.sin_port = htons(5201);
//Define the TCP port of host PC. It's the same as the value that you key-
in it in the "Peer for Receiving Data" item of configuration utility//
```



```
HostSock = socket(AF_INET, SOCK_STREAM, 0);
// Create the socket of TCP on the Host//
bind(HostSock,(sockaddr *)&HostAddr, sizeof(HostAddr));
listen(HostSock, 1);
ClntAddrLen=sizeof(ClntAddr);
ClntSock = accept(HostSock, (sockaddr *)&ClntAddr, &ClntAddrLen);
//The host PC accepts the connection request from the EDG-4508+U/
EDG-4516+U //
recv(ClntSock, RxData, 256, 0);
//Receive the data from the port of EDG-4508+U/EDG-4516+U //
closesocket(ClntSock);
//Disconnect from the EDG-4508+U/EDG-4516+U //
```

7.2.3 Peer-to-Peer Network Architecture

If you want to transmit data from one serial device to another serial device via the Ethernet, you can add EDG-4508+U/4516+Us at both sides and use peer-to-peer network architecture.

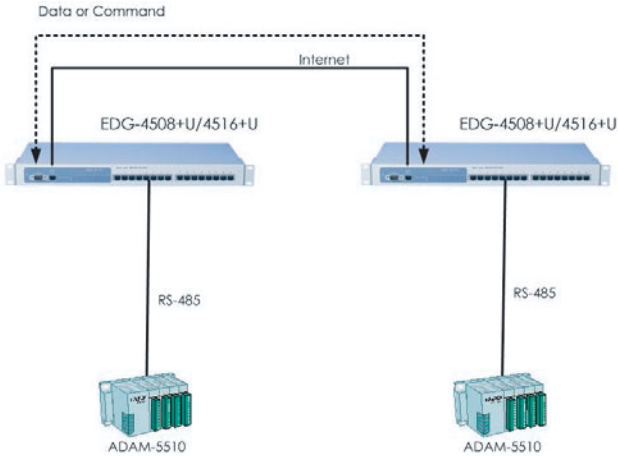

Figure 7.16: Network architecture: Peer-to-peer

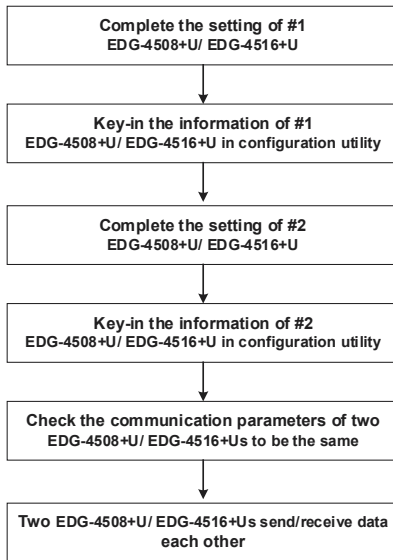

Figure 7.17: Flow chart: Peer-to-Peer network

Example (EDG-4508+U):

1. Complete the setting of #1 EDG-4508+U

#1 EDG-4508+U

Module name: Office

IP address: 172.20.20.111

TCP port: 5200

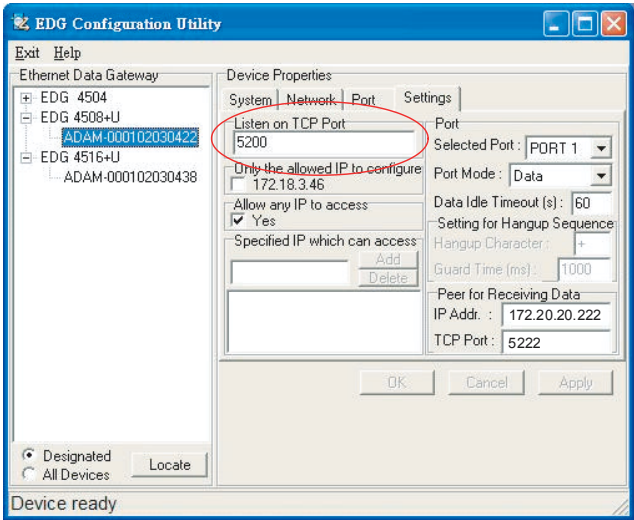

Figure 7.18: #1 EDG-4508+U Configuration Utility

2. Find out the IP address and TCP port of #2 EDG-4508+U that you want to connect.

#2 EDG-4508+U

Module name: Factory

IP address: 172.20.20.222

TCP port: 5220

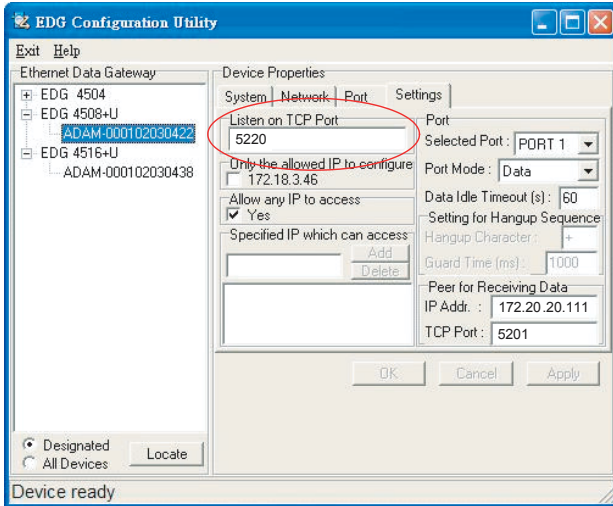

Figure 7.19: #2 EDG-4508+U Configuration Utility

3. Key-in the IP address and TCP port of #2 EDG-4508+U in #1 EDG-4508+U configuration utility.

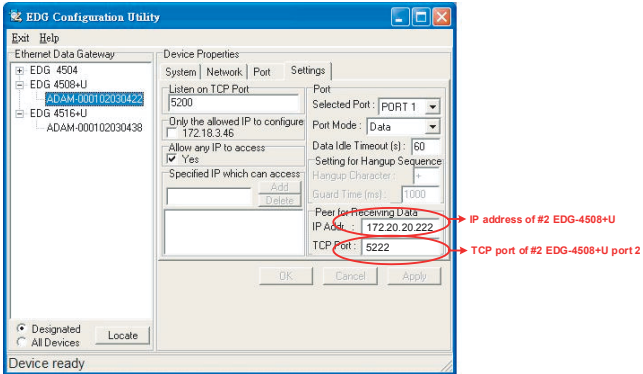

Figure 7.20: Key-in information of #2 EDG-4508+U

4. Follow the above procedure and complete the setting of #2 EDG-4508+U in the configuration utility.

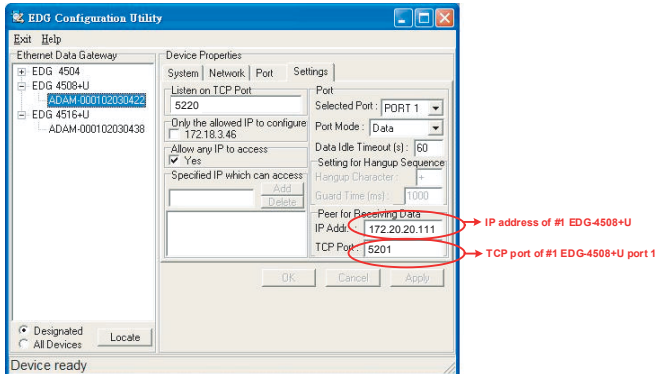

Figure 7.21: Key-in information of #1 EDG-4508+U

5. Check the communication parameters of both EDG-4508+Us are the same. If not, it might not work. Please check the "Baud rate", "Flow control", "Parity", "Data bit" and "Stop bit".

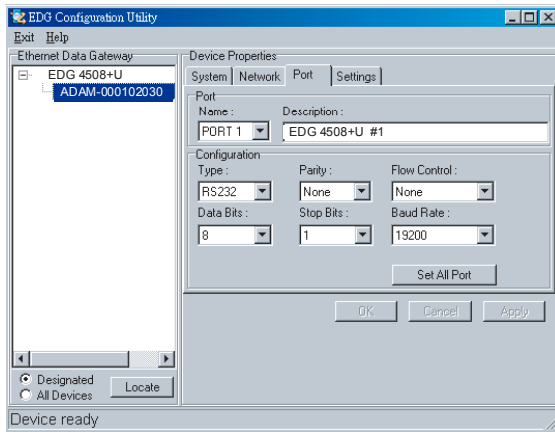

Figure 7.22: Communication parameters of #1 EDG-4508+U

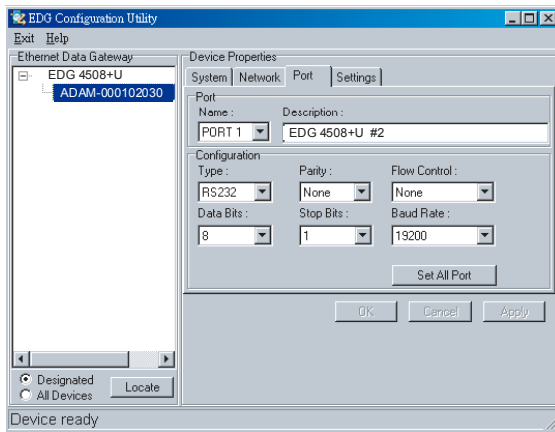

Figure 7.23: Communication parameters of #2 EDG-4508+U

6. #1 EDG-4508+U and #2 EDG-4508+U send/receive data each other.

7.3 Web-Based Configuration for EDG-4508+U/4516+U

EDG-4508+U/4516+U also support web-based configuration function. All operations are the same as EDG-4508+/4516+. You can configure EDG-4508+U/4516+U by internet browser.

Further information about the Web-based Configuration, please refer to chapter 5.

7.3.1 Access web page

Step1: Enter ID and Password.

The default ID and password is the root/root; key-in in the correct fields.



Step2: The Main Menu of Web-Based Configuration

After authorization, the configuration main menu will show up.

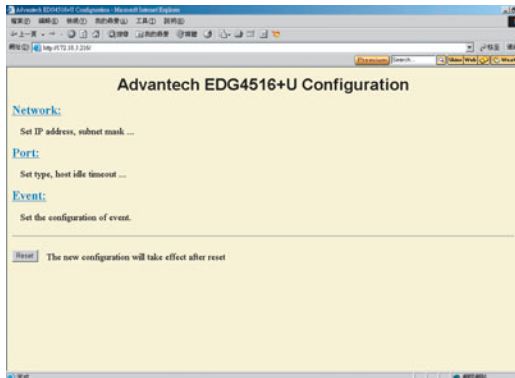

7.3.2 Network Configuration

Under network configuration, there are MAC address, IP Address, Subnet Mask and Default Gateway and Listen TCP Port Number. Enter the corresponding values for your network environment.

Step1. Enter MAC address, IP Address, Subnet Mask and Default Gateway and Listen TCP Port Number.

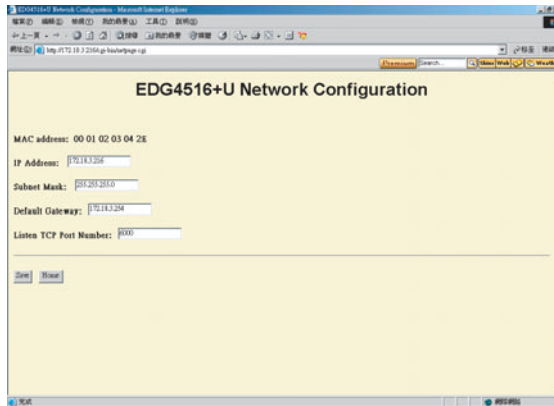

Step2: If you do any modification in EDG-4508+U/4516+U network configuration, please press "save" button to save the configuration.

Note *All new configurations will take effect after reset. Reset function is located on the main menu of the web configuration.*

7.3.3 Port Configuration

Under port configuration, you can assign the type, host idle timeout and configure the connected IP and TCP port for each port.

For instance, if the port 1 of EDG-4516+U#1 connects with the port 8 of EDG-4516+U#2, please fulfill Port 8 IP address and TCP port of EDG-4516+U #2 in port 1 information of EDG-4516+U #1 port configuration.

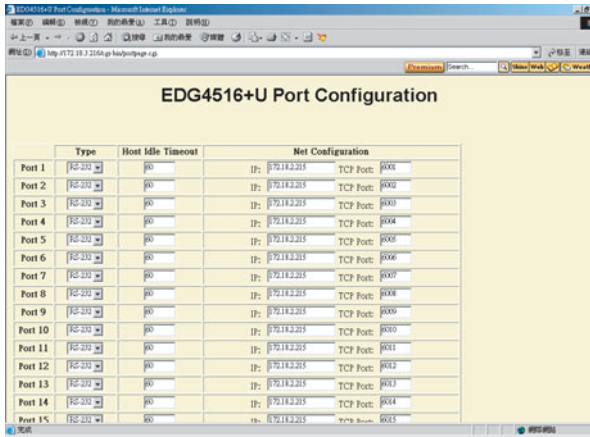

Note *The host time out function is similar to the one in the Configuration Utility.*

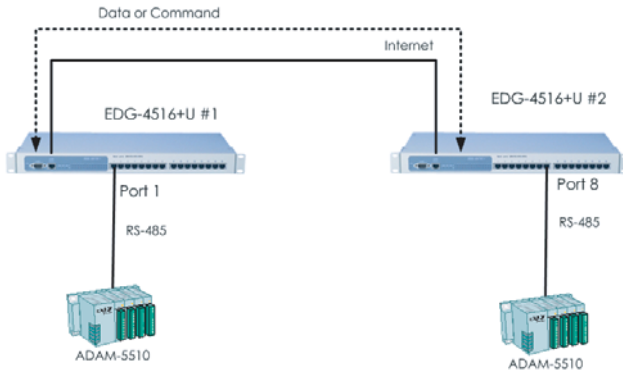

7.3.4 DI/O Event Configuration

In event configuration, you can assign DI event by enabling the check box and choose the optimized action mode, Server IP and TCP Port for the active event. Further information about DI/O event configuration, please refer to session 5.5.

7.3.5 Reset Configuration

All configurations will take effect after this reset step, just press the reset button and the system will give a reset response. It will take a few seconds to reconnect to the new values.

7.4 Console Configuration for EDG-4508+U/4516+U

EDG-4508+U/4516+U also support console configuration function. All operations are the same as EDG-4508+/4516+. The purpose of the console configuration is helping you manage your device with console mode. One of the main functions of the console mode is to change the web configuration login password. You can use terminal software like Hyper Terminal, Telix and other related terminal software.

Further information about console configuration and hyper terminal setting, please refer to chapter 6.

7.4.1 Command List

Command	Function
version	Displays the current firmware version
log	Displays the log file
date	Displays or sets the date
time	Displays or sets the time
net	Displays the net configuration
port	Displays the status of port(s)
event	Displays the configuration of event(s)
ping	Sends ICMP ECHO_REQUEST packets to network hosts
exit	Terminates shell session
web	Sets web password or saves web configuration
reboot	Reboots the system

- **version**

[Usage] version

[Function] displays the current firmware version

>version

Current version of firmware is 1.11-1.11

- **log**

[Usage] log

[Function] displays log file

>log

[05-09-2003 17:01:17] System up

- **date: displays or sets the date**

[Usage] date

[Function] displays the date

>date

Current date is 05-09-2003

[Usage] date [mm-dd-yy [dse]]

[Function] sets the date

>date 06-09-03

>date

> Current date is 06-09-2003

- **time: displays or sets the time**

[Usage] time

[Function] displays the configuration

>time

Current time is 17:17:30

[Usage] time [hh.mm.ss]

[Function] sets the time

>time 17:17:50

>time

Current time is 17:17:55

- **net**

[Usage] net

[Function] displays the configuration of net

>net

Current net is ip 172.18.3.226 gw 0.0.0.0 netmask 255.255.255.0

[Usage] net set ip d.d.d.d gw d.d.d.d netmask d.d.d.d

[Function] sets the configuration of net

>net set ip 172.18.3.227 gw 0.0.0.0 netmask 255.255.255.0

>net

Current net is ip 172.18.3.227 gw 0.0.0.0 netmask 255.255.255.0

[Usage] net tcpno ddd

[Function] Set the listen TCP port number of net.

> net tcpno 6000

Set the listen TCP port number to 6000.

[USAGE] net save

[FUNCTION] saves the configuration of net to system

Note *You should use the net save command to activate the change.*

- **port**

[USAGE] port [nn | all]

[FUNCTION] displays the status of port(s)

>port all

The Port01 is type 422, idlet 30, idle

The Port02 is type 232, idlet 30, idle

The Port03 is type 232, idlet 30, idle

The Port04 is type 232, idlet 30, idle

The Port05 is type 232, idlet 30, idle

The Port06 is type 232, idlet 30, idle

The Port07 is type 232, idlet 30, idle

The Port08 is type 232, idlet 30, idle

The Port09 is type 232, idlet 30, idle

The Port10 is type 232, idlet 30, idle

The Port11 is type 232, idlet 30, idle

The Port12 is type 232, idlet 30, idle

The Port13 is type 232, idlet 30, idle

The Port14 is type 422, idlet 30, idle

The Port15 is type 422, idletimeout 30, idle
The Port16 is type 422, idletimeout 30, idle

[USAGE] port [nn | all] type [232|422|485]

[FUNCTION] sets the type of port(s)

>port 3 type 485

>port 3

The Port03 is type 485, idletimeout 30, idle

[USAGE] port [nn | all] idletimeout [0 - 65535]

[FUNCTION] sets the idle timeout of port(s)

>port 3 idletimeout 45

>port 3

The Port03 is type 485, idletimeout 45, idle

[USAGE] port [nn | all] netcfg [d.d.d.d:d | clear]

[Function] set/clear the net configuration of port(s)

>port 3 netcfg 172.18.2.215:6003

Set the IP of port 3 to 172.18.2.215, and TCP port number to 6003.

[USAGE] port [nn | all] sercfg baud [n|o|e|m|s] [5|6|7|8] [1|1.5|2]

[FUNCTION] set the line configuration of port(s)

[n|o|e|m|s]: Parity setting

n: none

o: odd

e: even

m: mark

s: space

[5|6|7|8]: Data bit setting

[1|1.5|2]: Stop bit setting

[USAGE] port save

[FUNCTION] saves the configuration of port to system

Note *You should use the net save command to activate the change.*

- **event**

[USAGE] event [nn | all]

[FUNCTION] displays the configuration of event(s)

[USAGE] event nn iomap xx action [L2H|H2L|CHG] server d.d.d.d:d

[FUNCTION] sets the configuration of event

[USAGE] event [nn | all] clear

[FUNCTION] clears the configuration of event

>event 2 iomap f action L2H server 172.18.3.58:503

>event 2

The Event2 is iomap f action L2H server 172.18.3.58:503

>event 2 clear

>event all

The Event1 is iomap f action CHG server 172.18.3.58:502

The Event2 is disable

The Event3 is disable

The Event4 is disable

The inverse of DI value is off

[USAGE] event diinv [0|1]

[FUNCTION] sets the inverse of DI value on/off

>event diinv 1

>event all

The Event1 is iomap f action CHG server 172.18.3.58:502

The Event2 is disable

The Event3 is disable

The Event4 is disable

The inverse of DI value is on

>event diinv 0

>event all

The Event1 is iomap f action CHG server 172.18.3.58:502

The Event2 is disable

The Event3 is disable

The Event4 is disable

The inverse of DI value is off

[USAGE] event save

[FUNCTION] saves the configuration of event to system

Note *You should use the net save command to activate the change.*

- **l ping**

[USAGE] ping addr (addr: IP address of destination host)
[FUNCTION] Sends ICMP ECHO_REQUEST packets to network hosts

```
>ping 172.18.3.226  
32 bytes from 172.18.3.226: icmp_seq=0 ttl=64 time=1 ms  
32 bytes from 172.18.3.226: icmp_seq=1 ttl=64 time=1 ms  
32 bytes from 172.18.3.226: icmp_seq=2 ttl=64 time=1 ms  
32 bytes from 172.18.3.226: icmp_seq=3 ttl=64 time=1 ms
```

- **exit**

[USAGE] exit
[FUNCTION] Terminates shell session

```
>exit  
Bye!
```

- **web**

[USAGE] web password ****
[FUNCTION] sets the web password
>web password 1234
>web save
[USAGE] web save
[FUNCTION] saves the configuration of web to system
>web save

Note *You should use the web save command to activate the change.*

- **reboot**

[USAGE] reboot
[FUNCTION] reboots the system
>reboot
EDG 4516+ Firmware Version 1.11 Build-118
[05-09-2003 18:25:57] System up

CHAPTER
8

Event and DI/O Monitoring

Chapter 8 Event and DI/O Monitoring

8.1 Overview

The purpose of Event and DIO Test is to help you monitor your EDG-4508+/4516+ DI/DO event(s). Follow these steps to test the DI/DO event(s).

8.2 Event and DI/O Monitoring

8.2.1 Polling Monitoring

The following screen will appear once the EVENT Tester Program is executed. To start monitoring the Polling, enter the IP Address and press start. The Status will change to Monitoring if you enter the correct IP of your device.

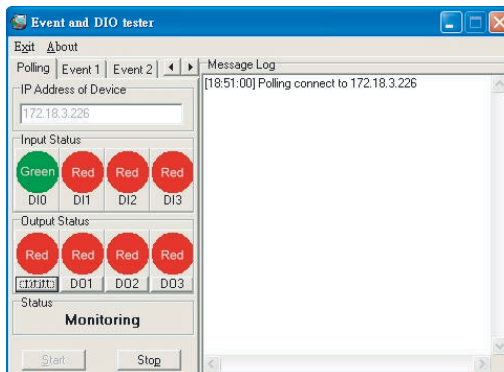
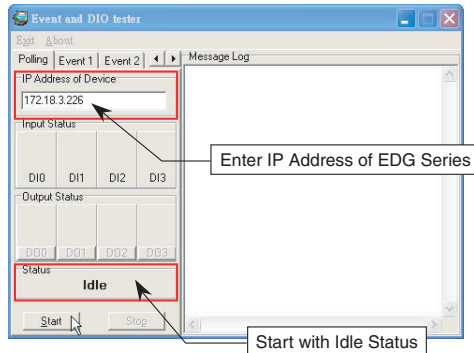

8.2.2 Event Monitoring

Once you have executed the steps in Chapter 3.4, you can use the tester to monitor the event status with the port and IP you have assigned before. Please follow these steps:

Step 1. Assign IP and TCP Port for monitoring

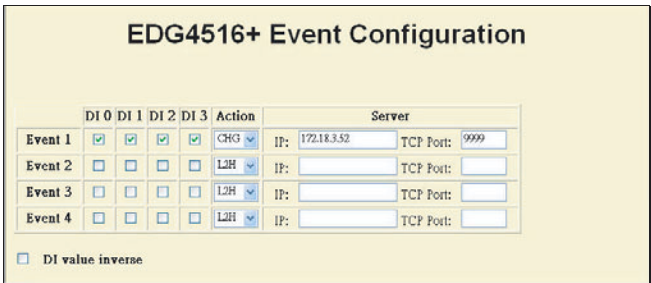

The screenshot shows the 'EDG4516+ Event Configuration' window. It contains a table with columns for Event, DI0, DI1, DI2, DI3, Action, and Server. Event 1 is configured with Action 'CHG', IP '172.18.3.52', and TCP Port '9999'. Events 2, 3, and 4 are configured with Action 'L2H' and have empty IP and TCP Port fields. There is a checkbox for 'DI value inverse' which is currently unchecked.

	DI 0	DI 1	DI 2	DI 3	Action	Server	
Event 1	<input checked="" type="checkbox"/>	<input checked="" type="checkbox"/>	<input checked="" type="checkbox"/>	<input checked="" type="checkbox"/>	CHG	IP: 172.18.3.52	TCP Port: 9999
Event 2	<input type="checkbox"/>	<input type="checkbox"/>	<input type="checkbox"/>	<input type="checkbox"/>	L2H	IP:	TCP Port:
Event 3	<input type="checkbox"/>	<input type="checkbox"/>	<input type="checkbox"/>	<input type="checkbox"/>	L2H	IP:	TCP Port:
Event 4	<input type="checkbox"/>	<input type="checkbox"/>	<input type="checkbox"/>	<input type="checkbox"/>	L2H	IP:	TCP Port:

DI value inverse

(Setting Event monitoring from Web Event Configuration)

Step 2. Assign TCP Port of Event Server and click on "Start". Event and DIO tester will change to Monitoring Mode. Red indicator in normal mode means Inactive and Green indicator means Active.

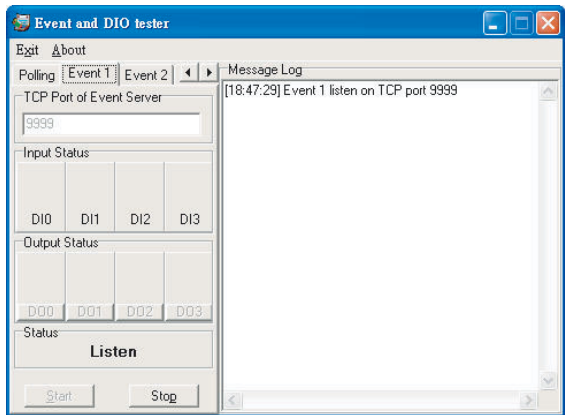

(Event Monitoring and no Event Active)

Step 3. We can activate the DI0 event; tester will show the green indicator. Message Log will show event log with timer and event description.

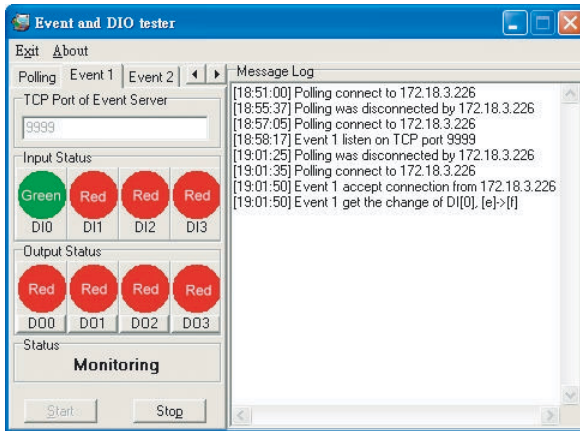

(DI0 Active and Event Monitor Shows Green)

8.2.3 DI Value Inverse Option

Because of different wiring issues, we have provided DI value inverse optional function to Inverse DI value. You can select the correct functions to match the results.

Step 1. DI value inverse function

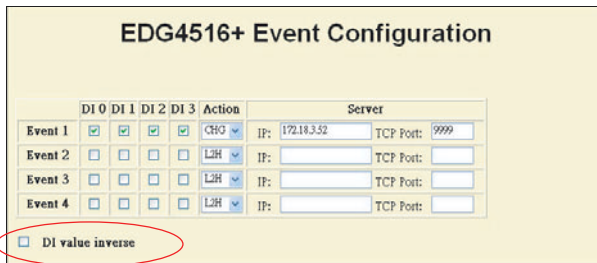

(Setting Event monitoring DI value Inverse Option)

Step 2. After enabling DI value inverse function, Green indicator means inactive and Red indicator means active.

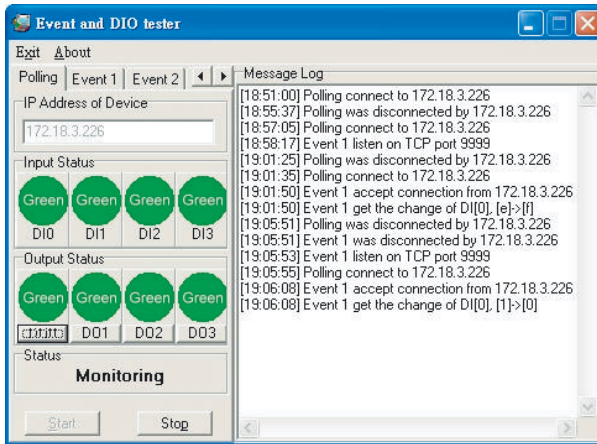

Step 3. After DI value inverse is enabled, follow the event configuration rule from the web configuration.

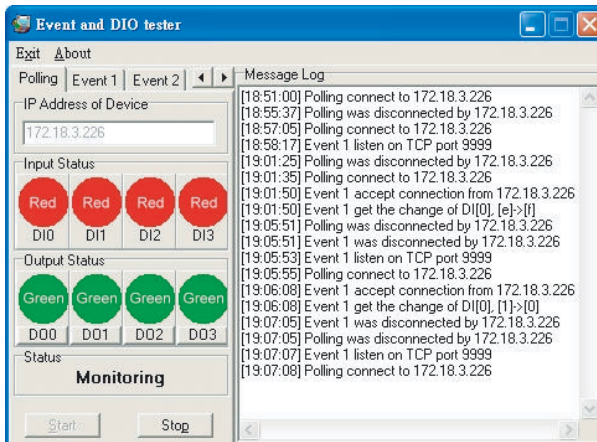

8.3 Programming I/O

According the feature list, it mentioned EDG-4508+/4516+ provide the D/I AND D/O handling function. In order to help customer to create the I/O event handling environment. We provide a programmable I/O sample program for customer use. After installing the EDG COM Port Utility, the sample programs will be on the location as follow:

C:\Program Files\Advantech\EDG COMPort Utility\samples\vc\
edgevtio.

How to use the sample files?

- (1) The sample programs include following file and the develop environment is based on Microsoft Visual C++.
 - edgevtio.cpp
 - edgevtio.dsp
 - edgevtio.dsw
 - edgevtio.ncb
 - edgevtio.opt
 - edgevtio.plg
 - mbtcp.h
- (2) Compiler the sample program
- (3) Run the sample program
 - After compiler the program and run the program, the system will change to Server mode to trigger any D/I event and sent back to system to active the D/O event.
- (4) You can modify the program and create your own event handling process.
- (5) Sample files list and description as follow:
 - edgevtio.cpp : Defines the entry point for the console application.
 - edgevtio.dsp : Microsoft Developer Studio Project File
 - edgevtio.dsw : Microsoft Developer Studio Workspace File
 - edgevtio.ncb : Microsoft C/C++ program database
 - edgevtio.opt
 - edgevtio.plg
 - mbtcp.h

In this sample files, we provide the note for the parameter for programmer use.

For example:

In edgevtio.cpp file content, line 32 to line 41

```

memset(&HostAddr, 0, sizeof(SOCKADDR_IN));
HostAddr.sin_family = AF_INET;
HostAddr.sin_addr.s_addr = INADDR_ANY;
HostAddr.sin_port = htons(5000);
//          |
//          +-->The TCP Port in the server application

```

It remarks the function of `htons(n)`, the parameter `n` means the TCP Port in server application and It helps the programmer to make his own program easier by referencing the note we provided.

```

HostSock = socket(AF_INET, SOCK_STREAM, 0);
//          |
//          +-->Create the socket of TCP on the Host

```

It remarks the function of `socket(AF_INET, SOCK_STREAM, 0)`, the function of `socket(var1,var2,n)` means to create the socket of TCP on Host. Programmer can also create the socket of TCP on the Host by himself.

edgevtio.dsp

Programmers can choose the develop tools for themselves. For example, in `edgevtio.dsp` file, the extension file name `.dsp` means Microsoft Developer Studio Project File. Programmer can open the file as a template to create their own programs.

edgevtio.dsw

File name of `edgevtio` means EDG Event I/O, extension name of `dsw` means it is a Microsoft Developer Studio Workspace file. This file is necessary when you open a Developer Studio Project and we make a warning note in file to reminder you not to modify or delete this related workspace file.

mbtcp.h

File name of mbtcp means Modbus TCP; we provide the easier definition of necessary parameter. For example,

```
#define MODBUSTCPMAXMSGLENGTH    288
#define MODBUSTCPMSGHDRLENGTH    6

typedef struct __MODBUSTCPMSG {
    unsigned short wTransactionId;
    unsigned short wProtocolId;
    unsigned char byteMsgLenHigh;
    unsigned char byteMsgLenLow;
    unsigned char Data[2];
} TMODBUSTCPMSG;
```

MODBUSTCPMAXMSGLENGTH

MODBUS TCP Max Message Length

MODBUSTCPMSGHDRLENGTH

MODBUS TCP Message Header Length

- * The programming I/O sample programs are for programmer's reference to make the event I/O program for their own environment. Programmers can open the file as a template file to make a new project of event.

CHAPTER
9

Troubleshooting

Chapter 9 Troubleshooting

This chapter explains how to solve some of the most common problems with the EDG Series. If you still have problems after reading this chapter, contact your dealer, or e-mail Advantech for help.

"Configuration Utility can not find EDG Series"

1. Check the "Power" LED. If it is off, you will have to:
 - Make sure the EDG Series power cable is plugged in, and the server is receiving power.
 - Check that the server's network connector is plugged in properly.
 - Check that the input power is 90 VAC ~ 260 VAC, 47 ~ 63 Hz.
 - Check that the fuse is OK.
2. Check the "Traffic" LED. If it is off, you will have to:
 - Make sure the network connection is OK
 - Make sure your network is 10/100 Mbps
3. If the above are completed, it means the EDG Series is okay. Next, check to see if the EDG Series and the host are in the same local area network.
4. Make sure your computer is properly connected to the network.

"Configuration utility can find EDG Series but cannot access EDG Series"

For security purpose, and to simplify operations, users can give the access right to specific PCs. Only these PCs can get data from EDG Series. While using the EDG Series, it is advised that you check to see if your PC is on the access right list.

"Cannot change the IP address or other server properties"

Only the network administrator can modify the EDG Series' configuration. Keep in mind, even when multiple hosts share the same network, administrative access is still protected. If you need to change any configuration settings, ask your network administrator for assistance.

"The host PC can access the EDG Series at this local site but later relocates the EDG Series to a remote site that PCs cannot access."

Your IP address might have changed because of different network interface connections, and as a result, you are no longer on the EDG Series' Access Control list. To resolve this issue:

1. Confirm your IP address with the EDG Series.
2. Ask the network administrator to set up the server configuration so that you are on the EDG Series' Access Control list.

APPENDIX
A

Appendix A

A.1 RS-232 Pin Assignment

Pin No.	Description
Pin 1	DCD
Pin 2	Rx
Pin 3	Tx
Pin 4	DTR
Pin 5	GND
Pin 6	DSR
Pin 7	RTS
Pin 8	CTS
Pin 9	RI

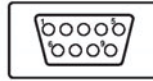

A.2 RJ-48 Cable PIN Assignment

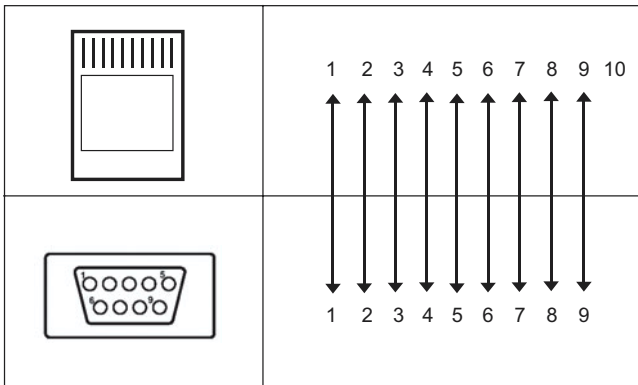

RS-422

Pin No.	Description
1	Tx-
4	Tx+
5	GND
7	Rx+
9	Rx-

RS-485

Pin No.	Description
1	DATA-
4	DATA+
5	GND

Free Manuals Download Website

<http://myh66.com>

<http://usermanuals.us>

<http://www.somanuals.com>

<http://www.4manuals.cc>

<http://www.manual-lib.com>

<http://www.404manual.com>

<http://www.luxmanual.com>

<http://aubethermostatmanual.com>

Golf course search by state

<http://golfingnear.com>

Email search by domain

<http://emailbydomain.com>

Auto manuals search

<http://auto.somanuals.com>

TV manuals search

<http://tv.somanuals.com>