

ViewSonic®



CDP6530-T LCD Monitor User Guide

IMPORTANT: Please read this User Guide to obtain important information on installing and using your product in a safe manner, as well as registering your product for future service. Warranty information contained in this User Guide will describe your limited coverage from ViewSonic Corporation, which is also found on our web site at <http://www.viewsonic.com> in English, or in specific languages using the Regional selection box in the upper right corner of our website. "Antes de operar su equipo lea cuidadosamente las instrucciones en este manual"

Model No. VS14704

Content

| | |
|---|-----------|
| Safety Precautions | 5 |
| Package Contents | 6 |
| Optional Accessories | 6 |
| Parts Name and Functions | 7 |
| Front View | 7 |
| Control Panel | 8 |
| Terminal Panel | 9 |
| Wireless Remote Control | 10 |
| Installing the Remote Control Batteries | 11 |
| Operating Range for the Remote Control | 11 |
| Handling the Remote Control | 11 |
| Setup Procedure | 12 |
| How to Mount and Attach Options to the LCD Monitor | 13 |
| Ventilation Requirements for Enclosure Mounting | 14 |
| Connections | 15 |
| Before Making Connections: | 15 |
| Wiring Diagram | 15 |
| Connecting a Personal Computer | 16 |
| Connecting with Digital Interface Equipment | 17 |
| Connecting a DVD Player with Component Output | 18 |
| Connecting a VCR with Composite (CVBS) and S-Video outputs | 19 |
| Connecting to External Speakers | 20 |
| Basic Operation | 25 |
| Power ON and OFF Modes | 25 |
| Power Indicator | 25 |
| Using Power Management | 25 |
| Selecting a Video Source | 26 |
| Picture Mode | 26 |
| OSD (On-Screen-Display) Controls | 27 |
| Picture | 28 |
| Sound | 30 |
| Option | 31 |
| Setting | 33 |
| For Long Life Use of Public Display | 37 |
| Controlling the LCD monitor via RS-232C Remote Control | 38 |
| Appendix: Installing Stands | 39 |
| Troubleshooting | 40 |
| Specifications | 41 |
| Product Specifications | 41 |
| Supported Input Signal Resolution | 42 |
| Supported Signal Source and Resolution in PIP Mode | 43 |
| Customer Support | 51 |
| Limited Warranty | 53 |
| Mexico Limited Warranty | 54 |

Compliance Information

For U.S.A.

This device complies with part 15 of FCC Rules. Operation is subject to the following two conditions: (1) this device may not cause harmful interference, and (2) this device must accept any interference received, including interference that may cause undesired operation.

This equipment has been tested and found to comply with the limits for a Class B digital device, pursuant to part 15 of the FCC Rules. These limits are designed to provide reasonable protection against harmful interference in a residential installation. This equipment generates, uses, and can radiate radio frequency energy, and if not installed and used in accordance with the instructions, may cause harmful interference to radio communications. However, there is no guarantee that interference will not occur in a particular installation. If this equipment does cause harmful interference to radio or television reception, which can be determined by turning the equipment off and on, the user is encouraged to try to correct the interference by one or more of the following measures:

- Reorient or relocate the receiving antenna.
- Increase the separation between the equipment and receiver.
- Connect the equipment into an outlet on a circuit different from that to which the receiver is connected.
- Consult the dealer or an experienced radio/TV technician for help.

Warning: You are cautioned that changes or modifications not expressly approved by the party responsible for compliance could void your authority to operate the equipment.

For Canada

- This Class B digital apparatus complies with Canadian ICES-003.
- Cet appareil numérique de la classe B est conforme à la norme NMB-003 du Canada.

CE Conformity for European Countries



The device complies with the EMC Directive 2004/108/EC and Low Voltage Directive 2006/95/EC.

Following information is only for EU-member states:

The mark shown to the right is in compliance with the Waste Electrical and Electronic Equipment Directive 2002/96/EC (WEEE).

The mark indicates the requirement NOT to dispose the equipment as unsorted municipal waste, but use the return and collection systems according to local law.



Important Safety Instructions

1. Read these instructions completely before using the equipment.
2. Keep these instructions in a safe place.
3. Heed all warnings.
4. Follow all instructions.
5. Do not use this equipment near water. Warning: To reduce the risk of fire or electric shock, do not expose this apparatus to rain or moisture.
6. Clean with a soft, dry cloth. If further cleaning is required.
7. Do not block any ventilation openings. Install the equipment in accordance with the manufacturer's instructions.
8. Do not install near any heat sources such as radiators, heat registers, stoves, or other devices (including amplifiers) that produce heat.
9. Do not attempt to circumvent the safety provisions of the polarized or grounding type plug. A polarized plug has two blades with one wider than the other. A grounding type plug has two blades and a third grounding prong. The wide blade and the third prong are provided for your safety. If the plug does not fit into your outlet, consult an electrician for replacement of the outlet.
10. Protect the power cord from being tread upon or pinched, particularly at the plug, and the point where it emerges from the equipment. Be sure that the power outlet is located near the equipment so that it is easily accessible.
11. Only use attachments/accessories specified by the manufacturer.
12. Use only with the cart, stand, tripod, bracket, or table specified by the manufacturer, or sold with the equipment. When a cart is used, use caution when moving the cart/equipment combination to avoid injury from tipping over.
13. Unplug this equipment when it will be unused for long periods of time.
14. Refer all servicing to qualified service personnel. Service is required when the unit has been damaged in any way, such as: if the power-supply cord or plug is damaged, if liquid is spilled onto or objects fall into the unit, if the unit is exposed to rain or moisture, or if the unit does not operate normally or has been dropped.



Declaration of RoHS Compliance

This product has been designed and manufactured in compliance with Directive 2002/95/EC of the European Parliament and the Council on restriction of the use of certain hazardous substances in electrical and electronic equipment (RoHS Directive) and is deemed to comply with the maximum concentration values issued by the European Technical Adaptation Committee (TAC) as shown below:

| Substance | Proposed Maximum Concentration | Actual Concentration |
|---|--------------------------------|----------------------|
| Lead (Pb) | 0.1% | < 0.1% |
| Mercury (Hg) | 0.1% | < 0.1% |
| Cadmium (Cd) | 0.01% | < 0.01% |
| Hexavalent Chromium (Cr ⁶⁺) | 0.1% | < 0.1% |
| Polybrominated biphenyls (PBB) | 0.1% | < 0.1% |
| Polybrominated diphenyl ethers (PBDE) | 0.1% | < 0.1% |

Certain components of products as stated above are exempted under the Annex of the RoHS Directives as noted below:

Examples of exempted components are:

1. Mercury in compact fluorescent lamps not exceeding 5 mg per lamp and in other lamps not specifically mentioned in the Annex of RoHS Directive.
2. Lead in glass of cathode ray tubes, electronic components, fluorescent tubes, and electronic ceramic parts (e.g. piezoelectronic devices).
3. Lead in high temperature type solders (i.e. lead-based alloys containing 85% by weight or more lead).
4. Lead as an alloying element in steel containing up to 0.35% lead by weight, aluminium containing up to 0.4% lead by weight and as a copper alloy containing up to 4% lead by weight.

Copyright Information

Copyright © ViewSonic® Corporation, 2012. All rights reserved.

ViewSonic, the three birds logo, OnView, ViewMatch, and ViewMeter are registered trademarks of ViewSonic Corporation.

Disclaimer: ViewSonic Corporation shall not be liable for technical or editorial errors or omissions contained herein; nor for incidental or consequential damages resulting from furnishing this material, or the performance or use of this product.

In the interest of continuing product improvement, ViewSonic Corporation reserves the right to change product specifications without notice. Information in this document may change without notice.

No part of this document may be copied, reproduced, or transmitted by any means, for any purpose without prior written permission from ViewSonic Corporation.

Product Registration

To meet your future needs, and to receive any additional product information as it becomes available, please register your product on the Internet at: **www.viewsonic.com**. The ViewSonic Wizard CD-ROM also provides an opportunity for you to print the registration form, which you may mail or fax to ViewSonic.

For Your Records

| | |
|------------------|--|
| Product Name: | CDP6530-T ViewSonic 64.5" LCD Monitor |
| Model Number: | VS14704 |
| Document Number: | CDP6530-T_UG_ENG Rev.1A 05-17-12 |
| Serial Number: | _____ |
| Purchase Date: | _____ |

Product disposal at end of product life

ViewSonic respects the environment and is committed to working and living green. Thank you for being part of Smarter, Greener Computing. Please visit ViewSonic website to learn more.

USA & Canada: <http://www.viewsonic.com/company/green/recycle-program/>

Europe: <http://www.viewsoniceurope.com/uk/kbase/article.php?id=639>

Taiwan: <http://recycle.epa.gov.tw/recycle/index2.aspx>

Safety Precautions

FOR OPTIMUM PERFORMANCE, PLEASE NOTE THE FOLLOWING WHEN SETTING UP AND USING THE LCD COLOR MONITOR:

- DO NOT REMOVE MONITOR BACK COVER. There are no user serviceable parts inside and opening or removing covers may expose you to dangerous shock hazards or other risks. Refer all servicing to qualified service personnel.
- Do not spill any liquids into the cabinet or use your monitor near water.
- Do not insert objects of any kind into the cabinet slots, as they may touch dangerous voltage points, which can be harmful or fatal or may cause electric shock, fire or equipment failure.
- Do not place any heavy objects on the power cord. Damage to the cord may cause shock or fire.
- Do not place this product on a sloping or unstable cart, stand or table, as the monitor may fall, causing serious damage to the monitor.
- When operating the LCD monitor with an AC 100-120V power supply in North America, use a power supply cord provided with this monitor.
- When operating the LCD monitor with an AC 220-240V power supply in Europe, use a power supply cord provided with this monitor.
- In UK, use a BS-approved power cord with molded plug having a black (10A) fuse installed for use with this monitor. If a power cord is not supplied with this monitor, please contact your supplier.
- When operating the LCD monitor with a 220-240V AC power supply in Australia, use the power cord provided with this monitor. If a power cord is not supplied with this monitor, please contact your supplier.
- For all other case, use a power cord that matches the AC voltage of the power outlet and has been approved by and complies with the safety standard of your particular country.
- Do not place any objects onto the monitor and do not use the monitor outdoors.
- The inside of the fluorescent tube located within the LCD monitor contains mercury. Please follow the laws or rules of your municipality to dispose of the tube properly.
- Do not bend power cord.
- Do not use monitor in high temperature, humid, dusty, or oily areas.
- If monitor or glass is broken, do not come in contact with the liquid crystal and handle with care.
- Allow adequate ventilation around the monitor, so that heat can properly dissipate. Do not block ventilated openings or place the monitor near a radiator or other heat sources. Do not put anything on top of the monitor.
- The power cable connector is the primary means of detaching the system from the power supply. The monitor should be installed close to a power outlet, which is easily accessible.
- Handle with care when transporting. Save packaging for transporting.
- Please clean the holes of back cabinet to reject dirt and dust at least once a year because of set reliability.
- If using the cooling fan continuously, it's recommended to wipe holes a minimum of once a month.
- When installing the remote control batteries;
 - Align the batteries according to the (+) and (-) indications inside the case.
 - Align the (-) indication of the battery first inside the case.



CAUTION:

Immediately unplug your monitor from the wall outlet and refer servicing to qualified service personnel under the following conditions:

- When the power supply cord or plug is damaged.
- If liquid has been spilled, or objects have fallen into the monitor.
- If the monitor has been exposed to rain or water.
- If the monitor has been dropped or the cabinet damaged.
- If the monitor does not operate normally by following operating instructions.

Recommended Use

CAUTION:

- For optimum performance, allow 20 minutes for warm-up.
- Rest your eyes periodically by focusing on an object at least 5 feet away. Blink often.
- Position the monitor at a 90° angle to windows and other light sources to minimize glare and reflections.
- Clean the LCD monitor surface with a lint-free, nonabrasive cloth. Avoid using any cleaning solution or glass cleaner!
- Adjust the monitor's brightness, contrast and sharpness controls to enhance readability.
- Avoid displaying fixed patterns on the monitor for long periods of time to avoid image persistence (after image effects).
- Get regular eye checkups.

Ergonomics

To realize the maximum ergonomic benefits, we recommend the following:

- Use the preset Size and Position controls with standard signals.
- Use the preset Color Setting.
- Use non-interlaced signals.
- Do not use primary color blue on a dark background, as it is difficult to see and may produce eye fatigue due to insufficient contrast.

Package Contents

Your new CDP6530 monitor box should contain the following:

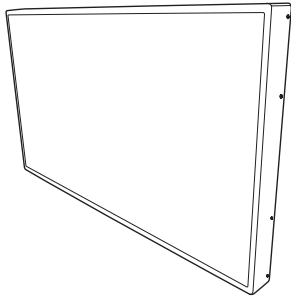

LCD monitor

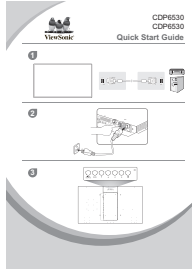

Quick Start Guide

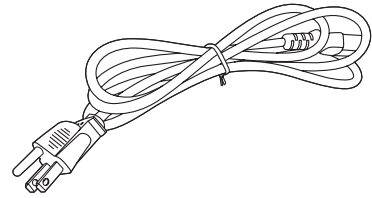

Power cord for North America

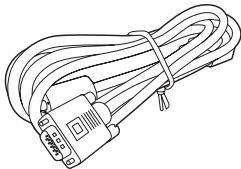

VGA cable

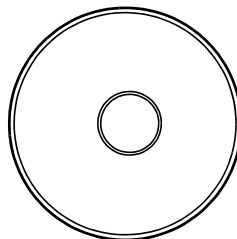

CD Wizard

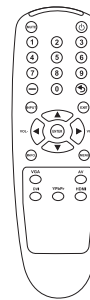

Wireless Remote Control

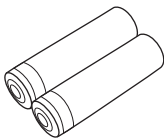

AAA battery (x 2)



USB cable

Optional Accessories

| Stand (STND-016) | |
|------------------------|--|
| | |
| Monitor stand (x 2) | M4 screw for stand installation (x 12) |

Parts Name and Functions

Front View

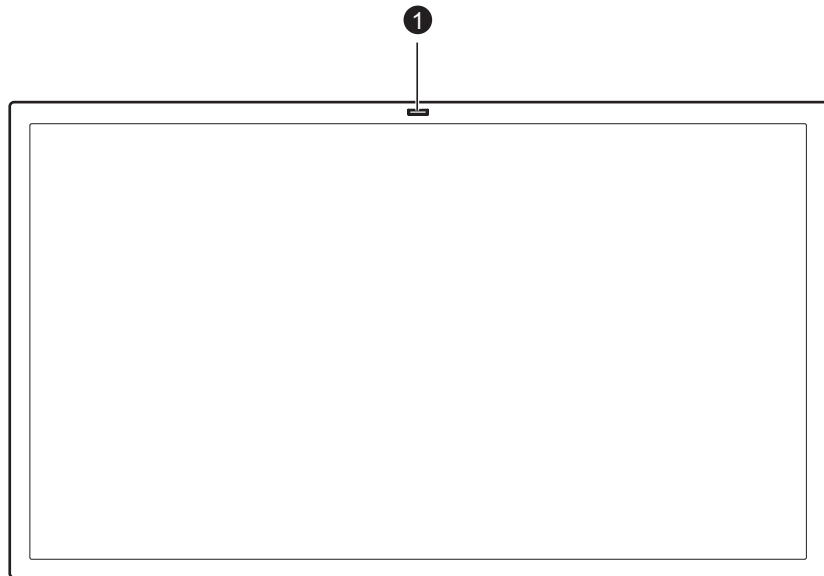

① Remote control sensor/Ambient light sensor/Power LED indicator

- Receives the signal from the wireless remote control.
- Automatically detects ambient lighting condition and adjusts screen brightness.
- Indicates the power status of the monitor.

| Status | Color |
|---------------|--------|
| Power ON | Green |
| Power OFF | Off |
| Power Standby | Orange |

Control Panel

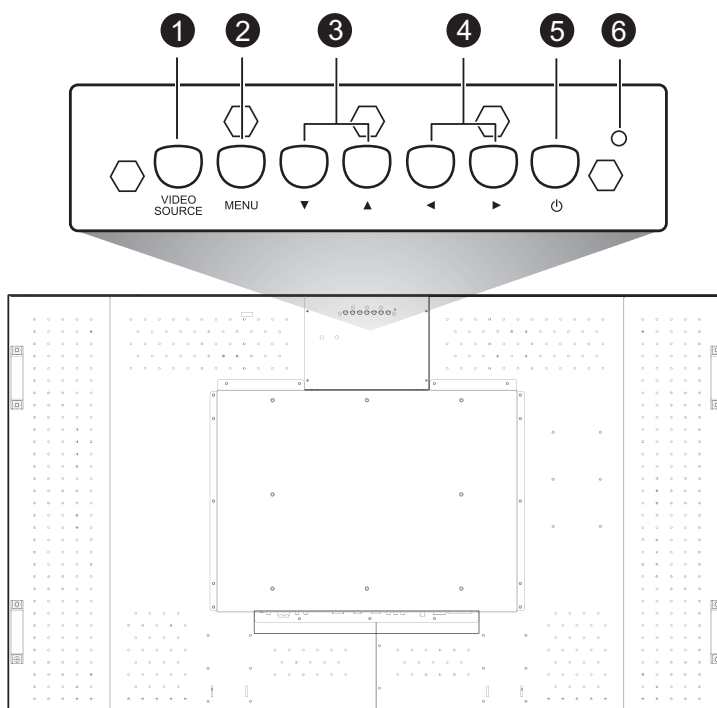

- ❶ **VIDEO SOURCE button** - Press this button to select an input source. Acts as SET button with OSD menu.
- ❷ **MENU button** - Activates the OSD menu when the OSD menu is turned-off. Acts as EXIT button to move to previous menu with OSD menu.
- ❸ **▲/▼ button** - Moves the selection highlight up or down in the OSD menu.
- ❹ **◀/▶ button** - Moves the selection highlight left or right in the OSD menu.
- ❺ **POWER button (⏻)** - Switches the power on/off.
- ❻ **Power indicator** - Glows green when the LCD monitor power is ON. Glows red when the LCD monitor is in the standby mode. Off when the main power is OFF.

Control Button Lock Function

| To activate/deactivate these lock functions.... | Press these buttons... | Description |
|---|--|--|
| Button lock | Press and hold the ◀ and ▶ buttons simultaneously for 5 seconds. | Locks/unlocks all control buttons except the POWER button (⏻). |
| Menu lock | Press and hold the ▲ and ▼ buttons simultaneously for 5 seconds. | Locks/unlocks the MENU button. |
| Power lock | Press and hold the MENU and ▶ buttons for 5 seconds. | <ul style="list-style-type: none"> • Locks/unlocks the POWER button (⏻). • Keeps power status after re-plugging the power cord. |
| IR lock | Press and hold the MENU and ◀ buttons for 5 seconds. | Locks/unlocks the wireless remote control function. |

Terminal Panel

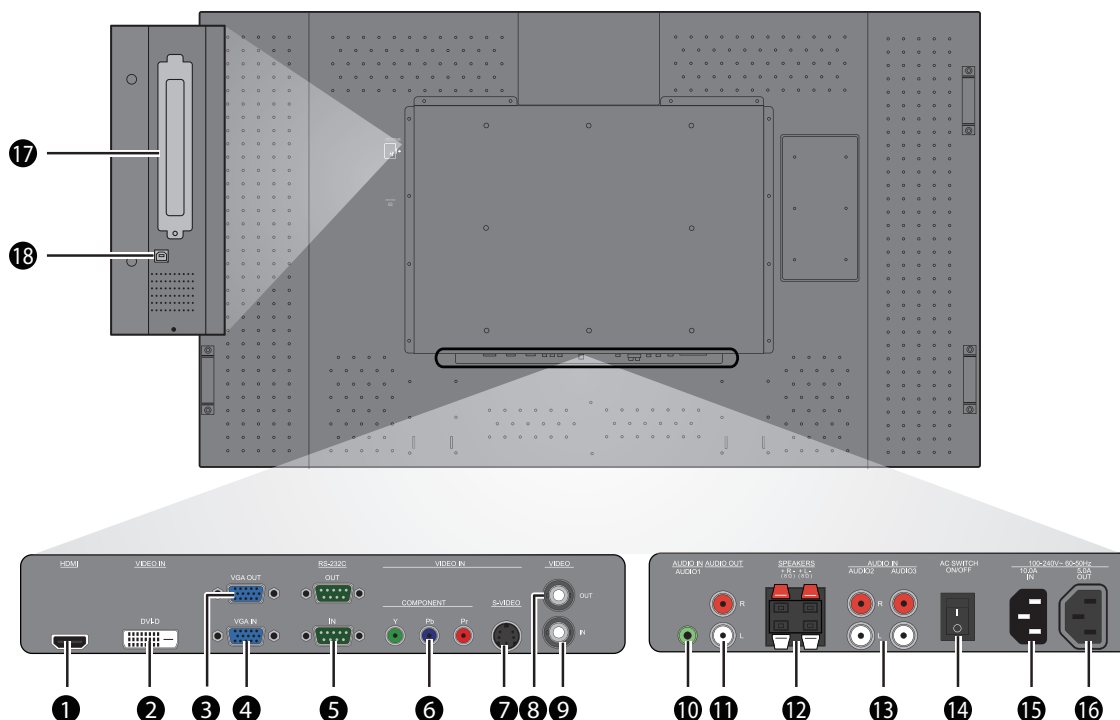

1 HDMI

Connects to the HDMI output of an AV device or to the DVI-D output of a PC. (Using a DVI-HDMI cable/adapter)

2 VIDEO IN (DVI-D)

Connects to the DVI-D output of a PC or to the HDMI output of an AV device (Using a DVI-HDMI cable).

3 VGA OUT

Outputs the VGA signal from the **VGA IN** jack.

4 VGA IN

Connects to the VGA output of a PC or media player.

5 RS232C (IN/OUT)

RS232C network connection input/output for the use of loop through function.

6 VIDEO IN (COMPONENT)

Component video input (YPbPr) for connecting to the component output of an AV device.

7 VIDEO IN (S-VIDEO)

S-Video input for connecting to the S-Video output of an AV device.

8 VIDEO OUT

Connects to the video input of an AV device or another BDL6545AT display.

9 VIDEO IN

Connects to the video output of an AV device or another BDL6545AT display.

10 AUDIO IN (AUDIO1)

Connects to the audio output of a computer.

11 AUDIO OUT R/L

Outputs the audio signal from the **AUDIO IN (AUDIO1/AUDIO2/AUDIO3)** or **HDMI** jack.

12 SPEAKERS R/L

Outputs the audio signal from the **AUDIO IN (AUDIO1/AUDIO2/AUDIO3)** or **HDMI** jack to external speakers.

13 AUDIO IN (AUDIO2/AUDIO3)

Connects to the audio output of an AV device.

14 Main power switch

Press to switch the main power on/off.

15 AC IN (10.0 A)

Connects the supplied power cord to the wall outlet.

16 AC OUT (5.0 A)

Can be used to power an external media device.

17 Slot for an OPS (Open Pluggable Specification) module

18 Touch module

Connects to the USB port of a computer.

IR Remote Control

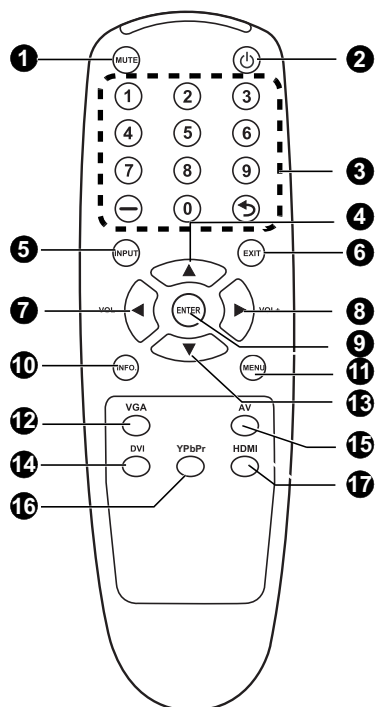

❶ MUTE button

To switch the mute function on/off.

❷ Power button

Switches the power on/off.

*If the Power indicator on the monitor is not glowing, then no controls will work.

❸ Number buttons

These buttons are not used and do not work.

❹ UP button

Acts as ▲ button to move the highlighted area up to select the adjustment with OSD menu.

❺ INPUT button

Selects from input signal: [AV], [S-Video], [VGA], [YPbPr], [DVI] and [HDMI].

❻ EXIT button

Turns to previous menu with OSD menu.

❼ ◀ /Volume - button

- Decreases the audio output level.
- Acts as ◀ button to move the highlighted area left to select the adjustment with OSD menu.

❽ ▶ /Volume + button

- Increases the audio output level.
- Acts as ▶ button to move the highlighted area right to select the adjustment with OSD menu.

❾ ENTER button

Acts as SET button with OSD menu.

❿ Information button

Displays information about the current status of the monitor.

⓫ MENU button

Displays or hides the OSD menu.

⓬ VGA button

Selects VGA as the input signal.

⓭ DOWN button

Acts as ▼ button to move the highlighted area down to select the adjustment with OSD menu.

⓮ DVI button

Selects DVI as the input signal.

⓯ AV button

Selects AV as the input signal.

⓰ YPbPr button

Selects YPbPr as the input signal.

⓱ HDMI button

Selects HDMI as the input signal.

Installing the Remote Control Batteries

The remote control is powered by 1.5V AAA batteries. To install or replace batteries:

1. Press and slide to open the cover.
2. Align the batteries according to the (+) and (-) indications inside the case.
3. Replace the cover.

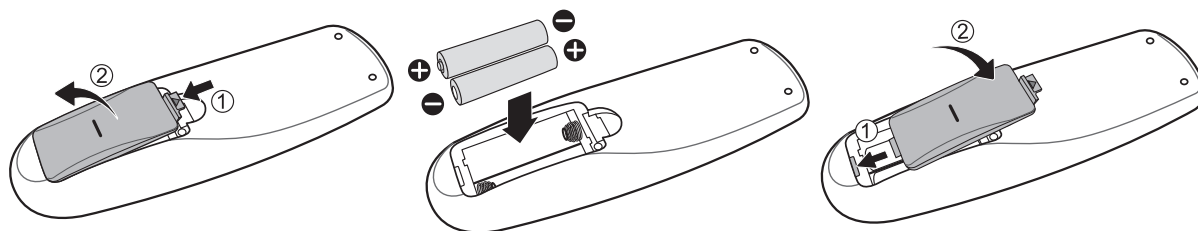

CAUTION:

Incorrect use of batteries can result in leaks or bursting. Be careful especially about the following points.

- Place "AAA" batteries matching the + and - signs on each battery to the + and - signs of the battery compartment.
- Do not mix battery types.
- Do not combine new batteries with used ones. It causes shorter battery life or leakage of batteries.
- Remove dead batteries immediately to prevent battery liquid from leaking into the battery compartment. Don't touch exposed battery acid, it cause damage to your skin.

NOTE:

If you do not intend to use the Remote Control for a long period, remove the batteries.

Operating Range for the Remote Control

Point the top of the remote control toward the LCD monitor's remote sensor during button operation. Use the remote control within a distance of about 10 m/32.8 ft. from the front of the LCD monitor's remote control sensor and at a horizontal and vertical angle of within 45°.

CAUTION:

Important, the remote control system may not function when direct sunlight or strong illumination strikes the remote control sensor of the LCD monitor, or when there is an object in the path.

Handling the Remote Control

- Do not subject to strong shock.
- Do not allow water or other liquid to splash the remote control. If the remote control gets wet, wipe it dry immediately.
- Avoid exposure to heat and steam.
- Other than to install the batteries, do not open the remote.

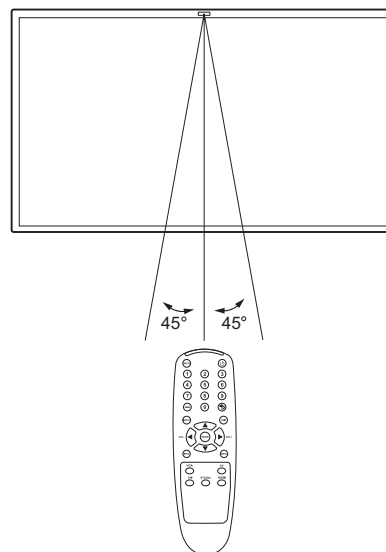

Setup Procedure

1. Determine the installation location

CAUTION: DO NOT ATTEMPT TO INSTALL THE LCD MONITOR BY YOURSELF. Installation of your LCD monitor must be done by a qualified technician. Contact your dealer for more information.

CAUTION: MOVING OR INSTALLING THE LCD MONITOR MUST BE DONE BY TWO OR MORE PEOPLE. Failure to follow this caution may result in injury if the LCD monitor falls.

CAUTION: Do not mount or operate the monitor upside down, face up, or face down.

CAUTION: Do not install the LCD monitor where it will be exposed to direct sunlight, as this will result in display defects.

IMPORTANT:

Lay the protective sheet, which was wrapped around the LCD monitor when it was packaged, beneath the LCD monitor so as not to scratch the panel.

2. Connect external equipment

To protect the connected equipment, turn off the main power before making connections.

Refer to your equipment user manual.

3. Connect the supplied power cord

The power outlet socket should be installed as near to the equipment as possible, and should be easily accessible.

Fully insert the prongs into the power outlet socket. Loose connection may cause noise.

NOTE:

- Please refer to “Safety Precautions, Maintenance & Recommended Use” section of this manual for proper selection of AC power cord.
- When installing the LCD monitor, incorporate a readily accessible disconnect device in the fixed wiring, or connect the power cord to socket-outlet which must be provided near the LCD monitor and easily accessible. If a fault should occur during operation of the unit, operate the disconnect device to switch the power supply off, or disconnect the power cord.

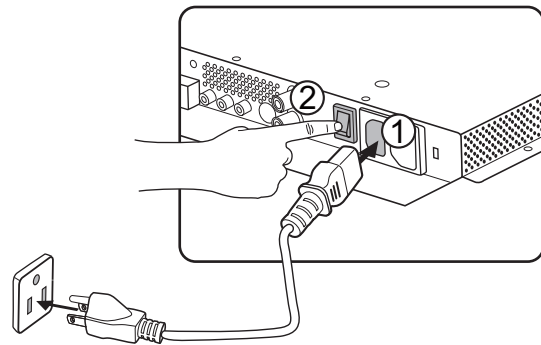

4. Switch on the power of all the attached external equipment

When connected to a computer, switch on the power of the computer first.

5. Operate the attached external equipment

Display the signal on the external equipment you wish.

6. Adjust the sound

Make adjustments lowering or raising the volume as required.

7. Adjust the screen

Make adjustments to the display position or settings if required.

8. Adjust the image

Make adjustments to brightness or contrast if required.

9. Recommended adjustment

To reduce the risk of “image persistence”, please adjust the following items based on the application being used: “Power save” and “Image retention”.

How to Mount and Attach Options to the LCD Monitor

Lay the protective sheet on a table, which was wrapped around the monitor when it was packaged, beneath the screen surface so as not to scratch the screen face.

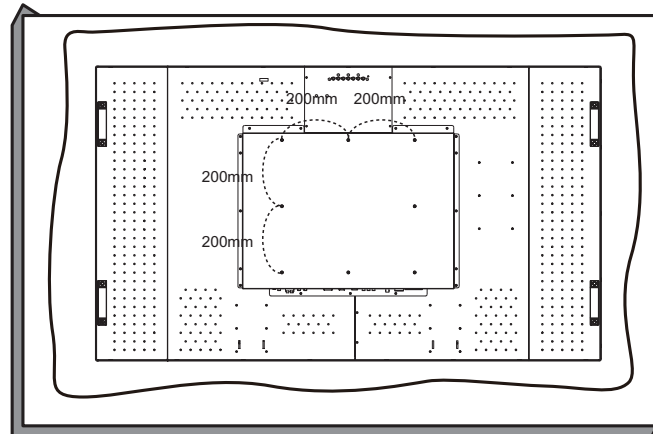

This device cannot be used or installed without the Tabletop Stand or other mounting accessory. Failure to follow correct mounting procedures could result in damage to the equipment or injury to the user or installer. Product warranty does not cover damage caused by improper installation.

Failure to follow these recommendations could result in voiding your warranty.

Use M6 mounting screws (having a length 10-15mm longer than the thickness of the mounting bracket) and tighten them securely. (Recommended torque: 470 - 635N•cm). The mounting interface should comply with the UL1678 standard in North America. The mounting means should be strong enough to bear the weight of the monitor (approx. 27.2kg without stand). ViewSonic recommends using mounting interface that comply with TÜV-GS standard.

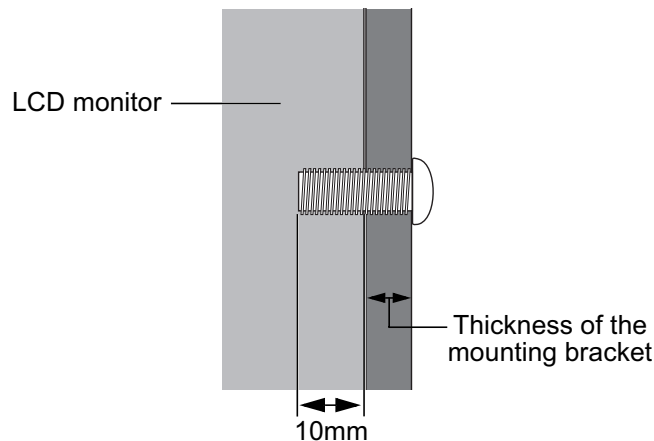

Caution:

For preventing the monitor from falling.

- Install the monitor with metal brackets for wall or ceiling installation (commercially available) on your own responsibility. For detailed procedures of installation, refer to the instructions of the metal brackets.
- To lessen the probability of injury and damage resulting from fall of the monitor in case of earthquake or other disaster, be sure to consult the bracket manufacturer for installation location.
- Do not sleep where the monitor may topple over or fall in case of an earthquake or other disaster.

Ventilation Requirements for Enclosure Mounting

To allow heat to disperse, leave space between surrounding objects as shown in the diagram below.

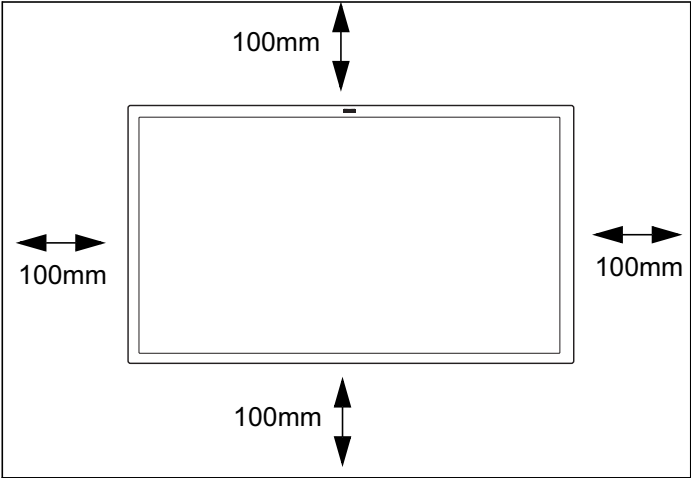

Connections

Before Making Connections:

- First turn off the power of all attached equipment and then make connections.
- Refer to the user manual included with each separate piece of equipment.

Wiring Diagram

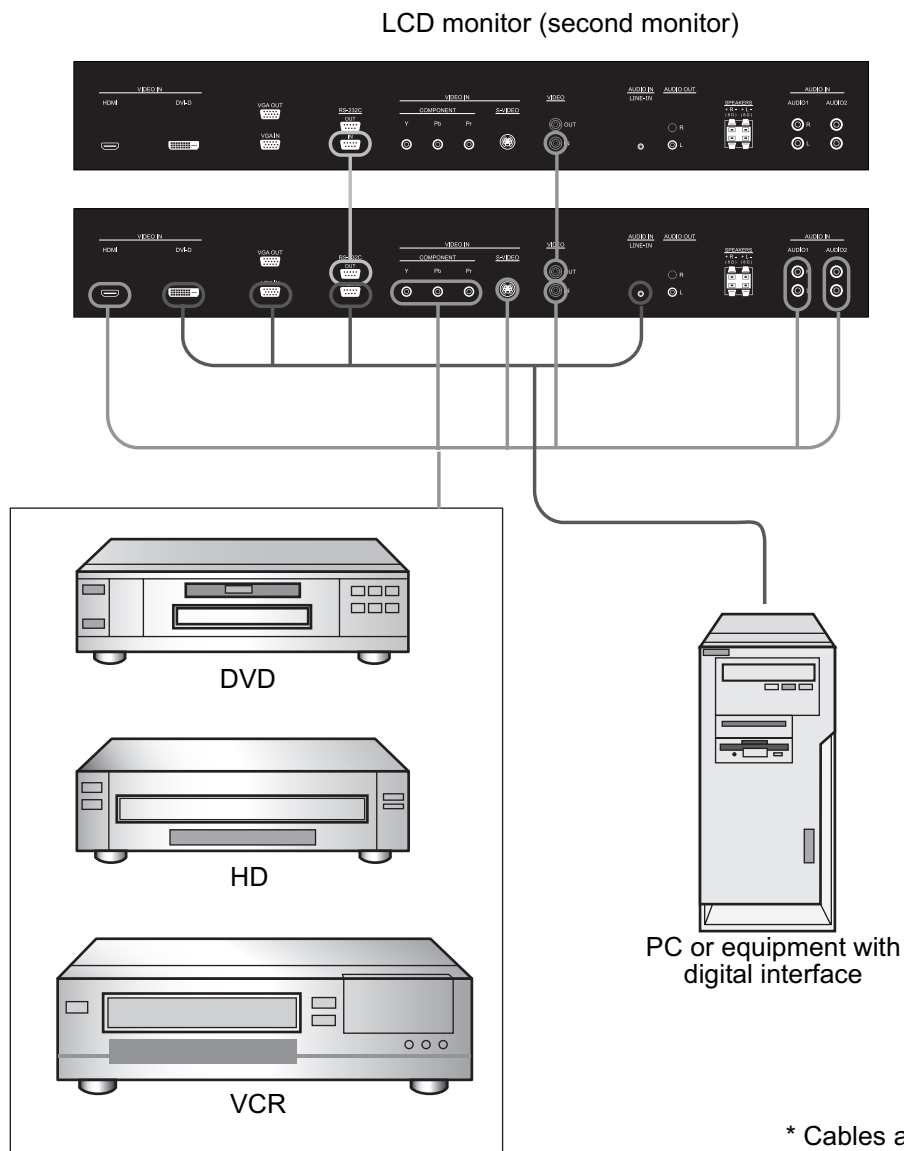

Connecting a Personal Computer

Connecting your computer to your LCD monitor will enable you to display your computer's screen image. Some video cards may not display an image correctly.

Connect the LCD Monitor to a Personal Computer

- To connect the VGA IN connector (mini D-sub 15 pin) on the LCD monitor, use a PC - Video RGB signal cable (mini D-sub 15 pin to mini D-sub 15 pin).
- When connecting one or more LCD monitors, use the VGA OUT connector (mini D-sub 15 pin).
- The LINE-IN jack can be used for audio input.
- The SPEAKERS jack outputs sound from the selected Audio input.

LCD monitor (second monitor)

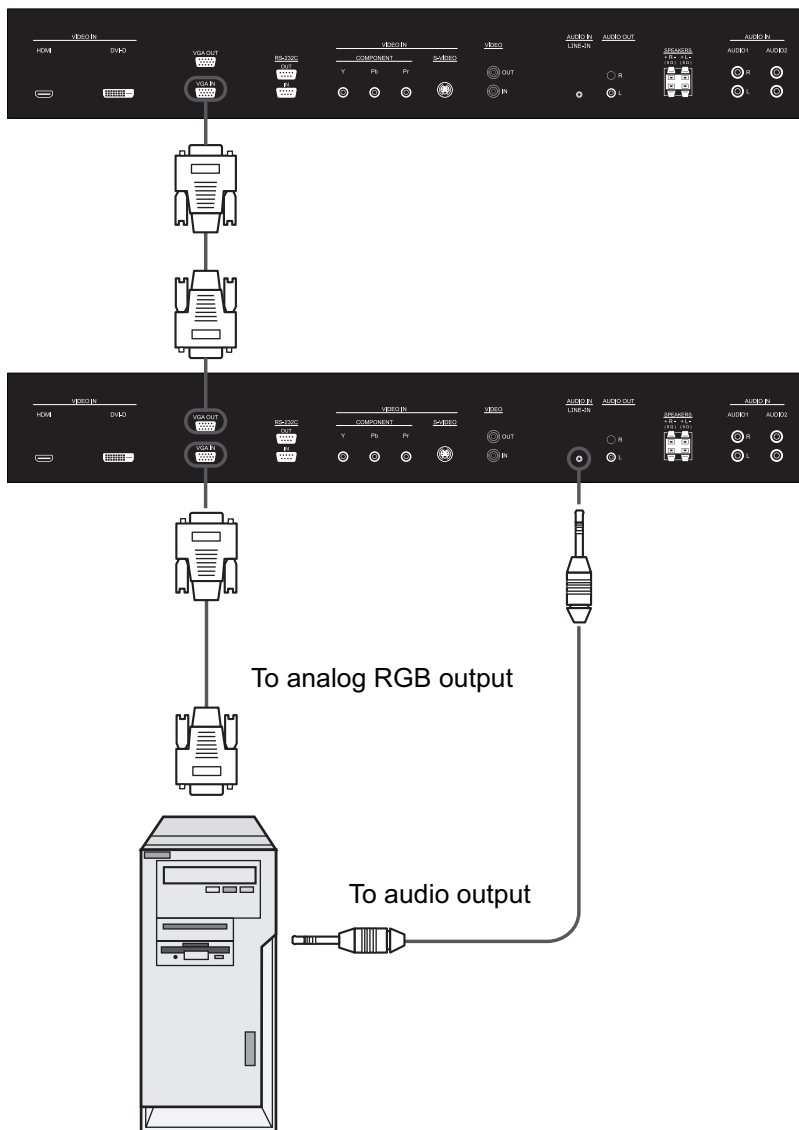

* Cables are not supplied

Connecting with Digital Interface Equipment

Connections can be made with equipment that is equipped with a digital interface compliant with the DVI (Digital Visual Interface) standard.

Connect the LCD Monitor to a Computer with a Digital Output

- The HDMI connector accepts an HDMI cable or a DVI-D to HDMI cable.
- The HDMI connector can connect to the HDMI output or DVI-D output of a PC.
- To maintain display quality, use a cable with a quality prescribed by HDMI and DVI standards.
- The LINE-IN jack can be used for audio input.
- The signal input from the HDMI connector cannot be output to the VGA OUT connector.

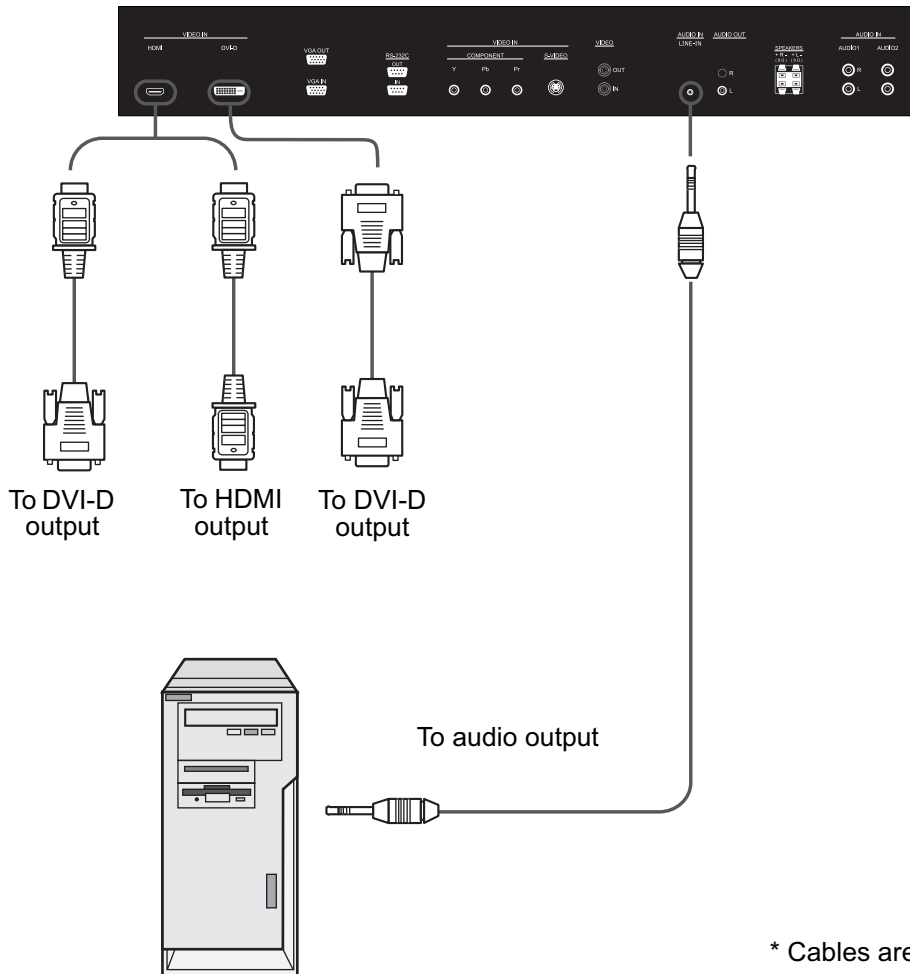

* Cables are not supplied

Connecting a DVD Player with Component Output

Connecting your DVD player to your LCD monitor will enable you to display DVD video. Refer to your DVD player owner's manual for more information.

Connect the LCD Monitor to a DVD Player

- Connect the COMPONENT jacks of the LCD monitor to the Y Pb Pr output of the DVD player. Alternatively, you can also use an HDMI cable to connect the HDMI jack of the LCD monitor to the HDMI output of the DVD player.
- The AUDIO IN jacks can be used for audio input. Do not reverse the audio left and right jacks.

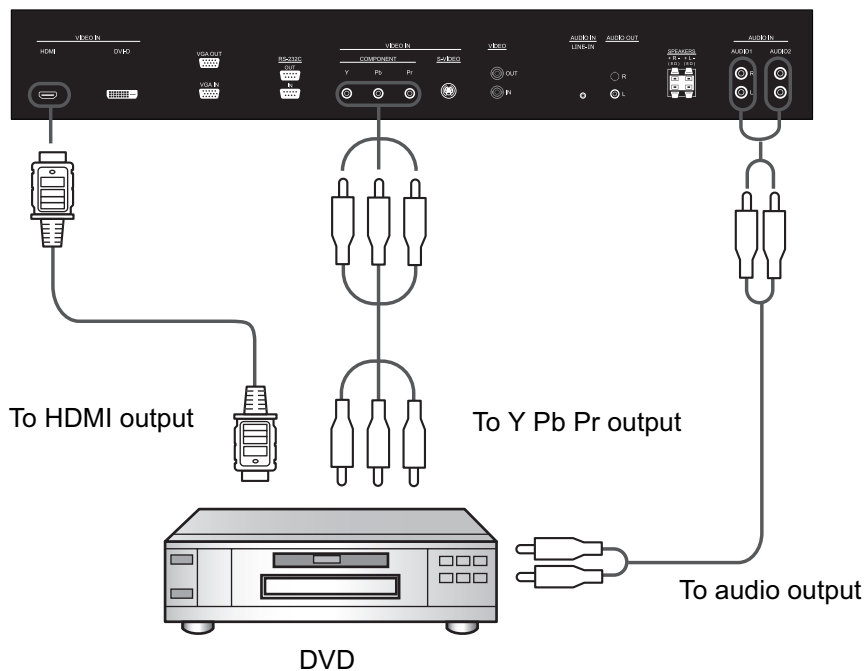

* Cables are not supplied

Connecting a VCR with Composite (CVBS) and S-Video outputs

Connecting your VCR to your LCD monitor will enable you to display video from the VCR. Refer to your VCR owner's manual for more information.

Connect the LCD Monitor to a VCR

- Connect the VIDEO-IN jack of the LCD monitor to the composite (AV) output of the VCR. Alternatively, you can also use an S-Video cable to connect the S-VIDEO jack of the LCD monitor to the S-Video output of the VCR.
- The AUDIO IN jacks can be used for audio input. Do not reverse the audio left and right jacks.

LCD monitor (second monitor)

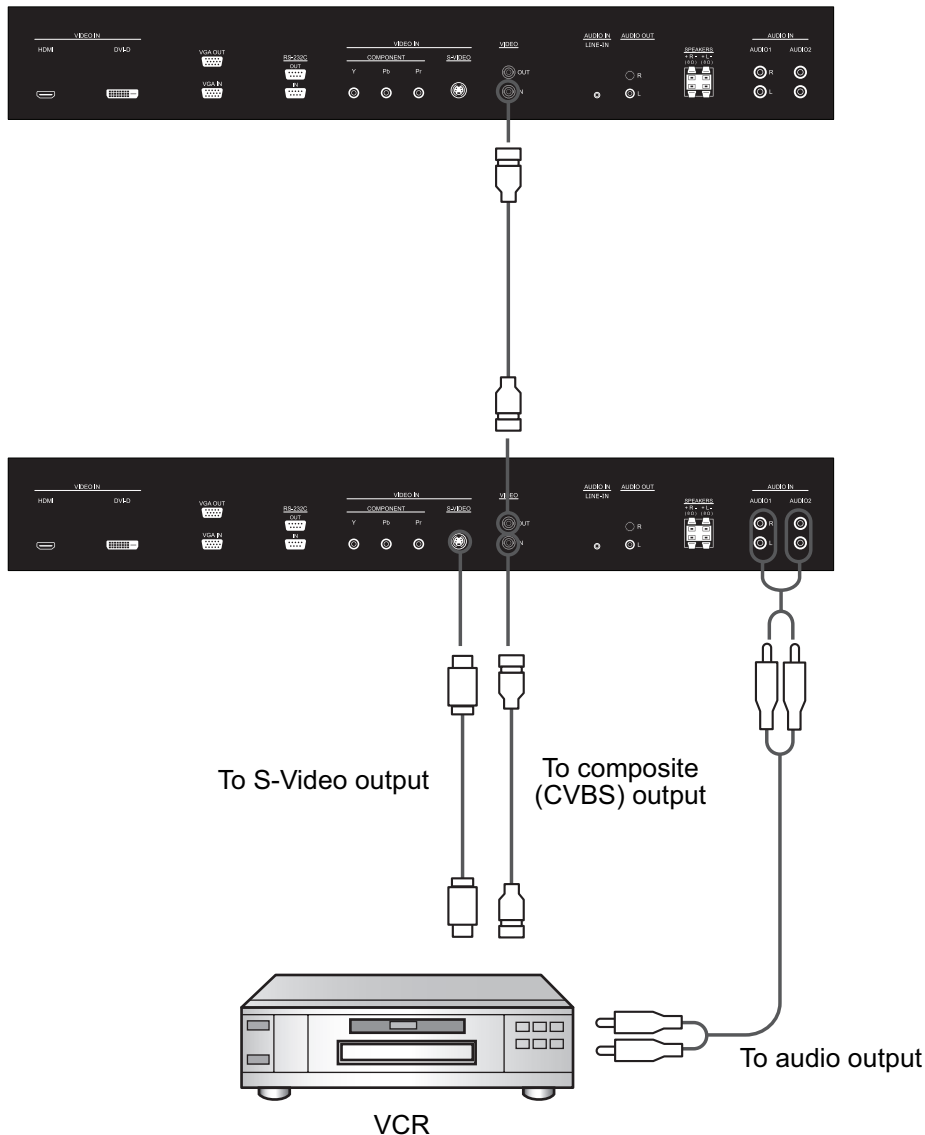

* Cables are not supplied

Connecting to External Speakers

This LCD monitor has a built-in 12W +12W amplifier, so you can connect your external speakers to the LCD monitor directly. Refer to your external speakers' owner's manual for more information.

Connect the LCD Monitor to External Speakers

- Connect the lead wires of the external speakers to the SPEAKERS jacks of the LCD monitor. Do not reverse the audio left and right jacks.

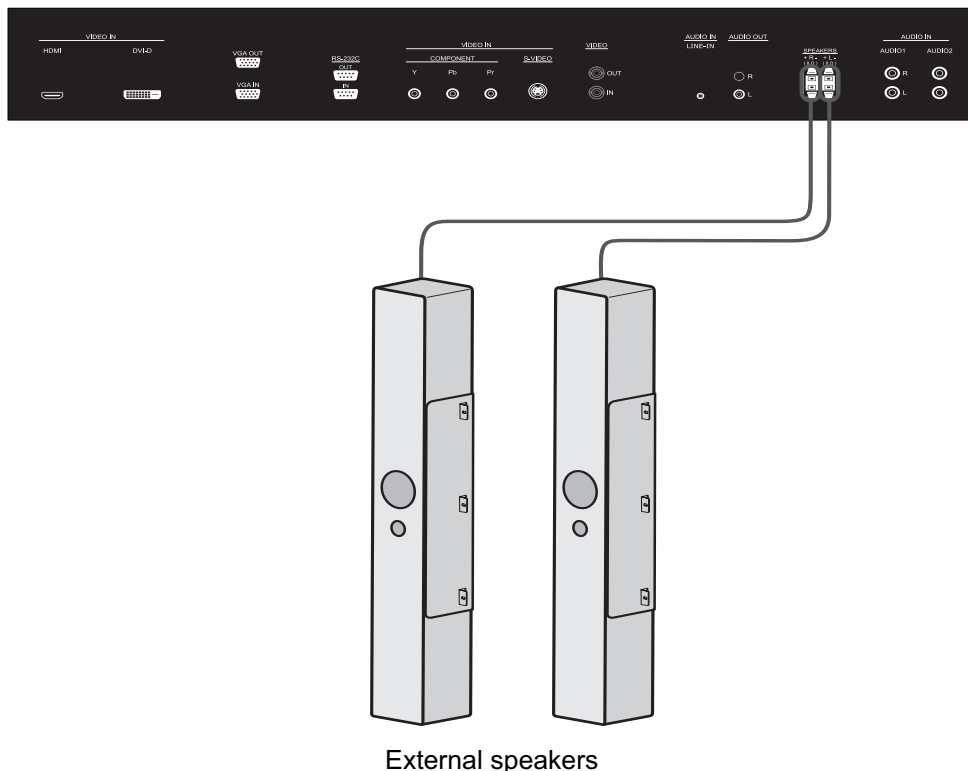

CONNECTING THE TOUCH MODULE

- There are two ways to connect the touch module.

1. Connect the USB cable on the display to a PC.

The touch module supports easy Plug-and-Play operations. There is no need to install additional drivers on the PC.

2. Install an OPS (Open Pluggable Specification) module in to the slot on the rear of the display. Refer to the module's documentation for user instructions.

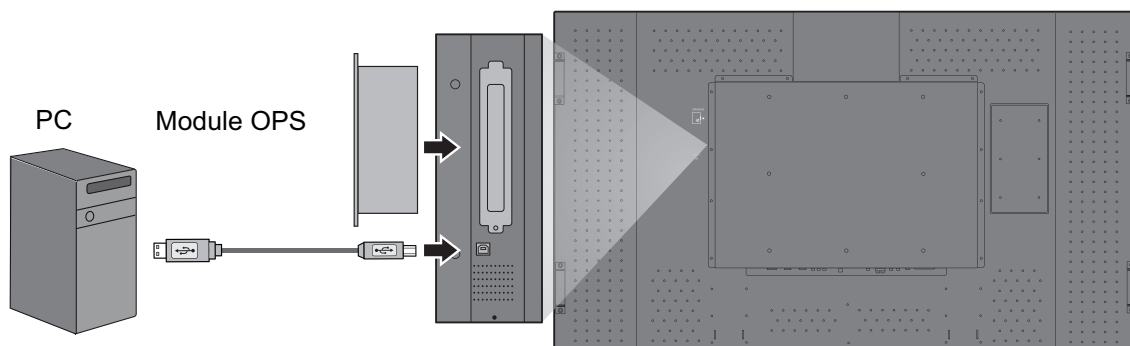

USING THE TOUCH SCREEN

You can use the optical touch screen to control your operating system. The touch screen can emulate basic mouse functions and supports multi-touch functions for Windows 7*. The following table shows a list of gestures you can use on the touch screen.

Note: Ensure that you have installed the USB cable on the display to a PC.

*Multi-touch functions are only supported by Windows 7 - Home Premium, Professional, Enterprise and Ultimate versions. For Windows XP, Windows Vista and Windows 7 - Starter and Home Basic versions, multi-touch is not supported.

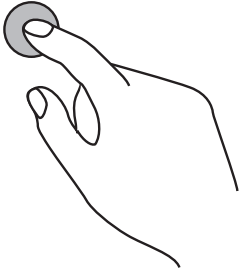
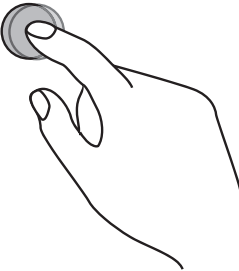
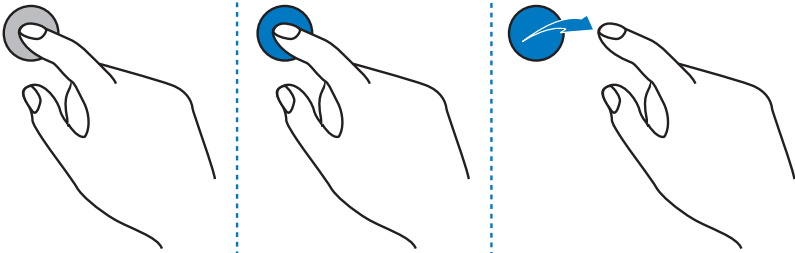
| OS functions | Gesture actions |
|--|--|
| <i>For Windows XP, Windows Vista and Windows 7</i> | |
| Click | <p>Tap the screen once.</p>  |
| Double-click | <p>Tap the screen twice.</p>  |
| Right-click | <ol style="list-style-type: none"> 1. Press on the target. 2. Hold and wait for a blue ring to appear. 3. Release your finger.  |

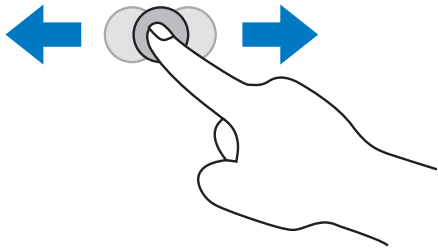
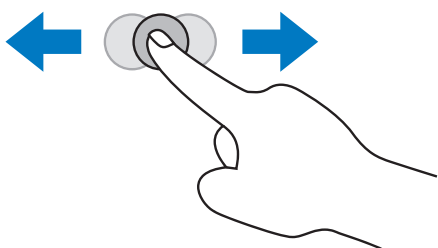
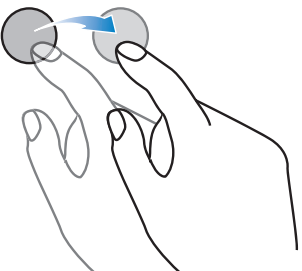
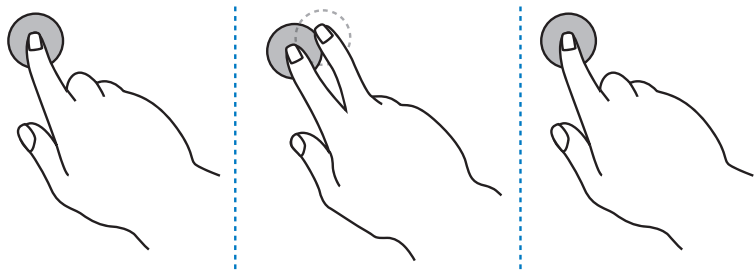
| OS functions | Gesture actions |
|---|---|
| <p>Drag</p> | <p>Drag one finger left or right.</p>  |
| <p><i>For Windows Vista and Windows 7</i></p> | |
| <p>Selection</p> | <p>Drag one finger left or right.</p>  |
| <p>Pan up / Pan down / Back / Forward</p> | <p>Quickly drag your finger (Flick) in a desired direction.</p>  |
| <p><i>Multi-touch functions</i> <i>For Windows 7 - Home Premium, Professional, Enterprise and Ultimate versions</i></p> | |
| <p>Right-click</p> | <ol style="list-style-type: none"> 1. Press on the target. 2. Tap the screen with another finger. 3. Release the second finger.  |

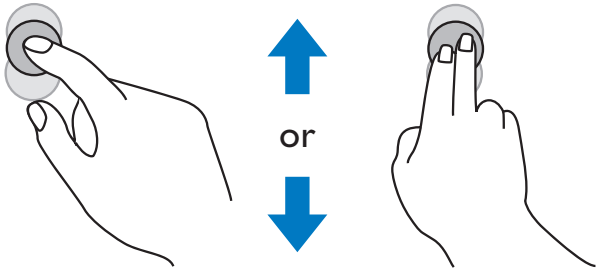
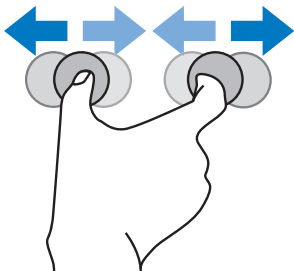
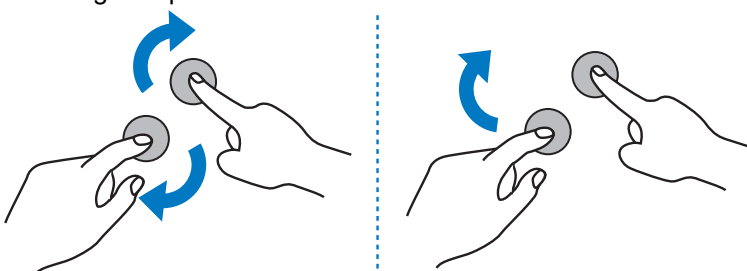
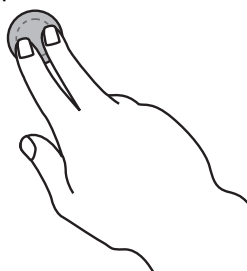
| OS functions | Gesture actions |
|------------------------------------|--|
| Scrolling | <p>Drag one or two fingers up or down.</p>  |
| Zoom | <p>Move two fingers apart or toward each other.</p>  |
| Supported by specific applications | <ul style="list-style-type: none"> • Move two fingers in opposing directions. • Use one finger to pivot around another.  |
| Supported by specific applications | <p>Tap two fingers simultaneously. The target should be the midpoint between the fingers.</p>  |

For Windows XP, Windows Vista and Windows 7

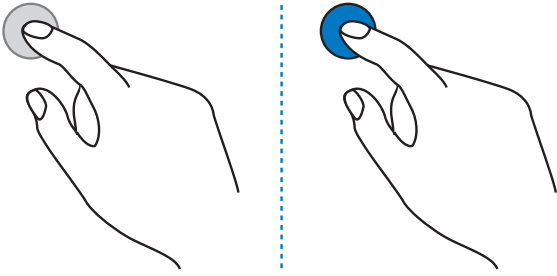
| OS functions | Gesture actions |
|-------------------------------------|---|
| Wakeup from Windows sleep mode (S3) | <p data-bbox="424 253 778 282">Press and hold for 4 seconds.</p>  |

Basic Operation

Power ON and OFF Modes

The LCD monitor power indicator will turn green while powered on or red in off mode. The monitor can be powered on or off using the following two options:

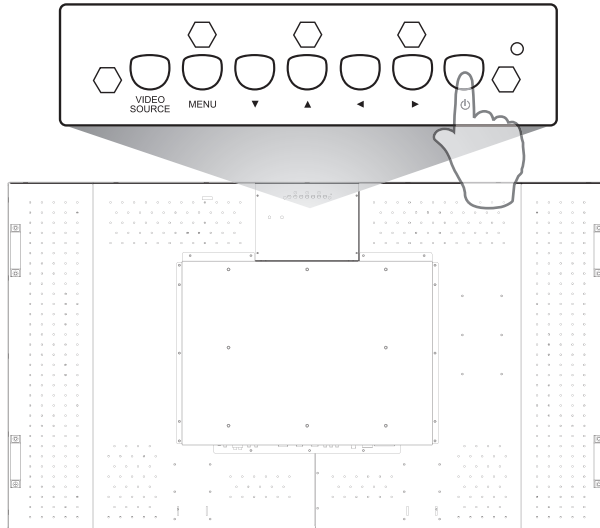

1. Pressing the power button.

NOTE:

Before pressing the power button, ensure that you have connected the supplied power cord to the LCD monitor and a wall outlet and turned on the main power switch.

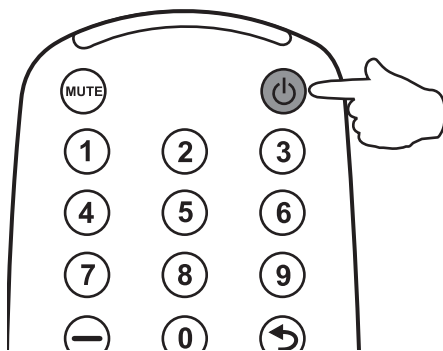

2. Using the remote control.

NOTE:

Before operating the remote control, ensure that you have connected the supplied power cord to the LCD monitor and a wall outlet and turned on the main power switch.

Power Indicator

| Status | Color |
|---------------|-------|
| Power ON | Green |
| Power OFF | Off |
| Power Standby | Red |

Using Power Management

The LCD monitor follows the VESA approved DPM Power Management function.

The power management function is an energy saving function that automatically reduces the power consumption of the monitor when the keyboard or the mouse has not been used for a fixed period.

The power management feature on your new monitor has been set to the "ON" mode. This allows your monitor to enter a Power Saving Mode when no signal is applied. This could potentially increase the life and decrease the power consumption of the monitor.

Selecting a Video Source

Normally the CDP6530 LCD monitor automatically searches for available video sources after it is turned on. You can also manually select one if multiple video sources are connected to the LCD monitor.

To select a video source using the control panel:

1. Press the **VIDEO SOURCE** button on the control panel to display the Input Source menu.
2. Press the **VIDEO SOURCE** button several times, or press the **▲** or **▼** button to select an input source.

To select a video source using the wireless remote control:

1. Press the **INPUT** button on the remote control to display the Input Source menu.
2. Press the **INPUT** button several times, or press the **▲** or **▼** button on the remote control to select an input source.

You can also press the **AV**, **VGA**, **DVI**, **HDMI** or **YPbPr** button according to the video source you wish to view.

Picture Mode

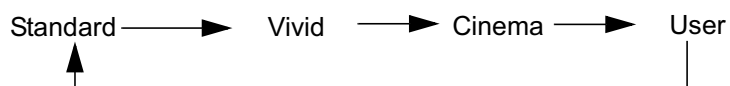



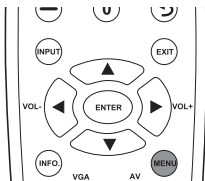
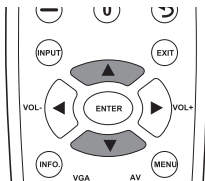
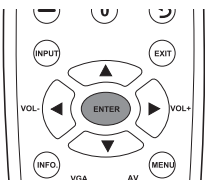
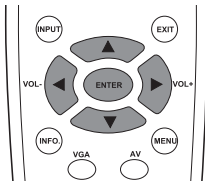
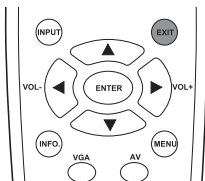

OSD (On-Screen-Display) Controls

Remote Control

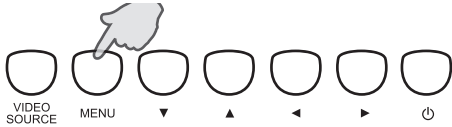
1. Press the **MENU** button to open the main menu.
 
2. Press the **▲** or **▼** button to select a sub-menu.
 
3. Press **ENTER** to decide.
 
4. Press the **▲** or **▼** button to select a function, or control which you like, and press **◀** or **▶** to adjust, or press the **ENTER** button to decide.
 
5. Press the **EXIT** button to exit.
 

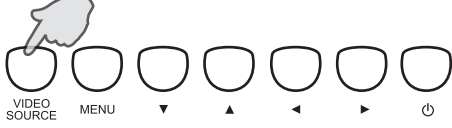
Control Panel

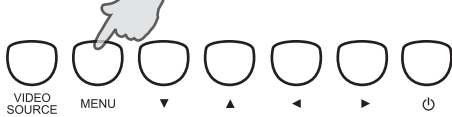
1. Press the **MENU** button to open the main menu.
 
2. Press the **▲** or **▼** button to select a sub-menu.
 
3. Press the **VIDEO SOURCE** button to decide.
 
4. Press the **▲** or **▼** button to select a function, or control which you like, and press **◀** or **▶** to adjust, or press the **VIDEO SOURCE** button to decide.
 
5. Press the **MENU** button to exit.
 

Picture

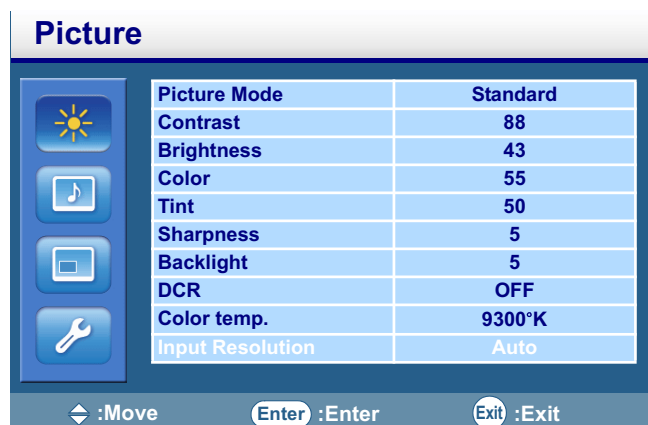

Picture Mode

- Allows you to choose from the following preset picture modes: **Standard**, **Vivid**, **Cinema** and **User**.
- Press **ENTER**, and then the **▲** or **▼** button to change selection.

Contrast

- Adjusts the image brightness in relation to the input signal.
- Press the **▶** button to increase contrast, or the **◀** button to decrease contrast.

Brightness

- Adjusts the image brightness in relation to the background.
- Press the **▶** button to increase brightness, or the **◀** button to decrease brightness.

Color

- Adjusts the image color intensity.
- Press the **▶** button to increase color intensity, or the **◀** button to decrease color intensity.

Note: This item is not available for the VGA and DVI inputs.

Tint

- Adjusts the image color tint.
- Press the **▶** button to change the color to a greenish tone, or the **◀** button to change the color to a purplish tone.

Note: This item is not available for the VGA and DVI inputs.

Sharpness

- This function is digitally capable to keep crisp image at any timings. It is adjustable to get a distinct image or a soft one as you prefer and set independently for each picture mode.
- Press the **▶** button to increase sharpness, or the **◀** button to decrease sharpness.

Backlight

- Adjusts the backlight intensity of the LCD screen.
- Press the **▶** button to increase backlight intensity, or the **◀** button to decrease backlight intensity.

Note: This item is not available if the Ambient Light Sensor function is set to HIGH or LOW.

DCR (Dynamic Contrast Ratio)

- When turned on, this function helps enhance image contrast when displaying dark scenes.
- Press **ENTER**, and then the **▲** or **▼** button to turn this function on or off.

Note: This item is not available if the Ambient Light Sensor function is set to HIGH or LOW.

Color temp.

- Use to choose a color temperature.
- Press **ENTER**, and then the **▲** or **▼** button to select **12000°K**, **9300°K**, **6500°K**, **5800°K** or **User**.
- If **User** is selected, you can adjust the **Red**, **Green** and **Blue** settings separately.

Input Resolution

Note: This item is only available for the VGA input.

- Set the resolution of the VGA input. This is only required when the monitor is unable to detect the VGA input resolution correctly.
- Press **ENTER**, and then the ▲ or ▼ button to select **1366x768**, **1360x768**, **1280x768** or **Auto**.

Sound

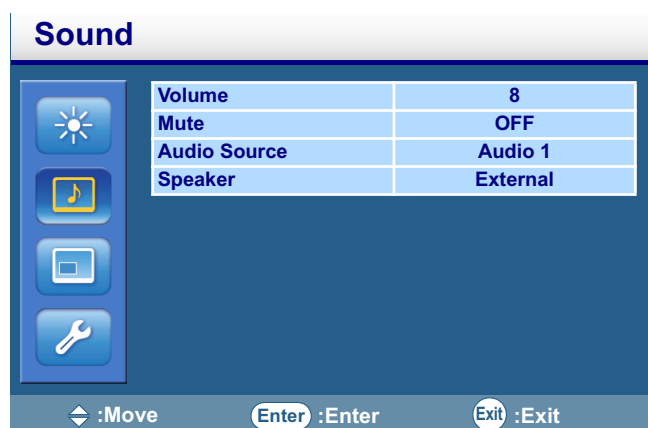

Volume

- Adjusts the audio volume.
- Press the ► button to increase volume, or the ◀ button to decrease volume.

Mute

- Turns audio off temporarily.
- Press **ENTER**, and then the ▲ or ▼ button to turn this function on or off.

Audio Source

- Selects the audio input source. You can use this function to select an audio input source from **Audio 1** (from the AUDIO IN R/L AUDIO1 jacks), **Audio 2** (from the AUDIO IN R/L AUDIO2 jacks), **Line-in** (from the LINE-IN jack) or **HDMI** (from the HDMI jack, only available when HDMI signal is detected).

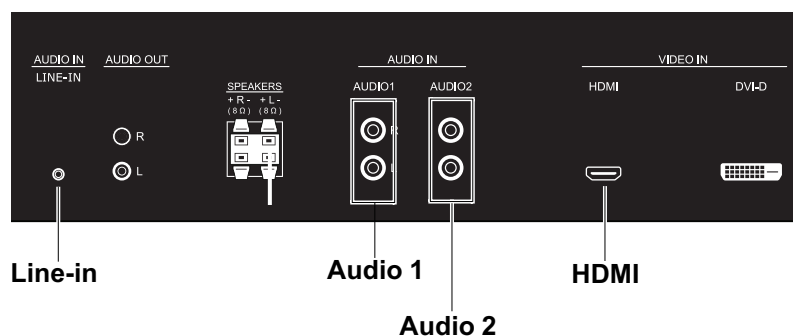

- Press **ENTER**, and then the ▲ or ▼ button to change selection.

Speaker

- Selects an audio output source from the built-in speaker (**Internal**), external speakers (**External**) or external audio devices (**Line-out**).
- Press **ENTER**, and then the ▲ or ▼ button to change selection.

Option

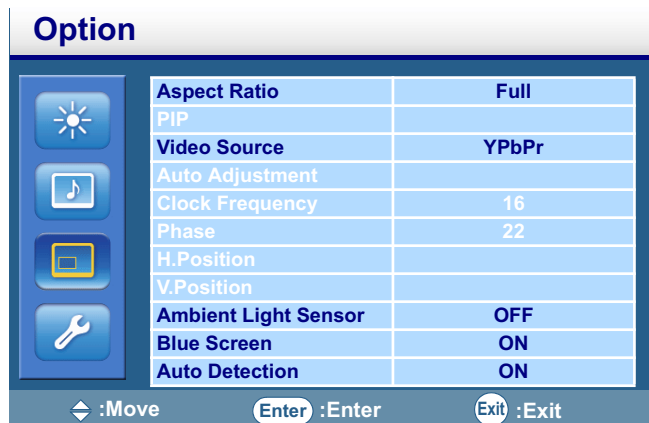

Aspect Ratio

- With this function, you can choose to let the LCD monitor display the input image in its original aspect ratio (when **Original** is selected), or force the LCD monitor to fill the input image on the entire display area (when **Full** is selected).
- Press **ENTER**, and then the ▲ or ▼ button to change selection.

PIP (Picture in Picture)

Note: This item is not available for the AV and S-Video inputs.

- Press **ENTER** to display the sub-menu:

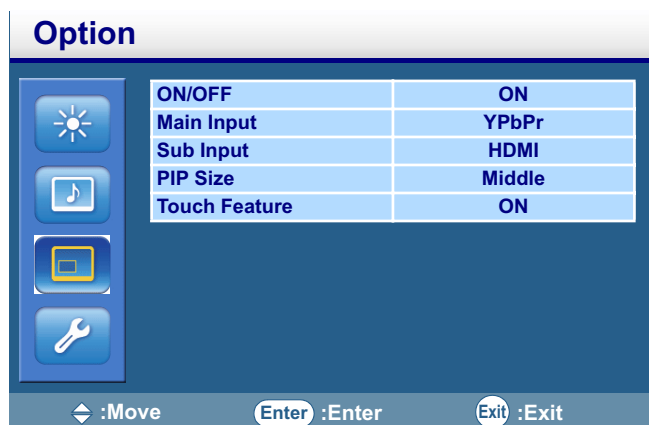

- **ON/OFF:** Turns on or off the PIP function of this LCD monitor. Press **ENTER**, and then the ▲ or ▼ button to turn this function on or off.
- **Main Input:** Selects the input source for the main picture. Press **ENTER**, and then the ▲ or ▼ button to change selection.
- **Sub Input:** Selects the input source for the sub picture. Press **ENTER**, and then the ▲ or ▼ button to change selection.
- **PIP Size:** Changes the size of the sub picture. Press **ENTER**, and then the ▲ or ▼ button to change selection.
- The availability of the PIP function is determined by the signal source combination. Please refer to the table below. (○: PIP function available, ×: PIP function unavailable)

| | | Main picture signal source | | | | | |
|---------------------------|---------|----------------------------|---------|-----|-------|-----|------|
| | | AV | S-Video | VGA | YPbPr | DVI | HDMI |
| Sub picture signal source | AV | × | × | × | × | × | × |
| | S-Video | × | × | × | × | × | × |
| | VGA | × | × | × | × | ○ | ○ |
| | YPbPr | × | × | × | × | ○ | ○ |
| | DVI | × | × | ○ | ○ | × | × |
| | HDMI | × | × | ○ | ○ | × | × |

Notes:

- In PIP mode, only the audio from the Main Input picture will be available.

- Refer to page 43 for more information on all supported signal source types and resolutions in PIP mode.

Video Source

- Selects an input source for the LCD monitor to display.
- Press **ENTER**, and then the ▲ or ▼ button to change selection.

Auto Adjustment

- Use this function to let the LCD monitor automatically adjust the screen size, horizontal position, vertical position, clock frequency and phase.
- Press the **ENTER** button to execute this function.

Note: This item is only available for the VGA and YPbPr inputs.

Clock Frequency

- Adjusts the clock frequency of the PC or YPbPr input image.
- Press the ► button to expand the width of the image on the screen to the right, or the ◀ button to narrow the width of the image on the screen to the left.

Note: This item is only available for the VGA and YPbPr inputs.

Phase

- Improves focus, clarity and image stability of PC or YPbPr input image by increasing or decreasing this setting.
- Press ► button to increase the setting, or ◀ button to decrease the setting.

Note: This item is only available for the VGA and YPbPr inputs.

H.Position

- Controls Horizontal Image position of PC input image within the display area of the LCD monitor.
- Press the ► button to move the screen image to the right, or the ◀ button to move the screen image to the left.

Note: This item is only available for the VGA input.

V.Position

- Controls Vertical Image position of PC input image within the display area of the LCD monitor.
- Press the ► button to move the screen image up, or the ◀ button to move the screen image down.

Note: This item is only available for the VGA input.

Ambient Light Sensor

- Choose to adjust the sensitivity or disable the ambient light sensor of the monitor.
- Press **ENTER**, and then the ▲ or ▼ button to select **OFF**, **HIGH** or **LOW**.

Blue Screen

- Turns on or off the blue screen function. If turned on, a blue screen will be displayed when no input signal is detected by the LCD monitor.
- Press **ENTER**, and then the ▲ or ▼ button to turn this function on or off.

Auto Detection

- Choose to let the monitor detect and display available signal sources automatically.
- Press **ENTER**, and then the ▲ or ▼ button to turn this function on or off.

Touch feature

- Control Touch function On or Off, once set ON, PIP and Display wall function will be disable.

Setting

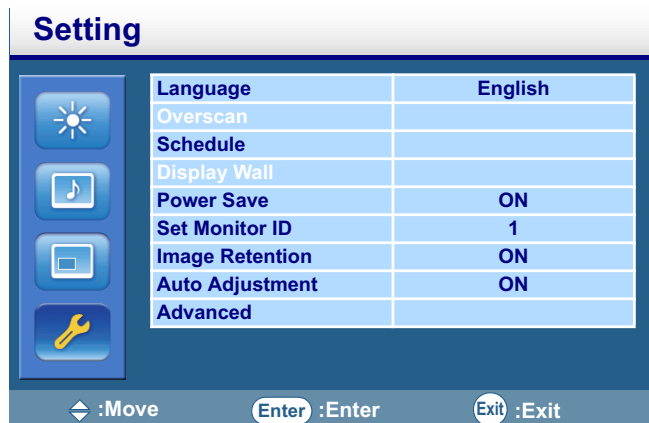

Language

- Allows you to select a preferred language for the OSD menu. **English**, **Français** (French) and **Español** (Spanish) are available for selection.
- Press **ENTER**, and then the ▲ or ▼ button to change selection.

Overscan

- Turns on or off the overscan function when displaying HDMI input image.
- Press **ENTER**, and then the ▲ or ▼ button to turn this function on or off.

Note: This item is only available for the HDMI input.

Schedule

- Press **ENTER**, and then the ▲ or ▼ button to select a function:
 - **Date and Time:** Sets up current date and time. Press **ENTER** to display the sub-menu:

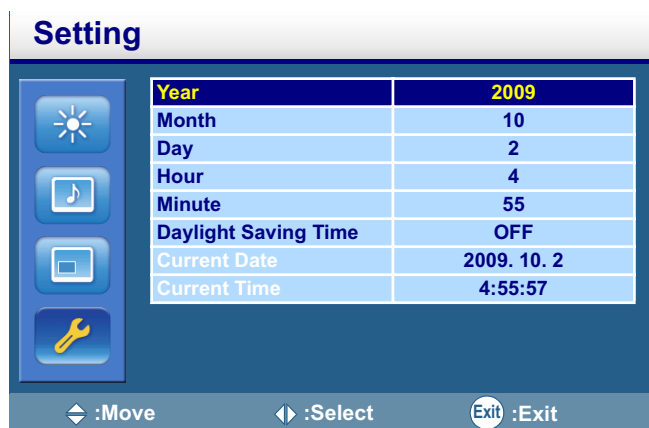

- To set up date and time:
 1. Press ▲ or ▼ button to highlight **Year**, and then press ◀ or ▶ to select a year.
 2. Press ▲ or ▼ button to highlight **Month**, and then press ◀ or ▶ to select a month.
 3. Press ▲ or ▼ button to highlight **Day**, and then press ◀ or ▶ to select a day.
 4. Press ▲ or ▼ button to highlight **Hour**, and then press ◀ or ▶ to set the hour.
 5. Press ▲ or ▼ button to highlight **Minute**, and then press ◀ or ▶ to set the minute.
 6. Press ▲ or ▼ button to highlight **Daylight Saving Time**, press **ENTER**, and then press ▲ or ▼ to select **ON** or **OFF**.
- Once set, the current date and time will display in the **Current Date** and **Current Time** rows.

- **Schedule:** Using the Schedule function allows you to set up to seven different scheduled time intervals when the LCD Monitor will be activated. You can select the time the monitor turns on and turns off, the day of week the monitor is activated, and which input source the monitor will use for each scheduled activation period.

Note: Set up current time first before setting up the Schedule.

- Press **ENTER** to display the sub-menu:

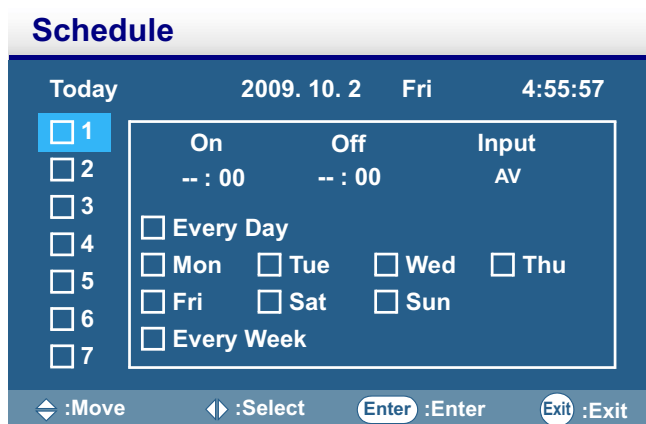

- To set up a schedule item:
 1. Press the **▲** or **▼** button to select a schedule item (item 1 through item 7), and then press the **▶** button.
 2. With the **On** item highlighted, press **ENTER** and then press the **▲** or **▼** button to set the hour when the LCD monitor will be turned on, then press the **▶** button to move to the minute slot to set the minute. If you create a schedule but do not want to use a power on time, select "--" for the hour slot, and "00" for the minute slot.
 3. Press **EXIT**, and then press the **▶** button to highlight the **Off** item. Press **ENTER**, and then press the **▲** or **▼** button to set the hour when the LCD monitor will be turned off, then press the **▶** button to move to the minute slot to set the minute. If you create a schedule but do not want to use a power off time, select "--" for the hour slot, and "00" for the minute slot.
 4. Press **EXIT**, and then press the **▶** button to highlight the **Input** item, and then press the **▲** or **▼** button to select an input source. If no input source is selected, the input from the previous schedule item will be used.
 5. Press the **▶** button to select what days in a week this schedule item will take effect, and then press **ENTER** button.
 6. If you want to set up more schedule items, press **EXIT** and then repeat the steps above.
- A check mark in the box next to the number of the schedule item indicates that the selected schedule is in effect.

Notes:

- The selection of Every Day within a schedule item takes priority over other schedules that are set up to operate weekly.
- When schedule items overlap, scheduled power on time has priority over scheduled power off time.
- If there are two schedule items programmed for the same time, then the highest numbered schedule has priority.

Display Wall

- Press the **ENTER** button to display the sub-menu:

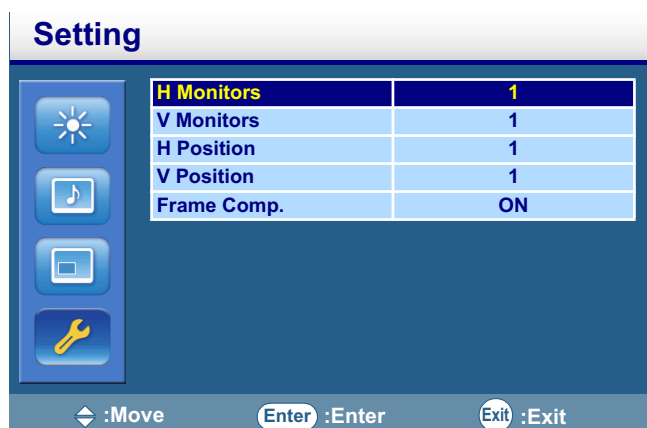

- **H Monitors:** Selects the number of displays used in the horizontal position. Press ◀ or ▶ to change the setting.
- **V Monitors:** Selects the number of displays used in the vertical position. Press ◀ or ▶ to change the setting.
- **H Position:** Selects the horizontal position of the monitor in the display wall matrix. Press the ◀ or ▶ button to change selection.
- **V Position:** Selects the vertical position of the monitor in the display wall matrix. Press the ◀ or ▶ button to change selection.
- **Frame Comp.:** Adjusts images near the display edges for optimal demonstration across the display wall.

Power save

- If turned on, the LCD monitor will go to power management mode when PC sync is lost, and will enter power management mode when no DVD/HD or VIDEO input signal can be detected three times in a row.
- Press **ENTER**, and then press the ▲ or ▼ to select **ON**, **OFF** or **VGA only**.

Set Monitor ID

- By connecting multiple LCD monitors to a PC using RS-232C cables, you can control any one monitor or all the monitors on the PC. Assign arbitrary ID number to each of multi-connected CDP6530 monitors using this function. ID numbers 1 to 99 are selectable. It is recommended to assign sequential ID numbers from 1 and up.
- Press **ENTER**, and then the ▲ or ▼ button to change the ID number.

Image Retention

- If turned on, the LCD monitor automatically displays swift moving patterns to prevent the formation of image retention on the screen.
- Press **ENTER**, and then the ▲ or ▼ button to turn this function on or off.

NOTE: IMAGE PERSISTENCE

- Please be aware that LCD Technology may experience a phenomenon known as Image Persistence. Image Persistence occurs when residual or "ghost" image of a previous image remains visible on the screen. Unlike CRT monitors, LCD monitors' image persistence is not permanent, but constant images being displayed for a long period of time should be avoided.
- To alleviate image persistence, turn off the monitor for as long as the previous image was displayed. For example, if an image was on the monitor for one hour and a residual image remains, the monitor should be turned off for one hour to erase the image.
- As with all personal display devices, ViewSonic recommends displaying moving images and using a moving screen saver at regular intervals whenever the screen is idle or turning off the monitor when not in use. Please use the Power Save and Schedule functions to further reduce the risk of image persistence.

Auto Adjustment

- Turns on or off the Auto Adjustment function. Once turned on, the LCD monitor will automatically optimize the image by adjusting the vertical position, horizontal position, clock frequency and phase when the input signal timing is changed.

- Press **ENTER**, and then the ▲ or ▼ button to turn this function on or off.

Advanced

- Press the **ENTER** button to display the diagnostic information of the LCD monitor:

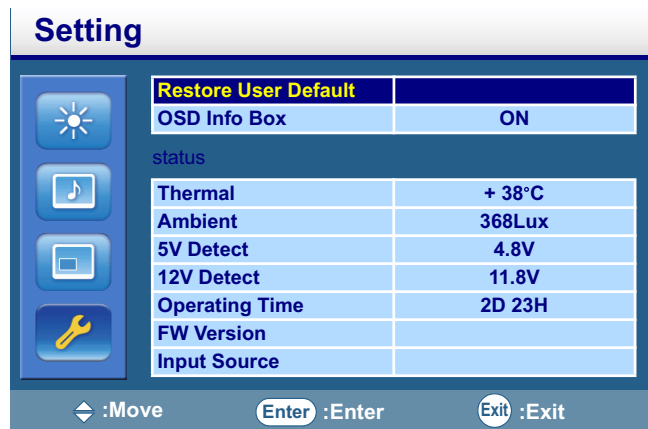

- **Reset User Default:** (1) If activated, all OSD settings (except the Language setting) will be restored to the factory settings. (2) Press the **ENTER** button to activate the reset.
- **OSD Info Box:** Disable or enable OSD information.
- **Thermal:** Displays the current temperature inside the LCD monitor.
- **Ambient:** Displays the current ambient brightness around the LCD monitor.
- **5V Detect:** Displays the current 5V voltage detection result.
- **12V Detect:** Displays the current 12V voltage detection result.
- **Operating Time:** Displays the time elapsed since the LCD monitor was last turned on. D=Day, H=Hour.

For Long Life Use of Public Display

< Image Sticking of the LCD Panel >

When the LCD panel is operated continuously for long hours, a trace of electric charge remains near the electrode inside LCD, and residual or "ghost" image of previous image may be observed. (Image Persistence)

Image Persistence is not permanent, but when fixed image is displayed for long period, ionic impurities inside LCD would accumulate along the displayed image, and are observed permanently. (Image Sticking)

< Recommendations >

For preventing the fast transition to Image Sticking, and for longer life usage of LCD, following are recommended.

1. Fixed image should not be displayed for long period, and changed to another images with short cycle.
2. When not in use, please turn off the monitor.
3. Reducing the environmental temperature is effective for long life use.

Controlling the LCD monitor via RS-232C Remote Control

This LCD monitor can be controlled by connecting a personal computer with a RS-232C terminal. Functions that can be controlled by a personal computer are:

Connection
LCD Monitor + PC

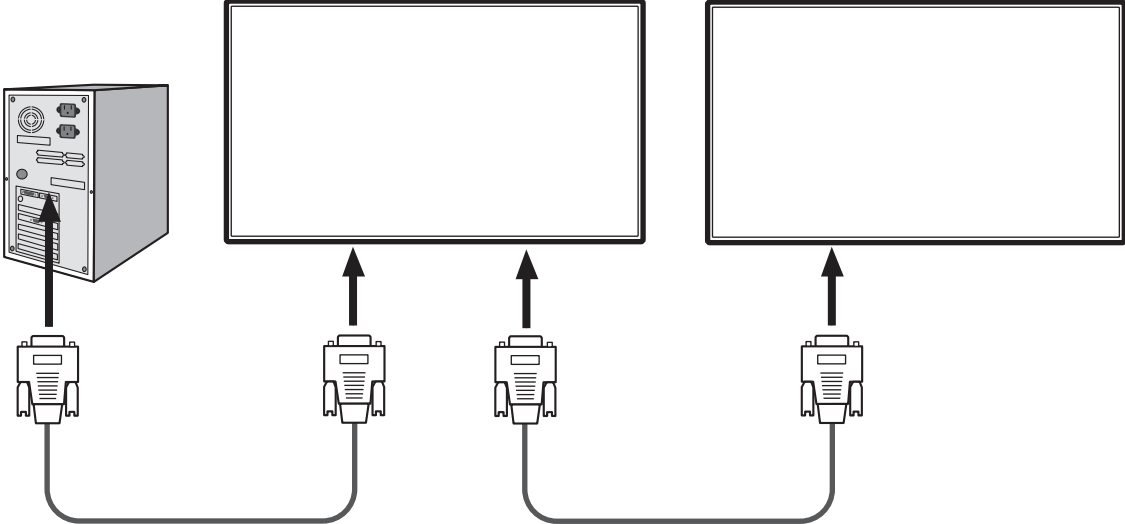

- NOTE:**
- Two kinds of RS-232 protocols are provided: serial connection and non-serial connection.
 - When connecting multiple monitors in a daisy-chain configuration, please refer to the table below for the maximum number of monitors that can be deployed depending on the signal type and resolution used. For example, if you use VGA as the signal type and signal resolution is 800 x 600 @ 60Hz, then you can connect up to 16 monitors in a daisy-chain configuration. It is recommended that you use VGA as the signal type for input/output connection in a daisy-chain configuration.

| Resolution | Signal type |
|--------------------|-------------|
| | VGA |
| 640 x 480 @ 60Hz | 16 |
| 640 x 480 @ 72Hz | |
| 640 x 480 @ 75Hz | |
| 720 x 400 @ 70Hz | |
| 800 x 600 @ 60Hz | |
| 800 x 600 @ 75Hz | |
| 1024 x 768 @ 60Hz | 12 |
| 1024 x 768 @ 75Hz | |
| 1280 x 768 @ 60Hz | |
| 1280 x 960 @ 60Hz | |
| 1280 x 1024 @ 60Hz | |
| 1360 x 768 @ 60Hz | |
| 1366 x 768 @ 60Hz | 10 |
| 1600 x 1200 @ 60Hz | |
| 1920 x 1080 @ 60Hz | |

Appendix: Installing Stands

How to Install Stands

1. Spread the protective sheet on a flat surface, such as a desk. Place the monitor on a protective sheet.

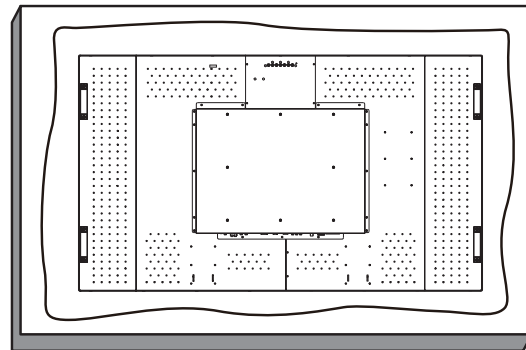

2. Place the stands on the monitor as shown.

NOTE:
Install the stands so that their longer portions come to the front.

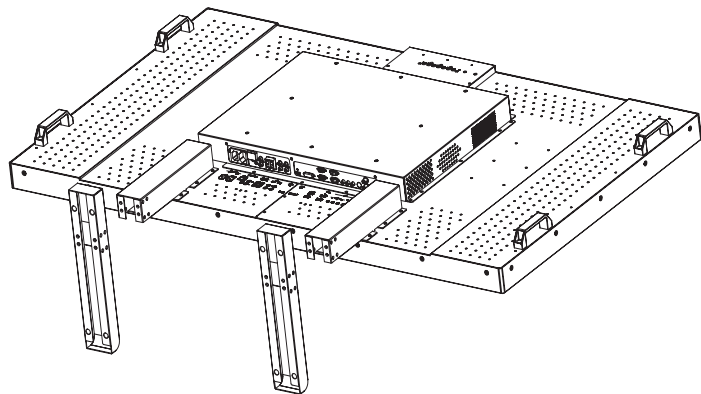

3. Use the M4 screws and a suitable screwdriver to secure the stands on the LCD monitor.

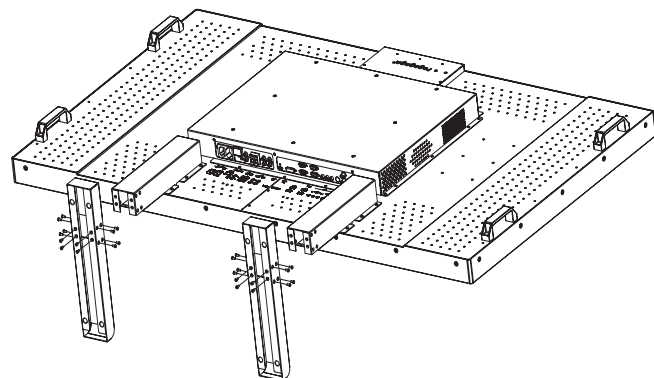
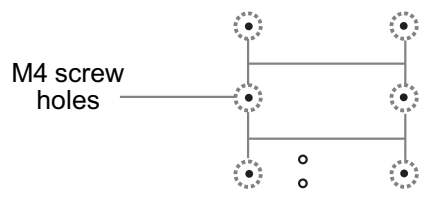

Troubleshooting

No picture

- The signal cable should be completely connected to the display card/computer.
- The display card should be completely seated in its slot.
- Monitor and computer power should be switched ON.
- Check to make sure that a supported mode has been selected on the display card or system being used. (Please consult display card or system manual to change graphics mode.)
- Check the monitor and your display card with respect to compatibility and recommended settings.
- Check the signal cable connector for bent or pushed-in pins.
- If nothing is displayed on the screen when an HDCP device is connected, reset the power of the device.

The Power button does not respond

- Unplug the power cord of the monitor from the AC outlet to turn off and reset the monitor.

Image persistence

- Please be aware that LCD technology may experience a phenomenon known as Image Persistence. Image Persistence occurs when a residual or “ghost” image of a previous image remains visible on the screen. Unlike CRT monitors, LCD monitors’ image persistence is not permanent, but constant images being displayed for a long period of time should be avoided. To alleviate image persistence, turn off the monitor for as long as the previous image was displayed. For example, if an image was on the monitor for one hour and a residual image remains, the monitor should be turned off for one hour to erase the image.

NOTE:

As with all personal display devices, VIEWSONIC recommends displaying moving images and using a moving screen saver at regular intervals whenever the screen is idle or turning off the monitor when not in use.

Image is unstable, unfocused or swimming is apparent

- Signal cable should be completely attached to the computer.
- Use the OSD controls to focus and adjust display by increasing or decreasing the fine adjustment.
- Check the monitor and your display card with respect to compatibility and recommended signal timings.
- If your text is garbled, change the video mode to non-interlace and use 60 Hz refresh rate.

Image of component signal is greenish

- Check to see if the DVD/HD input connector is selected.

The CCFL on the monitor is not lit (no green or red color can be seen)

- The power cord should be connected.
- Make certain the computer is not in a power-saving mode (touch the keyboard or mouse).

Display image is not sized properly

- Use the OSD Image Adjust controls to increase or decrease the coarse adjustment.
- Check to make sure that a supported mode has been selected on the display card or system being used. (Please consult display card or system manual to change graphics mode.)

No Sound

- Check to see if the speaker cable is properly connected.
- Check to see if mute is activated.
- Check to see if volume is set at minimum.

Remote Control is not available

- Check the Remote Control’s batteries status.
- Check if batteries are inserted correctly.
- Check if the Remote Control is pointing at the monitor’s remote sensor.

Stripe Noise

Either light vertical or horizontal stripes may appear, depending on the specific display pattern. This is no product fault or degradation.

Specifications

Product Specifications

| Product specifications | Analog Input | Digital Input |
|--|---|-------------------------|
| LCD Module | Diagonal: 64.5" / 163.83 cm Pixel Pitch: 0.248 (H) x 0.744 (V) mm Resolution: 1920 x 1080 dots Color: 10 bit, 1073.M colors Brightness: 500 nits (typ.) Contrast Ratio: 5000:1 (typ.) Response time: 8 ms (typ. G to G) View Angle: Up and Down 178°, Left and Right 178° (typ.) | |
| Frequency | Horizontal: 31 - 68 KHz Vertical: 50/60 - 75 Hz | |
| Pixel Clock | 138 MHz | |
| Viewable Size | 1428.48 (H) x 878.0 (V) mm / 56.24 x 34.57 inches | |
| Input Signal | PC Input: VGA 15 Pin Mini D-sub VIDEO Input: DVI HDMl Y Pb Pr Y Pb Pr (RCA jacks) CVBS Composite Video (BNC jacks) S-Video Y/C (Mini-DIN jack) AUDIO Input: L/R (RCA jacks) L/R (3.5mm Mini-jack) RS-232C: 9 Pin Mini D-sub | DVI-D HDMI with HDCP |
| Output Signal | PC Output: VGA 15 Pin Mini D-sub VIDEO Output: CVBS Composite Video (BNC jacks) Speaker Output: External Speaker Jack 12W + 12W (8 ohm) Internal Speaker 12W + 12W Audio Output: L/R (RCA jacks) RS-232C: 9 Pin Mini D-sub | |
| Resolutions Supported | NTSC, PAL, SECAM, 4.43NTSC, PAL60 480i@60, 576i@50, 480p@60, 576p@50, 1080i@60, 1080i@50, 720p@60, 720p@50, 1080p@60, 1080p@50 | |
| Power Supply | 100 - 240 V AC, 50 / 60 Hz | |
| Power Consumption | Max. 550 W Power Save: Less than 1 W | |
| Operational Environment | Temperature: Landscape: 0 - 40 °C / 32-104°F Humidity: 20 - 80% (Without condensation) | |
| Storage Environment | Temperature: -20 - 60°C / -4 - 140°F Humidity: 10 - 90% (Without condensation) | |
| Display Dimension [W x H x D] Without Stand (mm/inch) With Stand (mm/inch) | 1522.2 x 889.2 x 145.8/59.9 x 35.0 x 5.7 1522.2 x 1022.9 x 421.7/59.9 x 40.3 x 16.6 | |
| Gross Weight (kg/lbs) Net Weight Without Stand (kg/lbs) | 82.1/181.0 71.6/157.9 | |
| Wall mounting interface | 8 Holes, 200 pitch (200mm x 400mm) | |
| Power Management | VESA DPM | |
| Plug & Play | VESA DDC2B, DDC/CI | |
| Regulatory | FCC, ICES003, CB, CE, C-tick, EuP, WEEE | |
| Optical Touch Screen | Technology Optical | |
| Resolution (Points Area Function) | 32767 x 32767 | |
| Capability | 2 simultaneous touches | |
| Accuracy | ±3mm over 95% of touchable area | |
| Glass | Tempered glass | |
| Interface | USB 2.0 HID-compliant | |
| Supported OS | Windows XP, Windows Vista, Windows 7, Mac OSX, Linux | |

Note: Specifications and functions of this monitor are subject to change without prior notice.

Supported Input Signal Resolution

| Resolution | Input source | | | | | |
|--------------------|--------------|---------|-------|-----|------|-----|
| | AV | S-Video | YPbPr | VGA | HDMI | DVI |
| 640 x 480 @ 60Hz | | | | ○ | ○ | ○ |
| 640 x 480 @ 72Hz | | | | ○ | ○ | ○ |
| 640 x 480 @ 75Hz | | | | ○ | ○ | ○ |
| 720 x 400 @ 70Hz | | | | ○ | ○ | ○ |
| 800 x 600 @ 60Hz | | | | ○ | ○ | ○ |
| 800 x 600 @ 75Hz | | | | ○ | ○ | ○ |
| 1024 x 768 @ 60Hz | | | | ○ | ○ | ○ |
| 1024 x 768 @ 75Hz | | | | ○ | ○ | ○ |
| 1280 x 768 @ 60Hz | | | | ○ | ○ | ○ |
| 1280 x 960 @ 60Hz | | | | ○ | ○ | ○ |
| 1280 x 1024 @ 60Hz | | | | ○ | ○ | ○ |
| 1360 x 768 @ 60Hz | | | | ○ | ○ | ○ |
| 1366 x 768 @ 60Hz | | | | ○ | ○ | ○ |
| 1600 x 1200 @ 60Hz | | | | ○ | ○ | ○ |
| 1920 x 1080 @ 60Hz | | | | ○ | ○ | ○ |
| 576i (50Hz) | ○ | ○ | ○ | | ○ | |
| 480i (60Hz) | ○ | ○ | ○ | | ○ | |
| 480p (60Hz) | | | ○ | | ○ | |
| 576p (50Hz) | | | ○ | | ○ | |
| 720p (50Hz) | | | ○ | | ○ | |
| 720p (60Hz) | | | ○ | | ○ | |
| 1080i (50Hz) | | | ○ | | ○ | |
| 1080i (60Hz) | | | ○ | | ○ | |
| 1080p (50Hz) | | | ○ | | ○ | |
| 1080p (60Hz) | | | ○ | | ○ | |

Note:

- ○: supported
- Blank: not supported

Supported Signal Source and Resolution in PIP Mode

Note:

- The PIP function is only available under certain signal source combinations as shown in the table below.

| | | Main picture signal source | | | | | | |
|----------------------------------|-----------|----------------------------|---------|-----------|-----|-------|------|-----|
| | | Video | S-Video | Component | VGA | DVI-D | HDMI | OPS |
| Sub picture signal source | Video | X | X | X | X | X | X | X |
| | S-Video | X | X | X | X | X | X | X |
| | Component | X | X | X | X | ○ | ○ | ○ |
| | VGA | X | X | X | X | ○ | ○ | ○ |
| | DVI-D | X | X | ○ | ○ | X | X | X |
| | HDMI | X | X | ○ | ○ | X | X | X |
| | OPS | X | X | ○ | ○ | X | X | X |

(○: PIP function available, X: PIP function unavailable)

- The availability of the PIP function will also depend on the resolution of the input signal being used.

Note:

- ○: supported
- Blank: not supported

| | | Main picture | | | | | | | | | | | | | | |
|--------------------|---|------------------|------------------|------------------|------------------|------------------|------------------|-------------------|-------------------|-------------------|-------------------|--------------------|-------------------|-------------------|--------------------|--------------------|
| | | DVI | | | | | | | | | | | | | | |
| Sub picture | | 640 x 480 @ 60Hz | 640 x 480 @ 72Hz | 640 x 480 @ 75Hz | 720 x 400 @ 70Hz | 800 x 600 @ 60Hz | 800 x 600 @ 75Hz | 1024 x 768 @ 60Hz | 1024 x 768 @ 75Hz | 1280 x 768 @ 60Hz | 1280 x 960 @ 60Hz | 1280 x 1024 @ 60Hz | 1360 x 768 @ 60Hz | 1366 x 768 @ 60Hz | 1600 x 1200 @ 60Hz | 1920 x 1080 @ 60Hz |
| | | VGA | 640 x 480 @ 60Hz | ○ | ○ | ○ | ○ | ○ | ○ | ○ | ○ | ○ | ○ | ○ | ○ | ○ |
| 640 x 480 @ 72Hz | ○ | | ○ | ○ | ○ | ○ | ○ | ○ | ○ | ○ | ○ | ○ | ○ | ○ | | |
| 640 x 480 @ 75Hz | ○ | | ○ | ○ | ○ | ○ | ○ | ○ | ○ | ○ | ○ | ○ | ○ | ○ | | |
| 720 x 400 @ 70Hz | ○ | | ○ | ○ | ○ | ○ | ○ | ○ | ○ | ○ | ○ | ○ | ○ | ○ | | |
| 800 x 600 @ 60Hz | ○ | | ○ | ○ | ○ | ○ | ○ | ○ | ○ | ○ | ○ | ○ | ○ | ○ | | |
| 800 x 600 @ 75Hz | ○ | | ○ | ○ | ○ | ○ | ○ | ○ | ○ | ○ | ○ | ○ | ○ | ○ | | |
| 1024 x 768 @ 60Hz | ○ | | ○ | ○ | ○ | ○ | ○ | ○ | ○ | ○ | ○ | ○ | ○ | ○ | | |
| 1024 x 768 @ 75Hz | ○ | | ○ | ○ | ○ | ○ | ○ | ○ | ○ | ○ | ○ | ○ | ○ | ○ | | |
| 1280 x 768 @ 60Hz | ○ | | ○ | ○ | ○ | ○ | ○ | ○ | ○ | ○ | ○ | ○ | ○ | ○ | | |
| 1280 x 960 @ 60Hz | ○ | | ○ | ○ | ○ | ○ | ○ | ○ | ○ | ○ | ○ | ○ | ○ | ○ | | |
| 1280 x 1024 @ 60Hz | ○ | | ○ | ○ | ○ | ○ | ○ | ○ | ○ | ○ | ○ | ○ | ○ | ○ | | |
| 1360 x 768 @ 60Hz | ○ | | ○ | ○ | ○ | ○ | ○ | ○ | ○ | ○ | ○ | ○ | ○ | ○ | | |
| 1366 x 768 @ 60Hz | ○ | | ○ | ○ | ○ | ○ | ○ | ○ | ○ | ○ | ○ | ○ | ○ | ○ | | |
| 1600 x 1200 @ 60Hz | ○ | | ○ | ○ | ○ | ○ | ○ | ○ | ○ | ○ | ○ | ○ | ○ | ○ | | |
| 1920 x 1080 @ 60Hz | ○ | ○ | ○ | ○ | ○ | ○ | ○ | ○ | ○ | ○ | ○ | ○ | ○ | | | |

| | | Main picture | | | | | | | | | | | | | | |
|--------------------|--------------------|------------------|------------------|------------------|------------------|------------------|------------------|-------------------|-------------------|-------------------|-------------------|--------------------|-------------------|-------------------|--------------------|--------------------|
| | | VGA | | | | | | | | | | | | | | |
| Sub picture | | 640 x 480 @ 60Hz | 640 x 480 @ 72Hz | 640 x 480 @ 75Hz | 720 x 400 @ 70Hz | 800 x 600 @ 60Hz | 800 x 600 @ 75Hz | 1024 x 768 @ 60Hz | 1024 x 768 @ 75Hz | 1280 x 768 @ 60Hz | 1280 x 960 @ 60Hz | 1280 x 1024 @ 60Hz | 1360 x 768 @ 60Hz | 1366 x 768 @ 60Hz | 1600 x 1200 @ 60Hz | 1920 x 1080 @ 60Hz |
| DVI | 640 x 480 @ 60Hz | ○ | ○ | ○ | ○ | ○ | ○ | ○ | ○ | ○ | ○ | ○ | ○ | ○ | | |
| | 640 x 480 @ 72Hz | ○ | ○ | ○ | ○ | ○ | ○ | ○ | ○ | ○ | ○ | ○ | ○ | ○ | | |
| | 640 x 480 @ 75Hz | ○ | ○ | ○ | ○ | ○ | ○ | ○ | ○ | ○ | ○ | ○ | ○ | ○ | | |
| | 720 x 400 @ 70Hz | ○ | ○ | ○ | ○ | ○ | ○ | ○ | ○ | ○ | ○ | ○ | ○ | ○ | | |
| | 800 x 600 @ 60Hz | ○ | ○ | ○ | ○ | ○ | ○ | ○ | ○ | ○ | ○ | ○ | ○ | ○ | | |
| | 800 x 600 @ 75Hz | ○ | ○ | ○ | ○ | ○ | ○ | ○ | ○ | ○ | ○ | ○ | ○ | ○ | | |
| | 1024 x 768 @ 60Hz | ○ | ○ | ○ | ○ | ○ | ○ | ○ | ○ | ○ | ○ | ○ | ○ | ○ | | |
| | 1024 x 768 @ 75Hz | ○ | ○ | ○ | ○ | ○ | ○ | ○ | ○ | ○ | ○ | ○ | ○ | ○ | | |
| | 1280 x 768 @ 60Hz | ○ | ○ | ○ | ○ | ○ | ○ | ○ | ○ | ○ | ○ | ○ | ○ | ○ | | |
| | 1280 x 960 @ 60Hz | ○ | ○ | ○ | ○ | ○ | ○ | ○ | ○ | ○ | ○ | ○ | ○ | ○ | | |
| | 1280 x 1024 @ 60Hz | ○ | ○ | ○ | ○ | ○ | ○ | ○ | ○ | ○ | ○ | ○ | ○ | ○ | | |
| | 1360 x 768 @ 60Hz | ○ | ○ | ○ | ○ | ○ | ○ | ○ | ○ | ○ | ○ | ○ | ○ | ○ | | |
| | 1366 x 768 @ 60Hz | ○ | ○ | ○ | ○ | ○ | ○ | ○ | ○ | ○ | ○ | ○ | ○ | ○ | | |
| | 1600 x 1200 @ 60Hz | ○ | ○ | ○ | ○ | ○ | ○ | ○ | ○ | ○ | ○ | ○ | ○ | ○ | | |
| 1920 x 1080 @ 60Hz | ○ | ○ | ○ | ○ | ○ | ○ | ○ | ○ | ○ | ○ | ○ | ○ | ○ | | | |

| | | Main picture | | | | | | | | | |
|--------------------|--------------------|--------------|--------------|--------------|--------------|-------------|-------------|-------------|-------------|-------------|-------------|
| | | HDMI | | | | | | | | | |
| | | 1080p (60Hz) | 1080p (50Hz) | 1080i (60Hz) | 1080i (50Hz) | 720p (60Hz) | 720p (50Hz) | 576p (50Hz) | 480p (60Hz) | 480i (60Hz) | 576i (50Hz) |
| Sub picture | | | | | | | | | | | |
| VGA | 640 x 480 @ 60Hz | | | | | ○ | ○ | ○ | ○ | ○ | ○ |
| | 640 x 480 @ 72Hz | | | | | ○ | ○ | ○ | ○ | ○ | ○ |
| | 640 x 480 @ 75Hz | | | | | ○ | ○ | ○ | ○ | ○ | ○ |
| | 720 x 400 @ 70Hz | | | | | ○ | ○ | ○ | ○ | ○ | ○ |
| | 800 x 600 @ 60Hz | | | | | ○ | ○ | ○ | ○ | ○ | ○ |
| | 800 x 600 @ 75Hz | | | | | ○ | ○ | ○ | ○ | ○ | ○ |
| | 1024 x 768 @ 60Hz | | | | | ○ | ○ | ○ | ○ | ○ | ○ |
| | 1024 x 768 @ 75Hz | | | | | ○ | ○ | ○ | ○ | ○ | ○ |
| | 1280 x 768 @ 60Hz | | | | | ○ | ○ | ○ | ○ | ○ | ○ |
| | 1280 x 960 @ 60Hz | | | | | ○ | ○ | ○ | ○ | ○ | ○ |
| | 1280 x 1024 @ 60Hz | | | | | ○ | ○ | ○ | ○ | ○ | ○ |
| | 1360 x 768 @ 60Hz | | | | | ○ | ○ | ○ | ○ | ○ | ○ |
| | 1366 x 768 @ 60Hz | | | | | ○ | ○ | ○ | ○ | ○ | ○ |
| | 1600 x 1200 @ 60Hz | | | | | ○ | ○ | ○ | ○ | ○ | ○ |
| 1920 x 1080 @ 60Hz | | | | | ○ | ○ | ○ | ○ | ○ | ○ | |

| | | Main picture | | | | | | | | | | | | | | |
|--------------------|-----------------------|-----------------------|-----------------------|-----------------------|-----------------------|-----------------------|-----------------------|-----------------------|-----------------------|-----------------------|-----------------------|-----------------------|-----------------------|-----------------------|-----------------------|-----------------------|
| | | HDMI | | | | | | | | | | | | | | |
| Sub picture | | 640 x 480 @ 60Hz | 640 x 480 @ 72Hz | 640 x 480 @ 75Hz | 720 x 400 @ 70Hz | 800 x 600 @ 60Hz | 800 x 600 @ 75Hz | 1024 x 768 @ 60Hz | 1024 x 768 @ 75Hz | 1280 x 768 @ 60Hz | 1280 x 960 @ 60Hz | 1280 x 1024 @ 60Hz | 1360 x 768 @ 60Hz | 1366 x 768 @ 60Hz | 1600 x 1200 @ 60Hz | 1920 x 1080 @ 60Hz |
| VGA | 640 x 480 @ 60Hz | <input type="radio"/> | <input type="radio"/> | <input type="radio"/> | <input type="radio"/> | <input type="radio"/> | <input type="radio"/> | <input type="radio"/> | <input type="radio"/> | <input type="radio"/> | <input type="radio"/> | <input type="radio"/> | <input type="radio"/> | <input type="radio"/> | <input type="radio"/> | <input type="radio"/> |
| | 640 x 480 @ 72Hz | <input type="radio"/> | <input type="radio"/> | <input type="radio"/> | <input type="radio"/> | <input type="radio"/> | <input type="radio"/> | <input type="radio"/> | <input type="radio"/> | <input type="radio"/> | <input type="radio"/> | <input type="radio"/> | <input type="radio"/> | <input type="radio"/> | <input type="radio"/> | <input type="radio"/> |
| | 640 x 480 @ 75Hz | <input type="radio"/> | <input type="radio"/> | <input type="radio"/> | <input type="radio"/> | <input type="radio"/> | <input type="radio"/> | <input type="radio"/> | <input type="radio"/> | <input type="radio"/> | <input type="radio"/> | <input type="radio"/> | <input type="radio"/> | <input type="radio"/> | <input type="radio"/> | <input type="radio"/> |
| | 720 x 400 @ 70Hz | <input type="radio"/> | <input type="radio"/> | <input type="radio"/> | <input type="radio"/> | <input type="radio"/> | <input type="radio"/> | <input type="radio"/> | <input type="radio"/> | <input type="radio"/> | <input type="radio"/> | <input type="radio"/> | <input type="radio"/> | <input type="radio"/> | <input type="radio"/> | <input type="radio"/> |
| | 800 x 600 @ 60Hz | <input type="radio"/> | <input type="radio"/> | <input type="radio"/> | <input type="radio"/> | <input type="radio"/> | <input type="radio"/> | <input type="radio"/> | <input type="radio"/> | <input type="radio"/> | <input type="radio"/> | <input type="radio"/> | <input type="radio"/> | <input type="radio"/> | <input type="radio"/> | <input type="radio"/> |
| | 800 x 600 @ 75Hz | <input type="radio"/> | <input type="radio"/> | <input type="radio"/> | <input type="radio"/> | <input type="radio"/> | <input type="radio"/> | <input type="radio"/> | <input type="radio"/> | <input type="radio"/> | <input type="radio"/> | <input type="radio"/> | <input type="radio"/> | <input type="radio"/> | <input type="radio"/> | <input type="radio"/> |
| | 1024 x 768 @ 60Hz | <input type="radio"/> | <input type="radio"/> | <input type="radio"/> | <input type="radio"/> | <input type="radio"/> | <input type="radio"/> | <input type="radio"/> | <input type="radio"/> | <input type="radio"/> | <input type="radio"/> | <input type="radio"/> | <input type="radio"/> | <input type="radio"/> | <input type="radio"/> | <input type="radio"/> |
| | 1024 x 768 @ 75Hz | <input type="radio"/> | <input type="radio"/> | <input type="radio"/> | <input type="radio"/> | <input type="radio"/> | <input type="radio"/> | <input type="radio"/> | <input type="radio"/> | <input type="radio"/> | <input type="radio"/> | <input type="radio"/> | <input type="radio"/> | <input type="radio"/> | <input type="radio"/> | <input type="radio"/> |
| | 1280 x 768 @ 60Hz | <input type="radio"/> | <input type="radio"/> | <input type="radio"/> | <input type="radio"/> | <input type="radio"/> | <input type="radio"/> | <input type="radio"/> | <input type="radio"/> | <input type="radio"/> | <input type="radio"/> | <input type="radio"/> | <input type="radio"/> | <input type="radio"/> | <input type="radio"/> | <input type="radio"/> |
| | 1280 x 960 @ 60Hz | <input type="radio"/> | <input type="radio"/> | <input type="radio"/> | <input type="radio"/> | <input type="radio"/> | <input type="radio"/> | <input type="radio"/> | <input type="radio"/> | <input type="radio"/> | <input type="radio"/> | <input type="radio"/> | <input type="radio"/> | <input type="radio"/> | <input type="radio"/> | <input type="radio"/> |
| | 1280 x 1024 @ 60Hz | <input type="radio"/> | <input type="radio"/> | <input type="radio"/> | <input type="radio"/> | <input type="radio"/> | <input type="radio"/> | <input type="radio"/> | <input type="radio"/> | <input type="radio"/> | <input type="radio"/> | <input type="radio"/> | <input type="radio"/> | <input type="radio"/> | <input type="radio"/> | <input type="radio"/> |
| | 1360 x 768 @ 60Hz | <input type="radio"/> | <input type="radio"/> | <input type="radio"/> | <input type="radio"/> | <input type="radio"/> | <input type="radio"/> | <input type="radio"/> | <input type="radio"/> | <input type="radio"/> | <input type="radio"/> | <input type="radio"/> | <input type="radio"/> | <input type="radio"/> | <input type="radio"/> | <input type="radio"/> |
| | 1366 x 768 @ 60Hz | <input type="radio"/> | <input type="radio"/> | <input type="radio"/> | <input type="radio"/> | <input type="radio"/> | <input type="radio"/> | <input type="radio"/> | <input type="radio"/> | <input type="radio"/> | <input type="radio"/> | <input type="radio"/> | <input type="radio"/> | <input type="radio"/> | <input type="radio"/> | <input type="radio"/> |
| | 1600 x 1200 @ 60Hz | <input type="radio"/> | <input type="radio"/> | <input type="radio"/> | <input type="radio"/> | <input type="radio"/> | <input type="radio"/> | <input type="radio"/> | <input type="radio"/> | <input type="radio"/> | <input type="radio"/> | <input type="radio"/> | <input type="radio"/> | <input type="radio"/> | <input type="radio"/> | <input type="radio"/> |
| 1920 x 1080 @ 60Hz | <input type="radio"/> | <input type="radio"/> | <input type="radio"/> | <input type="radio"/> | <input type="radio"/> | <input type="radio"/> | <input type="radio"/> | <input type="radio"/> | <input type="radio"/> | <input type="radio"/> | <input type="radio"/> | <input type="radio"/> | <input type="radio"/> | <input type="radio"/> | <input type="radio"/> | |

| | | Main picture | | | | | | | | | | | | | | |
|--------------|--------------------|------------------|------------------|------------------|------------------|------------------|------------------|-------------------|-------------------|-------------------|-------------------|--------------------|-------------------|-------------------|--------------------|--------------------|
| | | VGA | | | | | | | | | | | | | | |
| | | 640 x 480 @ 60Hz | 640 x 480 @ 72Hz | 640 x 480 @ 75Hz | 720 x 400 @ 70Hz | 800 x 600 @ 60Hz | 800 x 600 @ 75Hz | 1024 x 768 @ 60Hz | 1024 x 768 @ 75Hz | 1280 x 768 @ 60Hz | 1280 x 960 @ 60Hz | 1280 x 1024 @ 60Hz | 1360 x 768 @ 60Hz | 1366 x 768 @ 60Hz | 1600 x 1200 @ 60Hz | 1920 x 1080 @ 60Hz |
| Sub picture | | | | | | | | | | | | | | | | |
| HDMI | 640 x 480 @ 60Hz | ○ | ○ | ○ | ○ | ○ | ○ | ○ | ○ | ○ | ○ | ○ | ○ | | | |
| | 640 x 480 @ 72Hz | ○ | ○ | ○ | ○ | ○ | ○ | ○ | ○ | ○ | ○ | ○ | ○ | | | |
| | 640 x 480 @ 75Hz | ○ | ○ | ○ | ○ | ○ | ○ | ○ | ○ | ○ | ○ | ○ | ○ | | | |
| | 720 x 400 @ 70Hz | ○ | ○ | ○ | ○ | ○ | ○ | ○ | ○ | ○ | ○ | ○ | ○ | | | |
| | 800 x 600 @ 60Hz | ○ | ○ | ○ | ○ | ○ | ○ | ○ | ○ | ○ | ○ | ○ | ○ | | | |
| | 800 x 600 @ 75Hz | ○ | ○ | ○ | ○ | ○ | ○ | ○ | ○ | ○ | ○ | ○ | ○ | | | |
| | 1024 x 768 @ 60Hz | ○ | ○ | ○ | ○ | ○ | ○ | ○ | ○ | ○ | ○ | ○ | ○ | | | |
| | 1024 x 768 @ 75Hz | ○ | ○ | ○ | ○ | ○ | ○ | ○ | ○ | ○ | ○ | ○ | ○ | | | |
| | 1280 x 768 @ 60Hz | ○ | ○ | ○ | ○ | ○ | ○ | ○ | ○ | ○ | ○ | ○ | ○ | | | |
| | 1280 x 960 @ 60Hz | ○ | ○ | ○ | ○ | ○ | ○ | ○ | ○ | ○ | ○ | ○ | ○ | | | |
| | 1280 x 1024 @ 60Hz | ○ | ○ | ○ | ○ | ○ | ○ | ○ | ○ | ○ | ○ | ○ | ○ | | | |
| | 1360 x 768 @ 60Hz | ○ | ○ | ○ | ○ | ○ | ○ | ○ | ○ | ○ | ○ | ○ | ○ | | | |
| | 1366 x 768 @ 60Hz | ○ | ○ | ○ | ○ | ○ | ○ | ○ | ○ | ○ | ○ | ○ | ○ | | | |
| | 1600 x 1200 @ 60Hz | ○ | ○ | ○ | ○ | ○ | ○ | ○ | ○ | ○ | ○ | ○ | ○ | | | |
| | 1920 x 1080 @ 60Hz | ○ | ○ | ○ | ○ | ○ | ○ | ○ | ○ | ○ | ○ | ○ | ○ | | | |
| | 576i (50Hz) | ○ | ○ | ○ | ○ | ○ | ○ | ○ | ○ | ○ | ○ | ○ | ○ | ○ | ○ | ○ |
| | 480i (60Hz) | ○ | ○ | ○ | ○ | ○ | ○ | ○ | ○ | ○ | ○ | ○ | ○ | ○ | ○ | ○ |
| | 480p (60Hz) | ○ | ○ | ○ | ○ | ○ | ○ | ○ | ○ | ○ | ○ | ○ | ○ | ○ | ○ | ○ |
| | 576p (50Hz) | ○ | ○ | ○ | ○ | ○ | ○ | ○ | ○ | ○ | ○ | ○ | ○ | ○ | ○ | ○ |
| | 720p (50Hz) | ○ | ○ | ○ | ○ | ○ | ○ | ○ | ○ | ○ | ○ | ○ | ○ | ○ | ○ | ○ |
| | 720p (60Hz) | ○ | ○ | ○ | ○ | ○ | ○ | ○ | ○ | ○ | ○ | ○ | ○ | ○ | ○ | ○ |
| 1080i (50Hz) | ○ | ○ | ○ | ○ | ○ | ○ | ○ | ○ | ○ | ○ | ○ | ○ | ○ | | | |
| 1080i (60Hz) | ○ | ○ | ○ | ○ | ○ | ○ | ○ | ○ | ○ | ○ | ○ | ○ | ○ | | | |
| 1080p (50Hz) | ○ | ○ | ○ | ○ | ○ | ○ | ○ | ○ | ○ | ○ | ○ | ○ | ○ | | | |
| 1080p (60Hz) | ○ | ○ | ○ | ○ | ○ | ○ | ○ | ○ | ○ | ○ | ○ | ○ | ○ | | | |

| | | Main picture | | | | | | | | | | |
|-------------|--------------|--------------------|--------------------|-------------------|-------------------|--------------------|-------------------|-------------------|-------------------|-------------------|------------------|------------------|
| | | DVI | | | | | | | | | | |
| | | 1920 x 1080 @ 60Hz | 1600 x 1200 @ 60Hz | 1366 x 768 @ 60Hz | 1360 x 768 @ 60Hz | 1280 x 1024 @ 60Hz | 1280 x 960 @ 60Hz | 1280 x 768 @ 60Hz | 1024 x 768 @ 75Hz | 1024 x 768 @ 60Hz | 800 x 600 @ 75Hz | 800 x 600 @ 60Hz |
| Sub picture | | | | | | | | | | | | |
| YPbPr | 576i (50Hz) | ○ | ○ | ○ | ○ | ○ | ○ | ○ | ○ | ○ | ○ | ○ |
| | 480i (60Hz) | ○ | ○ | ○ | ○ | ○ | ○ | ○ | ○ | ○ | ○ | ○ |
| | 480p (60Hz) | ○ | ○ | ○ | ○ | ○ | ○ | ○ | ○ | ○ | ○ | ○ |
| | 576p (50Hz) | ○ | ○ | ○ | ○ | ○ | ○ | ○ | ○ | ○ | ○ | ○ |
| | 720p (50Hz) | ○ | ○ | ○ | ○ | ○ | ○ | ○ | ○ | ○ | ○ | ○ |
| | 720p (60Hz) | ○ | ○ | ○ | ○ | ○ | ○ | ○ | ○ | ○ | ○ | ○ |
| | 1080i (50Hz) | ○ | ○ | ○ | ○ | ○ | ○ | ○ | ○ | ○ | ○ | ○ |
| | 1080i (60Hz) | ○ | ○ | ○ | ○ | ○ | ○ | ○ | ○ | ○ | ○ | ○ |
| | 1080p (50Hz) | ○ | ○ | ○ | ○ | ○ | ○ | ○ | ○ | ○ | ○ | ○ |
| | 1080p (60Hz) | ○ | ○ | ○ | ○ | ○ | ○ | ○ | ○ | ○ | ○ | ○ |

| | | Main picture | | | | | | | | | | |
|-------------|--------------------|--------------|-------------|-------------|-------------|-------------|-------------|--------------|--------------|--------------|--------------|--------------|
| | | YPbPr | | | | | | | | | | |
| | | 576i (50Hz) | 480i (60Hz) | 480p (60Hz) | 576p (50Hz) | 720p (50Hz) | 720p (60Hz) | 1080i (50Hz) | 1080i (60Hz) | 1080p (50Hz) | 1080p (60Hz) | 1080p (60Hz) |
| Sub picture | | | | | | | | | | | | |
| DVI | 640 x 480 @ 60Hz | ○ | ○ | ○ | ○ | ○ | ○ | ○ | ○ | ○ | ○ | ○ |
| | 640 x 480 @ 72Hz | ○ | ○ | ○ | ○ | ○ | ○ | ○ | ○ | ○ | ○ | ○ |
| | 640 x 480 @ 75Hz | ○ | ○ | ○ | ○ | ○ | ○ | ○ | ○ | ○ | ○ | ○ |
| | 720 x 400 @ 70Hz | ○ | ○ | ○ | ○ | ○ | ○ | ○ | ○ | ○ | ○ | ○ |
| | 800 x 600 @ 60Hz | ○ | ○ | ○ | ○ | ○ | ○ | ○ | ○ | ○ | ○ | ○ |
| | 800 x 600 @ 75Hz | ○ | ○ | ○ | ○ | ○ | ○ | ○ | ○ | ○ | ○ | ○ |
| | 1024 x 768 @ 60Hz | ○ | ○ | ○ | ○ | ○ | ○ | ○ | ○ | ○ | ○ | ○ |
| | 1024 x 768 @ 75Hz | ○ | ○ | ○ | ○ | ○ | ○ | ○ | ○ | ○ | ○ | ○ |
| | 1280 x 768 @ 60Hz | ○ | ○ | ○ | ○ | ○ | ○ | ○ | ○ | ○ | ○ | ○ |
| | 1280 x 960 @ 60Hz | ○ | ○ | ○ | ○ | ○ | ○ | ○ | ○ | ○ | ○ | ○ |
| | 1280 x 1024 @ 60Hz | ○ | ○ | ○ | ○ | ○ | ○ | ○ | ○ | ○ | ○ | ○ |
| | 1360 x 768 @ 60Hz | ○ | ○ | ○ | ○ | ○ | ○ | ○ | ○ | ○ | ○ | ○ |
| | 1366 x 768 @ 60Hz | ○ | ○ | ○ | ○ | ○ | ○ | ○ | ○ | ○ | ○ | ○ |
| | 1600 x 1200 @ 60Hz | ○ | ○ | ○ | ○ | ○ | ○ | ○ | ○ | ○ | ○ | ○ |
| | 1920 x 1080 @ 60Hz | ○ | ○ | ○ | ○ | ○ | ○ | ○ | ○ | ○ | ○ | ○ |

| | | Main picture | | | | | | | | | |
|-------------|--------------|--------------|-------------|-------------|-------------|-------------|-------------|--------------|--------------|--------------|--------------|
| | | HDMI | | | | | | | | | |
| | | 576i (50Hz) | 480i (60Hz) | 480p (60Hz) | 576p (50Hz) | 720p (50Hz) | 720p (60Hz) | 1080i (50Hz) | 1080i (60Hz) | 1080p (50Hz) | 1080p (60Hz) |
| Sub picture | | | | | | | | | | | |
| YPbPr | 576i (50Hz) | ○ | ○ | ○ | ○ | ○ | ○ | ○ | ○ | ○ | ○ |
| | 480i (60Hz) | ○ | ○ | ○ | ○ | ○ | ○ | ○ | ○ | ○ | ○ |
| | 480p (60Hz) | ○ | ○ | ○ | ○ | ○ | ○ | ○ | ○ | ○ | ○ |
| | 576p (50Hz) | ○ | ○ | ○ | ○ | ○ | ○ | ○ | ○ | ○ | ○ |
| | 720p (50Hz) | ○ | ○ | ○ | ○ | ○ | ○ | ○ | ○ | ○ | ○ |
| | 720p (60Hz) | ○ | ○ | ○ | ○ | ○ | ○ | ○ | ○ | ○ | ○ |
| | 1080i (50Hz) | ○ | ○ | ○ | ○ | ○ | ○ | ○ | ○ | ○ | ○ |
| | 1080i (60Hz) | ○ | ○ | ○ | ○ | ○ | ○ | ○ | ○ | ○ | ○ |
| | 1080p (50Hz) | ○ | ○ | ○ | ○ | ○ | ○ | ○ | ○ | ○ | ○ |
| | 1080p (60Hz) | ○ | ○ | ○ | ○ | ○ | ○ | ○ | ○ | ○ | ○ |

| | | Main picture | | | | | | | | | | | | | | |
|-------------|--------------|--------------------|--------------------|-------------------|-------------------|--------------------|-------------------|-------------------|-------------------|-------------------|------------------|------------------|------------------|------------------|------------------|------------------|
| | | HDMI | | | | | | | | | | | | | | |
| | | 1920 x 1080 @ 60Hz | 1600 x 1200 @ 60Hz | 1366 x 768 @ 60Hz | 1360 x 768 @ 60Hz | 1280 x 1024 @ 60Hz | 1280 x 960 @ 60Hz | 1280 x 768 @ 60Hz | 1024 x 768 @ 75Hz | 1024 x 768 @ 60Hz | 800 x 600 @ 75Hz | 800 x 600 @ 60Hz | 720 x 400 @ 70Hz | 640 x 480 @ 75Hz | 640 x 480 @ 72Hz | 640 x 480 @ 60Hz |
| Sub picture | | | | | | | | | | | | | | | | |
| YPbPr | 576i (50Hz) | ○ | ○ | ○ | ○ | ○ | ○ | ○ | ○ | ○ | ○ | ○ | ○ | ○ | ○ | ○ |
| | 480i (60Hz) | ○ | ○ | ○ | ○ | ○ | ○ | ○ | ○ | ○ | ○ | ○ | ○ | ○ | ○ | ○ |
| | 480p (60Hz) | ○ | ○ | ○ | ○ | ○ | ○ | ○ | ○ | ○ | ○ | ○ | ○ | ○ | ○ | ○ |
| | 576p (50Hz) | ○ | ○ | ○ | ○ | ○ | ○ | ○ | ○ | ○ | ○ | ○ | ○ | ○ | ○ | ○ |
| | 720p (50Hz) | ○ | ○ | ○ | ○ | ○ | ○ | ○ | ○ | ○ | ○ | ○ | ○ | ○ | ○ | ○ |
| | 720p (60Hz) | ○ | ○ | ○ | ○ | ○ | ○ | ○ | ○ | ○ | ○ | ○ | ○ | ○ | ○ | ○ |
| | 1080i (50Hz) | ○ | ○ | ○ | ○ | ○ | ○ | ○ | ○ | ○ | ○ | ○ | ○ | ○ | ○ | ○ |
| | 1080i (60Hz) | ○ | ○ | ○ | ○ | ○ | ○ | ○ | ○ | ○ | ○ | ○ | ○ | ○ | ○ | ○ |
| | 1080p (50Hz) | ○ | ○ | ○ | ○ | ○ | ○ | ○ | ○ | ○ | ○ | ○ | ○ | ○ | ○ | ○ |
| | 1080p (60Hz) | ○ | ○ | ○ | ○ | ○ | ○ | ○ | ○ | ○ | ○ | ○ | ○ | ○ | ○ | ○ |

| | | Main picture | | | | | | | | |
|--------------|--------------------|--------------|--------------|--------------|--------------|-------------|-------------|-------------|-------------|-------------|
| | | YPbPr | | | | | | | | |
| | | 1080p (60Hz) | 1080p (50Hz) | 1080i (60Hz) | 1080i (50Hz) | 720p (60Hz) | 720p (50Hz) | 576p (50Hz) | 480p (60Hz) | 480i (60Hz) |
| Sub picture | | | | | | | | | | |
| HDMI | 640 x 480 @ 60Hz | ○ | ○ | ○ | ○ | ○ | ○ | ○ | ○ | ○ |
| | 640 x 480 @ 72Hz | ○ | ○ | ○ | ○ | ○ | ○ | ○ | ○ | ○ |
| | 640 x 480 @ 75Hz | ○ | ○ | ○ | ○ | ○ | ○ | ○ | ○ | ○ |
| | 720 x 400 @ 70Hz | ○ | ○ | ○ | ○ | ○ | ○ | ○ | ○ | ○ |
| | 800 x 600 @ 60Hz | ○ | ○ | ○ | ○ | ○ | ○ | ○ | ○ | ○ |
| | 800 x 600 @ 75Hz | ○ | ○ | ○ | ○ | ○ | ○ | ○ | ○ | ○ |
| | 1024 x 768 @ 60Hz | ○ | ○ | ○ | ○ | ○ | ○ | ○ | ○ | ○ |
| | 1024 x 768 @ 75Hz | ○ | ○ | ○ | ○ | ○ | ○ | ○ | ○ | ○ |
| | 1280 x 768 @ 60Hz | ○ | ○ | ○ | ○ | ○ | ○ | ○ | ○ | ○ |
| | 1280 x 960 @ 60Hz | ○ | ○ | ○ | ○ | ○ | ○ | ○ | ○ | ○ |
| | 1280 x 1024 @ 60Hz | ○ | ○ | ○ | ○ | ○ | ○ | ○ | ○ | ○ |
| | 1360 x 768 @ 60Hz | ○ | ○ | ○ | ○ | ○ | ○ | ○ | ○ | ○ |
| | 1366 x 768 @ 60Hz | ○ | ○ | ○ | ○ | ○ | ○ | ○ | ○ | ○ |
| | 1600 x 1200 @ 60Hz | ○ | ○ | ○ | ○ | ○ | ○ | ○ | ○ | ○ |
| | 1920 x 1080 @ 60Hz | ○ | ○ | ○ | ○ | ○ | ○ | ○ | ○ | ○ |
| | 576i (50Hz) | ○ | ○ | ○ | ○ | ○ | ○ | ○ | ○ | ○ |
| | 480i (60Hz) | ○ | ○ | ○ | ○ | ○ | ○ | ○ | ○ | ○ |
| | 480p (60Hz) | ○ | ○ | ○ | ○ | ○ | ○ | ○ | ○ | ○ |
| | 576p (50Hz) | ○ | ○ | ○ | ○ | ○ | ○ | ○ | ○ | ○ |
| | 720p (50Hz) | ○ | ○ | ○ | ○ | ○ | ○ | ○ | ○ | ○ |
| 720p (60Hz) | ○ | ○ | ○ | ○ | ○ | ○ | ○ | ○ | ○ | |
| 1080i (50Hz) | ○ | ○ | ○ | ○ | ○ | ○ | ○ | ○ | ○ | |
| 1080i (60Hz) | ○ | ○ | ○ | ○ | ○ | ○ | ○ | ○ | ○ | |
| 1080p (50Hz) | ○ | ○ | ○ | ○ | ○ | ○ | ○ | ○ | ○ | |
| 1080p (60Hz) | ○ | ○ | ○ | ○ | ○ | ○ | ○ | ○ | ○ | |

Customer Support

For technical support or product service, see the table below or contact your reseller.

NOTE: You will need the product serial number.

| Country/Region | Website | T = Telephone F = FAX | Email |
|---|-----------------------------|---|---|
| Australia/New Zealand | www.viewsonic.com.au | AUS= 1800 880 818 NZ= 0800 008 822 | service@au.viewsonic.com |
| Canada | www.viewsonic.com | T (Toll-Free)= 1-866-463-4775 T (Toll)= 1-424-233-2533 F= 1-909-468-3757 | service.ca@viewsonic.com |
| Europe | www.viewsoniceurope.com | www.viewsoniceurope.com/uk/support/call-desk/ | |
| Hong Kong | www.hk.viewsonic.com | T= 852 3102 2900 | service@hk.viewsonic.com |
| India | www.in.viewsonic.com | T= 1800 266 0101 | service@in.viewsonic.com |
| Ireland (Eire) | www.viewsoniceurope.com/uk/ | www.viewsoniceurope.com/uk/support/call-desk/ | service_ie@viewsoniceurope.com |
| Korea | www.kr.viewsonic.com | T= 080 333 2131 | service@kr.viewsonic.com |
| Latin America (Argentina) | www.viewsonic.com/la/ | T= 0800-4441185 | soporte@viewsonic.com |
| Latin America (Chile) | www.viewsonic.com/la/ | T= 1230-020-7975 | soporte@viewsonic.com |
| Latin America (Columbia) | www.viewsonic.com/la/ | T= 01800-9-157235 | soporte@viewsonic.com |
| Latin America (Mexico) | www.viewsonic.com/la/ | T= 001-8882328722 | soporte@viewsonic.com |
| Renta y Datos, 29 SUR 721, COL. LA PAZ, 72160 PUEBLA, PUE. Tel: 01.222.891.55.77 CON 10 LINEAS Electroser, Av Reforma No. 403Gx39 y 41, 97000 Mérida, Yucatán. Tel: 01.999.925.19.16 Other places please refer to http://www.viewsonic.com/la/soporte/index.htm#Mexico | | | |
| Latin America (Peru) | www.viewsonic.com/la/ | T= 0800-54565 | soporte@viewsonic.com |
| Macau | www.hk.viewsonic.com | T= 853 2870 0303 | service@hk.viewsonic.com |
| Middle East | ap.viewsonic.com/me/ | Contact your reseller | service@ap.viewsonic.com |
| Puerto Rico & Virgin Islands | www.viewsonic.com | T= 1-800-688-6688 (English) T= 1-866-379-1304 (Spanish) F= 1-909-468-3757 | service.us@viewsonic.com soporte@viewsonic.com |
| Singapore/Malaysia/Thailand | www.viewsonic.com.sg | T= 65 6461 6044 | service@sg.viewsonic.com |
| South Africa | ap.viewsonic.com/za/ | Contact your reseller | service@ap.viewsonic.com |
| United Kingdom | www.viewsoniceurope.com/uk/ | www.viewsoniceurope.com/uk/support/call-desk/ | service_gb@viewsoniceurope.com |
| United States | www.viewsonic.com | T (Toll-Free)= 1-800-688-6688 T (Toll)= 1-424-233-2530 F= 1-909-468-3757 | service.us@viewsonic.com |

Limited Warranty

ViewSonic LCD Monitor

What the warranty covers:

ViewSonic warrants its products to be free from defects in material and workmanship, under normal use, during the warranty period. If a product proves to be defective in material or workmanship during the warranty period, ViewSonic will, at its sole option, repair or replace the product with a like product. Replacement product or parts may include remanufactured or refurbished parts or components.

How long the warranty is effective:

ViewSonic LCD Monitors are warranted for 3 years for all parts excluding the light source and 3 years for labor from the date of the first customer purchase.

Who the warranty protects:

This warranty is valid only for the first consumer purchaser.

What the warranty does not cover:

1. Any product on which the serial number has been defaced, modified or removed.
2. Damage, deterioration or malfunction resulting from:
 - a. Accident, misuse, neglect, fire, water, lightning, or other acts of nature, unauthorized product modification, or failure to follow instructions supplied with the product.
 - b. Repair or attempted repair by anyone not authorized by ViewSonic.
 - c. Any damage of the product due to shipment.
 - d. Removal or installation of the product.
 - e. Causes external to the product, such as electric power fluctuations or failure.
 - f. Use of supplies or parts not meeting ViewSonic's specifications.
 - g. Normal wear and tear.
 - h. Any other cause which does not relate to a product defect.
3. Any product exhibiting a condition commonly known as "image burn-in" which results when a static image is displayed on the product for an extended period of time.
4. Removal, installation, and set-up service charges.

How to get service:

1. For information about receiving service under warranty, contact ViewSonic Customer Support (please refer to Customer Support page). You will need to provide your product's serial number.
2. To obtain warranted service, you will be required to provide (a) the original dated sales slip, (b) your name, (c) your address, (d) a description of the problem, and (e) the serial number of the product.
3. Take or ship the product freight prepaid in the original container to an authorized ViewSonic service center or ViewSonic.
4. For additional information or the name of the nearest ViewSonic service center, contact ViewSonic.

Limitation of implied warranties:

There are no warranties, express or implied, which extend beyond the description contained herein including the implied warranty of merchantability and fitness for a particular purpose.

Exclusion of damages:

ViewSonic's liability is limited to the cost of repair or replacement of the product. ViewSonic shall not be liable for:

1. Damage to other property caused by any defects in the product, damages based upon inconvenience, loss of use of the product, loss of time, loss of profits, loss of business opportunity, loss of goodwill, interference with business relationships, or other commercial loss, even if advised of the possibility of such damages.
2. Any other damages, whether incidental, consequential or otherwise.
3. Any claim against the customer by any other party.

Effect of state law:

This warranty gives you specific legal rights, and you may also have other rights which vary from state to state. Some states do not allow limitations on implied warranties and/or do not allow the exclusion of incidental or consequential damages, so the above limitations and exclusions may not apply to you.

Sales outside the U.S.A. and Canada:

For warranty information and service on ViewSonic products sold outside of the U.S.A. and Canada, contact ViewSonic or your local ViewSonic dealer.

The warranty period for this product in mainland China (Hong Kong, Macao and Taiwan Excluded) is subject to the terms and conditions of the Maintenance Guarantee Card.

For users in Europe and Russia, full details of warranty provided can be found in www.viewsoniceurope.com under Support/Warranty Information.

Mexico Limited Warranty

ViewSonic LCD Monitor

What the warranty covers:

ViewSonic warrants its products to be free from defects in material and workmanship, under normal use, during the warranty period. If a product proves to be defective in material or workmanship during the warranty period, ViewSonic will, at its sole option, repair or replace the product with a like product. Replacement product or parts may include remanufactured or refurbished parts or components & accessories.

How long the warranty is effective:

ViewSonic LCD Monitors are warranted for 3 years for all parts excluding the light source and 3 years for labor from the date of the first customer purchase.

Who the warranty protects:

This warranty is valid only for the first consumer purchaser.

What the warranty does not cover:

1. Any product on which the serial number has been defaced, modified or removed.
2. Damage, deterioration or malfunction resulting from:
 - a. Accident, misuse, neglect, fire, water, lightning, or other acts of nature, unauthorized product modification, unauthorized attempted repair, or failure to follow instructions supplied with the product.
 - b. Any damage of the product due to shipment.
 - c. Causes external to the product, such as electrical power fluctuations or failure.
 - d. Use of supplies or parts not meeting ViewSonic's specifications.
 - e. Normal wear and tear.
 - f. Any other cause which does not relate to a product defect.
3. Any product exhibiting a condition commonly known as "image burn-in" which results when a static image is displayed on the product for an extended period of time.
4. Removal, installation, and set-up service charges.

How to get service:

For information about receiving service under warranty, contact ViewSonic Customer Support (Please refer to the attached Customer Support page). You will need to provide your product's serial number, so please record the product information in the space provided below on your purchase for your future use. Please retain your receipt of proof of purchase to support your warranty claim.

For Your Records

Product Name: _____ Model Number: _____

Document Number: _____ Serial Number: _____

Purchase Date: _____ Extended Warranty Purchase? _____ (Y/N)

If so, what date does warranty expire? _____

1. To obtain warranty service, you will be required to provide (a) the original dated sales slip, (b) your name, (c) your address, (d) a description of the problem, and (e) the serial number of the product.
2. Take or ship the product in the original container packaging to an authorized ViewSonic service center.
3. Round trip transportation costs for in-warranty products will be paid by ViewSonic.

Limitation of implied warranties:

There are no warranties, express or implied, which extend beyond the description contained herein including the implied warranty of merchantability and fitness for a particular purpose.

Exclusion of damages:

ViewSonic's liability is limited to the cost of repair or replacement of the product. ViewSonic shall not be liable for:

1. Damage to other property caused by any defects in the product, damages based upon inconvenience, loss of use of the product, loss of time, loss of profits, loss of business opportunity, loss of goodwill, interference with business relationships, or other commercial loss, even if advised of the possibility of such damages.
2. Any other damages, whether incidental, consequential or otherwise.
3. Any claim against the customer by any other party.
4. Repair or attempted repair by anyone not authorized by ViewSonic.

| Contact Information for Sales & Authorized Service (Centro Autorizado de Servicio) within Mexico: | |
|--|---|
| <i>Name, address, of manufacturer and importers:</i> México, Av. de la Palma #8 Piso 2 Despacho 203, Corporativo Interpalmas, Col. San Fernando Huixquilucan, Estado de México Tel: (55) 3605-1099 http://www.viewsonic.com/la/soporte/index.htm | |
| NÚMERO GRATIS DE ASISTENCIA TÉCNICA PARA TODO MÉXICO: 001.866.823.2004 | |
| Hermosillo: Distribuciones y Servicios Computacionales SA de CV. Calle Juarez 284 local 2 Col. Bugambilias C.P: 83140 Tel: 01-66-22-14-9005 E-Mail: disc2@hmo.megared.net.mx | Villahermosa: Compumantenimientos Garantizados, S.A. de C.V. AV. GREGORIO MENDEZ #1504 COL. FLORIDA C.P. 86040 Tel: 01 (993) 3 52 00 47 / 3522074 / 3 52 20 09 E-Mail: compumantenimientos@prodigy.net.mx |
| Puebla, Pue. (Matriz): RENTA Y DATOS, S.A. DE C.V. Domicilio: 29 SUR 721 COL. LA PAZ 72160 PUEBLA, PUE. Tel: 01(52).222.891.55.77 CON 10 LINEAS E-Mail: datos@puebla.megared.net.mx | Veracruz, Ver.: CONEXION Y DESARROLLO, S.A DE C.V. Av. Americas # 419 ENTRE PINZÓN Y ALVARADO Fracc. Reforma C.P. 91919 Tel: 01-22-91-00-31-67 E-Mail: gacosta@qplus.com.mx |
| Chihuahua Soluciones Globales en Computación C. Magisterio # 3321 Col. Magisterial Chihuahua, Chih. Tel: 4136954 E-Mail: Cefeo@soluglobales.com | Cuernavaca Compusupport de Cuernavaca SA de CV Francisco Leyva # 178 Col. Miguel Hidalgo C.P. 62040, Cuernavaca Morelos Tel: 01 777 3180579 / 01 777 3124014 E-Mail: aquevedo@compusupportcva.com |
| Distrito Federal: QPLUS, S.A. de C.V. Av. Coyoacán 931 Col. Del Valle 03100, México, D.F. Tel: 01(52)55-50-00-27-35 E-Mail : gacosta@qplus.com.mx | Guadalajara, Jal.: SERVICRECE, S.A. de C.V. Av. Niños Héroes # 2281 Col. Arcos Sur, Sector Juárez 44170, Guadalajara, Jalisco Tel: 01(52)33-36-15-15-43 E-Mail: mmiranda@servicrece.com |
| Guerrero AcapulcoGS Computación (Grupo Sesicomp) Progreso #6-A, Colo Centro 39300 Acapulco, Guerrero Tel: 744-48-32627 | Monterrey: Global Product Services Mar Caribe # 1987, Esquina con Golfo Pérsico Fracc. Bernardo Reyes, CP 64280 Monterrey N.L. México Tel: 8129-5103 E-Mail: aydeem@gps1.com.mx |
| MÉRIDA: ELECTROSER Av Reforma No. 403Gx39 y 41 Mérida, Yucatán, México CP97000 Tel: (52) 999-925-1916 E-Mail: rrrb@sureste.com | Oaxaca, Oax.: CENTRO DE DISTRIBUCION Y SERVICIO, S.A. de C.V. Murguía # 708 P.A., Col. Centro, 68000, Oaxaca Tel: 01(52)95-15-15-22-22 Fax: 01(52)95-15-13-67-00 E-Mail: gpotai2001@hotmail.com |
| Tijuana: STD Av Ferrocarril Sonora #3780 L-C Col 20 de Noviembre Tijuana, Mexico | FOR USA SUPPORT: ViewSonic Corporation 381 Brea Canyon Road, Walnut, CA. 91789 USA Tel: 800-688-6688 (English); 866-323-8056 (Spanish); Fax: 1-800-685-7276 E-Mail: http://www.viewsonic.com |



Free Manuals Download Website

<http://myh66.com>

<http://usermanuals.us>

<http://www.somanuals.com>

<http://www.4manuals.cc>

<http://www.manual-lib.com>

<http://www.404manual.com>

<http://www.luxmanual.com>

<http://aubethermostatmanual.com>

Golf course search by state

<http://golfingnear.com>

Email search by domain

<http://emailbydomain.com>

Auto manuals search

<http://auto.somanuals.com>

TV manuals search

<http://tv.somanuals.com>