

ViewSonic®

32/37/42 吋 Full-HD 液晶顯示器

32/37/42-Inch Full-HD LCD Display



- 使用手冊
- User Guide

Model No. : VT3245-NT / VT3745-NT / VT4245-NT

繁體
中文

ENGLISH

Contents

Important Safety Instructions	1
Declaration of RoHS Compliance.....	2
Copyright Information.....	3
Product Registration.....	3
Antenna Installation Instructions	4
Cleaning the LCD Display	4
Overview of the LCD Display	5
Product components	5
Front view	6
Rear view (32/42-inch).....	7
Rear view (32/42-inch).....	8
Remote Control.....	9
Remote Control.....	10
Getting started	11
Inserting the remote control batteries	11
Connecting power	11
Cable Connections.....	12
Basic Operation.....	15
Basic Operation.....	16
Using the OSD Menu	17
Picture Adjustment.....	18
Sound Adjustment.....	20
TV Tuner Adjustment	22
DTV OSD Functions.....	23
PC Setup	25
Setup Adjustment.....	26
Using a USB Source	27
Program Guide.....	28
Other Information	29
Troubleshooting	29
Customer Support.....	30
Limited Warranty	31

Important Safety Instructions

1. Read these instructions.
2. Keep these instructions.
3. Heed all warnings.
4. Follow all instructions.
5. Do not use this unit near water.
6. Clean with a soft, dry cloth. If still not clean, see “Cleaning the Display” in this guide for further instructions.
7. Do not block any ventilation openings. Install the unit in accordance with the manufacturer’s instructions.
8. Do not install near any heat sources such as radiators, heat registers, stoves, or other devices (including amplifiers) that produce heat.
9. To firmly secure the VT3745-NT LCD Display to your desktop or stand, fasten the anti-tip auxiliary screw in the support hole for safety concerns.

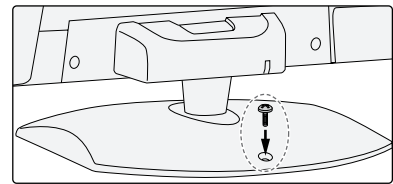

螺絲建議尺寸：M4 x 14mm (1支)

10. Follow the instructions in the image on the right to install the stand on the VT3245-NT model.

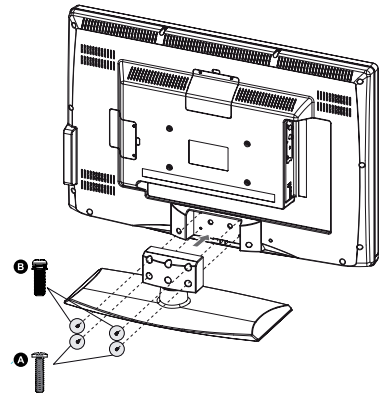

11. Do not defeat the safety purpose of the polarized or grounding-type plug. A polarized plug has two blades with one wider than the other. A grounding type plug has two blades and a third grounding prong. The wide blade and the third prong are provided for your safety. If the provided plug does not fit into your outlet, consult an electrician for replacement of the obsolete outlet.
12. Protect the power cord from being walked on or pinched particularly at plugs. Convenience receptacles and the point where they exit from the unit. Be sure that the power outlet is located near the unit so that it is easily accessible.
13. Only use attachments/accessories specified by the manufacturer.

14.  Use only with the cart, stand, tripod, bracket, or table specified by the manufacturer, or sold with the unit. When a cart is used, use caution when moving the cart/unit combination to avoid injury from tipping over.
15. Unplug this unit when unused for long periods of time.
16. Refer all servicing to qualified service personnel. Servicing is required when the unit has been damaged in any way, such as: if the power-supply cord or plug is damaged, if liquid is spilled onto or objects fall into the unit, if the unit is exposed to rain or moisture, or if the unit does not operate normally or has been dropped.
17. Operating temperature: 0~40°C.

Following information is only for EU-member states:

The mark shown to the right is in compliance with the Waste Electrical and Electronic Equipment Directive 2002/96/EC (WEEE).

The mark indicates the requirement NOT to dispose the equipment as unsorted municipal waste, but use the return and collection systems according to local law.

If the batteries, accumulators and button cells included with this equipment, display the chemical symbol Hg, Cd, or Pb, then it means that the battery has a heavy metal content of more than 0.0005% Mercury or more than, 0.002% Cadmium, or more than 0.004% Lead.



Declaration of RoHS Compliance

This product has been designed and manufactured in compliance with Directive 2002/95/EC of the European Parliament and the Council on restriction of the use of certain hazardous substances in electrical and electronic equipment (RoHS Directive) and is deemed to comply with the maximum concentration values issued by the European Technical Adaptation Committee (TAC) as shown below:

Substance	Proposed Maximum Concentration	Actual Concentration
Lead (Pb)	0.1%	< 0.1%
Mercury (Hg)	0.1%	< 0.1%
Cadmium (Cd)	0.01%	< 0.01%
Hexavalent Chromium (Cr ⁶⁺)	0.1%	< 0.1%
Polybrominated biphenyls (PBB)	0.1%	< 0.1%
Polybrominated diphenyl ethers (PBDE)	0.1%	< 0.1%

Certain components of products as stated above are exempted under the Annex of the RoHS Directives as noted below:

Examples of exempted components are:

1. Mercury in compact fluorescent lamps not exceeding 5 mg per lamp and in other lamps not specifically mentioned in the Annex of RoHS Directive.
2. Lead in glass of cathode ray tubes, electronic components, fluorescent tubes, and electronic ceramic parts (e.g. piezoelectronic devices).
3. Lead in high temperature type solders (i.e. lead-based alloys containing 85% by weight or more lead).
4. Lead as an alloying element in steel containing up to 0.35% lead by weight, aluminium containing up to 0.4% lead by weight and as a copper alloy containing up to 4% lead by weight.



The "HD ready" Logo is a trademark of EICTA.

Copyright Information

Copyright © ViewSonic® Corporation, 2010. All rights reserved.

ViewSonic, the three birds logo, OnView, ViewMatch, and ViewMeter are registered trademarks of ViewSonic Corporation.

Disclaimer: ViewSonic Corporation shall not be liable for technical or editorial errors or omissions contained herein; nor for incidental or consequential damages resulting from furnishing this material, or the performance or use of this product.

In the interest of continuing product improvement, ViewSonic Corporation reserves the right to change product specifications without notice. Information in this document may change without notice.

No part of this document may be copied, reproduced, or transmitted by any means, for any purpose without prior written permission from ViewSonic Corporation.

Product Registration

To meet your future needs, and to receive any additional product information as it becomes available, please register your product on the Internet at: www.viewsonic.com.tw

For Your Records	
Product Name:	VT3245-NT, VT3745-NT, VT4245-NT
Model Name:	ViewSonic LCD Full-HD LCD Display
Document Number:	VS12920-1P, VS12921-1P, VS12922-1P VT3245-NT_UG_TCH Rev. 1A 12-30-09
Serial Number:	_____
	VT3745-NT_UG_TCH Rev. 1A 12-30-09
Serial Number:	_____
	VT4245-NT_UG_TCH Rev. 1A 12-30-09
Serial Number:	_____
Purchase Date:	_____

Product disposal at end of product life

ViewSonic is concerned about the preservation of our environment. Please dispose of this product properly at the end of its useful life. Your local waste disposal company may provide information about proper disposal.

The lamp in this product contains mercury. Please dispose of properly in accordance with environmental laws of your location.

Antenna Installation Instructions

1. Outdoor Antenna Grounding

If an outside antenna or cable system is connected to the product be sure the antenna or cable system is grounded so as to provide some protection against voltage surges and built-up static charges, Article 810 of the National Electrical Code, ANSI/NFPA 70, provides information with regard to proper grounding of the mast and supporting structure, grounding of the lead-in wire to an antenna discharge unit, connection to grounding electrodes, and requirements for the grounding electrode.

2. Lightning

For added protection for this product during a lightning storm, or when it is left unattended and unused for long periods of time, unplug it from the wall outlet and disconnect the antenna or cable system. This will prevent damage to the product due to lightning and power-line surges. Do not disconnect the antenna or the power cord during a heavy storm lightning may strike while you are holding the cable cord, causing serious injury; turn off your LCD Display and wait for the weather to improve.

3. Power Lines

An outside antenna system should not be located in the vicinity of overhead power lines or other electric light or power circuits, or where it can fall into such power lines or circuits, When installing an outside antenna system, extreme care should be taken to keep from touching such power lines or circuits as contact with them might be fatal.

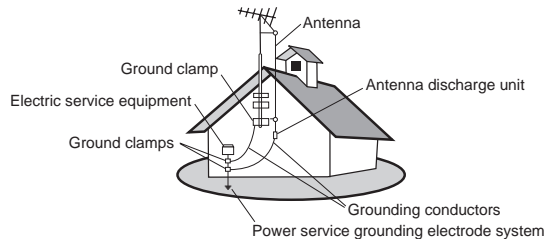

Cleaning the LCD Display

- Make sure the LCD Display is turned off.
- Never spray or pour any liquid directly onto the screen or case.

To clean the screen:

1. Wipe the screen with a clean, soft, lint-free cloth. This removes dust and other particles.
2. If still not clean, apply a small amount of non-ammonia, non-alcohol based glass cleaner onto a clean, soft, lint-free cloth, and wipe the screen.

To clean the case:

1. Use a soft, dry cloth.
2. If still not clean, apply a small amount of a non-ammonia, non-alcohol based, mild non-abrasive detergent onto a clean, soft, lint-free cloth, then wipe the surface.

Disclaimer

ViewSonic® does not recommend the use of any ammonia or alcohol-based cleaners on the LCD Display screen or case. Some chemical cleaners have been reported to damage the screen and/or case of the LCD Display. ViewSonic will not be liable for damage resulting from use of any ammonia or alcohol-based cleaners.

Overview of the LCD Display

Congratulation in purchasing the LCD Color Display. This product has been designed to provide you with a rich audio and video experience. This monitor enables you to watch broadcast or cable television ,channels, connect VCR, VCD or DVD player to watch your favorites movies, or connect a computer to use the display as a monitor. The LCD Display is equipped with convenient control buttons located on the front panel and a handy remote control to let you adjust the setting and customize the preferences through an easy-to -use on screen menu system.

Enjoy the versatility of your LCD Display with its wide variety of features:

Color active matrix TFT LCD Display with remote control

Safe, sturdy construction

Maximum display resolution: 1920 x 1080

Audio / Video support

- HDMI analog audio input
- Component (YCbCr / YPbPr) video/audio input
- S-Video/Audio input
- AV-Video/Audio input
- VGA input
- PC audio input
- Earphone output

On-Screen Display (OSD) menu system

Product components

The following section describes the various components of the LCD Display. Please take a few moments to familiarize yourself with the product and control panel before using it .

When you unpack this LCD Display, please make sure the box contains the following items:

- LCD Color Display
- Power Cord
- Remote Control (with 2 AAA batteries)
- User Manual
- Quick Start Guide

* If any of these items were missing or damaging, please contact service party for assistance.

Used or discharged batteries must be properly disposed of or recycled in compliance with all applicable laws.

For detailed information, contact your local solid waste disposal authority



Batteries recycle

Front view

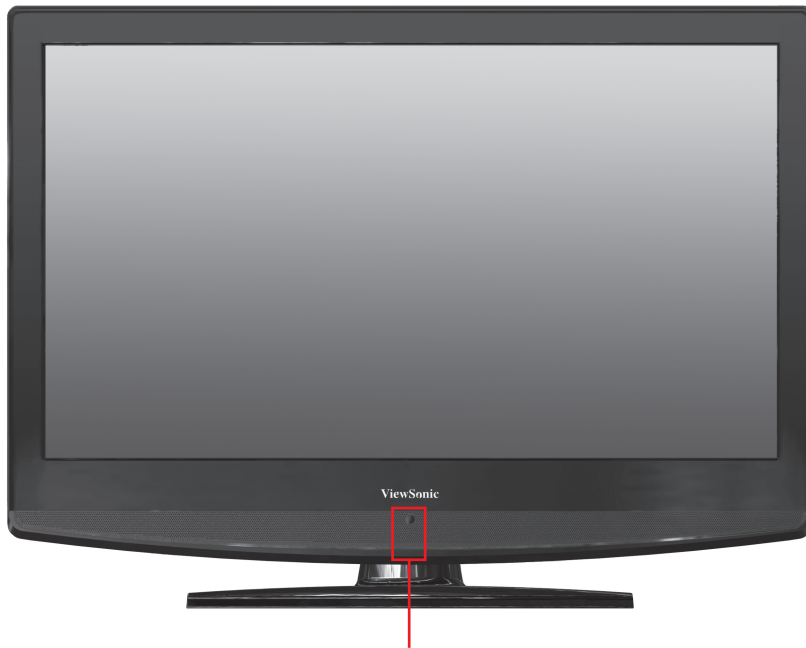

Power Indicator LED

- ① 訊號源 SOURCE
Switch among the input source.
- ② 選單 MENU
Press the button to enter On Screen Display (OSD).
- ③ 音量 VOL +/-
Increase or decrease the volume.
- ④ 選擇 CH ▲/▼
Increase or decrease channel number.
- ⑤ 電源 POWER
Increase or decrease ch



Power indicator LED indicates if the LCD power is turned on (blue) or in stand-by state (red).

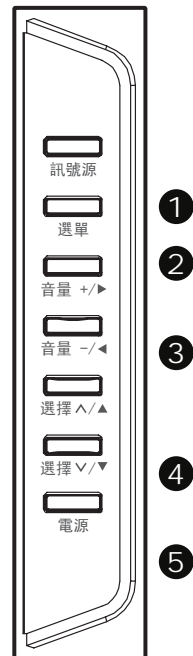

Rear view (32/42-inch)

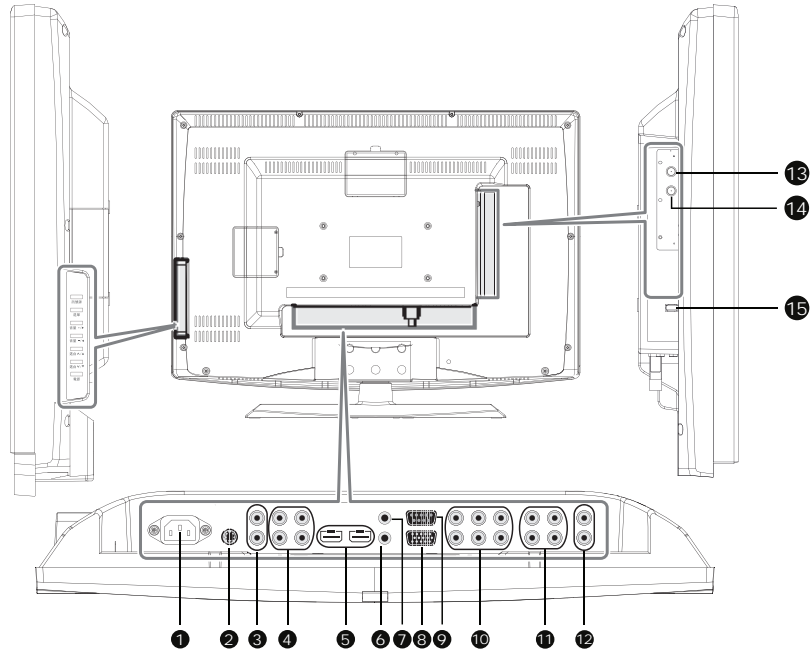

NO	ITEM	FUNCTION
①	AC-IN	Connect to the AC outlet.
②	S-VIDEO IN	Connect to the S-Video output jack of your video/audio device.
③	AV IN	Connect to the A/V output jack of your A/V device.
④	AV AUDIO IN	Connect to the A/V output jack of your A/V device.
⑤	HDMI IN	Connect to the HDMI output of your PC or portable computer or A/V device.
⑥	PC AUDIO IN	Connect to the audio output of your computer.
⑦	AUDIO OUT	Connect to the audio input jack of your audio device.
⑧	PC -IN	Connect to the VGA output of your PC or portable computer.
⑨	RS232 IN	Connect RS-232 serial port cable for remote control (for service only).
⑩	COMPONENT IN	Connect to the component output jack of your component device.
⑪	COMPONENT AUDIO IN	Connect to the component output jack of your component device.
⑫	AUDIO OUT	Connect to the audio input jack of your Audio device.
⑬	ANTENNA/TV MODULE CONNECTORS	Connect to the ATV signal and DTV signal.
⑭	ANTENNA/TV MODULE CONNECTORS	Connect to the ATV signal and DTV signal.
⑮	USB	Connect a USB source.

Rear view (32/42-inch)

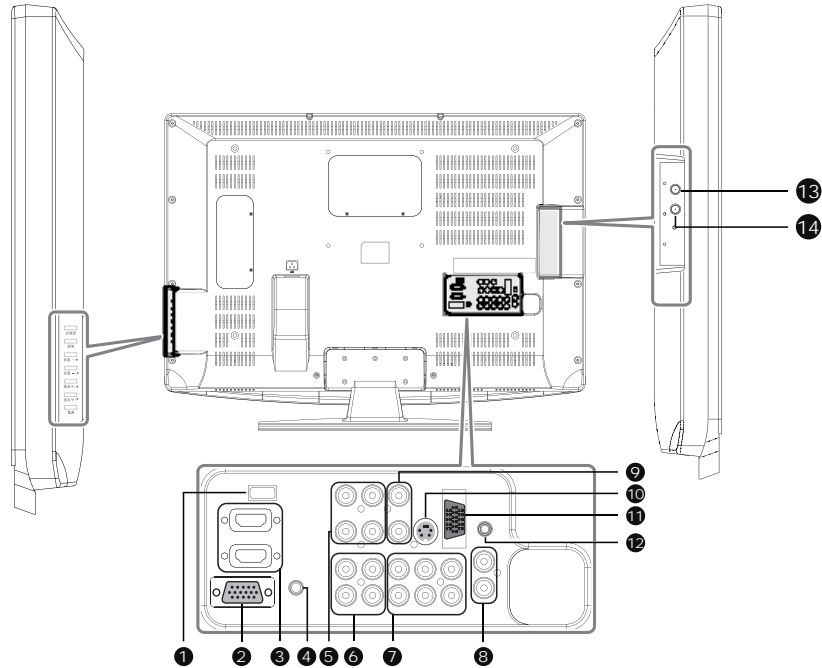

NO	ITEM	FUNCTION
①	USB	Connect a USB source.
②	PC -IN	Connect to the VGA output of your PC or portable computer.
③	HDMI IN	Connect to the HDMI output of your PC or portable computer or A/V device.
④	PC AUDIO IN	Connect to the audio output of your computer.
⑤	AV AUDIO IN	Connect to the A/V output jack of your A/V device.
⑥	COMPONENT IN	Connect to the component output jack of your component device.
⑦	COMPONENT AUDIO IN	
⑧	AUDIO OUT	Connect to the audio input jack of your audio device.
⑨	AV IN	Connect to the A/V output jack of your A/V device.
⑩	S-VIDEO IN	Connect to the S-Video output jack of your video/audio device.
⑪	RS232 IN	Connect RS-232 serial port cable for remote control (for service only).
⑫	AUDIO OUT	Connect to the audio input jack of your Audio device.
⑬	ANTENNA/TV MODULE	Connect to the ATV signal and DTV signal.
⑭	CONNECTORS	

Remote Control

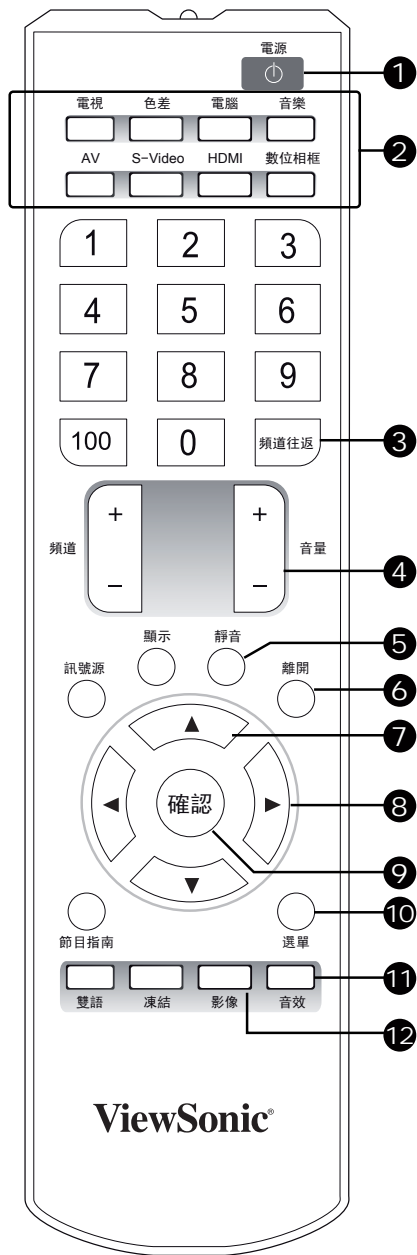

1 電源 POWER

Turn power ON or OFF.

2 SOURCE HOTKEYS

Press the hotkeys to select the input source.

3 頻道往返 RETURN

Switch to the previous viewed channel.

4 音量 +/- VOL+/-

Increase + or decreases - the volume.

5 靜音 MUTE

Disable the audio output.

6 離開 EXIT

Exit OSD menus.

7 OSD MENU UP/FAST FORWARD

Move up in OSD menus/fast forward media.

8 OSD MENU RIGHT/SKIP FORWARD

Move right in OSD menus/skip to next media.

9 確認 ENTER/PLAY

Enter the selected OSD item/Play media.

10 選單 MENU

Press to enter current source OSD Menu.

11 音效 SOUND MODE

Select the desired Sound Mode.

12 影像 PICTURE MODE

Switch among four picture modes to change the picture quality : USER, STANDARD, VIVID, SOFT.

Remote Control

ENGLISH

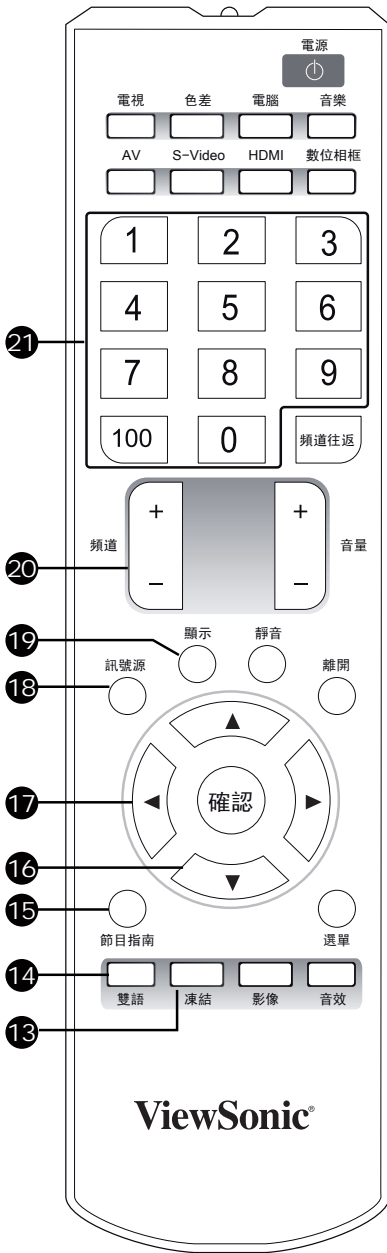

13 凍結 FREEZE

Freeze the present image on the screen. To continue, press the button again.

14 雙語 MTS

Switch between monaural, stereo, and audio modes. This function enable you to receive a second language or unrelated audio.

15 GUIDE (ONLY IN DTV OSD MENU)

Enter the program guide of DTV OSD.

16 睡眠 SLEEP TIMER

Press repeatedly to set the sleep timer from 15 to 60 minutes.

17 OSD MENU LEFT/SKIP BACKWARD

Move left in OSD menus/skip to previous media

18 訊號源 SOURCE

Select the video source signal.

19 顯示 DISPLAY

Press to display the information of input signal.

20 頻道 CHANNEL +/-

Press the + or - keys to increase or decrease the channel number.

21 數字鍵 NUMBER KEYS

Press the number keys to enter channel numbers.

Getting started

Please refer to the following sections for detailed instructions about connecting the audio/ video (AV) device of your LCD Display and view your favorite programmes or movies .These sections describe the basic procedures required to set up your Display for easy and convenient viewing.

Inserting the remote control batteries

Insert the two AAA batteries provided into the remote control as described below:

1. Pull the latch on the battery compartment cover on the rear of the remote control and remove the cover.
2. Insert the two supplied AAA batteries .Check the + and - ends of the batteries before inserting them in the compartment.
3. Replace the cover and make sure it snaps securely back into place.

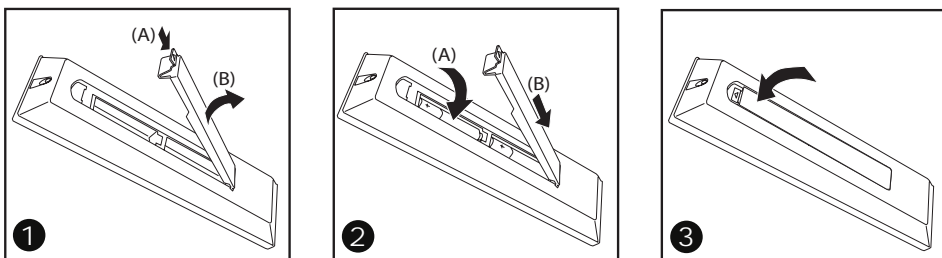

- Do not mix old and new batteries or batteries of different types together.
- Do not short -circuit ,disassemble ,heat or fire batteries.
- Remove the batteries to avoid damage from possible battery leakage if you anticipate that the remote control will not be used for an extended period of time.
- Please handle the remote control with care. Avoid dropping it ,getting it wet ,or placing it in direct sunlight, near a heater or in an area of high humidity.

Connecting power

1. Connect the supplied power cord to the AC IN jack on the rear of Display.
2. Connect the other end of the power cord to a power outlet.(AC 110V 60Hz).

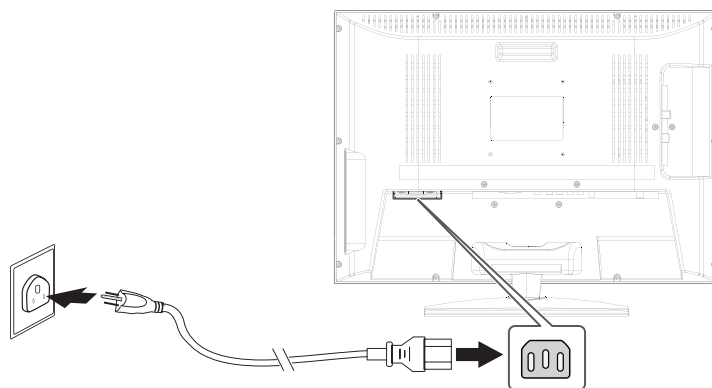

Cable Connections

PC Connector

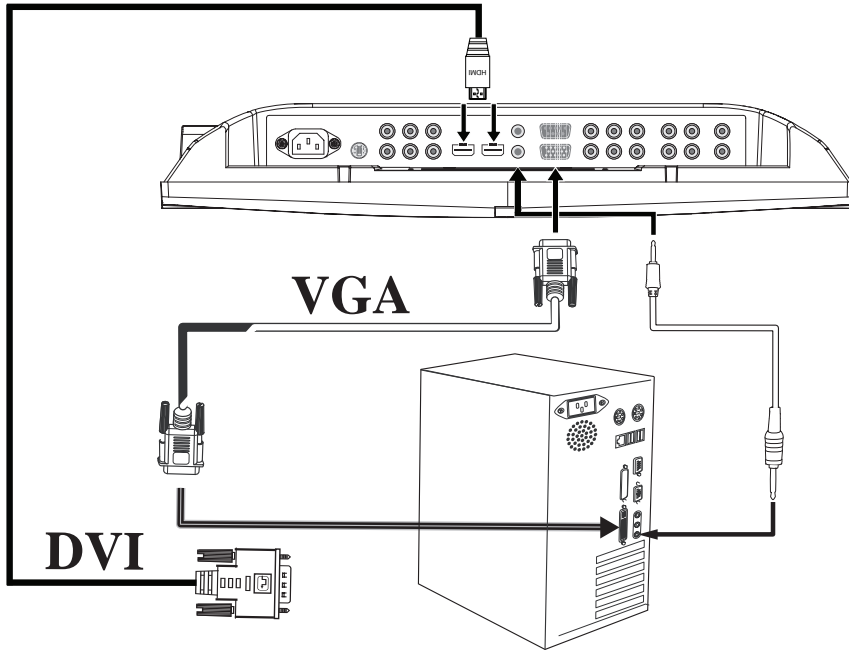

ENGLISH

Supported Resolutions

Compatibility table of PC						
Mode		Inputs				
Standard	Resolution	Composite	SVHS	YPbPr	RGB	HDMI
DOS	720x400(70Hz)	No	No	No	Yes	Yes
VESA	640x480(60Hz)	No	No	No	Yes	Yes
VESA	800x600(60Hz)	No	No	No	Yes	Yes
VESA	1024x768(60Hz)	No	No	No	Yes	Yes
VESA	1360x768(60Hz)	No	No	No	Yes	Yes
VESA	1280x720(60Hz)	No	No	No	No	Yes
VESA	1280x1024(60Hz)	No	No	No	Yes	Yes
VESA	1920x1080(60Hz)	No	No	No	Yes	Yes

Other Connections

(32/42-inch)

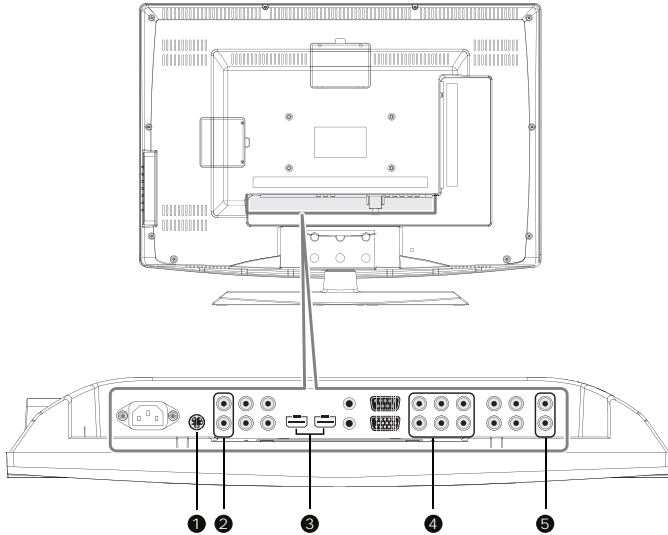

(37-inch)

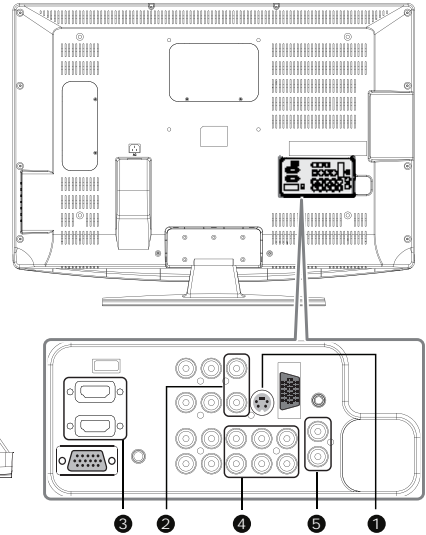

1



S-video cable

Connect to devices with S-video output such as DVD players, Digital cameras, and satellite receivers.

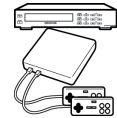

2

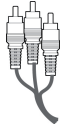

A/V connector

Connect to devices with A/V output such as VCRs, VCD players, and DVD players.

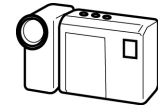

3



HDMI

Connect to devices with HDMI output such as Blu-ray players, DVD players, Cable boxes, VCR / VCD players, PCs, and portable PCs.



4

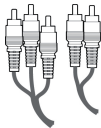

Component cable

Connect to devices such as DVD players, Digital TV receivers, and Digital satellite receivers.



5

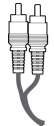

Audio cable

Connect to devices with audio output such as DVD recorders, VCRs, and Home theater audio equipment.



Compatibility table of Video						
Mode		Inputs				
Standard	Resolution	Composite	SVHS	YPbPr	RGB	HDMI
NTSC	480i(60Hz)	Yes	Yes	Yes	No	Yes
EDTV	480p(60Hz)	No	No	Yes	No	Yes
SDTV	576i(60Hz)	No	No	Yes	No	Yes
SDTV	576p(60Hz)	No	No	Yes	No	Yes
HDTV	720p(50Hz)	No	No	Yes	No	Yes
HDTV	720p(60Hz)	No	No	Yes	No	Yes
HDTV	1080i(50Hz)	No	No	Yes	No	Yes
HDTV	1080i(60Hz)	No	No	Yes	No	Yes
HDTV	1080p(50Hz)	No	No	Yes	No	Yes
HDTV	1080p(24Hz)	No	No	No	No	Yes
HDTV	1080p(60Hz)	No	No	Yes	No	Yes

Notes:

Refer to these notes before connecting any audio / video equipment to this Display:

- Refer to the manuals of your Display, stereo, or other equipment.
- Disconnect all equipment from the power outlets. Connect the equipment to the power outlets only after you have completed connecting everything. Never make or change connections when equipment still connected to a power outlet.
- Connect DVD player directly to the Display. For example, do not connect DVD player to VCR and then connect the VCR to your Display. This type of connection could distort both the picture and the sound. Your VCR might have a copy protection system which could distorted the DVD image.
- Set the stereo system to the correct channel or source if your video equipment is also connected to a stereo system.
- You only need one audio connection and one video connection between your Display and other audio/video equipment (such as DVD player, VCR, Camcorder). This means it is possible you will not use all the jacks on the Display.
- If you plan to watch Display via your DVD player or VCR, connect a coaxial cable to the DVD player's or VCR's TUNER IN jack then connect to the antenna jack on your LCD Display. This allows you to watch channels on the Display normally when the DVD player or VCR is off.
- The function of your existing audio/video equipment, governing the connection mode between your Display and existing audio/video equipment. Progressive Scan Component Video and Component Video have the highest picture quality but it can only be used if the connected video equipment supports Progressive Scan Component Video or component video. S-Video provides a high signal quality. Composite Video (a yellow Video jack) provides a good video output. Please follow the correct step to connect existing audio/video equipment.

Basic Operation



1 Turn the LCD Display ON

Press the POWER key to turn on or off the power of the LCD Display. The indicate light is blue as power ON and orange as power OFF.

2 Select Channel

Press 選擇 ▲▼ or 頻道+/- key to increase or decrease the channel number.

3 Adjust Volume

Press 音量+/- key to increase (+) or decrease (-) the volume.

4 Menu

Press 選單 key to enter current source OSD Menu.

5 Switch the input source

Press 訊號源 key to list input source.

Press ▲▼ key to choose the input source, select and switch the wanted input source.

Press 確認 to adjust.

Use the Source Hotkeys to select the input source directly.

Basic Operation

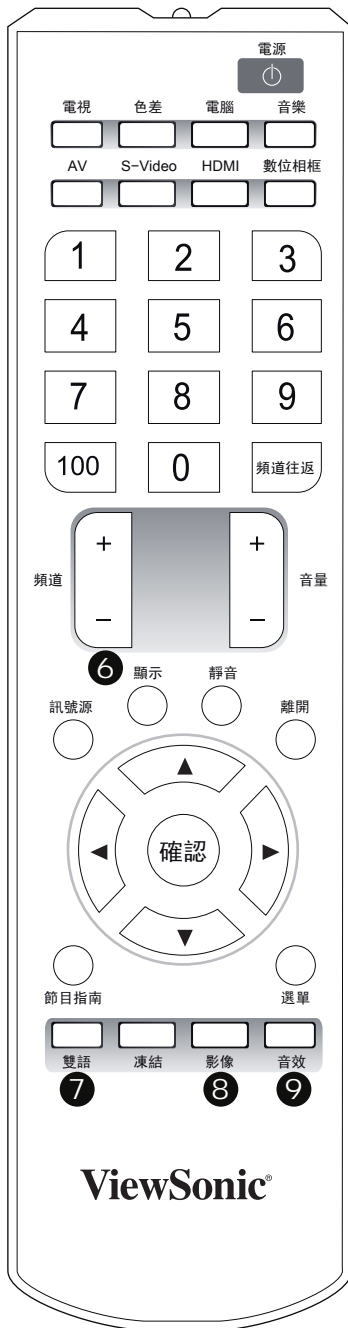

6 Display

Press 顯示 key to display channel number (in TV mode) and information of output signal.

7 MTS

Press 雙語 key to switch monaural and stereo modes. This function enable you to receive a second language or unrelated audio.

8 PICTURE MODE

Press 影像 key to change the picture quality : USER, STANDARD, VIVID, SOFT.

9 Sound Mode

Press 音效 key repeatedly to select sound mode.

Using the OSD Menu

The On-Screen Display (OSD) menu system provides a quick and simple method to adjust LCD Display base setting. OSD menu can be viewed using both the remote control and the control buttons on the control panel.

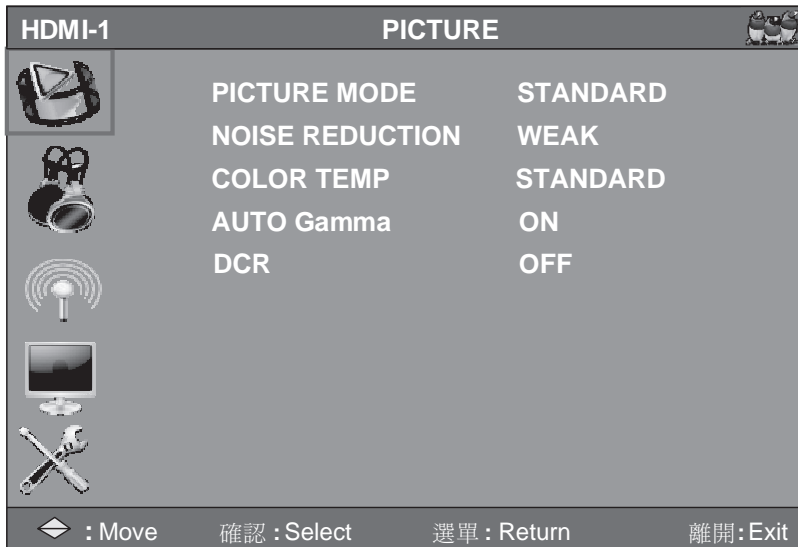

- 1 Press 選單 key on the control panel or the remote control to view OSD menu.
- 2 Press ▲▼ key to select the function.
- 3 Press 確認 key to enter the sub menu.
- 4 Press ▲▼ key to select the item and press ◀▶ to adjust.
- 5 Press 選單 key on the control panel or 離開 key on the remote control to exit OSD menu.



After change settings on the OSD menu, the new settings are confirmed automatically when OSD picture vanish, even did not press the menu to exit the OSD system.

Picture Adjustment

The Picture adjustment enables you to adjust Brightness, Contrast, Sharpness, Color, Hue, Color Temp, and Dynamic Contrast.

- 1 Press **選單** key on the control panel or the remote control to view OSD menu.



- 2 Press **▲▼** key to select [PICUTURE] mode.
Press **◀▶** or **+/-** key to select (PICTURE MODE) item.

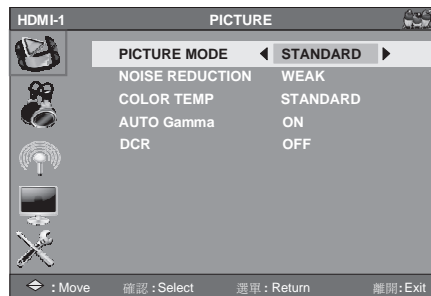

- 3 Press **◀▶** or **+/-** key to select USER, STANDARD, VIVID, or SOFT.

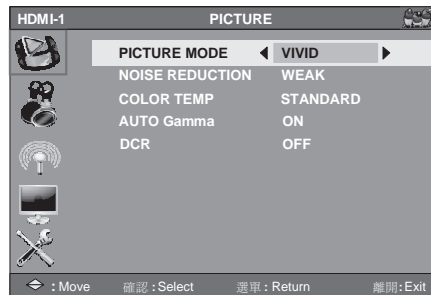

In preset Picture Modes, it is allowed to adjust each subpicture-item setting. Press **▲▼** key to select item and press **◀▶** key or **+/-** key to adjust setting.

4

Press 選單 key on the control panel or 離開 key on the remote control to exit OSD menu.

(BRIGHTNESS)

Adjust the levels of light on your screen. It should be used in conjunction with the contrast option.

(CONTRAST)

Adjust the difference between the dark and light level on your screen.

(SHARPNESS)

Adjust the sharpness level on your screen.

(COLOR)

Change the dominant color intensity on your screen. Adjust this setting until the colors on the screen look natural.

(HUE)

Change the color balance. Adjust this setting so that colors on the screen are neither too green or too magenta.

(Not applicable in PC mode)

(NOISE REDUCTION)

Press ◀▶ or +/- key to adjust the level of the noise removal (OFF, WEAK, MEDIUM, or STRONG. .

(COLOR TEMPERATURE)

Adjust the image color intensity:

USER, STANDARD, COOL, WARM

(AUTO GAMMA)

Press ◀▶ or +/- key to to turn on/off the auto gamma adjustment on the picture.

(Not applicable in PC mode)

(DCR)

Turn on of off auto contrast adjustment.

(Not applicable in PC mode)

Sound Adjustment

The Sound adjustment enables you to adjust volume, treble, bass, balance, speaker output and surround setting.

- 1 Press 選單 key on the control panel or the remote control to view OSD menu.

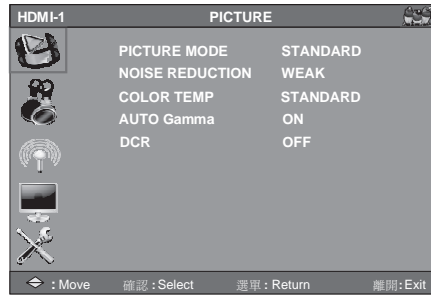

- 2 Press ▲▼ key to select [SOUND] mode.
Press ◀▶ or +/- key to enter sub-menu.

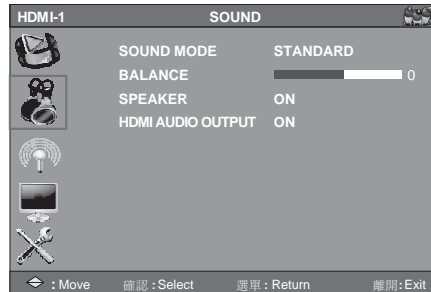

- 3 Press ◀▶ key to select (SOUND MODE).

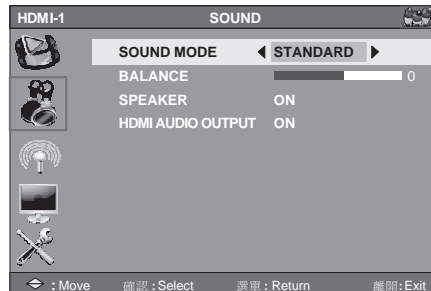

In default SOUND MODE, it is allowed to adjust each sub audio-item setting. Press ▲▼ key to select an item and press ◀▶ key or +/- key to adjust the settings.

4 Press ◀▶ or +/- key to select STANDARD, MUSIC, MOVIE, SPEECH, USER.

5 Press 選單 key on the control panel or 離開 key on the remote control to exit OSD menu.

(TREBLE/BASE)
Adjust the high frequency content in audio output.

(BALANCE)
Balance the volume of right and left speakers.

(AUTO VOLUME)
Turn AUTO VOLUME Control on or off.

(SPEAKER)
Turn auto speaker adjustment on or off.

(HDMI AUDIO INPUT)
Select the audio input source:
HDMI, VGA

TV Tuner Adjustment

- The Tuner Adjustment enables user to adjust the settings of tuner function.
- Tuner Adjustment can only be operated in TV mode.

- 1 Press 選單 key on the control panel or the remote control to view OSD menu.

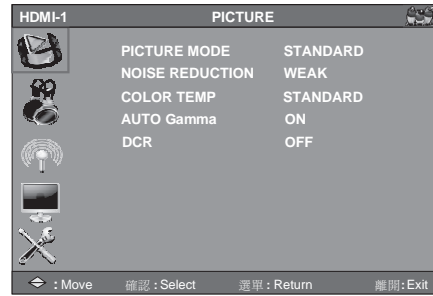

- 2 Press ▲▼ key to select [CHANNEL] mode.
Press ◀▶ or +/- key to enter sub-menu.

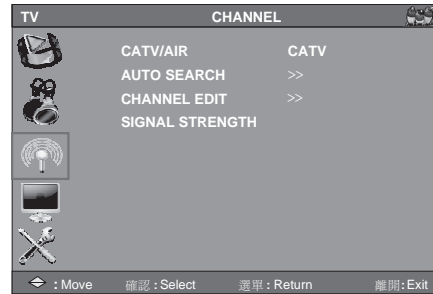

- 3 Press ▲▼ key to select (CATV/AIR).

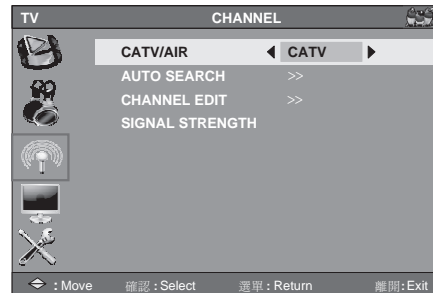

- 4 Press ▲▼ key to select (AUTO SEARCH) and press ▶ to start scanning channels.



- 5 Press 選單 key on the control panel or 離開 key on the remote control to exit OSD menu.

DTV OSD Functions

The DTV OSD (On-Screen Display) menu present user a consistent look and feel throughout. User can adjust the DTV channel system setting in this menu.



First time enter DTV OSD, the DTV channel system will be automatically search all channels.

Press 選單 key on the control panel or the remote control to view OSD menu.

Press ▲▼ key to select [DTV] mode then press ◀▶ or +/- key to enter sub-menu (make sure the input source is in DTV mode).

DTV OSD MENU includes these main options:

- AUTO SEARCH
- CHANNEL EDIT
- SIGNAL STRENGTH



DTV Channel Management

- 1 Press ▲▼ key to select (CHANNEL EDIT).
Press ► key to enter the CHANNEL EDIT submenu.

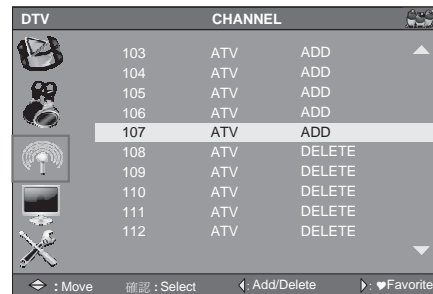

- 2 Press 選單 key on the control panel or 離開 key on the remote control to exit OSD menu.

DTV Functions

- 1 Press ▲▼ key to select (AUTO SEARCH) item and press ► to start scanning channels.

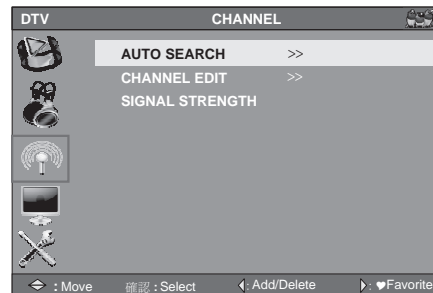

Discovered TV channels are displayed in the corresponding panels.

- 2 Press ▲▼ key to select (SIGNAL STRENGTH).
Press ◀▶ key to adjust the level of the signal strength.

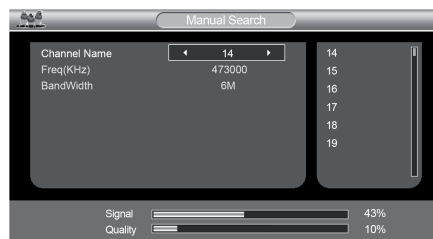

Press ◀▶ to select a channel to scan. The signal strength and quality are displayed at the bottom of the screen.

Press [PLAY] to add the selected channel to the channel list.

- 3 Press 選單 key on the control panel or 離開 key on the remote control to exit OSD menu.

PC Setup

The PC Setup adjustment enable you to adjust PC mode settings: AUTO ADJUST, H POSITION, V POSITION, PHASE, and CLOCK (make sure the input source is in PC mode).

- 1 Press 選單 key on the control panel or the remote control to view OSD menu.

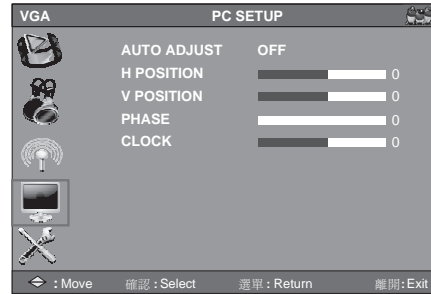

- 2 Press ▲▼ key to select [PC SETUP] mode.
Press ◀▶ or +/- key to enter sub-menu.

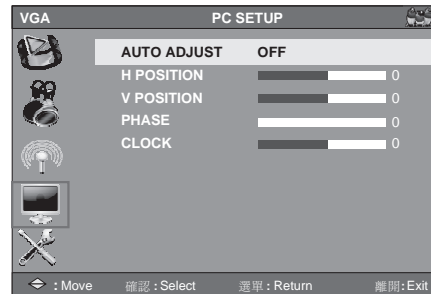

- 3 Press ▲▼ key to select (AUTO ADJUST).
Press ▶ key to auto adjust screen to the best position.

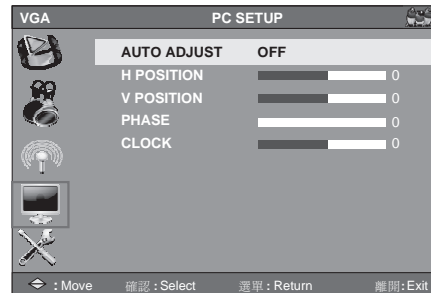

- 4 Press ▲▼ key to select PC SETUP parameters.
Press ◀▶ key to adjust the screen to the best position:
 - H POSITION—adjust the horizontal position of the screen.
 - V POSITION—adjust the vertical position of the screen.
 - PHASE—adjust phase for the display.
 - CLOCK—adjust the clock frequency of display.

Setup Adjustment

- The Setup adjustment enables you to adjust LANGUAGE, OSD TIME, SLEEP TIMER, CLOCK MODE, CLOCK SET, SCREEN MODE, ASPECT, BLUE BACK, and BACKLIGHT.
- You can reset all the OSD settings in this option.

- Press 選單 key on the control panel or the remote control to view OSD menu.

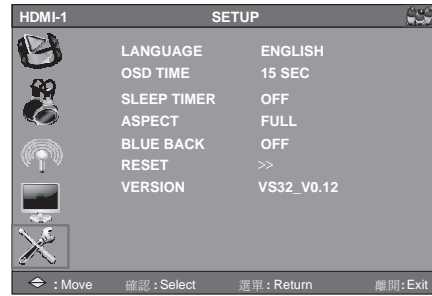

- Press ▲▼ key to select [SETUP] mode.
Press ◀▶ or +/- key to enter sub-menu.

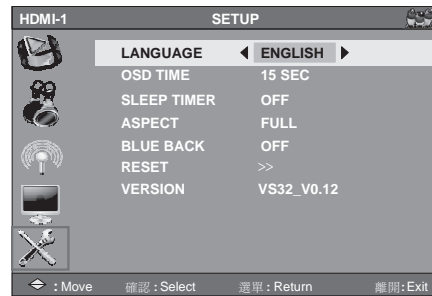

- Press ▲▼ key to select (LANGUAGE).
Press ◀▶ key to select ENGLISH or 或繁體中文.



- Press ▲▼ key to select (RESET).
Press ▶ key to Restore to the factory original setting.

Using a USB Source

Insert a USB key containing valid file formats into the slot on the display and press 訊號源 key on the control panel or 音樂 key on the remote control to select (USB) source.

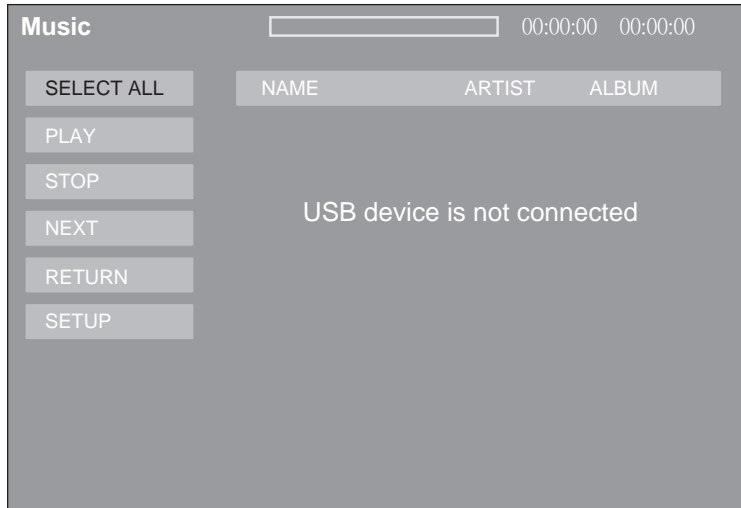

Supported File Formats

PHOTO	JPEG	File types: *.JPG Compatible File Format: JPEG Baseline (4:2:2/4:2:0) Maximum Resolution: 7680*4320 (1920x4*1080x4) pixels
	BMP	Not supported
	GIF	Not supported
AUDIO	MPEG 1 Layer 3	File Type: *.mp3 PC Support Timing (kHz): 32, 44.1,48 Supported Bit rate (Kbits/sec): 32, 40, 48, 56, 64, 80, 96, 112, 128, 160,192, 224, 256, 320
	MPEG 2 Layer 3	File Type: *.mp3 PC Support Timing (kHz): 22.05, 24 Support Bit rate (Kbits/sec): 16, 24, 32, 40, 48, 56, 64, 80, 96, 112,128,160
	Others	Not supported
Device	USB host 2.0 is compatible with USB 1.1 Not supported: USB Hub, USB 2.0 OTG (On The Go) and USB mass storage drivers	
File System	Support FAT32 USB Flash memory sticks Maximum supported memory size: 32GB Maximum supported number of songs on a memory card: 3000	

Press 音樂 key or 數位相框 key on the control to select the desired media type:

- Press 音樂 key to play music
- Press 數位相框 key to view photos

Program Guide

Press 節目指南 key on the remote control and wait for few seconds, the LCD Display will show the program guide subpage.

There are six parts in the Program Guide:

1. Date and time: Shows the current date and time by day/month/year (DD/MM/YYYY).
2. Time range: EPG shows the program list within a 2-hour range. Current program will be shown in the first block.
3. Channel menu: Shows all channel names.
4. Program List: Descends the manifestation program name in time zone according to the program length.
5. Program time and name: Displays the program time and full name.
6. Program account: Presents more detail information if any.

The following keys are relevant to the operation:

▲▼◀▶ keys: browses the channels

確認/PLAY key: selects and change the channels

選擇▲▼ key: page up or down

Other Information

Troubleshooting

No power

- Make sure the Display and the power cord are connected correctly.
- Check if you pressed POWER on the remote control unit. If the indicator in the front panel is red, press POWER in the remote control or the front control panel.

No picture

- Connect to local CATV system equipment, and make sure the signal is unlocked.
- Make sure the Display and the Audio/Video signal input devices are connected correctly.
- In PC (VGA) mode, the screen turns off automatically 2 minutes after no signal input detected. In the other modes, the screen turns off automatically 15 minutes after no signal input detected.

Strange color, light color, or color misalignment

- Is the room too bright? The picture may look dark in a room that is too bright.
- Check the input signal setting.

No sound

- Make sure the Mute function is not operated.
- When signal passed by the HDMI distribution amplifier, that may result in this situation.

Remote control unit does not operate

- Check if the batteries are inserted with the polarity(+,-)correctly aligned.
- Check if the batteries are discharged. Please replace with new batteries.
- Make sure that you do not use the remote control under strong or fluorescent lighting.
- Check if there is a fluorescent light illuminated near the remote control sensor.
- The path of the remote control beam may be blocked; please make sure the path is clear and that remote control is aimed at the remote control sensor in the Display.

Power is cut off suddenly

- Check if the off timer or sleep timer are set.
- The unit's internal temperature has increased. Remove any objects blocking the vents and clean them to remove dust.

Picture is cut off /with side bar screen

- Check if the image position is correct.
- Check if the screen mode adjustments such as picture size are made correctly.

LCD Display does not operate

External influences such as lightning or static electricity may cause improper operation. In this case, operate the unit after first turning on the power, or plugging the AC cord and plugging it in again after 1 to 2 minutes.

Customer Support

For technical support or product service, see the table below or contact your reseller.



You will need the product serial number.

Country/ Region	Website	T=Telephone F= Fax	E-mail
Taiwan	www.viewsonic.com.tw	T=886 2 2246 3456 F=886 2 2249 1751 Toll Free=0800 061 198	service@tw.viewsonic.com
Hong Kong	www.hk.viewsonic.com/support/	T= 852 3102 2900	service@hk.viewsonic.com

Limited Warranty

VIEWSONIC® LCD Display

ENGLISH

What the warranty covers:

ViewSonic warrants its products to be free from defects in material and workmanship, under normal use, during the warranty period. If a product proves to be defective in material or workmanship during the warranty period, ViewSonic will, at its sole option, repair or replace the product with a like product. Replacement product or parts may include remanufactured or refurbished parts or components.

How long the warranty is effective:

ViewSonic LCD Displays are warranted for 1 year for all parts excluding the light source and 1 year for labor from the date of the first customer purchase.

Who the warranty protects:

This warranty is valid only for the first consumer purchaser.

What the warranty does not cover:

1. Any product on which the serial number has been defaced, modified or removed.
2. Damage, deterioration or malfunction resulting from:
 - a. Accident, misuse, neglect, fire, water, lightning, or other acts of nature, unauthorized product modification, or failure to follow instructions supplied with the product.
 - b. Repair or attempted repair by anyone not authorized by ViewSonic.
 - c. Any damage of the product due to shipment.
 - d. Removal or installation of the product.
 - e. Causes external to the product, such as electric power fluctuations or failure.
 - f. Use of supplies or parts not meeting ViewSonic's specifications.
 - g. Normal wear and tear.
 - h. Any other cause which does not relate to a product defect.
3. Any product exhibiting a condition commonly known as "image burn-in" which results when a static image is displayed on the product for an extended period of time.
4. Removal, installation, and set-up service charges.
5. When you mount it on the wall, the following must be noticed:
 - a. The accessories attached with this product are applicable for this product only.
 - b. When the product is mounted on the wall, holes and fixed screws will remain in the wall body.
 - c. Wall face may discolor when this product has been mounted on the wall for a long time.

How to get service:

1. For information about receiving service under warranty, contact ViewSonic Customer Support (please refer to Customer Support page). You will need to provide your product's serial number.
2. To obtain warranted service, you will be required to provide (a) the original dated sales slip, (b) your name, (c) your address, (d) a description of the problem, and (e) the serial number of the product.
3. Take or ship the product freight prepaid in the original container to an authorized ViewSonic service center or ViewSonic.
4. For additional information or the name of the nearest ViewSonic service center, contact ViewSonic.

Limitation of implied warranties:

There are no warranties, express or implied, which extend beyond the description contained herein including the implied warranty of merchantability and fitness for a particular purpose.

Exclusion of damages:

ViewSonic's liability is limited to the cost of repair or replacement of the product. ViewSonic shall not be liable for:

1. Damage to other property caused by any defects in the product, damages based upon inconvenience, loss of use of the product, loss of time, loss of profits, loss of business opportunity, loss of goodwill, interference with business relationships, or other commercial loss, even if advised of the possibility of such damages.
2. Any other damages, whether incidental, consequential or otherwise.
3. Any claim against the customer by any other party.

Effect of state law:

This warranty gives you specific legal rights, and you may also have other rights which vary from state to state. Some states do not allow limitations on implied warranties and/or do not allow the exclusion of incidental or consequential damages, so the above limitations and exclusions may not apply to you.

Sales outside the U.S.A. and Canada:

For warranty information and service on ViewSonic products sold outside of the U.S.A. and Canada, contact ViewSonic or your local ViewSonic dealer.

The warranty period for this product in mainland China (Hong Kong, Macao and Taiwan Excluded) is subject to the terms and conditions of the Maintenance Guarantee Card.

For users in Europe and Russia, full details of warranty provided can be found in www.viewsoniceurope.com under Support/Warranty Information.

4.3: ViewSonic LCD Display Warranty

LTV_LW01 Rev. 1C 06-25-07



ViewSonic®

Free Manuals Download Website

<http://myh66.com>

<http://usermanuals.us>

<http://www.somanuals.com>

<http://www.4manuals.cc>

<http://www.manual-lib.com>

<http://www.404manual.com>

<http://www.luxmanual.com>

<http://aubethermostatmanual.com>

Golf course search by state

<http://golfingnear.com>

Email search by domain

<http://emailbydomain.com>

Auto manuals search

<http://auto.somanuals.com>

TV manuals search

<http://tv.somanuals.com>