

ViewSonic®



CDE6500-L/CDE4200-L/CDE3200-L Full HD Professional LED Display User Guide

IMPORTANT: Please read this User Guide to obtain important information on installing and using your product in a safe manner, as well as registering your product for future service. Warranty information contained in this User Guide will describe your limited coverage from ViewSonic Corporation, which is also found on our web site at <http://www.viewsonic.com> in English, or in specific languages using the Regional selection box in the upper right corner of our website. "Antes de operar su equipo lea cuidadosamente las instrucciones en este manual"

Model No. VS15817/VS15405/VS15629

Contents

Compliance Information

FCC Compliance Statement.....	i
Industry Canada Statement.....	i
CE Conformity for European Countries.....	ii
Declaration of RoHS2 Compliance.....	iii

Copyright Information

Product Registration.....	iv
For Your Records.....	iv
Important Safety Instructions.....	v

Getting Started

Package Contents.....	1
Installing the Display.....	2
Installing the Stand (For 65").....	2
Disconnecting the Stand (For 65").....	2
Installing the Stand (For 42").....	3
Installing the Stand (For 32").....	3
Disconnecting the Stand (For 42"/32").....	3
Mounting ViewSonic display to the wall.....	4
Wall Mount Kit Specifications (VESA).....	5
FRONT View & SIDE View of the Product.....	6
Rear View of the Product.....	7
Connecting the Display.....	8
HD Cable Box/HD Satellite Box.....	8
Personal Computer.....	10

Using the Display Features

Remote Control and Display Controls.....	12
Inserting Remote Control Batteries.....	12
Remote Control and Display Controls.....	12
Operation.....	14

Other Information

Troubleshooting.....	24
Specifications	26
RS232 Protocol	28
1. Introduction.....	28
2. Description	28
3. Protocol	29
Customer Support	36
Limited Warranty	37
Mexico Limited Warranty.....	39

Compliance Information

NOTE: This section addresses all connected requirements and statements regarding regulations. Confirmed corresponding applications shall refer to nameplate labels and relevant markings on unit.

FCC Compliance Statement

This device complies with part 15 of FCC Rules. Operation is subject to the following two conditions: (1) this device may not cause harmful interference, and (2) this device must accept any interference received, including interference that may cause undesired operation.

This equipment has been tested and found to comply with the limits for a Class B digital device, pursuant to part 15 of the FCC Rules. These limits are designed to provide reasonable protection against harmful interference in a residential installation. This equipment generates, uses, and can radiate radio frequency energy, and if not installed and used in accordance with the instructions, may cause harmful interference to radio communications. However, there is no guarantee that interference will not occur in a particular installation. If this equipment does cause harmful interference to radio or television reception, which can be determined by turning the equipment off and on, the user is encouraged to try to correct the interference by one or more of the following measures:

- Reorient or relocate the receiving antenna.
- Increase the separation between the equipment and receiver.
- Connect the equipment into an outlet on a circuit different from that to which the receiver is connected.
- Consult the dealer or an experienced radio/TV technician for help.

Warning: You are cautioned that changes or modifications not expressly approved by the party responsible for compliance could void your authority to operate the equipment.

Industry Canada Statement

CAN ICES-3 (B)/NMB-3(B)

CE Conformity for European Countries



The device complies with the EMC Directive 2004/108/EC and Low Voltage Directive 2006/95/EC.

Following information is only for EU-member states:

The mark shown to the right is in compliance with the Waste Electrical and Electronic Equipment Directive 2002/96/EC (WEEE). The mark indicates the requirement NOT to dispose the equipment as unsorted municipal waste, but use the return and collection systems according to local law.

If the batteries, accumulators and button cells included with this equipment, display the chemical symbol Hg, Cd, or Pb, then it means that the battery has a heavy metal content of more than 0.0005% Mercury or more than, 0.002% Cadmium, or more than 0.004% Lead.

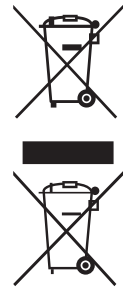

ENERGY STAR Information:

- ENERGY STAR is a set of power-saving guidelines issued by the U.S. Environmental Protection Agency (EPA).

ENERGY STAR is a joint program of the U.S. Environmental Protection Agency and the U.S. Department of Energy helping us all save money and protect the environment through energy efficient products and practices.

The power consumption will be changed, if the TV set up to be another mode except for default as-shipped television configuration and settings.

The power consumption may exceed energy consumption beyond the limits required for ENERGY STAR qualification when the optional function used or the operation mode changed in use.

Dolby Trademark Information:

-  **DOLBY**
DIGITAL Manufactured under license from Dolby Laboratories. Dolby and the double-D symbol are trademarks of Dolby Laboratories.

Declaration of RoHS2 Compliance

This product has been designed and manufactured in compliance with Directive 2011/65/EU of the European Parliament and the Council on restriction of the use of certain hazardous substances in electrical and electronic equipment (RoHS2 Directive) and is deemed to comply with the maximum concentration values issued by the European Technical Adaptation Committee (TAC) as shown below:

Substance	Proposed Maximum Concentration	Actual Concentration
Lead (Pb)	0.1%	< 0.1%
Mercury (Hg)	0.1%	< 0.1%
Cadmium (Cd)	0.01%	< 0.01%
Hexavalent Chromium (Cr ⁶⁺)	0.1%	< 0.1%
Polybrominated biphenyls (PBB)	0.1%	< 0.1%
Polybrominated diphenyl ethers (PBDE)	0.1%	< 0.1%

Certain components of products as stated above are exempted under the Annex III of the RoHS2 Directives as noted below:

Examples of exempted components are:

1. Mercury in cold cathode fluorescent lamps and external electrode fluorescent lamps (CCFL and EEFL) for special purposes not exceeding (per lamp):
 - (1) Short length (≤ 500 mm): maximum 3.5 mg per lamp.
 - (2) Medium length (> 500 mm and $\leq 1,500$ mm): maximum 5 mg per lamp.
 - (3) Long length ($> 1,500$ mm): maximum 13 mg per lamp.
2. Lead in glass of cathode ray tubes.
3. Lead in glass of fluorescent tubes not exceeding 0.2% by weight.
4. Lead as an alloying element in aluminium containing up to 0.4% lead by weight.
5. Copper alloy containing up to 4% lead by weight.
6. Lead in high melting temperature type solders (i.e. lead-based alloys containing 85% by weight or more lead).
7. Electrical and electronic components containing lead in a glass or ceramic other than dielectric ceramic in capacitors, e.g. piezoelectronic devices, or in a glass or ceramic matrix compound.

Copyright Information

Copyright © ViewSonic® Corporation, 2014. All rights reserved.

ViewSonic, the three birds logo, OnView, ViewMatch, and ViewMeter are registered trademarks of ViewSonic Corporation.

Disclaimer: ViewSonic Corporation shall not be liable for technical or editorial errors or omissions contained herein; nor for incidental or consequential damages resulting from furnishing this material, or the performance or use of this product.

In the interest of continuing product improvement, ViewSonic Corporation reserves the right to change product specifications without notice. Information in this document may change without notice.

No part of this document may be copied, reproduced, or transmitted by any means, for any purpose without prior written permission from ViewSonic Corporation.

Product Registration

To fulfill possible future product needs, and to receive additional product information as it becomes available, please visit your region section on ViewSonic's website to register your product online.

For Your Records

Product Name:	CDE6500-L/CDE4200-L/CDE3200-L
Brand/Product type:	ViewSonic/LCD Display
Model Number:	VS15817/VS15405/VS15629
Document Number:	CDE6500-L/CDE4200-L/CDE3200-L_UG_ENG Rev. 1E 03-06-14
Serial Number:	_____
Purchase Date:	_____

Product disposal at end of product life

ViewSonic respects the environment and is committed to working and living green. Thank you for being part of Smarter, Greener Computing.

Please visit ViewSonic website to learn more.

USA & Canada: <http://www.viewsonic.com/company/green/recycle-program/>

Europe: <http://www.viewsoniceurope.com/uk/support/recycling-information/>

Taiwan: <http://recycle.epa.gov.tw/recycle/index2.aspx>

Important Safety Instructions

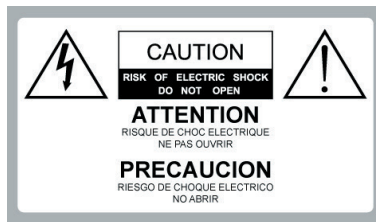

Dangerous Voltage: The lightning flash with arrowhead symbol, within an equilateral triangle, is intended to alert the user to the presence of dangerous voltage within the inside of the product that may be sufficient level to constitute a risk of electric shock to persons.



Instruction: The exclamation point within an equilateral triangle is intended to alert the user to the presence of important operating and servicing instructions in the literature accompanying the appliance.

1. Read these instructions completely before using the equipment.
2. Keep these instructions in a safe place.
3. Heed all warnings.
4. Follow all instructions.
5. Do not use this apparatus near water.
6. Clean with a soft, dry cloth.
7. Do not block any ventilation openings. Install the equipment in accordance with the manufacturer's instructions.
8. Do not install near any heat sources such as radiators, heat registers, stoves, or other devices (including amplifiers) that produce heat.
9. Do not attempt to circumvent the safety provisions of the polarized or grounding-type plug. A polarized plug has two blades with one wider than the other. A grounding type plug has two blades and a third grounding prong. The wide blade and the third prong are provided for your safety. If the provided plug does not fit into your outlet, consult an electrician for replacement of the outlet.
10. Prevent the power cord from being tread upon or pinched, particularly at the plug, convenience receptacles, and the point where they exit from the device. Be sure that the power outlet is located near the equipment so that it is easily accessible.
11. Only use attachments/ accessories specified by the manufacturer.
12. Use only with the cart, stand, tripod, bracket, or table specified by the manufacturer, or sold with the apparatus. When a cart is used, use caution when moving the cart/ apparatus combination to avoid injury from tip-over.
13. Unplug this apparatus when it will be unused for a long period of time.
14. Refer all servicing to qualified service personnel. Servicing is required when the apparatus has been damaged in any way, such as power-supply cord or plug is damaged, liquid has been spilled or objects have fallen into the apparatus, the apparatus has been exposed to rain or moisture, or the unit does not operate normally, or has been dropped.

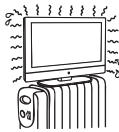

USE

AC power Cord

Keep the following guidelines to protect the AC power cord from being damaged. If the AC power cord is damaged, it may result in a fire or an electric shock. Stop using it and ask your dealer or ViewSonic service center to exchange it.

- Do not place the display where the power cord is subject to wear or abuse.
- Do not pinch, bend, or twist the cord excessively.
- The core lines may be bared and cut, causing a short-circuit, and resulting in a fire or an electric shock.
- Do not convert or damage the power cord.
- Avoid power cord being rolled over or rested upon.
- When the power cord is plugged in, do not move the display.
- Keep the power cord away from heat sources.
- When you disconnect the AC power cord, disconnect it from the wall outlet first.
- When disconnecting the power cord, grasp the plug instead of pulling the power cord.
- Use only an original ViewSonic AC power cord, not other brands. Do not use the supplied AC power cord on any other equipment.
- The plug of power cord is intended to serve as disconnection device. And the socket-outlet shall be installed close to the shredder for easy Access.



Wall outlet

Insert the plug fully into the outlet. If it is loose, do not use it. Doing so may cause arcing and result in a fire. Contact your electrician to change the outlet.

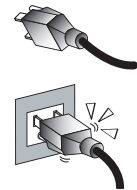

Wiring

For your safety, be sure to unplug the AC power cord when connecting cables. Take care not to trip on the cables. It may cause damage to the display set.

Electric shock

Do not touch the AC power cord or the display with a wet hand. If you plug/unplug the AC power cord from the display with a wet hand, it may cause electric shock.



Lightning storms

During a lightning storm, unplug the display from the wall outlet and disconnect the antenna to prevent damage to the display.

When not in use

If you will not be using the display set for long periods of time, the display set should be disconnected from the AC power outlet to prevent power line surges. The display set is not disconnected from the AC power source when the display set is switched off.

To disconnect the display set completely, unplug from the AC power outlet.

Overloading

This display set is designed to operate on a 120V AC supply only.

If there are too many appliances connected to the same AC power outlet, it could result in a fire or an electric shock.

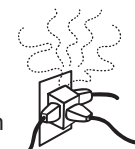

Optional equipment

If optional equipment is to be installed, leave some space between optional equipment and the display set. Picture distortion and/or noisy sound may occur if the display set is positioned in close proximity to any equipment emitting electromagnetic radiation.

Small accessories

Keep small accessories in a safe place where children are unable to reach.

Magnetic influence

This display contains a strong magnet in the speaker unit that generates a magnetic field. Keep any items susceptible to magnetic fields away from the speaker.

Sound

If you hear snapping or popping sound comes from the display continuously or frequently while the display is operating, unplug the display and consult your dealer or service technician. It is normal for some displays to make occasional snapping or popping sounds, particularly when being turned on or off.



Use in outdoor

This display is not designed for outdoors installation. Do not expose the display to rain, as it may result in a fire or an electric shock. Also, do not expose the display to direct sunlight, as it may heat up and become damaged.

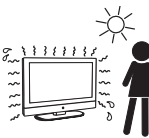

Vehicle, ships and other vessels

Do not install this display in a vehicle. Car accidents may cause the display to fall down and cause injury.



Do not install this display in a ship or vessel. If the display is exposed to seawater, it may cause a fire or damage the display.



Medical institutions

Do not place this display in a place where medical equipment is in use. It may cause the medical equipment to malfunction.

Volume adjustment

- Adjust the volume to avoid disturbing your neighbors. Sound carries easily at night. Therefore, we suggest you close the windows or use headphones.
- When using headphones, adjust the volume to appropriate levels, or hearing damage may result.

ANTENNAS

Outdoor antenna grounding

If an outdoor antenna is installed, follow the precautions below. Do not install the outdoor antenna system near of overhead power lines or other electric light or power circuits, or where it can come in contact with such power lines or circuits.

WHEN INSTALLING AN OUTDOOR ANTENNA SYSTEM, EXTREME CARE SHOULD BE TAKEN TO KEEP FROM CONTACTING SUCH POWER LINES OR CIRCUITS AS CONTACT WITH THEM IS ALMOST INVARIABLY FATAL.

Be sure the antenna system is grounded so that it can provide some protection against voltage surges and built-up static charges.

Section 810 of the National Electrical Code (NEC) in the U.S.A. and Section 54 of the Canadian Electrical Code in Canada provides information with in regard to proper grounding of the mast and supporting structure, grounding of the lead-in wire to an antenna discharge unit, size of grounding conductors, location of antenna discharge unit, connection to grounding electrodes, and requirements for the grounding electrode.

Antenna grounding according to the National Electrical Code, ANS/NFPA70-70

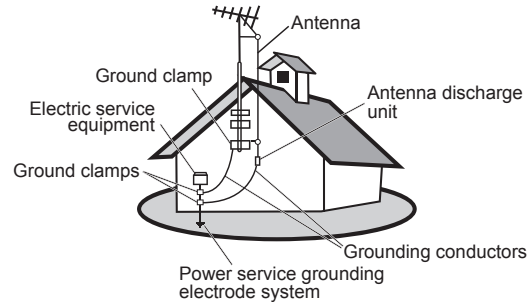

CLEANING

Cleaning the AC power plug

Unplug the AC power plug and clean it regularly. If the plug is covered with dust and gathers moisture, its insulation may deteriorate and result in a fire.

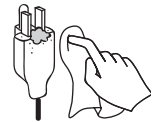

Cleaning the screen surface/ cabinet of the display set

When cleaning this display, unplug the AC power cord. If not, it may result in electric shock. Use a dry soft cloth to clean the cabinet of the display. To remove dust near the screen, wipe it gently with a soft cloth.



Stubborn stains may be removed with a cloth slightly dampened with a solution of mild soap and warm water. Never use strong solvents such as thinner or benzene for cleaning. If using a chemically pretreated cloth, please follow the instruction provided on the package. The ventilation holes can accumulate dust over time. To ensure proper ventilation, we recommend you to remove the dust periodically (once a month) using a vacuum cleaner, while the display is powered off.

Disclaimer

Some chemical cleaners have been reported to damage the screen and/or case of the display. ViewSonic will not be liable for damage resulting from use of these cleaners.

CARRYING THE DISPLAY

Carry the display as instructed

To prevent dropping the display and causing serious injury, you must follow these guidelines:

- Disconnect all cables before carrying the display.
- Carrying the large size display requires at least two or three people.
- When you carry the display, place your hands as illustrated and hold it securely. Do not put stress on the panel and the frame around the screen.
- When carrying the display, do not subject it to shocks, vibration, or excessive force.

- When lifting or moving the display, hold it securely from the bottom. Place your palm directly under the panel.

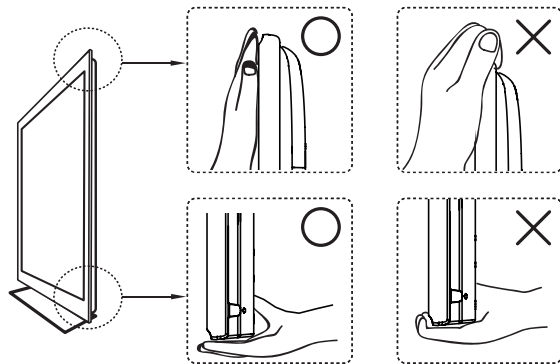

VENTILATION

Slots and openings in display are provided for ventilation. To ensure reliable operation of the display and to protect it from overheating, be sure these openings are not blocked or covered.

The display may accumulate dust and get dirty if proper ventilation is not provided. For proper ventilation, follow the following guidelines:

- Never install the display face up, down or sideways.
- Never install the display turned over or upside down.
- Never cover the slots and openings with a cloth or other materials.
- Never block the slots and openings by placing the display on a bed, sofa, rug or other similar surface.
- Never place the display in a confined space, such as a bookcase or built-in cabinet, unless proper ventilation is provided.



Leave some space around the display set as shown below. Otherwise, air-circulation may be inadequate and cause overheating, which may cause a fire or damage to the display set.

Installed on the wall

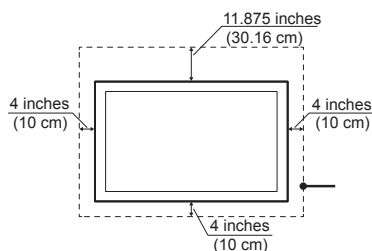

Installed with stand

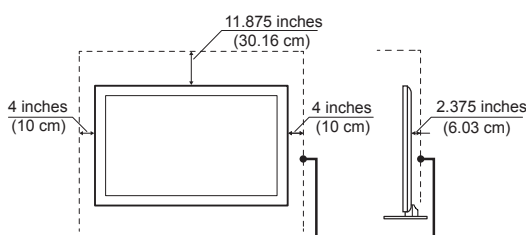

Leave at least this space around the set.

Do not install the display set as follows:

Air circulation is blocked. Air circulation is blocked.

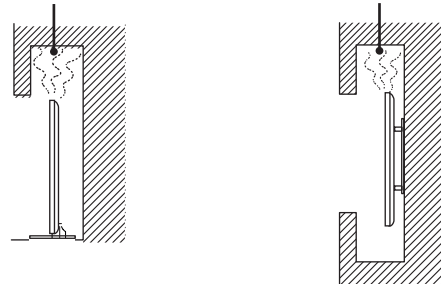

Objects and ventilation holes

Never push any objects into the slots on the display cabinet as they may touch dangerous voltage points or short out parts that could result in a fire or an electric shock. Do not place any objects on the display.

MOISTURE

Moisture and flammable objects

- Keep the product away from moisture. Do not expose this appliance to rain or moisture. Do not place objects filled with liquids, such as vases, on the display.
- Do not use power-line operated display sets near water, such as in places like a bathtub, washbowl, kitchen sink, laundry tub, a wet basement, or near a swimming pool, etc. It may cause fire or electric shock.
- Do not let this display get wet. Never spill liquid of any kind on the display. If water penetrates into the product, unplug the power cord and contact ViewSonic.
- Do not operate the display when wet. It may result in electric shock or damage to the display.
- To prevent fire, keep flammable objects or open flame (e.g. candles) away from the display.

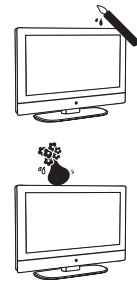

INSTALLATION

Optional wall mount

To do Wall mount installation, you need a Wall-Mount Bracket. When installing or removing the display using the Wall-Mount Bracket, be sure to use qualified contractors. If not properly secured during installation or removal from the Wall-Mount Bracket, the display may fall and cause serious injury.

- When installing the display using a Wall-Mount Bracket, make sure you follow the operating instructions supplied with the Wall-Mount Bracket.
- Attach the brackets supplied with the Wall-Mount Bracket.
- The display is not designed for hanging from the ceiling. It may fall and cause serious injury.

Placement

The display should be installed near an easily accessible AC power outlet.

Observe the following to prevent the display from falling from the stand or wall mount.

- Place the display on a stable, level surface.
- Do not hang anything on the display. Do not allow children to climb on the display. Do not install the display in places subject to extreme temperature, such as in direct sunlight, near a radiator, or heating vent. If the display is exposed to extreme temperature, the display may overheat and cause deformation of the enclosure or cause malfunction.



- Do not install the display in a place exposed to direct air conditioning.
- If the display is installed in such a location, moisture may condense inside and may cause a malfunction.
- Do not place the display in hot, oily, humid or excessively dusty places.
- Do not install the display where insects may enter.
- Do not install the display where it may be exposed to mechanical vibration.
- Do not install the display in a location where it may spear up, such as on or behind a pillar, or where you might bump your head on it. It may cause injury.



Preventing the display from toppling over

To prevent the display from toppling over, secure the display to a wall or stand.

Placement for watching

We suggest you to watch the display at a distance of 3-7 times that of the screen height, and not in excessive brightness. It is easy to cause eye fatigue if you watch display for too long or in a dark room. To obtain clear picture, do not expose the screen to direct illumination or sunlight. Use spot lighting directed down from the ceiling if you can.

SCREEN

- Although the screen is made with high precision technology and has effective pixels of 99.99% or more, black dots or bright points or light (red, blue, or green) may appear constantly on the screen. This is a structural property of the panel and is not a malfunction.
- The screen is made with high-precision technology. To achieve a high level of performance and picture quality, this display's backlight setting is set to maximize the brightness of the display. However, uneven brightness may be observed when the display is viewed in a dark environment without an input source or a blank screen. This is a normal condition, not a malfunction of the display. To improve this condition, change the Picture mode, Backlight setting, enable the Light Sensor, or turn on the Power management.
- Avoid exposing the screen surface to direct sunlight. It is likely to damage the panel.
- Do not push or scratch the screen, or place objects on top of the display. The image may be uneven or the panel may be damaged.
- If the display is used in a cold place, a smear may occur in the picture or the picture may become dark. It is not caused by a failure. This condition will improve as the temperature rises.
- When still pictures are displayed continuously, ghosting may occur. It should disappear after a short period of time.
- The screen and cabinet get warm when the display is in use. This is a normal condition.
- Spraying insect repellent with volatile material on the screen will cause damage.
- Do not make prolonged contact with rubber or plastic material.

Broken pieces

Do not throw anything at the display. Doing so may break the screen glass and cause serious injury.

If the surface of the display cracks, unplug the AC power cord before touching the display. Otherwise electric shock may result.



Handling of broken glass and liquid crystal leakage

If the panel gets damaged, crystalline liquid leakage may occur, or scattered broken glass may result. Do not touch broken glass or crystalline liquid which is toxic, with bare hands as cuts, poisoning or skin irritation may occur. Also do not glass fragments or leaked crystalline liquid get into your eyes or mouth. Should either contacted your eyes or mouth, rinse the contacted area thoroughly with water and consult your doctor.

SERVICING

Do not attempt to repair the display yourself, since opening the cabinet may expose you to dangerous voltage or other hazards. Ask qualified service personnel to do the servicing for your display.



Replacement parts

When replacement parts are required, be sure the service technician certifies in writing that he/she has used replacement parts specified by the manufacturer that have the same characteristics as the original parts. Unauthorized substitutions may cause a fire, an electric shock or other hazards.

Safety check

Upon completion of repairs to the display, ask the service technician to perform routine safety checks (as specified by the manufacturer) to determine that the display is safe for operating, and to so certify.

Ask a qualified service technician to dispose of the display.

Getting Started

Package Contents

Please make sure the following items are included with your display. If any items are missing, please contact your dealer.

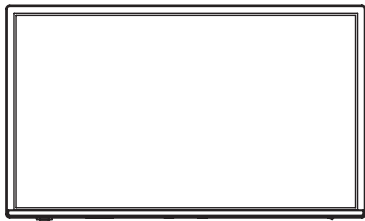

display (For 42")

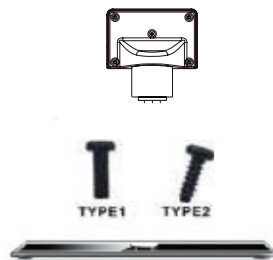

Screw type1 x 5 pcs/
Screw type2 x 5 pcs/
Bottom stand/Stand neck (For 42")



Remote Control with batteries

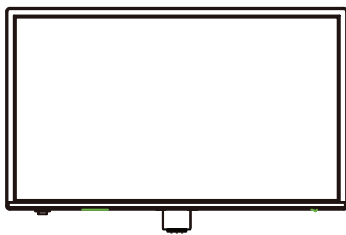

display (For 32")



Screw x 5 pcs/Bottom stand
(For 32")

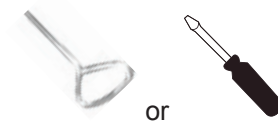

Screw driver x 1 piece



display (For 65")

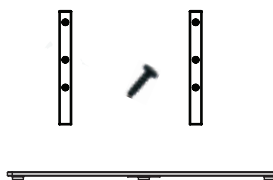

Screw x 10 pcs/
Stand neck x 2 pcs/
Bottom stand (For 65")

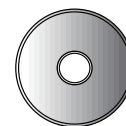

Viewsonic CD
(User Guide)



Power Cord
(Only for EU+UK model)



Power Cord
(Only for US model)

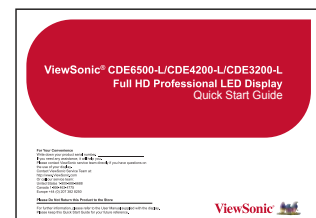

ViewSonic Quick Start Guide



The photos of the accessories are for reference only, the color of the remote control, the type of power cord are variable based on the actual models.

Installing the Display

Installing the Stand (For 65")

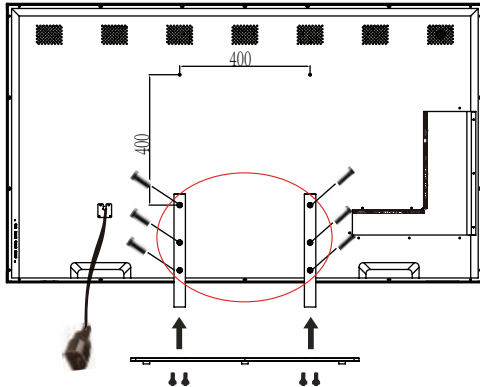

Place the display face down on a protective surface. Afterwards attach the neck piece onto the display and screw in the 4 screws to secure the neck. then insert the neck onto the bottom stand and secure the parts by inserting the screws and tightening them with the screwdriver provided.

Note: Attaching the stand requires two people.

Disconnecting the Stand (For 65")

To remove the stand, remove the screws in the circled area and the neck will come off.

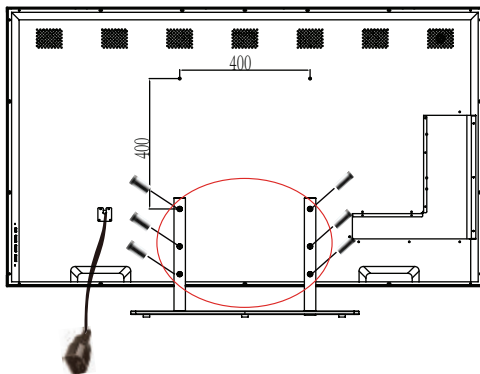

Installing the Stand (For 42")

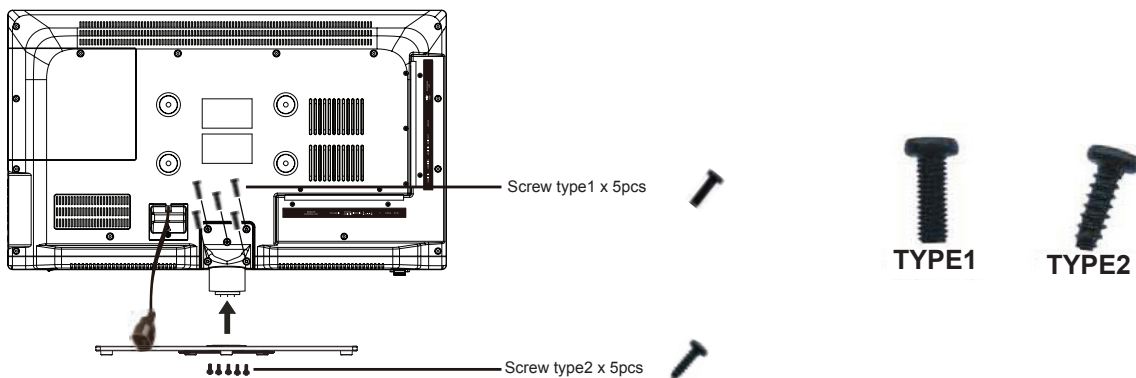

Place the display face down on a protective surface. Afterwards attach the neck piece onto the display and screw in the 5 screws to secure the neck. then insert the neck onto the bottom stand and secure the parts by inserting the screws and tightening them with the screwdriver provided.

Note: Attaching the stand requires two people.

Installing the Stand (For 32")

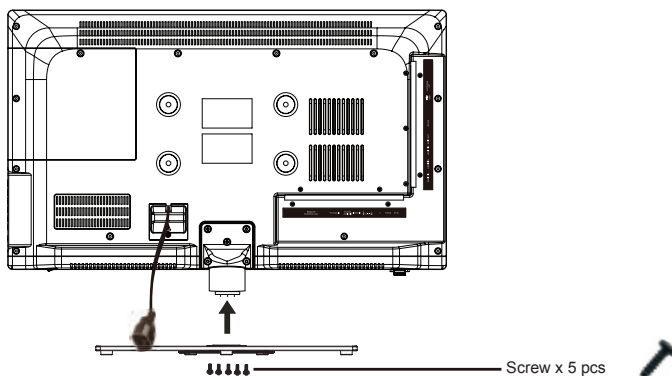

Place the display face down on a protective surface. Then insert the neck onto the bottom stand and secure the parts by inserting the screws and tightening them with the screwdriver provided.

Note: Attaching the stand requires two people.

Disconnecting the Stand (For 42"/32")

To remove the stand, remove the screws in the circled area and the neck will come off.

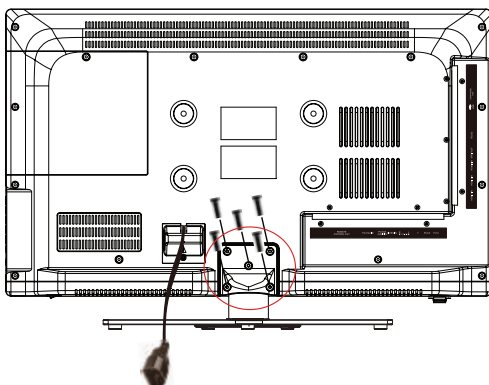

Mounting ViewSonic display to the wall

The display can be used in a free standing position or wall-mounted. Before installing the product to the wall, please consider the following guidelines:

- Read the Important Safety Instructions, at the start of this manual.
- Do not install in a moist or wet environment. This equipment is intended for indoor use.
- Do not install near heat source, or strong magnetic fields.
- Use only ViewSonic approved wall-mounting brackets to support the display weight.
- Before attaching the wall mount plate to the back cover, ensure the product is working.
- If your display is already set up for free-standing operation, you need to first remove the stand before mounting the device to the wall.

To attach the wall-mount bracket to display safely, please use the following guidelines:

- Disconnect the power and any other cables that might hinder moving the display.
- Set the display on a table or work surface, placing the screen face down on a towel or woolen blanket to protect the screen surface from damage while installing plate.
- Before installing the display on the wall, ensure you have recorded the product serial number on page (i) of the User Guide, as you will need the serial number to request service should there be a service need.
- Install the wall mount plate to the display using screws NO LONGER than 20mm, as longer screws found in universal (non-ViewSonic) wall mount kits may damage the power supply causing the unit to fail. The wall-mount screw type is M6 x L20.

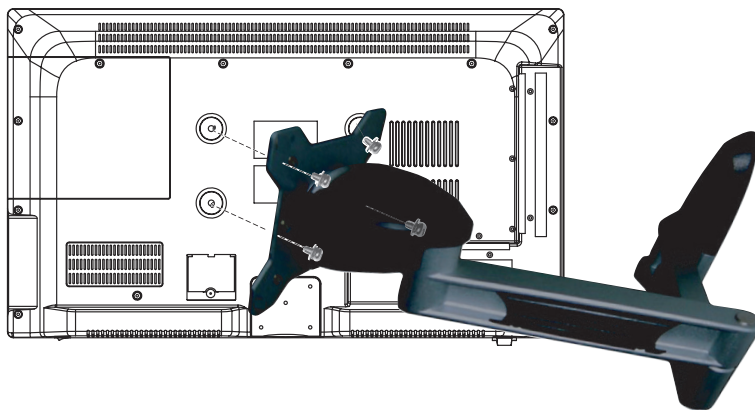

- Mount the wall mount bracket to the wall ensuring use of proper screws to support the installation. Ensure there is at least 3cm of space surrounding any air-vents of your display to allow adequate cooling during operation.
- Hang the display wall mount plate to the wall mount bracket, completing installation.

Enjoy your ViewSonic display!

Wall Mount Kit Specifications (VESA)

When attaching to other building materials, please contact your nearest dealer.

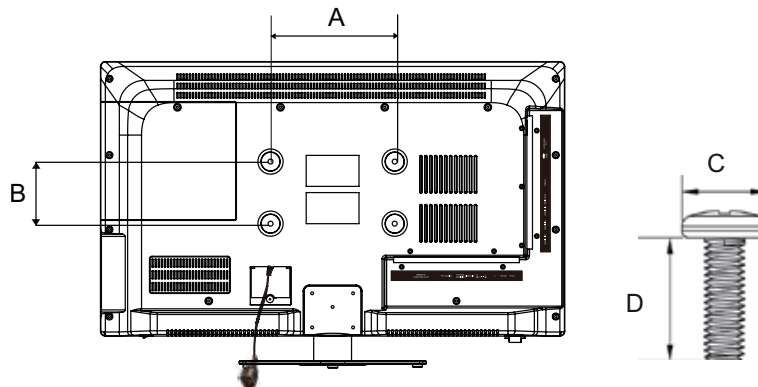

Product Family	inch	VESA Spec. (A x B)	Standard Screw (C x D)	Quantity
display	42	200 x 200 mm	M6 x L20	4
display	32	200 x 100 mm	M6 x L20	4

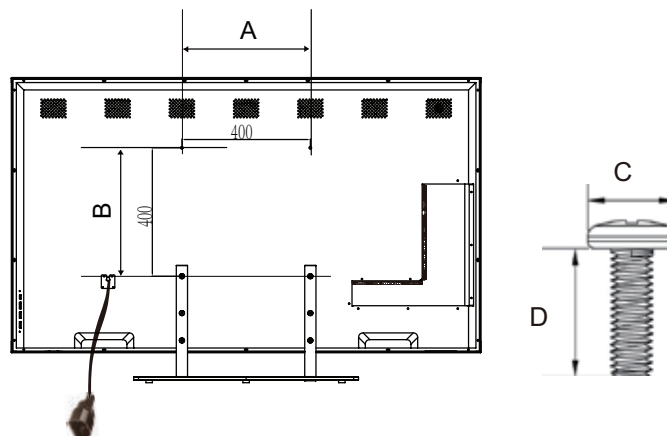

Product Family	inch	VESA Spec. (A x B)	Standard Screw (C x D)	Quantity
display	64.5	400 x 400 mm	M6 x L20	4

- ViewSonic provides the standard dimensions for wall mount kits as shown in the table above.
- To find the perfect mount, please browse www.viewsonic.com or call our service team: United States 1-800-688-6688, Canada 1-866-463-4775, Europe +44 (0) 207 382 8250.
- When purchasing our wall mount kit, a detailed install manual and all parts necessary for assembly are provided.
- Do not use the screws that longer than the standard dimension, as they may cause damage to the inside of the display set.

FRONT View & SIDE View of the Product

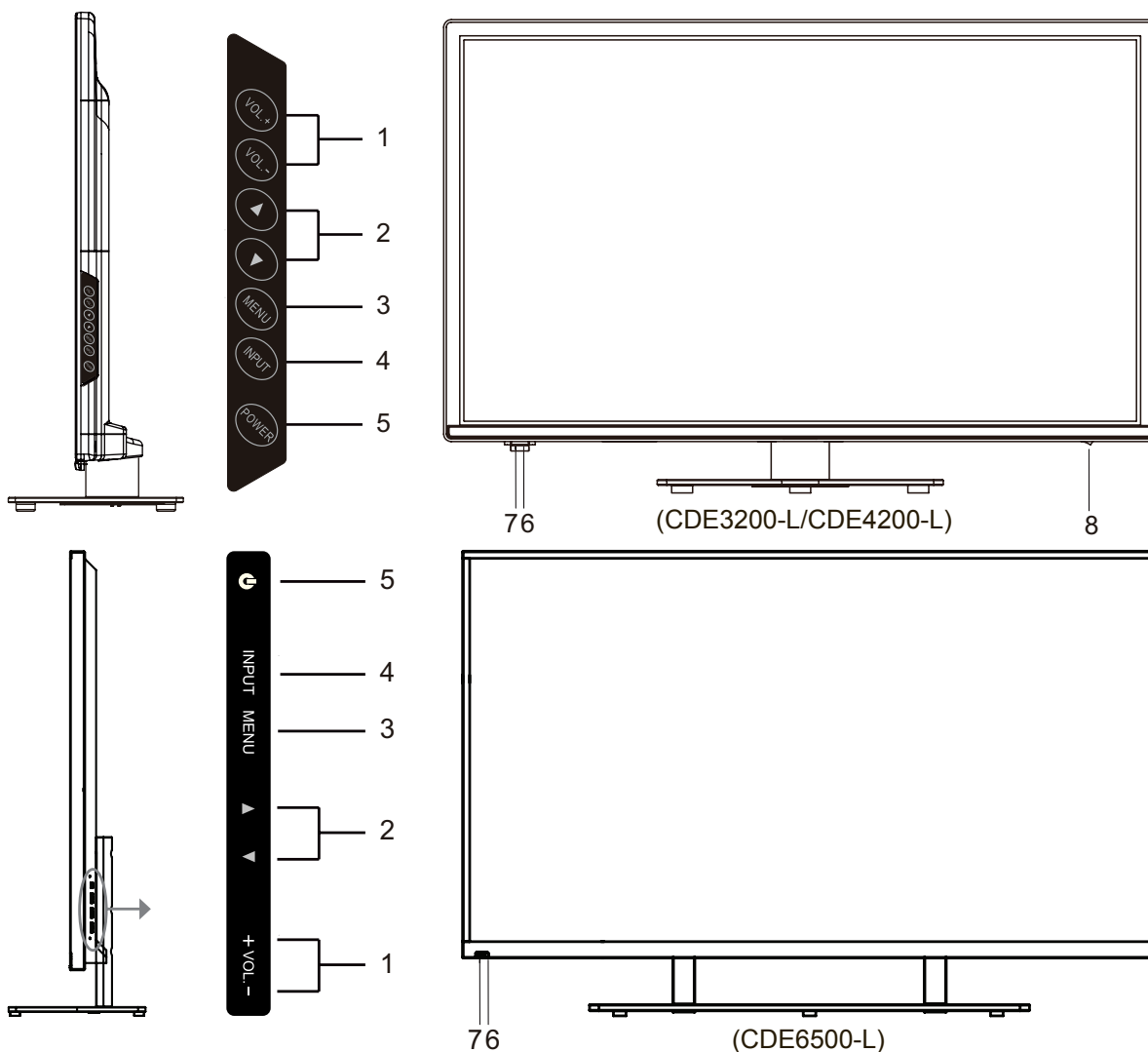

Item	Icon	Description
1 Volume	VOL +	Increase the volume. Move to the right or adjust the setting on the OSD menu.
	VOL -	Decrease the volume. Move to the left or adjust the setting on the OSD menu.
2 ▲ ▼	▲	Move upward to scroll through menu options.
	▼	Move downward to scroll through menu options.
3 Menu	MENU	Turn the on-screen display (OSD) menu on / off.
4 Input	INPUT	Select the input source. Enter the submenu.
5 Power	⏻	Turn the power on from standby mode. Touch it again to return to standby mode.
6 Remote Control Receiver		Receive IR signals from the remote control.
7 LED Indicator		Blue indicates power on. Red indicates standby mode.
8 Power Switch		To switch the display on and off.

Rear View of the Product

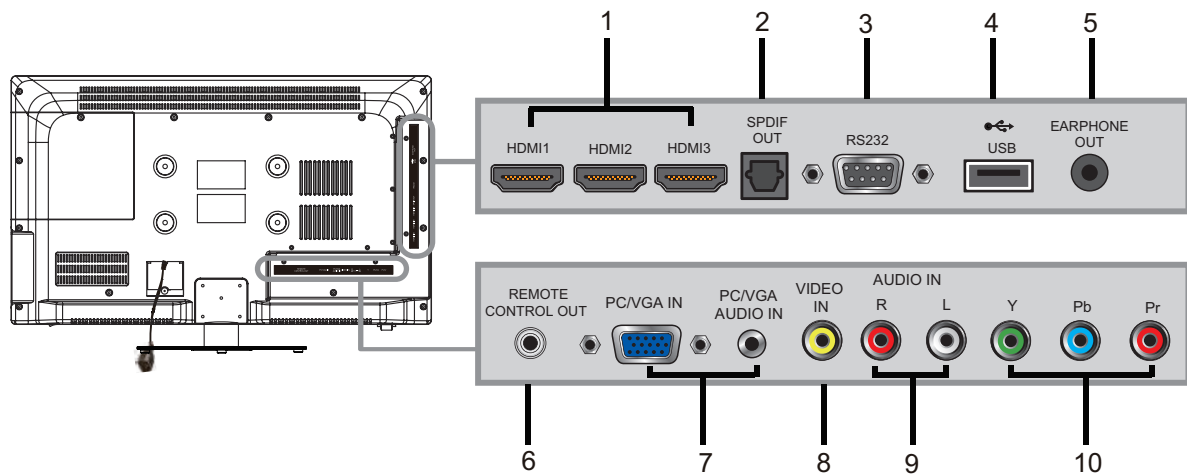

Item	Description
1 HDMI input	Connect to the HDMI output of A/V devices.
2 SPDIF Optical output	Connect to the SPDIF input of A/V device.
3 RS232 signal input	Reserved for the service technician's use.
4 USB	Connect to USB devices, such as USB flash drive.
5 Earphone Jack	Connect to earphones. By connecting the earphones, you can listen to the sound from the display through the earphones. If you connect the earphones, the display speakers will be muted.
6 Remote Control Out	Connect to an IR emitter. This will enable the remote control of external equipment.
7 PC/VGA in & PC Audio in	Connect to a PC VGA port or a PC line / audio port.
8 Video in	Connect to the video output of A/V device.
9 Audio input (left/ right)	Connect to the corresponding audio connectors on your A/V device.
10 YPbPr signal input	Connect to the YPbPr output of YPbPr device.

Connecting the Display

HD Cable Box/HD Satellite Box

You can also enjoy high-definition programming by subscribing to a high-definition cable service or a highdefinition satellite service. For the optimum picture quality, be sure to connect this device to your display via the HDMI or component video (with audio) input on the rear side of your display.

HDMI Connection

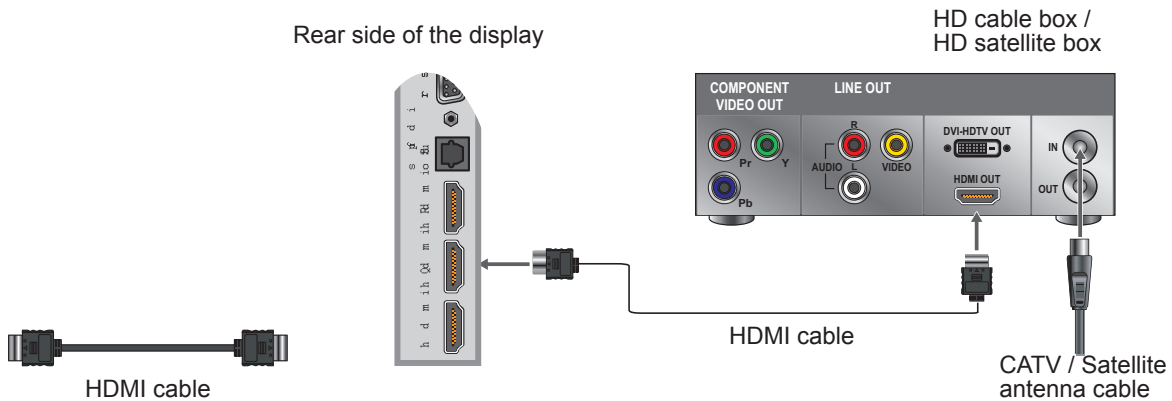

DVI Connection

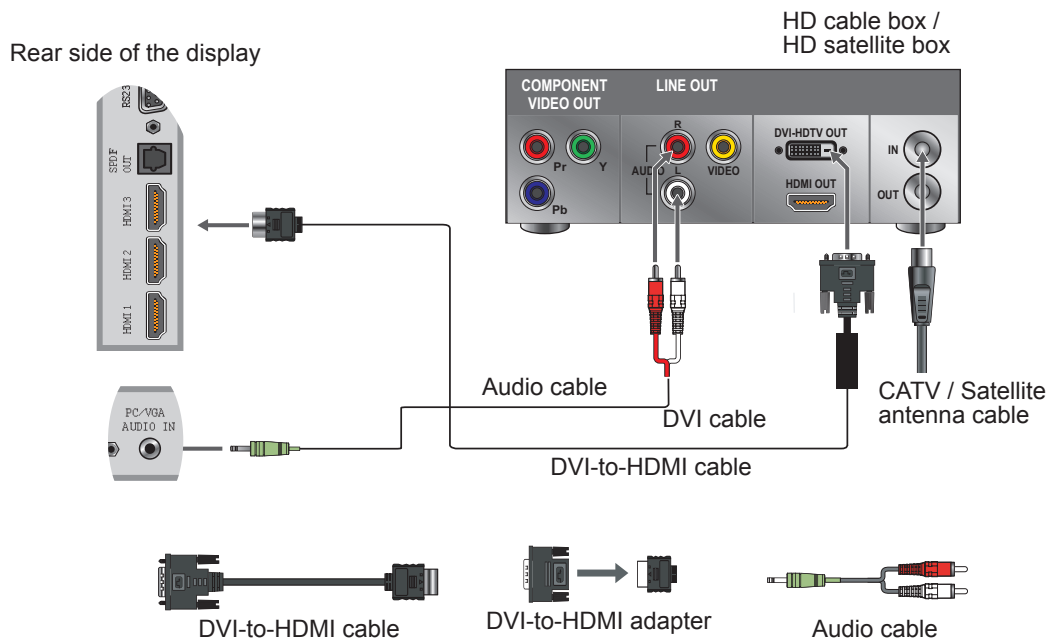

Note:

For DVI connection, connect the HDMI jack (with DVI-to-HDMI cable, or DVI-to-HDMI adapter), and connect the audio jack to the AUDIO IN jacks of PC Audio input.

HDMI Timing Reference Chart

No.	Mode	HDMI	DVI
1	VGA60 (640x480)	V	V
2	SVGA60 (800x600)	V	V
3	XGA60 (1024x768)	V	V
4	SXGA60 (1280x1024)	V	V
5	WXGA60 (1360x768)	NA	NA
6	1280 x 800	NA	NA
7	1440 x 900	NA	NA
8	1680 x 1050	NA	NA
9	1920 x 1080	V	V
10	480i60	V	V
11	576i50	V	V
12	480P60	V	V
13	576P50	V	V
14	720P50	V	V
15	720P60	V	V
16	1080I50	V	V
17	1080I60	V	V
18	1080P50	V	V
19	1080P60	V	V
20	1080P24	NA	NA
21	1080P30	NA	NA

YPbPr or Component Connection

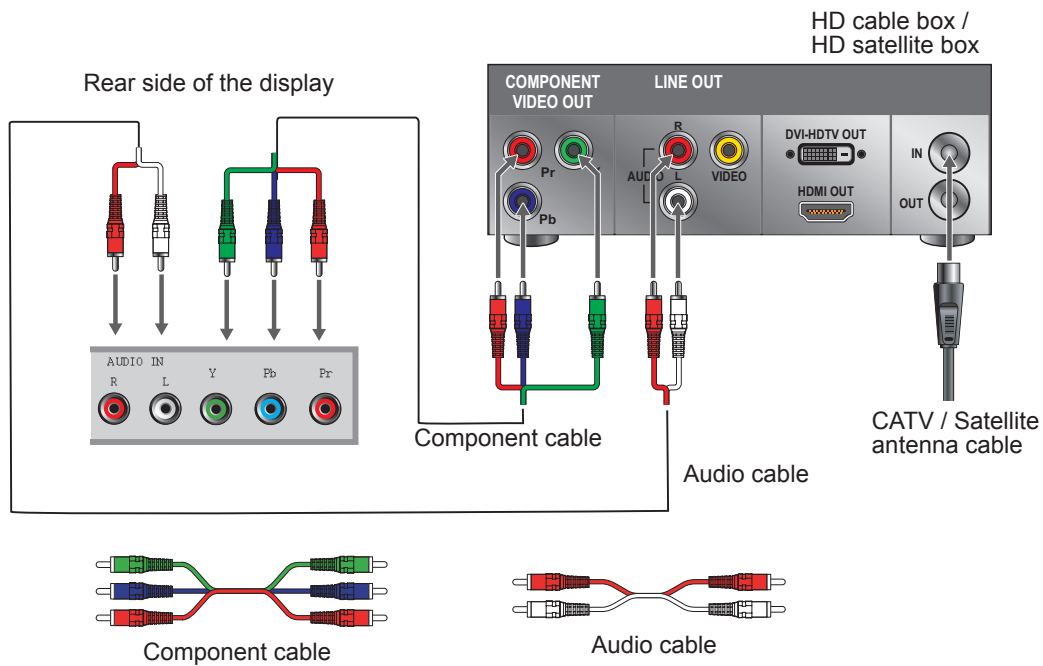

Note:

YPbPr provides better quality than the AV connection.

AV Connection

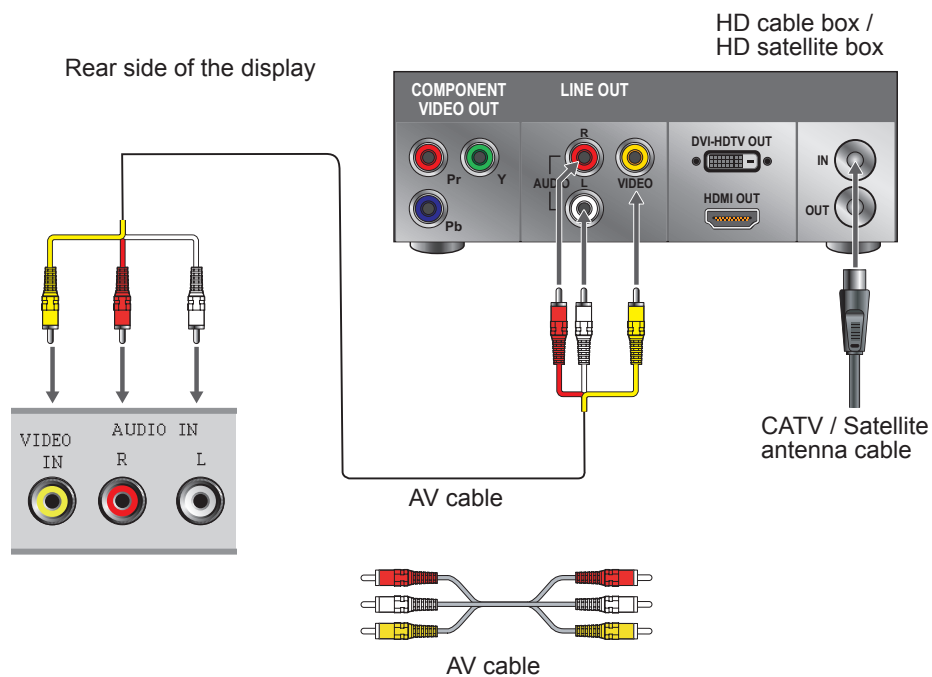

Programming your Cable or Satellite Box remote

Refer to the user manual from your service provider to determine the setting.

If it requires:

- 3 digits, please try “566”, “565”, “556”, or “688”. It usually works with DISHNetwork.
- 4 digits, please try “0054”. It usually works with Cox.
- 5-digits, please try “11454”, “11054”, or “10690”. It usually works with DIRECTV.

Personal Computer

Use the display as the monitor of your computer.

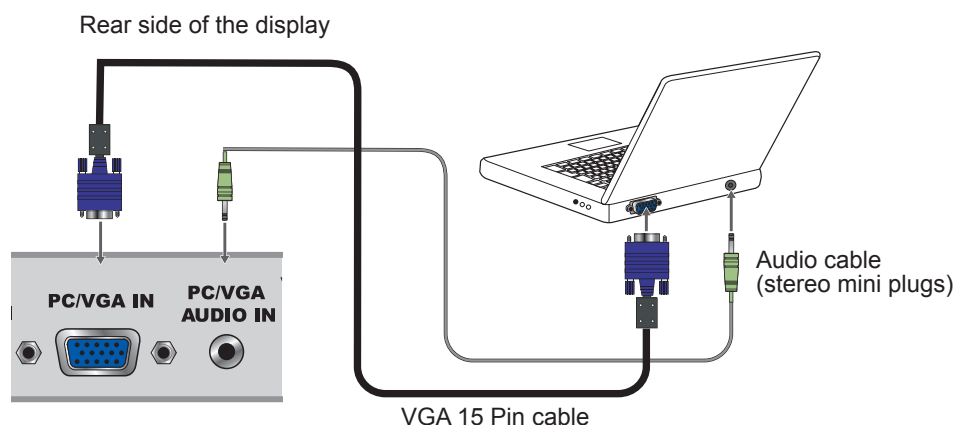

Note:

Connect the PC IN jack to the PC using a 15-pin cable and audio cable.

PC Timing Reference Chart

No.	VGA Timing		Panel FullHD (1920 x 1080) Support				
	Mode	Resolution	H sync (kHz)	V sync (Hz)	Pixel clock (MHz)	Polarity	Support
1	IBM VGA	720 x 400	31.47	70.09	28.32	N/P	V
2	VESA DMT	640 x 480	31.5	59.94	25.175	N/N	V
3	VESA DMT	800 x 600	37.88	60.32	40	P/P	V
4	VESA DMT	1024 x 768	48.36	60	65	N/N	V
5	VESA DMT	1280 x 768	47.77	59.8	79.5	N/P	V
6	VESA DMT	1280 x 800	49.7	59.81	83.5	N/P	NA
7	VESA DMT	1280 x 1024	63.98	60.02	108	P/P	V
8	VESA DMT	1360 x 768	47.71	60.01	85.5	P/P	NA
9	VESA DMT	1440 x 900	55.94	59.89	106.5	N/P	NA
10	VESA DMT	1680 x 1050	65.29	59.95	146.25	N/P	NA
11	CEA	1920 x 1080	67.5	60	148.5	P/P	V

Note:

This VGA input does not support interlaced signals.

Using the Display Features

Remote Control and Display Controls

Inserting Remote Control Batteries

1. Remove the battery cover by pulling then lifting the knob on the cover.
2. Insert the batteries, corresponding to the (+) and (-) markings on the battery compartment.
3. Reattach the battery cover.

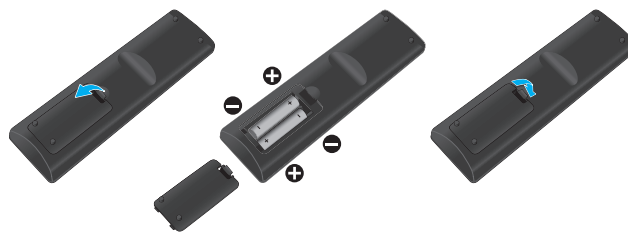

CAUTION

- Only use the specified AAA batteries.
- Do not mix new and old batteries. This may result in creaking or leakage, which may pose a risk of fire or lead to personal injury.
- Insert batteries according to (+) and (-) markings. Inserting the batteries incorrectly may result in leakage, which may pose a risk of fire or lead to personal injury.
- Dispose of the battery in accordance with local laws and regulations.
- Keep the batteries away from children or pets.
- When the remote control will not be used for an extended period, remove the batteries.

Remote Control and Display Controls

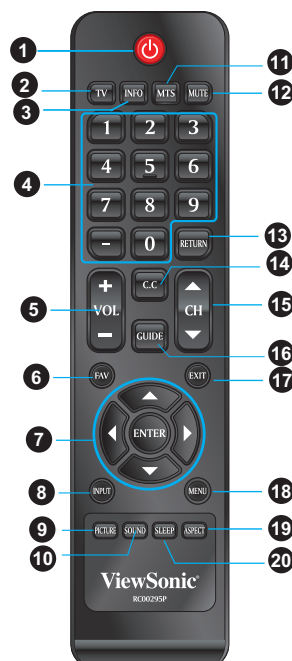

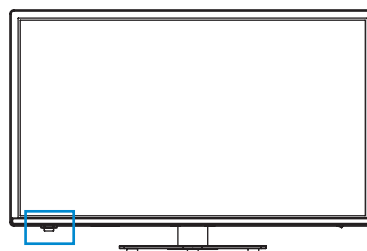

Touch keys located at the front side of the display operate the same as these buttons on the remote control.

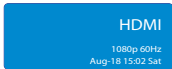
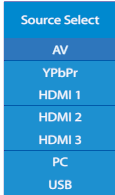

Button	Description
1 POWER	Press this button to turn the power on from standby mode. Press it again to return to standby mode.
2 TV	This function is not available for this model. (Only for TV)
3 INFO	Press to display the current state of the display. 
4 0~9, - number buttons	Press the respective button to input a character or number.
5 - VOL -	Press to adjust the volume.
6 FAV	This function is not available for this model. (Only for TV)
7 ▲▼◀▶ / ENTER buttons	Press these buttons to navigate the OSD menus. <ul style="list-style-type: none"> ▲ / ▼ - move upward/downward to select menu options. ◀ / ▶ - move to the right/left to select the main menu or adjust the settings. You can also use ▶ to enter the corresponding submenu. ENTER: Confirm the selection or enter the corresponding submenu.
8 INPUT	Press to display the Source Select list and select the source with ▲ / ▼. To confirm the selection, press ENTER . 
9 PICTURE	Press this button repeatedly to select the preset picture mode. Available options: Standard, Movie, User, Power Saving, or Dynamic.
10 SOUND	Press this button repeatedly to select the preset sound mode. Available options: Standard, Soft, User or Dynamic.
11 MTS	This function is not available for this model. (Only for TV)
12 MUTE	Press to turn off the sound. To restore the sound, press this button again, or press the VOL+/- button.
13 RETURN	Press to return to the previous channel.(Only for TV)
14 C.C	Press to select the Closed Caption menu in the AV mode.
15 ▼ CH ▲	This function is not available for this model. (Only for TV)
16 GUIDE	This function is not available for this model. (Only for TV)
17 EXIT	Press to exit the OSD menu screen.
18 MENU	Press to turn the OSD (On-Screen Display) menu on.
19 ASPECT	Press this button repeatedly to select the screen size. Available options: Normal, Wide, Cinema, Zoom, or Full 100%. <i>* For Full 100% option, it is only available on HDMI/DVI input source.</i>
20 SLEEP	Cycle through the display sleep timer.

Operation

Turning the Display On and Off

Press  on the remote control.
You can also use the  key on the front side of the panel.

* If there is no input signal within 10 minutes, the display will be turned off automatically.

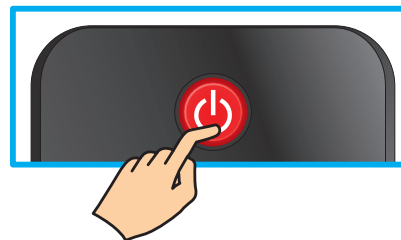

Adjusting the Volume

Press **VOL +/-** to adjust volume.
To turn off the volume, press **MUTE**.
To restore volume, press **MUTE** again, or press **VOL +/-** directly.



Viewing the Displayed Information

To display the current information of the display:
Press **INFO**, and the current state will be displayed on the screen. (It shows all or some of the information about Input, Resolution, etc., depending on the input source)

* The illustration shows an example of the INFO screen in an HDMI source.

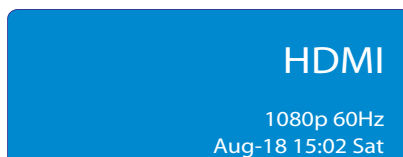
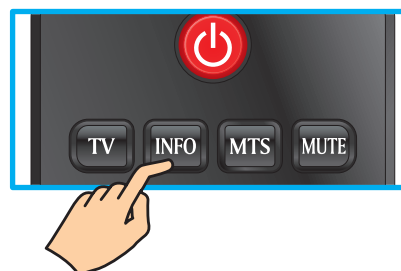

Selecting the Input Source

To select the input sources connected to the display:

1. Press **SOURCE** on the remote control.
2. Press **▲** or **▼** to select the desired input source.
3. To confirm the selection, press **ENTER**.

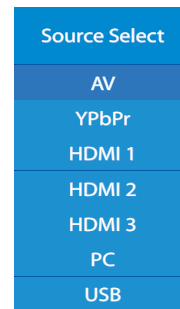

Using the Parent Controls

With PARENT CONTROL, you can block display and movie programming based on Movie ratings.

Password is required to access the PARENTAL CONTROL menu. The default is "0000".

Changing Password

To change a new password:

1. Press **MENU** to display the OSD main menu.
2. Press **◀** or **▶** to select **PARENTAL** menu, then press **ENTER** to enter the menu.
3. Enter the password.
4. Press **▲** or **▼** to select **Change Password**, then press **▶** to enter its submenu.
5. Enter the old password on **Old PIN**.
6. Enter your new password on **New PIN**.
7. Enter your new password again on **Confirm**.
The screen will return to the PARENTAL CONTROL menu. This indicates the password has been changed.
8. Press **EXIT** to exit the menu.

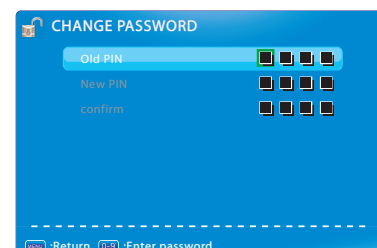
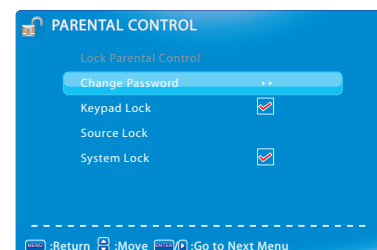
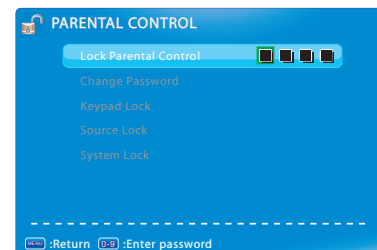

Blocking Selected Input Source

To block the selected input source:

1. Press **MENU** to display the OSD main menu.
2. Press ◀ or ▶ to select **PARENTAL** menu, then press **ENTER** to enter the menu.
3. Enter the password.
4. Press ▲ or ▼ to select **Source Lock**, then press **ENTER** to enter its submenu.
5. Press ▲ or ▼ to select the input source that you want to block.
6. Press **ENTER** to confirm.
A ✓ icon indicates the selected input source has been blocked.
7. Press **EXIT** to exit the menu.

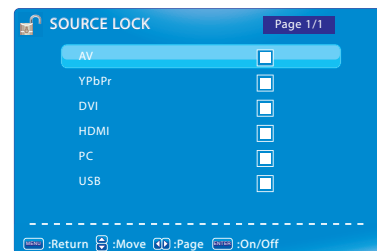
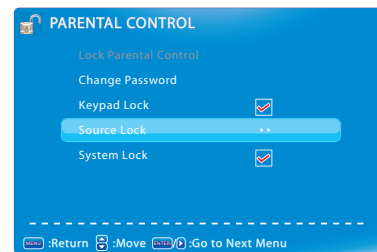

Resetting to Factory Default Settings

To reset all setting to the factory default settings:

1. Press **MENU** to display the OSD main menu.
2. Press ◀ or ▶ to select **OTHERS** menu, then press **ENTER** to enter the menu.
3. Press ▲ or ▼ to select **All Reset**, then press **ENTER** to reset to the default settings.

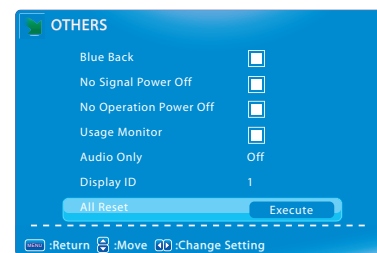

Display ID Setting

To set ID number to display for RS232 function:

1. Press **MENU** to display the OSD main menu.
2. Press ◀ or ▶ to select **OTHERS** menu, then press **ENTER** to enter the menu.
3. Press ▲ or ▼ to select **Display ID**.
4. Press ◀ or ▶ to set the ID number (1~98).
For details information, refer to the RS232 Protocol on page 26~33.
5. Press **EXIT** to exit the menu.

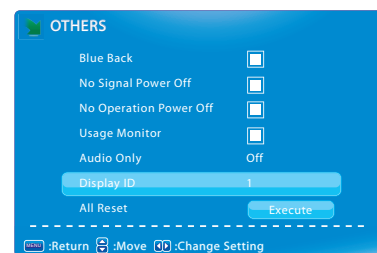

Customizing PC Display

Connect the PC and your display using the VGA cable. See “Personal Computer” on page 10.

1. Press **SOURCE** to display the **Source Select** menu.
2. Press **▲** or **▼** to select PC, then press **ENTER** to confirm the setting.
3. Press **MENU** to display the OSD main menu.
4. Press **◀** or **▶** to select **PICTURE** menu, then press **ENTER** to enter the menu.
5. Press **▲** or **▼** to select **PC Settings**, then press **ENTER** to enter its submenu.
6. Press **▲** or **▼** to select **Auto Adjust**, **Horizontal Position**, **Vertical Position**, **Clock**, or **Phase**, and press **◀** or **▶** to adjust the setting.
7. Press **EXIT** to exit the menu.

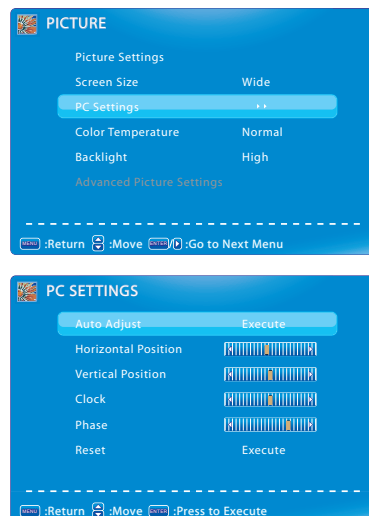

Using USB Function

Your display is equipped with a USB connector that enables you to view photos or listen to music stored on a USB storage device.

Note:

USB only supports JPEG and MP3 files.

Multimedia support format

Multimedia Categories	File Extension	Decoder	Notes
Music	*.mp3	MPEG1 Audio LAYERIII (Not corresponding MP3 Pro)	Sampling Frequency [KHz] : 32 / 44.1 / 48 Bit Rate [kbit/s]: 32 / 40 / 48 / 56 / 64 / 80 / 96 / 112 / 128 / 160 / 192 / 224 / 256 / 320 / VBR
Photo	*.jpg	Baseline	Horizontal Max: less than 5000 Vertical Max: less than 5000 Horizontal Min: greater than 8 Vertical Min: greater than 8

1. Plug a USB device to the USB connector on the rear side of the display.
2. Press **SOURCE** to display the **Source Select** menu.
3. Press **▲** or **▼** to select USB, then press **ENTER** to confirm the setting. The USB menu appears on the screen.

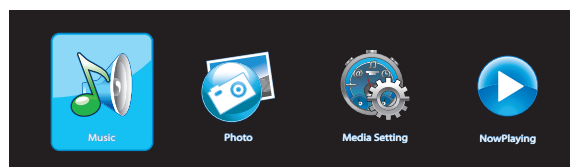

4. Press **◀** or **▶** to select the menu item, then press **ENTER**.
5. Press **EXIT** to return to the previous screen.

Playing Music

1. Press ◀ or ▶ to select **Music**, then press **ENTER**. If there are several folders, press ▲ or ▼ to select the desired folder, then press **ENTER** to view the subfolder content.
2. Press ▲ or ▼ to select a song, then press **ENTER** to play. An automatic playback begins from the selected song.
3. During the playback, do the following:
 - To pause the playback, press ◀ or ▶ to select **||** icon, then press **ENTER**. Press ◀ or ▶ to select ▶ icon, then press **ENTER** to resume.
 - To skip to previous song, press ◀ or ▶ to select ◀◀ icon, then press **ENTER**.
 - To skip to next song, press ◀ or ▶ to select ▶▶ icon, then press **ENTER**.
 - To stop the playback, press ◀ or ▶ to select ■ icon, then press **ENTER**.

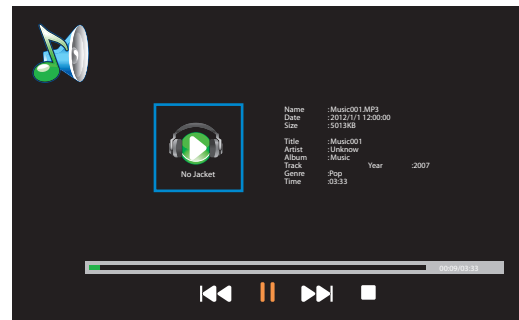
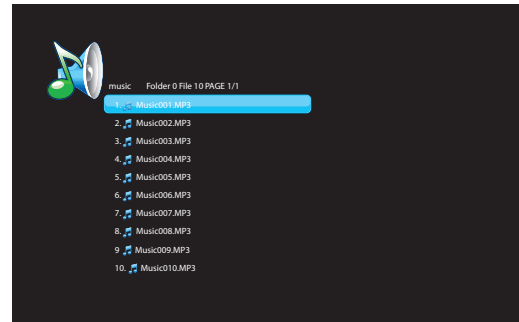

* You can directly view the playlist by selecting **NowPlaying**, then press **ENTER**.

Viewing Photos

1. Press ◀ or ▶ to select **Photo**, then press **ENTER**. If there are several folders, press ▲ or ▼ to select the desired folder, then press **ENTER** to view the subfolder content.
2. Press ▲ or ▼ to select a photo, then press **ENTER** to view the photo in full screen. Press **EXIT** to stop the slide show.

Customizing Slide Show Settings

1. Press ◀ or ▶ to select Media Setting, then press **ENTER**.
2. Press ▲ or ▼ to select the menu item, and press ◀ or ▶ to adjust the setting.

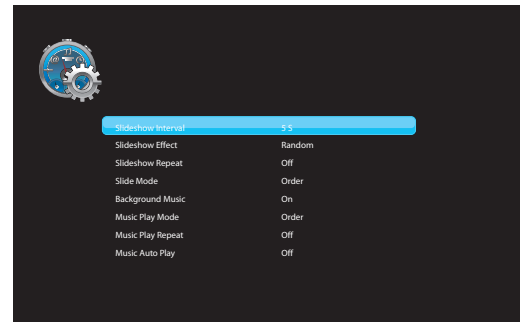

Menu item	Description
Slideshow Interval	Set the interval time between each slide displays (3 S / 5 S / 10 S / 30 S / 1 Min / 30 Min).
Slideshow Effect	Select the transition effect between each slide displays (Random / Off / Wipe Right / Wipe Left / Wipe Up / Wipe Down / Comb Side / Comb UpDown / Checker / Mosaic / Fade / Blind Right / Blind Left / Blind Up / Blind Down / Box In / Box Out / Slide in Right / Slide in Left / Slide in Up / Slide in Down).
Slideshow Repeat	Enable/Disable the slide show repetition (Off / On).
Slide Mode	Set the slide mode option (Order / Random).
Background Music	Enables/Disable background music during the slide show (On / Off).
Music Play Mode	Set music play mode option (Order / Random / Play One).
Music Play Repeat	Enable/Disable the music playback repetition (Off / On).
Music Auto Play	Enable/Disable the automatic music playback (Off / On).

Adjusting On-Screen Display (OSD) Settings

1. Press **MENU** to display the OSD main menu.

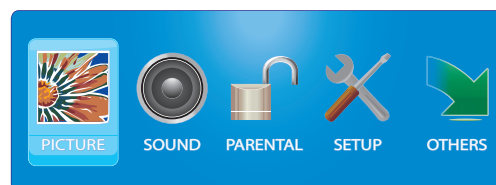

2. Press ◀ or ▶ to select the main menu, then press **ENTER** to enter the selected menu.
3. Press ▲ or ▼ to select the menu item, then press ◀ or ▶ to adjust or select the setting. When selecting a menu item with a submenu (▶▶), press ▶ or **ENTER** to enter its submenu. (▶▶ will only appear when the menu item is highlighted)
4. Press **MENU** to return to the previous menu or press **EXIT** to exit the menu.

Picture Menu

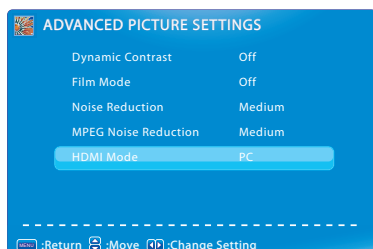
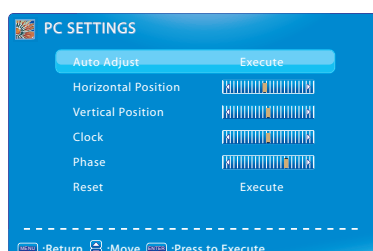
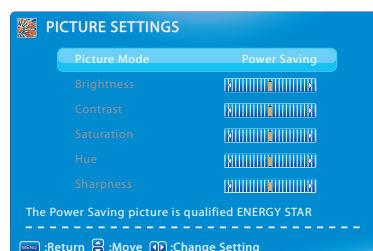
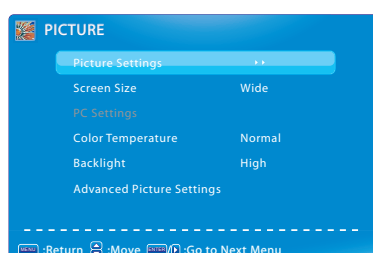

Menu item	Description
Picture Settings	<p>Apply a preset picture mode optimized for different viewing conditions (Standard / Movie / User / Power Saving / Dynamic).</p> <p>* If Picture Settings is set to User, you can adjust the following settings:</p> <ul style="list-style-type: none"> • Brightness: Adjust the brightness setting. • Contrast: Adjust the difference between the light and dark levels in the picture. • Saturation: Adjust the color detail of images. • Hue: Adjust the picture hue. • Sharpness: Adjust the sharpness of the edges of elements in the picture.
Screen Size	<p>Select the aspect ratio of the display (Zoom / Normal / Wide / Cinema / Full 100%).</p> <p>* For Full 100% option, it is only available on HDMI/DVI input source.</p>
PC Settings (only available on VGA source)	<p>Adjust the PC display settings.</p> <ul style="list-style-type: none"> • Auto Adjust: Synchronize the display automatically. • Horizontal Position: Move the screen position horizontally. • Vertical Position: Move the screen position vertically. • Clock: Adjust delay time of clock in order to reduce the noise of picture. • Phase: Adjust delay time of phase in order to reduce the noise of picture. • Reset: Reset to the default settings.
Color Temperature	<p>Apply a preset color temperature setting (Normal / Warm / Cool).</p>
Backlight	<p>Adjust the backlight that affects the overall brilliance of the picture (High / Medium / Low).</p>
Advanced Picture Settings	<p>Set additional picture settings:</p> <ul style="list-style-type: none"> • Dynamic Contrast: Automatically enhance the image for greater picture details. • Film Mode: Produce smoother motion picture when viewing movies. • Noise Reduction: Reduce the noise level. • MPEG Noise Reduction: Reduce the noise level when viewing movies.
HDMI Mode	<p>Allows to set the HDMI Mode to be: Video/PC.</p>

Sound Menu

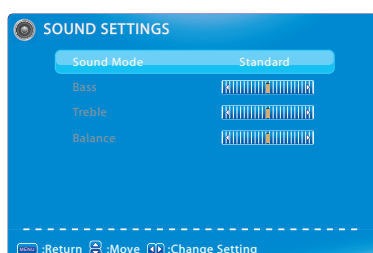
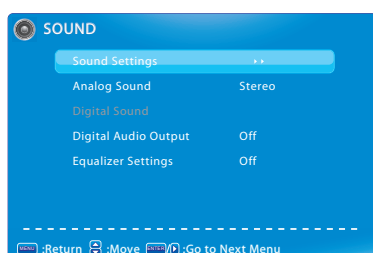

Menu item	Description
Sound Settings	Apply a preset audio option optimized for different sounding conditions (Standard / Soft / User / Dynamic). * If Sound Settings is set to User , you can adjust the following settings: <ul style="list-style-type: none"> • Bass: Adjust the bass level to your preference. • Treble: Adjust the treble level to your preference. • Balance: Adjust the sound balance between the left and right speakers.
Analog Sound	Select the analog audio mode (Mono / SAP / Stereo). * <i>Only available for analog channels.</i>
Digital Sound	Select the digital audio mode. * <i>Only available for digital channels.</i>
Digital Audio Output	Select the type of digital audio output to an external audio system (Off / PCM / Raw).
Equalizer Settings	Apply a preset equalizer setting (Off / Rock / Pop / Jazz).

Parental Control Menu

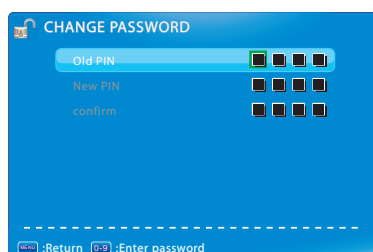

Menu item	Description
Lock Parental Control	Enter password to access Lock Parental Control menu. The default is "0000".
Change Password	Change the new password.
Keypad Lock	Select to lock the front panel keys operation.
Source Lock	Select the input source that you want to block.
System Lock	Enable/Disable the Lock Parental Control function.

Setup Menu

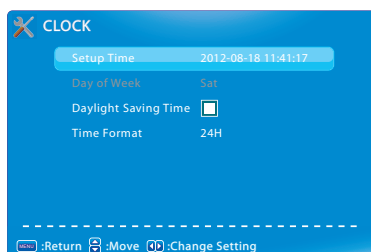
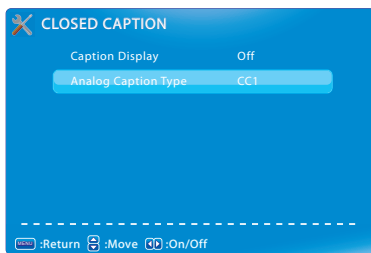
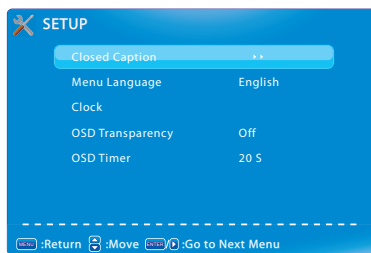

Menu item	Description
Closed Caption	Set Closed Caption (CC) settings. <ul style="list-style-type: none"> • Caption Display: Enable/Disable the caption display. • Analog Caption Type: Set the analog CC display type.
Menu Language	Select the on-screen menu language.
Clock	Set the time settings. <ul style="list-style-type: none"> • Setup Time: Set the current date and time. • Day of Week: Display the day of the week. • Daylight Saving Time: Set to turn on/off daylight saving. • Time Format: Select the time format. <p>* Daylight Saving Time is only available if Auto Clock is enabled.</p>
OSD Transparency	Set the OSD transparency level.
OSD Timer	Set the duration OSD menu stays visible on the screen.

Others Menu

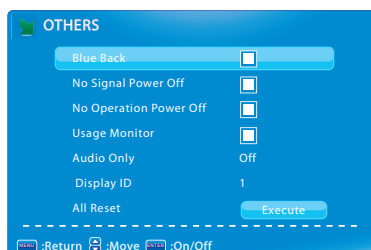

Menu item	Description
Blue Back	Select to enable the blue background in case of no signal.
No Signal Power Off	Select to set the display to automatically turn off in case of no signal for 10 minutes.
No Operation Power Off	Select to set the display to automatically turn off if it is left idle for 3 hours.
Usage Monitor	Select to calculate the overall monitor usage.
Audio Only	Output audio from the display speakers but turn off the display (Off / On).
Display ID	Set the display ID for RS232 parameter.
All Reset	Select to restore the factory default settings.

Hospitality Menu

1. Press **MENU** and **9, 9, 3** button on the remote controller to display the Hospitality menu.
2. Press **▲** or **▼** to select the menu item, then press **◀** or **▶** to adjust or select the setting. When selecting a menu item with a submenu (> >), press **▶** or **ENTER** to enter its submenu.
3. Press **MENU** to return to the previous menu or press **EXIT** to exit the menu.

Hospitality Menu	
EEPROM Init	DO
Save Config To USB	>>
Load Config From USB	>>
Hospitality	Off
Hospitality Function	>>

Menu item	Description
EEPROM Init	Clean up the setting to its initial value.
Save Config To USB	Save the hospitality configuration into USB drive.
Load Config From USB	Load the hospitality configuration from USB drive.
Hospitality	Turn on or off the Hospitality function.
Hospitality Function	Enter the hospitality sub-menu.

Hospitality Menu	
Remote Customer Code	0
Menu Key	Enable
Remote Control	Enable
VOL Def.	30
VOL Max	100
AV	Enable
YPbPr	Enable
HDMI1	Enable
HDMI2	Enable
HDMI3	Enable
PC	Enable
USB	Enable
Power Input	AV

Menu item	Description
Remote Customer Code	Select the specific remote ID (0, 1, or 2).
Menu Key	Enable or disable the MENU key.
Remote Control	Enable, disable remote or set as IR pass through
VOL Def.	Default volume for each power on.
VOL Max	Maximum available volume
AV YPbPr HDMI1/2/3 PC USB	Enable or disable the input source.
Power Input	Default input source for each power on.

Other Information

Troubleshooting

Please contact ViewSonic service team directly if you have questions, service needs, or require technical assistance related on the use of your display.

Contact ViewSonic Service Team at:

<http://www.ViewSonic.com>

Or call our service team:

United States 1-800-688-6688

Canada 1-866-463-4775

Europe +44 (0) 207 382 8250

Problem	Possible Solution
No power	<ul style="list-style-type: none">• Make sure the AC power cord is properly connected to the wall outlet.• Plug another electrical device (like a radio) to the power outlet to verify that the outlet is supplying the proper voltage.
No picture	<ul style="list-style-type: none">• Make sure that the cable connection to other components are properly installed.• Make sure that setup has been done correctly after connections.• Make sure the correct input is selected and the input signal is compatible.
Strange color, light color, or color misalignment	<ul style="list-style-type: none">• Ensure that the video cable is securely connected.• The picture may appear dim in a brightly lit room.• Adjust the display settings.• Check the input signal setting.
No sound	<ul style="list-style-type: none">• Check your audio connections to other components are properly installed.• The MUTE button may have been pressed, try pressing this button again.• Check your audio settings, your display audio may be set to minimum.• Press VOL + on the remote control.
Remote control unit does not operate	<ul style="list-style-type: none">• Make sure the batteries are inserted correctly.• Batteries could be weak or dead. Replace with new batteries.• Check if there is a fluorescent light illuminated near the remote control sensor.• The path of the remote control beam may be blocked. Make sure the path is clear and that the remote control is aimed at the remote control sensor on the display.• Press  on the remote control to see if you can turn on the display.• Press MENU on the remote control to see if there is an OSD menu shown on the screen.• Press only one button at a time and it is the correct one for the operation you want to perform.

Problem	Possible Solution
Unit cannot be operated	<ul style="list-style-type: none"> • External influences such as lightning or static electricity may cause improper operation. In this case, operate the unit after first turning on the power of the display and the AV System, or unplug the AC cord for 1 to 2 minutes, then replug again.
Power is cut off suddenly	<ul style="list-style-type: none"> • Make sure the sleep timer is turned off. • Make sure the PC or video signal cable is connected properly. • The internal temperature of the unit has increased. Remove any objects blocking the vent or clean as necessary.
Picture is cut off/with sidebar screen	<ul style="list-style-type: none"> • Make sure the video signal cable is connected properly. • Adjust the Screen Size setting on the Picture menu. • Press ASPECT repeatedly on the remote control to switch to the display mode you prefer.

Specifications

Model		CDE4200-L	CDE3200-L
(LED Backlight)	Screen Size	42-inch FHD 60Hz	32-inch FHD 60Hz
	Aspect Ratio	16:9	
Input signal	RGB	1 RGB analog (0.7/1.0 Vp-p, 75 ohms) Separate Sync, fh: 31.47-63.98 kHz, fv:59.8-70.09 Hz	
	Video	1 composite RCA, 1 YPbPr component, 3 HDMI	
	Audio	1 mini-stereo (for PC/VGA audio in), 1 pair of RCA (L/R) stereo	
	USB	JPEG / MP3 Format	
Compatibility	PC	Up to 1920 x 1080 (CEA mode)	
Speaker Output		10W x 2 @ THD=10% (max)	
Audio Output		1 Earphone jack, 1 SPDIF (optical)	
RS232 Output		RS232 communication	
Remote Control Out		Remote control out (NEC 38KHz / RC5 38KHz)	
Power	Voltage	AC 100~240V (50/60Hz)	
Operating conditions	Temperature	0°C to + 40°C	
	Humidity	20% to 90% (no condensation)	
Storage condition	Temperature	-20°C to + 60°C	
	Humidity	20% to 90% (no condensation)	
Dimensions	Physical (L) x (W) x (H)	974.2 x 210 x 626.3 mm (38.35 x 8.27 x 24.66 in)	747.8 x 180 x 488.1 mm (29.44 x 7.09 x 19.22 in)
Weight(Net)	With stand	13.3kg (29.3 lb)	8.8kg (19.38 lb)
	Without stand	11.9 kg (26.24 lb)	8.0kg (17.62 lb)
Regulations		UL/cUL, FCC-B (Doc-B), ICES-003, CE	UL/cUL, FCC-B (Doc-B), ICES-003, CE, ENERGY STAR®
Power consumption	On	59 W (typ) / 75 W (max)	50 W (typ) / 55 W (max)
	Stand by	0.5W	
Warning: Do not set the graphics card in your computer to exceed these refresh rates; doing so may result in permanent damage to the display.			

Note:

Product Specifications are subject to change without notice.

Model		CDE6500-L
(LED Backlight)	Screen Size	64.5-inch FHD 60Hz
	Aspect Ratio	16:9
Input signal	RGB	1 RGB analog (0.7/1.0 Vp-p, 75 ohms) Separate Sync, fh: 31.47-63.98 kHz, fv:59.8-70.09 Hz
	Video	1 composite RCA, 1 YPbPr component, 3 HDMI
	Audio	1 mini-stereo (for PC/VGA audio in), 1 pair of RCA (L/R) stereo
	USB	JPEG / MP3 Format
Compatibility	PC	Up to 1920 x 1080 (CEA mode)
Speaker Output		10W x 2 @ THD=10% (max)
Audio Output		1 Earphone jack, 1 SPDIF (optical)
RS232 Output		RS232 communication
Remote Control Out		Remote control out (NEC 38KHz / RC5 38KHz)
Power	Voltage	AC 100~240V (50/60Hz)
Operating conditions	Temperature	0°C to + 40°C
	Humidity	20% to 90% (no condensation)
Storage condition	Temperature	-20°C to + 60°C
	Humidity	20% to 90% (no condensation)
Dimensions	Physical (L) x (W) x (H)	1463 x 280 x 942.4 mm (57.64 x 11.03 x 37.1 in)
Weight(Net)	With stand	42 kg (92.3 lb)
	Without stand	37.2 kg (82 lb)
Regulations		UL/cUL, FCC-B (Doc-B), ICES-003, CE
Power consumption	On	160 W (typ) / 180 W (max)
	Stand by	0 .5W
Warning: Do not set the graphics card in your computer to exceed these refresh rates; doing so may result in permanent damage to the display.		

Note:

Product Specifications are subject to change without notice.

RS232 Protocol

1. Introduction

This document describes the hardware interface spec and software protocols of RS232 interface communication between Viewsonic Commercial Display and PC or other control unit with RS232 protocol.

The protocol divide into three sections:

- Set-Function
- Get-Function
- Remote control pass-through mode

※In below document, “PC” will represents all the control units that can sent or receive the RS232 protocol command.

2. Description

2.1 Hardware specification

Viewsonic communication port in the rear side

(1) Connector type: DSUB 9 Pin Male

(2) Pin Assignment

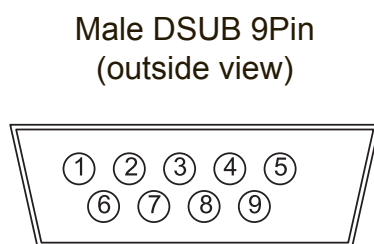

Pin #	Signal	Remark
1	NC	
2	RXD	Input to Monitor
3	TXD	Output from Monitor
4	NC	
5	GND	
6	NC	
7	NC	
8	NC	
9	NC	
frame	GND	

* Use of crossover (null modem) cable required for use with PC.

2.2 Communication Setting

- Baud Rate Select: 9600bps (fixed)
- Data bits: 8bits (fixed)
- Parity: None (fixed)
- Stop Bits: 1 (fixed)

2.3 Command Message Reference

PC sends to Monitor command packet followed by “CR”. Every time PC sends control command to the Monitor, the Monitor shall response as follows:

1. If the message is receives correctly it will send “+” (02Bh) followed by “CR” (00Dh)
2. If the message is receives incorrectly it will send “-” (02Dh) followed by “CR” (00Dh)

3. Protocol

3.1 Set-Function Listing

The PC can control the display for specific actions. The Set-Function command allows you to control the display behavior in a remote sit through the RS232 port. The Set-Function packet format consists of 9 bytes.

Set-Function description:

- Length:** Total Byte of Message excluding "CR"
- ID:** Identification for each of display
If we want to set all settings, ID can use "99" to achieve, and it will not have Reply command on this function.
The ID can be set via the OSD menu for each set.
- Command Type:** Identify command type,
"s" (0x73h) : Set Command
"+" (0x2Bh) : Valid command Reply
"- " (0x2Dh) : Invalid command Reply
- Command:** Function command code: One byte ASCII code
- Value[1~3]:** Three bytes ASCII that defines the value
- CR:** 0x0D

Set-Function format:

Send: (Command Type= "s")

Name	Length	ID	Command Type	Command	Value1	Value2	Value3	CR
Byte Count	1 Byte	2 Byte	1 Byte	1 Byte	1 Byte	1 Byte	1 Byte	1 Byte
Bytes order	1	2~3	4	5	6	7	8	9

Reply: (Command Type= "+" or "-")

Name	Length	ID	Command Type	CR
Byte Count	1 Byte	2 Byte	1 Byte	1 Byte
Bytes order	1	2~3	4	5

[NOTE] The reply for "Power on" command is the exception. It's 0x322B0D (2+<CR>).

Example1: Set Brightness as 76 for TV-02 and this command is valid

Send (Hex Format)

Name	Length	ID	Command Type	Command	Value1	Value2	Value3	CR
Hex	<u>0x38</u>	<u>0x30</u> <u>0x32</u>	<u>0x73</u>	<u>0x24</u>	<u>0x30</u>	<u>0x37</u>	<u>0x36</u>	<u>0x0D</u>

Reply (Hex Format)

Name	Length	ID	Command Type	CR
Hex	<u>0x34</u>	<u>0x30</u> <u>0x32</u>	<u>0x2B</u>	<u>0x0D</u>

**Example2: Set Brightness as 176 for TV-02 and this command is NOT valid.
Send (Hex Format)**

Name	Length	ID	Command Type	Command	Value1	Value2	Value3	CR
Hex	0x38	0x30 0x32	0x73	0x24	0x31	0x37	0x36	0x0D

Reply (Hex Format)

Name	Length	ID	Command Type	CR
Hex	0x34	0x30 0x32	0x2D	0x0D

Set-function table

Set Function	Length	ID	Command Type (ASCII)	Command		Value Range (Three ASCII bytes)	Comments
				Code (ASCII)	Code (Hex)		
Power on/off (standby)	8		s	!	21	000: STBY 001: ON	
Input Select	8		s	"	22	000 : TV 001 : AV 002 : S-Video 003 : YPbPr 004 : HDMI 014: HDMI2 024: HDMI3 005 : DVI 006 : PC/VGA	1. No need for USB 2. For the case of two more same sources, the 2nd digital is used to indicate the extension.
Contrast	8		s	#	23	000 ~ 100	
Brightness	8		s	\$	24	000 ~ 100	
Sharpness	8		s	%	25	000 ~ 100	
Color	8		s	&	26	000 ~ 100	
Tint	8		s	'	27	000 ~ 100	
Color mode	8		s)	29	000: Normal 001: Warm 002: Cold 003: Personal	
Bass	8		s	.	2E	000 ~ 100	
Treble	8		s	/	2F	000 ~ 100	
Balance	8		s	0	30	000 ~ 100	Sets Balance position
OSD language	8		s	2	32	000: English 001: French 002: Spanish	Extend the value for more supported languages
Power lock	8		s	4	34	000 : Unlock 001 : Lock	
Volume	8		s	5	35	000 ~ 100 900:Volume down (-1) 901:Volume up (+1)	
Mute	8		s	6	36	000: OFF 001: ON (mute)	
Button lock	8		s	8	38	000: Unlock 001: Lock	
Menu lock	8		s	>	3E	000: Unlock 001: Lock	

Number	8		s	@	40	000~009	
Key Pad	8		s	A	41	000: UP 001: DOWN 002: LEFT 003: RIGHT 004: ENTER 005: INPUT 006: MENU/EXIT	
Remote Control	8		s	B	42	000: Disable 001: Enable 002: Pass through	Disable: RCU has no effect on HDTV. Enabled: RCU controls the HDTV. This is the power up default on the HDTV. Pass through: RCU has no effect on HDTV and all RCU command codes are transmitted to FC via the RS232 port.
Restore default	8		s	~	7E	000	Resets HDTV to factory setting

Note:

1. Behavior at lock modes

Lock Mode	Behavior
Button Lock	<ol style="list-style-type: none"> 1. Lock all buttons of front panel and RCU, except for "Power" 2. All the SET functions should be workable via RS32, even the ones with according hot key in RCU like Mute,...etc.
MENU Lock	<ol style="list-style-type: none"> 1. Lock "MENU" key of front panel and RCU 2. The Factory and Hospitality modes should not be blocked for the model using MENU-combined key to enter these two modes. Alternative approach will be indicated separately if any limitation by model.
POWER Lock	<ol style="list-style-type: none"> 1. Lock "POWER" key of front and RCU. 2. The SET_POWER on/off should be workable via RS232, but does not mean the POWER lock will be released under this case. 3. Can not be un-locked by reset in OSD setting 4. Will auto AC power-on in power-lock 5. Under power-lock, the set will not enter power saving when no PC signal and neither not turn off when no other video signals after 15min.
Remote control disable	Lock the keys on RCU, but keep the buttons of front panel workable.

3.2 Get-Function Listing

The PC can interrogate the display for specific information. The Get-Function packet format consists of 9 bytes which is similar to the Set-Function packet structure. Note that the "Value" byte is always = 00.

Set-Function description:

- Length:** Total Byte of Message excluding "CR"
ID: Identification for each of display
Command Type: Identify command type,
 "g" (0x67h) : Get Command
 "r" (0x72h) : Valid command Reply
 "-" (0x2Dh) : Invalid command Reply
Command: Function command code: One byte ASCII code
Value[1~3]: Three bytes ASCII that defines the value
CR: 0x0D

Get-Function format:

Send: (Command Type= "g")

Name	Length	ID	Command Type	Command	Value1	Value2	Value3	CR
Byte Count	1 Byte	2 Byte	1 Byte	1 Byte	1 Byte	1 Byte	1 Byte	1 Byte
Bytes order	1	2~3	4	5	6	7	8	9

Reply: (Command Type= "r" or "-")

If the Command is valid, Command Type = "r"

Name	Length	ID	Command Type	Command	Value1	Value2	Value3	CR
Byte Count	1 Byte	2 Byte	1 Byte	1 Byte	1 Byte	1 Byte	1 Byte	1 Byte
Bytes order	1	2~3	4	5	6	7	8	9

If the Command is Not valid, Command Type= "-"

Name	Length	ID	Command Type	CR
Byte Count	1 Byte	2 Byte	1 Byte	1 Byte
Bytes order	1	2~3	4	5

**Example1: Get Brightness from TV-05 and this command is valid.
 The Brightness value is 67.**

Send (Hex Format)

Name	Length	ID	Command Type	Command	Value1	Value2	Value3	CR
Hex	<u>0x38</u>	<u>0x30</u> <u>0x35</u>	<u>0x67</u>	<u>0x62</u>	<u>0x30</u>	<u>0x30</u>	<u>0x30</u>	<u>0x0D</u>

Reply (Hex Format)

Name	Length	ID	Command Type	Command	Value1	Value2	Value3	CR
Hex	<u>0x38</u>	<u>0x30</u> <u>0x35</u>	<u>0x72</u>	<u>0x62</u>	<u>0x30</u>	<u>0x36</u>	<u>0x37</u>	<u>0x0D</u>

Example2: Get Brightness from TV-05 , but the Brightness command ID is error and it is NOT in the command table.

Send (Hex Format)

Name	Length	ID	Command Type	Command	Value1	Value2	Value3	CR
Hex	<u>0x38</u>	<u>0x30</u> <u>0x35</u>	<u>0x67</u>	<u>0XD3</u>	<u>0x30</u>	<u>0x30</u>	<u>0x30</u>	<u>0x0D</u>

Reply (Hex Format)

Name	Length	ID	Command Type	CR
Hex	<u>0x34</u>	<u>0x30</u> <u>0x35</u>	<u>0x2D</u>	<u>0x0D</u>

Get-function table

Set Function	Length	ID	Command Type	Command		Value Range (Three ASCII bytes)	Comments
				Code (ASCII)	Code (Hex)		
Get-Contrast	8		g	a	61	000 ~ 100	
Get-Brightness	8		g	b	62	000 ~ 100	
Get-Sharpness	8		g	c	63	000 ~ 100	
Get-Color	8		g	d	64	000 ~ 100	
Get-Tint	8		g	e	65	000 ~ 100	
Get-Volume	8		g	f	66	000 ~ 100	
Get-Mute	8		g	g	67	000: Off 001: On (muted)	
Get-Input select	8		g	j	6A	000~	See Set-function table
Get-Power status: ON/STBY	8		g	l	6C	001: ON 000: STBY	
Get-Remote control	8		g	n	6E	000: Disable 001: Enable 002: Pass through	Gets RCU mode status
Get-Power lock	8		g	o	6F	000: Unlock 001: Lock	
Get-Button lock	8		g	p	70	000: Unlock 001: Lock	
Get-Menu lock	8		g	q	71	000: Unlock 001: Lock	
Get-Setup wizard	8		g	s	73	000: Disable 001: Enable	
Get-ACK	8		g	z	7A	000	This command is used to test the communication link.

3.3 Remote Control Pass-through mode

When PC sets the display to Remote Control Pass through mode, the display shall send a 7 bytes packet (followed by “CR”) in response to RCU button activation. Note, that in this mode the RCU shall have no effect on the display function. For example: “Volume+” will not change the volume in the but only sends “Volume+” code to PC over the RS232 port.

IR Pass Through-Function format

Reply: (Command Type= “p”)

Name	Length	ID	Command Type	RCU Code1 (MSB)	RCU Code2 (LSB)	CR
Byte Count	1 Byte	2 Byte	1 Byte	1 Byte	1 Byte	1 Byte
Bytes order	1	2~3	4	5	6	7

Example1: Remote Control pass-through when “VOL+” key is pressed for TV-05 Reply (Hex Format)

Name	Length	ID	Command Type	RCU Code1 (MSB)	RCU Code2 (LSB)	CR
Hex	<u>0x36</u>	<u>0x30</u> <u>0x35</u>	<u>0x70</u>	<u>0x31</u>	<u>0x30</u>	<u>0x0D</u>

Key	Code (HEX)
1	01
2	02
3	03
4	04
5	05
6	06
7	07
8	08
9	09
0	0A
-	0B
RECALL (LAST)	0C
	0D
	0E
ASPECT (ZOOM)	0F
VOLUME UP (+)	10
VOLUME DOWN (-)	11
MUTE	12
CHANNEL/PAGE UP (+)	13
CHANNEL/PAGE DOWN (-)	14
POWER	15
SOURCES (INPUTS)	16
	17

	18
SLEEP	19
MENU	1A
UP	1B
DOWN	1C
LEFT	1D
RIGHT	1E
OK (ENTER)	1F
EXIT	20
	21
	22
	23
	24
	25
	26
	27
	28
	29
	2A
	2B
	2C
	2D
	2E
	2F

Note:

1. This IR-pass-through code is different with RCU key code.
2. Special control sequence for POWER key under IR-pass through mode.
 - 2-1. When display is OFF and receives the POWER code: The display will turn on itself, then forward the POWER code to the host via RS232.
 - 2-2. When display is ON and receives the POWER code: The display will forward the POWER code to the host via RS232, then turns off itself.
3. The code of VOLUME UP and VOLUME DOWN will repeatedly output when press and hold the keys.

Customer Support

For technical support or product service, see the table below or contact your reseller.
NOTE: You will need the product serial number.

Use with other Wall-Mount kit may cause instability and possibly result in injury.
 To find the perfect mount for CDE6500-L/CDE4200-L/CDE3200-L, please browse
www.viewsonic.com or call our service team: United States 1-800-688-6688,
 Canada 1-866-463-4775, Europe +44 (0) 207 382 8250.

Country/Region	Website	T = Telephone F = FAX	Email
United States	www.viewsonic.com	T (Toll-Free)= 1-800-688-6688 T (Toll)= 1-424-233-2530 F= 1-909-468-3757	service.us@viewsonic.com
Canada	www.viewsonic.com	T (Toll-Free)= 1-866-463-4775 T (Toll)= 1-424-233-2533 F= 1-909-468-3757	service.ca@viewsonic.com
Europe	www.viewsoniceurope.com	www.viewsoniceurope.com/uk/support/call-desk/	
Latin America (Argentina)	www.viewsonic.com/la/	T= 0800-4441185	soporte@viewsonic.com
Latin America (Chile)	www.viewsonic.com/la/	T= 1230-020-7975	soporte@viewsonic.com
Latin America (Columbia)	www.viewsonic.com/la/	T= 01800-9-157235	soporte@viewsonic.com
Latin America (Mexico)	www.viewsonic.com/la/	T= 001-8882328722	soporte@viewsonic.com
Renta y Datos, 29 SUR 721, COL. LA PAZ, 72160 PUEBLA, PUE. Tel: 01.222.891.55.77 CON 10 LINEAS Electroser, Av Reforma No. 403Gx39 y 41, 97000 Mérida, Yucatán. Tel: 01.999.925.19.16 Other places please refer to http://www.viewsonic.com/la/soporte/index.htm#Mexico			
Latin America (Peru)	www.viewsonic.com/la/	T= 0800-54565	soporte@viewsonic.com

Limited Warranty

ViewSonic® LCD Commercial Display

What the warranty covers:

ViewSonic warrants its products to be free from defects in material and workmanship, under normal use, during the warranty period. If a product proves to be defective in material or workmanship during the warranty period, ViewSonic will, at its sole option, repair or replace the product with a like product. Replacement product or parts may include remanufactured or refurbished parts or components.

How long the warranty is effective:

ViewSonic LCD Commercial Displays are warranted for 3 years for all parts excluding the light source and 3 years for labor from the date of the first customer purchase.

Who the warranty protects:

This warranty is valid only for the first consumer purchaser.

What the warranty does not cover:

1. Any product on which the serial number has been defaced, modified or removed.
2. Damage, deterioration or malfunction resulting from:
 - a. Accident, misuse, neglect, fire, water, lightning, or other acts of nature, unauthorized product modification, or failure to follow instructions supplied with the product.
 - b. Any damage of the product due to shipment.
 - c. Removal or installation of the product.
 - d. Causes external to the product, such as electrical power fluctuations or failure.
 - e. Use of supplies or parts not meeting ViewSonic's specifications.
 - f. Normal wear and tear.
 - g. Any other cause which does not relate to a product defect.
3. Any product exhibiting a condition commonly known as "image burn-in" which results when a static image is displayed on the product for an extended period of time.
4. Removal, installation, one way transportation, insurance, and set-up service charges.

How to get service:

1. For information about receiving service under warranty, contact ViewSonic Customer Support (Please refer to Customer Support page). You will need to provide your product's serial number.
2. To obtain warranty service, you will be required to provide (a) the original dated sales slip, (b) your name, (c) your address, (d) a description of the problem, and (e) the serial number of the product.
3. Take or ship the product freight prepaid in the original container to an authorized ViewSonic service center or ViewSonic.
4. For additional information or the name of the nearest ViewSonic service center, contact ViewSonic.

Limitation of implied warranties:

There are no warranties, express or implied, which extend beyond the description contained herein including the implied warranty of merchantability and fitness for a particular purpose.

Exclusion of damages:

ViewSonic's liability is limited to the cost of repair or replacement of the product. ViewSonic shall not be liable for:

1. Damage to other property caused by any defects in the product, damages based upon inconvenience, loss of use of the product, loss of time, loss of profits, loss of business opportunity, loss of goodwill, interference with business relationships, or other commercial loss, even if advised of the possibility of such damages.
2. Any other damages, whether incidental, consequential or otherwise.
3. Any claim against the customer by any other party.
4. Repair or attempted repair by anyone not authorized by ViewSonic.

Effect of state law:

This warranty gives you specific legal rights, and you may also have other rights which vary from state to state. Some states do not allow limitations on implied warranties and/or do not allow the exclusion of incidental or consequential damages, so the above limitations and exclusions may not apply to you.

Sales outside the U.S.A. and Canada:

For warranty information and service on ViewSonic products sold outside of the U.S.A. and Canada, contact ViewSonic or your local ViewSonic dealer.

The warranty period for this product in mainland China (Hong Kong, Macao and Taiwan Excluded) is subject to the terms and conditions of the Maintenance Guarantee Card.

For users in Europe and Russia, full details of warranty provided can be found in www.viewsoniceurope.com under Support/Warranty Information.

Mexico Limited Warranty

ViewSonic® LCD Commercial Display

What the warranty covers:

ViewSonic warrants its products to be free from defects in material and workmanship, under normal use, during the warranty period. If a product proves to be defective in material or workmanship during the warranty period, ViewSonic will, at its sole option, repair or replace the product with a like product. Replacement product or parts may include remanufactured or refurbished parts or components.

How long the warranty is effective:

ViewSonic LCD Commercial Displays are warranted for 3 years for all parts excluding the light source and 3 years for labor from the date of the first customer purchase.

Who the warranty protects:

This warranty is valid only for the first consumer purchaser.

What the warranty does not cover:

1. Any product on which the serial number has been defaced, modified or removed.
2. Damage, deterioration or malfunction resulting from:
 - a. Accident, misuse, neglect, fire, water, lightning, or other acts of nature, unauthorized product modification, or failure to follow instructions supplied with the product.
 - b. Any damage of the product due to shipment.
 - c. Removal or installation of the product.
 - d. Causes external to the product, such as electrical power fluctuations or failure.
 - e. Use of supplies or parts not meeting ViewSonic's specifications.
 - f. Normal wear and tear.
 - g. Any other cause which does not relate to a product defect.
3. Any product exhibiting a condition commonly known as "image burn-in" which results when a static image is displayed on the product for an extended period of time.
4. Removal, installation, one way transportation, insurance, and set-up service charges.

How to get service:

For information about receiving service under warranty, contact ViewSonic Customer Support (Please refer to the attached Customer Support page). You will need to provide your product's serial number, so please record the product information in the space provided below on your purchase for your future use. Please retain your receipt of proof of purchase to support your warranty claim.

For Your Records

Product Name: _____

Model Number: _____

Document Number: _____

Serial Number: _____

Purchase Date: _____

Extended Warranty Purchase? _____(Y/N)
If so, what date does warranty expire? _____

1. To obtain warranty service, you will be required to provide (a) the original dated sales slip, (b) your name, (c) your address, (d) a description of the problem, and (e) the serial number of the product.
2. Take or ship the product in the original container packaging to an authorized ViewSonic service center.
3. Round trip transportation costs for in-warranty products will be paid by ViewSonic.

Limitation of implied warranties:

There are no warranties, express or implied, which extend beyond the description contained herein including the implied warranty of merchantability and fitness for a particular purpose.

Exclusion of damages:

ViewSonic's liability is limited to the cost of repair or replacement of the product. ViewSonic shall not be liable for:

1. Damage to other property caused by any defects in the product, damages based upon inconvenience, loss of use of the product, loss of time, loss of profits, loss of business opportunity, loss of goodwill, interference with business relationships, or other commercial loss, even if advised of the possibility of such damages.
2. Any other damages, whether incidental, consequential or otherwise.
3. Any claim against the customer by any other party.
4. Repair or attempted repair by anyone not authorized by ViewSonic.

Contact Information for Sales & Authorized Service (Centro Autorizado de Servicio) within Mexico:	
Name, address, of manufacturer and importers: México, Av. de la Palma #8 Piso 2 Despacho 203, Corporativo Interpalmas, Col. San Fernando Huixquilucan, Estado de México Tel: (55) 3605-1099 http://www.viewsonic.com/la/soporte/index.htm	
NÚMERO GRATIS DE ASISTENCIA TÉCNICA PARA TODO MÉXICO: 001.866.823.2004	
Hermosillo: Distribuciones y Servicios Computacionales SA de CV. Calle Juarez 284 local 2 Col. Bugambillas C.P: 83140 Tel: 01-66-22-14-9005 E-Mail: disc2@hmo.megared.net.mx	Villahermosa: Compumantenimientos Garantizados, S.A. de C.V. AV. GREGORIO MENDEZ #1504 COL, FLORIDA C.P. 86040 Tel: 01 (993) 3 52 00 47 / 3522074 / 3 52 20 09 E-Mail: compumantenimientos@prodigy.net.mx
Puebla, Pue. (Matriz): RENTA Y DATOS, S.A. DE C.V. Domicilio: 29 SUR 721 COL. LA PAZ 72160 PUEBLA, PUE. Tel: 01(52).222.891.55.77 CON 10 LINEAS E-Mail: datos@puebla.megared.net.mx	Veracruz, Ver.: CONEXION Y DESARROLLO, S.A DE C.V. Av. Americas # 419 ENTRE PINZÓN Y ALVARADO Fracc. Reforma C.P. 91919 Tel: 01-22-91-00-31-67 E-Mail: gacosta@qplus.com.mx
Chihuahua Soluciones Globales en Computación C. Magisterio # 3321 Col. Magisterial Chihuahua, Chih. Tel: 4136954 E-Mail: Cefeo@soluglobales.com	Cuernavaca Compusupport de Cuernavaca SA de CV Francisco Leyva # 178 Col. Miguel Hidalgo C.P. 62040, Cuernavaca Morelos Tel: 01 777 3180579 / 01 777 3124014 E-Mail: aquevedo@compusupportcva.com
Distrito Federal: QPLUS, S.A. de C.V. Av. Coyoacán 931 Col. Del Valle 03100, México, D.F. Tel: 01(52)55-50-00-27-35 E-Mail : gacosta@qplus.com.mx	Guadalajara, Jal.: SERVICRECE, S.A. de C.V. Av. Niños Héroes # 2281 Col. Arcos Sur, Sector Juárez 44170, Guadalajara, Jalisco Tel: 01(52)33-36-15-15-43 E-Mail: mmiranda@servicrece.com
Guerrero Acapulco GS Computación (Grupo Sesicomp) Progreso #6-A, Colo Centro 39300 Acapulco, Guerrero Tel: 744-48-32627	Monterrey: Global Product Services Mar Caribe # 1987, Esquina con Golfo Pérsico Fracc. Bernardo Reyes, CP 64280 Monterrey N.L. México Tel: 8129-5103 E-Mail: aydeem@gps1.com.mx
MERIDA: ELECTROSER Av Reforma No. 403Gx39 y 41 Mérida, Yucatán, México CP97000 Tel: (52) 999-925-1916 E-Mail: rrrb@sureste.com	Oaxaca, Oax.: CENTRO DE DISTRIBUCION Y SERVICIO, S.A. de C.V. Murguía # 708 P.A., Col. Centro, 68000, Oaxaca Tel: 01(52)95-15-15-22-22 Fax: 01(52)95-15-13-67-00 E-Mail: gpotai2001@hotmail.com
Tijuana: STD Av Ferrocarril Sonora #3780 L-C Col 20 de Noviembre Tijuana, Mexico	FOR USA SUPPORT: ViewSonic Corporation 381 Brea Canyon Road, Walnut, CA. 91789 USA Tel: 800-688-6688 (English); 866-323-8056 (Spanish); Fax: 1-800-685-7276 E-Mail: http://www.viewsonic.com



Free Manuals Download Website

<http://myh66.com>

<http://usermanuals.us>

<http://www.somanuals.com>

<http://www.4manuals.cc>

<http://www.manual-lib.com>

<http://www.404manual.com>

<http://www.luxmanual.com>

<http://aubethermostatmanual.com>

Golf course search by state

<http://golfingnear.com>

Email search by domain

<http://emailbydomain.com>

Auto manuals search

<http://auto.somanuals.com>

TV manuals search

<http://tv.somanuals.com>