

ViewSonic®

N3260w/N3760w/N4060w

LCD TV Display

- User Guide
- Guide de l'utilisateur
- Guía del usuario



ViewSonic®

Model No. : VS10847-1M / VS10848-1M / VS10846-1M

Contents

Compliance Information	1
Important Safety Instructions	2
Copyright Information	3
Product Registration.....	3
Antenna Installation Instructions	4
Cleaning the LCD Display	4

Getting Started

Package Contents	5
Front View of the Product.....	6
Rear View of the product.....	7
Remote Control	8
Notes on the Remote Control	10
Remote Control Battery Installation	11
Cable Connection.....	12

OSD Functions

Picture Adjustment	14
Image Adjustment	15
Source Adjustment.....	17
Setup Adjustment	18
Audio Adjustment	20
Tuner Adjustment.....	21
V-Chip Adjustment	22

Appendix

Specifications	24
Troubleshooting	26
Customer Support	27
Limited Warranty	28

Compliance Information

User Information for North America.

Notice: Use the cables which are included with the unit or specified.



is a trademark of SRS Labs, Inc.

TruSurround XT technology is incorporated under license from SRS Labs, Inc.



HDMI, the HDMI logo and High-Definition Multimedia Interface are registered trademarks of HDMI Licensing LLC.



The Pixelworks DNX Technology™ logo is a trademark of Pixelworks, Inc.

Important Safety Instructions

1. Read these instructions completely before using the equipment.
2. Keep these instructions in a safe place.
3. Heed all warnings.
4. Follow all instructions.
5. Do not use this equipment near water.
6. Clean with a soft, dry cloth. If further cleaning is required, see “Cleaning the Display” in this guide for further instructions.
7. Do not block any ventilation openings. Install the equipment in accordance with the manufacturer’s instructions.
8. Do not install near any heat sources such as radiators, heat registers, stoves, or other devices (including amplifiers) that produce heat.
9. Do not attempt to circumvent the safety provisions of the polarized or grounding-type plug. A polarized plug has two blades with one wider than the other. A grounding type plug has two blades and a third grounding prong. The wide blade and the third prong are provided for your safety. If the plug does not fit into your outlet, consult an electrician for replacement of the outlet.
10. Protect the power cord from being tread upon or pinched, particularly at the plug, and the point where it emerges from the equipment. Be sure that the power outlet is located near the equipment so that it is easily accessible.
11. Only use attachments/accessories specified by the manufacturer.
12. Use only with the cart, stand, tripod, bracket, or table specified by the manufacturer, or sold with the equipment. When a cart is used, use caution when moving the cart/equipment combination to avoid injury from tipping over.
13. Unplug this equipment when it will be unused for long periods of time.
14. Refer all servicing to qualified service personnel. Service is required when the unit has been damaged in any way, such as: if the power-supply cord or plug is damaged, if liquid is spilled onto or objects fall into the unit, if the unit is exposed to rain or moisture, or if the unit does not operate normally or has been dropped.

Copyright Information

Copyright © ViewSonic® Corporation, 2005. All rights reserved.

ViewSonic®, the three birds logo, OnView, ViewMatch, and ViewMeter are registered trademarks of ViewSonic Corporation.

Disclaimer: ViewSonic Corporation shall not be liable for technical or editorial errors or omissions contained herein; nor for incidental or consequential damages resulting from furnishing this material, or the performance or use of this product.

In the interest of continuing product improvement, ViewSonic Corporation reserves the right to change product specifications without notice. Information in this document may change without notice.

No part of this document may be copied, reproduced, or transmitted by any means, for any purpose without prior written permission from ViewSonic Corporation.

Product Registration

To meet your future needs, and to receive any additional product information as it becomes available, please register your product on the Internet at: www.viewsonic.com.

For Your Records	
Product Name:	N3260w / N3760w / N4060w ViewSonic LCD TV Display
Model Number:	VS10847-1M / VS10848-1M / VS10846-1M
Document Number:	N3260w/N3760w/N4060w-1M_UG_ENG Rev. 1A 07-26-05
Serial Number:	_____
Purchase Date:	_____

Product disposal at end of product life

ViewSonic® is concerned about the preservation of our environment. Please dispose of this product properly at the end of its useful life. Your local waste disposal company may provide information about proper disposal.

The lamp in this product contains mercury. Please dispose of properly in accordance with environmental laws of your location.

Antenna Installation Instructions

1 Outdoor Antenna Grounding

If an outside antenna or cable system is connected to the product be sure the antenna or cable system is grounded to avoid voltage surges and built-up static charges. Article 810 of the National Electrical Code, ANSI/NFPA 70, provides information with regard to proper grounding of the mast and supporting structure, grounding of the lead-in wire to an antenna discharge unit, connection to grounding electrodes, and requirements for the grounding electrode.

2 Lightning

For added protection for this product during a lightning storm, or when it is left unattended and unused for long periods of time, unplug it from the wall outlet and disconnect the antenna or cable system. This will prevent damage to the product due to lightning and power-line surges. Do not disconnect the antenna or the power cord during a heavy storm as lightning may strike while you are holding the cable cord, causing serious injury. Turn off your LCD and wait for the weather to improve.

3 Power Lines

An outside antenna system should not be located in the vicinity of overhead power lines or other electric light or power circuits. When installing an outside antenna system, extreme care should be taken to keep from touching the power lines or circuits as contact with them may be fatal.

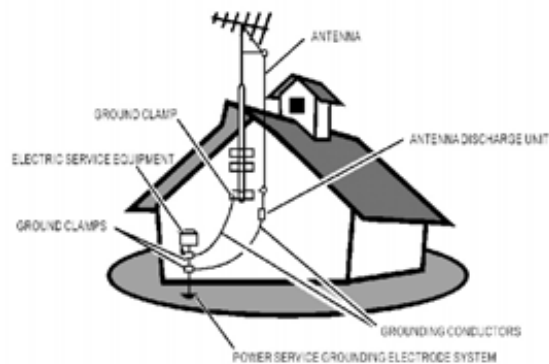

Cleaning the LCD Display

- Make sure the LCD Display is turned off.
- Never spray or pour any liquid directly onto the screen or case.

To clean the screen:

1. Wipe the screen with a clean, soft, lint-free cloth. This removes dust and other particles.
2. If still not clean, apply a small amount of non-ammonia, non-alcohol based glass cleaner onto a clean, soft, lint-free cloth, and wipe the screen.

To clean the case:

1. Use a soft, dry cloth.
2. If still not clean, apply a small amount of non-ammonia, non-alcohol based, mild non-abrasive detergent onto a clean, soft, lint-free cloth, then wipe the surface.

Disclaimer

ViewSonic does not recommend the use of any ammonia or alcohol-based cleaners on the LCD screen or case. Some chemical cleaners have been reported to damage the screen and/or LCD case. ViewSonic will not be liable for damage resulting from use of any ammonia or alcohol-based cleaners.

Getting Started

Congratulations on your purchase of a ViewSonic LCD TV display.

Important! Save the original box and all packaging material for future shipping needs.

Package Contents

Please confirm that the following accessories are present when you unpack the box:

- LCD TV
- Remote Control (batteries included)
- Power Cord(s)
- AV Cable
- Color Quick Start Guide
- User Guide

Front View of the Product

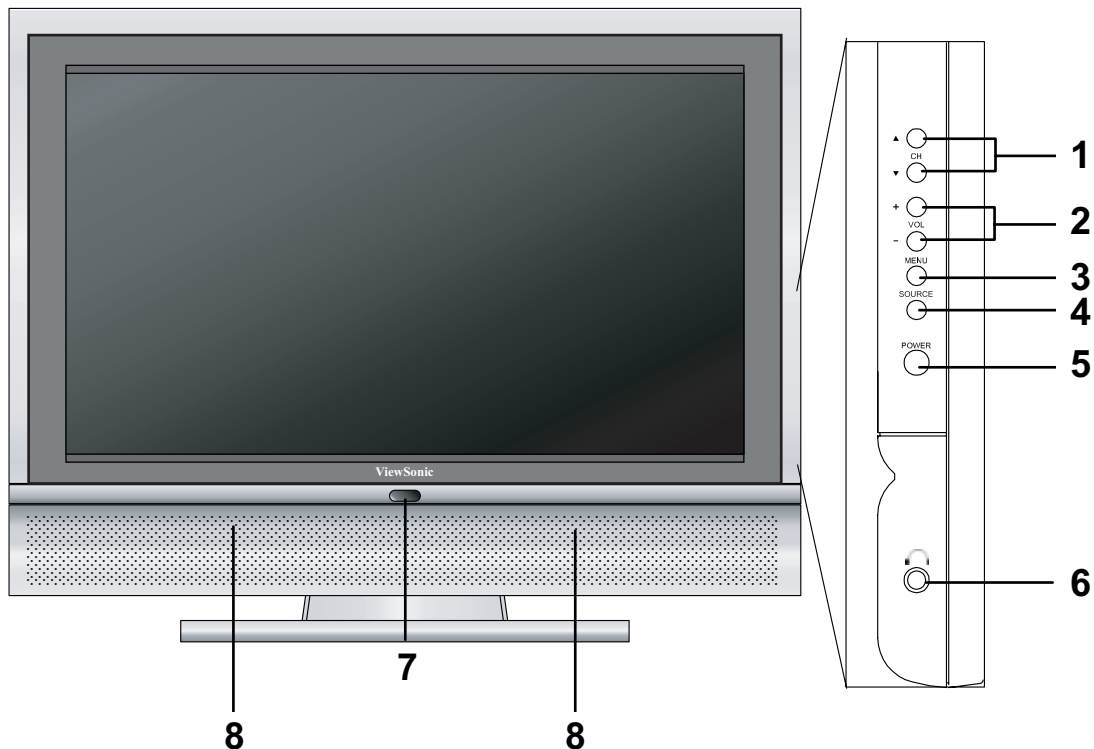

- 1 CH ▲ / ▼**
Changes the channel.
- 2 VOL +/-**
Used for changing the volume.
- 3 MENU**
Display menu screen.
- 4 SOURCE**
Switch between display input sources.
- 5 POWER**
Turns the TV on and off. A green light indicates that TV is on and red that it is off.
- 6 EARPHONE **
Used for connecting headphones to the TV.
- 7 Power indicator LED**
GREEN shall apply during all operational states (i.e. with image present), LED light off when the product in stand-by mode. Red light apply when no PC/HDMI signals in PC/HDMI mode after 15 sec.
- 8 SPEAKERS**
Audio output.

Power Lock

Press MENU and VOL + buttons at the same time can lock the function of POWER button.

OSD Lock

Press VOL - and VOL + buttons at the same time can lock the function of MENU button.

Rear View of the Product

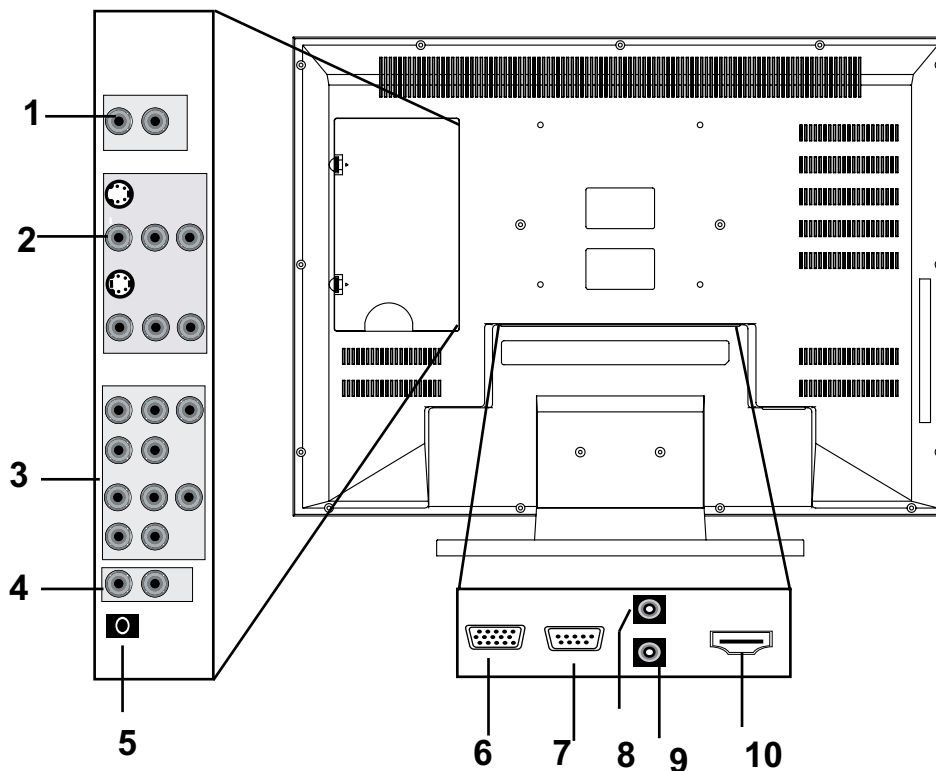

- 1 AUDIO - OUT**
Connects to the A/V device audio input.
- 2 S/AV - IN**
Connects to the audio and S-Video or AV output jack of your A/V device.
- 3 COMPONENT 1 / COMPONENT 2 IN**
Connects to the audio and component video output jacks of your A/V device.
- 4 HDMI ANALOG AUDIO - IN**
Connects HDMI ANALOG audio output of your PC computer or to A/V device.
- 5 PC Audio - IN**
Connects to the audio output (earphone jack) of your PC or portable computer.
- 6 PC - IN**
Connects to your VGA output of your PC or portable computer.
- 7 RS-232**
For manufacturer use only. Incorrect use may damage the system.
- 8 ANT**
Connects to your ATSC antenna or coaxial cable from a local TV.
- 9 CABLE - IN**
Connects to your coaxial cable a from local TV.
- 10 HDMI - IN**
Connects to your HDMI output of A/V device.

Remote Control

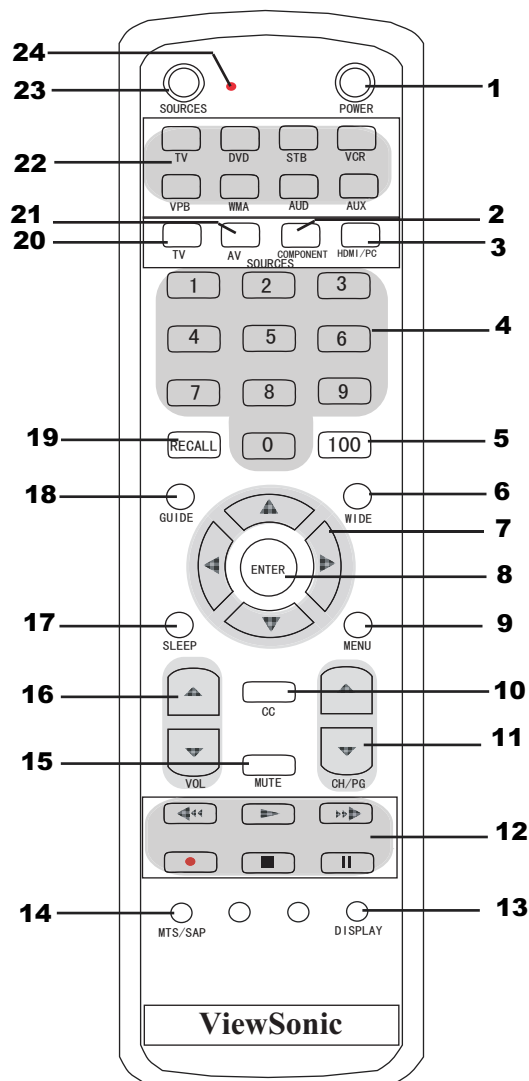

- 1 POWER**
Turns power on or off.
- 2 COMPONENT**
Switches the source to HD1/HD2 mode.
- 3 HDMI/PC**
Switches the source to HMDI/PC mode.
- 4 NUMBER KEYS**
Press the number keys to enter channel numbers.
- 5 100**
Press the key to choose a channel number higher than 100. For example, if you want to select channel 125, press 100 key first then press 2 and 5 number keys on the remote control than press enter key.
- 6 WIDE**
Switches the display mode between various wide modes.

- 7 ARROW KEYS**
Press the up, down, left, right arrow keys to scroll through the OSD menu options.
- 8 ENTER**
Press this button to execute the order you choose.
- 9 MENU**
Displays the OSD menu. Press repeatedly to view the different menu pages or exit the OSD menu.
- 10 CC**
Press to call the Closed Caption (CC) list.
- 11 CH ▲ ▼**
Increases ▲ or decreases ▼ the channel number.
- 12** (These function available on other devices)
- 13 DISPLAY**
Make sure it will display current time.
- 14 MTS/SAP**
Press to select from SAP, MONO or Stereo mode.
- 15 MUTE**
Disables the audio output.
- 16 VOL ▲ ▼**
Increases ▲ or decreases ▼ the volume.
- 17 SLEEP**
Press repeatedly to set the off timer to 10 through 240 minutes. The TV enters stand-by mode after the specified time interval.
- 18 GUIDE**
Press to display the program list of Digital TV.
- 19 RECALL**
Switches to the previously viewed channel.
- 20 TV**
Switches the source to TV mode.

21 AV

Switches the source to AV mode.

22 (These function available on other devices)

*If remote control unit does not operate, you may try press TV key to reset the setting of remote control.

23 SOURCES

Selects the TV, AV/S,HDTV,PC/HDMI inputs as the video source signal.

24 REMOTE INDICATOR LIGHT

When using remote control, the indicator light will be in red.

Notes on the Remote Control

- The remote control's effective range is 5 meters from the LCD screen at an angle of up to $\pm 30^\circ$.
- Direct light may affect the remote controls effective range.
- Avoid subjecting the remote control to shocks or vibrations.
- Avoid placing the remote control in humid and hot environments such as direct sunlight.
- Remove the batteries when not using the remote control for long periods.

Remote Control Battery Installation

Follow the steps below to insert the batteries.

- 1 Open the remote control's rear battery compartment cover.
- 2 Insert two AA batteries. Ensure that the positive and negative ends match as indicated on the bottom of the battery compartment.
- 3 Replace the battery compartment cover.

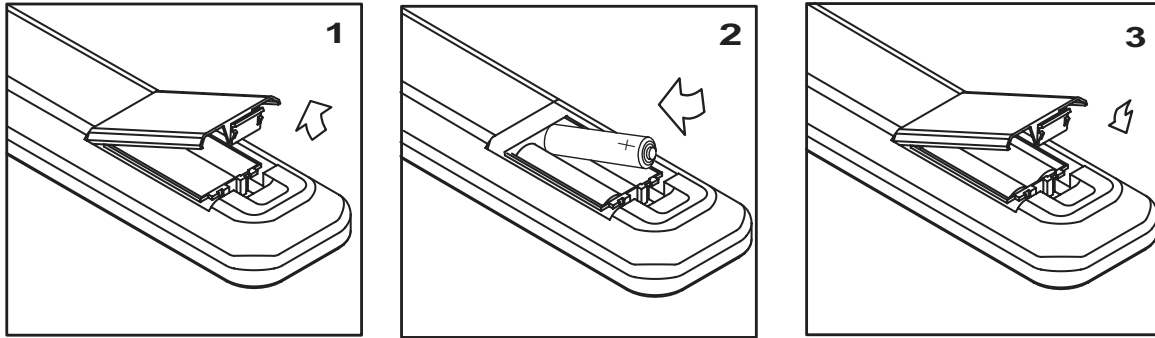

CAUTION

- Only use the specified AA batteries.
- Do not mix new and old batteries. This may result in cracking or leakage, which may pose a fire risk or lead to personal injury.
- Insert batteries according to the (+) and (-) markings. Inserting the batteries incorrectly may result in cracking or leakage, which may pose a fire risk or lead to per-sonal injury.
- Dispose of batteries in accordance with local laws and regulations.
- Keep batteries away from children and pets.
- If the remote control will not be used for an extended period of time, remove the batteries.

Cable Connections

Attach video and audio cables according to the connections on your external devices such as DVDs, VCR's, stereo systems.

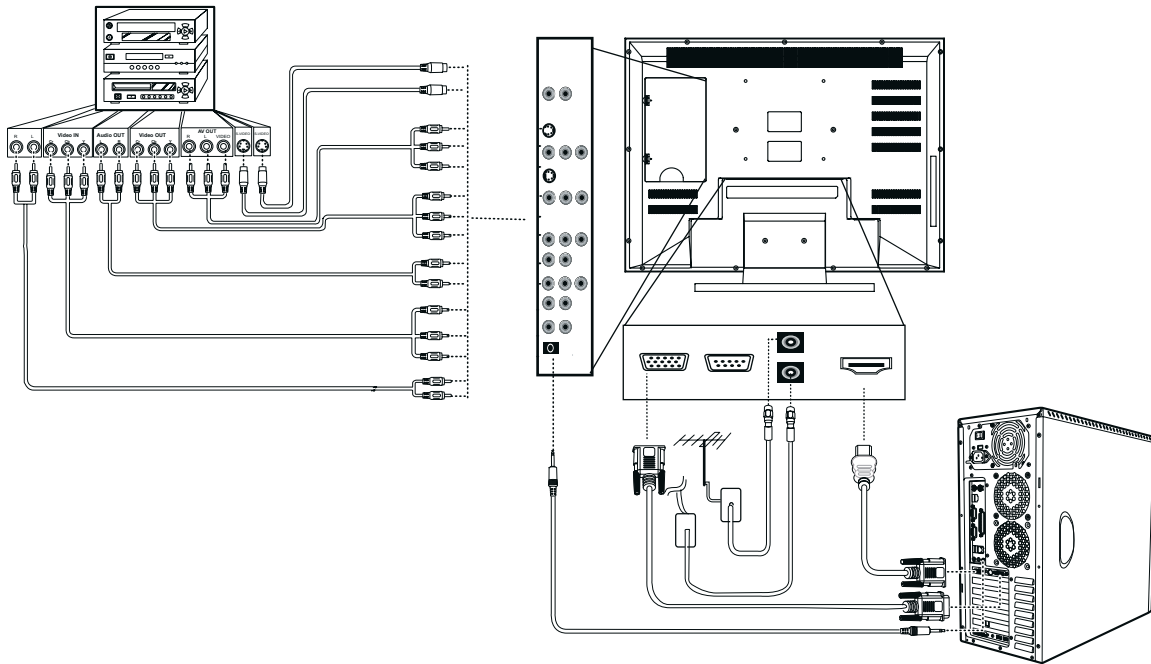

Power Cable Connection

- 1 Connect the power cable to a wall socket.
- 2 Connect the other end to the socket on the back of the LCD.

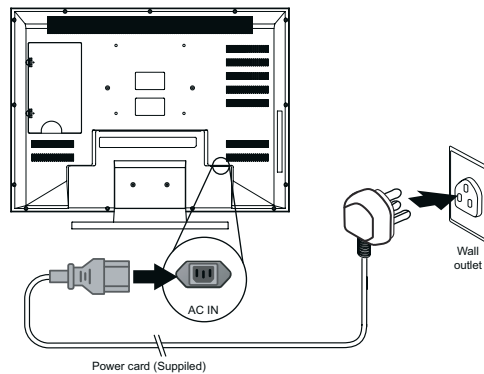

Turning the TV (Power) On

- 1 Press the power button. The power light will turn from red to green and the screen will appear after 5seconds.
- 2 Press the power button again to turn it off.

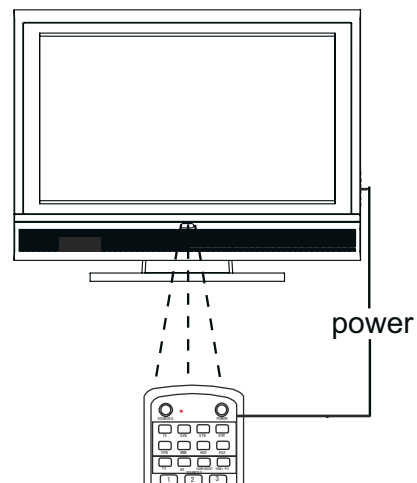

OSD Functions

All the functions for the LCD TV are controlled either by the remote control or the control buttons on the front control panel at bottom of the TV. See “Front View of the Product” on page6.

Press the **MENU** button on the remote control or the right hand side control panel to display the OSD main menu.

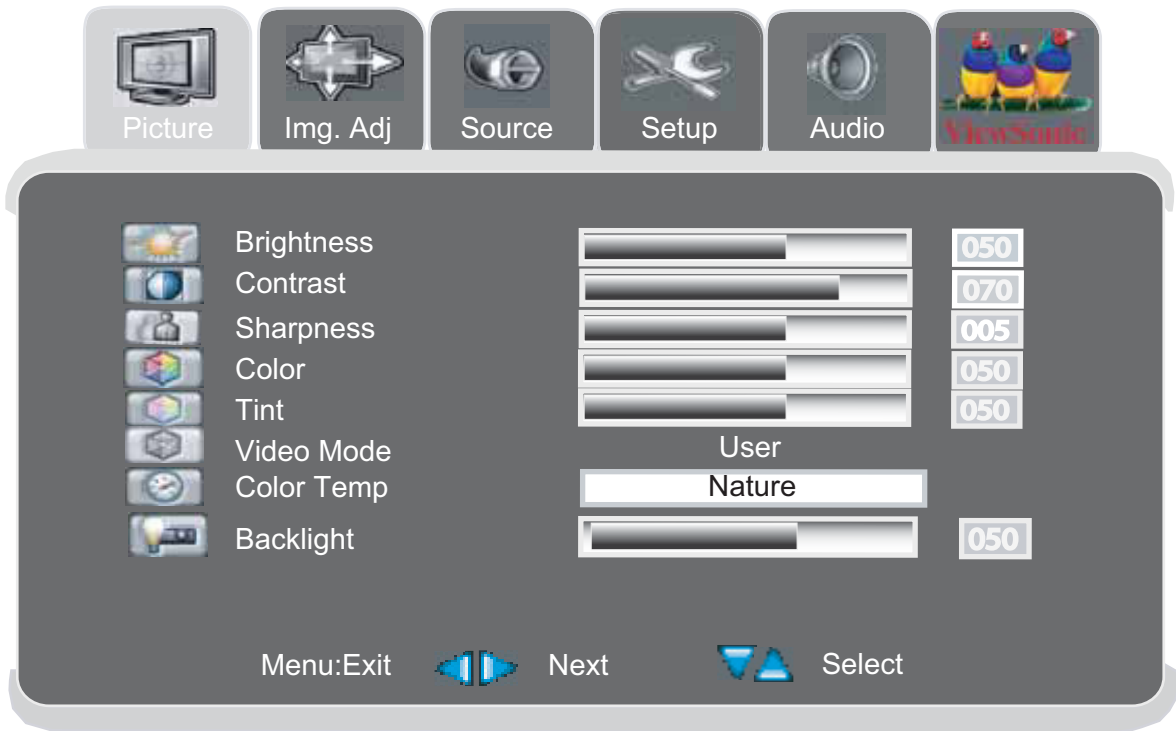

Press the **MENU** button to select the OSD menu you want.

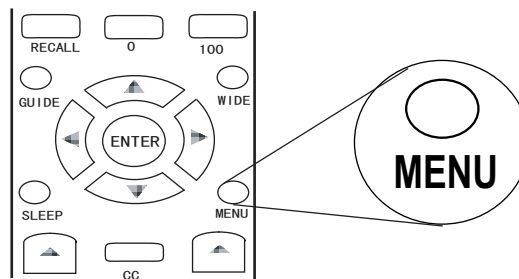

Press the **MENU** button to exit the OSD.

Picture Adjustment

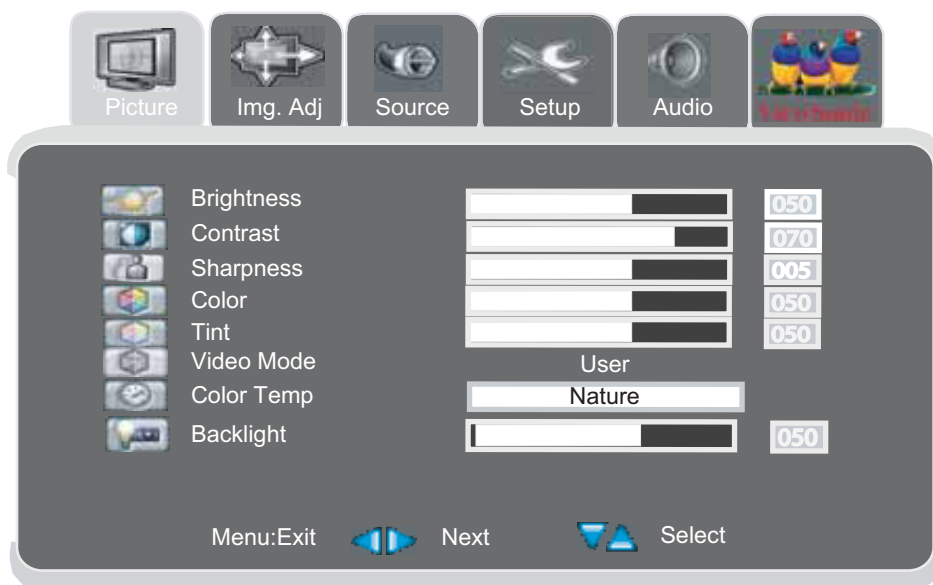

Function Name	Explanation
Brightness	Adjusts the levels of light on your screen. It should be used in conjunction with the Contrast option.
Contrast	Adjusts the light levels on your display. It should be used in conjunction with the Brightness option.
Sharpness	Adjusts the sharpness levels on your screen.
Color (No Support in PC mode)	Changes the dominant color intensity on your screen. Adjust this setting until the colors on the screen (for example, flesh tones) look natural.
Tint (No Support in PC mode)	Changes the color balance. Adjust this setting so that the colors (for example, fresh tones) on the screen are neither too green or too magenta.
Video Mode	Stores Picture settings. The following options are available: Soft: loads picture settings that result in softer colors and less sharp images. User: loads the most recent user defined settings. Preset: loads factory default settings.
Color Temp	Adjusts the image color intensity: nature, warm, cool, normal.
Backlight	Adjusts the backlight of OSD menu.
Phase	Adjusts the phase of the display.(PC mode only)
Frequency	Adjusts the Frequency of your display.(PC mode only)

Image Adjustment

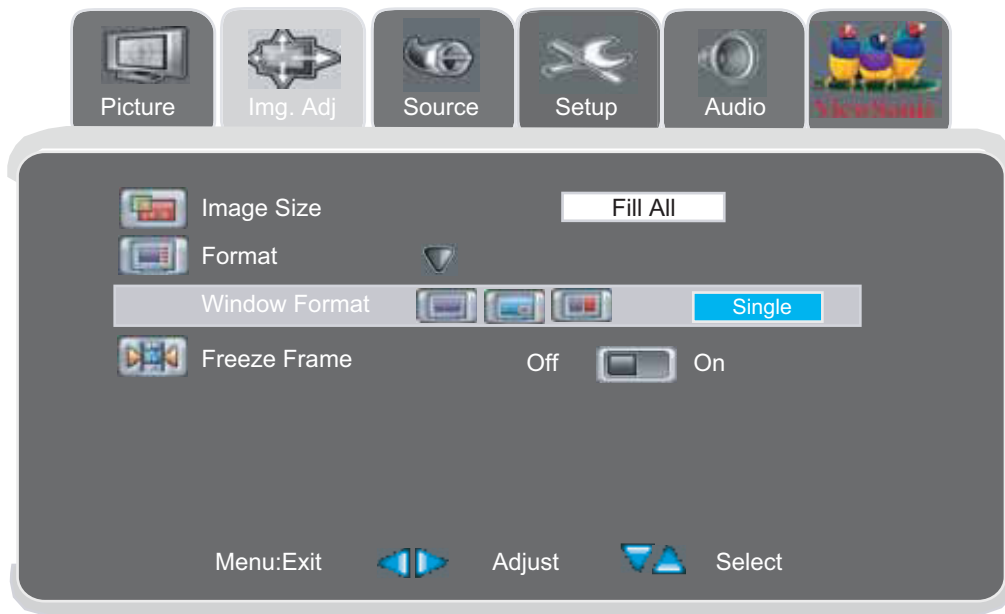

Function Name	Explanation
Image Size	Adjusts the image size include:Fill All,1 to 1, normal, wide, zoom,anamorphic. In PC mode, image size includes:Fill All ,1 to 1, Fill Aspect.
Format	Adjusts the window format in 3 mode: single, PIP, side by side.
Freeze Frame	Choose to freeze or un-freeze the frame on the screen. (Only support in PC mode)
H Position	Adjusts the horizontal position of display. (Only support in PC mode)
V Position	Adjusts the vertical position of display. (Only support in PC mode)
Auto	Auto adjusts screen to the best position. (Only support in PC mode)

Image Adjustment

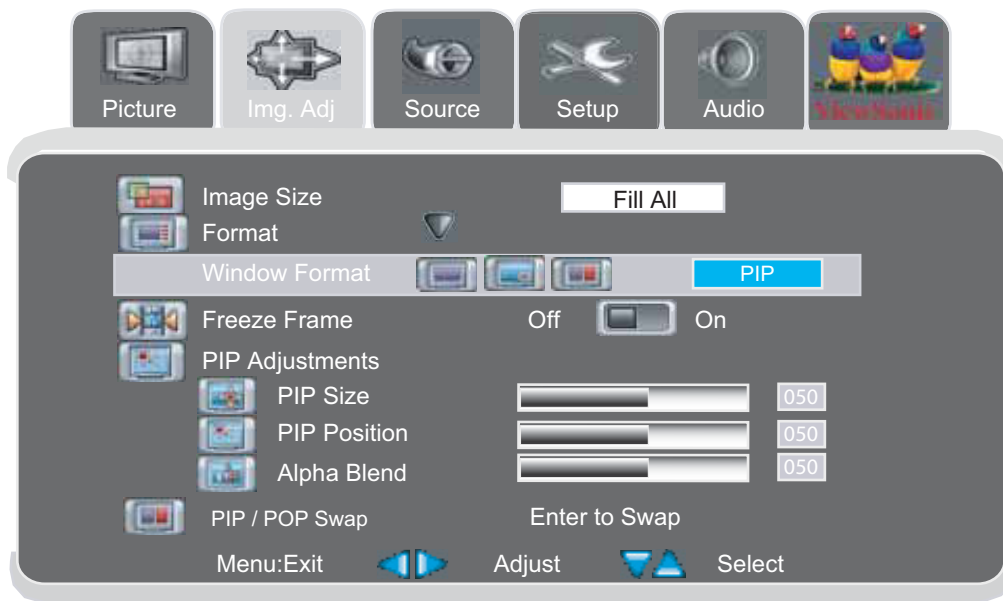

Function Name	Explanation
PIP Adjustments PIP Size PIP Position Alpha Blend (PIP mode only)	Adjust the size of sub-picture in 3 mode. Adjust the position of sub-picture: up, down, right, left. Adjust the transparency of sub-picture.
PIP / POP Swap (PIP / POP mode only)	In PIP mode, swap the position of main picture and sub-picture position. In POP mode, swap the right -side picture and left side picture position.

Note on the PIP/POP mode

- In PIP/POP mode, press ◀ ▶ keys on remote control to switch the audio source.
- Press SOURCES key or TV, AV, COMPONENT, HDMI/PC hot key on remote control to select the source of main picture.

Source Adjustment

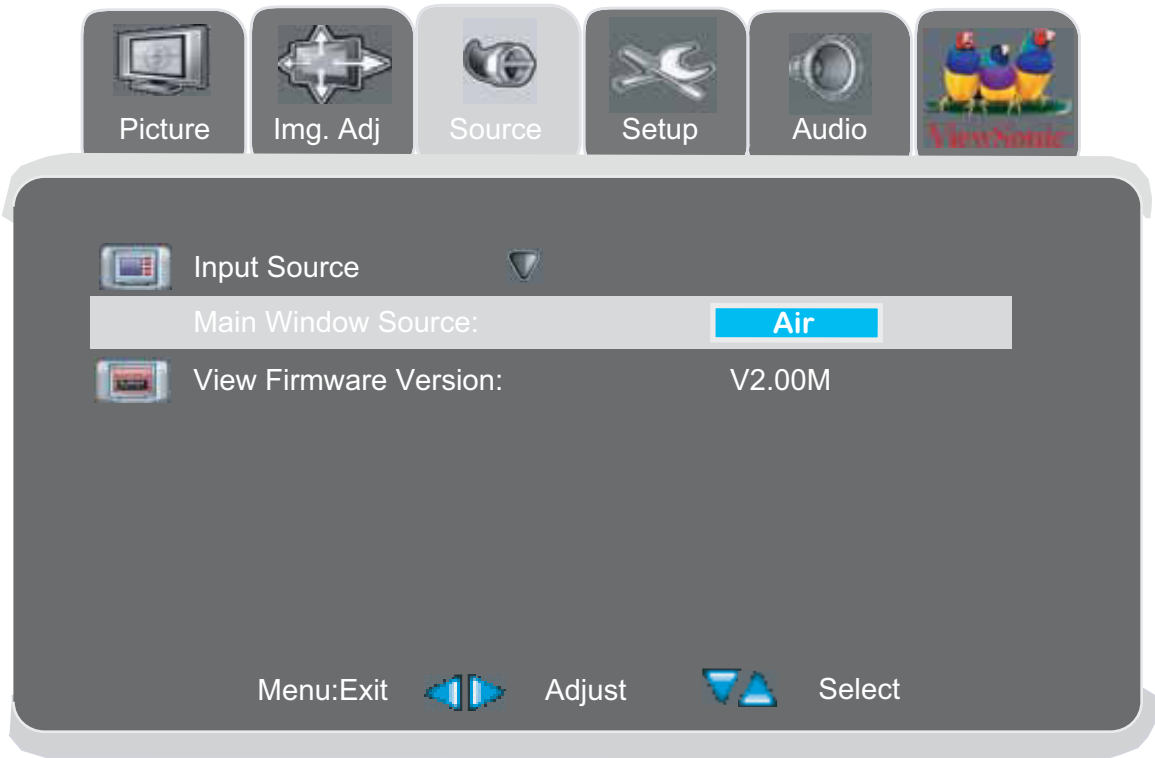

Function Name	Explanation
Input Source	Select the input source: Air, AV1, AV2, HD1, HD2, PC, HDMI.
View Firmware Version	For manufacturer use.

Setup Adjustment

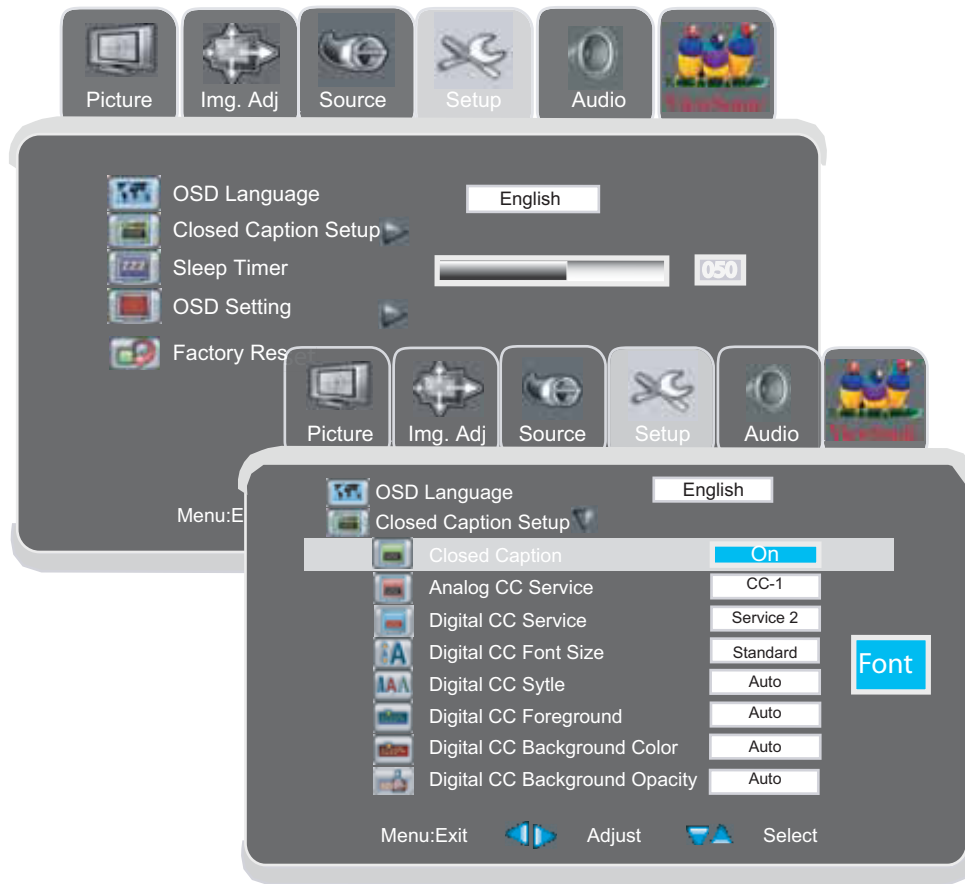

Function Name	Explanation
OSD Language	Adjust the OSD language ENGLISH, SPANISH, FRENCH
Closed Caption Setup	Adjust the setting of Closed Caption.
Closed Caption	Adjust CC ON, OFF or when mute.
Analog CC Service	Choose the analog CC service: cc1,cc2,cc3,cc4,tex1,tex2,tex3,tex4.
Digital CC Service	Choose the digital CC service: service1-6.
Digital CC Font Size	Choose the CC font: standard ,small,large,auto.
Digital CC Style	Choose the CC style mode.
Digital CC Foreground	Choose the CC foreground color: black,white,red,green,blue,yellow magenta,cyan and auto. You can see the color sample showing on a square.
Digital CC Background Color	Choose the CC background color: black,white,red,green,blue,yellow magenta,cyan and auto. You can see the color sample showing on a square.
Digital CC Background Opacity	Adjust CC background opacity mode: auto, opaque, transparent. (NO support in PC,HDMI,HD mode)
DVI Only Mode	Adjust the the screen range: Graphic (zoom in) or video (zoom out) (only in HDMI MODE)

Note: When you select sources in OSD menu, closed caption settings will be updated after exiting OSD menu.

Setup Adjustment

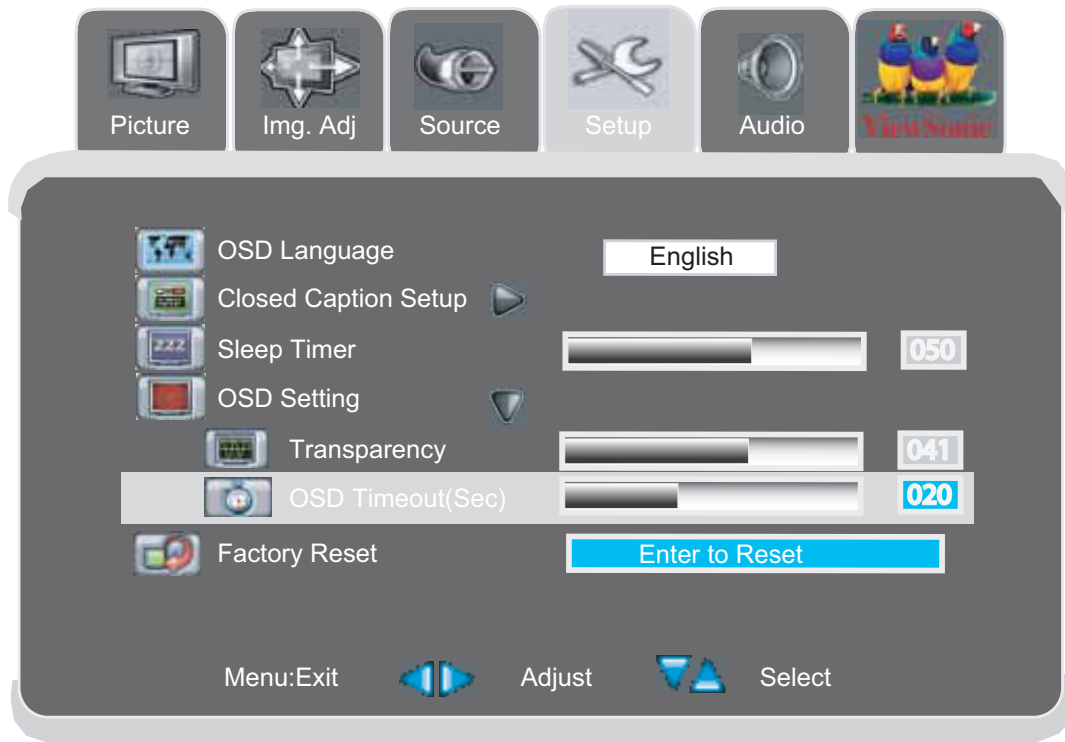

Function Name	Explanation
Sleep Timer	Enable you to set off timer to 10 through 240 min. That will elapse before the TV turns off.
OSD Setting Transparency OSD Timeout	Adjust the transparency rate of OSD background. Adjust the stay time that OSD picture stay on screen.
Factory Reset	Back to the factory settings.

Audio Adjustment

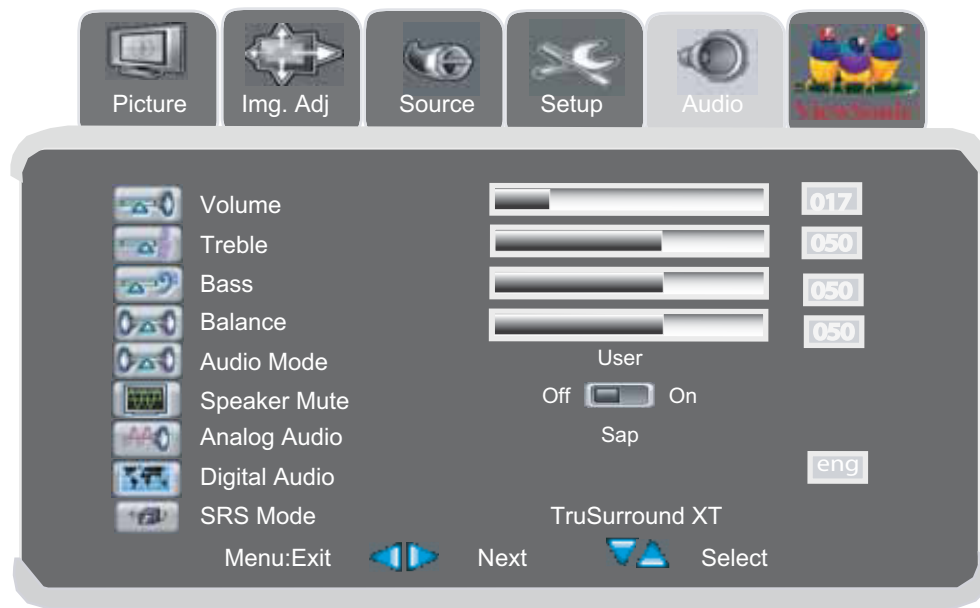

Function Name	Explanation
Volume	Adjusts the overall volume of the speakers.
Treble	Adjusts the high frequency content in the audio output.
Bass	Adjusts the low frequency content in the audio output.
Balance	Balance the volume of the left and right speakers.
Audio Mode	Stores Audio settings. The following options are available: Soft: loads audio settings that result in softer audio. User: loads the most recent user defined settings. Preset: loads factory default settings.
Speaker Mute	Disable the audio output. (when connect outside AMP)
Analog Audio	Adjusts analog audio setting items: Stereo, Sap, Mono.
Digital Audio	Show the language of digital audio.
SRS Mode	Switches SRS function on (TruSurround XT) or off.
HDMI Audio Source	Select the source in HDMI mode: HDMI,DVI and Auto. (HDMI mode only)

Tuner Adjustment

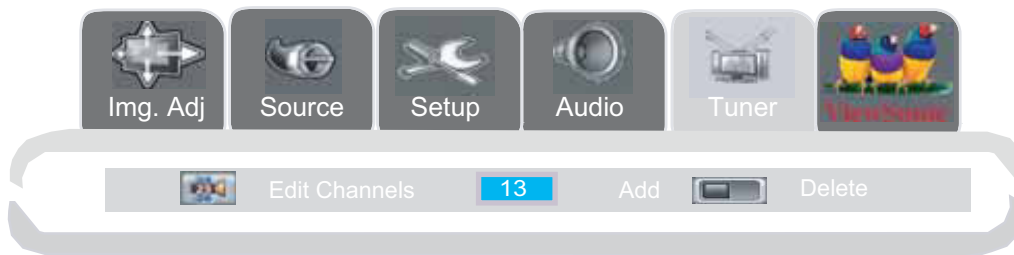
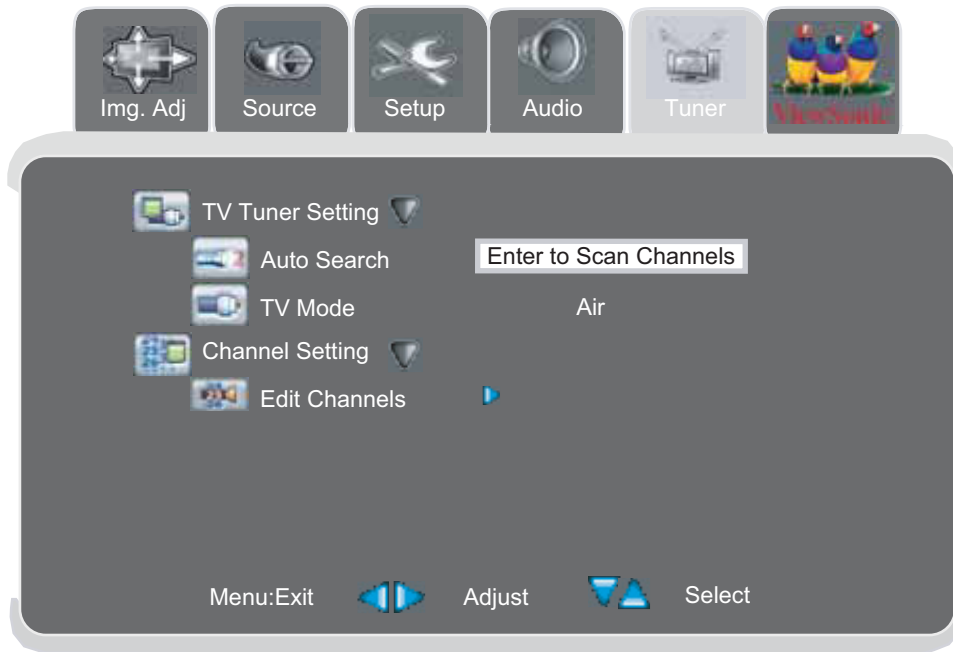

Function Name	Explanation
TV Tuner Setting Auto Search TV Mode	Auto scan and record the ANT or cable channels Select the tuner source : air, cable.
Channel Setting	You can add or delete the channel in your channel list. Choosing a channel by ▲ ▼ key or CH button and press ◀▶ key to add or delete channel.

* TV mode only

V-Chip Adjustment

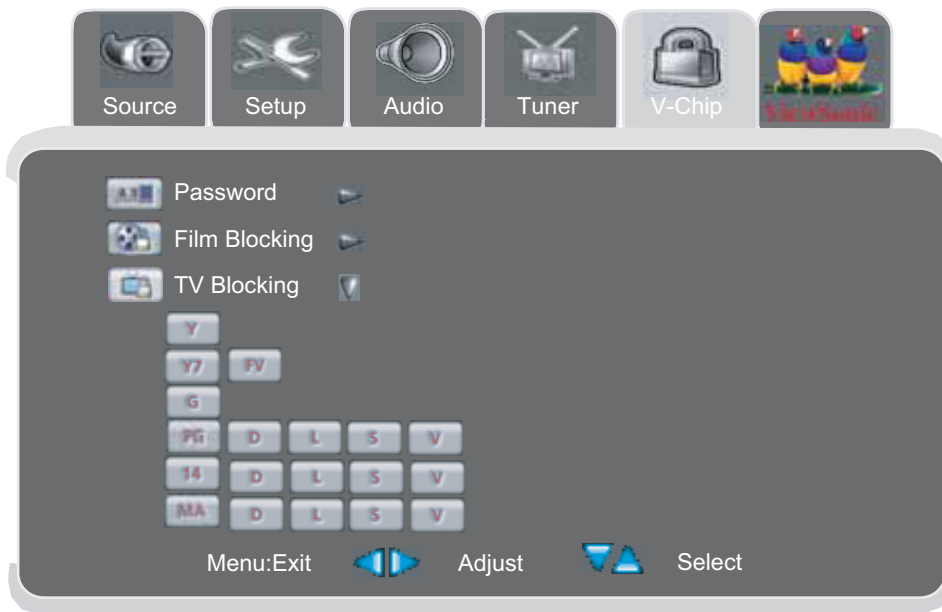
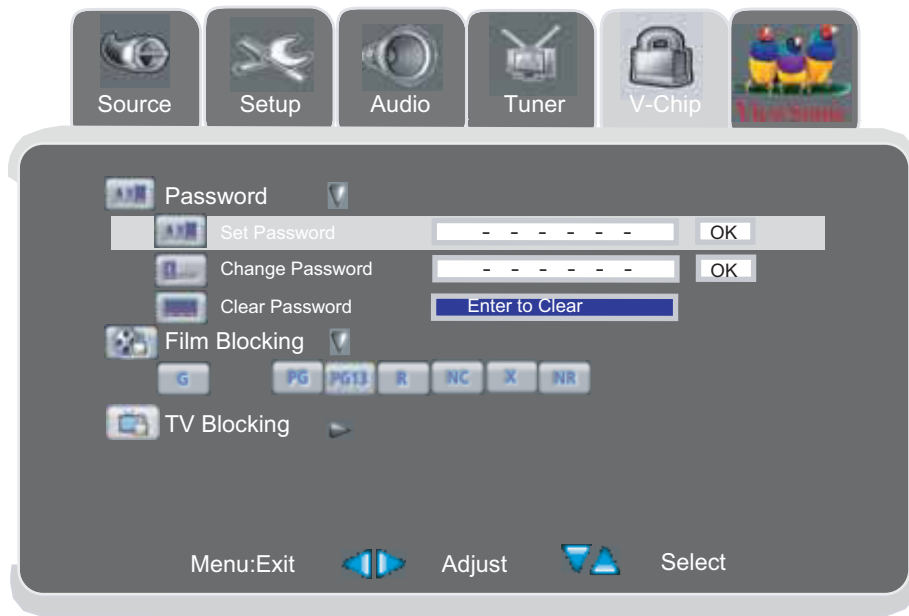

Function Name	Explanation
Password	Access to parental control feature, you have to enter password. Factory default password is "000000". You may change or clear password. Select channel you want to block and choose the rate by arrow keys then press enter to setting. Blocked channels will not be output on screen. (No support in HDMI and PC mode)

V-chip Adjustment

MPAA Rating	Explanation
G (GENERAL AUDIENCES)	Suitable for all ages.
PG (PARENTAL GUIDANCE SUGGESTED)	Some material may not be suitable for children.
PG-13 (PARENTAL STRONGLY CAUTIONED)	Some material may be inappropriate for children under 13.
R (RESTRICTED)	Children under 17 are required to be accompanied by their parents or adult guardians.
NC-17	No-one 17 and under admitted.
X	X is an older rating that is unified with NC-17, but may be included in the data of older movies.
NR	Movies unrating.

TV Guideline	Explanation
TV-Y	ALL Children (This program is appropriate for all children)
TV-Y7	Directed at older children (This program is designed for children aged 7 and above. Note: For those programs where fantasy violence may be more intense or more combative than other programs in this category, such programs will be designated TV-Y7-FV.)
TV-G	General Audience (this program is suitable for all ages.)
TV-PG	Parental Guidance Suggested (This program contains material that maybe not suitable for younger children.) D) Some suggestive dialog. L) Infrequent coarse language S) Some sexual situations V) Moderate violence
TV-14	Parents Strongly Cautioned (This program contains material that are not suitable for children under 14 years of age.) D) Intense suggestive dialog L) Strong coarse language S) Intense sexual situations V) Intense violence
TV-MA	Mature Audience Only (This program contains scenes that are not suitable for children under 17.) L) Explicit sexual situations S) Graphic violence

Appendix

Specifications

Panel	Type	32" (full 31.5" viewable diagonal area) 37" (full 37.02" viewable diagonal area) 40" (full 39.9" viewable diagonal area) Active Matrix Wide-XGA, 1360 x 768
Viewing angles		32" 170° (H) / 170° (V) 37" 176° (H) / 176° (V) 40" 170° (H) / 170° (V)
Channel Capablility	ATSC/NTSC	VHF/UHF: 2-69 (ATSC/NTSC) CATV : 1-125 (NTSC)
Connection Terminals	TV	AIR IN VHF/UHF: 2-69 (ATSC/NTSC) CATV: 1-125 (NTSC)
	S/AV	Video IN x 2 S-Video IN x 2 (S jack has priority when S-jack and Video-jack plug in at the same time) Audio IN x 2
	COMPONENT	COMPONENT Video x 2 (YCbCr/YPbPr)(support 480i, 480P, 720P, 1080i) Audio IN x 2
	PC	VGA IN x 1 Audio IN x 1 (3.5mm Jack)
	HDMI	HDMI x 1
	Audio Out	Audio IN x 1 (For HDMI Analog Audio) Analog Audio Out x 1
Compatibility	Mode	Compatible Inputs
	720 x 400 @ 70 Hz	PC, HDMI
	640 x 480 @ 60/75 Hz	PC, HDMI
	800 x 600 @ 60/75 Hz(VESA)	PC, HDMI
	832 x 624 @ 75 Hz (Mac)	PC, HDMI
	1024 x 768 @ 60/75 Hz(VESA)	PC, HDMI
	1280 x 720 @ 60 Hz	PC, HDMI
	1280 x 768 @ 60 Hz(VESA)	PC, HDMI
	1280 x 1024 @ 60 Hz(VESA)	PC, HDMI
	1360 x 768 @ 60 Hz	PC
	480 I 60 Hz(NTSC)	AV/S,HD
	480 P 60 Hz(DVD)	PC, HDMI
	720 P 50/60 Hz	PC, HDMI
	1080 I 50/60 Hz	PC, HDMI
Speaker Output		10 W + 10 W
Power	Voltage	100-240 VAC, 50/60 Hz 32" : 190W(MAXIMUN) 37" : 220W(MAXIMUN) 40" : 260W(MAXIMUN)
Operating conditions	Temperature	0°C to 40°C (32°F to 104°F)
	Humidity	10% to 90% (no condensation)
	Altitude	To 3000 meters

Storage conditions	Temperature	-20°C to 60°C (-4°F to 140°F)
	Humidity	10% to 90% (no condensation)
	Altitude	To 12,000 meters
Dimensions	Physical	32" : 820 mm (W) x 650 mm (H) x 230 mm (D) 32.3" (W) x 25.6" (H) x 9.1" (D)
		37" : 960 mm (W) x 730 mm (H) x 280 mm (D) 37.8" (W) x 28.7" (H) x 11" (D)
		40" : 1015 mm (W) x 755 mm (H) x 280 mm (D) 40.0" (W) x 29.7" (H) x 11" (D)
	Package	32" : 960 mm (W) x 780 mm (H) x 320 mm (D) 37.8" (W) x 30.7" (H) x 12.6" (D)
		37" : 1130 mm (W) x 870 mm (H) x 370 mm (D) 44.5" (W) x 34.3" (H) x 14.6" (D)
		40" : 1145 mm (W) x 910 mm (H) x 370 mm (D) 45.1" (W) x 35.8" (H) x 14.6" (D)
Weight	Net	32" : 22 kg (48.5 lb.)
		37" : 31 kg (68.3 lb.)
		40" : 33 kg (72.7 lb.)
	Gross	32" : 26.5 kg (58.4 lb.)
		37" : 38.5 kg (84.9 lb.)
		40" : 40.0 kg (88.1 lb.)
Regulations	FCC-B, c-UL, CB, NOM	
Power saving modes	Stand by	<1.5 W

Preset Timing Mode (Pre-adjusted to VESA 1360 x 768 at 60 Hz)

Warning : Do not set the graphics card in your computer to exceed these refresh rates. Doing so may result in permanent damage to the LCD.

Note : Product specifications are subject to change without notice.

Troubleshooting

No power

- Make sure the LCD is properly connected. (see also pages 12)
- Make sure the AC power cord is properly connected. (see also page 12)
- Make sure the AC power is ON, DC power button is ON (Green LED).
- Plug another electrical device (like a radio) to the power outlet to verify that the outlet is supplying the proper voltage.

Poor or no picture

- The TV station may be experiencing problems. Try another channel.
- The Cable TV signal may be scrambled or encoded. Please contact your local cable operator.
- Make sure that connection to other components are correct. (see also pages 12)
- Make sure that setup has been done correctly after connections. (see also pages 14-19)
- Make sure the correct input is selected and the input signal is compatible.

Strange color, light color, or color misalignment

- Ensure that the video cable is securely connected.
- The picture may appear dim in a brightly lit room.
- Adjust brightness and contrast.
- Check the input signal setting.

No sound

- Check your audio connections
- The **MUTE** button may have been pressed, try pressing this button again.
- Check your audio settings, your TV audio may be set to minimum.
- Press the **Volume + (Up)** button on the remote control.

Remote control unit does not operate

- Make sure batteries are inserted correctly. (see also page 11)
- Batteries could be weak or dead. Replace batteries.
- Is a fluorescent light illuminated near the remote control sensor?
- The path of the remote control beam may be blocked. Make sure the path is clear and that the remote control is aimed at the remote control sensor on the TV.
- Press only one button at a time and it is the correct one for the operation you want to perform..

Unit cannot be operated

- External influences such as lightning or static electricity may cause improper operation. In this case, operate the unit after first turning on the power of the LCD and the AVC System, or unplug the AC cord for 1 to 2 minutes, then replug again.

Power is cut off suddenly

- Is the sleep timer set? (see also page 19)
- The internal temperature of the unit has increased. Remove any objects blocking the vent or clean as necessary.

No CATV reception (or no reception above CH13)

- Is the AIR/CABLE option set correctly? Please set the AIR/CABLE option to CABLE.
- CATV is connected improperly or not connected; please check all the CATV connections.
- The cable TV service is interrupted; please contact your cable operator.

Picture is cut off/with sidebar screen

- Is the image positioned correctly?
- Are screen mode adjustments such as picture size set correctly?

Customer Support

For technical support or product service, see the table below or contact your reseller.

Note: You will need the product serial number.

Country/ Region	Web Site	T=Telephone
United States	www.viewsonic.com	800 688 6688
Canada	www.viewsonic.com	866 463 4775
Latin America	www.viewsonic.com/la	909 444 8800

Limited Warranty

VIEWSONIC® LCD TV

What the warranty covers:

ViewSonic® warrants its products to be free from defects in material and workmanship, under normal use, during the warranty period. If a product proves to be defective in material or workmanship during the warranty period, ViewSonic® will at its sole option repair or replace the product with a like product. Replacement product or parts may include remanufactured or refurbished parts or components.

How long the warranty is effective:

ViewSonic® LCD TV's are warranted for one (1) year for all parts excluding the light source and one (1) year for labor from the date of the first customer purchase.

Who the warranty protects:

This warranty is valid only for the first consumer purchaser.

What the warranty does not cover:

1. Any product on which the serial number has been defaced, modified or removed.
2. Damage, deterioration or malfunction resulting from:
 - a. Accident, misuse, neglect, fire, water, lightning, or other acts of nature, unauthorized product modification, or failure to follow instructions supplied with the product.
 - b. Repair or attempted repair by anyone not authorized by ViewSonic®.
 - c. Any damage of the product due to shipment.
 - d. Removal or installation of the product.
 - e. Causes external to the product, such as electric power fluctuations or failure.
 - f. Use of supplies or parts not meeting ViewSonic's specifications.
 - g. Normal wear and tear.
 - h. Any other cause which does not relate to a product defect.
3. Any product exhibiting a condition commonly known as "image burn-in" which results when a static image is displayed on the product for an extended period of time.
4. Removal, installation, and set-up service charges.

How to get service:

1. For information about receiving service under warranty, contact ViewSonic® Customer Support at 800-888-8583. You will need to provide your product's serial number.
2. To obtain warranted service, you will be required to provide (a) the original dated sales slip, (b) your name, (c) your address, (d) a description of the problem, and (e) the serial number of the product.
3. Take or ship the product freight prepaid in the original container to an authorized ViewSonic® service center or ViewSonic®.
4. For additional information or the name of the nearest ViewSonic® service center, contact ViewSonic®.

Limitation of implied warranties:

There are no warranties, express or implied, which extend beyond the description contained herein including the implied warranty of merchantability and fitness for a particular purpose.

Exclusion of damages:

ViewSonic's liability is limited to the cost of repair or replacement of the product. ViewSonic® shall not be liable for:

1. Damage to other property caused by any defects in the product, damages based upon inconvenience, loss of use of the product, loss of time, loss of profits, loss of business opportunity, loss of goodwill, interference with business relationships, or other commercial loss, even if advised of the possibility of such damages.
2. Any other damages, whether incidental, consequential or otherwise.
3. Any claim against the customer by any other party.

Effect of state law:

This warranty gives you specific legal rights, and you may also have other rights which vary from state to state. Some states do not allow limitations on implied warranties and/or do not allow the exclusion of incidental or consequential damages, so the above limitations and exclusions may not apply to you.

Sales outside the U.S.A. and Canada:

For warranty information and service on ViewSonic® products sold outside of the U.S.A. and Canada, contact ViewSonic® or your local ViewSonic® dealer.



ViewSonic®

Free Manuals Download Website

<http://myh66.com>

<http://usermanuals.us>

<http://www.somanuals.com>

<http://www.4manuals.cc>

<http://www.manual-lib.com>

<http://www.404manual.com>

<http://www.luxmanual.com>

<http://aubethermostatmanual.com>

Golf course search by state

<http://golfingnear.com>

Email search by domain

<http://emailbydomain.com>

Auto manuals search

<http://auto.somanuals.com>

TV manuals search

<http://tv.somanuals.com>