

User Guide

ND4200/ND5000

Network Display



Copyright © ViewSonic Corporation, 2006. All rights reserved.

ViewSonic and the three birds logo are registered trademarks of ViewSonic Corporation.

Tivella and the Tivella logo are trademarks of Tivella, Inc.

Cisco is a registered trademark and this document may include service marks of Cisco Systems, Inc. and/or its affiliates in the U.S. and other countries.

Corporate names and trademarks are the property of their respective companies.

Disclaimer: ViewSonic Corporation shall not be liable for technical or editorial errors or omissions contained herein; nor for incidental or consequential damages resulting from furnishing this material, or the performance or use of this product.

In the interest of continuing product improvement, ViewSonic Corporation reserves the right to change product specifications without notice. Information in this document may change without notice.

No part of this document may be copied, reproduced, or transmitted by any means, for any purpose without prior written permission from ViewSonic Corporation.

Product Registration

To meet your future needs, and to receive any additional product information as it becomes available, please register your product on the Internet at: **www.viewsonic.com**. The **ViewSonic** product also comes with a CD-ROM that has a registration form that you can print and mail or fax to **ViewSonic Corporation**.

| For Your Records | |
|------------------|----------------------------|
| Model Name: | ND4200 |
| Model Name: | ND5000 |
| Model Number: | VS10713 for ND4200 |
| Model Number: | VS10714 for ND5000 |
| Document Number: | ND4200/ND5000_UG_ENG_Rev1A |
| Serial Number: | _____ |
| Purchase Date: | _____ |
| | 11 May 2006 |

Product disposal at end of product life

ViewSonic is concerned about the preservation of our environment. Please dispose of this product properly at the end of its useful life. Your local waste disposal company may provide information about proper disposal.

Contents

INTRODUCTION

| | |
|----------------------------------|---|
| Packaged Contents | 1 |
| Optional Accessories | 1 |
| Requirements | 1 |
| Two Modes of Operation | 2 |
| Two Modes of Communication | 3 |
| Features | 3 |
| Front View | 4 |
| Back View | 5 |
| Side View | 5 |
| Remote Control | 6 |

SETTING UP THE NETWORK DISPLAY

| | |
|--|----|
| Connect to a Switch or Router | 7 |
| Connect External Speakers (optional) | 9 |
| Turn Power On to the Network Display | 9 |
| Login | 10 |

MANAGEMENT

| | |
|--|----|
| Startup URLs/Network Configuration | 11 |
| Browser Configuration | 12 |
| VNC client | 14 |
| Video/Audio Configuration | 15 |
| TAS Configuration | 16 |
| System Services Configuration | 17 |
| FTP server | 18 |

ACTIONS

| | |
|-----------------------|----|
| Video Multicast | 19 |
| Video HTTP | 20 |
| Playlist | 21 |
| VNC client | 22 |
| Transparency | 23 |
| Go to URL | 24 |

ADMINISTRATION

| | |
|------------------------------------|----|
| Advanced Video Configuration | 25 |
| Security | 26 |
| Save Configuration | 27 |
| Default Settings | 27 |
| Reboot | 28 |
| Firmware Upgrade | 28 |

HELP

| | |
|---------------|----|
| Status | 29 |
| License | 30 |
| About | 30 |

APPENDIX

| | |
|------------------------|----|
| Screens | 31 |
| Customer Support | 33 |
| FCC Information | 34 |
| Specifications | 35 |
| Limited Warranty | 36 |

INTRODUCTION

Thank you for buying the **ViewSonic® Network Display**. This section introduces you to the **ND4200/ND5000 Network Display**.

Packaged Contents

Please check that all the following items are in the package:



ND4200/ND5000 Network Display



ViewSonic CD

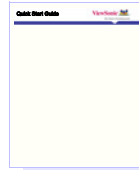

Quick Start Guide



**Remote Control
with two AA batteries**

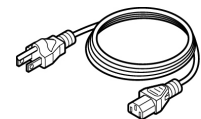

AC Power Cord

Optional Accessories

The accessories listed below are available at viewsonic.com

- USB Wi-Fi adapter
- Wall mount kit
- Detachable speakers

Requirements

The **ND4200/ND5000 Network Display** requires:

- **ViewSonic ND4200/ND5000 Network Display** connected to AC power and a network or internet connection
- Streaming video server and/or live encoder
- Wireless network connection if using the **ND4200/ND5000** wireless support option

Two Modes of Operation

Standalone

The setup allows the **ND4200/ND5000 Network Display** to act as an independent network device controlled by one server.

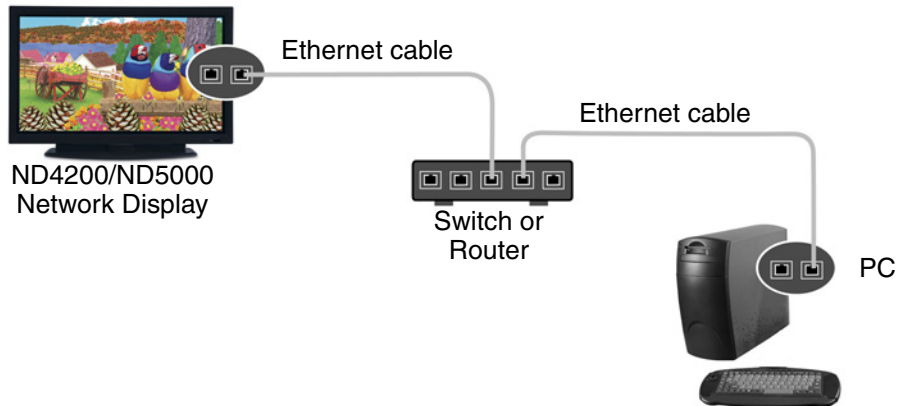

TAS Managed

You can purchase Tivella Administration Server (TAS) separately through Tivella (www.tivella.com or a Tivella dealer/reseller). A TAS server should be used to configure and manage multiple **Network Displays** remotely. TAS provides centralized scheduling of video content presentation on multiple **Network Displays**, as well as management and seamless operation of a Cisco® ACNS Content Distribution Networking infrastructure if one is installed. This configuration greatly reduces maintenance overhead, when TAS and the **Network Display** are connected to the network (LAN/WAN) with the TAS acting as a manager for multiple **Network Displays**.

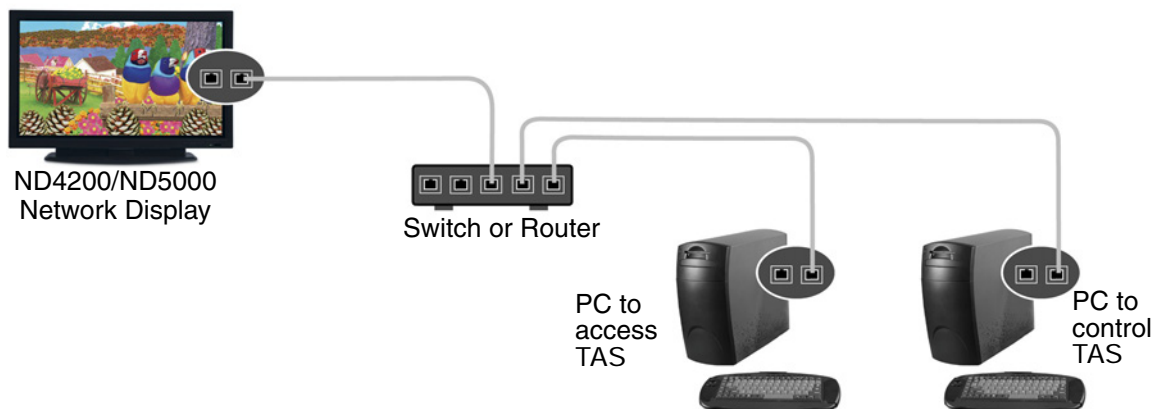

Two Modes of Communication

There are two modes of communication with the **ND4200/ND5000 Network Display**: an HTTP web interface and a Telnet advanced command line interface. This document focuses on the web interface only.

Features

- Bright plasma type display ideal for advertisement and video playback
- Integrated display for A/V IP delivery
- Multiple **Network Displays** can be daisy chained with different IP addresses
- Supports scheduling of different video content across multiple displays
- No need for additional external PC or set-top box with a switch
- Remote management control and status reporting
- MPEG A/V decoding, MPEG 1/2/4, WMV9, Macromedia Flash
- Auto-MDIX (no crossover cabling)
- Powerful combination of the Sigma Design® EM8621L and the Freescale® MPC8247 for smooth playback
- Can be installed with an optional wall mount
- Uses Tivella® content management software
- Devices can be remotely controlled from virtually anywhere with a network or internet connection
- Wireless Ethernet support eliminates the need to run cables to an existing network
- Remote management allows you to adjust the screen and see valuable information without being physically in front of the unit
- Network ready, easy installation
- Optional local content buffering or storing in CF card

Front View

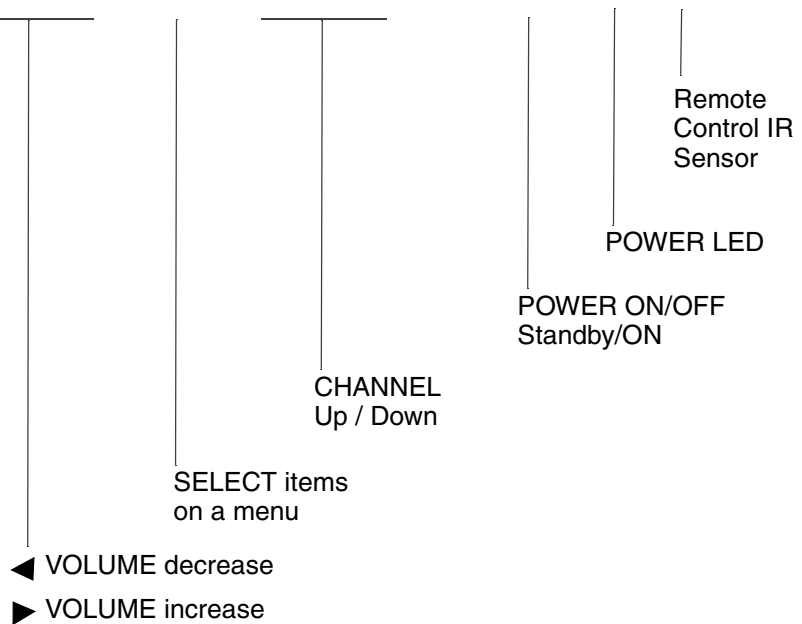
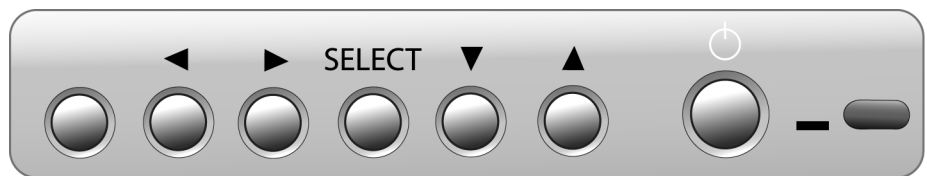
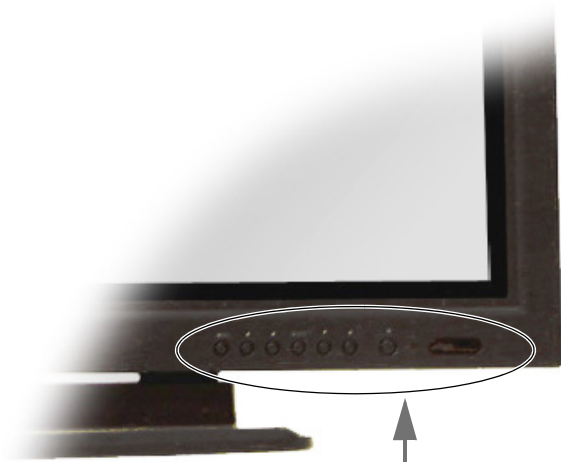

Back View

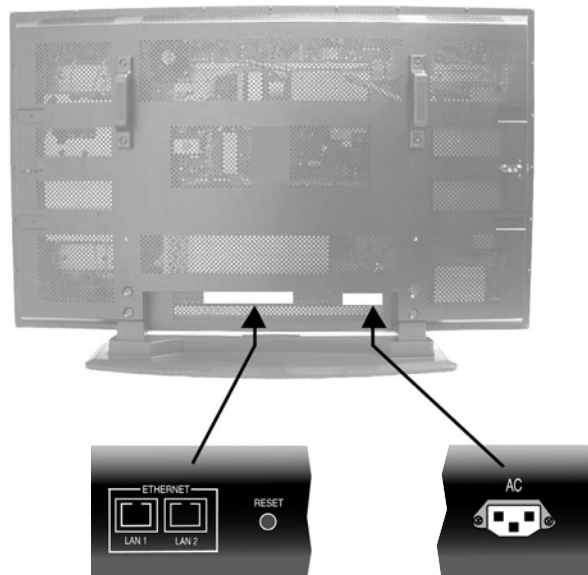

Side View

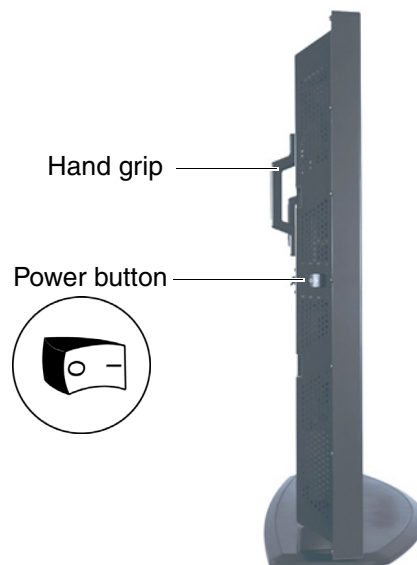

Remote Control



SETTING UP THE NETWORK DISPLAY

1. Connect to a Switch or Router

Connect an RJ-45 Ethernet cable from the **Network Display** to either a switch or a router. See your IT Administrator for a code to the switch or a router. The Router shown is a **ViewSonic WMG100**. Connect the AC power cord from the **Network Display** to an AC power source like a wall outlet.

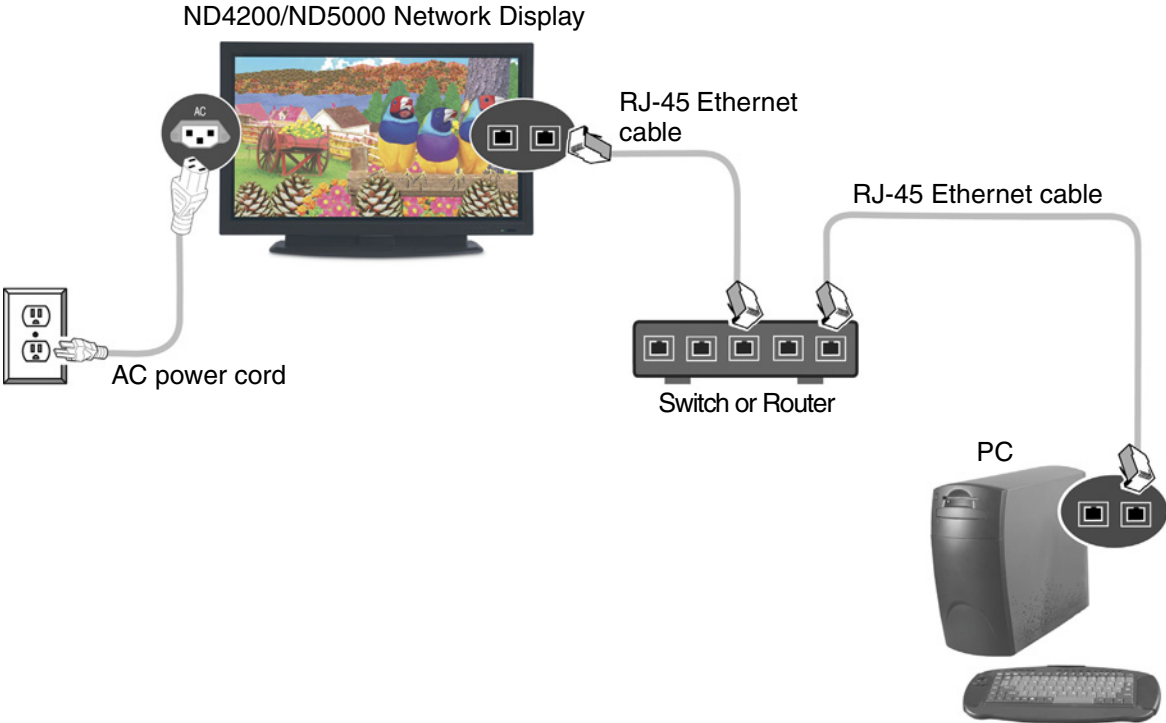

Connect Multiple Network Displays (optional)

You can daisy chain several **Network Displays** together. The two built-in Ethernet ports make the **ViewSonic Network Displays** unique because you do not need separate network switches or PCs for each **Network Display**. Media content on each **Network Display** can be scheduled independently when connected to an external server.



Plug another RJ-45 Ethernet cable into an Ethernet port of another **Network Display**. You can connect either of the two Ethernet ports of one unit to either of the two Ethernet ports of another unit.

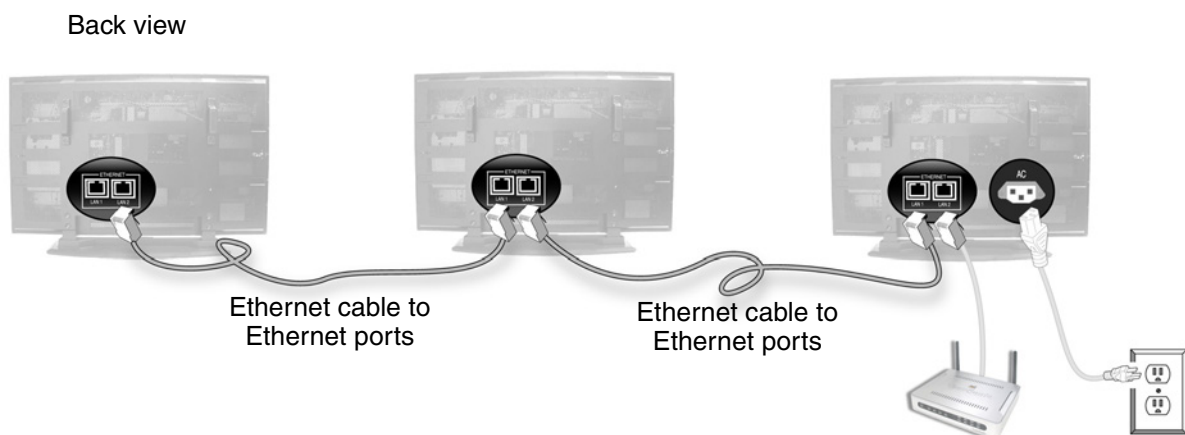

2. Connect External Speakers (optional)

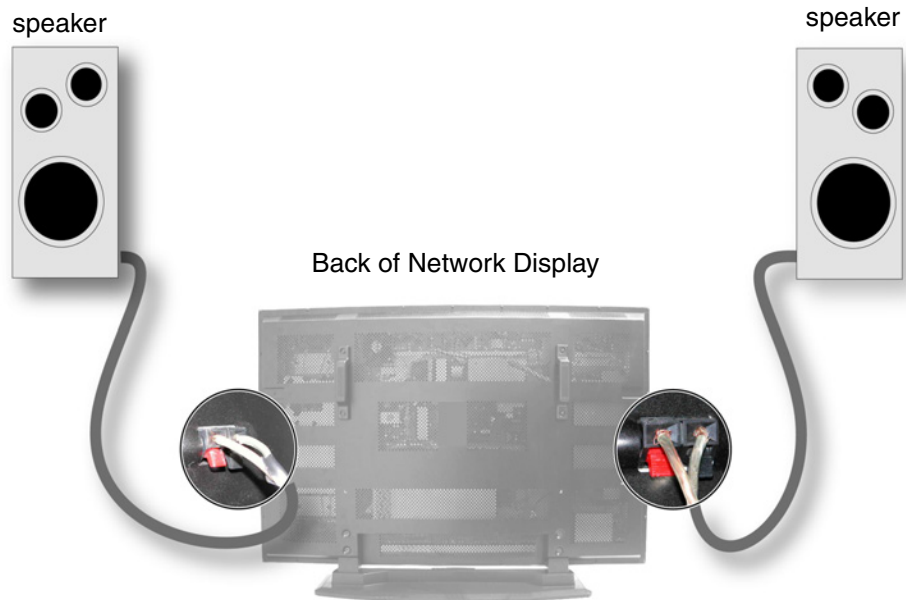

3. Turn Power On to the Network Display

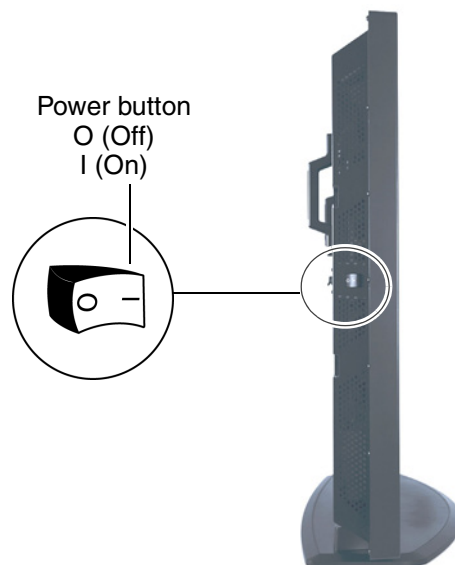

Put Batteries in Remote Control

Remove the back cover from the remote control as shown below. Put two AA batteries in the remote control. Be sure to match the positive end of the battery with the positive end of the compartment. Put the cover back on the remote control.

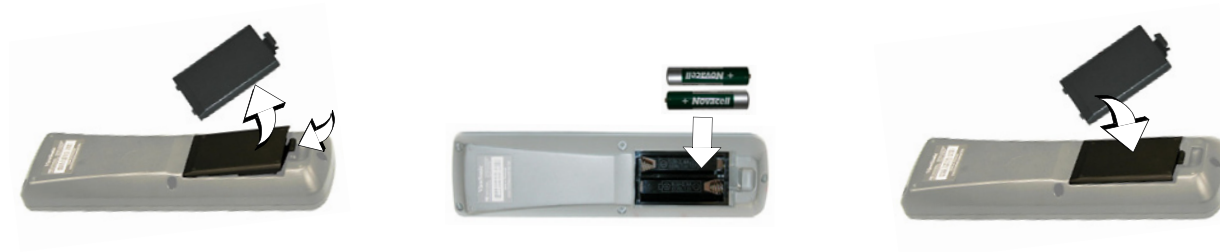

4. Login

Open an Internet Browser, i.e., **Internet Explorer**. In the **URL address field**, type in the default IP address of the **ND4200/ND5000** (192.168.12.100) > press **Enter**. A prompt appears asking for a **User Name** and **Password**. The default name admin and the password admin automatically appear in the corresponding fields > click **OK**. The **Network Configuration** screen appears as shown on the next page. **Note: The Network Display** logs you out after five minutes of inactivity.

For security purposes, we recommend that you change the default IP address, **Login** and **Password**. *For more information, see the **Security** section in this user guide.*

After logging in successfully, the **Network Configuration** screen appears as shown on the next page. **Note: The ND4200/ND5000** automatically logs you out after five minutes of inactivity.

For information on how to change network settings on an OS other than Windows, please consult the OS user guide or your Network Administrator.

MANAGEMENT

Startup URLs/Network Configuration

The **Network Configuration** screen allows you to select the video that appears on-screen when you boot up the **NMP-500**. To go to the **Network Configuration** screen after logging into the **NMP-500**, select **Management > Startup**. The **Startup URLs** screen and the **Network Configuration** screen appears as shown below.

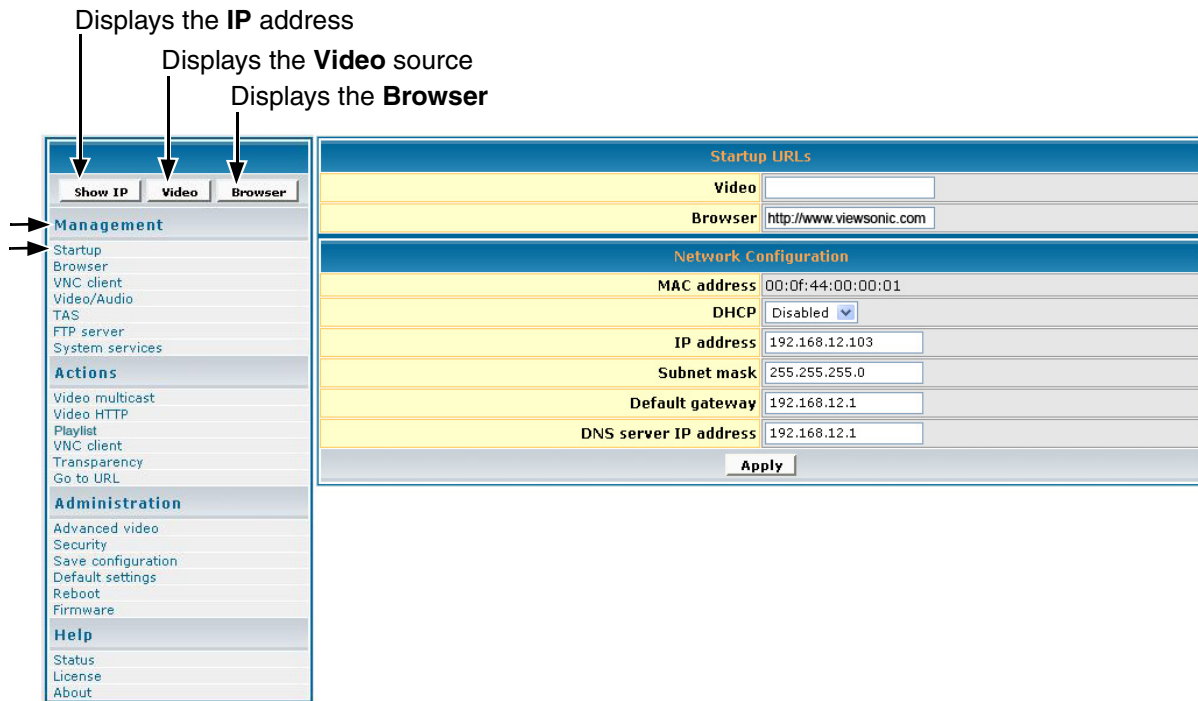

- 1 To play a particular video at startup, in the **Video** field, enter a valid HTML page. Here are some examples:
 - **http://<ip-address->/<mpeg-1/2-file-located on WEB Server>**
 - **udp://<ip-multicast-address>/port**
 - **rtp://<multicast-address>/port**
 - **iptv://<ip-multicast-address>/videoport/audioport**
 - **playlist=http://<ip-address>/<playlist-file-located-on-WEB-server>**
- 2 In the **Browser** field, enter a startup web screen (for example, http://www.viewsonic.com). Note: The **MAC address** is a read-only field that displays the built-in MAC address of the unit.

Continued . . .

- 3 In the **DHCP** field of the **Network Configuration** screen, tap the down arrow for the pull-down menu and select **Enabled** to dynamically get network parameters. Make sure there are values in the **IP address**, **Mask**, **Gateway**, and **DNS** fields although DHCP assigns values to these fields automatically. If you select **Disabled**, type valid network parameters in these fields.
- 4 If any changes were made to this screen, do the following:
 - To enable the changes, click **Apply**
 - To save the changes, click the **Administration** menu > click **Save Configuration** > click **Save**.

Browser Configuration

The **Browser Configuration** screen allows you to make specific screen settings for a specific URL that you chose. Click **Management** > **Browser**. The screen shown below appears. Note: 1 millisecond = 1/1000th second.

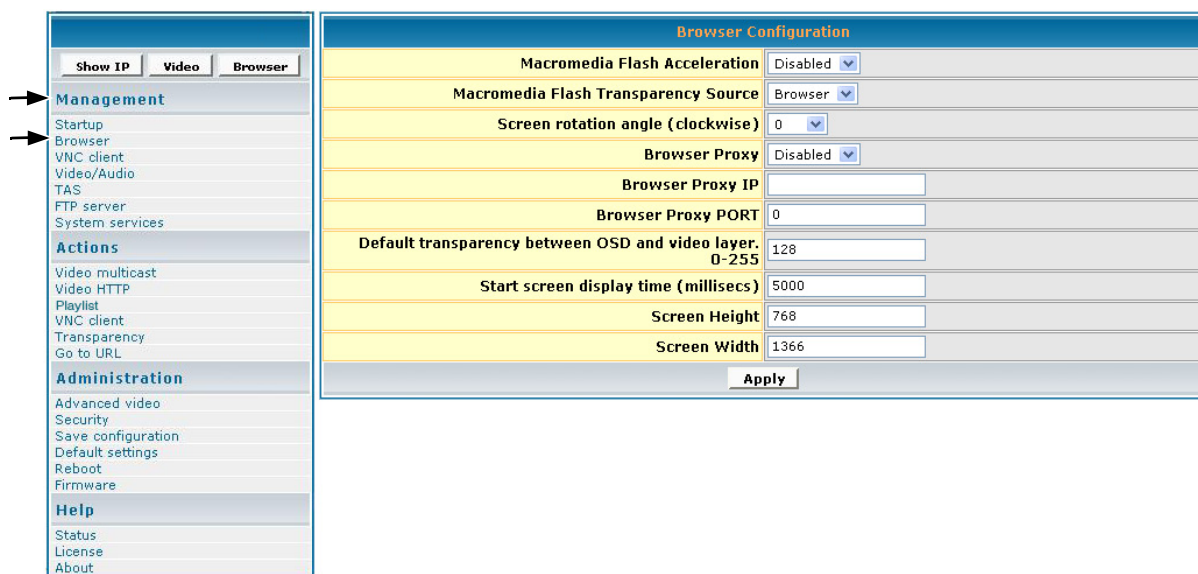

- 1 In the **Macromedia Flash Transparency Source** field, select one of the options from the pull-down menu.
- 2 In the **Screen rotation angle (clockwise)** field, select one from the pull-down menu for the angle of rotation of the HTML content displayed on-screen. This feature is useful when the **NMP-500** is installed vertically.
- 3 In the **Browser Proxy** field, select **Enabled** or **Disabled** from the pull-down menu.

- 4 In the **Browser Proxy IP** field, type an IP address if the **Browser Proxy** was Enabled.
- 5 In the **Browser Proxy PORT** field, type the port if the **Browser Proxy** was Enabled.
- 6 In the **Default transparency between OSD and video layer** field, type a number that is between 0 to 255: (128 is average where video and graphics blend together). Also, see examples in the Transparency section of this guide.
 - 0 = video only, no graphics
 - 255 = graphics only, no video
- 7 In the **Start screen display time** field, type the number of milliseconds you want the initial screen to be displayed at startup. (1 millisecond = 1/1000 second)
- 8 In the **Screen Height** field, type the height of the screen that is displaying your graphics image.
- 9 In the **Screen Width** field, type the width of the screen that is displaying your graphics image.
- 10 If any changes were made to this screen, do the following:
 - To enable the changes, click **Apply**
 - To save the changes, click the **Administration** menu > click **Save Configuration** > click **Save**.

VNC client

The **VNC client configuration** screen shown below on the **Management** menu lets you set the device to start as a VNC client and connect automatically to the VNC server specified. This auto-start feature works only if the **VNC client** under **System services** is set to **YES** or **Enabled**.

VNC server password must be at least 6 characters (can be alpha-numeric).

X and Y coordinates let you set the size of the window of the remote desktop displayed if full screen is not desired.

VNC full screen mode lets you set the client to start up as full screen all the time.

VNC auto restart mode reconnects the client in the event of network interruption.

Delay before restart VNC sets the time between reconnects.

| VNC client configuration | |
|---|-----------------------------------|
| VNC server address | <input type="text"/> |
| VNC server password | <input type="text"/> |
| X coordinate of VNC windows left-top corner | <input type="text" value="0"/> |
| Y coordinate of VNC windows left-top corner | <input type="text" value="0"/> |
| VNC full screen mode | <input type="text" value="No"/> |
| VNC auto restart mode | <input type="text" value="No"/> |
| Delay (in milliseconds) before restart VNC | <input type="text" value="5000"/> |
| <input type="button" value="Apply"/> | |

Video/Audio Configuration

This screen is used to adjust the display and audio parameters. Click **Management** > **Video/Audio**. The screen shown below appears.

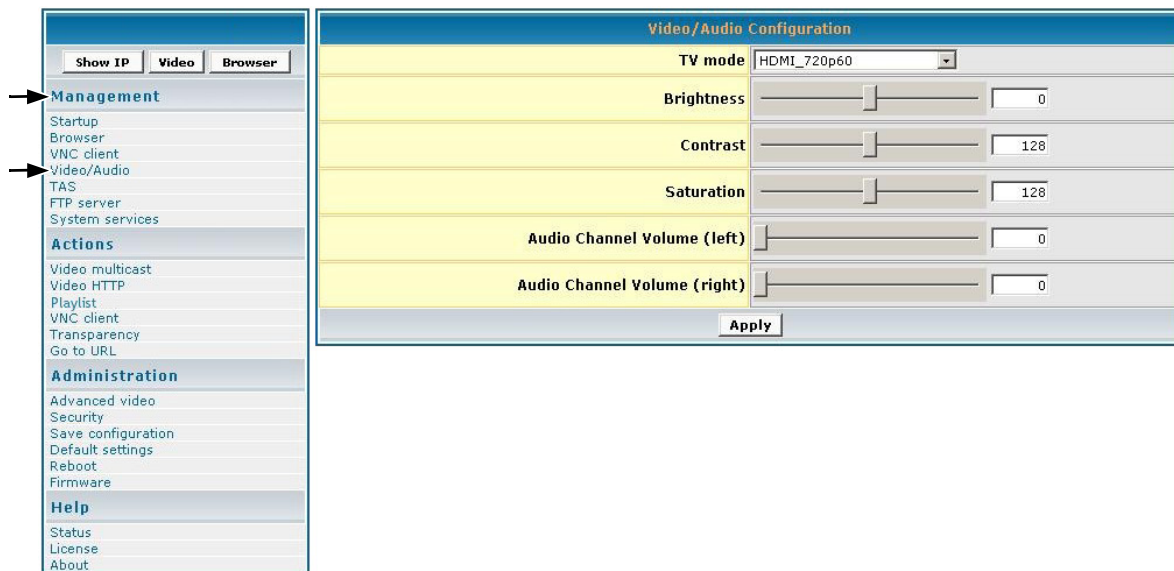

- 1 In the **TV Mode** field, click the down arrow for the pull-down menu and select one of the options.
- 2 Move the **Brightness** slider: values range between -128 and 127
- 3 Move the **Contrast** slider: values range between 0 and 255
- 4 Move the **Saturation** slider: values range between 0 and 255
- 5 Move the **Audio Channel Volume** (left) slider: values range between 0 and 100
- 6 Move the **Audio Channel Volume** (right) slider: values range between 0 and 100
- 7 If any changes were made to this screen, do the following:
 - To enable the changes, click **Apply**
 - To save the changes, click the **Administration** menu > click **Save Configuration** > click **Save**.

TAS Configuration

This screen works in conjunction with **TAS**. (TAS software can be purchased through Tivella at www.tivella.com or through an authorized Tivella dealer/reseller.) Click **Management > TAS**. The screen shown below appears.

| TAS Configuration | |
|--------------------------------------|--------------|
| Timeout (sec) | 20 |
| IP Address | tas-intranet |
| <input type="button" value="Apply"/> | |

- 1 In the **Timeout (sec)** field, type the number of seconds for the **NMP-500s** to access TAS.
- 2 In the **IP Address** field is a valid DNS name automatically generated by TAS when connected to a network but empty when used as a standalone.
- 3 If any changes were made to this screen, do the following:
 - To enable the changes, click **Apply**
 - To save the changes, click the **Administration** menu > click **Save Configuration** > click **Save**.

System Services Configuration

Configure System Services in the MIB (Management Information Base) to manage the following groups: Network, Browser, Video/Audio, TAS, and System Services. Click **Management** > **System services**. The screen shown below appears.

| System Services Configuration | |
|--------------------------------------|-----|
| Network Media Player (port 6666) | Yes |
| MIB Event Notification | No |
| <input type="button" value="Apply"/> | |

- 1 In the **Network Media Player (port 6666)** field, select **Yes** to access the **NMP-500** using a Telnet client on port 6666. If you do not want this, select **No**.
- 2 In the **MIB Event Notification** field, select **Yes** to be notified of changes that you made to the **NMP-500** settings.
- 3 If any changes were made to this screen, do the following:
 - To enable the changes, click **Apply**
 - To save the changes, click the **Administration** menu > click **Save Configuration** > click **Save**.

FTP server

FTP server is only for Network Displays with local storage. The **FTP server** allows you to use an FTP client for uploading files.

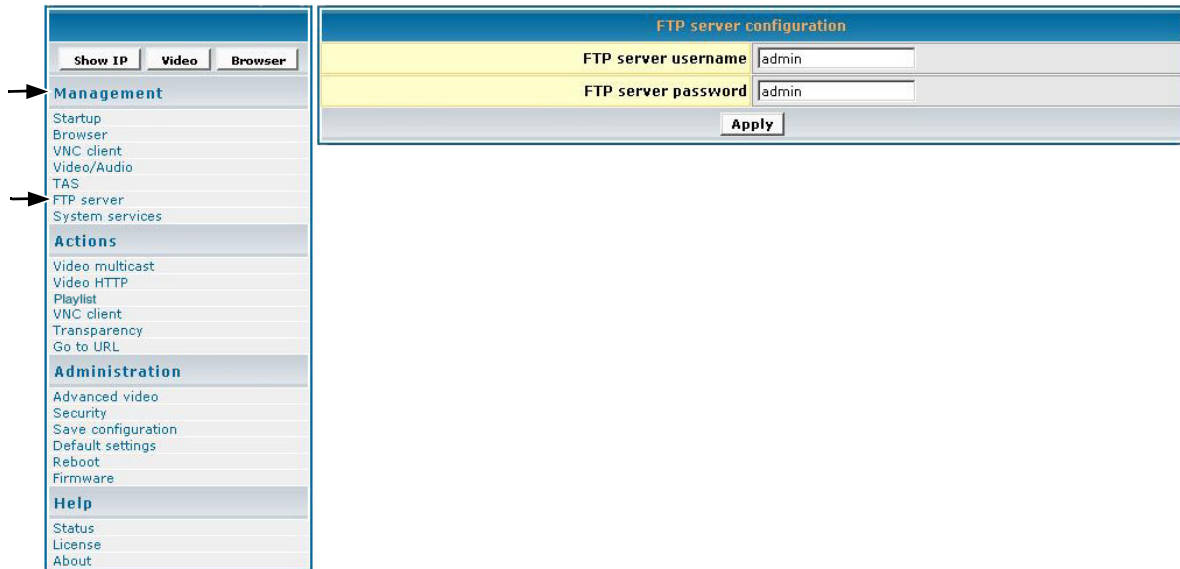

ACTIONS

This section mainly concerns video related activities. Video can be streamed by UDP, RTP, IP/TV or HTTP stream and organized in Playlists. When you initiate a stream, you can see the video on your display. You can also change the **Transparency** of the OSD or go to a specific URL on the fly.

Video Multicast

This screen allows you to play streams using the assorted protocols. Select **Actions** > **Video multicast**. The screen shown below appears.

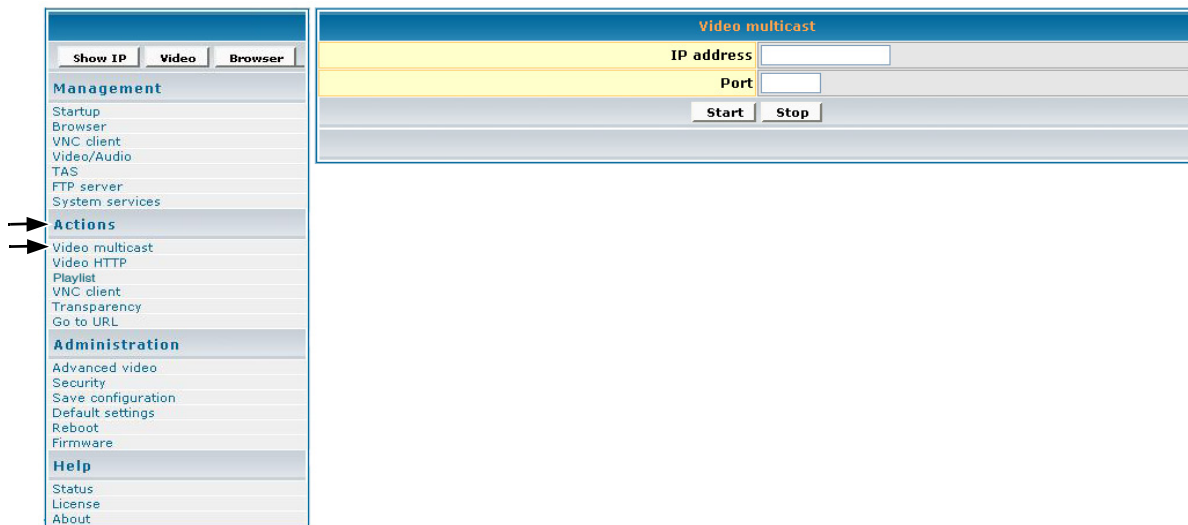

- 1 In the **IP address** field, type the IP Address transmitting UDP based multicast stream (for example, 239.1.1.7)
- 2 In the **Port** field, type the **Port** number used to receive the multicast.
- 3 To tell the system to listen to the UDP multicast stream from the IP on the Port that you entered, click **Start**.

Video HTTP

To get to the browser setup screen, click **Actions** > **Video HTTP**. The screen shown below appears.

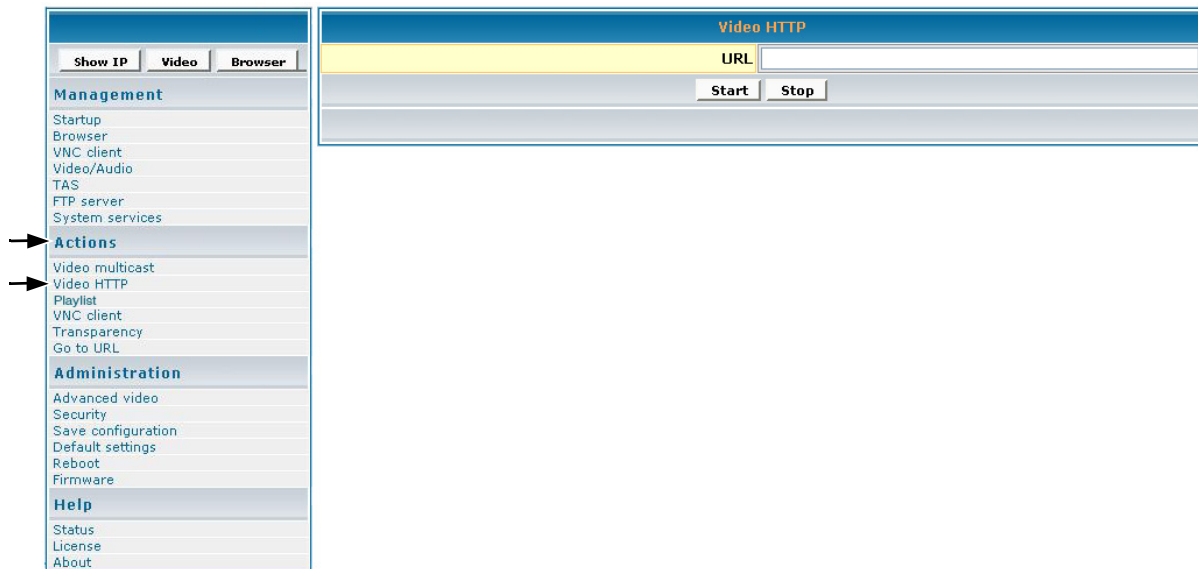

- 1 In the **URL** field, type the URL that corresponds to the HTTP stream that you want to appear on the display (for example: `http:192.168.12.x/movie.mpg`, or, `http://<server-ip>/file.mpg`).
- 2 To tell the system to listen to the HTTP stream from the entered URL, click **Start**.

Playlist

To stream existing video **Playlists** on an HTTP server, click **Actions > Playlist**. The screen shown below appears.

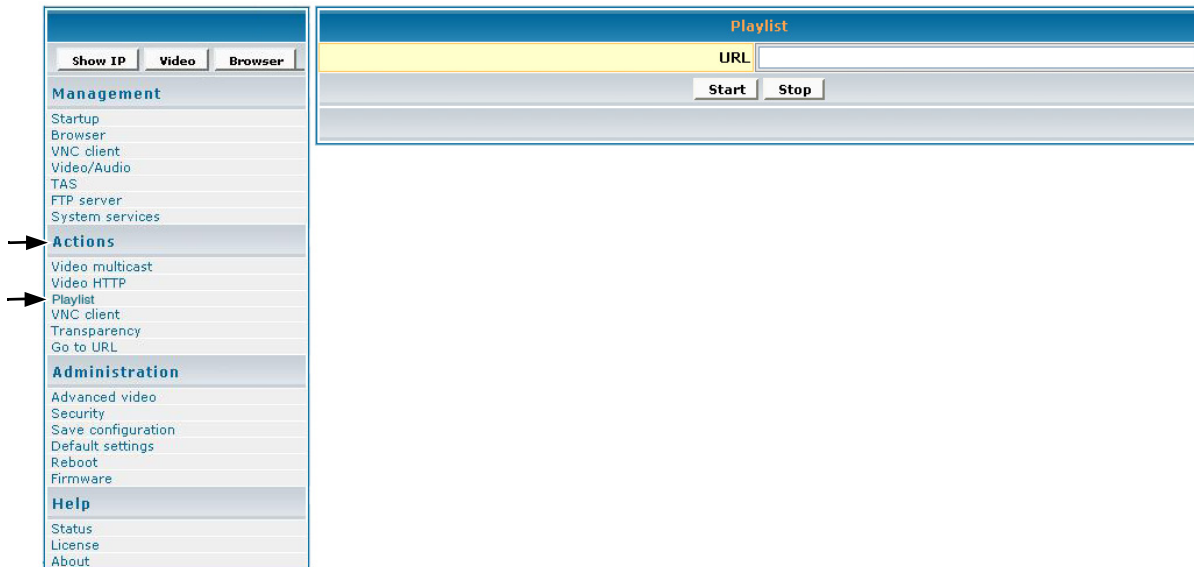

- 1 In the **URL** field, type the URL that corresponds to the **Playlist** to appear on the display (for example, `http://192.168.12.x/playlist.txt` or, type the address to start playback such as `http://<server-ip>/playlists.pls`).
- 2 To tell the system to listen to the **Playlist** from the entered URL, click **Start**.

To create a playlist

A **Playlist** is a text file that can be created in any text editor with an extension of `.txt`. A **Playlist** is necessary when you want the **NMP-500** to play specific content, in a specific order, usually looped. A **Playlist** can be created for the http streams. Example of a looped **Playlist**:

```
loop
http http://192.168.12.x/movie1.mpg
http http://192.168.12.x/movie2.mpg
http http://192.168.12.x/movie3.mpg
```

For a **Playlist** that is not looped, list the desired content without the keyword "loop."

VNC client

The VNC (Virtual Network Computing) client screen allows you to connect and display a remote desktop running a VNC server.

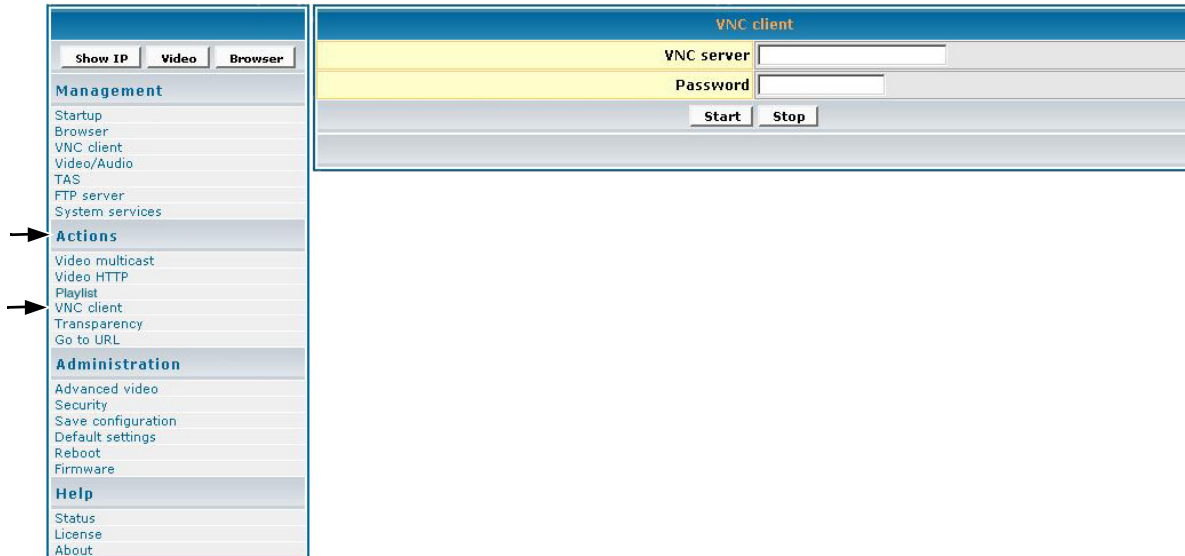

- 1 In the **VNC server** field, type the IP Address of the VNC server.
- 2 In the **Password** field, type the password of the VNC server whose IP is entered above. **IMPORTANT!** The password must be at least six (6) characters (can be alpha-numeric).
- 3 To display the remote desktop click **Start**.

Transparency

To change the transparency of the browser on-screen in relation to the video image in the background, click **Actions** > **Transparency**. The screen shown below appears.

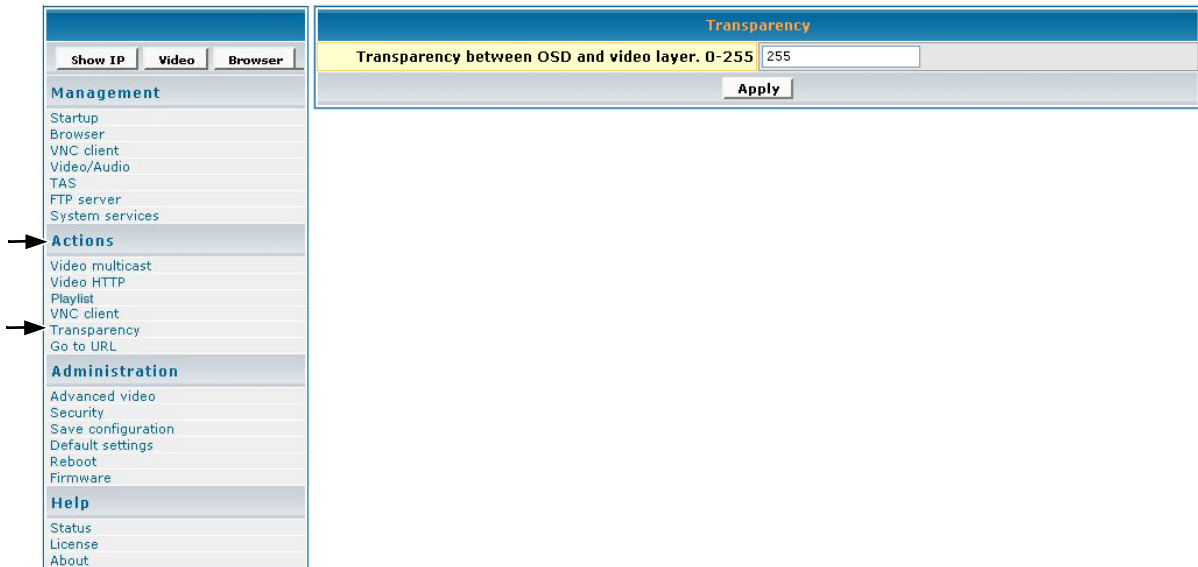

- 1 In the **Transparency between OSD and video layer** field, type a number between 0 to 255 for a more or less transparent (translucent) browser image (user interface) so you can still see through the browser OSD (On-Screen Display) shown below on the right with your video or other images: 0 = no OSD, 255 = no video, 128 = equal transparency between video and OSD layers.

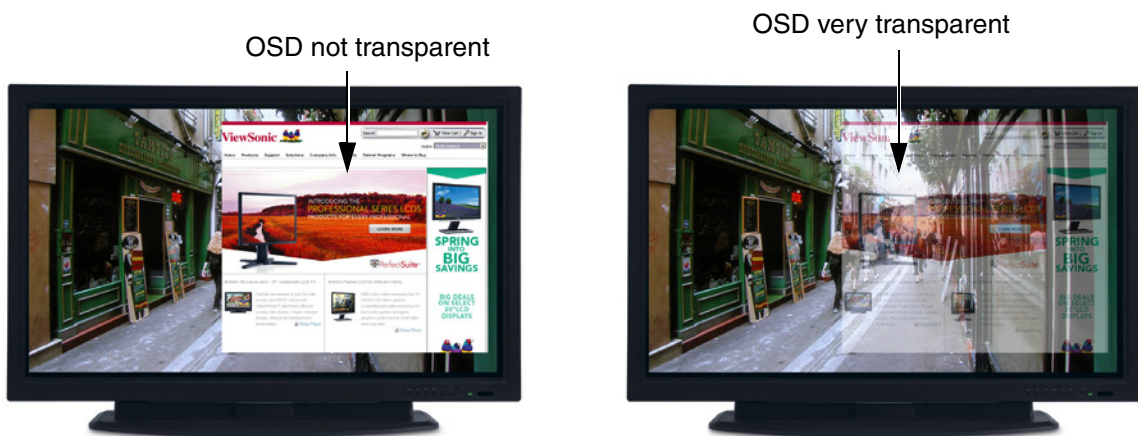

- 2 To apply the entered transparency value to the image on the **NMP-500**, click **Apply**.

Go to URL

To go to a web page on the browser, click **Actions** > **Go to URL**. The screen shown below appears.

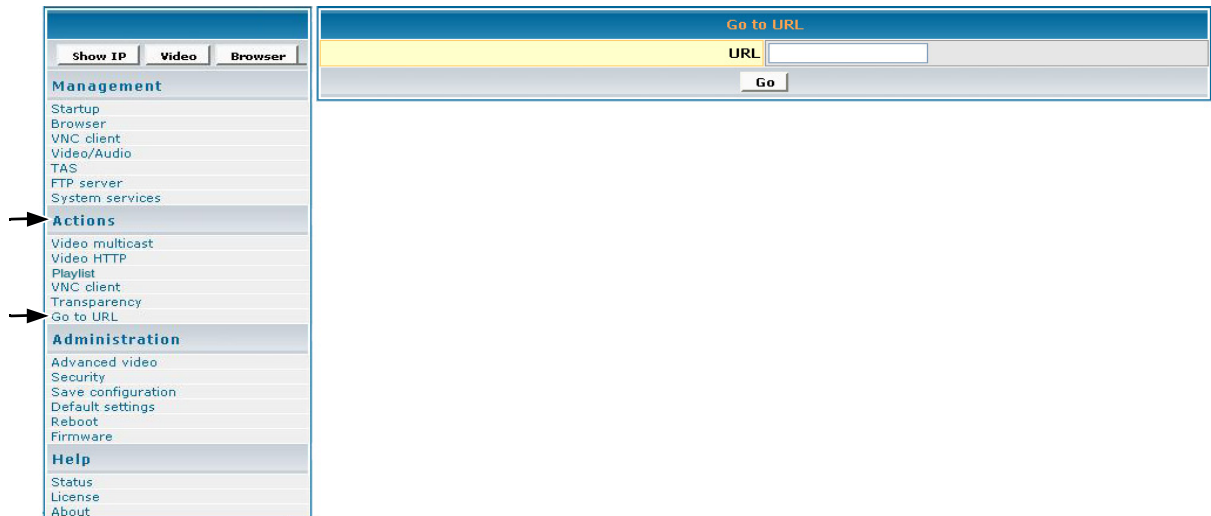

- 1 In the **URL** field, type the desired URL.
- 2 To redirect the browser to the URL that you entered, click **Go**. The web page appears on your display.

ADMINISTRATION

Advanced Video Configuration

To adjust the size and location of the video on the screen, click **Administration** > **Advanced video**. The screen shown below appears.

| Advanced video Configuration | |
|--------------------------------------|------|
| X of destination window | 2048 |
| Y of destination window | 2048 |
| Width of destination window | 4096 |
| Height of destination window | 4096 |
| <input type="button" value="Apply"/> | |

- 1 In the **X of destination window**, type the center point of the screen on the X axis.
- 2 In the **Y of destination window**, type the center point of the screen on the Y axis.
- 3 In the **Width of destination window**, type the width of the destination window.
- 4 In the **Height of destination window**, type the height of the destination window.
- 5 If any changes were made to this screen, do the following:
 - To enable the changes, click **Apply**
 - To save the changes, click the **Administration** menu > click **Save Configuration** > click **Save**.

Security

To change the **User name** and **Password** of the **NMP-500**, click **Administration** > **Security**. Current settings automatically appear in each field as shown below: default User name/Password is admin/admin.

The screenshot displays the web interface for the NMP-500. On the left is a navigation menu with sections: Management (Startup, Browser, VNC client, Video/Audio, TAS, FTP server, System services), Actions (Video multicast, Video HTTP, Playlist, VNC client, Transparency, Go to URL), Administration (Advanced video, Security, Save configuration, Default settings, Reboot, Firmware), and Help (Status, License, About). The 'Administration' and 'Security' items are highlighted with arrows. The main content area is titled 'Security Credentials' and contains three input fields: 'User name' with the value 'admin', 'Password' with '*****', and 'Repeat password' with '*****'. An 'Apply' button is located at the bottom right of the form.

- 1 In the **Password** field, type a new password.
- 2 In the **Repeat Password** field, re-type the new password.
- 3 If any changes were made to this screen, do the following:
 - To enable the changes, click **Apply**
 - To save the changes, click the **Administration** menu > click **Save Configuration** > click **Save**.

Save Configuration

To save your settings on the **NMP-500**, click **Administration** > **Save Configuration**. The screen shown below appears. Click **Save**.

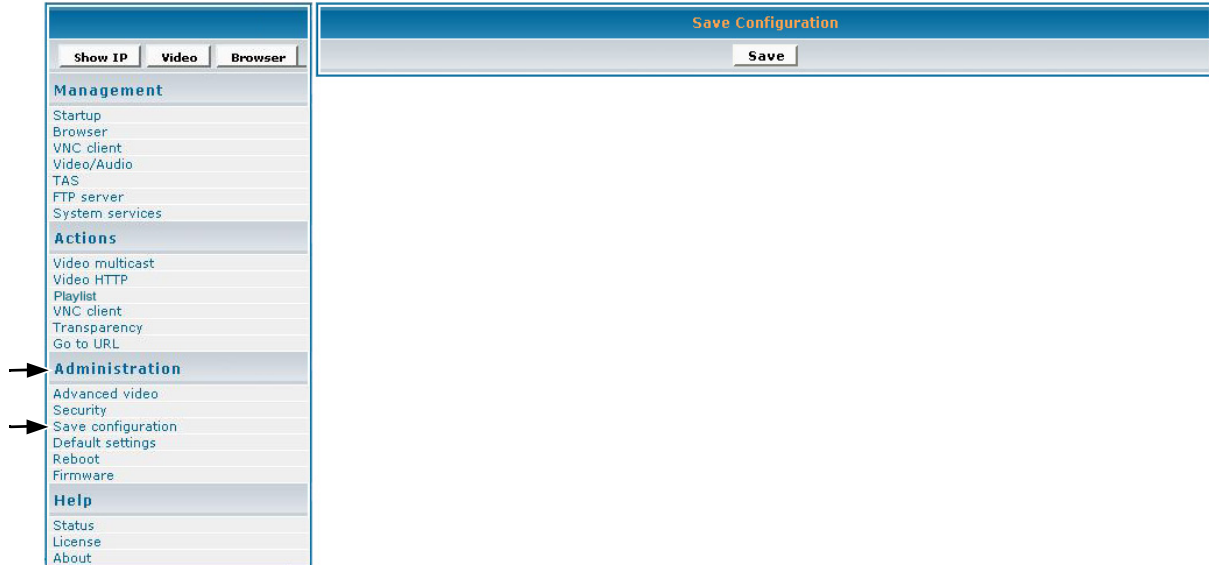

Default Settings

To restore the **NMP-500** back to factory settings, click **Administration** > **Default Settings**. The screen shown below appears. Click **Restore**. User-defined settings will be lost.

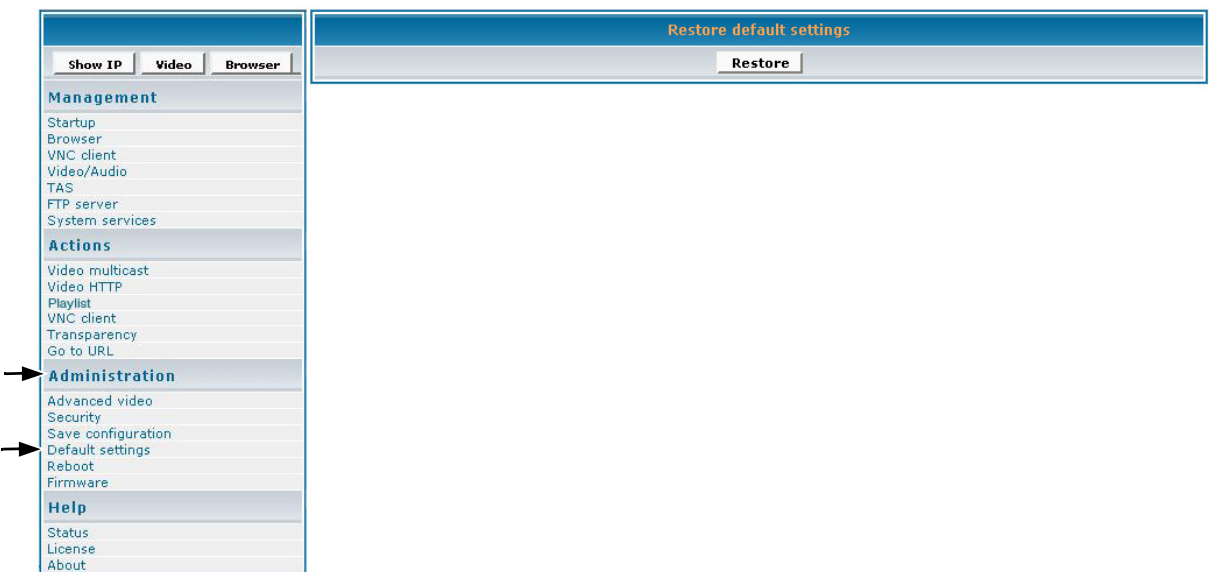

Reboot

To reboot the **NMP-500**, click **Administration** > **Reboot**. The screen shown below appears. Click **Reboot**. The **NMP-500** reboots.

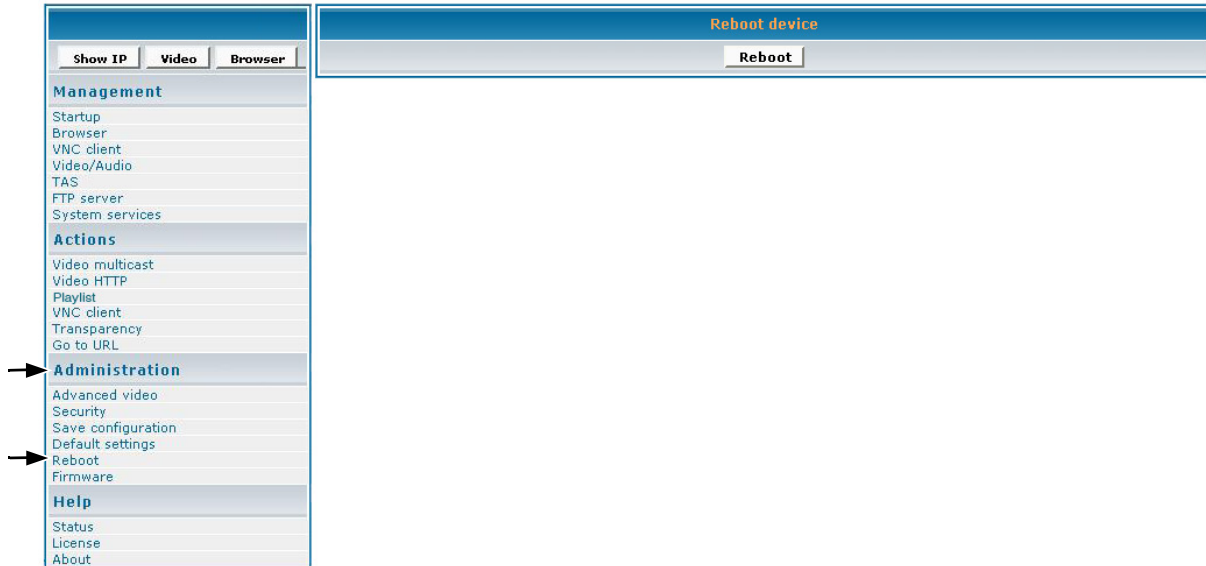

Firmware Upgrade

To upgrade the firmware on the **NMP-500**, click **Administration** > **Firmware**. The screen shown below appears. Click **Browse** to open the firmware file > click **Start upgrade**.

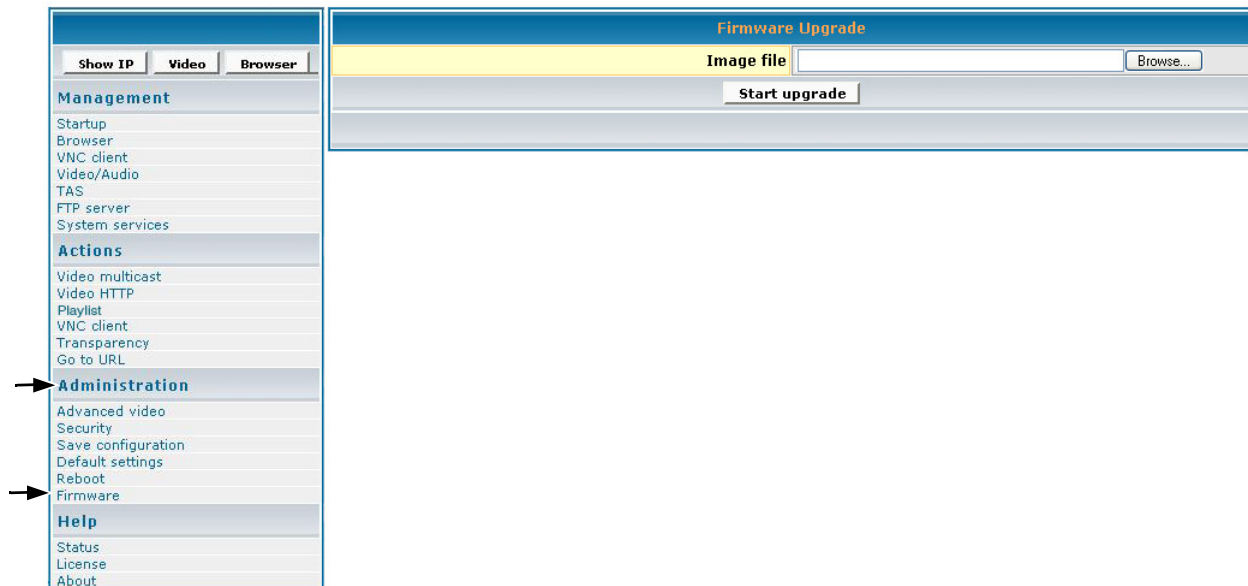

HELP

Status

Status refers to the log where you can track activity on a specific **NMP-500**. To show the **Status** log, click **Help > Status**. The screen shown below is for information only (no inputs).

The screenshot shows a web interface with a sidebar on the left and a main content area on the right. The sidebar has three main sections: Management, Actions, and Administration. The 'Help' item is highlighted with two arrows. The main content area is titled 'Device status' and displays a list of system parameters and their values.

| Parameter | Type | Value |
|---------------------------|----------|----------------------------------|
| init.License_ro | T_STRING | Y |
| init.License | T_STRING | 000F8800001049903A6A1F5492C0607A |
| init.DefaultFactorySetup | T_STRING | SETUP NUMBER_2 NUMBER_9 |
| init.build | T_STRING | Mon Feb 20 10:01:18 PST 2006 |
| init.model_name | T_STRING | NMP-500 |
| init.product | T_STRING | NMP-500 |
| init.version | T_STRING | 2.00-RC6 |
| init.macAddress | T_STRING | 00:0f: |
| init.manufactHardware | T_STRING | |
| init.manufactVendor | T_STRING | |
| init.manufactDate | T_STRING | |
| init.lHydraServerPort | T_STRING | 8080 |
| init.lHydraServerAddress | T_STRING | 192.168.12.99 |
| init.BigHydraServerAddr | T_STRING | 64.1.254.116 |
| init.lightHydraMacUpdate | T_STRING | yes |
| init.startService_xapp | T_STRING | no |
| init.startService_X11 | T_STRING | yes |
| init.startNtpclient | T_STRING | no |
| init.startInetd | T_STRING | yes |
| init.startService_mib_mc | T_STRING | no |
| init.startService_tnet | T_STRING | no |
| init.startService_rs232 | T_STRING | no |
| init.startService_kbd | T_STRING | yes |
| init.startService_api | T_STRING | no |
| init.startService_vt1 | T_STRING | no |
| init.startService_pickoch | T_STRING | no |
| init.startService_sigma | T_STRING | yes |
| init.startService_sinfo | T_STRING | yes |
| init.startService_smb | T_STRING | yes |
| init.startService_mibevt | T_STRING | no |
| init.startService_mibifc | T_STRING | yes |
| init.startService_mib | T_STRING | yes |
| init.startService_shell | T_STRING | yes |

License

To activate the license on the **NMP-500**, click **Help** > **License**. The **License Key** may appear automatically in the screen shown below (read-only).

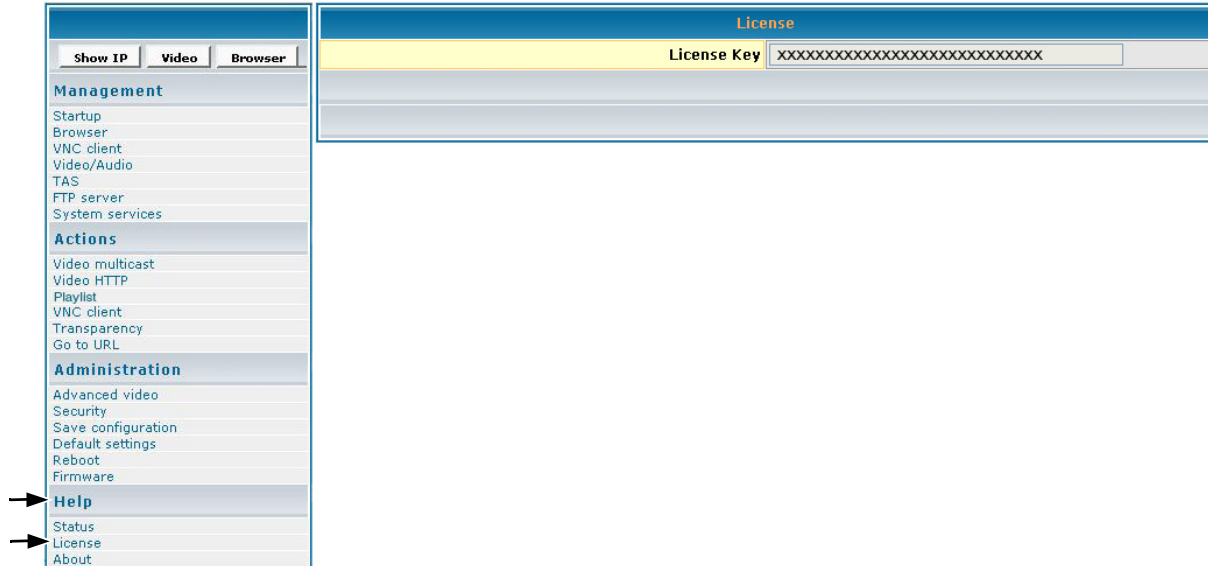

About

To show the current version of the product, click **Help** > **About**. The screen shown below appears (information only).

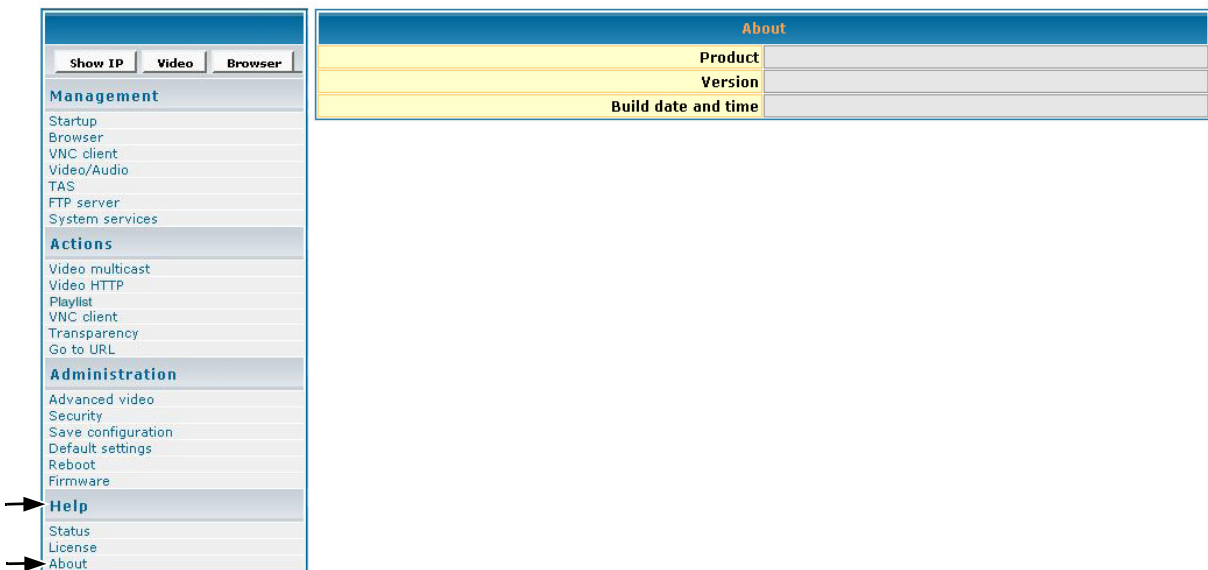

APPENDIX

Screens

Management

| Show IP Video Browser | |
|---------------------------|--|
| Management | |
| Startup | |
| Browser | |
| VNC client | |
| Video/Audio | |
| TAS | |
| FTP server | |
| System services | |
| Actions | |
| Video multicast | |
| Video HTTP | |
| Playlist | |
| VNC client | |
| Transparency | |
| Go to URL | |
| Administration | |
| Advanced video | |
| Security | |
| Save configuration | |
| Default settings | |
| Reboot | |
| Firmware | |
| Help | |
| Status | |
| License | |
| About | |

| Startup URLs | |
|--------------|--------------------------|
| Video | |
| Browser | http://www.viewsonic.com |

| Network Configuration | |
|-----------------------|-------------------|
| MAC address | 00:0F:44:00:00:01 |
| DHCP | Disabled |
| IP address | 192.168.12.103 |
| Subnet mask | 255.255.255.0 |
| Default gateway | 192.168.12.1 |
| DNS server IP address | 192.168.12.1 |
| Apply | |

| Browser Configuration | |
|---|----------|
| Macromedia Flash Acceleration | Disabled |
| Macromedia Flash Transparency Source | Browser |
| Screen rotation angle (clockwise) | 0 |
| Browser Proxy | Disabled |
| Browser Proxy IP | |
| Browser Proxy PORT | 0 |
| Default transparency between OSD and video layer. | 128 |
| Start screen display time (milliseconds) | 5000 |
| Screen Height | 768 |
| Screen Width | 1366 |
| Apply | |

| VNC client configuration | |
|---|------|
| VNC server address | |
| VNC server password | |
| X coordinate of VNC windows left-top corner | 0 |
| Y coordinate of VNC windows left-top corner | 0 |
| VNC full screen mode | No |
| VNC auto restart mode | No |
| Delay (in milliseconds) before restart VNC | 5000 |
| Apply | |

| Video/Audio Configuration | |
|------------------------------|-------------|
| TV mode | HDMI_720p60 |
| Brightness | 0 |
| Contrast | 128 |
| Saturation | 128 |
| Audio Channel Volume (left) | 0 |
| Audio Channel Volume (right) | 0 |
| Apply | |

| TAS Configuration | |
|-------------------|--------------|
| Timeout (sec) | 20 |
| IP Address | tas-intranet |
| Apply | |

| FTP server configuration | |
|--------------------------|-------|
| FTP server username | admin |
| FTP server password | admin |
| Apply | |

| System Services Configuration | |
|-------------------------------|-----|
| Network Display (port 6666) | Yes |
| MIB Event Notification | No |
| Apply | |

Actions

The 'Actions' configuration page includes the following sections:

- Video multicast:** IP address, Port, Start, Stop
- Video HTTP:** URL, Start, Stop
- Playlist:** URL, Start, Stop
- VNC client:** VNC server, Password, Start, Stop
- Transparency:** Transparency between OSD and video layer. 0-255, Apply
- Go to URL:** URL, Go

Administration

The 'Administration' configuration page includes the following sections:

- Advanced video Configuration:** X of destination window (2048), Y of destination window (2048), Width of destination window (4096), Height of destination window (4096), Apply
- Security Credentials:** User name (tivella), Password (*****), Repeat password (*****), Apply
- Save Configuration:** Save
- Restore default settings:** Restore
- Reboot device:** Reboot
- Firmware Upgrade:** Image file (Browse...), Start upgrade

Help

The screenshot shows a web interface for device management. On the left is a navigation menu with categories: Management, Actions, and Administration. The 'Help' option is selected. The main area is titled 'Device status' and contains a list of system parameters:

```

init.License_ro T_STRING Y
init.License T_STRING 000F8800001049903A6A1F5492C0607A
init.DefaultFactorySetup T_STRING SETUP NUMBER_2 NUMBER_9
init.build T_STRING Mon Feb 20 10:01:18 PST 2006
init.model_name T_STRING NMP-500
init.product T_STRING NMP-500
init.version T_STRING 2.00-RC6
init.macAddress T_STRING 00:0E:1A:00:00:00
init.manufactHardware T_STRING
init.manufactVendor T_STRING
init.manufactDate T_STRING
init.lHydraServerPort T_STRING 8080
init.lHydraServerAddress T_STRING 192.168.12.99
init.BigHydraServerAddr T_STRING 64.1.254.116
init.lightHydraMacUpdate T_STRING yes
init.startService_xapp T_STRING no
init.startService_xll T_STRING yes
init.startUpclient T_STRING no
init.startInetd T_STRING yes
init.startService_mib_mc T_STRING no
init.startService_tnet T_STRING no
init.startService_rs232 T_STRING no
init.startService_kbd T_STRING yes
init.startService_ap1 T_STRING no
init.startService_vt1 T_STRING no
init.startService_p1ckch T_STRING no
init.startService_sigmas T_STRING yes
init.startService_sinfo T_STRING yes
init.startService_mmb T_STRING yes
init.startService_mibevt T_STRING no
init.startService_mibifc T_STRING yes
init.startService_mib T_STRING yes
init.startService_shell T_STRING yes
  
```

Below the status list are two sections:

- License:** A table with a 'License Key' field containing a long string of 'x' characters.
- About:** A table with fields for 'Product', 'Version', and 'Build date and time'.

Customer Support

You need the product serial number when you contact **Customer Support**.

| Country/Region | Website (for email address also) | T = Telephone F = FAX |
|----------------|-------------------------------------|--|
| United States | www.viewsonic.com | T: (800) 688-6688 F: (909) 468-1202 |
| Canada | www.viewsonic.com | T: (866) 463-4775 F: (909) 468-5814 |

FCC Information

This equipment has been tested and found to comply with the limits for a Class A digital device, pursuant to Part 15 of the Federal Communications Commission (FCC) Rules. These limits are designed to provide reasonable protection against harmful interference in a residential installation. This equipment generates, uses, and can radiate radio frequency energy, and, if not installed and used in accordance with the instructions, may cause harmful interference to radio communications. However, there is no guarantee that interference will not occur in a particular installation. If this equipment does cause harmful interference to radio or television reception, which can be determined by turning the equipment off and on, the user is encouraged to try to correct the interference by one or more of the following measures:

- Increase the separation between the equipment and the receiver.
- Connect the equipment into an outlet on a circuit different from that to which the receiver is connected.

FCC Warning: To assure continued FCC compliance, the user must use grounded power supply cord and the provided shielded video interface cable with bonded ferrite cores. Also, any unauthorized changes or modifications not expressly approved by the party responsible for compliance could void the user's authority to operate this device.

Compliance Information for Canada

Notice: This class A digital apparatus complies with Canadian ICES-003.

AVIS: Cet appareil numérique de la Classe A conforme a la norme NMB-003 du Canada.

User Information for All Countries

Notice: Use the cables that are included unless otherwise specified.

Specifications

| | ND4200 | ND5000 |
|--------------------------|--|--|
| Default resolution | 1024 x 768 @ 60 Hz | 1366 x 768 @ 60 Hz |
| Dimensions | 1015mm (W) x 613mm (H) x 67.5mm (D) Height without stand | 1184mm (W) x 700mm (H) x 63mm (D) Height without stand |
| Effective display size | 42" Plasma screen: Horizontal 933.9mm x Vertical 534.2mm | 50" Plasma screen: Horizontal 1106.46mm x Vertical 622.08mm |
| Weight | 86.0 lbs (39.1kg) net | 115.0 lbs (52.3 kg) net |
| Connectivity | Network RJ-45 x 2 for Daisy Chain feature 10/100 Ethernet | Network RJ-45 x 2 for Daisy Chain feature 10/100 Ethernet |
| | Audio Audio output: 2 x RCA stereo analog Internal analog stereo to power amp | Audio Audio output: 2 x RCA stereo analog Internal analog stereo to power amp |
| | Communication USB x 2 | Communication USB x 2 |
| Streaming protocol types | HTTP, UDP, RTP, IP/TV, Local file playback | HTTP, UDP, RTP, IP/TV, Local file playback |
| Scanning format | SDTV: 480i EDTV: 480p HDTV: 720p, 1080i | SDTV: 480i EDTV: 480p HDTV: 720p, 1080i |
| Video decoding formats | MPEG-1, MPEG-2, MPEG-4, Macromedia Flash | MPEG-1, MPEG-2, MPEG-4, Macromedia Flash |
| Audio decoding formats | MPEG-1 (Layers 1 & 2) MP3, WAV | MPEG-1 (Layers 1 & 2) MP3, WAV |
| Image file formats | JPEG, PNG | JPEG, PNG |
| Memory (RAM) | 128 MB | 128 MB |
| Memory (FLASH) | 64 MB | 64 MB |
| Number of colors | 16.77 million | 134.2 million |
| Power consumption | 390 watts +/- 10% watts | 500 + 10% watts |
| Power input | AC 100 ~ 240 V (max) @ 50/60 Hz | AC 100 ~ 240 V (max) @ 50/60 Hz |
| Contrast ratio | 700Cd/m ² | 700Cd/m ² |
| Viewing angle | Over 160° | Over 160° |
| Operating temperature | 41 ~ 104° F (5 ~ 40° C) | 41 ~ 104° F (5 ~ 40° C) |
| Regulatory approvals | FCC-15A, IC, UL/c-UL | FCC-15A, IC, UL/c-UL |
| Optional accessories | Wall mount kit, Detachable speakers | Wall mount kit, Detachable speakers |

Specifications are subject to change without notice. Corporate names and trademarks stated herein are the property of their respective companies.

LIMITED WARRANTY

ViewSonic® Limited Warranty Terms and Conditions (Current Production Models. U.S.A. and Canada Only)

How the Viewsonic Standard Limited Warranty works:

ViewSonic Corporation ("ViewSonic") warrants its products to be free from defects in material and workmanship during a specified length of time, or "Warranty Period", as indicated below. If a product proves to be defective in material or workmanship during the Warranty Period, ViewSonic will, at its sole option, repair or replace the product with a similar product. Replacement products or parts may include remanufactured or refurbished parts or components. The replacement product will be covered by the balance of the time remaining on the customer's original ViewSonic Limited Warranty. This warranty does not cover any software included with the product.

ViewSonic products are manufactured using new materials or new and used materials equivalent to new in performance and reliability. Spare parts may be new or equivalent to new. Spare parts are warranted to be free from defects in material or workmanship for the remainder of the Limited Warranty Period under proper and/or normal use of the ViewSonic Product in which they are installed.

During the Limited Warranty Period, ViewSonic will, at its sole discretion, repair or replace the defective component parts or the ViewSonic product. All component parts or hardware products removed under this Limited Warranty become the property of ViewSonic. In the unlikely event that your ViewSonic Product has a recurring failure, ViewSonic will, at its sole discretion, provide you with a replacement unit of ViewSonic's choosing that is similar or equivalent to your ViewSonic originally purchased product in hardware and/or performance.

How long the warranty is effective:

ViewSonic warrants that its hardware will be free from defects in workmanship and materials, under proper normal use, and as set forth below:

- Hardware and Power Supplies: One (1) Year
- Accessories, spare parts, and spare kits: Ninety (90) days

The Warranty Period will begin on the date of purchase, and remain effective as specified above. Proof of purchase and/or receipt will be required for all claims purposes.

Exclusions of Warranty:

The following will immediately and automatically render any and all warranties and/or guarantees, including but not limited to the ViewSonic Limited Warranty, as void:

1. Any product on which the serial number has been defaced, modified or removed.
2. Accident, misuse, neglect, fire, water, lightning, or other acts of nature, unauthorized product modification, and/or failure to follow instructions as prescribed by ViewSonic.
3. Repair or attempted repair by someone other than a ViewSonic Licensed Technician.
4. Any damage resulting from shipments not made and/or insured by ViewSonic, and/or shipments made by ViewSonic for which recipient failed to notify ViewSonic of the damage claim within 48 hours upon receipt.

5. Removal and/or installation of any components not intended or prescribed by ViewSonic.
6. Causes external to the product, such as electric power fluctuations and/or failure.
7. Normal wear and tear.
8. Damage to, or abuse of, the coating on the surface of the display, including but not limited to cosmetic defects that do not affect functionality.
9. Any other cause which is not related to a manufacturer's defect.
10. Loss of, or damage to, the covered product due to mishandling, improper packaging by you, alteration, accident, electrical current fluctuations or failure to follow operating, maintenance or environmental instructions prescribed in the covered product's User Manual. In the event that ViewSonic determines, in its sole discretion, that the return product is damaged due to one or more of these excluded causes, the customer will be billed for the cost of repairs.
11. ViewSonic will not be responsible for any damage to, loss of, or consequential loss from the inability to use, any programs, data or other information stored on any media or any part of any Product serviced hereunder. ViewSonic makes no representations or warranties whatsoever to keep confidential or secure any data stored on any media or any part of any Product serviced hereunder. ViewSonic will not be responsible for and hereby disclaims any and all liability for damage or loss to software, data, Programs, removable media, consumables, portable docking stations, carrying cases, or non-ViewSonic-branded products such as joysticks, printers, and/or scanners, that may occur as a result of repairs to, and/or by the replacement of any defective product. In order to avoid any and such losses or damages, please make a back-up of any and/or all data(s) and Programs before returning your product to ViewSonic for replacement and/or repair(s).
12. Image burn-in and/or defective pixels/sub-pixels are not considered a manufacturer's defect. For a complete review of the details regarding the industry standard methodology ViewSonic uses to determine defective pixels/sub-pixels please visit our on-line Customer Support database at <http://www.viewsonic.com/support/qa.cfm?topic=lcd&question=01>.

Limitation of Implied Warranties

THERE ARE NO WARRANTIES, EXPRESS OR IMPLIED, WHICH EXTEND BEYOND THE DESCRIPTION CONTAINED HEREIN INCLUDING THE IMPLIED WARRANTY OF MERCHANTABILITY AND FITNESS FOR A PARTICULAR PURPOSE.

Limitations of Liability:

VIEWSONIC'S LIABILITY IS LIMITED TO THE COST OF REPAIR OR REPLACEMENT OF THE PRODUCT. VIEWSONIC EXPRESSLY DISCLAIMS ANY AND ALL LIABILITY FOR DELAYS IN SHIPPING AND/OR ANY RESULTING DAMAGE(S) DUE TO LOSS OF USE FOR ANY AND ALL REASONS. IN NO EVENT WILL VIEWSONIC CORPORATION, AND ANY AND ALL OF ITS PRESENT, FORMER AND FUTURE REPRESENTATIVES BE LIABLE FOR SPECIAL INDIRECT, INCIDENTAL OR CONSEQUENTIAL DAMAGES RELATING DIRECTLY OR INDIRECTLY TO THIS AGREEMENT. FURTHER, VIEWSONIC WILL NOT BE LIABLE FOR LOSS OF THE USE OF PRODUCT, LOSS OF DATA, LOSS OF TIME, LOSS OF PROFITS, LOSS OF BUSINESS OPPORTUNITY, LOSS OF GOODWILL, INTERFERENCE WITH BUSINESS RELATIONSHIPS OR OTHER COMMERCIAL LOSS, REGARDLESS OF WHETHER ADVISED VIEWSONIC IS ADVISED OF OR SHOULD HAVE KNOWN ABOUT THE POSSIBILITY OF SUCH DAMAGES.

How to get service:

1. For information on obtaining warranty service, call your ViewSonic dealer/reseller.
2. To obtain warranty service, please contact ViewSonic Customer Support for a Return Authorization number (RMA). You will be required to provide
 - A. A copy of the dated sales slip.
 - B. Your name.
 - C. Your address.
 - D. The serial number of the product.
 - E. A description of the problem.
 - F. Mobile and wireless products, customer should provide the user name and the password or disable password protections in order to allow ViewSonic access to the device for the performance of warranty service.
3. Bring or ship the product prepaid in the original container, with the associated accessories, to ViewSonic or any ViewSonic authorized service center.
4. For additional information or the name of the nearest ViewSonic service center, contact your ViewSonic dealer/reseller or ViewSonic.

NOTE: ViewSonic is not responsible for any returned product without an assigned RMA.

Sales outside the U.S.A. and Canada:

For ViewSonic products sold outside the U.S. and Canada, contact your ViewSonic dealer/reseller

Effect of state law:

This warranty gives you specific legal rights, and you may also have other rights which vary from state to state. Some states do not allow limitations on implied warranties and/or do not allow the exclusion of incidental or consequential damages, so the above limitations and exclusions may not apply to you.

LIMITED WARRANTY (V1.0)

Release Date: 1 May 2006

ViewSonic® 
the choice of professionals

Free Manuals Download Website

<http://myh66.com>

<http://usermanuals.us>

<http://www.somanuals.com>

<http://www.4manuals.cc>

<http://www.manual-lib.com>

<http://www.404manual.com>

<http://www.luxmanual.com>

<http://aubethermostatmanual.com>

Golf course search by state

<http://golfingnear.com>

Email search by domain

<http://emailbydomain.com>

Auto manuals search

<http://auto.somanuals.com>

TV manuals search

<http://tv.somanuals.com>