

# ViewSonic<sup>®</sup>

## **VPW4255**

**User Guide**

**Guide de l'utilisateur**

**Guía del usuario**

***42" PLASMA DISPLAY***

# Contents

For Your Records.....	1
<b>IMPORTANT SAFETY INSTRUCTIONS .....</b>	<b>2</b>
<b>FEATURES .....</b>	<b>4</b>
<b>SAFETY INSTRUCTIONS .....</b>	<b>5</b>
<b>IMAGE RETENTION PREVENTION .....</b>	<b>10</b>
<b>COMPONENT NAMES .....</b>	<b>11</b>
Main Unit.....	11
Remote control .....	12
Loading Batteries .....	12
Handling the Remote Control .....	12
<b>INSTALLATION INSTRUCTIONS .....</b>	<b>13</b>
Installation.....	13
Anti-tumble measures.....	13
Connecting to a PC .....	14
Mounting the Speaker Unit .....	15
Power Cord Connection .....	15
<b>OPERATING INSTRUCTIONS .....</b>	<b>16</b>
Turning Power On and Off .....	16
Input Switching .....	17
Volume Adjustment.....	17
Audio Mute .....	17
Size Switching .....	18
Input Signal Screen Display .....	18
Automatic Adjustment of Screen Position and the Clock .....	19
Independent Operation of Multiple Monitors .....	19
Using the Menu Screen .....	19
PICTURE MENU .....	20
AUDIO MENU .....	21
TIMER MENU .....	21
FUNCTION MENU .....	22
SETUP MENU .....	23
LANGUAGE MENU.....	24
<b>OTHER FEATURES .....</b>	<b>24</b>
Automatic Store .....	24
Signal Check .....	25
Power Save Mode.....	25
<b>IMAGE RETENTION OF PLASMA DISPLAY .....</b>	<b>26</b>
<b>NOTES .....</b>	<b>26</b>
<b>TROUBLESHOOTING .....</b>	<b>27</b>
Symptoms That Seemingly Appear to be Failures.....	27
Actions to Correct Abnormal Displays .....	29
<b>PRODUCT SPECIFICATIONS .....</b>	<b>30</b>
Signal Input.....	30
Recommended Signal List .....	31
<b>APPENDIX .....</b>	<b>33</b>
Customer Support .....	33
Limited Warranty .....	34
Power Cord Safety Guidelines .....	35
Cleaning and Maintenance .....	36
FCC Information .....	37

## Notes about This Manual

- The information in this manual is subject to change without notice.
- While meticulous care has been taken in the preparation of this manual, you are requested to notify your dealer or us should you have any comments, views or questions about our product.
- Fully understand the prerequisites to using the product, such as hardware and software specifications and constraints, in using the product. We are not held liable for damages caused by improper handling of the product.
- Reproduction of this manual in whole or in part without our prior written permission is prohibited.
- The product names mentioned in this manual may be trademarks or registered trademarks of their respective owners.

Copyright © ViewSonic Corporation, 2004. All rights reserved.

Macintosh, Mac and Power Macintosh are registered trademarks of Apple Computer, Inc.

Microsoft, Windows, Windows NT, and the Windows logo are registered trademarks of Microsoft Corporation in the United States and other countries.

ViewSonic, the three birds logo and OnView are registered trademarks of ViewSonic Corporation.

VESA and SVGA are registered trademarks of the Video Electronics Standards Association. DPMS and DDC are trademarks of VESA.

VGA and XGA are registered trademarks of the International Business Machines Corporation.

Disclaimer: ViewSonic Corporation shall not be liable for technical or editorial errors or omissions contained herein; nor for incidental or consequential damages resulting from furnishing this material, or the performance or use this product.

In the interest of continuing product improvement, ViewSonic Corporation reserves the right to change product specifications without notice. Information in this document may change without notice.

No part of this document may be copied, reproduced, or transmitted by any means, for any purpose without prior written permission from ViewSonic Corporation.

**TruBass** TruBass by SRS TruBass, SRS and (O) symbol are trademarks of SRS Labs, Inc. TruBass technology is incorporated under license from SRS Labs, Inc.

### Electronic Warranty Registration

To meet your future needs, and to receive any additional product information as it becomes available, please register your screen's warranty on the internet at:

<http://www.viewsonic.com>

Image Optimization files are also available free of charge at our web site. Go to [www.viewsonic.com](http://www.viewsonic.com) and select "Support." If you do not have access to the internet or if you require further assistance, contact "Customer Support" on page 36.

### For Your Records

<b>Product Name:</b>	<b>ViewSonic VPW4255</b>	
<b>Model Number:</b>	<b>VS10182</b>	
<b>Document Number</b>	<b>A-CD-VPW4255</b>	<b>3-25-04</b>
<b>Serial Number:</b>	_____	
<b>Purchase Date:</b>	_____	

### Product disposal at end of product life

ViewSonic is concerned about the preservation of our environment. Please dispose of this product properly at the end of its useful life. Your local waste disposal company may provide information about proper disposal.



## IMPORTANT SAFETY INSTRUCTIONS





### SAFETY POINTS YOU SHOULD KNOW ABOUT YOUR PLASMA MONITOR

Our reputation has been built on the quality, performance, and ease of service of ViewSonic Plasma monitor.

Safety is also foremost in our minds in the design of these units. To help you operate these products properly, this section illustrates safety tips which will be of benefit to you. Please read it carefully and apply the knowledge you obtain from it to the proper operation of your ViewSonic Plasma monitor.

Please fill out your warranty card and mail it to ViewSonic. This will enable ViewSonic to notify you promptly in the improbable event that a safety problem should be discovered in your product model.

Follow all warnings and instructions marked on this monitor.

	<b>CAUTION</b> RISK OF ELECTRIC SHOCK DO NOT OPEN			The lightning flash with arrowhead symbol, within an equilateral triangle, is intended to alert the user to the presence of uninsulated "dangerous voltage" within the product's enclosure that may be of a sufficient magnitude to constitute a risk of electric shock to persons.
CAUTION: TO REDUCE THE RISK OF ELECTRIC SHOCK, DO NOT REMOVE COVER (OR BACK). NO USER SERVICEABLE PARTS INSIDE. REFER SERVICING TO QUALIFIED SERVICE PERSONNEL.				The exclamation point within an equilateral triangle, is intended to alert the user to the presence of important operating and maintenance (servicing) instructions in the literature accompanying the appliance.

**WARNING:**

- TO PREVENT FIRE OR SHOCK HAZARD, DO NOT EXPOSE THIS MONITOR TO RAIN OR MOISTURE.
- THE MONITOR SHOULD NOT BE EXPOSED TO DRIPPING OR SPLASHING AND NO OBJECTS FILLED WITH LIQUIDS, SUCH AS VASES, SHOULD NOT BE PLACED ON THE MONITOR.

**NOTE:**

- There are no user serviceable parts inside the monitor.
- Model and serial numbers are indicated on back side of the monitor.

**CAUTION:** Adjust only those controls that are covered in the instructions, as improper changes or modifications not expressly approved by ViewSonic could void the user's authority to operate the monitor.

**MODIFICATIONS:** The FCC requires the user to be notified that any changes or modifications made to this device that are not expressly approved by ViewSonic. Home Electronics Division may void the user's authority to operate the equipment.

#### POWER SOURCE

THIS MONITOR IS DESIGNED TO OPERATE ON 120 VOLTS 60Hz, AC CURRENT. INSERT THE POWER CORD INTO A 120 VOLT 60Hz OUTLET.

TO PREVENT ELECTRIC SHOCK, DO NOT USE THE MONITOR'S (POLARIZED) PLUG WITH AN EXTENSION CORD, RECEPTACLE, OR OTHER OUTLET UNLESS THE BLADES AND GROUND TERMINAL CAN BE FULLY INSERTED TO PREVENT BLADE EXPOSURE.

NEVER CONNECT THE MONITOR TO DIRECT CURRENT OR ANYTHING OTHER THAN THE SPECIFIED VOLTAGE.



**CAUTION:** Never remove the back cover of the monitor as this can expose you to very high voltages and other hazards. If the monitor does not operate properly, unplug the monitor and call your authorized dealer or service center.



## IMPORTANT SAFETY INSTRUCTIONS

### Read before operating equipment

Follow all warnings and instructions marked on this monitor.

1. Read these instructions.
2. Keep these instructions.
3. Heed all warnings.
4. Follow all instructions.
5. Do not use this apparatus near water.
6. Clean only with a dry cloth.
7. Do not block any ventilation openings. Install in accordance with the manufacturer's instructions.
8. Do not install near any heat sources such as radiators, heat registers, stoves, or other apparatus (including amplifiers) that produce heat.
9. Do not defeat the safety purpose of the polarized or grounding-type plug. A polarized plug has two blades with one wider than the other. A grounding type plug has two blades and a third grounding prong. The wide blade or the third prong are provided for your safety. If the provided plug does not fit into your outlet, consult an electrician for replacement of the obsolete outlet.
10. Protect the power cord from being walked on or pinched particularly at plugs, convenience receptacles, and the point where they exit from the apparatus.
11. Only use the attachments/accessories specified by the manufacturer.
12.  Use only with the cart, stand, tripod, bracket, or table specified by the manufacturer, or sold with the apparatus. When a cart is used, use caution when moving the cart/apparatus combination to avoid injury from tip-over.
13. Unplug this apparatus during lightning storms or when unused for long periods of time.
14. Refer all servicing to qualified service personnel. Servicing is required when the apparatus has been damaged in any way, such as power-supply cord or plug is damaged, liquid has been spilled or objects have fallen into apparatus, the apparatus has been exposed to rain or moisture, does not operate normally, or has been dropped.

Do not place any objects on the top of the monitor which may fall or cause a child to climb to retrieve the objects.

### PREVENTION OF SCREEN BURN

Continuous on-screen displays such as video games, stock market quotations, computer generated graphics, and other fixed (non-moving) patterns can cause permanent damage to the monitor. Such "SCREEN BURNS" constitute misuse and are **NOT COVERED** by your ViewSonic Warranty.

### PUBLIC VIEWING OF COPYRIGHTED MATERIAL

Public viewing of programs broadcast by TV stations and cable companies, as well as programs from other sources, may require prior authorization from the broadcaster or owner of the video program material.

15. Monitors are designed to comply with the recommended safety standards for tilt and stability. Do not apply excessive pulling force to the front, or top, of the cabinet which could cause the product to overturn resulting in product damage and/or personal injury.
16. Follow instructions for wall, shelf or ceiling mounting as recommended by the manufacturer.
17. An outdoor antenna should not be located in the vicinity of overhead power lines or other electrical circuits.
18. If an outside antenna is connected to the receiver be sure the antenna system is grounded so as to provide some protection against voltage surges and built up static charges. Section 810 of the National Electric Code, ANSI/NFPA No. 70-1984, provides information with respect to proper grounding for the mast and supporting structure, grounding of the lead-in wire to an antenna discharge unit, size of grounding connectors, location of antenna-discharge unit, connection to grounding electrodes and requirements for the grounding electrode.

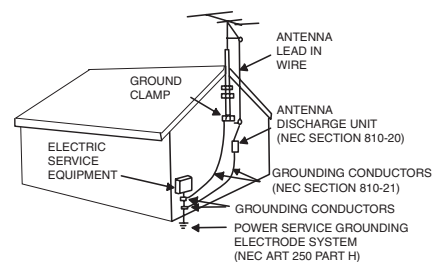

NEC NATIONAL ELECTRICAL CODE

Note to the CATV system installer: This reminder is provided to call the CATV system installer's attention to Article 820-40 of the NEC that provides guidelines for proper grounding and, in particular, specifies that the cable ground shall be connected to the grounding system of the building, as close to the point of cable entry as practical.

Disposal of this product may require specific instructions pertaining to your resident state. For disposal or recycling information, please contact your local authorities or the Electronic Industries Alliance: [www.eiae.org](http://www.eiae.org).

## Important

Please read this User's Manual thoroughly, especially the Important Safety Instructions on Page 3 to 4 and 6 to 10. Mis-use may cause damage to your plasma monitor, which could shorten its lifespan, or cause injury to yourself. Should you encounter any difficulty in the set-up or operation of your monitor, firstly refer to the Troubleshooting guide at the rear of this manual.

In the unlikely event of a problem occurring with your plasma monitor, switch off at the mains sockets, pull out the plugs, and contact your dealer immediately.

## CAUTION

Under no circumstances remove the rear cover of your plasma monitor.

Never guess or take any chances with electrical equipment of any kind - it is better to be safe than sorry!

## Software Notice

It is prohibited for the end user of this product to copy, reverse engineer or reverse compile the software included therein, save to the extent permitted by law.

## Plasma Monitor

After the plasma monitor has been on for any length of time, you will notice that the screen becomes warm. Please note that this is normal. Sometimes the screen might have some tiny bright or dark spots. Please note that this is normal.

## CAUTION

To prevent scratches or damages to the plasma screen, do not knock or rub the surface with sharp or hard objects. Clean the screen with a soft cloth moistened with warm water and dry with a soft cloth. A mild soap may be used if the screen is extremely dirty. Do not use harsh or abrasive cleaners!

## CAUTION

Use a soft cloth to clean the cabinet and control panel of the monitor. When excessively soiled dilute a neutral detergent in water, wet and wring out the soft cloth and afterward wipe with a dry soft cloth.

Never use acid/alkaline detergent, alcoholic detergent, abrasive cleaner, powder soap, OA cleaner, car wax, glass cleaner, etc. especially because they would cause discoloration, scratches or cracks.

## FEATURES

### Large-screen, high-definition plasma display panel

The 42-inch color plasma display panel, with a resolution of 1024 (H) x 1024 (V) pixels, creates a high-definition, large-screen (aspect ratio: 16:9) and low-profile flat display. Free from electromagnetic interferences from geomagnetic sources and ambient power lines, color misconvergence and display distortion.

### High Performance Digital Processor

A wide range of personal computer signals can be handled, from 640 x 400, 640 x 480 VGA to 1600 x 1200 UXGA.

### Easy-to-use remote control and on screen display system

The remote control included eases the work of setting display controls. Further, the on-screen display system, displays the status of signal reception and display control settings in an easy-to-view fashion.

### Power saving system

The International ENERGY STAR® power saver feature saves power consumption automatically when input signals are not available. When connected to a VESA DPMS-compliant PC, the monitor cuts its power consumption while it is idle.

### TruBass <sup>TruBass</sup> by SRS

TruBass, SRS and (O) symbol are trademarks of SRS Labs, Inc. TruBass technology is incorporated under license from SRS Labs, Inc.

### About the Video Unit

The following functions can be obtained by connecting the video unit.

- (1) A composite/S terminal and two component terminals are included. A composite video output terminal is also provided as a monitor output.
- (2) A wide range of devices other than personal computers can also be connected.
- (3) A component input is possible to switch to RGB signals from the Menu screen.

# SAFETY INSTRUCTIONS

This Plasma monitor has been designed and manufactured to meet international safety standards, but like any electrical equipment, care must be taken if you are to obtain the best results and safety is to be assured. Before using this product, please read and understand the Safety Instructions thoroughly to ensure correct usage, and follow all the instructions.

## About the Symbols

Various symbols are used in this manual, the user's manual and on the product itself to ensure correct usage, to prevent danger to the user and others, and to prevent property damage. The meanings of these symbols are described below. It is important that you read these descriptions thoroughly and fully understand the contents.



This symbol indicates information that, if ignored, could possibly result in personal injury or even death due to incorrect handling.



This symbol indicates information that, if ignored, could result possibly in personal injury or physical damage due to incorrect handling.

### Typical Symbols



This symbol indicates an additional warning (including cautions). An illustration is provided to clarify the contents.



This symbol indicates a prohibited action. The contents will be clearly indicated in an illustration or nearby (the symbol to the left indicates that disassembly is prohibited).



This symbol indicates a compulsory action. The contents will be clearly indicated in an illustration or nearby (the symbol to the left indicates that the power plug should be disconnected from the power outlet).



### Never use the monitor if a problem should occur.

Abnormal operations such as smoke, strange odor, no image, no sound, excessive sound, damaged casing, elements, cables, penetration of liquids or foreign matter, etc. can cause a fire or electrical shock.

In such case, immediately turn off the power switch and then disconnect the power plug from the power outlet. After making sure that the smoke or odor has stopped, contact your dealer. Never attempt to make repairs yourself because this could be dangerous.



Disconnect the plug from the power outlet.

### Do not insert liquids or foreign objects.

Penetration of liquids or foreign objects could result in fire or electrical shock. Use special caution in households where children are present.

If liquids or foreign objects should enter the Display, immediately turn off the power switch, disconnect the power plug from the power outlet and contact your dealer.

- Do not place the monitor in a bathroom.
- Do not expose the monitor to rain or moisture.
- Do not place flower vases, pots, cups, cosmetics, liquids such as water, etc on or around the monitor.
- Do not place metals, combustibles, etc on or around the monitor.



Do not disassemble.

### Never disassemble or modify the monitor.

The monitor contains high voltage components. Modification could result in fire or electrical shock.

- Never remove any fixed cover.

### Do not give the monitor any shock or impact.

If the monitor should be shocked and/or broken, it could result in an injury, and continued use could result in fire or electrical shock. If the glass panel is broken or damaged, immediately turn off the power switch, disconnect the power plug from the power outlet and contact your dealer.



### Do not place the monitor on an unstable surface.

If the monitor should be dropped and/or broken, it could result in an injury, and continued use could result in fire or electrical shock.

- Do not place the monitor on an unstable, slanted or vibrant surface such as a wobbly or inclined stand.

### Do not obstruct the ventilation of the monitor.

If the ventilation is obstructed during the operation of the monitor or just after switching off the power, it could result in damage and shorten the lifespan of your monitor due to overheating. Make sure there is ample ventilation.

- Keep a space of 100mm (10cm) or more between the sides, rear and top of the monitor and other objects such as walls.
- Do not place anything around ventilation openings of the monitor.
- Never block ventilation openings.
- Do not put the plasma screen side up.
- Do not cover the monitor with a tablecloth, etc.
- Do not place the monitor on a carpet or bedding, or near a curtain.



### Use only the correct power outlet.

Incorrect power supply could result in fire or electrical shock. Use only the correct power outlet depending on the indication on the monitor and the safety standard.

- The enclosed power cord must be used depending on the power outlet to be used.



## SAFETY INSTRUCTIONS (continued)

### WARNING

#### **Be cautious of the power cord connection.**

Incorrect connection of the power cord could result in fire or electrical shock.

- Do not touch the power cord with a wet hand.
- Check that the connecting portion of the power cord is clean (with no dust), before using. Use a soft and dry cloth to clean the power plug.
- Insert the power plug into a power outlet firmly. Avoid using a loose, unsound outlet or contact failure.
- Do not cut off the fitted power plug, the removal of which could lead to impaired performance. If you wish to extend the lead, obtain an appropriate extension lead or consult your dealer.
- Should you require replacing the fuse in the molded plug with a new fuse, then please replace with new one of the same value, type and approval as the original. Ensure the fuse cover is returned to its original position.



#### **Be sure to keep safety ground connection.**

Connect the ground terminal of AC inlet of this monitor with the ground terminal provided at the power outlet using the enclosed power cord. If the provided plug does not fit your outlet, consult an electrician for replacement of the obsolete outlet.



Surely connect the ground wire.

#### **Be careful in handling the power cord and external connection cables.**

If you keep using a damaged the power cord or cables, it can cause a fire or electrical shock. Do not apply too much heat, pressure or tension to the power cord and cables.

If the power cord or cables are damaged (exposed or broken core wires, etc.), contact your dealer.

- Do not place the monitor or heavy objects on the power cord and cables. Also, do not place a spread, cover, etc., over them because this could result in the inadvertent placing of heavy objects on the concealed power cord or cables.
- Do not pull the power cord and cables. When connecting and disconnecting the power cord or cables, do it with your hand holding the plug or connector.
- Do not place the cord near the heater.
- Do not touch the power plug just after disconnecting it from the power outlet to prevent electric shock.
- Do not touch the power plug when lightning is close to you.
- Avoid coiling the power cord and bending it sharply.
- Protect the power cord from being walked on, pinched particularly at plugs, conveniences receptacles, and the point where they exit from the apparatus.
- Do not modify the power cord.



#### **Be careful in handling the battery of the remote control.**

Incorrect handling of the battery could result in fire or personal injury. The battery may explode if not handled properly.

- Keep the battery away from children and pets. If swallowed consult a physician immediately for emergency treatment.
- Do not allow the battery to be exposed to fire or water.
- Avoid fire or high-temperature environment.
- Do not hold the battery with metallic tweezers.
- Keep the battery in a dark, cool and dry place.
- Do not short circuit the battery.
- Do not recharge, disassemble or solder the battery.
- Do not physically impact the battery.
- Use only the battery specified in the manual of this monitor.
- Make sure the plus and minus terminals are correctly aligned when loading the battery.
- If you observe a leakage of the battery, wipe out the liquid and then replace the battery. If the liquid adheres your body or clothes, rinse well with water.
- Obey the local laws on disposing the battery.





## SAFETY INSTRUCTIONS (continued)

### CAUTION

#### Be careful in moving the monitor.

Neglect could result in an injury or damage.

- Do not move the monitor during use. Before moving, disconnect the power plug and all external connections.
- You are advised to move the monitor with two persons.
- Avoid any impact or shock to the monitor; particularly take care of glass screen.



#### Do not put anything on top of the monitor.

Placing anything on the monitor could result in loss of balance or falling, and cause an injury or damage. Use special caution in households where children are present.



#### Avoid a humid or dusty place.

Placing the monitor in a smoke, a highly humid, dusty place, oily soot or corrosive gas could result in fire or electrical shock.

- Do not place near the kitchen, a humidifier or other place where there is oil, smoke or humidity.



#### Avoid a high temperature environment.

The heat could have adverse influence on the monitor and other parts, and could result in transformation, melting or fire.

- Do not place the monitor, the remote control and other parts in direct sunlight or near a hot object such as heater, etc.
- Do not put the monitor in a place where the temperature is widely changing.



#### Remove the power cord for complete separation.

- For safety purposes, disconnect the power cord if the monitor is not to be used for prolonged periods of time.
- Before cleaning, turn off and unplug the monitor. Neglect could result in fire or electrical shock.



Disconnect the plug from the power outlet.

### PRECAUTIONS

#### Installation environment

Do not obstruct a ventilation hole.

Do not put the monitor on carpet or blanket, or near a curtain which has a possibility of obstructing a ventilation hole of the monitor.

Do not put the monitor in the following places.

- Hot places such as near heaters or places exposed to the direct rays of the sun.
- A place where the temperature is widely changing.
- Places with soot, dust or high humidity.
- Poor air ventilation place.
- Places near fire.
- A wet place such as bathroom, or shower room.
- Place where you can trip over it.
- Always vibrating or strongly vibrating places.
- Unstable places.

#### How to view the monitor

If you use the monitor in a dark room, your eyes may become tired.

Please use it in a reasonably bright room.

Avoid direct rays of the sun to the screen in order to prevent eye fatigue.

Your eyes will get fatigued after viewing the monitor for long period of time.

Relax your eyes by viewing away from the monitor from time to time.

#### Note on image retention

The plasma monitor illuminates phosphor to display images. The phosphor has a finite illumination life. After extended periods of illumination, the brightness of the phosphor will be degraded to such extent that stationary images would burn-in that part of the screen as grayed-out images.

Tips to prevent such image retention are:

- Do not display images having sharp brightness differences or high-contrast images, such as monochrome characters and graphic patterns, for long.
- Do not leave stationary images on-screen for long. Try to refresh them at appropriate intervals of time, or try to move them using the screen saver function.
- Turn down the contrast and brightness controls.

#### How to clean the plasma screen panel of the monitor

Before cleaning the monitor, turn off the monitor and disconnect the power plug from the power outlet.

To prevent scratching or damaging the plasma screen face, do not knock or rub the surface with sharp or hard objects. Clean the screen with a soft cloth moistened with warm water and dry with a soft cloth. If it is not enough, then use a cloth with mild detergent. Do not use harsh or abrasive cleaners.

#### How to clean the cabinet of the monitor

Use a soft cloth to clean the cabinet and control panel of the monitor. When excessively soiled dilute a neutral detergent in water, wet and wring out the soft cloth and afterward wipe with a dry soft cloth.

Never use acid/alkaline detergent, alcoholic detergent, abrasive cleaner, powder soap, OA cleaner, car wax, glass cleaner, etc. especially because they would cause discoloration, scratches or cracks.

## SAFETY INSTRUCTIONS (continued)

### • **Avoiding radio interference**

This monitor has been designed according to the international EMI standards. This is to prevent a problem to radio receivers.

- Keep the monitor away from a radio.
- Adjust radio antennas so the monitor does not receive interference.
- The antenna cable of radio should be kept away from the monitor.
- Use a coaxial cable for antenna.
- You can check if this monitor influences radio receivers by turning off all equipment other than the monitor.
- If you find a problem with a radio when using the monitor, check the instructions mentioned above.

### • **Precautions for the cable connection**

- Ensure that all connections including the power plug, extension leads and interconnections between the pieces of equipment are properly made and in accordance with the manufacturer's instructions. Switch off and withdraw the power plug before making or changing connections.
- Confirm the connector is fixed tightly when the signal cable is connected. Also confirm the screws on the connector are tightened.
- Plug the power cord of the monitor into a different socket than a socket used for equipment like radios, etc.
- Use a plug with ground terminal and make sure that it connects to the ground.

### • **Precaution during transportation**

- Use the original carton box and its packaging materials when the monitor is transported.
- Failure to transport the monitor in any carton except the original carton may result in damage to the monitor.
- Save the original carton box and all packing material.

### • **Do not physically impact the remote control.**

- A physical impact could cause damage or malfunction of the remote control.
- Take care not to drop the remote control.
- Do not place heavy objects on the remote control.

### • **Avoid strong rays.**

- Any strong rays (such as direct sun rays or room lighting) onto the remote control sensors could deactivate the remote control.

### • **Avoid radio interference.**

- Any interfering radiation could cause distorted images or "noises."
- Avoid radio generators such as a mobile telephone, transceiver, etc. around the monitor.

### • **Precautions for the installation**

- Do not use makeshift stands and NEVER fix legs with wood screws - to ensure complete safety, always fit the manufacturer's approved stand or legs with the parts provided according to the instructions.
- Use only with the cart, stand, tripod, bracket, or table specified by the manufacturer or sold with the apparatus. When a cart is used, use caution when moving the cart/apparatus combination to avoid injury from tipping it over.
- This product is designed to comply with the recommended safety standards for tilt and stability. Do not apply excessive pulling force to the front, or top, of the cabinet that could cause the product to overturn resulting in product damage and/or personal injury.
- Follow instructions for wall, shelf or ceiling mounting as recommended by the manufacturer.
- Only use the attachments/accessories specified by the manufacturer.
- Consult your dealer if you are in any doubt about installation, operation or safety of your equipment.

### • **Other precautions**

- Do not leave equipment switched on when it is unattended unless it is specifically stated that it is designed for unattended operation or has a stand-by mode. Switch off using the switch on the equipment.
- Disposal of this product may require specific instructions pertaining to your resident region.
- Never guess or take any chances with electrical equipment of any kind - it is better to be safe than sorry!

## SAFETY INSTRUCTIONS (continued)

### • FCC (Federal Communications Commission) STATEMENT WARNING

For model VPW4255

**WARNING :** This equipment has been tested and found to comply with the limits for a Class B digital device, pursuant to Part 15 of the FCC Rules. These limits are designed to provide reasonable protection against harmful interference in a residential installation. This equipment generates, uses, and can radiate radio frequency energy and, if not installed and used in accordance with the instructions, may cause harmful interference to radio communications. However, there is no guarantee that interference will not occur in a particular installation. If this equipment does cause harmful interference to radio or television reception, which can be determined by turning the equipment off and on, the user is encouraged to try to correct the interference by one or more of the following measures:

- Reorient or relocate the receiving antenna.
- Increase the separation between the equipment and receiver.
- Connect the equipment into an outlet on a circuit different from where the receiver is connected.
- Consult the dealer or an experienced radio / TV technician for help.

**Instructions to Users :** This equipment complies with the requirements of FCC (Federal Communication Commission) regulations, provided that following conditions are met.

Video inputs : The input signal amplitude must not exceed the specified level.

**CAUTION :** Changes or modifications not expressly approved by the party responsible for compliance could void the user's authority to operate the equipment.

## IMAGE RETENTION PREVENTION

Image Retention	Rétention d'image	Retención de Imagen
<p>Image Retention can be an issue for all plasma displays. However if you follow the simple guidelines listed below you can enjoy many years of viewing. ViewSonic has included a number of features in our range of plasma Televisions and Monitors which help to reduce image retention and temporary image. Please refer to the user manual for this model for instruction on how to use these features.</p>	<p>La rétention peut être un problème pour les écrans plasma. Néanmoins si vous suivez les simples instructions suivantes, vous pourrez profiter de votre écrans pendant de longues années. ViewSonic a pourvu ses écrans Plasma TV et moniteurs de fonctions permettant de réduire la rétention d'image et les images temporaires. Veuillez s'il vous plaît vérifier dans le mode d'emploi de ce modèle comment utiliser ces fonctions.</p>	<p>La Retención de Imagen puede ser un inconveniente para todas las pantallas de plasma. Sin embargo si sigue estas recomendaciones que aparecen debajo, podrá disfrutar durante más años de una correcta visualización. ViewSonic ha incluido una serie de características en su gama de plasma Television y Monitor que pueden ayudar a reducir la retención de imagen y la imagen temporal. Por favor consulte el manual del usuario de este modelo concreto para instrucciones de cómo utilizar estas características.</p>
<p><b>Examples of Image Retention</b></p>	<p><b>Exemples de Rétention d'Image</b></p>	<p><b>Ejemplos de Retención de Imagen</b></p>

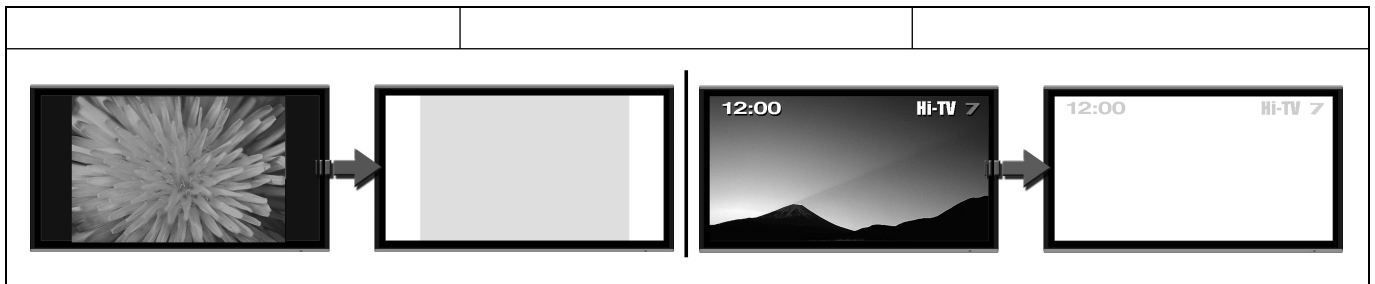

- \* Ensure screen save mode is activated.
- \* Always display the image in a mode that fills the screen.
- \* Avoid using split screen modes for long periods of time.
- \* Do not allow the "On Screen Display" to stay on for long periods of time.
- \* Do not display still images, such as menus from game consoles, Teletext, and PCs for a long period of time.
- \* Reduce the "Contrast" and "Brightness" level as much as possible.

- \* Assurez vous que l'économiseur d'écran est bien activé.
- \* Vérifiez toujours que le format d'image que vous utilisez est constamment adapté à l'écran.
- \* Evitez d'utiliser le mode de séparation d'écran sur une longue période.
- \* Ne pas laisser le menu à l'écran affiché pendant de longues périodes.
- \* Ne pas afficher des images fixes, comme les menus des jeux vidéo, télétexte, ordinateurs ou Logos sur l'écran pendant de longues périodes.
- \* Nous vous recommandons également de régler le contraste et la luminosité à un niveau le plus faible possible.

- \* Asegúrese que el modo "salva pantalla" esté activo.
- \* Visualize la imagen en un mode que llene toda la pantalla.
- \* Evite el uso de los modos de pantalla partida durante largos periodos de tiempo.
- \* No permita que el Menú en Pantalla (OSD) permanezca durante periodos de tiempo prolongados.
- \* No muestre imágenes fijas como menús de videoconsolas, Teletexto, PC o logos en el panel durante largos periodos de tiempo.
- \* Recomendamos que el nivel de "Contraste" y "Brillo" se reduzca tanto como sea posible.

# COMPONENT NAMES

## Main Unit

### Front

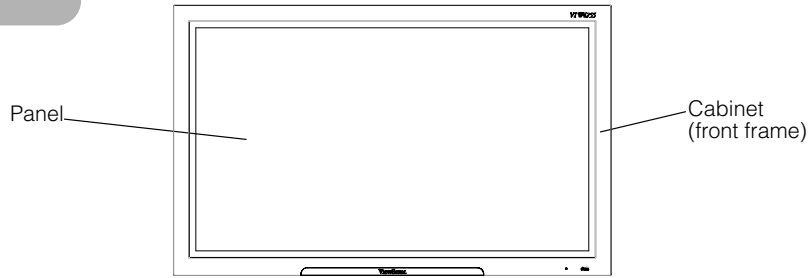

### Control panel

- Adjustment buttons are located on the bottom.
- The back cover is provided with indications to distinguish the adjustment buttons.

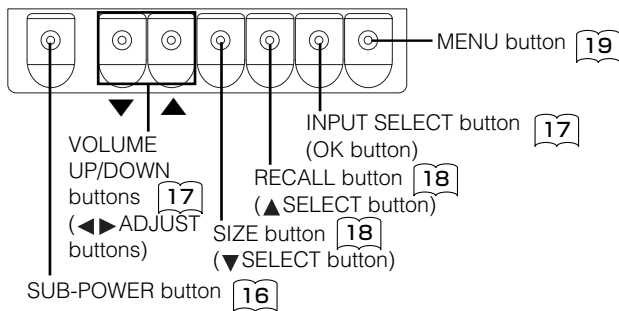
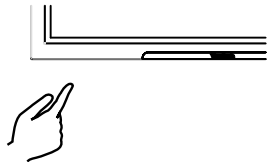

- ( ) indicates the function while the MENU is displayed on the screen.

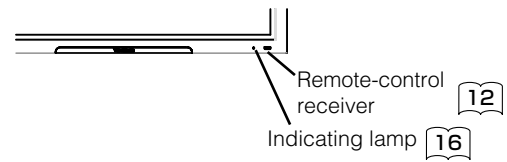

- The main power switch is located at the back, on the lower surface.

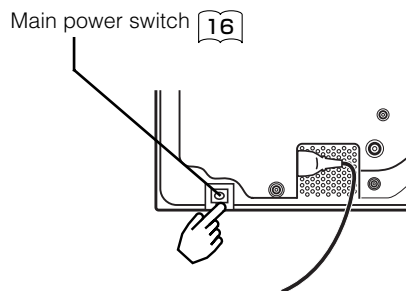

### Caution when moving the main unit

- As this product is heavy, whenever it is moved, two people are required to transport it safely.
- Whenever the unit is moved it should be lifted forwards using the two handgrips at the back, and the unit should then be held at the base on both sides for stability.

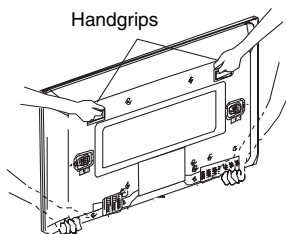

### Rear

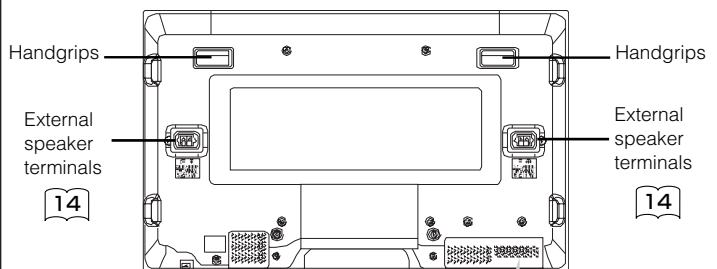

### External device connection terminals

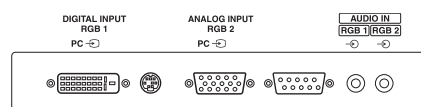

RGB input terminals 14

# COMPONENT NAMES (continued)

## Remote control

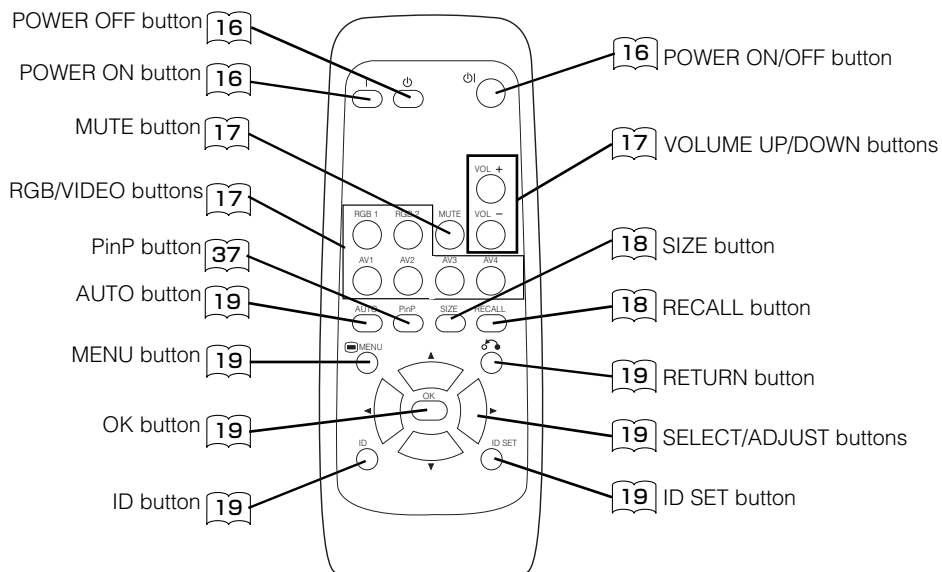

### Loading Batteries

1. Open the battery cover.
  - Slide back and remove the battery cover in the direction of the arrow.

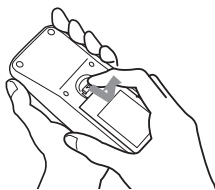

2. Load batteries.
  - Load two Size AA batteries included observing the correct polarities.

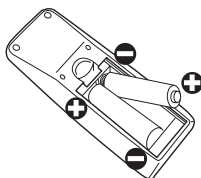

3. Close the battery cover.
  - Replace the battery cover in the direction of the arrow and snap it back into place.

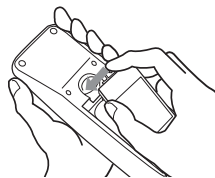

### Handling the Remote Control

Use the remote control within about 5m from the front of the unit's remote-control sensor and within 30 degrees on both sides.

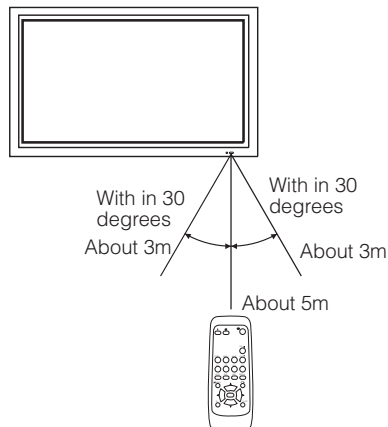

**CAUTION**

- Do not use new and old batteries together. The batteries could explode or leak, resulting in fires, physical injury, or stains.
- When loading batteries, observe their correct polarities as marked on the product. If loaded in the wrong direction, the batteries could explode or leak, resulting in fires, physical injury, or stains.

**ATTENTION**

- Do not drop or impact the remote control.
- Do not splash the remote control with water or put it on a wet object.
- Before leaving the remote control out of use for an extended period of time, remove the batteries from it.
- If the remote control begins to lack responsiveness, replace the batteries.
- Strong light, such as direct sunlight, shining on the photoreceptor of the remote control can cause operational failure. Position this unit to avoid direct contact with such light.

# INSTALLATION INSTRUCTIONS

## Installation

- If you have purchased the model without the stand attached:  
When installing the monitor, use the optional Desktop Stand.  
The Desktop Stand has been used for the illustrations in this manual.

### ⚠ WARNING

Use one of the special mount units to install this product. A mount of insufficient strength or inadequate design can cause overturning or dropping and result in fire, electrical shock or injury. Please note that our company assumes absolutely no responsibility for personal injuries or property damage caused by use of other mount units or improper installation.

### ⚠ CAUTION

- Installation of the wall mount unit and ceiling mount unit can be dangerous, so do not attempt this work yourself. Ask your dealer to provide the name of a qualified installer.
- In order to prevent an internal temperature increase, maintain a space of 10cm (4 inches : For a desktop set-up) or more between the sides and other objects such as walls, etc., so that the ventilation holes are not blocked.(:\*)

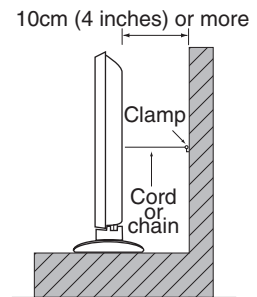

## Anti-tumble measures

### ⚠ CAUTION

Have this unit mounted in a stable place. Take measures to prevent it from tumbling down to avoid possible physical injury.

### Securing to a wall or pillar

Using a commercially available cord, chain and clamp, secure the set to a firm wall or pillar.

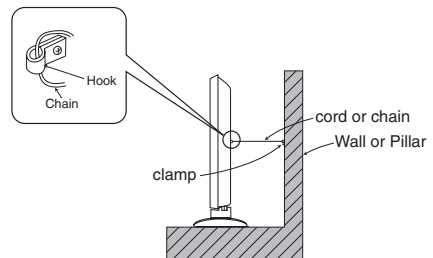

### Securing desktop

- 1) Using wood screws (two), fasten the set to the clamping screw holes on the rear of the stand as shown.
- 2) Using commercially available wood screws, secure the set firmly in position.

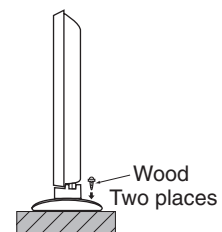

## INSTALLATION INSTRUCTIONS (continued)

Read **SAFETY INSTRUCTIONS** ( 5 to 9 ) carefully to ensure maximum safety before proceeding to these steps:

- Choose an appropriate site and install the product on a level table where the stand is secure.
  - Install the monitor to have ready access to a power socket available.
- Make sure that the power switch of this device is turned off.

### Connecting to a PC

(1) Please refer to the ViewSonic website for appropriate PC drivers to run the display at its optimal condition.

[www.ViewSonic.com](http://www.ViewSonic.com)

(2) Make sure that the display signal of the personal computer to be used is compatible with the specifications of this device.

See "Product Specifications" concerning the specifications of this device. 30 ~ 32

(3) Make sure that the power switch of the personal computer is turned off.

(4) Connect the signal input terminal (RGB 1 or RGB 2) on the rear panel of this device to the display signal output terminal of the personal computer.

- Use a cable that fits the input terminal of this device and the output terminal of the personal computer.
- Depending on the type of personal computer being connected, the use of an optional conversion adapter or the adapter provided with the personal computer may be necessary. For details, refer to the instruction manual of the personal computer or ask the personal computer manufacturer or your local retail dealer.

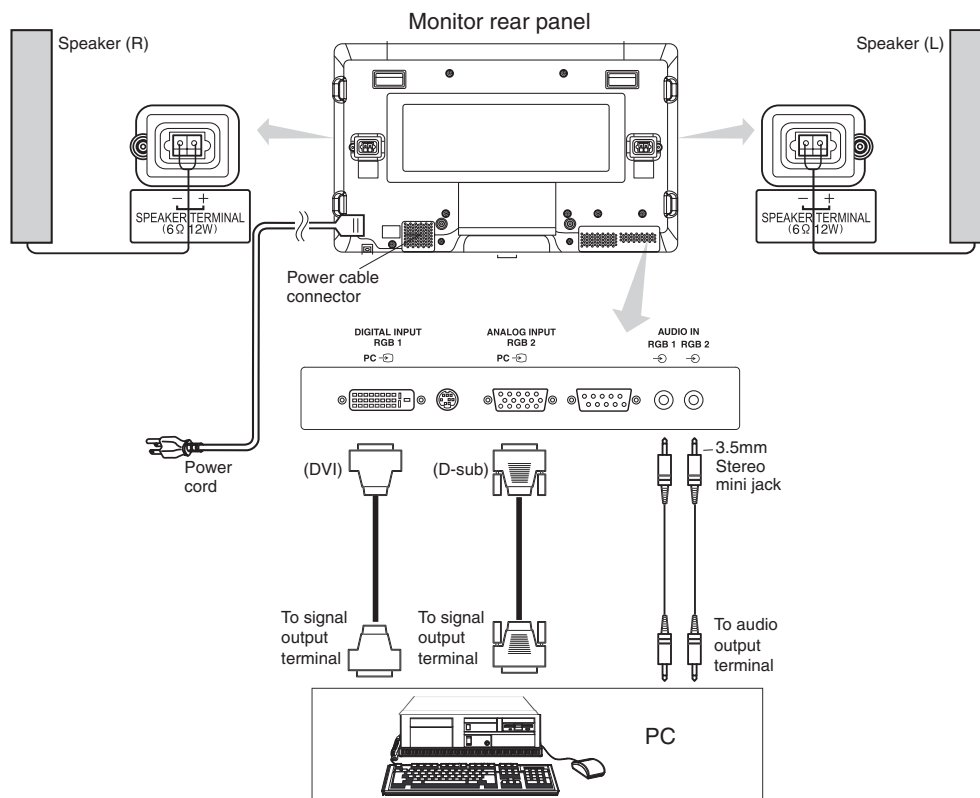



## INSTALLATION INSTRUCTIONS (continued)

### Power Cord Connection

Connect the power cord, after completing all other connections.

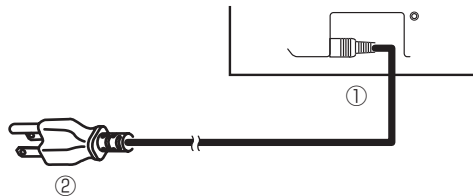

- ① Connect the power cord to this device.
- ② Connect the power cord plug to the power outlet.  
(The type of plug is different from this drawing for some countries.)

#### CAUTION

- Use only the power cord provided.
- Do not use a power supply voltage other than that indicated (AC100-240V, 50/60Hz) as this may cause fire or electric shock.

# OPERATING INSTRUCTIONS

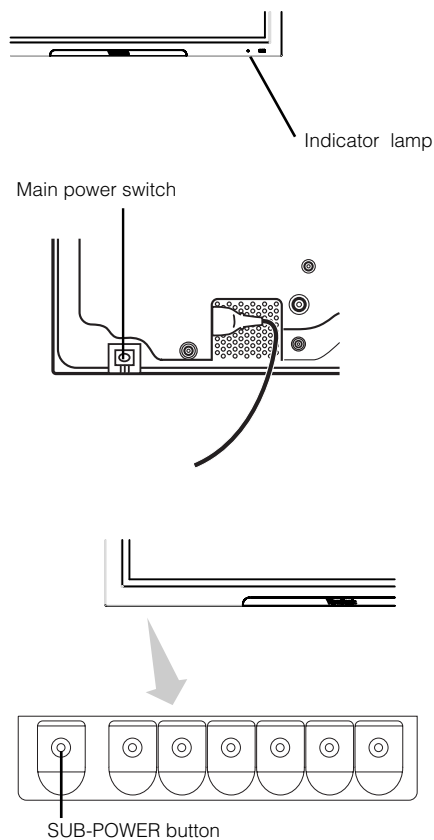

## Turning Power On and Off

- To turn the monitor power ON, press the main power switch on the back of the unit to ON, and then press the SUB POWER button or the ON/OFF or ON button on the remote control.
- To turn the monitor power OFF, press the SUB POWER, or the ON/OFF, or OFF button on the remote control, and then press the main power switch to OFF.
  - During normal use, the main power switch is set in the ON position, and the monitor can then be turned ON/OFF using the SUB POWER button or the ON/OFF button on the remote control.

### Indicator lamp

Indicator lamp	Power status	Operating
Off	Off	When the main power switch is set to OFF.
Red	Off (standby)	When the main power switch is ON, and SUB POWER is OFF.
Green	On	When the main power switch is ON, and SUB POWER is ON.
Orange	Off (Power Save)	When the main power switch is ON, and SUB POWER is ON. The unit is in Power Save mode.

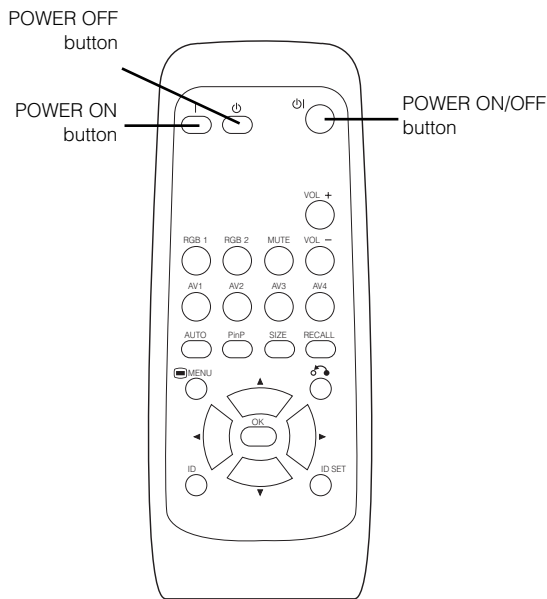

When the indicating lamp lights orange or the message "No Sync. Signal", "Power Save" or "Invalid Scan Freq." appears on the screen, there is something unusual about the status of reception. See "Power Save Mode" or "Symptoms That Seemingly Appear to be Failures." [25](#) [27](#)

**ATTENTION**

- Avoid repeatedly turning the monitor on and off at short time intervals. Failures might result from such operation.
- Turn off the main power switch before leaving the monitor out of use for an extended period of time.
- If a power failure occurs while the main unit is running, it will be powered on upon recovery from the failure. Turn off the unit's main power switch to avoid power surges upon recovery.

## OPERATING INSTRUCTIONS (continued)

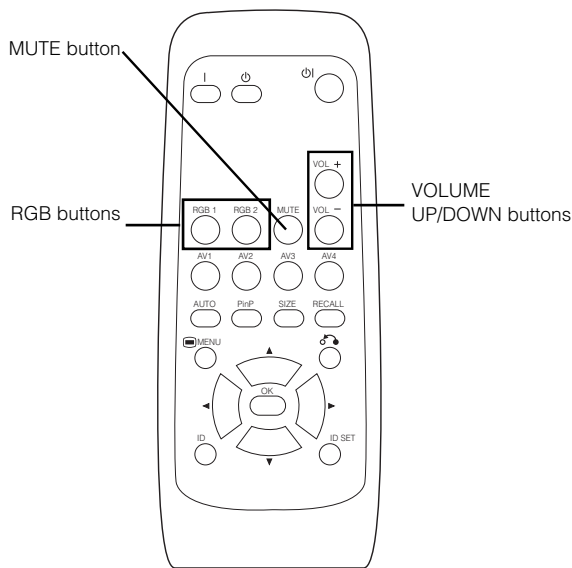
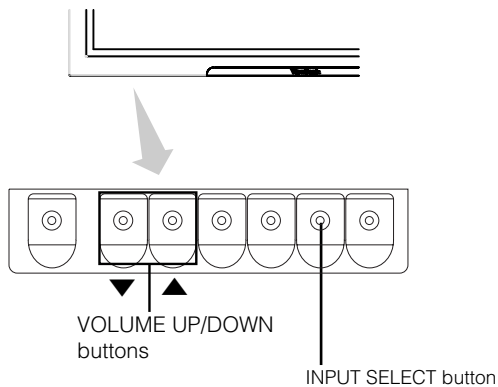

### Input Switching

- Input can be switched by pressing the RGB1, RGB2, buttons of the remote control.
- Input can be switched in the sequence of RGB1 → RGB2 by pressing the INPUT SELECT button of the monitor.

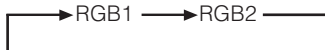

### Volume Adjustment

The volume can be adjusted by pressing the VOL+ and VOL- buttons of the remote control (or the ▲ and ▼ volume buttons of the monitor unit).

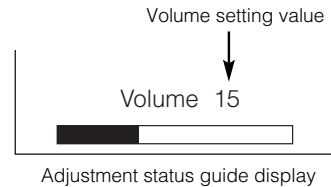

• When a button is pressed, the volume adjustment status guide will be displayed.

- The volume will increase when the VOL+ (or ▲) button is pressed while the guide is being displayed.
- The volume will decrease when the VOL- (or ▼) button is pressed while the guide is being displayed.

### Audio Mute

The audio volume can be temporarily muted by pressing the MUTE button of the remote control.

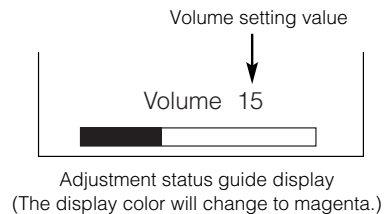

• When a button is pressed, the volume adjustment status guide (magenta) will be displayed.

- The volume setting can be lowered by pressing the VOL- button while the audio is mute.
- The muting can be cancelled by pressing the VOL+ button or MUTE button while the audio is mute.

When the MUTE button of the remote control is pressed again, the audio will be restored and the volume display (green) will appear.

# OPERATING INSTRUCTIONS (continued)

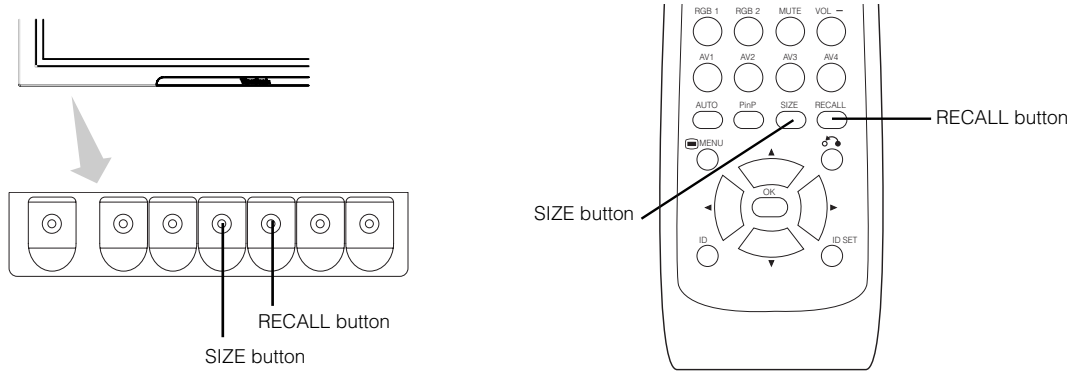

## Size Switching

Each time the SIZE button of the remote control or the monitor is pressed, the screen display area will change in sequence and the status will be displayed at the bottom of the screen.

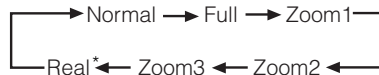

\* Real mode gives the image of the same shape as it is displayed on a computer monitor. This mode is only available for VGA (640 X 480) and WVGA (864 X 480).

## Display area selection diagram (RGB input)

Resolution	Full display	Circular display				
		Normal	Real	Zoom1	Zoom2	Zoom3
640 X 480 (VGA)						
800 X 600 (SVGA)						
1024 X 768 (XGA)						
1280 X 1024 (SXGA)						
1600 X 1200 (UXGA)						

Processes such as compression (thinning) and expansion are performed for the above signal display. Because of this, there is a possibility that flicker may become noticeable on Zoom (1 ~ 3) depending on the display contents. If this occurs, turning the Vertical Filter On can reduce the flicker.

## Input Signal Screen Display

The input signal status can be displayed on the screen by pressing the RECALL button of the remote control or the monitor.

- The display will go out in approximately 6 seconds.

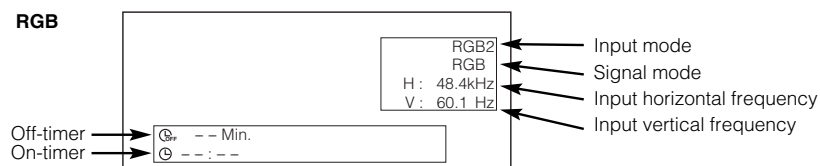

## OPERATING INSTRUCTIONS (continued)

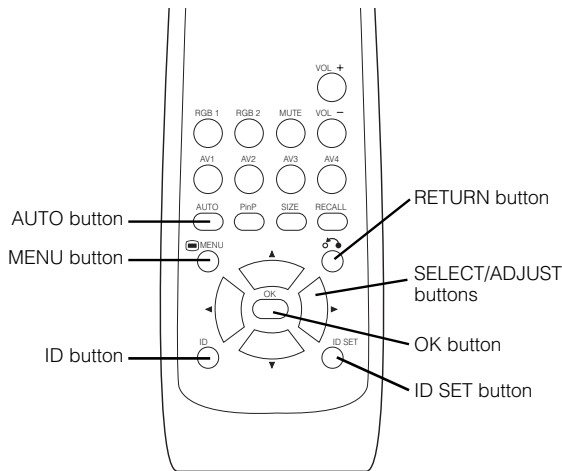

### Automatic Adjustment of Screen Position and the Clock

Adjustment of the screen to a position suitable for the PC signal and the clock adjustment can be performed automatically by pressing the AUTO button of the remote control.

#### IMPORTANT

Select the Automatic Adjustment of Screen Position for each input (RGB1 or RGB2) and for each signal.

\* Depending on the signal, satisfactory adjustment may not be possible. In such a case, adjust by referring to the Setup Menu item.

### Independent Operation of Multiple Monitors (ID No)

Setting the ID No. of the remote control allows separate control of up to a maximum of seven monitors. Remote control ID No. 2 (initially ID no. 1) can be set by pressing the ID SET button for 2 sec. or more holding down the ID button. The number will be incremented (2...6→7→1→2) when this button is pressed continuously.

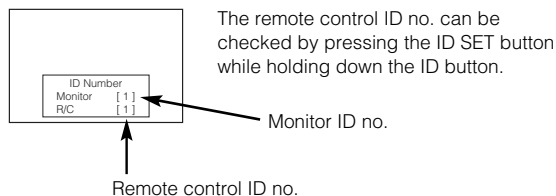

The remote control ID no. can be checked by pressing the ID SET button while holding down the ID button.

The ID remote control is operated by pressing the various buttons while holding down the ID button; Operation is possible only when the remote control and monitor ID nos. are the same.

- The remote control can be operated normally by pressing the various remote control buttons without holding down the ID button.
- Set the monitor using the ID No. of Function MENU. [22](#)

### Using the Menu Screen (On-screen display system)

When the MENU button is pressed, the adjustment menu screen will be displayed; from there, PC signal adjustment and setting is possible by using the SELECT button, ADJUST button and OK button.

- Refer to [20](#) - [24](#) concerning the adjustment items and the settings.

#### Example: Selecting the Picture screen

1. Press the MENU button to display the Main Menu screen.

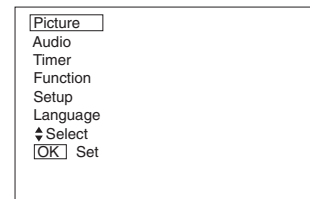

2. Press the OK button to display the Picture Menu screen. (Use the ▲ and ▼ SELECT buttons to select other items.)

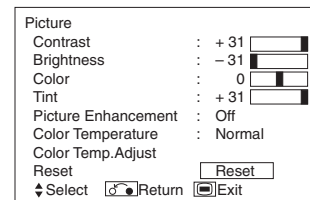

3. Use the ▲ and ▼ SELECT buttons to select the item to be adjusted and then use the ◀ and ▶ ADJUST buttons to adjust (example: Contrast).

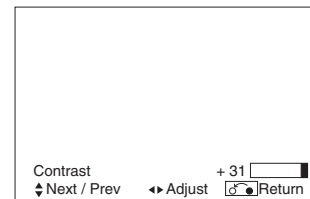
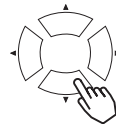

- Press the RETURN button to return to the previous screen.
- If there is no operation for a period of one minute, the Adjustment Menu screen will be closed automatically.



# OPERATING INSTRUCTIONS (continued)

## AUDIO MENU



Selected characters	◀	▶	Setup hint
Audio Mode	▶ Movie ↔ Music ↔ Speech ↔ Favorite ◀		Movie: This selects audio suitable for Movie. Music: This selects audio suitable for Music. Speech: This selects audio suitable for News, Talk show etc. Favorite: This mode can be adjusted depending on user's preference.
Treble	Suppresses treble.	Enhances treble.	Adjust to taste.
Bass	Suppresses bass.	Enhances bass.	Adjust to taste.
Balance	Suppresses right-side sound.	Suppresses left-side sound.	Adjust to taste.
SRS TruBass	▶ Off ↔ Low ↔ Middle ↔ High ◀		SRS TruBass takes advantage of the ability for the human ear to distinguish between two different tones. By using this feature, TruBass gives enhanced bass sound that otherwise would not be heard. Adjust it depending on the user's preference.
Matrix Surround	▶ Off ↔ On ◀		This features the spacious sound effects of a stadium.
Perfect Volume	▶ Off ↔ On ◀		This will automatically adjust volume so each channel and input has the same average volume level.
Reset	(off the function)	(waiting to reset)	The original factory settings for the items of this Menu page can be restored by pressing the OK button.

## TIMER MENU

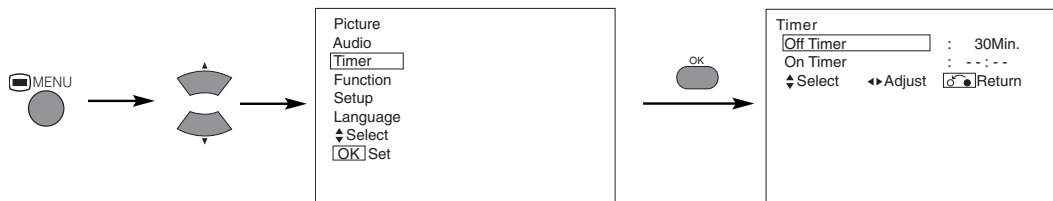

Selected characters	◀	▶	Setup hint
Off Timer	--Min. ↔ 30Min. ↔ 60Min. ↔ 120Min. ↔ 90Min. ◀		This function sets the power to standby status when the indicated time period has elapsed.
On Timer	-- (: --) hours	(- - : -) minutes	This sets the power from standby to ON when the indicated time period has elapsed. The settable time is 00:00~11:59. Input the required time by ▼▲ SELECT buttons on the remote control.

# OPERATING INSTRUCTIONS (continued)

## FUNCTION MENU

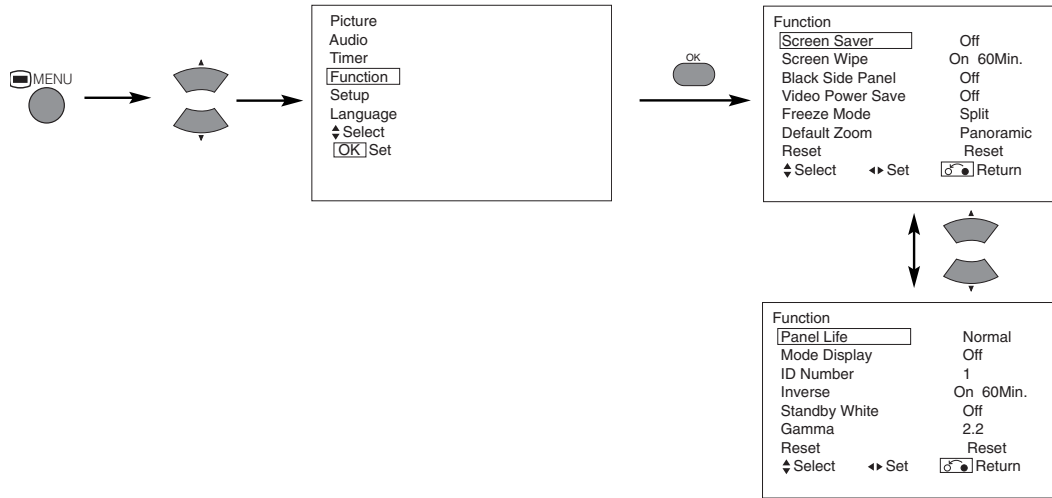

Selected characters	◀	▶	Setup hint
Screen Saver	◀ Off ↔ 5Min. ↔ 10Min. ↔ 60Min. ↔ 40Min. ↔ 20Min. ▶		This moves the picture around the screen in small amounts, at set intervals, to reduce the panel image retention. This prevents stationary objects, such as screen logos, from leaving a slight image visible after they should have disappeared.
Screen Wipe	On	60Min.	Select On (continuous operation) or 60 Min. (time limit operation) and press the OK button. Press the MENU or RETURN button on the remote control to return to normal viewing.
Black Side Panel	◀ Off ↔ On ▶		This turns the gray sidebars On/Off when watching normal mode screen size area. It is always set to Off when the monitor is powered On. It is recommended to set to Off to reduce the panel image retention.
Video Power Save		(grayed out-not available)	
Freeze Mode		(grayed out-not available)	
Default Zoom		(grayed out-not available)	
Reset	(Exit the function)	(waiting to reset)	The original factory settings for the items of this Menu page can be restored by pressing the OK button.
Panel Life	Normal ↔ Extend 1 ↔ Extend 2		This function is to suppress the contrast of the screen regardless of the Contrast setting in the Picture Menu. By this control, power consumption can be reduced or degradation of a panel can be mitigated. The order of power consumption is Extend 2 < Extend 1 < Normal. If the Contrast setting is changed when this item is set to Extend 1 or 2, it will be changed to Normal automatically.
Mode Display	◀ Off ↔ On ▶		This can display the Input Signal Screen Display every time the input mode and signal mode are changed. Set to OFF if the Input Signal Screen Display is not needed when switching signals.
ID Number	1 ↔ 2 ↔ 3 ↔ 4 7 ↔ 6 ↔ 5		Assigns ID nos. to the monitors so that they can be controlled individually (up to 7 monitors can be controlled).
Inverse	On	60Min.	This function can change each level of RGB signal invert to reduce the panel image retention. When this function is required, select On (continuous operation) or 60Min. (time limit operation) and press the OK button. Press the Menu or Return button to exit.
Standby White	◀ Off ↔ 15Min. ↔ 30Min. ↔ 120Min. ↔ 60Min. ▶		This function is also provided to prevent image retention. If time is set for this item, the screen changes to the white pattern when the monitor enters power save mode, and it will continue for the period of the setting time.
Gamma	◀ 2.2 ↔ 2.8 ▶		Normally set to 2.2.



# OPERATING INSTRUCTIONS (continued)

## SETUP MENU

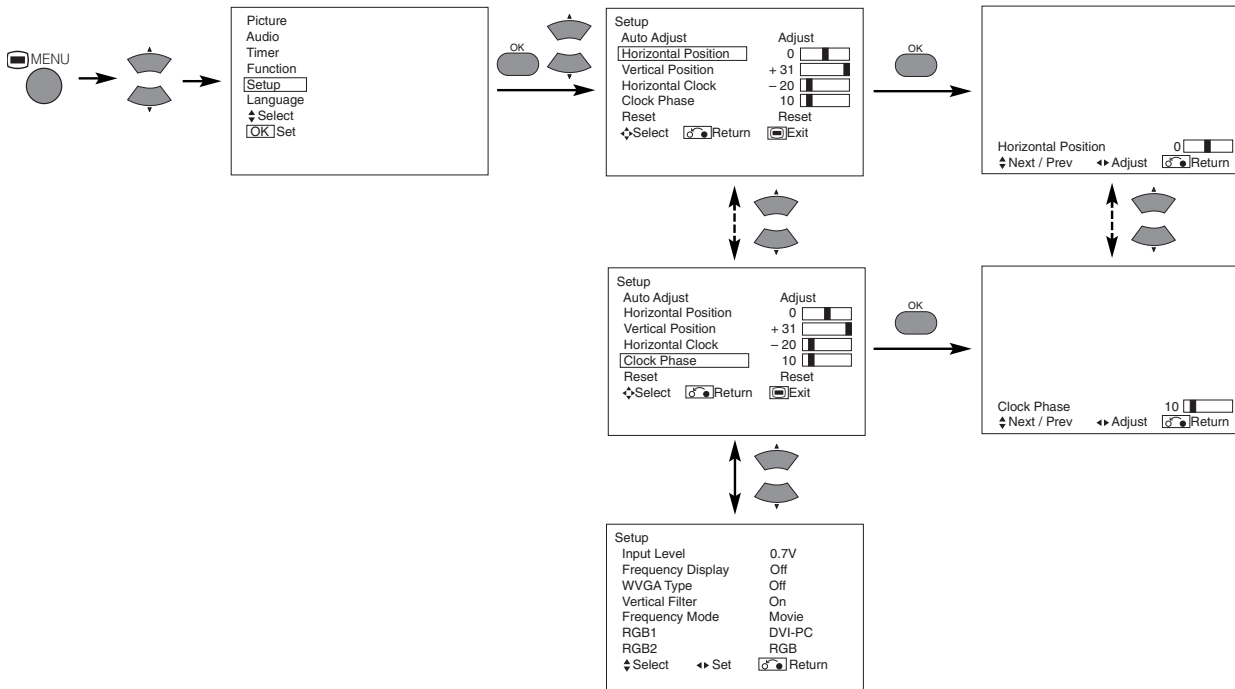

Selected characters	◀	▶	Setup hint
Auto Adjust*	(Menu)	Adjust Pressing the OK button here, Automatic regulation is started.	Horizontal Position, Vertical Position, Horizontal Clock and Clock Phase are adjusted automatically.
Horizontal Position	Moves the horizontal position to left. 	Moves the horizontal position to right. 	Adjust the left-side display position. (This function is only for RGB2. It's not available (grayed out) for RGB1.)
Vertical Position	Moves down the vertical position. 	Moves up the vertical position. 	Adjust the vertical display position. (This function is only for RGB2. It's not available (grayed out) for RGB1.)
Horizontal Clock	Reduces the dot clock frequency (shrinks the right side). 	Increases the dot clock frequency (expands the right side). 	Adjust for maximum character clarity. (This function is only for RGB2. It's not available (grayed out) for RGB1.)
Clock Phase	Slows the dot clock phase (shifts slightly to left). 	Advances the dot clock phase (shifts slightly to right). 	Adjust for clear character visibility. (This function is only for RGB2. It's not available (grayed out) for RGB1.)
Reset	(Exit the function)	(waiting to reset)	The original factory settings for the items of this Menu page can be restored by pressing the OK button. (This is effective only for RGB2.)
Input Level			Normally set to 0.7 V. If white is found to spread across the screen, set to 1.0 V. (This is effective only for RGB2.)
Frequency Display			Set this to Off if the frequency information of the Input Signal Screen Display is not required.
WVGA Type			This is only available for W-VGA signal. When it is set to On, the display area mode can be selected Full or Real.
Vertical Filter			Turn On when concerned about screen flicker.
Frequency Mode			Set to Movie when viewing moving images on a personal computer.
RGB1	(grayed out-not available)		
RGB2	(grayed out-not available)		

\* Depending on the type of signal, the display may not be optimized through automatic adjustment. Adjust manually to optimize them.

# OPERATING INSTRUCTIONS (continued)

## LANGUAGE MENU

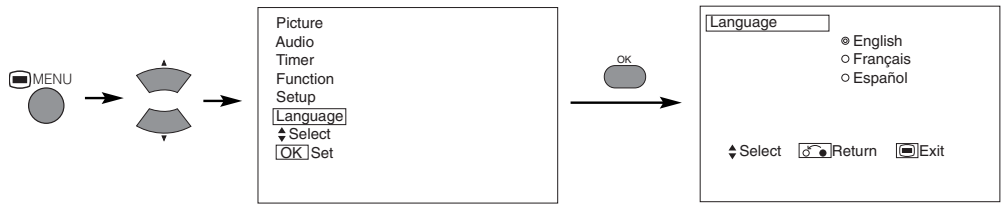

Select a language by ▼▲ SELECT buttons and press the OK button.

## OTHER FEATURES

### Automatic Store

Approximately 1 sec. after adjustment is completed, the adjustments will be recorded as shown in the table below.

Menu	Display	Registration condition	
Picture	Contrast	For every input function, 1 setting is registered.	
	Brightness		
	Color		
	Tint		
	Picture Enhancement		
	Color temperature		
	Color Temp. Adjust		
	R Amplitude		For every Color Temperature, 1 setting is registered.
	G Amplitude		
	B Amplitude		
R Cut Off			
G Cut Off			
B Cut Off			
Audio	Audio Mode	1 setting is registered.	
	Treble	For every Audio Mode, 1 setting is registered.	
	Bass		
	Balance	1 setting is registered.	
	SRS TruBass	For every Audio Mode, 1 setting is registered.	
	Matrix Surround		
Perfect Volume			



Menu	Display	Registration condition	
Function	Screen Saver	1 setting is registered.	
	Screen Wipe	(not registered)	
	Black Side Panel	(not registered)	
	Panel Life	1 setting is registered.	
	Mode Display		
	ID Number		
	Inverse		
	Standby White		
	Gamma		
	Setup		Auto Adjust
Horizontal Position			For RGB1, 1 setting is registered.
Vertical Position			
Horizontal Clock			
Clock Phase			
Input Level		1 setting is registered.	
Frequency Display			
WVGA Type			
Vertical Filter			
Frequency Mode			
Language		1 setting is registered.	

- The previously recorded items will be lost.
- The signal mode can be identified by the horizontal/vertical sync frequency and the sync signal polarity. Different signals where all the elements are the same or similar will be handled as the same signal.

## OTHER FEATURES (continued)

### Signal Check

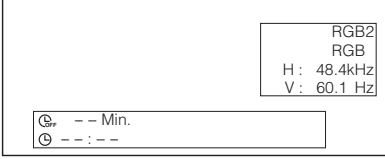
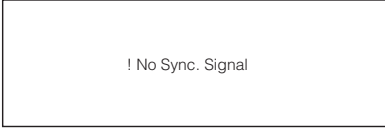
Changes in the signal status are displayed on the screen.

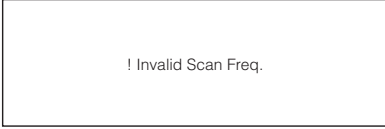
Status	Display	Action	RGB
When Mode Display is set to ON, the input signal is switched or when the RECALL button is pressed.	A guide is displayed for the input terminal and the horizontal and vertical sync frequency.	_____	
When the sync signal is no longer detected.	<ul style="list-style-type: none"> <li>A guide displays No Sync. Signal, and Power Save (for approx. 5 sec.)</li> <li>When the condition continues where the sync signal cannot be detected, indicator lamp of power source changes to orange and the mode switches to power save mode.</li> </ul>	Recheck the personal computer power switch status and the connection status.	
When the input signal does not match the monitor specifications or is in an unstable status.	A guide displays Invalid Scan Freq.	Recheck the input signal specifications. 	

### Power Save Mode

#### When the RGB1, RGB2 input is selected

- When this unit is connected to a VESA DPMS computer, the Power Save (Off) mode can be set to be activated automatically when the computer is not being used to reduce power consumption by this unit.

RGB sync signal	Horizontal	Yes	No	Yes	No
	Vertical	Yes	Yes	No	No
PC signal		Active (normal display)	Blank (no display)		
Operation mode		On	Off		
Indicating lamp		Lights green	Lights orange		
Power consumption		365W	3W or less (RGB1) 1W or less (RGB2 ; $100V \leq AC \leq 120V$ ) 3W or less (RGB2 ; $120V < AC \leq 240V$ )		

#### Returning to operating status

- Operate the personal computer, or press either the INPUT SELECT button of the main unit or the RGB1/RGB2 buttons of the remote control.

## IMAGE RETENTION OF PLASMA DISPLAY

There are different characteristics that result in panel image retention depending on how the plasma display is used. Situations and effective usage methods related to ghosting are provided below.

### Image retention characteristics of a plasma display

The image retention phenomenon of a plasma panel occurs because of partial phosphor degradation arising from partial character and figure display.

For example, when the character image as shown in Fig. A at the right is continuously displayed for a long period of time, the only part of the phosphor (Red, Green, Blue) that will degrade will be the color of the applicable character display portion. Consequently, when a white image is displayed on the entire screen as shown in Fig. a, the character marks displayed up to that time will become a color difference visible to the eye, but the phosphor will never burn.

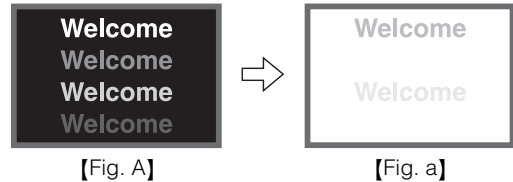

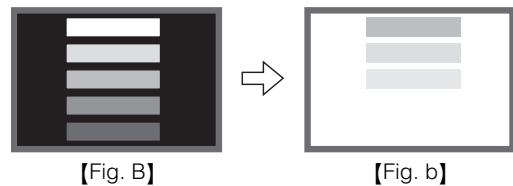

■ The degree of image retention is proportional to the brightness of the characters and figures displayed as well as the display time.

- The tendency of the phosphor is to degrade more the brighter the characters and figures are displayed. When images of figures with different levels of brightness, as shown in Fig. B, are continuously displayed for a long period of time, it becomes easier to see image marks at locations when the brighter figures are displayed to see.



\* The image retention images in this document are exaggerated for the purpose of explanation. The actual manner in which the image retention is seen differs depending on the operation time and brightness.

### Methods to Reduce the Occurrence of Image Retention

- Lower the Contrast and Brightness settings of the plasma display as much as possible.  
A function is provided in the display that controls the brightness of the screen to reduce degradation of the panel. Using this function makes it possible to reduce image retention.  
(Refer to Panel Life (Extend 1. or Extend 2 shown on  )
- Set the plasma monitor to an "Screen Wipe" or "Inverse" display.  
The occurrence of image retention when displaying images of identical patterns, such as static images, for long periods of time can be reduced by displaying a reversed color or completely white screen for about 1 ~ 2 hours after terminating the display.  
(Settings can be made using Screen Wipe and Inverse of Function MENU shown on  )
- Using in combination with moving images  
Since the degradation of the fluorescent material progresses comparatively uniformly for moving images, the occurrence of partial image retention can be minimized by usage in combination with moving images such as DVDs.  
\* Please be careful since image retention will occur if display is left in a two screen display state for a long period of time.  
\* Television broadcasts include images displayed for long periods of time in which the left and right or top and bottom of the image are cut and broadcast station name or time are displayed in the same portion of the screen. Image retention in these portions can be expected to occur, so please be aware.

## NOTES

### About screen defects

- High precision technology is used in the making of plasma panels but there may be dark spots (points that do not illuminate) and bright spots (points that are too bright) in some cases. These do not indicate a malfunction.

### About residual images

- In some cases, residual images may remain after the short-term display of still images, but these will disappear and return to normalcy. This is not a malfunction.

### About the panel screen

- Plasma displays create images by means of electrical discharges inside the panel. Because of this, the temperature of the panel surface may rise in some cases. Also, plasma displays are made of finely processed glass. A reinforced glass filter is installed over the panel surface but avoid strong impact because there is still danger of glass breakage.

# TROUBLESHOOTING

## Symptoms That Appear to be Failures

Make the checks suggested below depending on the symptoms observed. If the symptoms remain, contact your dealer.





**WARNING**

Customer servicing can be hazardous.

Symptom		Point to check	See page
<ul style="list-style-type: none"> <li>No picture with the power-indicator lamp off.</li> </ul>		<ul style="list-style-type: none"> <li>Check to ensure the power cable is connected.</li> <li>Press the power switch.</li> </ul>	<div style="border: 1px solid black; padding: 2px; display: inline-block;">15</div> <div style="border: 1px solid black; padding: 2px; display: inline-block;">16</div>
<ul style="list-style-type: none"> <li>The message "No Sync. Signal" or "Power Save" is displayed.</li> <li>No picture with the power indicator lamp light orange.</li> </ul>	<div style="border: 1px solid black; padding: 2px; display: inline-block;">! No Sync. Signal</div> 	<p>No sync signal is detected.</p> <ul style="list-style-type: none"> <li>Check to ensure the signal cable is connected.</li> <li>Make sure that the switch of the computer, imaging equipment, etc., is turned on.</li> <li>Make sure the computer is not in the power-save mode.</li> <li>Check to see if the input selection matches the connection terminal.</li> </ul>	<div style="border: 1px solid black; padding: 2px; display: inline-block;">14</div>
<ul style="list-style-type: none"> <li>The message "Invalid Scan Freq." is displayed.</li> </ul>	<div style="border: 1px solid black; padding: 2px; display: inline-block;">! Invalid Scan Freq.</div>	<p>An input signal is not being received normally.</p> <ul style="list-style-type: none"> <li>Check to see if the input signal matches the monitor specifications.</li> <li>Check to ensure the signal cable is connected.</li> </ul>	<div style="border: 1px solid black; padding: 2px; display: inline-block;">14</div> <div style="border: 1px solid black; padding: 2px; display: inline-block;">31</div> <div style="border: 1px solid black; padding: 2px; display: inline-block;">32</div>
<ul style="list-style-type: none"> <li>The power indicator lamp is normally lit but no picture.</li> </ul>		<ul style="list-style-type: none"> <li>Check the contrast and brightness settings (adjust them for higher contrast and brightness).</li> <li>Check to ensure the signal cable is connected.</li> </ul>	<div style="border: 1px solid black; padding: 2px; display: inline-block;">14</div> <div style="border: 1px solid black; padding: 2px; display: inline-block;">20</div>
<ul style="list-style-type: none"> <li>The display image appears to be flowing slantwise.</li> <li>Text displayed across the screen appears vertically streaked, with the characters in vertical columns blurred.</li> </ul>	 	<ul style="list-style-type: none"> <li>Adjust the dot clock frequency and phase. (Adjust the dot clock frequency first, then the dot clock phase) (RGB input)</li> </ul>	<div style="border: 1px solid black; padding: 2px; display: inline-block;">23</div> <div style="border: 1px solid black; padding: 2px; display: inline-block;">29</div>
<ul style="list-style-type: none"> <li>Text displayed across the screen appears blurred.</li> <li>A fine pattern flickers when displayed on the screen.</li> </ul>	<div style="border: 1px dashed black; padding: 2px; display: inline-block;">A</div> 	<ul style="list-style-type: none"> <li>Adjust the dot clock phase for the clearest viewing. (RGB input)</li> </ul>	<div style="border: 1px solid black; padding: 2px; display: inline-block;">23</div> <div style="border: 1px solid black; padding: 2px; display: inline-block;">29</div>
<ul style="list-style-type: none"> <li>The remote control does not work.</li> </ul>		<ul style="list-style-type: none"> <li>Check to see if the batteries are loaded in the remote control correctly.</li> <li>Try loading new batteries in the remote control.</li> </ul>	<div style="border: 1px solid black; padding: 2px; display: inline-block;">12</div>

## TROUBLESHOOTING (continued)

### Symptoms That Appear to be Failures (continued)

Symptom	Point to check	See page
<ul style="list-style-type: none"> <li>The temperature of the display panel surface is high.</li> </ul>	<ul style="list-style-type: none"> <li>The plasma display panel is lighting the phosphors by the discharge of internal energy. In some cases, this may cause the temperature of the panel surface to increase. Please note that this is not a malfunction.</li> </ul>	-
<ul style="list-style-type: none"> <li>There are locations on the screen that are different from the periphery (*). *Points that do not light, points with brightness different from that of the periphery, points with color different from that of the periphery, etc.</li> </ul>	<ul style="list-style-type: none"> <li>High-precision technology is used to manufacture the plasma display panel. However in some cases, there are minor defects in some parts of the screen. Please note that this is not a malfunction.</li> </ul>	-
<ul style="list-style-type: none"> <li>Vertical stripes appear, depending on the screen contents.</li> </ul>	<ul style="list-style-type: none"> <li>The plasma display panel is lighting the phosphors by the discharge of internal energy. Depending on the screen contents, in rare cases, this may cause vertical stripes to appear because the phosphors fail to light. Please note that this is not a malfunction.</li> </ul>	-
<ul style="list-style-type: none"> <li>Coarse horizontal stripes appear in FULL display.</li> </ul>	<ul style="list-style-type: none"> <li>Adjusting the Clock Phase will reduce the horizontal stripes. (RGB input)</li> </ul>	 23
<ul style="list-style-type: none"> <li>Flickering in the form of horizontal lines oscillating up and down. (PC INPUT MODE only)</li> </ul>	<ul style="list-style-type: none"> <li>If the direct frequency from the computer is below 85Hz, try a higher frequency (upper limit 85Hz). There may be a slight attenuation of the current image.</li> <li>Try turning the Vertical Filter On. For this case however, the vertical resolution will drop.</li> </ul>	 23
<ul style="list-style-type: none"> <li>The fan motor is noisy. (Only for models with fan.)</li> </ul>	<ul style="list-style-type: none"> <li>The fan lowers the temperature of this unit. If the ambient air temperature increases, the fan RPMs increase and motor noise increases. This is not a malfunction.</li> </ul>	-
<ul style="list-style-type: none"> <li>The top of the monitor heats up.</li> </ul>	<ul style="list-style-type: none"> <li>When used for long periods of time, the top of the monitor may heat up. This is not a malfunction.</li> </ul>	-
<ul style="list-style-type: none"> <li>Text characters are displayed with varying thicknesses.</li> </ul>	<ul style="list-style-type: none"> <li>The thicknesses of characters and lines may vary if images with a vertical resolution greater than 512 lines are displayed. This is not a malfunction.</li> </ul>	-

# TROUBLESHOOTING (continued)

## Actions to Correct Abnormal Images

Depending on the kind of system equipment used, images may not be displayed normally. In this case, make the adjustments suggested below. (only for RGB2)



Symptom 1	Text displayed across the screen appears vertically streaked, with some characters blurred (figure 1). The display image appears flowing (figure 2) (RGB input).
Example	<p>Figure 1</p> <p>Figure 2</p>
Adjustment procedure	<p>1) Press the AUTO button on the remote control.</p> <p>When adjustment is not possible with Auto Adjust</p> <p>2) Press the MENU button. The Main Menu will be displayed.</p> <p>3) Press the ▼ SELECT button and select Setup.</p> <p>4) Press the OK button. The Setup Menu will be displayed.</p> <p>5) Press the ▼ SELECT button and select Horizontal Clock.</p> <p>(Display fine patterns as characters or a vertical striped pattern over the entire screen during Horizontal Clock adjustment.)</p> <p>6) Press the ► or ◀ ADJUST buttons and search for clear characters over the entire screen.</p> <p>7) When the characters are blurred on the entire screen, make the adjustment for Symptom 2 below.</p>

- The display image may be momentarily disturbed during clock adjustment but this is not a failure.

Symptom 2	Text displayed across the screen appears blurred in its entirety (figure 2). A fine pattern flickers when displayed on the screen (figure 3).	
Example	<p>Figure 2</p>	<p>Figure 3</p>
Adjustment procedure	<p>1) Press the AUTO button on the remote control.</p> <p>When adjustment is not possible with Auto Adjust</p> <p>2) Press the MENU button. The Main Menu will be displayed.</p> <p>3) Press the ▼ SELECT button and select Setup.</p> <p>4) Press the OK button. The Setup Menu will be displayed.</p> <p>5) Press the ▼ SELECT button and select Clock Phase.</p> <p>(Display fine patterns as characters or a vertical striped pattern over the entire screen during Clock Phase adjustment.)</p> <p>6) Press ► or ◀ ADJUST buttons to make the text appear clean across the screen.</p> <p>6) Press ► or ◀ ADJUST buttons to make the text not flicker.</p>	

## PRODUCT SPECIFICATIONS

Product specifications and designs are subject to change without notice.

<b>Panel</b>	<b>Display dimensions</b>	Approx. 42 inches (922 (H) x 522 (V) mm, diagonal 1059mm)
	<b>Resolution</b>	1024 (H) x 1024 (V) pixels
<b>Net dimensions (excluding Speakers/Stand)</b>		1030 (W) x 636 (H) x 91 (D) mm
<b>Net weight (excluding Speakers/Stand)</b>		34.9kg
<b>Ambient conditions</b>	<b>Temperature</b>	Operating : 5°C to 35°C, Storage : 0°C to 40°C
	<b>Relative humidity</b>	Operating : 20% to 80%, Storage : 20% to 90% (non-condensing)
<b>Power supply</b>		AC100 - 240V, 50/60Hz
<b>Power consumption/at standby</b>		365W / <3W
<b>Audio output</b>		12W + 12W (6Ω)
<b>(RGB input)</b>		
<b>Input signals</b>	<b>Input terminals</b>	RGB1 DVI input terminal (DVI-D) RGB1 audio input terminal (3.5mm Stereo Mini Jack) RGB2 analog RGB input terminal (D-sub 15-pin) RGB2 audio input terminal (3.5mm Stereo Mini Jack)
	<b>Video signals</b>	0.7 V/1.0 Vp-p, analog RGB (Recommended Signal)
	<b>Sync signals</b>	H/V separate, TTL level [2KΩ] H/V composite, TTL level [2KΩ] Sync on green, 0.3 Vp-p [75Ω]
<b>Recommended signal</b>		42 modes  

- The monitor takes at least 30 minutes to attain the status of optimal picture quality.

## Signal Input

### RGB terminal (D-sub 15-pin connector)

Pin	Input signal
1	R
2	G or sync on green
3	B
4	No connection
5	No connection
6	R.GND
7	G.GND
8	B.GND
9	No connection
10	GND
11	No connection
12	[SDA]
13	H. sync or H/V composite sync
14	V.sync. [V.CLK]
15	[SCL]

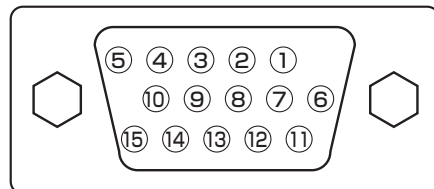

- When different kinds of input signals are simultaneously input to the monitor via a graphics board or the like, the monitor will automatically select the signals in the following priority order:

Sync signal type	Priority
H/V separate sync.	1
H/V composite sync.	2
sync.on Green *	3

\*Even in the case of the recommended signals shown on the following page, there may be instances when correct display is not possible. In this case, use H/V separate sync, H/V composite sync.



## PRODUCT SPECIFICATIONS (continued)

### Signal Input (continued)

#### DVI terminal (DVI-D)

Pin	Input signal	Pin	Input signal
1	T.M.D.S. Data2-	14	+5V Power
2	T.M.D.S. Data2+	15	Ground (for+5V)
3	T.M.D.S. Data2/4 Shield	16	Hot Plug Detect
4	T.M.D.S. Data4-	17	T.M.D.S. Data0-
5	T.M.D.S. Data4+	18	T.M.D.S. Data0+
6	DDC Clock	19	T.M.D.S. Data0/5 Shield
7	DDC Data	20	T.M.D.S. Data5-
8	No Connect	21	T.M.D.S. Data5+
9	T.M.D.S. Data1-	22	T.M.D.S. Clock Shield
10	T.M.D.S. Data1+	23	T.M.D.S. Clock+
11	T.M.D.S. Data1/3 Shield	24	T.M.D.S. Clock-
12	T.M.D.S. Data3-	Frame	GND
13	T.M.D.S. Data3+		

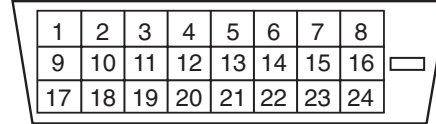

### Recommended Signal List

#### With Digital RGB signal input (RGB1 input)

No.	Signal mode			Horizontal frequency (kHz)	Dot clock frequency (MHz)	Remarks
	Signal Name	Resolution	Vertical frequency (Hz)			
1	VGA	640 X 400	70.08	31.47	25.18	
2		640 X 480	59.94	31.47	25.18	
3	W-VGA	864 X 480	59.94	31.47	34.24	WVGA type : On
4	VESA	640 X 480	72.81	37.86	31.50	
5		640 X 480	75.00	37.50	31.50	
6		640 X 480	85.01	43.27	36.00	
7		800 X 600	56.25	35.16	36.00	
8		800 X 600	60.32	37.88	40.00	
9		800 X 600	72.19	48.08	50.00	
10		800 X 600	75.00	46.88	49.50	
11		800 X 600	85.06	53.67	56.25	
12		1024 X 768	60.00	48.36	65.00	
13		1024 X 768	70.07	56.48	75.00	
14	1024 X 768	75.03	60.02	78.75		

- Make sure that the signal of the equipment to be connected is compatible with the specifications of this list.

## PRODUCT SPECIFICATIONS (continued)

### Recommended Signal List (continued)

#### With Analog RGB signal input (RGB2 input)

No.	Signal mode			Horizontal frequency (kHz)	Dot clock frequency (MHz)	Remarks
	Signal Name	Resolution	Vertical frequency (Hz)			
1	VGA	640 X 400	70.08	31.47	25.18	
2		640 X 480	59.94	31.47	25.18	
3	W-VGA	864 X 480	59.94	31.47	34.24	WVGA type : On
4	VESA	640 X 480	72.81	37.86	31.50	
5		640 X 480	75.00	37.50	31.50	
6		640 X 480	85.01	43.27	36.00	
7		800 X 600	56.25	35.16	36.00	
8		800 X 600	60.32	37.88	40.00	
9		800 X 600	72.19	48.08	50.00	
10		800 X 600	75.00	46.88	49.50	
11		800 X 600	85.06	53.67	56.25	
12		1024 X 768	60.00	48.36	65.00	
13		1024 X 768	70.07	56.48	75.00	
14		1024 X 768	75.03	60.02	78.75	
15		1024 X 768	85.00	68.68	94.50	
16		1152 X 864	75.00	67.50	108.00	
17		1280 X 1024	60.02	63.98	108.00	
18	1280 X 1024	75.03	79.98	135.00		
19	1280 X 1024	85.02	91.15	157.50		
20	1600 X 1200	60.00	75.00	162.00		
21	1600 X 1200	75.00	93.75	202.50		
22	1600 X 1200	85.00	106.25	229.50		
23	Macintosh	640 X 480	66.67	35.00	30.24	
24		832 X 624	74.55	49.72	57.28	
25		1024 X 768	74.93	60.24	80.00	
26		1152 X 870	75.06	68.68	100.00	
27	W-XGA	1280 X 768	59.833	47.986	81.00	
28		1280 X 768	69.997	56.137	94.760	

- The type of video board or connecting cable used may not allow for correct displays adjustment of Horizontal Position, Vertical Position, Horizontal Clock and Clock Phase.
- The monitor may fail to display an animation image correctly when a signal having a vertical frequency of 85Hz or higher is input to it.
- The monitor differentiates the signal modes according to the horizontal and vertical frequencies and the horizontal and vertical sync signal polarities. Note that different signals having all these elements alike may be handled as the same signal.
- Displaying images with more than 512 lines of vertical resolution at Full display (compressed display) can result in the interpolation of stripes.

# Customer Support

For technical support or product service, see the table below or contact your reseller.

**NOTE:** You will need the product serial number.

<b>Country/ Region</b>	<b>Web site</b>	<b>T = Telephone F = FAX</b>	<b>Email</b>
United States	www.viewsonic.com/ support	<b>T:</b> (800) 688-6688 <b>F:</b> (909) 468-1202	service.us@ viewsonic.com
Canada	www.viewsonic.com/ support	<b>T:</b> (800) 688-6688 <b>F:</b> (909) 468-1202	service.ca@ viewsonic.com
United Kingdom	www.viewsoniceurope.com	<b>T:</b> 0800 833 648 <b>F:</b> (01293) 643910	service.eu@ viewsoniceurope.com
Europe, Middle East, Baltic countries, and North Africa	www.viewsoniceurope.com	Contact your reseller	service.eu@ viewsoniceurope.com
Australia and New Zealand	www.viewsonic.com.au	<b>T:</b> +61 2 9906 6277 <b>F:</b> +61 2 9906 6377	service@au. viewsonic.com
Singapore/ Malaysia/Thailand	www.viewsonic.com.sg	<b>T:</b> 65 273 4018 <b>F:</b> 65 273 1566	service@sg. viewsonic.com
South Africa/ Other countries	www.viewsonic.com	<b>T:</b> 886 2 2246 3456 <b>F:</b> 886 2 8242 3668	service@sd. viewsonic.com
Hong Kong	www.hk.viewsonic.com	<b>T:</b> 886 2 2246 3456 <b>F:</b> 886 2 8242 3668	service@hk. viewsonic.com

# LIMITED WARRANTY

## VIEWSONIC Plasma Display

### What the warranty covers:

ViewSonic® warrants its products to be free from defects in material and workmanship during the warranty period. If a product proves to be defective in material or workmanship during the warranty period, ViewSonic will at its sole option repair or replace the product with a like product. Replacement product or parts may include remanufactured or refurbished parts or components.

### How long the warranty is effective:

ViewSonic Plasma Display's are warranted for twelve(12) months for all parts, twelve(12) months for all labor.

### Who the warranty protects:

This warranty is valid only for the first consumer purchaser.

### What the warranty does not cover:

1. Any product on which the serial number has been defaced, modified or removed.
2. Damage, deterioration or malfunction resulting from:
  - a. Accident, misuse, neglect, fire, water, lightning, or other acts of nature, unauthorized product modification, or failure to follow instructions supplied with the product.
  - b. Repair or attempted repair by anyone not authorized by ViewSonic.
  - c. Any damage of the product due to shipment.
  - d. Removal or installation of the product.
  - e. Causes external to the product, such as electric power fluctuations or failure.
  - f. Use of supplies or parts not meeting ViewSonic's specifications.
  - g. Normal wear and tear.
  - h. Any other cause which does not relate to a product defect.
3. Removal, installation, and set-up service charges.

### How to get service:

1. For information about receiving service under warranty, contact ViewSonic Customer Support at 800-888-8583. You will need to provide your product's serial number.
2. To obtain warranted service, you will be required to provide (a) the original dated sales slip, (b) your name, (c) your address, (d) a description of the problem, and (e) the serial number of the product.
3. Take or ship the product freight prepaid in the original container to an authorized ViewSonic service center or ViewSonic.
4. For additional information or the name of the nearest ViewSonic service center, contact ViewSonic.

### Limitation of implied warranties:

**THERE ARE NO WARRANTIES, EXPRESS OR IMPLIED, WHICH EXTEND BEYOND THE DESCRIPTION CONTAINED HEREIN INCLUDING THE IMPLIED WARRANTY OF MERCHANTABILITY AND FITNESS FOR A PARTICULAR PURPOSE.**

### Exclusion of damages:

**VIEWSONIC'S LIABILITY IS LIMITED TO THE COST OF REPAIR OR REPLACEMENT OF THE PRODUCT. VIEWSONIC SHALL NOT BE LIABLE FOR:**

1. DAMAGE TO OTHER PROPERTY CAUSED BY ANY DEFECTS IN THE PRODUCT, DAMAGES BASED UPON INCONVENIENCE, LOSS OF USE OF THE PRODUCT, LOSS OF TIME, LOSS OF PROFITS, LOSS OF BUSINESS OPPORTUNITY, LOSS OF GOODWILL, INTERFERENCE WITH BUSINESS RELATIONSHIPS, OR OTHER COMMERCIAL LOSS, EVEN IF ADVISED OF THE POSSIBILITY OF SUCH DAMAGES.
2. ANY OTHER DAMAGES, WHETHER INCIDENTAL, CONSEQUENTIAL OR OTHERWISE.
3. ANY CLAIM AGAINST THE CUSTOMER BY ANY OTHER PARTY.

### Effect of state law:

This warranty gives you specific legal rights, and you may also have other rights which vary from state to state. Some states do not allow limitations on implied warranties and/or do not allow the exclusion of incidental or consequential damages, so the above limitations and exclusions may not apply to you.

### Sales outside the U.S.A. and Canada:

For warranty information and service on ViewSonic products sold outside of the U.S.A. and Canada, contact ViewSonic or your local ViewSonic dealer.

Plasma Warranty (V2.1)

Release Date: 04-18-2001

# Power Cord Safety Guidelines

**Caution:** Use a power cable that is properly grounded. Always use an AC power cord that meets your country's safety standard.

USA.....	UL	Switzerland.....	SEV
Canada .....	CSA	Britain.....	BASE/BS
Germany.....	VDE	Japan.....	Electric Appliance Control Act

## AC PLUG CORD PRECAUTIONS FOR THE UNITED KINGDOM

FOR YOUR SAFETY PLEASE READ THE FOLLOWING TEXT CAREFULLY.

IF THE FITTED MOULDED PLUG IS UNSUITABLE FOR THE SOCKET OUTLET THEN THE PLUG SHOULD BE CUT OFF AND DISPOSED OF SAFELY.

THERE IS A DANGER OF SEVERE ELECTRICAL SHOCK IF THE CUT OFF PLUG IS INSERTED INTO AN APPROPRIATE SOCKET.

If a new plug is to be fitted, please observe the wiring code as shown below.

If in any doubt, please consult a qualified electrician.

**WARNING:** THIS APPLIANCE MUST BE EARTHED.

**IMPORTANT:** The wires in this mains lead are coloured in accordance with the following code:

Green-and-Yellow: Earth

Blue: Neutral

Brown: Live

If the coloured wires of the mains lead of this appliance do not correspond with the coloured markings identifying the terminals in your plug, proceed as follows:

The wire which is coloured GREEN-AND-YELLOW must be connected to the terminal in the plug which is marked by the letter E or by the Earth symbol or coloured GREEN or GREEN-AND-YELLOW.

The wire which is coloured BLUE must be connected to the terminal in the plug which is marked with the letter N or coloured BLACK. The wire which is coloured BROWN must be connected to the terminal in the plug which is marked with the letter L or coloured RED.

## IMPORTANT NOTICE CONCERNING POWER CORD SELECTION

The power cord set for this unit has been enclosed and has been selected according to the country of destination and must be used to prevent electric shock. Use the following guidelines if it is necessary to replace the original cord set, or if the cord set is not enclosed.

The female receptacle of the cord set must meet CEE-22 requirements and may look like (Figure A1 below):

Figure A1 

## For the United States and Canada

In the United States and Canada the male plug is a NEMA5-15 style (Figure A2), UL Listed, and CSA Labeled. For units which are mounted on a desk or table, type SVT or SJT cord sets may be used. For units which sit on the floor, only SJT type cord sets may be used. The cord set must be selected according to the current rating for your unit. Please consult the table below for the selection criteria for power cords used in the United States and Canada.

Figure A2 

## For the customer in Canada

Notice: This Class B digital apparatus complies with Canadian ICES-003.

Cord Type	Size of Conductors in Cord	Maximum Current Rating of Unit
SJT	18 AWG	10 Amps
	16 AWG	12 Amps
	14 AWG	12 Amps
SVT	18 AWG	10 Amps
	17 AWG	12 Amps

## For European Countries

In Europe you must use a cord set which is appropriate for the receptacles in your country. The cord set is HAR-Certified, and a special mark that will appear on the outer sheath, or on the insulation of one of the inner conductors. If you have any questions concerning which proper power cord to use, please consult with the dealer from whom you have purchased the product.

# CLEANING AND MAINTENANCE

## Cautions When Using the Plasma Display

- Do not bring your hands, face or objects close to the ventilation holes of the plasma display. The top of plasma display is usually very hot due to the high temperature of exhaust air being released through the ventilation holes. Burns or personal injuries may occur if any body parts are brought too close. Placing any object near the top of the display could also result in heat related damages to the object as well as the display itself.
- Be sure to disconnect all cables before moving the plasma display. Moving the display with its cables attached may damage the cables and thus case fire or electric shock danger.
- Disconnect the power plug from the wall outlet as a safety precaution before carrying out any type of cleaning or maintenance procedure.



## Front Panel Cleaning Instructions

- The front of the display has been specially treated. Wipe the surface gently using only a cleaning cloth or a soft, lint-free cloth.
- If the surface is particularly dirty, soak a soft, lint-free cloth in a mild detergent solution. Wring the cloth to remove excess liquid. Wipe the surface of the display to remove dirt. Then use a dry cloth of the same type to dry.
- Do not scratch or hit the surface of the panel with fingers or hard objects of any kind.
- Do not use volatile substances such as insect sprays, solvents and thinners.

## Cabinet Cleaning Instructions

- If the cabinet becomes dirty, wipe the cabinet with a soft, dry cloth.
- If the cabinet is extremely dirty, soak a lint-free cloth in a mild detergent solution. Wring the cloth to remove as much moisture possible. Wipe the cabinet. Use another dry cloth to wipe over until the surface is dry.
- Do not allow any water or detergent to come into contact with the surface of the display. If water or moisture gets inside the unit, operating problems, electrical and shock hazards may result.
- Do not scratch or hit the cabinet with fingers or hard objects of any kind.
- Do not use volatile substances such as insect sprays, solvents and thinners on the cabinet.
- Do not place articles made from rubber or PVC near the cabinet for any extended periods of time.



## Avoid Still Images

- Do not allow a still picture to be displayed for extended periods of time. This can cause a permanent image to remain on the plasma display. Examples of still images may include: still computer images, still video game images, still logos or pictures, text and images displayed in 4:3 Normal mode.



**Contents of this manual is subject to change without notice.**

## Trademark Credits

- VGA is a trademark of IBM Corporation.
- Macintosh is a registered trademark of Apple Computer Corporation.
- SVGA is a registered trademark of the Video Electronics Standard Association.
- BBE is a registered trademark of BBE Sound Inc.
- SRS and  symbol are trademarks of SRS Labs Inc.  
SRS technology is incorporated under license from SRS Labs, Inc.
- All other trademarks are the properties of their respective owners.

## FCC Information

This equipment has been tested and found to comply with the limits for a Class A digital device, pursuant to part 15 of the FCC Rules. These limits are designed to provide reasonable protection against harmful interference in a residential installation. This equipment generates, uses, and can radiate radio frequency energy, and if not installed and used in accordance with the instructions, may cause harmful interference to radio communications. However, there is no guarantee that interference will not occur in a particular installation. If this equipment does cause harmful interference to radio or television reception, which can be determined by turning the equipment off and on, the user is encouraged to try to correct the interference by one or more of the following measures:

- Reorient or relocate the receiving antenna.
- Increase the separation between the equipment and receiver.
- Connect the equipment into an outlet on a circuit different from that to which the receiver is connected.
- Consult the dealer or an experienced radio/TV technician for help.

### FCC Warning

To assure continued FCC compliance, the user must use grounded power supply cord and the provided shielded video interface cable with bonded ferrite cores. If a BNC cable is going to be used, use only a shielded BNC(5) cable. Also, any unauthorized changes or modifications not expressly approved by the party responsible for compliance could void the user's authority to operate this device.

### Instructions to Users

This equipment complies with the requirements of FCC (Federal Communication Commission) equipment provided that the following condition is met. Use the cables which are included with the projector or specified.

## Compliance Information for Canada

Notice: This class A digital apparatus complies with Canadian ICES-003.

AVIS: Cet appareil numérique de la Classe A conforme a la norme NMB-003 du Canada.

## Compliance Information for European Countries

### CE Conformity



The device complies with the requirements of the EEC directive 89/336/EEC as amended by 93/68/EEC Art.5 with regard to "Electromagnetic compatibility," and 73/23/EEC as amended by 93/68/EEC Art.13 with regard to "Safety."

## User Information for All Countries

NOTICE: Use the cables which are included with the Plasma Display or specified.

**ViewSonic<sup>®</sup> Corporation**



## Free Manuals Download Website

<http://myh66.com>

<http://usermanuals.us>

<http://www.somanuals.com>

<http://www.4manuals.cc>

<http://www.manual-lib.com>

<http://www.404manual.com>

<http://www.luxmanual.com>

<http://aubethermostatmanual.com>

Golf course search by state

<http://golfingnear.com>

Email search by domain

<http://emailbydomain.com>

Auto manuals search

<http://auto.somanuals.com>

TV manuals search

<http://tv.somanuals.com>