

ViewSonic®

VT2645

VT3245

VT3745

LCD TV

- **User Guide**
- **Guide de l'utilisateur**
- **Guía del usuario**

IMPORTANT: Please read this User Guide to obtain important information on installing and using your product in a safe manner, as well as registering your product for future service. Warranty information contained in this User Guide will describe your limited coverage from ViewSonic Corporation, which is also found on our web site at <http://www.viewsonic.com> in English, or in specific languages using the Regional selection box in the upper right corner of our website. "Before operating the equipment, read the instructions in this manual carefully."



ViewSonic®

Model No.: VS12675-1M
VS12664-1M
VS12676-1M

Dear ViewSonic customer,

Congratulations on your purchase of a ViewSonic TV display. For maximum benefit of your TV, please read these instructions before any operations.

For assistance, please contact ViewSonic service team at <http://www.viewsonic.com> or call our service team: United States 1-800-688-6688, Canada 1-866-463-4775.

To purchase or inquire about any accessories and installation services for your TV, please visit www.viewsonic.com or call: United States 1-800-688-6688, Canada 1-866-463-4775.

Important! Please save the original box and all packing material for future shipping needs.

We recommend you to register your TV on the internet at: www.viewsonic.com

Product Registration

To meet your future needs, and to receive any additional product information as it becomes available, please register your product on the internet at: www.viewsonic.com.

For Your Records

Product Name: [] VTxxxx (VT2645, VT3245, or VT3745)

ViewSonic LCD TV

Document Number: [] VTxxxx-1M_UG_ENG Rev. 1A mm-dd-yy

Serial Number: _____

Purchase Date: _____

Product disposal at end of product life

ViewSonic is concerned about the preservation of our environment. Please dispose of this product properly at the end of its useful life. Your local waste disposal company may provide information about proper disposal.

The lamp in this product contains mercury. Please dispose of properly in accordance with environmental laws of your location.

Customer Support

For technical support or product service, see the table below or contact your reseller.

Note: You will need the product serial number.

Country/Region	Web Site	T= Telephone F= Fax	Email
United States	www.viewsonic.com	T (Toll-Free) = 1-800-688-6688 T (Toll) = 1-424-233-2530 F = 1-909-468-1202	service.us@viewsonic.com
Canada	www.viewsonic.com	T (Toll-Free) = 1-866-463-4775 T (Toll) = 1-424-233-2533 F = 1-909-468-1202	service.ca@viewsonic.com
Renta y Datos, 29 SUR 721, COL. LA PAZ, 72160 PUEBLA, PUE. Tel: 01.222.891.55.77 CON 10 LINEAS Electroser, Av Reforma No. 403Gx39 y 41, 97000 Mérida, Yucatán. Tel: 01.999.925.19.16 Other places please refer to http://www.viewsonic.com/la/soporte/index.htm#Mexico			

Contact ViewSonic service team at: <http://www.ViewSonic.com> or call our service team: United States 1-800-688-6688, Canada 1-866-463-4775

ViewSonic

i

VT2645 / VT3245 / VT3745

Contact Information for Sales & Authorized Service (Centro Autorizado de Servicio) within Mexico:	
Name, address, of manufacturer and importers: México, Av. de la Palma #8 Piso 2 Despacho 203, Corporativo Interpalmas, Col. San Fernando Huixquilucan, Estado de México Tel: (55) 3605-1099 http://www.viewsonic.com/la/soporte/index.htm	
NÚMERO GRATIS DE ASISTENCIA TÉCNICA PARA TODO MÉXICO: 001.866.823.2004	
Hermosillo: Distribuciones y Servicios Computacionales SA de CV. Calle Juarez 284 local 2 Col. Bugambillas C.P: 83140 Tel: 01-66-22-14-9005 E-Mail: disc2@hmo.megared.net.mx	Villahermosa: Compumantenimientos Garantizados, S.A. de C.V. AV. GREGORIO MENDEZ #1504 COL, FLORIDA C.P. 86040 Tel: 01 (993) 3 52 00 47 / 3 52 20 74 / 3 52 20 09 E-Mail: compumantenimientos@prodigy.net.mx
Puebla, Pue. (Matriz): RENTA Y DATOS, S.A. DE C.V. Domicilio: 29 SUR 721 COL. LA PAZ 72160 PUEBLA, PUE. Tel: 01(52).222.891.55.77 CON 10 LINEAS E-Mail: datos@puebla.megared.net.mx	Veracruz, Ver.: CONEXION Y DESARROLLO, S.A DE C.V. Av. Americas # 419 ENTRE PINZÓN Y ALVARADO Fracc. Reforma C.P. 91919 Tel: 01-22-91-00-31-67 E-Mail: gacosta@qplus.com.mx
Chihuahua Soluciones Globales en Computación C. Magisterio # 3321 Col. Magisterial Chihuahua, Chih. Tel: 4136954 E-Mail: Cefeo@soluglobales.com	Cuernavaca Compusupport de Cuernavaca SA de CV Francisco Leyva # 178 Col. Miguel Hidalgo C.P. 62040, Cuernavaca Morelos Tel: 01 777 3180579 / 01 777 3124014 E-Mail: aquevedo@compusupporteva.com
Distrito Federal: QPLUS, S.A. de C.V. Av. Coyoacán 931 Col. Del Valle 03100, México, D.F. Tel: 01(52)55-50-00-27-35 E-Mail : gacosta@qplus.com.mx	Guadalajara, Jal.: SERVICRECE, S.A. de C.V. Av. Niños Héroe # 2281 Col. Arcos Sur, Sector Juárez 44170, Guadalajara, Jalisco Tel: 01(52)33-36-15-15-43 E-Mail: mmiranda@servicrece.com
Guerrero Acapulco GS Computación (Grupo Sesicomp) Progreso #6-A, Colo Centro 39300 Acapulco, Guerrero Tel: 744-48-32627	Monterrey: Global Product Services Mar Caribe # 1987, Esquina con Golfo Pérsico Fracc. Bernardo Reyes, CP 64280 Monterrey N.L. México Tel: 8129-5103 E-Mail: aydeem@gps1.com.mx
MERIDA: ELECTROSER Av Reforma No. 403Gx39 y 41 Mérida, Yucatán, México CP97000 Tel: (52) 999-925-1916 E-Mail: rrrb@sureste.com	Oaxaca, Oax.: CENTRO DE DISTRIBUCION Y SERVICIO, S.A. de C.V. Murguía # 708 P.A., Col. Centro, 68000, Oaxaca Tel: 01(52)95-15-15-22-22 Fax: 01(52)95-15-13-67-00 E-Mail. gpotai2001@hotmail.com
Tijuana: STD Av Ferrocarril Sonora #3780 L-C Col 20 de Noviembre Tijuana, Mexico	FOR USA SUPPORT: ViewSonic Corporation 381 Brea Canyon Road, Walnut, CA. 91789 USA Tel: 800-688-6688 (English); 866-323-8056 (Spanish); Fax: 1-800-685-7276 E-Mail: http://www.viewsonic.com

4:3 ViewSonic Mexico Limited Warranty

Contact ViewSonic service team at: <http://www.ViewSonic.com> or call our service team: United States 1-800-688-6688, Canada 1-866-463-4775

TV Wall Mount

To find the perfect mount for VT2645, VT3245, and VT3745, please browse www.viewsonic.com or call our service team: United States 1-800-688-6688, Canada 1-866-463-4775.

Safety Instructions



The symbol is intended to alert the user to presence of un-insulated “Hazardous Voltage” within the product’s enclosure that may be of sufficient magnitude to constitute a risk of electric shock to persons.



This symbol is intended to alert the user that improper use of the product may result in product malfunction. The user should pay attention to avoid accidents or unnecessary problems.

Wet Location

Apparatus shall not be exposed to dripping or splashing and that no objects filled with liquids, such as vases, shall be placed on the apparatus.

Outdoor Use

WARNING: To reduce the risk of fire or electric shock, do not expose this apparatus to rain or moisture.

Disconnect Device - The Mains Plug or An Appliance Coupler

The mains plug or an appliance coupler is used as the disconnect device for disconnection from the mains, the disconnect device shall remain readily operable.

Contents

Product Registration	i
Product disposal at end of product life	i
Customer Support	i
Safety Instructions	iii
Wet Location	iii
Outdoor Use	iii
Disconnect Device - The Mains Plug or An Appliance Coupler	iii
Copyright Information	1
WARNING	2
Important Safety Instructions	3
USE	3
ANTENNAS	4
BATTERIES	4
CLEANING	4
MOISTURE	6
INSTALLATION	6
VOLUME ADJUSTMENT	7
LCD SCREEN	7
Compliance Information	8
FCC Statement	8
Declaration of RoHS Compliance	9
List of Features	10
Package Contents	10
Installing the LCD TV	11
Disconnecting the stand	11
Installing the stand	11
Mounting ViewSonic LCD TV to the wall	12
Wall Mount Kit Specifications (VESA)	13
Front View of VT2645, VT3245, and VT3745	14
Rear View of VT2645	15
Rear View of VT3245	16
Rear View of VT3745	17
Connecting the LCD TV	19
Cable System or VHF/UHF Antenna System	19
Cable System and VHF/UHF Antenna System	19
HD Cable Box/HD Satellite Box	20
Personal Computer	21
Remote Control and TV Controls	25
Inserting Remote Control Batteries	25
Remote Control and TV Controls	26
Operation	28

Contact ViewSonic service team at: <http://www.ViewSonic.com> or call our service team: United States 1-800-688-6688, Canada 1-866-463-4775

Turning the TV On and Off 28
Changing Channels 28
Adjusting the Volume 28
Viewing the Displayed Information 28
Cleaning the LCD TV 42
 To clean the screen: 42
 To clean the case: 42
 Disclaimer 42
Troubleshooting 43
Specifications 45
Limited Warranty 47
Mexico Limited Warranty 48

Copyright Information

Copyright © ViewSonic® Corporation, 2009. All rights reserved.
ViewSonic, the three birds logo, OnView, ViewMatch, and ViewMeter are registered trademarks of ViewSonic Corporation.

ENERGY STAR® is a registered trademark of the U.S. Environmental Protection Agency (EPA).
As an ENERGY STAR® partner, ViewSonic Corporation has determined that this product meets the ENERGY STAR® guidelines for energy efficiency.

Disclaimer: ViewSonic Corporation shall not be liable for technical or editorial errors or omissions contained herein; nor for incidental or consequential damages resulting from furnishing this material, or the performance or use of this product.

In the interest of continuing product improvement, ViewSonic Corporation reserves the right to change product specifications without notice. Information in this document may change without notice.

No part of this document may be copied, reproduced, or transmitted by any means, for any purpose without prior written permission from ViewSonic Corporation.

WARNING

Do not expose this TV to rain or moisture. It may increase the risk to fire or electronic shock.



Dangerous Voltage:

The lightning flash with arrowhead symbol, within an equilateral triangle, is intended to alert the user to the presence of dangerous voltage within the inside of the product that may be sufficient level to constitute a risk of electric shock to persons.



Instruction: The exclamation point within an equilateral triangle is intended to alert the user to the presence of important operating and servicing instructions in the literature accompanying the appliance.

The TV shall not be exposed to dripping or splashing. Do not put objects filled with liquids, such as vases, on the TV.

CAUTION

To prevent electric shock, do not use this polarized AC plug with an extension cord, receptacle or other outlet unless the blades can be fully inserted to prevent blade exposure.

Declaration of Conformity

Trade Name: ViewSonic Model: N1630w Responsible Party: ViewSonic Corporation Address: 381 Brea Canyon Road, Walnut, CA. 91789 USA Telephone Number: 1-800-688-6688 This device complies with part 15 of the FCC rules. Operation is subject to the following two conditions: 1) This device may not cause harmful interference, and 2) this device must accept any interference received, including interference that may cause undesired operation.

NOTIFICATION

This device has been tested and found to comply with the limits for a Class B digital device, pursuant to Part 15 of the FCC Rules. These limits are designed to provide reasonable protection against harmful interference in a residential installation. This device generates, uses and can radiate radio frequency energy and, if not installed and used in accordance with the instructions, may cause harmful interference to radio communications. However, there is no guarantee that interference will not occur in a particular installation. If this equipment does cause harmful interference to radio or television reception, which can be determined by turning the equipment off and on, the user is encouraged to try to correct the interference by one or more of the following measures:

- Reorient or relocate the receiving antenna.
- Increase the separation between the device and receiver.
- Connect the device into an outlet on a circuit different from that to which the receiver is connected.
- Consult the dealer or an experienced radio/TV technician for help.

Pursuant to FCC regulations, be cautioned that any changes or modifications not expressly approved in this manual could void your authority to operate this equipment.

Safety

- Operate the TV on 120V and 240 V AC only.
- Use the AC power cord specified by ViewSonic and suitable for the voltage where you use it.
- The plug is designed, for safety purposes, to fit into the wall outlet only one way.
- If you are unable to insert the plug fully into the outlet, contact your dealer.
- If any liquid or solid object should fall inside the cabinet, stop operating, unplug the TV immediately and have it checked by qualified service technician.
- If you will not be using the TV for a long time, disconnect the power by pulling the plug itself. Do not pull on the cord.
- For details concerning safety precautions, refer to Important Safety instructions on page 4.

Installation

- The TV should be installed near an easily accessible power outlet.
- To prevent internal heat buildup, do not block the ventilation openings.
- Do not install the TV in a hot or humid place, or in a place subject to excessive dust or mechanical vibration.
- Avoid operating the TV at temperatures below 41°F (5°C).
- When the TV is transported directly from a cold to a warm location, or if the room temperature changes suddenly, the picture may be blurred or show poor color due to moisture condensation. In this case, please wait a few hours before turning on the TV, in order to let the moisture evaporate first.
- To ensure best picture quality, do not expose the screen to direct illumination or sunlight. We recommend you use spot lighting directed down from the ceiling or to cover the windows that face the screen with opaque curtains. It is better that TV is installed where the floor and walls are not of a reflective material.

To Customers

To install the specified TV, sufficient expertise is required. Make sure you subcontract the installation to ViewSonic dealer or licensed contractors and pay adequate attention to safety during the installation.



Note

This television includes a QAM demodulator, which should allow you to receive unscrambled digital cable television programming via subscription service to a cable service provider. The type of programming and signal provided by your cable service provider will affect the availability of digital cable television programming in your area.

Trademark Information

Macintosh is a trademark of Apple Inc., registered in the U.S. and other countries. HDMI, the HDMI logo and High-Definition Multimedia Interface are trademarks or registered trademarks of Dolby Laboratories. Blu-ray Disc is a trademark. Adobe is a registered trademark or a trademark of Adobe Systems Incorporated in United States and/or other countries.

Important Safety Instructions

1. Read these instructions completely before using the equipment.
2. Keep these instructions in a safe place.
3. Heed all warnings.
4. Follow all instructions.
5. Do not use this apparatus near water.
6. Clean with a soft, dry cloth.
7. Do not block any ventilation openings. Install the equipment in accordance with the manufacturer's instructions.
8. Do not install near any heat sources such as radiators, heat registers, stoves, or other devices (including amplifiers) that produce heat. 
9. Do not attempt to circumvent the safety provisions of the polarized or grounding-type plug. A polarized plug has two blades with one wider than the other. A grounding type plug has two blades and a third grounding prong. The wide blade and the third prong are provided for your safety. If the provided plug does not fit into your outlet, consult an electrician for replacement of the outlet.
10. Prevent the power cord from being tread upon or pinched, particularly at the plug, convenience receptacles, and the point where they exit from the device. Be sure that the power outlet is located near the equipment so that it is easily accessible.
11. Only use attachments/ accessories specified by the manufacturer.
12. Use only with the cart, stand, tripod, bracket, or table specified by the manufacturer, or sold with the apparatus. When a cart is used, use caution when moving the cart/ apparatus combination to avoid injury from tip-over. 
13. Unplug this apparatus when it will be unused for a long period of time.
14. Refer all servicing to qualified service personnel. Servicing is required when the apparatus has been damaged in any way, such as power-supply cord or plug is damaged, liquid has been spilled or objects have fallen into the apparatus, the apparatus has been exposed to rain or moisture, or the unit does not operate normally, or has been dropped.

USE

AC power Cord

Keep the following guidelines to protect the AC power cord from being damaged. If the AV power cord is damaged, it may result in a fire or an electric shock. Stop using it and ask your dealer or ViewSonic service center to exchange it.

- Do not place the TV where the power cord is subject to wear or abuse.
- Do not pinch, bend, or twist the cord excessively.
- The core lines may be bared and cut, causing a short-circuit, and resulting in a fire or an electric shock.
- Do not convert or damage the power cord.
- Avoid power cord being rolled over or rested upon. 
- When the power cord is plugged in, do not move the TV.
- Keep the power cord away from heat sources.
- When you disconnect the AC power cord, disconnect it from the wall outlet first.
- When disconnecting the power cord, grasp the plug instead of pulling the power cord.
- Use only an original ViewSonic AC power cord, not other brands.
- Do not use the supplied AC power cord on any other equipment.

Wall outlet

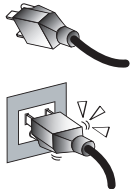
The TV set with a three-wire grounding type AC power cord plug must be connected to an AC power socket outlet with a protective grounding connection. 

Do not use an unfitting outlet. Insert the plug fully into the outlet. If it is loose, do not use it. Doing so may cause arcing and result in a fire. Contact your electrician to change the outlet.

Wiring

For your safety, be sure to unplug the AC power cord when connecting cables.

Take care not to trip on the cables. It may cause damage to the TV set.

Electric shock

Do not touch the AC power cord or the TV with a wet hand. If you plug/unplug the AC power cord from the TV with a wet hand, it may cause electric shock. 

Lightning storms

During a lightning storm, unplug the TV from the wall outlet and disconnect the antenna to prevent damage to the TV.

When not in use

If you will not be using the TV set for long periods of time, the TV set should be disconnected from the AC power outlet to prevent power line surges. The TV set is not disconnected from the AC power source when the TV set is switched off. To disconnect the TV set completely, unplug from the AC power outlet.

Overloading

This TV set is designed to operate on a 120 - 240 V AC supply only. If there are too many appliances connected to the same AC power outlet, it could result in a fire or an electric shock.



Optional equipment

If optional equipment is to be installed, leave some space between optional equipment and the TV set. Picture distortion and/or noisy sound may occur if the TV set is positioned in close proximity to any equipment emitting electromagnetic radiation.

Small accessories

Keep small accessories in a safe place where children are unable to reach.

ANTENNAS

Outdoor antenna grounding

If an outdoor antenna is installed, follow the precautions below.

Do not install the outdoor antenna system near of overhead power lines or other electric light or power circuits, or where it can come in contact with such power lines or circuits.

WHEN INSTALLING AN OUTDOOR ANTENNA SYSTEM, EXTREME CARE SHOULD BE TAKEN TO KEEP FROM CONTACTING SUCH POWER LINES OR CIRCUITS AS CONTACT WITH THEM IS ALMOST INVARIABLY FATAL.

Be sure the antenna system is grounded so that it can provide some protection against voltage surges and built-up static charges.

Section 810 of the National Electrical Code (NEC) in the U.S.A. and Section 54 of the Canadian Electrical Code in Canada provides information with in regard to proper grounding of the mast and supporting structure, grounding of the lead-in wire to an antenna discharge unit, size of

grounding conductors, location of antenna discharge unit, connection to grounding electrodes, and requirements for the grounding electrode.

Antenna grounding according to the National Electrical Code, ANS/NFPA 70

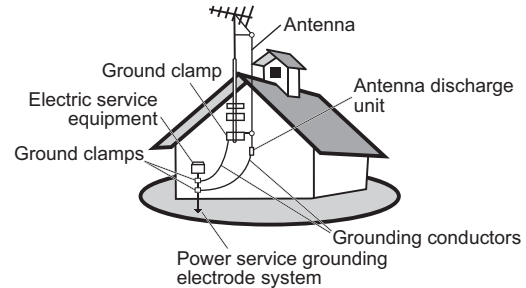

BATTERIES

- Do not cast away batteries in a fire.
- Do not disassembled, overheat, or short-circuit the batteries.
- If the battery is replaced in the wrong way, it may cause danger of explosion. Replace only with the same or equivalent type.

Dispose used batteries

To preserve our environment, dispose of used batteries according to your local laws or regulations.

CLEANING

Cleaning the AC power plug

Unplug the AC power plug and clean it regularly. If the plug is covered with dust and gathers moisture, its insulation may deteriorate and result in a fire.

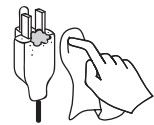

Cleaning the screen surface/ cabinet of the TV set

When cleaning this TV, unplug the AC power cord. If not, it may result in electric shock. Use a dry soft cloth to clean the cabinet of the TV. To remove dust near the screen, wipe it gently with a soft cloth. Stubborn stains may be removed with a cloth slightly dampened with a solution of mild soap and warm water. Never use strong solvents such as thinner or benzene for cleaning. If using a chemically pre-treated cloth, please follow the instruction provided on the package. The ventilation holes can accumulate dust over time.



To ensure proper ventilation, we recommend you to remove the dust periodically (once a month) using a vacuum cleaner, while the LCD TV is powered off.

MAGNETIC INFLUENCE

This TV contains a strong magnet in the speaker unit that generates a magnetic field. Keep any items susceptible to magnetic fields away from the speaker.

SOUND

If you hear snapping or popping sound comes from the TV continuously or frequently while the TV is operating, unplug the TV and consult your dealer or service technician. It is normal for some TVs to make occasional snapping or popping sounds, particularly when being turned on or off.



CARRYING THE TV

Carry the TV as instructed

To prevent dropping the TV and causing serious injury, you must follow these guidelines:

- Disconnect all cables before carrying the TV.
- Carrying the large size TV requires at least two or three people.
- When you carry the TV, place your hands as illustrated and hold it securely. Do not put stress on the LCD panel and the frame around the screen.
- When carrying the TV, do not subject it to shocks, vibration, or excessive force.
- When lifting or moving the TV, hold it securely from the bottom. Place your palm directly under the panel.

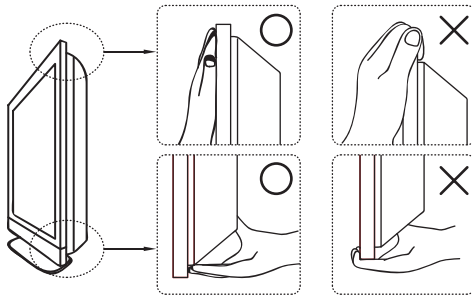

VENTILATION

Slots and openings in TV are provided for ventilation. To ensure reliable operation of the TV and to protect it from overheating, be sure these openings are not blocked or covered.

The TV may accumulate dust and get dirty if proper ventilation is not provided. For proper ventilation, follow the following guidelines:

- Never install the TV face up, down or sideways.
- Never install the TV turned over or upside down.
- Never cover the slots and openings with a cloth or other materials.
- Never block the slots and openings by placing the TV on a bed, sofa, rug or other similar surface.
- Never place the TV in a confined space, such as a bookcase or built-in cabinet, unless proper ventilation is provided.

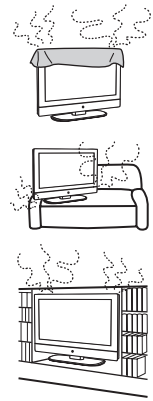

Leave some space around the TV set as shown below. Otherwise, air-circulation may be inadequate and cause overheating, which may cause a fire or damage to the TV set.

Installed on the wall

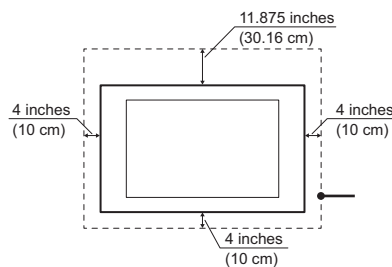

Installed with stand

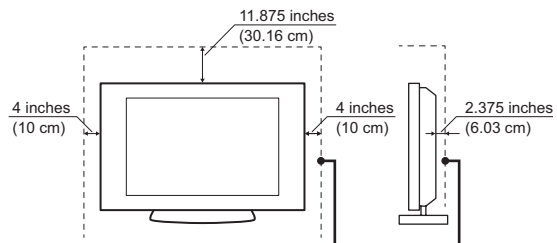

Leave at least this space around the set.

Do not install the TV set as follows:

Air circulation is blocked. Air circulation is blocked.

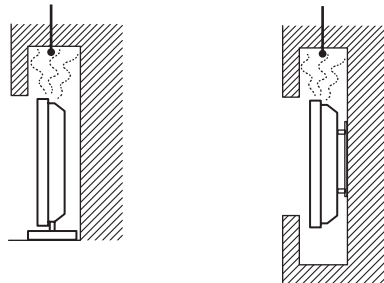

Objects and ventilation holes

Never push any objects into the slots on the TV cabinet as they may touch dangerous voltage points or short out parts that could result in a fire or an electric shock. Do not place any objects on the TV.

MOISTURE

Moisture and flammable objects

- Keep the product away from moisture. Do not expose this appliance to rain or moisture. Do not place objects filled with liquids, such as vases, on the TV.
- Do not use power-line operated V sets near water, such as in places like a bathtub, washbowl, kitchen sink, laundry tub, a wet basement, or near a swimming pool, etc. It may cause fire or electric shock.
- Do not let this TV get wet. Never spill liquid of any kind on the TV. If water penetrates into the product, unplug the power cord and contact ViewSonic.
- Do not operate the TV when wet. It may result in electric shock or damage to the TV.
- To prevent fire, keep flammable objects or open flame (e.g. candles) away from the TV.



- Do not place the TV in hot, oily, humid or excessively dusty places.
- Do not install the TV where insects may enter.
- Do not install the TV where it may be exposed to mechanical vibration.
- Do not install the TV in a location where it may spear up, such as on or behind a pillar, or where you might bump your head on it. It may cause injury.



Preventing the TV from toppling over

To prevent the TV from toppling over, secure the TV to a wall or stand.

Placement for watching

We suggest you to watch the TV at a distance of 3-7 times that of the screen height, and not in excessive brightness. It is easy to cause eye fatigue if you watch TV for too long or in a dark room. To obtain clear picture, do not expose the screen to direct illumination or sunlight. Use spot lighting directed down from the ceiling if you can.

Use in outdoor

This TV is not designed for outdoors installation. Do not expose the TV to rain, as it may result in a fire or an electric shock. Also, do not expose the TV to direct sunlight, as it may heat up and become damaged.

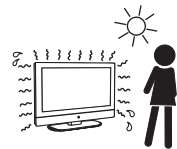

INSTALLATION

To do Wall mount installation, you need a Wall-Mount Bracket. When installing or removing the TV using the Wall-Mount Bracket, be sure to use qualified contractors. If not properly secured during installation or removal from the Wall-Mount Bracket, the TV may fall and cause serious injury.

Optional wall mount.

- When installing the TV using a Wall-Mount Bracket, make sure you follow the operating instructions supplied with the Wall-Mount Bracket.
- Attach the brackets supplied with the Wall-Mount Bracket.
- The TV is not designed for hanging from the ceiling. It may fall and cause serious injury.

Placement

The TV should be installed near an easily accessible AC power outlet.

Observe the following to prevent the TV from falling from the stand or wall mount.

- Place the TV on a stable, level surface.
- Do not hang anything on the TV. Do not allow children to climb on the TV.
- Do not install the TV in places subject to extreme temperature, such as in direct sunlight, near a radiator, or heating vent. If the TV is exposed to extreme temperature, the TV may overheat and cause deformation of the enclosure or cause malfunction.
- Do not install the TV in a place exposed to direct air conditioning. If the TV is installed in such a location, moisture may condense inside and may cause a malfunction.



Vehicle, ships and other vessels

Do not install this TV in a vehicle. Car accidents may cause the TV to fall down and cause injury.

Do not install this TV in a ship or vessel.

If the TV is exposed to seawater, it may cause a fire or damage the TV.



Medical institutions

Do not place this TV in a place where medical equipment is in use. It may cause the medical equipment to malfunction.

VOLUME ADJUSTMENT

- Adjust the volume to avoid disturbing your neighbors. Sound carries easily at night. Therefore, we suggest you close the windows or use headphones.
- When using headphones, adjust the volume to appropriate levels, or hearing damage may result.

LCD SCREEN

- Although the LCD screen is made with high precision technology and has effective pixels of 99.99% or more, black dots or bright points or light (red, blue, or green) may appear constantly on the LCD screen. This is a structural property of the LCD panel and is not a malfunction.
- The LCD screen is made with high-precision technology. To achieve a high level of performance and picture quality, this TV's backlight setting is set to maximize the brightness of the TV. However, uneven brightness may be observed when the LCD TV is viewed in a dark environment without an input source or a blank screen. This is a normal condition, not a malfunction of the TV. To improve this condition, change the Picture mode, Backlight setting, enable the Light Sensor, or turn on the Power management.
- Avoid exposing the LCD screen surface to direct sunlight. It is likely to damage the LCD panel.
- Do not push or scratch the LCD screen, or place objects on top of the TV. The image may be uneven or the LCD panel may be damaged.
- If the TV is used in a cold place, a smear may occur in the picture or the picture may become dark. It is not caused by a failure. This condition will improve as the temperature rises.
- When still pictures are displayed continuously, ghosting may occur. It should disappear after a short period of time.
- The screen and cabinet get warm when the TV is in use. This is a normal condition.
- Spraying insect repellent with volatile material on the screen will cause damage.
- Do not make prolonged contact with rubber or plastic material.

Broken pieces

Do not throw anything at the TV.

Doing so may break the screen glass and cause serious injury.



If the surface of the TV cracks, unplug the AC power cord before touching the TV. Otherwise electric shock may result.

Handling of broken glass and liquid crystal leakage

If the LCD panel gets damaged, crystalline liquid leakage may occur, or scattered broken glass may result. Do not touch broken glass or crystalline liquid which is toxic, with bare hands as cuts, poisoning or skin irritation may occur. Also do not glass fragments or leaked crystalline liquid get into your eyes or mouth. Should either contacted your eyes or mouth, rinse the contacted area thoroughly with water and consult your doctor.

SERVICING

Do not attempt to repair the TV yourself, since opening the cabinet may expose you to dangerous voltage or other hazards. Ask qualified



service personnel to do the servicing for your TV.

Replacement parts

When replacement parts are required, be sure the service technician certifies in writing that he/she has used replacement parts specified by the manufacturer that have the same characteristics as the original parts. Unauthorized substitutions may cause a fire, an electric shock or other hazards.

Safety check

Upon completion of repairs to the TV, ask the service technician to perform routine safety checks (as specified by the manufacturer) to determine that the TV is safe for operating, and to so certify. Ask a qualified service technician to dispose of the TV.

For Customers in the United States

There is mercury in the lamp of this product. Disposal of these materials may be regulated due to environmental considerations. For disposal or recycling information, please contact your local authorities or the Electronic Industries Alliance (<http://www.eiae.org>).

Compliance Information

FCC Statement

This device complies with part 15 of FCC Rules. Operation is subject to the following two conditions: (1) this device may not cause harmful interference, and (2) this device must accept any interference received, including interference that may cause undesired operation.

This equipment has been tested and found to comply with the limits for a Class B digital device, pursuant to part 15 of the FCC Rules. These limits are designed to provide reasonable protection against harmful interference in a residential installation. This equipment generates, uses, and can radiate radio frequency energy, and if not installed and used in accordance with the instructions, may cause harmful interference to radio communications. However, there is no guarantee that interference will not occur in a particular installation. If this equipment does cause harmful interference to radio or television reception, which can be determined by turning the equipment off and on, the user is encouraged to try to correct the interference by one or more of the following measures:

- Reorient or relocate the receiving antenna.
- Increase the separation between the equipment and receiver.
- Connect the equipment into an outlet on a circuit different from that to which the receiver is connected.
- Consult the dealer or an experienced radio/TV technician for help.

Warning: You are cautioned that changes or modifications not expressly approved by the party responsible for compliance could void your authority to operate the equipment.

Following information is only for EU-member states:

The mark shown to the right is in compliance with the Waste Electrical and Electronic Equipment Directive 2002/96/EC (WEEE).

The mark indicates the requirement NOT to dispose the equipment as unsorted municipal waste, but use the return and collection systems according to local law.



ENERGY STAR Information:

- Keeping the TV at its factory default settings that meet ENERGY STAR criteria.
- Enabling certain features and functionality of LCD TV will increase its energy consumption, possibly beyond the limits required for ENERGY STAR qualification.

Declaration of RoHS Compliance

This product has been designed and manufactured in compliance with Directive 2002/95/EC of the European Parliament and the Council on restriction of the use of certain hazardous substances in electrical and electronic equipment (RoHS Directive) and is deemed to comply with the maximum concentration values issued by the European Technical Adaptation Committee (TAC) as shown below:

Substance	Proposed Maximum Concentration	Actual Concentration
Lead (Pb)	0.1%	<0.1%
Mercury (Hg)	0.1%	<0.1%
Cadmium (Cd)	0.1%	<0.01%
Hexavalent Chromium (Cr6+)	0.01%	<0.1%
Polybrominated biphenyls (PBB)	0.1%	<0.1%
Polybrominated diphenyl ethers (PBDE)	0.1%	<0.1%

Certain components of products as stated above are exempted under the Annex of the RoHS Directives as noted below:

Examples of exempted components are:

1. Mercury in compact fluorescent lamps not exceeding 5 mg per lamp and in other lamps not specifically mentioned in the Annex of RoHS Directive.
2. Lead in glass of cathode ray tubes, electronic components, fluorescent tubes, and electronic ceramic parts (e.g. piezoelectronic devices).
3. Lead in high temperature type solders (i.e. lead-based alloys containing 85% by weight or more lead).
4. Lead as an alloying element in steel containing up to 0.35% lead by weight, aluminium containing up to 0.4% lead by weight and as a copper alloy containing up to 4% lead by weight.

Getting Started

List of Features

1. Enjoy HDTV with 1366 x 768 (26") / 1920 x 1080 (32" & 37") native image resolution.
2. ClearPicture™ Technology for high contrast and realistic video.
3. Built-in digital tuners (HDTV, NTSC, Clear QAM-digital cable).
4. Multiple video/computer inputs: HDMI (x2), component (x2 for 37"), S-Video, composite, PC.
5. Powerful 10W (2x5W for 26") / 20W (2x10W for 32" & 37") speakers.

Package Contents

Check the contents of your package. It should contain:



LCD TV



Remote Control with batteries

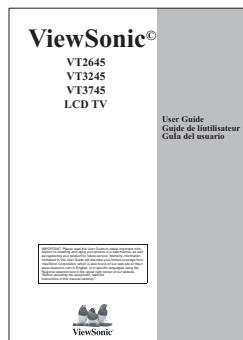

ViewSonic User Guide

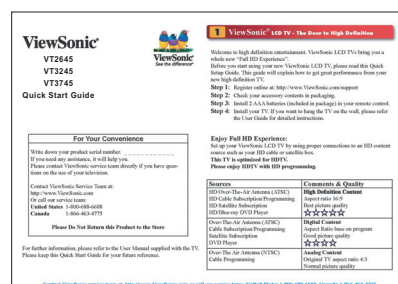

ViewSonic Quick Start Guide

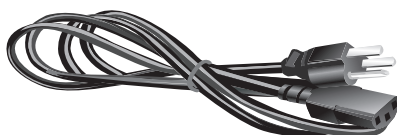

Power Cord

Contact ViewSonic service team at: <http://www.ViewSonic.com> or call our service team: United States 1-800-688-6688, Canada 1-866-463-4775

Getting Started

Installing the LCD TV

Disconnecting the stand

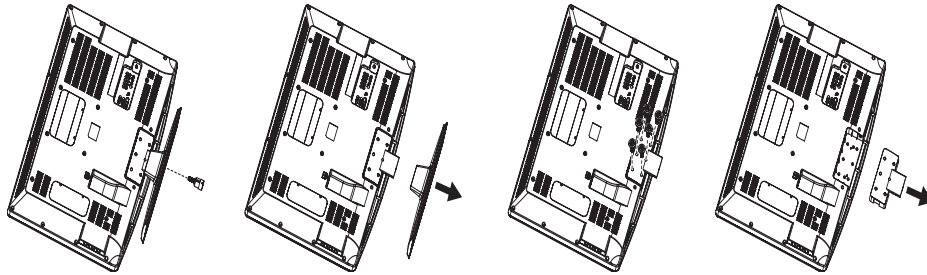

1. Place the TV face down on a soft cloth or cushion on a table.
2. Remove the base. It is attached to the stand with 1 screw.
3. Remove screws holding the stand to the hinge: VT2645 (x4), VT3245 (x4), VT3745 (x5)
4. Remove the stand.

Installing the stand

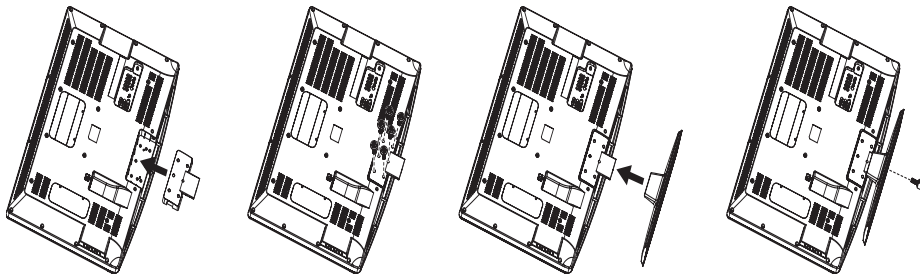

1. Place the TV face down on a soft cloth or cushion on a table.
2. Connect the stand with the hinge at the back of TV with screws: VT2645 (x4), VT3245 (x4), VT3745 (x5)
3. Attach the base to the stand with 1 screw.

Getting Started

Mounting ViewSonic LCD TV to the wall

The LCD TV can be used in a free standing position or wall-mounted. Before installing the product to the wall, please consider the following guidelines:

- Read the Important Safety Instructions, at the start of this manual.
- Do not install in a moist or wet environment. This equipment is intended for indoor use.
- Do not install near heat source, or strong magnetic fields.
- Use only UL approved wall-mounting brackets to support the LCD TV weight.
- Before attaching the wall mount plate to the back cover, ensure the product is working.
- If your LCD TV is already set up for free-standing operation, you need to first remove the stand before mounting the device to the wall.

To attach the wall-mount bracket to LCD TV safely, please use the following guidelines:

- Disconnect the power and any other cables that might hinder moving the LCD TV.
 - Set the LCD TV on a table or work surface, placing the screen face down on a towel or woolen blanket to protect the screen surface from damage while installing plate.
 - Before installing the LCD TV on the wall, ensure you have recorded the product serial number on page (i) of the User Guide, as you will need the serial number to request service should there be a service need.
 - Install the wall mount plate to the LCD TV using screws NO LONGER than 10mm, as longer screws found in universal (non-ViewSonic) wall mount kits may damage the power supply causing the unit to fail. The wall-mount screw type is M4 x L10.
 - Mount the wall mount bracket to the wall ensuring use of proper screws to support the installation. Ensure there is at least 3cm of space surrounding any air-vents of your LCD TV to allow adequate cooling during operation.
 - Hang the LCD TV wall mount plate to the wall mount bracket, completing installation.
- Enjoy your ViewSonic LCD TV!

Getting Started

Wall Mount Kit Specifications (VESA)

When attaching to other building materials, please contact your nearest dealer.

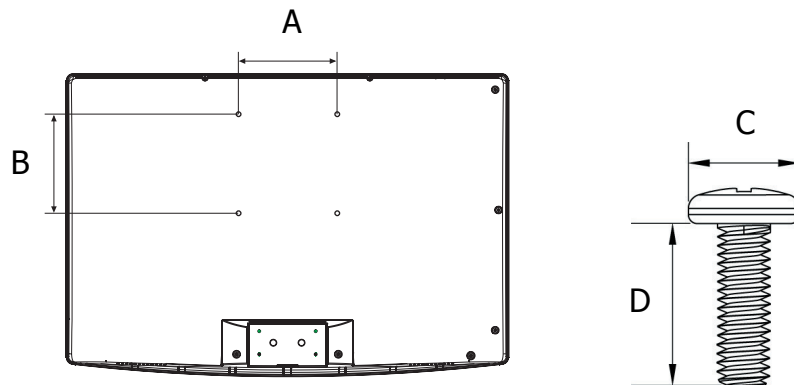

Product Family	Model	VESA Spec. (A x B)	Standard Screw (C x D)	Quantity
LCD TV	VT2645	200 x 100 mm	M4 x L10	4
	VT3245	200 x 100 mm	M6 x L14	4
	VT3745	200 x 200 mm	M6 x L15	4

- ViewSonic provides the standard dimensions for wall mount kits as shown in the table above.
- When purchasing our wall mount kit, a detailed install manual and all parts necessary for assembly are provided.
- Do not use the screws that are longer than the standard dimension, as they may cause damage to the inside of the TV set.

To find the perfect mount for VT2645, VT3245, or VT3745, please browse www.viewsonic.com or call our service team: United States 1-800-688-6688, Canada 1-866-463-4775.

Getting Started

Front View of VT2645, VT3245, and VT3745

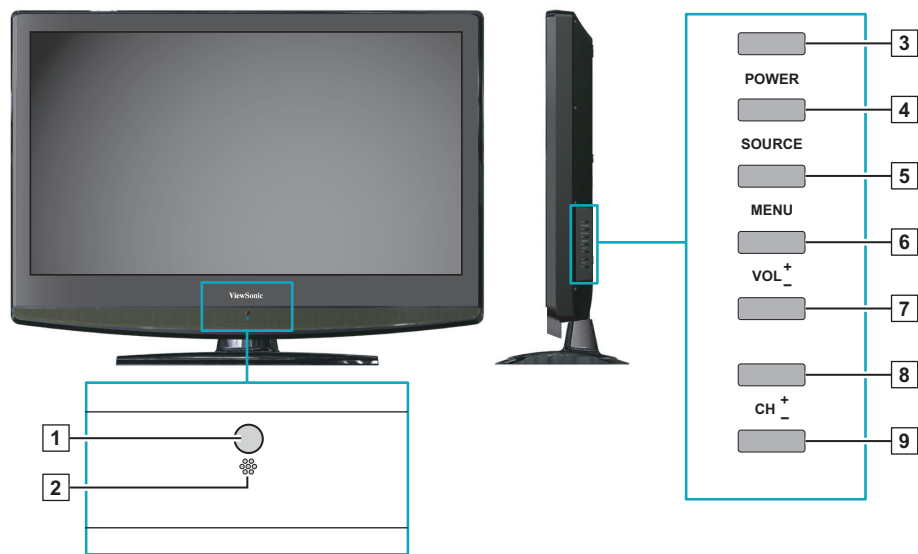

Item	Description
1	Remote Control Receiver Receives IR signals from the remote control.
2	Power LED Indicator Lights up in blue when the TV is turned on. Lights up in orange when the TV is in standby mode.
3	Power ON/OFF button Turn the power on from standby mode or turn the power off to return to the standby mode.
4	SOURCE Select input source.
5	MENU Turn OSD menu ON/OFF.
6	Volume Up Increase sound volume or select a control while in OSD menu.
7	Volume Down Decrease sound volume or or select a control while in OSD menu.
8	CH Up Channel up when source is TV, or adjust a high-lighted control while in OSD menu.
9	CH Down Channel down when source is TV, or adjust a high-lighted control while in OSD menu.

Getting Started

Rear View of VT2645

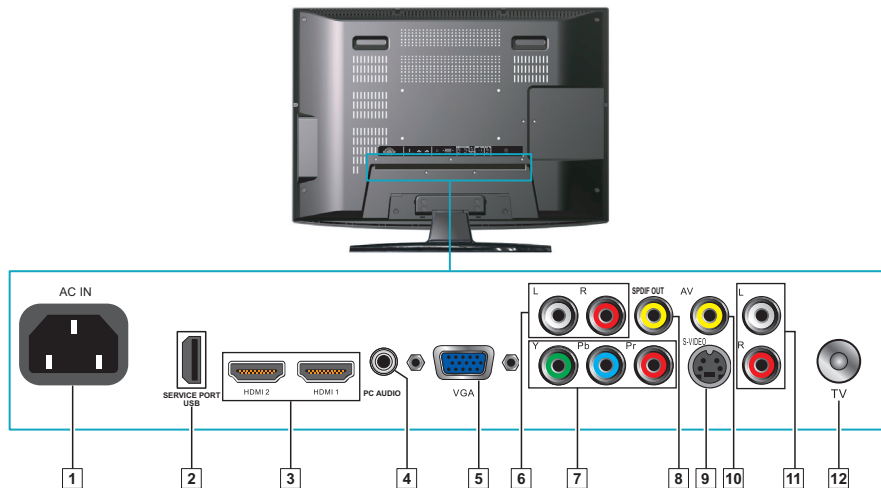

Item	Description
1 Power (AC input)	Plug-in the supplied AC Power cord and connect to the AC input power source (110~120V).
2 USB Service Port	Service only. Not available for users.
3 HDMI 1 / 2	Connect this port to the HDMI/HDMI-DVI jack of the compatible equipment. *If you use HDMI-DVI connections, please use PC Audio In for audio input.
4 PC Audio In	Connect the PC Audio Out on your computer to the PC Audio In on the rear of the LCD TV.
5 VGA Signal Input	Connect a 15-pin D-sub RGB cable to the RGB output of your computer and the other end to the RGB input on the rear of the LCD TV.
6 R/L Audio Inputs (YPbPr)	Connect to an external device, such as a VCR, STB, or a DVD player.
7 YPbPr	Connect to an external device, such as a VCR, STB, or a DVD player.
8 Coaxial	Connect to a digital audio receiver supporting the S/PDIF standard, such as a home theater receiver.
9 S-Video Input	Connect to an external device, such as a VCR, STB, or a DVD player.
10 AV	Connect to an external device, such as a VCR, STB, or a DVD player.
11 R/L Audio Input (AV/S-Video)	Connect to an external device, such as a VCR, STB, or a DVD player.
12 TV Cable/Antenna	Connect to a cable or antenna TV.

Getting Started

Rear View of VT3245

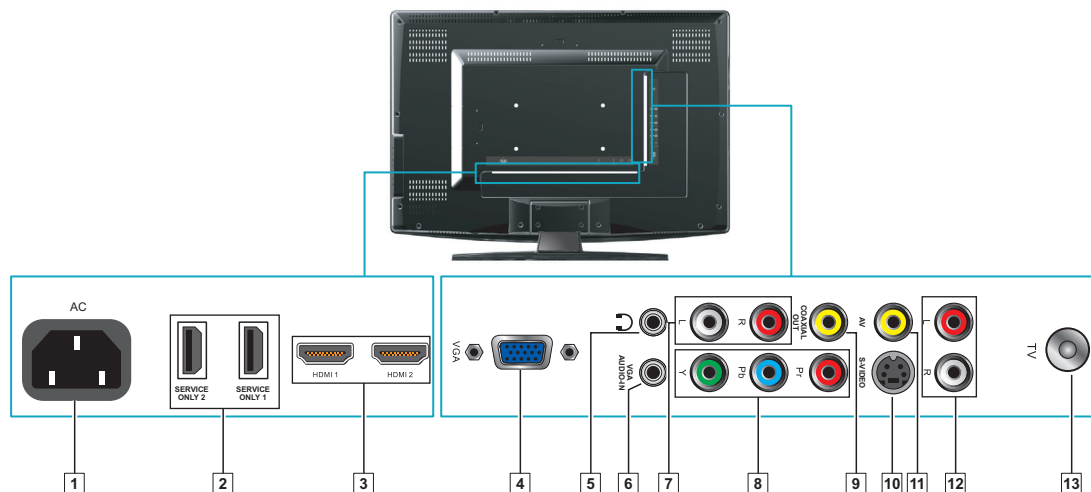

Item	Description
1	Power (AC input) Plug-in the supplied AC Power cord and connect to the AC input power source (110~120V).
2	Service Port 1 / 2 Service only. Not available for users.
3	HDMI 1 / 2 Connect this port to the HDMI/HDMI-DVI jack of the compatible equipment. *If you use HDMI-DVI connections, please use PC Audio In for audio input.
4	VGA Signal Input Connect a 15-pin D-sub RGB cable to the RGB output of your computer and the other end to the RGB input on the rear of the LCD TV.
5	Headphone Jack Connect to your headphones. By connecting the headphones, you can listen to the sound from the TV on headphones. *If you connect the headphones, the TV speakers will be muted.
6	VGA Audio In Connect to Audio Out on your computer.
7	R/L Audio Input (YPbPr) Connect to an external device, such as a VCR, STB, or a DVD player.
8	YPbPr Connect to an external device, such as a VCR, STB, or a DVD player.
9	Coaxial Use a coaxial cable to connect to a digital audio receiver supporting the S/PDIF standard, such as a home theater receiver.
10	S-Video Input Connect to an external device, such as a VCR, STB, or a DVD player.
11	AV Connect to an external device, such as a VCR, STB, or a DVD player.
12	R/L Audio Input (AV/S-Video) Connect to an external device, such as a VCR, STB, or a DVD player.
13	TV Cable/Antenna Connect to a cable or antenna TV.

Contact ViewSonic service team at: <http://www.ViewSonic.com> or call our service team: United States 1-800-688-6688, Canada 1-866-463-4775

Getting Started

Rear View of VT3745

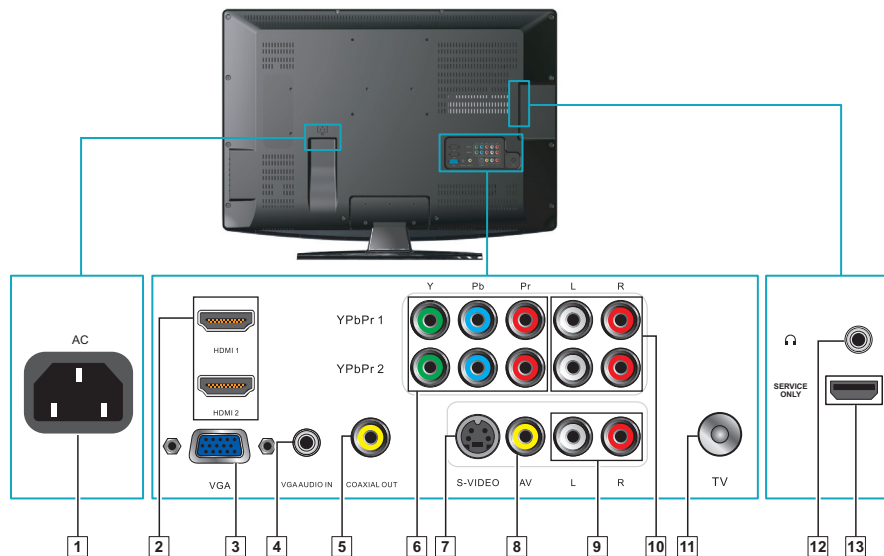

Item	Description
1	Power (AC input) Plug-in the supplied AC Power cord and connect to the AC input power source (110V~120V).
2	HDMI 1 / 2 Connect this port to the HDMI/HDMI-DVI jack of the compatible equipment. *If you use HDMI-DVI connections, please use PC Audio In for audio input.
3	VGA Signal Input Connect to VGA Out on your computer.
4	VGA Audio In Connect to Audio Out on your computer.
5	Coaxial Out Use a coaxial cable to connect to a digital audio receiver supporting the S/PDIF standard, such as a home theater receiver.
6	YPbPr 1 / 2 Connect to an external device, such as a VCR, STB, or a DVD player.
7	S-Video Input Connect to an external device, such as a VCR, STB, or a DVD player.
8	AV Connect to an external device, such as a VCR, STB, or a DVD player.
9	R/L Audio Input (AV/S-Video) Connect to an external device, such as a VCR, STB, or a DVD player.
10	R/L Audio Input 1 / 2 (YPbPr) Connect to an external device, such as a VCR, STB, or a DVD player.
11	TV Cable/Antenna Connect to a cable or antenna TV.
12	Headphone Jack Connect to your headphones. By connecting the headphones, you can listen to the sound from the TV on headphones. *If you connect the headphones, the TV speakers will be muted.
13	Service Port Service only. Not available for users.

Contact ViewSonic service team at: <http://www.ViewSonic.com> or call our service team: United States 1-800-688-6688, Canada 1-866-463-4775

Getting Started

AV connection

Connect the composite video and audio input jacks to the corresponding output jacks of your A/V device.

- VIDEO: Composite Video input [9]
- AUDIO: AV/ S-Video signal Audio input [8]

S-Video connection

Connect the S-Video and audio input jacks to the corresponding output jacks of your VCR or other video device that has S-Video. S-Video provides better picture quality than composite video connection. If both are connected, S-Video signal has priority.

- VIDEO: S-Video input [10]
- AUDIO: AV/ S-Video signal Audio input [8]

Component (YPbPr) connection

YPbPr provides better picture quality than the S-Video or the AV connection.

*For YPbPr connection, connect the component video (YPbPr) and audio jacks to the corresponding output jacks of your A/V device.

- VIDEO: YPbPr signal input [7]
- AUDIO: YPbPr signal audio input [6]

HDMI connection

HDMI (High-Definition Multimedia Interface) is a licensable audio/video connector interface for transmitting uncompressed, encrypted digital streams between this TV and any HDMI equipped audio/video equipment.

- Be sure to use only an HDMI cable that bears the HDMI logo.
- If the equipment has a DVI jack and not an HDMI jack, connect the DVI jack to the HDMI Input Terminal (with DVI-to-HDMI cable or adapter), and connect the Audio cable to the Audio In jacks.

1. With HDMI cable: HDMI Input Terminal [4]
2. With HDMI-DVI cable

- VIDEO: HDMI Input Terminal [4]
- AUDIO: YPbPr/ DVI signal Audio input [6]

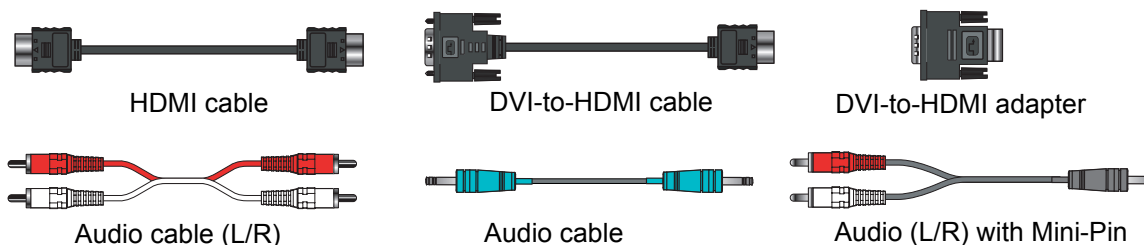

Computer connection

Connect the VGA cable and Audio cable from the VGA signal input and PC Audio input to the corresponding ports on your A/V device.

- VIDEO: VGA signal input [5]
- AUDIO: PC Audio input [2]

Getting Started

Connecting the LCD TV

Cable System or VHF/UHF Antenna System

Enjoy the high-definition and standard-definition digital programming along with standard definition analog programming.

- This TV is capable of receiving unscrambled digital programming for both cable and external VHF/UHF antenna.
- We strongly recommend that you connect the antenna/cable input using a 75-ohm coaxial cable (not supplied) to ensure the best picture quality.

Cable or VHF/UHF

75-ohm coaxial cable  Rear of TV VHF/UHF/CABLE input

Cable System and VHF/UHF Antenna System

Use an optional A-B RF switch (not supplied) to switch between the cable and antenna programming, as shown below.

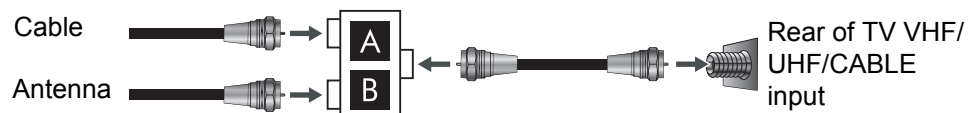

- Remember to set the TV Source setting in the CHANNEL menu to Air or Cable for the type you choose.

Getting Started

HD Cable Box/HD Satellite Box

You can also enjoy high-definition programming by subscribing to a high-definition cable service or a high-definition satellite service. For the optimum picture quality, be sure to connect this device to your TV via the HDMI or component video (with audio) input on the back of your LCD TV.

HDMI Connection

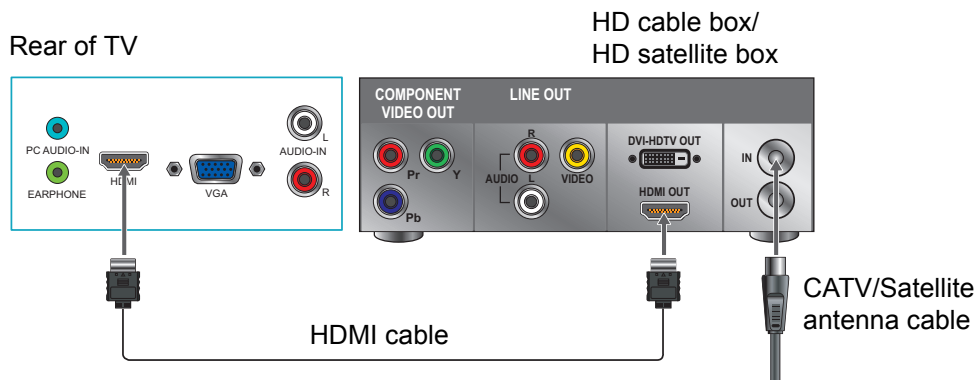

DVI Connection

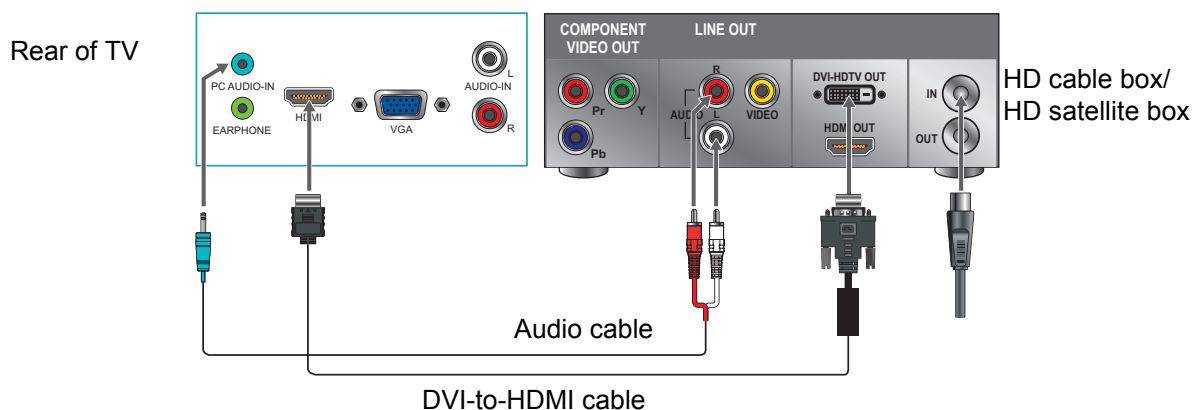

YPbPr or Component Connection

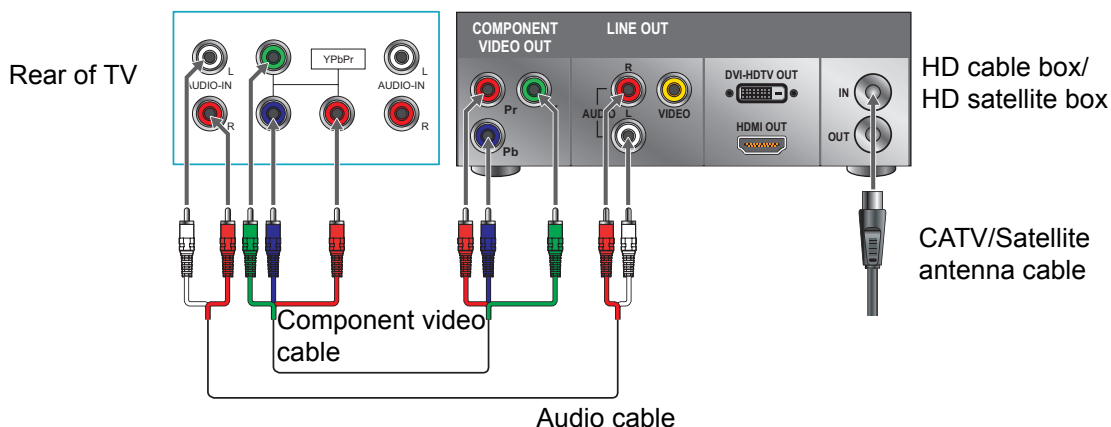

- If the equipment has a DVI jack and not an HDMI jack, connect the DVI jack to the HDMI jack [4] and connect the audio jack to the AUDIO In jacks of HDMI [2].

Contact ViewSonic service team at: <http://www.ViewSonic.com> or call our service team: United States 1-800-688-6688, Canada 1-866-463-4775

Getting Started

Personal Computer

Use the LCD TV as the monitor of your computer.

The picture below shows the connection for PC. The LCD TV can also be connected to PC with DVI or HDMI output.

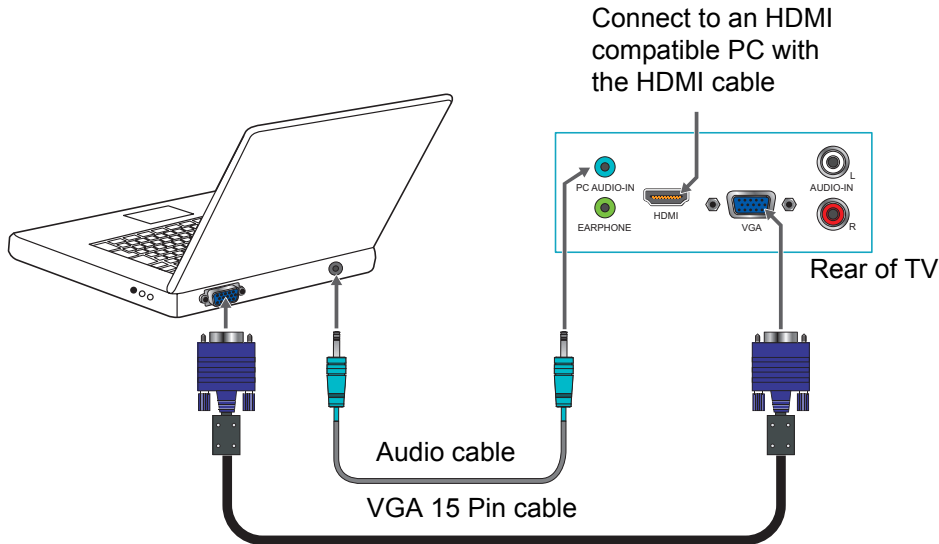

- Connect the PC IN jack to the PC using a 15-pin cable and audio cable.
- If the PC is connected to TV and no signal has been input from PC for more than 5 seconds, the TV will enter standby mode automatically.

PC Timing Reference Chart

Compatibility Table						
Standard	Resolution	Composite	SVHS	YPbPr	RGB	HDMI
DOS	720 x 400 @ 70Hz	No	No	No	Yes	Yes
VESA	640 x 480 @ 60Hz	No	No	No	Yes	Yes
VESA	640 x 480 @ 75Hz	No	No	No	Yes	Yes
VESA	800 x 600 @ 60Hz	No	No	No	Yes	Yes
VESA	800 x 600 @ 75Hz	No	No	No	Yes	Yes
MAC	832 x 624 @ 75Hz	No	No	No	Yes	Yes
VESA	1024 x 768 @ 60Hz	No	No	No	Yes	Yes
VESA	1024 x 768 @ 75Hz	No	No	No	Yes	Yes
VESA	1360 x 768 @ 60Hz	No	No	No	Yes	Yes
VESA	1280 x 1024 @ 60Hz	No	No	No	Yes	Yes†
VESA	1920 x 1080 @ 60Hz	No	No	No	Yes*	Yes†

* Reduced Blinking mode (CV-RBT)

† applicable only to VT3245 and VT3745

Getting Started

VT2645:

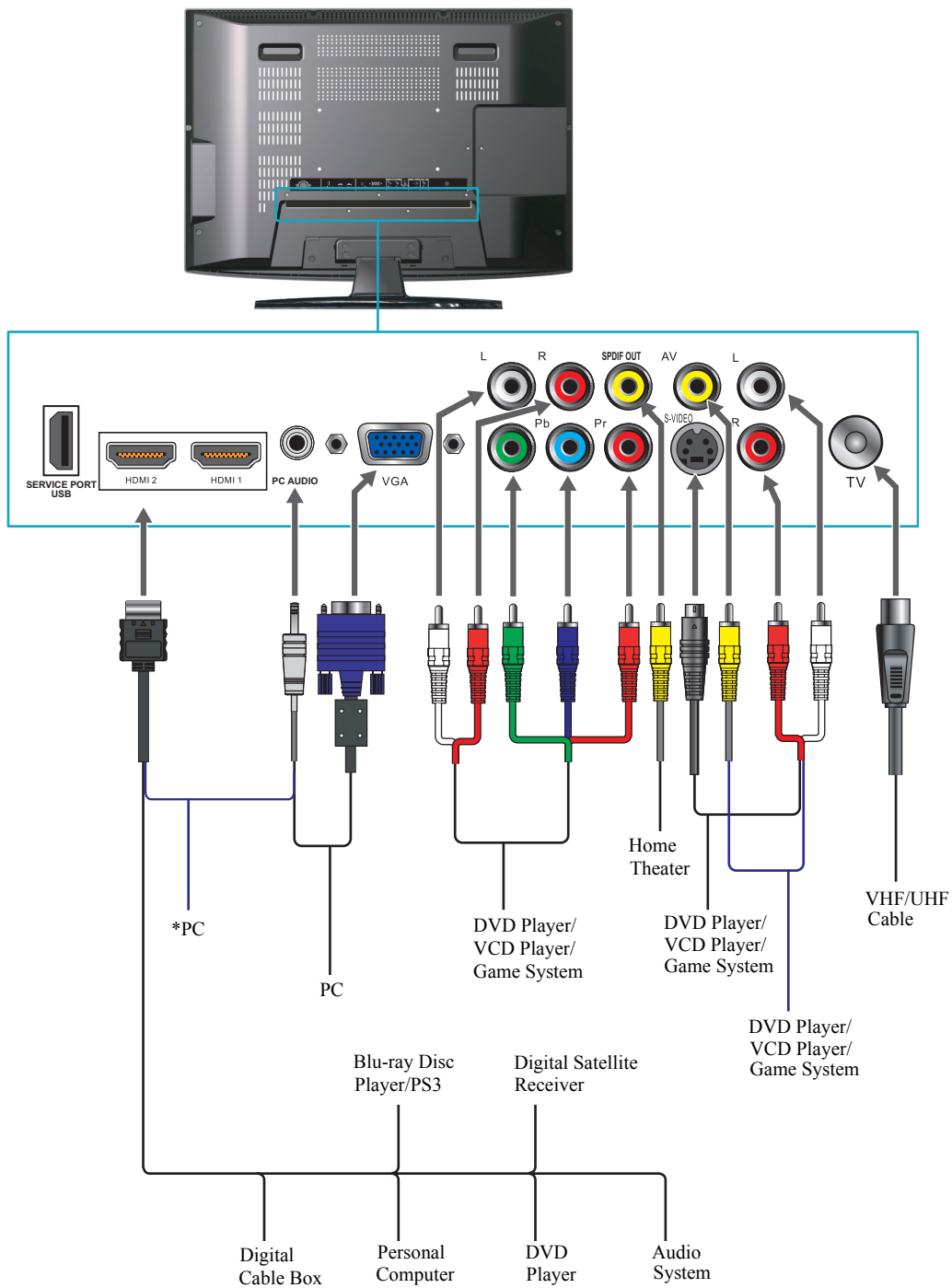

***Note:** For DVI connection please use DVI-to-HDMI cable/adaptor.

Getting Started

VT3245:

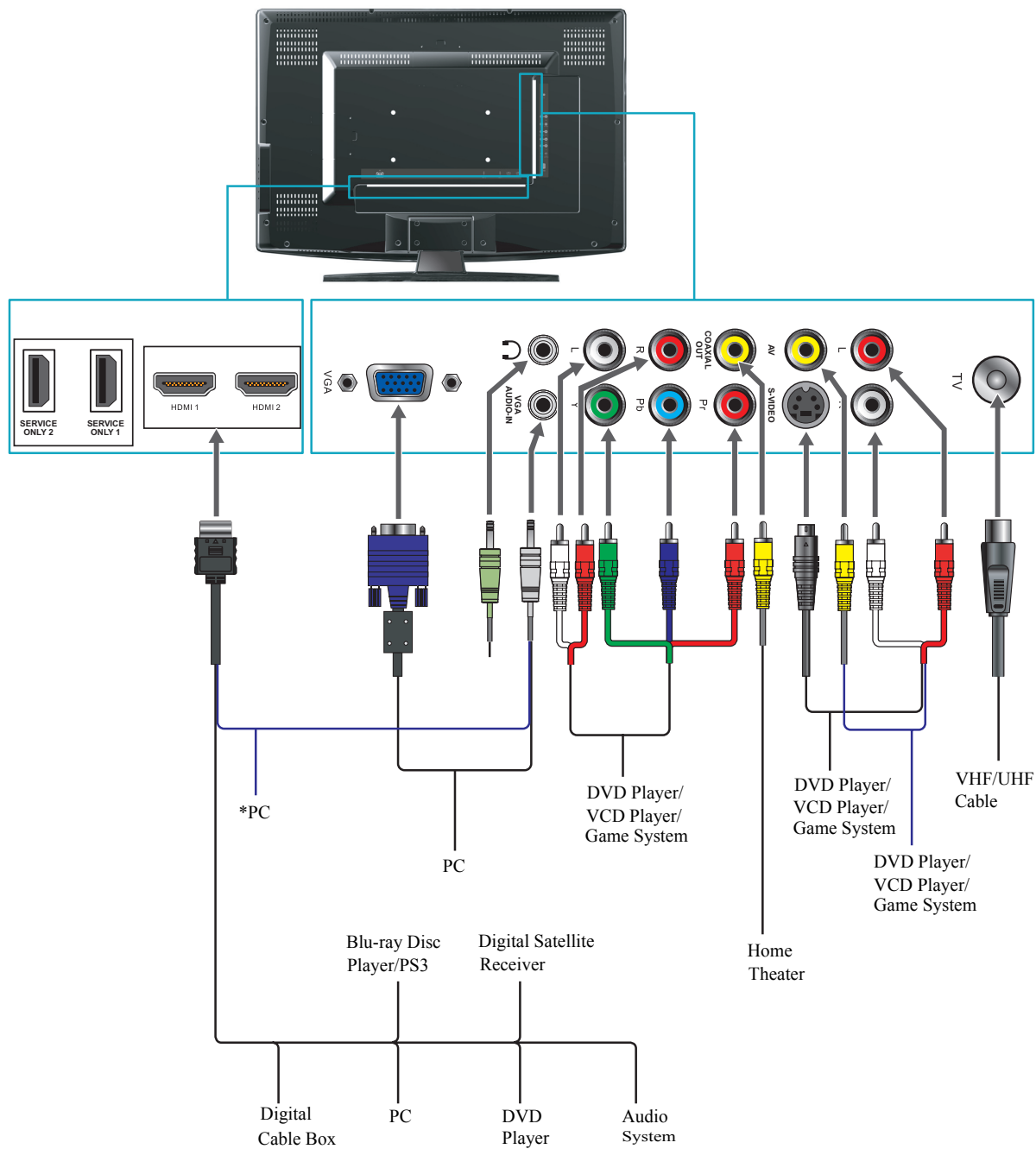

***Note:** For DVI connection please use DVI-to-HDMI cable/adaptor.

Contact ViewSonic service team at: <http://www.ViewSonic.com> or call our service team: United States 1-800-688-6688, Canada 1-866-463-4775

Getting Started

VT3745:

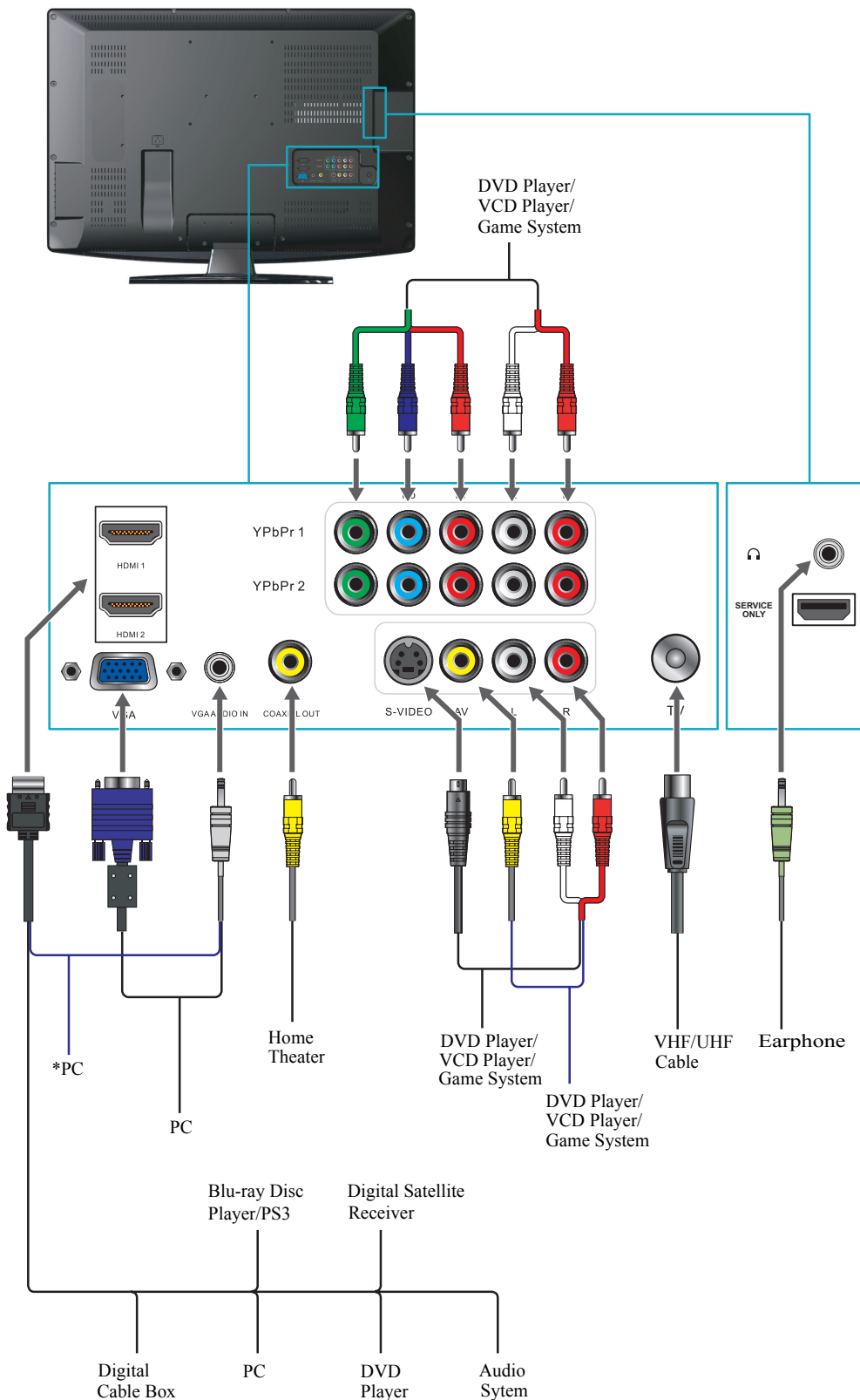

English

***Note:** For DVI connection please use DVI-to-HDMI cable/adapter.

Contact ViewSonic service team at: <http://www.ViewSonic.com> or call our service team: United States 1-800-688-6688, Canada 1-866-463-4775

Using TV Features

Remote Control and TV Controls

Inserting Remote Control Batteries

1. Remove the battery cover by pulling then lifting the knob on the cover.
2. Insert the batteries, corresponding to the (+) and (-) markings on the battery compartment.
3. Reattach the battery cover.

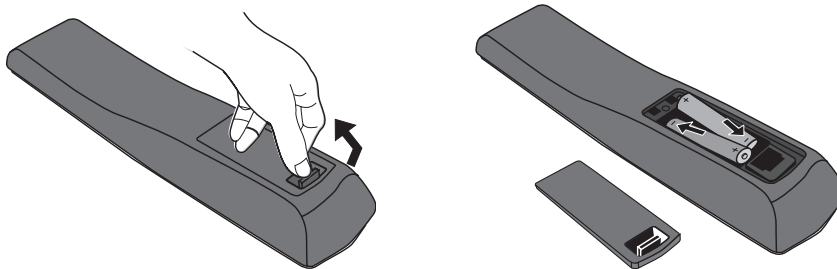

CAUTION

- Only use the specified AAA batteries.
- Do not mix new and old batteries. This may result in creaking or leakage, which may pose a risk of fire or lead to personal injury.
- Insert batteries according to (+) and (-) markings. Inserting the batteries incorrectly may result in leakage, which may pose a risk of fire or lead to personal injury.
- Dispose of the battery in accordance with local laws and regulations.
- Keep the batteries away from children or pets.
- When the remote control will not be used for an extended period, remove the batteries.

Using TV Features

Remote Control and TV Controls

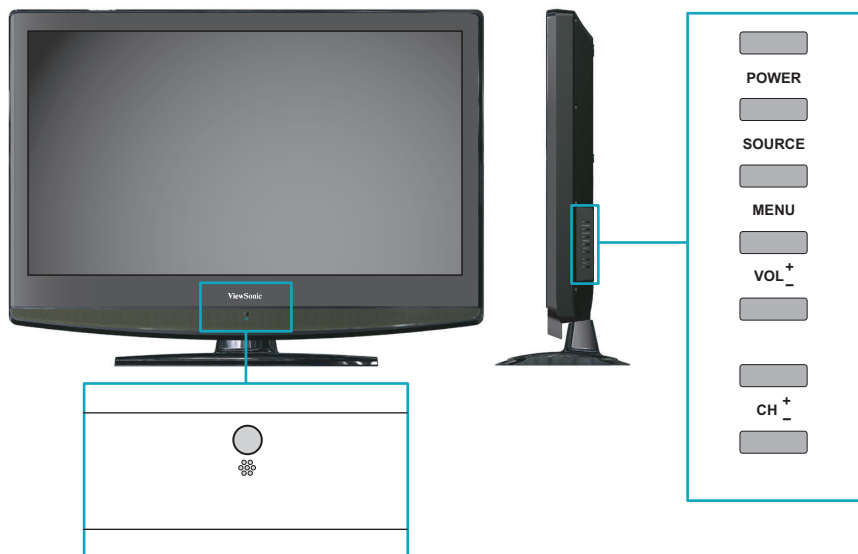

English

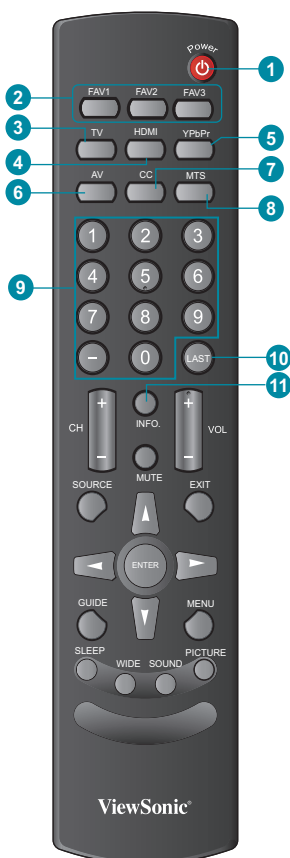

Button	Description
1 POWER	Press this button to turn the power on from standby mode. Press it again to return to the standby mode.
2 FAV 1-3	Press to select favorite channels
3 TV	Press to direct to TV source when in any other source.
4 HDMI	Press to select source to HDMI mode.
5 YPbPr	Press to select source to YPbPr mode.
6 AV	Press to select source to AV mode
7 CC	Press to turn Closed Caption On/Off
8 MTS	Press to activate Multichannel Television Sound, Stereo or Mono.
9 0~9, - number buttons	Press 0~9 and "-" to select a channel. After you input the channel numbers, press ENTER button to direct to the channel immediately, or wait for 3 seconds to change automatically.
10 LAST	Press to return to previous channel.
11 INFO	Press this button to display the current state of the LCD TV.

Contact ViewSonic service team at: <http://www.ViewSonic.com> or call our service team: United States 1-800-688-6688, Canada 1-866-463-4775

Using TV Features

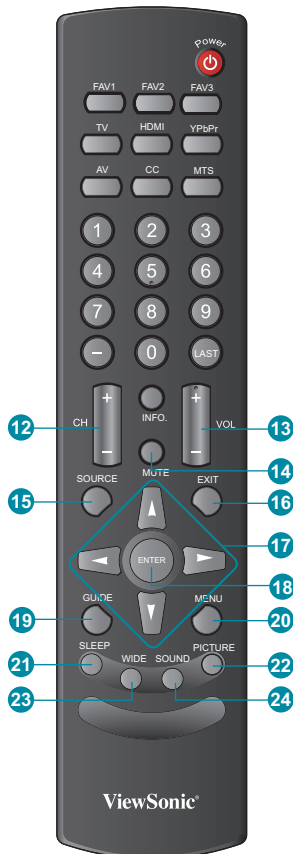

12	▲ CH ▼	Press to change the channels up or down.
13	+VOL-	Press to adjust the volume.
14	MUTE	Press to turn off the sound. To restore the sound, press this button again, or press the VOL+ / VOL- button.
15	SOURCE	Press to display the INPUT source list and select the source with ▲ / ▼ buttons. To confirm the selection, press ENTER .
16	EXIT	Press the button to exit the present menu.
17		Press these buttons to navigate the OSD menus. ▲ / ▼ is for function select, and ◀ / ▶ is for function adjustment.
18	ENTER	Press to confirm the selection in the OSD menu, or to enter the OSD menu you select. Pressing ENTER after you input channel numbers will change channels immediately.
19	GUIDE	Press to display the Electronic Program Guide (EPG). It contains the program information for the channel you're watching.
20	MENU	Press to turn the OSD (On-Screen Display) menu on.
21	SLEEP	Press repeatedly to set the off timer. The function is used to automatically shut off the LCD TV after a preset period of time passed. There are several times for choice – Off, 15 Min, 30 Min, 45 Min, 60 Min, 75 Min, 90 Min, 105 Min, and 120 Min.
22	PICTURE	Press to adjust Picture mode.
23	WIDE	Press to select Video Display format.
24	Sound	Press to adjust Sound mode.

How to Set the Favorite Channel

There are total four Favorite Channels which you can set the TV program what you like. This favorite channel function can support analog (NTSC) and digital (ATSC) TV.

Step 1: Change the channel number what you want for the favorite channel.

Using TV Features

Step 2: Press **FAV1**, **FAV2**, or **FAV3** on the remote control and hold this button for more than 3 seconds.

The current channel is saved as the favorite channel.

How to Select the Favorite Channel

Press **FAV1**, **FAV2**, or **FAV3** on the remote control and release it, then the TV will be change to the pre-stored channel number.

Operation

Turning the TV On and Off

Press the **POWER** button on the remote control.

You can also use the Power button on the front of the panel.



Changing Channels

1. Using Channel Buttons

Press **▲ CH ▼** button to change channels, and the TV changes channels in sequence. You will see all channels that have been memorized. Channels erased or not memorized will not be shown.

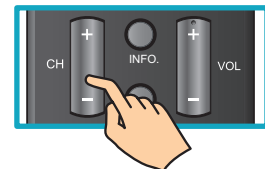

2. Using Number Buttons

Using the remote control buttons 0-9, select channel for NTSC/ATSC/CATV.

To select 1, 2 or 3-digit channel number (e.g., Channel 110)

Press 1 → 1 → 0.

To select 4-digit channel number (e.g. Channel 23-1)

Press 2 → 3 → - → 1.

Adjusting the Volume

Press **VOL +/-** to adjust volume.

To turn off the volume, press **MUTE**.

To restore volume, press **MUTE** again, or press **VOL +/-** directly.

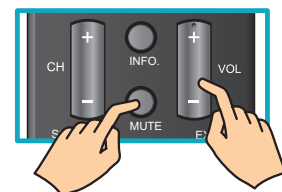

Viewing the Displayed Information

To display the current information of the LCD TV:

Press **INFO**, and the current state will be displayed on the screen. (It shows all or some of the information about Input, Channel, Resolution, Audio Type, etc., depending on what input source it is in)



Using TV Features

Using the OSD Menu

Read this section to learn how to make adjustments to your TV settings.

1. Press **POWER** to turn the LCD TV on.
2. Press **MENU** on the remote control to display the Main menu.
3. Use **◀ ▶** to highlight an OSD Menu and press **ENTER** to enter the OSD Menu.
4. Use **◀ ▶** to highlight an individual OSD option, then use **◀ ▶** to change the setting.
5. Press **ENTER** to enter next OSD layer, then press **MENU** to exit the menu.

- The OSD Menu appears as:

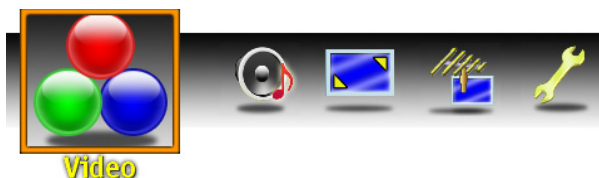

- Use **◀ ▶** to highlight an individual OSD option.

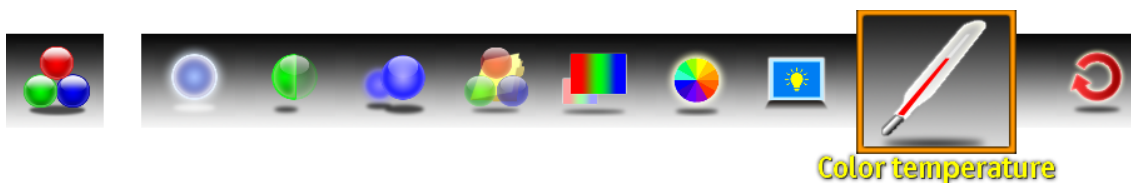

- Press **ENTER** to enter next OSD layer, use **◀ ▶** to change the setting, then press **ENTER** to confirm.



Using TV Features

Customizing the Video Settings

Allows you to make adjustments to your video settings.

1. Press **MENU** on the remote control to display the Main menu and use ◀ ▶ to select **Video**.
2. Use ◀ ▶ to highlight an individual **Video** option, then press **ENTER** to set up. Use ◀ ▶ to change the setting, then press **MENU** to exit the menu.

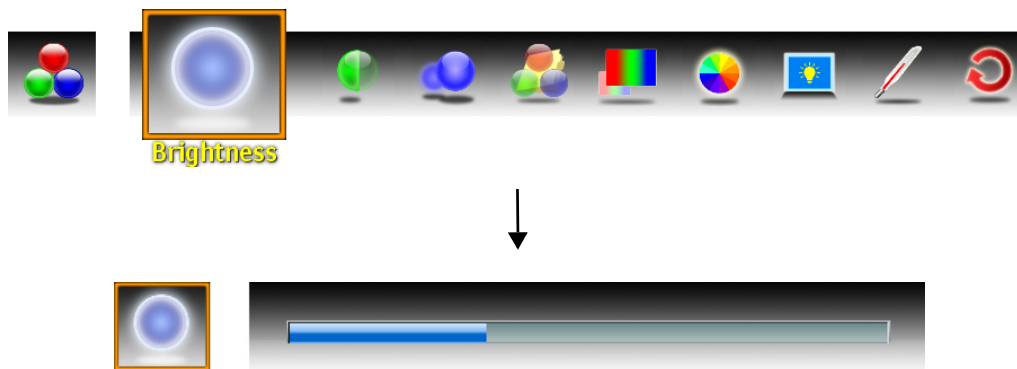

3. The Video menu includes the following options:

Brightness	Controls the overall brightness of the picture.
Contrast	Controls the difference between the brightest and darkest regions of the picture.
Sharpness	Increase this setting to see crisp edges in the picture; decrease it for soft edges.
Picture Mode	Selects the picture mode.
Color	Controls the overall color of the picture.
Tint	Controls the difference between the green and red regions of the picture.
Backlight	Changes the backlight of TV set. There are 3 different modes available: Dark Room , Medium Room , and Bright Room .
Color Temperature	Adjusts the color temperature to achieve a warm or cool effect: Warm: Increases warm effect. Cool: Increases cool effect. Neutral: Panel native temperature.
Memory Recall	Resets all settings of Video.

Using TV Features

Customizing the Audio Settings

Allows you to make adjustments to your video settings.

1. Press **MENU** on the remote control to display the Main menu and use ◀ ▶ to select **Audio**.
2. Use ◀ ▶ to highlight an individual **Audio** option, then press **ENTER** to set up.
3. Use ◀ ▶ to change the setting, then press **MENU** to exit the menu.



4. The Audio menu includes the following options:

Bass	Controls the relative intensity of lower-pitched sounds.
Treble	Controls the relative intensity of higher pitched sounds.
Balance	Adjusts the relative volume of the speakers in a multiple speaker system.
TV Speaker	Turns the TV speaker on or off.
Audio mode	Allows selection of an audio-enhancement technique from the following options: Rock / POP / Classical / Flat .
SRS	Adjusts the SRS surround sound settings: * SRS: Turn the SRS on or off. TruBass: Adjust TruBass to on/off, low, medium, high. DialogClarity: Adjust Dialog Clarity to on/off, low, medium, high. *available only for VT3245 and VT3745
Audio Only	Turns off video and gives out audio only. Press any key to show video.
Memory Recall	Resets all settings of Audio.

Using TV Features

Customizing the Screen Settings

Allows you to customize the screen settings.

1. Press **MENU** on the remote control to display the Main menu and use ◀▶ to select **Screen**.
2. Use ◀▶ to highlight an individual **Screen** option, then press **ENTER** to set up.
3. Use ◀▶ to change the setting, then press **MENU** to exit the menu.

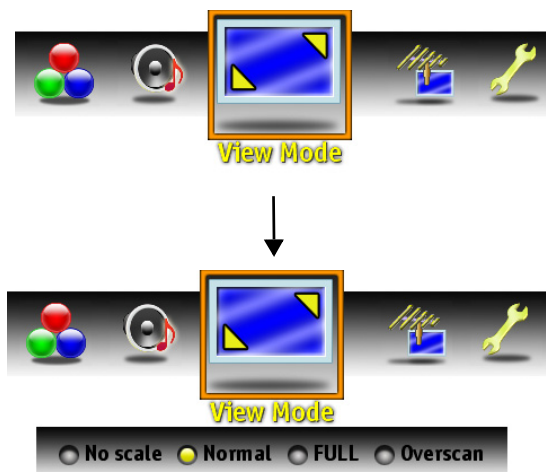

4. The Screen menu includes the following options:*

No Scale	Displays the 1:1 size of the original content.
Normal	Keeps the source display ratio. If the original input content is 4:3, then shows 4:3. If the original input content is 16:9, then shows 16:9.
Full	Enlarges the standard 4:3 source video to the 16:9 full screen video. When the source video is 16:9 in ratio, no change will occur.
Overscan	Enlarges the original picture horizontally and vertically to an equal aspect ratio that fills the screen. The redundant part of the upper, bottom, left and right of the image will be removed.

* **NOTE:** all options are applicable only to display of VGA source.

Using TV Features

Customizing the TV Program Settings

Allows you to make adjustments to your TV Program settings.

1. Press **SOURCE** on the remote control then use ◀ ▶ to select **TV** and press **ENTER**.
2. Press **MENU** on the remote control to display the Main menu and use ◀ ▶ to select **TV Program**.
3. Press **ENTER** to begin setup.
4. Use ◀ ▶ to highlight an individual **TV Program** option, then press **ENTER** to set up.
5. Use ◀ ▶ to change the setting, then press **MENU** to exit the menu.

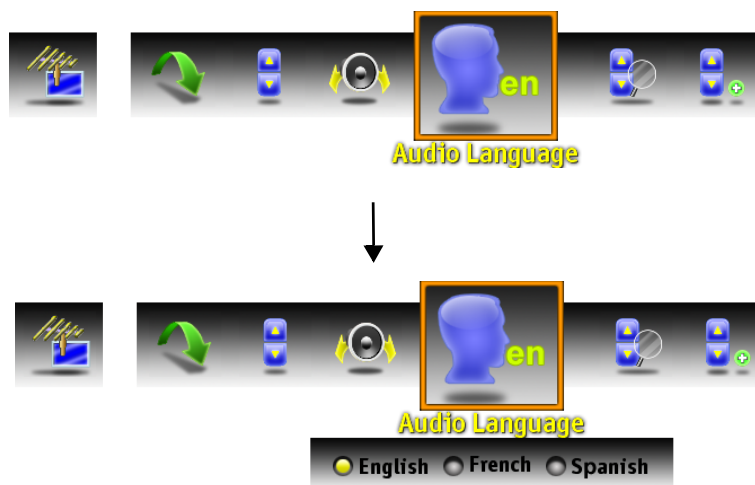

6. The TV Program menu includes the following options:

1. Select **Skip List** from the TV Program menu and press **ENTER**. The Channel Skip List menu appears:

Skip List

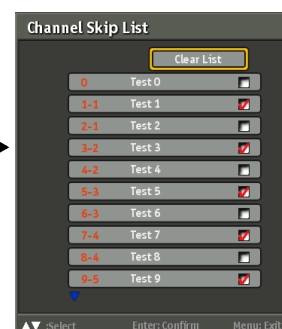

2. Press ▼ to select the desired channel and press **ENTER** repeatedly to add or clear the channel from the favorite list.

Using TV Features

Allows you to assign a name to a channel.

1. Select **Skip List** from the TV Program menu and press **ENTER**. The Channel Skip List menu appears.

Channel Edit

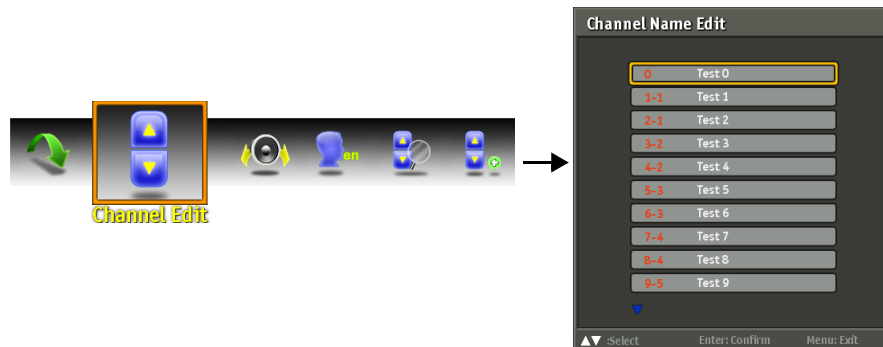

2. Press **▼** to select the desired channel and press **ENTER** to enter the Channel Name Edit screen.
3. Use **▲ ▼ ◀ ▶** to move the cursor to the character you want to enter and press **ENTER** to enter characters. Select **Accept** when finished.

Allows you to add channels manually.

1. Select **Manual Add** from the TV Program menu and press **ENTER**. The Channel Add screen appears:

Manual Add



2. Use the **0-9** to enter the channel number, select **Enter** on the screen, and press **ENTER** to confirm.

Allows you to listen to high-fi delity stereo sound while watching TV.

MTS

- **Stereo**
Use separate audio tracks for left and right speakers, if available.
- **SAP**
You can enjoy a second audio program from the speakers while watching a scene in the original program.
- **Mono**
You can enjoy a second audio program from the speakers while watching a scene in the original program

Audio Language

Allows the user to select the audio language:
English/French/Spanish.

Using TV Features

Press **ENTER**, the **Auto Scan** automatically creates a list of receivable channels for the source you select:

Auto Scan

- **Cable**

Choose this setting if you are receiving TV channels with a CATV (cable TV)

- **AIR**

Choose this setting if you are receiving TV channels with an antenna (over the air)

Using TV Features

Customizing the Setup Settings

Allows you to set up a variety of features: Date and Time, Close Caption, Parental Control, OSD Timeout, OSD Language, Reset All, and Version.

1. Press **MENU** on the remote control to display the Main menu and use ◀ ▶ to select **Settings**.
2. Use ◀ ▶ to highlight an individual **Settings** option.
3. Use ◀ ▶ to change the setting, then press **ENTER** to confirm.

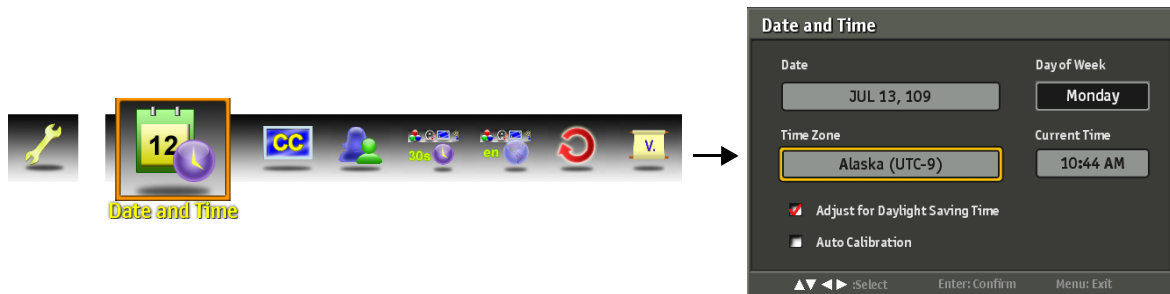

4. The Settings menu includes the following options:

Allows the user to set the current time.

Auto Calibration:

- **ON**: Selects to display the TV or cable system's current time.
- **OFF**: Selects to set the current time.

Date and Time

1. Press ▲ ▼ to select the Date, Current Time or Time Zone.
2. Press ▲ ▼ ◀ ▶ to move each setting, and use 0-9 keys to set the current time.
3. Press ▲ ▼ to select the regional TV systems of USA: Eastern Time/Indiana/Central time/Mountain Time/Arizona/Pacific Time/Alaska/Hawaii/Newfoundland/Atlantic Canada.
4. Press ▲ ▼ to select **Adjust for Daylight Saving Time** and press **ENTER** repeatedly to set Daylight Saving on or off.

Using TV Features

Allows the user to select from analog or digital closed caption modes.

1. Select **Closed Caption** from the Setup menu and press **ENTER**. The Close Caption screen appears:

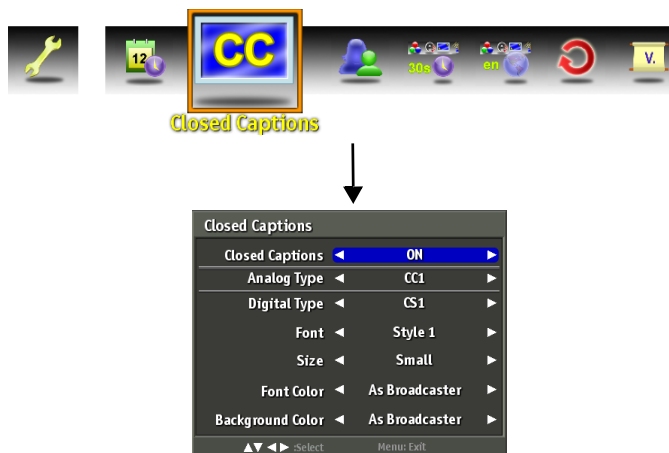

2. Press **◀▶** to turn the Close Caption on. The following options appear:

Analog Type:

Press **◀▶** to select the basic analog closed caption options:

- CC1 /CC2 /CC3 /CC4:

Display a printed version of the dialog and sound effects of the program being viewed.

Digital Type:

Press **◀▶** to select the digital closed caption options:

Service1/Service2/Service3/Service4/Service5/Service6/
OFF

Font:

Press **◀▶** to select the font for your closed caption:

As Broadcaster/Style 1/Style 2/Style 3/Style 4/Style 5/Style
6/Style 7

Size:

Press **◀▶** to select the font size for your closed caption:

As Broadcaster/Small/Medium/Large

Font Color:

Press **◀▶** to select the font color for your closed caption:

As Broadcaster/Black/White/Green/Blue/Red/Cyan/Yellow/
Magenta

Background Color:

Press **◀▶** to select the background color for your closed caption:

As Broadcaster/Black/White/Green/Blue/Red/Cyan/Yellow/
Magenta

Closed Captions

Using TV Features

Parental Control can be used to block channels and change password.

1. Select **Parental Control** from the Setup menu and press **ENTER**.



2. To use the Parental Control function you must enter a 6 digit password. The factory default is **999999**.
3. The Parental Control menu appears.
4. Use ◀ ▶ to highlight an individual **Parental Control** option, then use 0-9 to enter the password.

Parental Control



5. Use ▲ ▼ ◀ ▶ to move the cursor, then press **ENTER** repeatedly to toggle between **BLOCK** or to **UNBLOCK**.

Please see “Customizing the Parental Control Settings” on page 39 for more details.

OSD Timeout	Allows the user to adjust the OSD duration on the screen: 10 sec/20 sec/30 sec.
OSD Language	Allows the user to select the OSD language: English/French/Spanish.
Version	Press ENTER to view the current TV version.
DCR	Press ENTER to turn on/off dynamic contrast ratio.
Reset All	Press ENTER to reset all settings and restore defaults.

Using TV Features

Customizing the Parental Control Settings

1. Press **MENU** on the remote control to display the Main menu, and use ◀ ▶ to select **Setup**.
2. Use ▼ to highlight **Parental**, then press **ENTER**.



3. Use the **Parental** function, you must enter a six-digit password. The factory password is **999999**.

4. The **Parental Control** menu includes the following options:

Rating	Select ON/OFF to activate/deactivate the Rating programs.
Block Unrated	Select ON/OFF to block/unlock all unrated programs.

TV Ratings

Select to customize US TV Rating programs.

Use ▲ ▼ ◀ ▶ to select the rating you want and press **ENTER** repeatedly to select **BLOCK** or **UNBLOCK**.

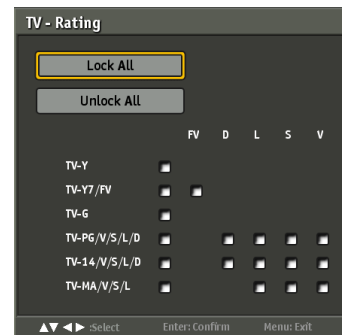

TV RATING	DESCRIPTION
TV-Y	All children
TV-Y7	For children age 7 and older
TV-G	General Audience
TV-PG	Parental Guidance suggested
TV-14	Parents strongly cautioned
TV-MA	Mature Audience only
FV	Fantasy violence
D	Suggestive dialogue
L	Strong language
S	Sexual situations
V	Violence
ALL	All contents are blocked

Contact ViewSonic service team at: <http://www.ViewSonic.com> or call our service team: United States 1-800-688-6688, Canada 1-866-463-4775

Using TV Features

MPAA Ratings

Select to customize US Movie Rating programs.

Use ▲ ▼ ◀ ▶ to select the rating you want and press **ENTER** repeatedly to select **BLOCK** or **UNBLOCK**.

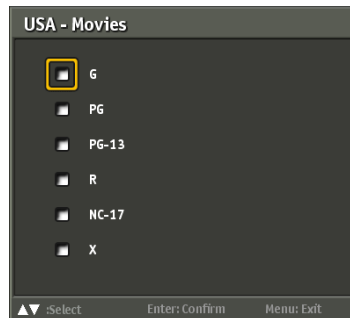

MPAA RATING	DESCRIPTION
G	General Audiences. Movie is appropriate for all ages
PG	Parental Guidance Suggested. May contain material not suited for younger viewers
PG-13	Contains content that may not be appropriate for viewers under the age of 13
R	Restricted. Contains adult content, no one under 17 admitted without parent
NC-17	No one 17 and under admitted
X	Adult programming

Canada English Ratings

Use ▲ ▼ ◀ ▶ to select the rating you want and press **ENTER** repeatedly to select **BLOCK** or **UNBLOCK**.



MPAA RATING	DESCRIPTION
E	Exempt shows
G	All children
C8+	Children 8 years and older
G	General programming
PG	Parental guidance
14+	Viewers 14 and older
18+	Adult programming

Contact ViewSonic service team at: <http://www.ViewSonic.com> or call our service team: United States 1-800-688-6688, Canada 1-866-463-4775

Using TV Features

Canada French Ratings

Use ▲ ▼ ◀ ▶ to select the rating you want and press **ENTER** repeatedly to select **BLOCK** or **UNBLOCK**.

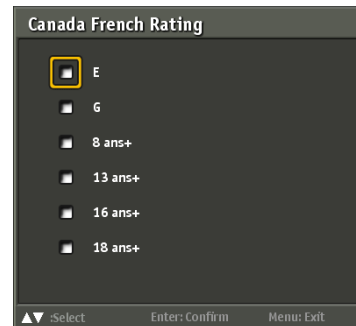

MPAA RATING	DESCRIPTION
E	Exempt shows
G	General programming
8 ans+	Not recommended for ages under 8
13 ans+	Not recommended for ages under 13
16 ans+	Not recommended for ages under 16
18 ans+	Programming restricted to adults.

Channel Block

Channel Block allows user to block digital channels.

1. Press ▲ ▼ to select the channel.
2. Press **ENTER** repeatedly to select **BLOCK** or **UNBLOCK**.

Change Password

Select to change the password.

1. Select **Change Password** from the Parental Control menu and press **ENTER**.
2. The Enter Password screen appears.
3. Use **0-9** to enter your current password and press **ENTER**.
4. Use **0-9** to enter the new password and press **ENTER**.
5. Use **0-9** to enter the new password again for confirmation then press **ENTER**.

Other Information

Cleaning the LCD TV

- Make sure the LCD TV is turned off.
- Never spray or pour any liquid directly onto the screen or case.

To clean the screen:

1. Wipe the screen with a clean, soft, lint-free cloth. This removes dust and other particles.
2. If still not clean, apply a small amount of non-ammonia, non-alcohol based glass cleaner onto a clean, soft, lint-free cloth, and wipe the screen.

To clean the case:

1. Use a soft, dry cloth.
2. If still not clean, apply a small amount of a non-ammonia, non-alcohol based, mild non-abrasive detergent onto a clean, soft, lint-free cloth, then wipe the surface.

Disclaimer

ViewSonic® does not recommend the use of any ammonia or alcohol-based cleaners on the LCD TV screen or case. Some chemical cleaners have been reported to damage the screen and/or case of the LCD TV. ViewSonic will not be liable for damage resulting from use of any ammonia or alcohol-based cleaners.

Troubleshooting

Please contact ViewSonic service team directly if you have questions, service needs, or require technical assistance related on the use of your television.

Contact ViewSonic Service Team at:

<http://www.ViewSonic.com>

Or call our service team:

United States 1-800-688-6688

Canada 1-866-463-4775

Problem	Possible Solution
No power	<ul style="list-style-type: none">• Make sure the power cord is properly connected to the LCD TV AC power socket.• Make sure the AC power cord is properly connected to the wall outlet.• Make sure the DC power button is ON (Blue LED).• Plug another electrical device (like a radio) to the power outlet to verify that the outlet is supplying the proper voltage.
No picture	<ul style="list-style-type: none">• The TV station may be experiencing problems. Try another channel.• The Cable TV signal may be scrambled or encoded. Please contact your local cable operator.• Make sure that connection to other components are correct referring to the user guide.• Make sure that setup has been done correctly after connections.• Make sure the correct input is selected and the input signal is compatible.
Strange color, light color, or color misalignment	<ul style="list-style-type: none">• Ensure that the video cable is securely connected.• The picture may appear dim in a brightly lit room.• Adjust brightness, contrast, saturation (color), and tint referring to the user guide.• Check the input signal setting.
Unit cannot be operated	<ul style="list-style-type: none">• External influences such as lightning or static electricity may cause improper operation. In this case, operate the unit after first turning on the power of the LCD TV and the AVC System, or unplug the AC cord for 1 to 2 minutes, then plug in again.

Other Information

<i>Problem</i>	<i>Possible Solution</i>
No sound	<ul style="list-style-type: none"> • Check your audio connections are properly connected referring to the user guide. • The MUTE button may have been pressed, try pressing this button again. • Check your audio settings, your TV audio may be set to minimum. • Press the Volume + (Up) button on the remote control.
Remote control unit does not operate	<ul style="list-style-type: none"> • Make sure the directions of batteries are inserted correctly referring to the user guide. • Batteries could be weak or dead. Replace with new batteries. • Is a fluorescent light illuminated near the remote control sensor? • The path of the remote control beam may be blocked. Make sure the path is clear and that the remote control is aimed at the remote control sensor on the TV. • Press the POWER button on the remote control to see if you can turn on the TV. • Press MENU button on the remote control to see if there is a MENU shown on the screen. • Press only one button at a time and it is the correct one for the operation you want to perform.
Picture is cut off/with sidebar screen	<ul style="list-style-type: none"> • Is the image positioned correctly? • Are screen mode adjustments such as picture size set correctly? • Press WIDE button repeatedly on the remote control to see if you can get the picture you prefer.
Power is cut off suddenly	<ul style="list-style-type: none"> • Is the sleep timer set in advance? • Is there no signal in PC mode or HDMI mode? • The internal temperature of the unit has increased. Remove any objects blocking the vent or clean as necessary.
No CATV reception (or no reception above CH13)	<ul style="list-style-type: none"> • Is the AIR/CABLE option set correctly? Please set the AIR/CABLE option to CABLE referring to the user guide. • CATV is connected improperly or not connected; please check all the CATV connections. • The cable TV service is interrupted; please contact your cable operator.

Other Information

Specifications

Model		VT2645	VT3245	VT3745
LCD	Type	26" TFT Active Matrix RGB 0.1405 (H) x 0.4215 (V) mm pixel	32" TFT Active Matrix RGB 0.12125 (H) x 0.36375 (V) mm pixel	37" TFT Active Matrix RGB 0.14225 (H) x 0.42675 (V) mm pixel
	Color Filter Glass surface	RGB vertical stripe Anti-Glare	RGB vertical stripe Anti-Glare	RGB vertical stripe Anti-Glare
	Native Resolution	1366 x 768	1920 x 1080	1920 x 1080
Input signal	RGB	RGB analog (0.7/1.0 Vp-p, 75 ohms) Separate Sync, fh: 30-80 kHz, fv:50-75 Hz	RGB analog (0.7/1.0 Vp-p, 75 ohms) Separate Sync, fh: 30-80 kHz, fv:50-75 Hz	RGB analog (0.7/1.0 Vp-p, 75 ohms) Separate Sync, fh: 30-80 kHz, fv:50-75 Hz
	RF Video	TV system Antenna/ NTSC+ATSC, TV cable system/ CATV+Digital cable 1 composite RCA, 1 S- Video, 1 YPbPr component, 2 HDMI	TV system Antenna/ NTSC+ATSC, TV cable system/ CATV+Digital cable 1 composite RCA, 1 S- Video, 1 YPbPr component, 2 HDMI	TV system Antenna/ NTSC+ATSC, TV cable system/ CATV+Digital cable 1 composite RCA, 1 S- Video, 2 YPbPr component, 2 HDMI
	Audio	1 mini-stereo, 2 pair of RCA (L/R) stereo	1 mini-stereo, 2 pair of RCA (L/R) stereo	1 mini-stereo, 2 pair of RCA (L/R) stereo
Compatibility	PC	640 x 480 @ 60Hz 640 x 480 @ 75Hz 800 x 600 @ 60Hz 800 x 600 @ 75Hz 1024 x 768 @ 60Hz 1024 x 768 @ 75Hz 1360 x 768 @ 60Hz	640 x 480 @ 60Hz 640 x 480 @ 75Hz 800 x 600 @ 60Hz 800 x 600 @ 75Hz 1024 x 768 @ 60Hz 1024 x 768 @ 75Hz 1360 x 768 @ 60Hz 1920 x 1080 @ 60Hz	640 x 480 @ 60Hz 640 x 480 @ 75Hz 800 x 600 @ 60Hz 800 x 600 @ 75Hz 1024 x 768 @ 60Hz 1024 x 768 @ 75Hz 1280 x 1024 @ 60Hz 1920 x 1080 @ 60Hz
		Recommended and supported (AV/S-Video Mode)	NTSC	NTSC
Resolution Table	Recommended and supported (YPbPr/HDMI Mode)	480i @ 60Hz 480p @ 60Hz 720p @ 60 Hz 1080i @ 60Hz	480i @ 60Hz 480p @ 60Hz 720p @ 60 Hz 1080i @ 60Hz 1080p @ 60Hz	480i @ 60Hz 480p @ 60Hz 720p @ 60 Hz 1080i @ 60Hz 1080p @ 60Hz
	Speaker Output	5W x 2 @ THD=10%	10W x 2 @ THD=10%	10W x 2 @ THD=10%
Audio Output		1 SPIDF	1 SPIDF, 1 Headphone jack	1 SPIDF, 1 Headphone jack
Power	Voltage	100-120 VAC, 50/60 Hz	100-120 VAC, 50/60 Hz	100-120 VAC, 50/60 Hz
Display area	Full Scan	575.769mm (H) x 323.712mm (V) 22.66" (H) x 12.74" (V)	698.4mm (H) x 392.85mm (V) 27.49" (H) x 15.46" (V)	819.36mm (H) x 460.89mm (V) 32.25" (H) x 18.14" (V)
Operating conditions	Temperature	32°F to + 104°F (0°C to + 40°C)	32°F to + 104°F (0°C to + 40°C)	32°F to + 104°F (0°C to + 40°C)
	Humidity Altitude	20% to 65% (no condensation) To 10,000 feet (3,000m)	20% to 65% (no condensation) To 10,000 feet (3,000m)	20% to 65% (no condensation) To 10,000 feet (3,000m)

Contact ViewSonic service team at: <http://www.ViewSonic.com> or call our service team: United States 1-800-688-6688, Canada 1-866-463-4775

Other Information

Storage condition	Temperature Humidity Altitude	-4°F to + 140°F (-20°C to + 60°C) 10% to 90% (no condensation) To 40,000 feet (12,000m)	-4°F to + 140°F (-20°C to + 60°C) 10% to 90% (no condensation) To 40,000 feet (12,000m)	-4°F to + 140°F (-20°C to + 60°C) 10% to 90% (no condensation) To 40,000 feet (12,000m)
Dimensions	Physical (W)x(H)x(D)	657.7mm x 506.5mm x 220mm 25.89"x19.94"x8.66"	783.4mm x 580mm x 220mm 30.84"x22.83"x8.66"	900mm x 678mm x 255mm 35.43"x26.69"x10.03"
Weight	Net	7.3 kg (16.07 lb)	10.5 kg (23.12 lb)	14.0 kg (30.83 lb)
Regulations		UL/cUL, FCC-B (Doc-B), BETS-7, ENERGY STAR [®] , CEC	UL/cUL, FCC-B (Doc-B), NOM, BETS-7, ENERGY STAR [®] , CEC	UL/cUL, FCC-B (Doc-B), BETS-7, ENERGY STAR [®] , CEC.
Power consumption	On Standby	Max. 75 W (blue LED) < 1 W at 110 Vac only (orange LED)	Max. 135 W (blue LED) < 1 W at 110 Vac only (orange LED)	Max. 145 W (blue LED) < 1 W at 110 Vac only (orange LED)
Warning: Do not set the graphics card in your computer to exceed these refresh rates; doing so may result in permanent damage to the LCD TV.				

Note: Product Specifications are subject to change without notice.

Limited Warranty

VIEWSONIC® LCD TV

What the warranty covers:

ViewSonic warrants its products to be free from defects in material and workmanship, under normal use, during the warranty period. If a product proves to be defective in material or workmanship during the warranty period, ViewSonic will at its sole option repair or replace the product with a like product. Replacement product or parts may include remanufactured or refurbished parts or components.

How long the warranty is effective:

ViewSonic LCD TV are warranted for one (1) year for all parts excluding the light source and one (1) year for labor from the date of the first customer purchase.

Who the warranty protects:

This warranty is valid only for the first consumer purchaser.

What the warranty does not cover:

1. Any product on which the serial number has been defaced, modified or removed.
2. Damage, deterioration or malfunction resulting from:
 - a. Accident, misuse, neglect, fire, water, lightning, or other acts of nature, unauthorized product modification, or failure to follow instructions supplied with the product.
 - b. Repair or attempted repair by anyone not authorized by ViewSonic.
 - c. Any damage of the product due to shipment.
 - d. Removal or installation of the product.
 - e. Causes external to the product, such as electric power fluctuations or failure.
 - f. Use of supplies or parts not meeting ViewSonic's specifications.
 - g. Normal wear and tear.
 - h. Any other cause which does not relate to a product defect.
3. Any product exhibiting a condition commonly known as "image burn-in" which results when a static image is displayed on the product for an extended period of time.
4. Removal, installation, and set-up service charges.
5. When you mount it on the wall, the following must be noticed:
 - a. The accessories attached with this product are applicable for this product only.
 - b. When the product is mounted on the wall, holes and fixed screws will remain in the wall body.
 - c. Wall face may discolor when this product has been mounted on the wall for a long time.

How to get service:

1. For information about receiving service under warranty, contact ViewSonic Customer Support. You will need to provide your product's serial number.
2. To obtain warranted service, you will be required to provide (a) the original dated sales slip, (b) your name, (c) your address, (d) a description of the problem, and (e) the serial number of the product.
3. Take or ship the product freight prepaid in the original container to an authorized ViewSonic service center or ViewSonic.
4. For additional information or the name of the nearest ViewSonic service center, contact ViewSonic.

Limitation of implied warranties:

There are no warranties, expressed or implied, which extend beyond the description contained herein including the implied warranty of merchantability and fitness for a particular purpose.

Exclusion of damages:

ViewSonic's liability is limited to the cost of repair or replacement of the product. ViewSonic shall not be liable for:

1. Damage to other property caused by any defects in the product, damages based upon inconvenience, loss of use of the product, loss of time, loss of profits, loss of business opportunity, loss of goodwill, interference with business relationships, or other commercial loss, even if advised of the possibility of such damages.
2. Any other damages, whether incidental, consequential or otherwise.
3. Any claim against the customer by any other party.

Effect of state law:

This warranty gives you specific legal rights, and you may also have other rights which vary from state to state. Some states do not allow limitations on implied warranties and/or do not allow the exclusion of incidental or consequential damages, so the above limitations and exclusions may not apply to you.

Sales outside the U.S.A. and Canada:

For warranty information and service on ViewSonic products sold outside of the U.S.A. and Canada, contact ViewSonic or your local ViewSonic dealer.

The warranty period for this product in mainland China (Hong Kong, Macao and Taiwan Excluded) is subject to the terms and conditions of the Maintenance Guarantee Card.

For users in Europe and Russia, full details of warranty provided can be found in www.viewsoniceurope.com under Support/Warranty Information.

4.3: ViewSonic LCD TV Warranty

LTV_LW01 Rev. 1C 10-28-08

Mexico Limited Warranty

VIEWSONIC® LCD TV

What the warranty covers:

ViewSonic warrants its products to be free from defects in material and workmanship, under normal use, during the warranty period. If a product proves to be defective in material or workmanship during the warranty period, ViewSonic will, at its sole option, repair or replace the product with a like product. Replacement product or parts may include remanufactured or refurbished parts or components & accessories.

How long the warranty is effective:

ViewSonic LCD TVs are warranted for 1 year for all parts excluding the light source and 1 year for labor from the date of the first customer purchase.

Who the warranty protects:

This warranty is valid only for the first consumer purchaser.

What the warranty does not cover:

1. Any product on which the serial number has been defaced, modified or removed.
2. Damage, deterioration or malfunction resulting from:
 - a. Accident, misuse, neglect, fire, water, lightning, or other acts of nature, unauthorized product modification, unauthorized attempted repair, or failure to follow instructions supplied with the product.
 - b. Any damage of the product due to shipment.
 - c. Causes external to the product, such as electrical power fluctuations or failure.
 - d. Use of supplies or parts not meeting ViewSonic's specifications.
 - e. Normal wear and tear.
 - f. Any other cause which does not relate to a product defect.
3. Any product exhibiting a condition commonly known as "image burn-in" which results when a static image is displayed on the product for an extended period of time.
4. Removal, installation, insurance, and set-up service charges.

How to get service:

For information about receiving service under warranty, contact ViewSonic Customer Support (Please refer to the attached Customer Support page). You will need to provide your product's serial number, so please record the product information in the space provided below on your purchase for your future use. Please retain your receipt of proof of purchase to support your warranty claim.

For Your Records

Product Name: _____ Model Number: _____

Document Number: _____ Serial Number: _____

Purchase Date: _____ Extended Warranty Purchase? _____ (Y/N)

If so, what date does warranty expire? _____

1. To obtain warranty service, you will be required to provide (a) the original dated sales slip, (b) your name, (c) your address, (d) a description of the problem, and (e) the serial number of the product.
2. Take or ship the product in the original container packaging to an authorized ViewSonic service center.
3. Round trip transportation costs for in-warranty products will be paid by ViewSonic.

Limitation of implied warranties:

There are no warranties, expressed or implied, which extend beyond the description contained herein including the implied warranty of merchantability and fitness for a particular purpose.

Exclusion of damages:

ViewSonic's liability is limited to the cost of repair or replacement of the product. ViewSonic shall not be liable for:

1. Damage to other property caused by any defects in the product, damages based upon inconvenience, loss of use of the product, loss of time, loss of profits, loss of business opportunity, loss of goodwill, interference with business relationships, or other commercial loss, even if advised of the possibility of such damages.
2. Any other damages, whether incidental, consequential or otherwise.
3. Any claim against the customer by any other party.
4. Repair or attempted repair by anyone not authorized by ViewSonic.



Free Manuals Download Website

<http://myh66.com>

<http://usermanuals.us>

<http://www.somanuals.com>

<http://www.4manuals.cc>

<http://www.manual-lib.com>

<http://www.404manual.com>

<http://www.luxmanual.com>

<http://aubethermostatmanual.com>

Golf course search by state

<http://golfingnear.com>

Email search by domain

<http://emailbydomain.com>

Auto manuals search

<http://auto.somanuals.com>

TV manuals search

<http://tv.somanuals.com>