

# ViewSonic®

**VPC101**  
**All-in-One PC**

- User Guide
- Guide de l'utilisateur
- Guía del usuario
- Οδηγός χρηστών
- 使用手冊 (繁體)
- 使用手冊 (简体)



**ViewSonic®**

**Model No. : VS12602**

# Compliance Information

## For U.S.A.

This device complies with part 15 of FCC Rules. Operation is subject to the following two conditions: (1) this device may not cause harmful interference, and (2) this device must accept any interference received, including interference that may cause undesired operation.

This equipment has been tested and found to comply with the limits for a Class B digital device, pursuant to part 15 of the FCC Rules. These limits are designed to provide reasonable protection against harmful interference in a residential installation. This equipment generates, uses, and can radiate radio frequency energy, and if not installed and used in accordance with the instructions, may cause harmful interference to radio communications. However, there is no guarantee that interference will not occur in a particular installation. If this equipment does cause harmful interference to radio or television reception, which can be determined by turning the equipment off and on, the user is encouraged to try to correct the interference by one or more of the following measures:

- Reorient or relocate the receiving antenna.
- Increase the separation between the equipment and receiver.
- Connect the equipment into an outlet on a circuit different from that to which the receiver is connected.
- Consult the dealer or an experienced radio/TV technician for help.

**Warning:** You are cautioned that changes or modifications not expressly approved by the party responsible for compliance could void your authority to operate the equipment.

## For Canada

This Class B digital apparatus complies with Canadian ICES-003.  
Cet appareil numérique de la classe B est conforme à la norme NMB-003 du Canada.

## CE Conformity for European Countries



The device complies with the EMC Directive 2004/108/EC and Low Voltage Directive 2006/95/EC.

### Following information is only for EU-member states:

The mark shown to the right is in compliance with the Waste Electrical and Electronic Equipment Directive 2002/96/EC (WEEE).

The mark indicates the requirement NOT to dispose the equipment as unsorted municipal waste, but use the return and collection systems according to local law.

If the batteries, accumulators and button cells included with this equipment, display the chemical symbol Hg, Cd, or Pb, then it means that the battery has a heavy metal content of more than 0.0005% Mercury or more than, 0.002% Cadmium, or more than 0.004% Lead.



## **FCC Radiation Exposure Statement**

This equipment should be installed and operated with minimum distance 20cm between the radiator & your body.

This wireless module device complies with part 15 of FCC Rules. Operation is subject to the following two conditions: (1) this device may not cause harmful interference, and (2) this device must accept any interference received, including interference that may cause undesired operation.

## **Industry Canada Notice**

This wireless module device complies with Canadian RSS-210. To prevent radio interference to the licensed service, this device is intended to be operated indoors and away from windows to provide maximum shielding. Equipment (or its transmitting antenna) that is installed outdoors is subject to licensing. The installer of this radio equipment must ensure that the antenna is located or pointed such that it does not emit RF field in excess of Health Canada limits for the general population; consult Safety Code 6, obtainable from Health Canada's web site [www.hc-sc.gc.ca/rpb](http://www.hc-sc.gc.ca/rpb).

## **R&TTE Compliance Statement**

This wireless module device complies with the Essential Requirements of the R&TTE Directive of the European Union (1999/5/EC). This equipment meets the following conformance standards:

ETSI EN 300 328V1.7.1 (2006)  
EN 301 489-01 V1.6.1 (2005)  
EN 301 489-17 V1.2.1 (2002)  
EN 62311 (2008)

**Notified Countries:** Germany, UK, Netherlands, Belgium, Sweden, Denmark, Finland, France, Italy, Spain, Austria, Ireland, Portugal, Greece, Luxembourg, Estonia, Latvia, Lithuania, Czech Republic, Slovakia, Slovenia, Hungary, Poland and Malta.

# Important Safety Instructions

1. Read these instructions completely before using the equipment.
2. Keep these instructions in a safe place.
3. Heed all warnings.
4. Follow all instructions.
5. Do not use this equipment near water. Warning: To reduce the risk of fire or electric shock, do not expose this apparatus to rain or moisture.
6. Clean with a soft, dry cloth. If further cleaning is required, see “Cleaning the Display” in this guide for further instructions.
7. Do not block any ventilation openings. Install the equipment in accordance with the manufacturer’s instructions.
8. Do not install near any heat sources such as radiators, heat registers, stoves, or other devices (including amplifiers) that produce heat.
9. Do not attempt to circumvent the safety provisions of the polarized or grounding-type plug. A polarized plug has two blades with one wider than the other. A grounding type plug has two blades and a third grounding prong. The wide blade and the third prong are provided for your safety. If the plug does not fit into your outlet, consult an electrician for replacement of the outlet.
10. Protect the power cord from being tread upon or pinched, particularly at the plug, and the point where it emerges from the equipment. Be sure that the power outlet is located near the equipment so that it is easily accessible.
11. Only use attachments/accessories specified by the manufacturer.
12. Use only with the cart, stand, tripod, bracket, or table specified by the manufacturer, or sold with the equipment. When a cart is used, use caution when moving the cart/equipment combination to avoid injury from tipping over.
13. Unplug this equipment when it will be unused for long periods of time.
14. Refer all servicing to qualified service personnel. Service is required when the unit has been damaged in any way, such as: if the power-supply cord or plug is damaged, if liquid is spilled onto or objects fall into the unit, if the unit is exposed to rain or moisture, or if the unit does not operate normally or has been dropped.



# Declaration of RoHS Compliance

This product has been designed and manufactured in compliance with Directive 2002/95/EC of the European Parliament and the Council on restriction of the use of certain hazardous substances in electrical and electronic equipment (RoHS Directive) and is deemed to comply with the maximum concentration values issued by the European Technical Adaptation Committee (TAC) as shown below:

Substance	Proposed Maximum Concentration	Actual Concentration
Lead (Pb)	0.1%	< 0.1%
Mercury (Hg)	0.1%	< 0.1%
Cadmium (Cd)	0.01%	< 0.01%
Hexavalent Chromium (Cr <sup>6+</sup> )	0.1%	< 0.1%
Polybrominated biphenyls (PBB)	0.1%	< 0.1%
Polybrominated diphenyl ethers (PBDE)	0.1%	< 0.1%

Certain components of products as stated above are exempted under the Annex of the RoHS Directives as noted below:

Examples of exempted components are:

1. Mercury in compact fluorescent lamps not exceeding 5 mg per lamp and in other lamps not specifically mentioned in the Annex of RoHS Directive.
2. Lead in glass of cathode ray tubes, electronic components, fluorescent tubes, and electronic ceramic parts (e.g. piezoelectronic devices).
3. Lead in high temperature type solders (i.e. lead-based alloys containing 85% by weight or more lead).
4. Lead as an alloying element in steel containing up to 0.35% lead by weight, aluminium containing up to 0.4% lead by weight and as a copper alloy containing up to 4% lead by weight.

## Copyright Information

Copyright © ViewSonic® Corporation, 2011. All rights reserved.

Microsoft®, Windows®, Windows NT®, and the Windows® logo are registered trademarks of Microsoft® Corporation in the United States and other countries.

ViewSonic®, the three birds logo, OnView, ViewMatch, and ViewMeter are registered trademarks of ViewSonic® Corporation.

Intel®, Pentium®, and Atom™ are registered trademarks of Intel Corporation.

AMD®, Athlon™, Athlon™ XP, Thoroughbred™ and Duron™ are registered trademarks of AMD® Corporation.

NVIDIA®, the NVIDIA logo, DualNet and nForce are registered trademarks or trademarks of NVIDIA Corporation in the United States and/ or other countries.

PS/2® and OS/2® are registered trademarks of International Business Machines Corporation.

Netware® is a registered trademark of Novell, Inc.

Award® is a registered trademark of Phoenix Technologies Ltd.

AMI® is a registered trademark of American Megatrends Inc.

Disclaimer: ViewSonic® Corporation shall not be liable for technical or editorial errors or omissions contained herein; nor for incidental or consequential damages resulting from furnishing this material, or the performance or use of this product.

In the interest of continuing product improvement, ViewSonic® Corporation reserves the right to change product specifications without notice. Information in this document may change without notice.

No part of this document may be copied, reproduced, or transmitted by any means, for any purpose without prior written permission from ViewSonic® Corporation.

## U.S. Patent Numbers

This item incorporates copy protection technology that is protected by U.S. patents and other intellectual property rights of Rovi Corporation. Reverse engineering and disassembly are prohibited.

## Product Registration

To meet your future needs, and to receive any additional product information as it becomes available, please register your product on the Internet at: **www.viewsonic.com**. The ViewSonic Wizard CD-ROM also provides an opportunity for you to print the registration form, which you may mail or fax to ViewSonic.

### For Your Records

Product Name:	VPC101 ViewSonic All-in-One PC
Model Number:	VS12602
Document Number:	VPC101-1_UG_ENG Rev. 1C 12-15-10
Serial Number:	_____
Purchase Date:	_____

### Product disposal at end of product life

The lamp in this product contains mercury which can be dangerous to you and the environment. Please use care and dispose of in accordance with local, state or federal laws.

ViewSonic respects the environment and is committed to working and living green. Thank you for being part of Smarter, Greener Computing. Please visit ViewSonic website to learn more.

USA & Canada: <http://www.viewsonic.com/company/green/recycle-program/>

Europe: <http://www.viewsoniceurope.com/uk/support/recycling-information/>

Taiwan: <http://recycle.epa.gov.tw/recycle/index2.aspx>

---

## Table of contents

<b>Overview of your documentation.....</b>	<b>4</b>
Document type.....	4
Printed documentation.....	4
Non-printed documentation .....	4
Servicing.....	4
Typographics .....	4
<b>Package contents .....</b>	<b>5</b>
Standard items.....	5
<b>Getting to know the PC.....</b>	<b>6</b>
Touring the PC .....	6
Front view.....	6
Rear view .....	7
Right-side view .....	9
Left-side view .....	10
Wired keyboard and mouse.....	10
Special keyboard buttons (front view) .....	10
Overview of the wired mouse (front view) .....	12
Indicator lights.....	12
<b>Setting up the PC.....</b>	<b>13</b>
Preparing to setup your PC .....	13
Connecting the power.....	14
Connecting the wired keyboard and mouse .....	15
Customizing the mouse settings .....	15
Turning on the PC.....	16
Turning off the PC.....	16
Configuring the display .....	17
Brightness control.....	17
<b>Using the PC .....</b>	<b>18</b>
Connecting to the Internet .....	18
Connecting to a wired network .....	18



Connecting to a wireless network (for select models) .....	19
Using the webcam .....	20
Using the optical disc drive .....	21
Inserting a disc .....	21
Reading a disc.....	23
Writing to a disc .....	23
Removing a disc.....	23
Using memory cards.....	24
Using the touch screen (for select models) .....	26
Selecting items with your touch screen .....	26
<b>Using the Peripheral Devices .....</b>	<b>27</b>
Connecting USB devices .....	27
Removing USB devices .....	28
<b>Cleaning and care.....</b>	<b>29</b>
Screen and computer .....	29
Cleaning the screen and computer .....	29
Storing your computer .....	30
CDs and DVDs (ViewSonic Wizard CD and System Recovery and Driver Disk) .....	30
Cleaning the discs .....	30
Keyboard and mouse.....	31
Cleaning your keyboard and mouse.....	31
<b>BIOS Setup Utility .....</b>	<b>32</b>
When to Use the BIOS Setup Utility .....	32
Standard CMOS Features menu .....	34
Advanced BIOS Features menu.....	34
Load Optimized Defaults menu .....	35
Set Password menu .....	36
Save & Exit Setup menu .....	36
Exit Without Saving menu .....	36
<b>System Recovery.....</b>	<b>37</b>
When to Use System Recovery.....	37

---

Running ViewSonic® Recovery Manager.....	37
Running Recovery Disc Creation Tool.....	40
Using the recovery DVD .....	43
<b>Troubleshooting .....</b>	<b>45</b>
Frequently asked questions (FAQ) .....	45
Power problems .....	45
Internet access problems .....	46
Optical discs problems .....	47
Display problems.....	48
Keyboard and mouse problems .....	49
Sound and microphone problems .....	50
Miscellaneous problems.....	51
<b>Specifications .....</b>	<b>52</b>
<b>Other information .....</b>	<b>54</b>
Customer Support.....	54
Limited Warranty.....	55

---

# Overview of your documentation

---

## Document type

Your documentation contains printed information and PDF user manuals to help you perform various tasks.

### Printed documentation

- **Quick Start Guide** provides information about setting up your computer.

### Non-printed documentation



- **ViewSonic Wizard CD** (containing this manual) provides information about using your computer, cleaning and maintaining the monitor and the accessories, and the common solutions to the problems you may encounter while using your computer.
- **System Recovery and Driver Disk** provides information about restoring your computer system to factory settings.

## Servicing

Do not attempt to service this product yourself, as opening or removing covers may expose you to the risk of electric shock and other hazards. If any of the above mentioned misuse or other accident such as dropping or mishandling occurs, contact qualified service personnel for servicing.

## Typographics

Special tips, notes, and cautions that appear throughout this manual are designed to ensure that you perform specific tasks properly, preventing unnecessary errors.

	<b>CAUTION:</b> Indicates important information to prevent potential damage to the unit and data, or personal injury caused by improper use.
	<b>NOTE:</b> Indicates additional information for particular situation.
	<b>TIP:</b> Indicates useful information for completing a task.







# Package contents

When unpacking please check you have the following items. If any are missing or damaged, please contact the place of purchase for a replacement. Retain the box and packaging in case you need to transport your personal computer in the future. The fitted foam packing is ideal for protecting the device during transport.

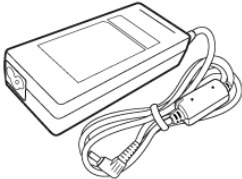

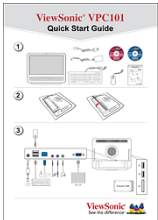
**The appearance and contents of your package may be different from those illustrated below due to regional variations.**

## Standard items

		
All-in-One PC	power adapter	power cord
		
Quick Start Guide	ViewSonic Wizard CD	System Recovery and Driver Disk
		
mouse	keyboard	

# Getting to know the PC

## Touring the PC





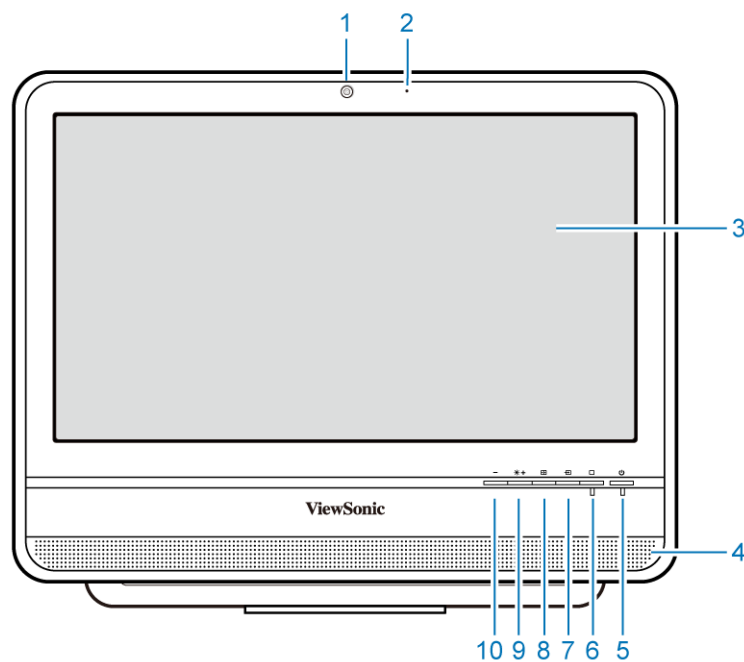

This section describes the views and the features of the controls, ports, buttons, components, and connectors of your computer.

### Front view

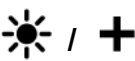

No.	Item	Description
1	<b>Webcam</b>	The built-in camera allows you to capture still images, record videos, and have video chats.
2	<b>Built-in microphone</b>	The built-in microphone receives sounds and voices when used with the built-in webcam.
3	<b>Touch-enabled widescreen (for select models)</b>	The monitor is equipped with touch screen. You may make adjustments to your work field at your fingertips. The touch screen will responsively react with your fingertip commands.
4	<b>Speakers</b>	The internal speakers deliver high-quality audio while listening to music or watching your home videos and DVD discs.

# Getting to know the PC





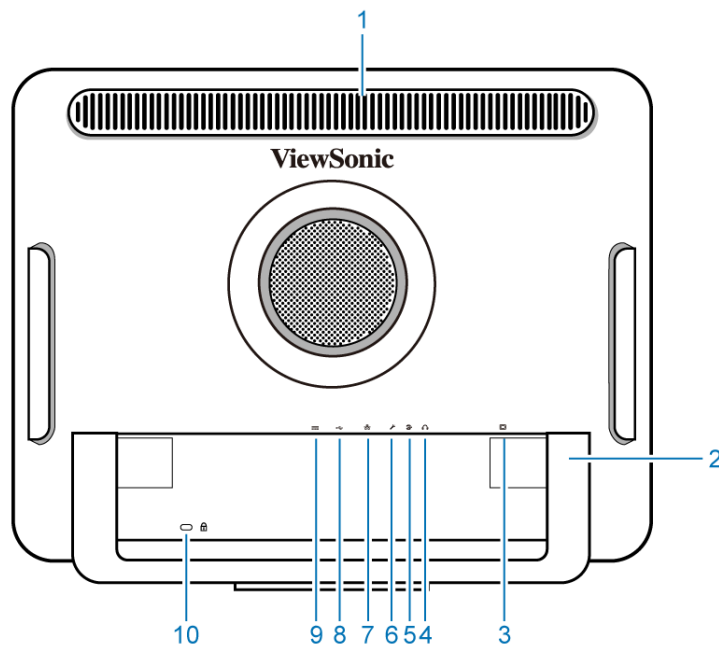



5		Power. Press to turn on your computer.
6		LCD display switch. Press to turn on or turn off the display. When the system is on, pressing the LCD display control will turn off the display and the built-in speakers.   <b>When the system is on, pressing the LCD display control will turn off the display and the built-in speakers.</b>
7		Input signal switch. Press to select the input signal that may have connected to your computer.
8		Auto-adjust. Press to automatically optimizes and adjusts the screen while displaying video source from the D-sub input jack.
9		Brightness/Increase. Hotkey for LCD <b>Brightness</b> control / Press to make increase adjustment.
10		Decrease. Press to make decrease <b>Brightness</b> adjustment.

## Rear view



No.	Item	Description
1	<b>Vents</b>	The design of the vents is to prevent the computer from overheating. The internal fans blow hot air away from heat-sensitive components in the computer.

## Getting to know the PC

	<b>Keep the vents clean and free of dirt and dust, as blocking it may cause serious thermal problems.</b>	
2	<b>Computer stand</b>	You can adjust the back computer stand to enable it to stand upright.
3		15-pin D-Sub input jack. Use a 15-pin D-Sub cable to connect other devices with D-Sub output port, such as notebooks, or game consoles, etc.
4		Audio/Headphone output jack. Connect your headphones or speakers to this jack to listen to the sound from your PC when watching videos and DVDs, listening to music, and playing games.
5		Audio input jack. Connect to an audio in jack on external audio equipment for audio sound.
6		Microphone input jack. Connect your microphone to this jack to record sound or voice.
7		LAN (Local Area Network) port. Use an Ethernet (RJ45) cable to connect your computer with a network or broadband device.
8		USB ports. Insert the USB plugs into the USB ports to connect your USB devices, such as MP3 players, digital cameras, keyboard and mouse, or external hard disk drives, etc.
9		DC IN port. Connect the power cord to this port to power the computer.
10		Security lock slot. We recommend you to attach a security lock (sold separately) and cable (sold separately) to the slot to help prevent possible theft.

## Right-side view

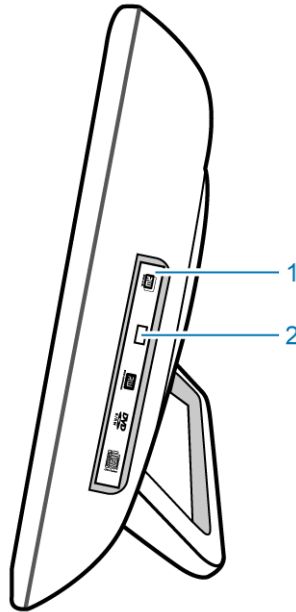

No.	Item	Description
1	<b>CD/DVD drive</b>	<p>Press the <b>Eject</b> button and insert a CD/DVD into this drive to play your CD's collections, DVD movies, or access the data burned onto the discs.</p> <p>To record a CD or DVD, press the <b>Eject</b> button to insert a recordable CD or DVD into this drive and burn the data with CD/DVD recording applications installed on your system.</p>
2	<b>Eject button</b>	Press to open the disc tray.



## Left-side view

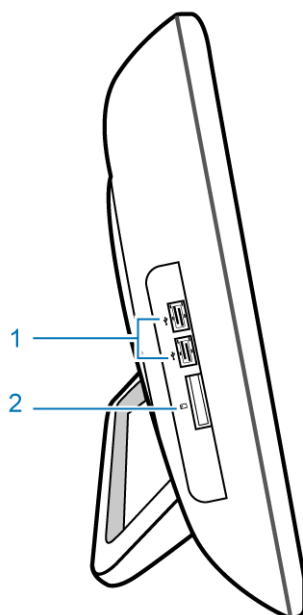

No.	Item	Description
1	<b>USB ports</b>	Connect the USB plugs into the USB ports to connect your USB devices, such as MP3 players, digital cameras, keyboard and mouse, or external hard disk drives, etc.
2	<b>Media card reader</b>	Insert your memory card into this media card reader to access photos, audio and video files, or other data stored in the memory cards. This reader supports the following card types: <ul style="list-style-type: none"><li>• Secure Digital (SD)</li><li>• MultiMedia Card (MMC)</li><li>• Memory Stick (MS)</li><li>• Memory Stick Pro (MS Pro)</li></ul>

## Wired keyboard and mouse

This section describes some information about the wired keyboard and mouse.

### Special keyboard buttons (front view)



**The appearance of the keyboard may vary by region.**

1. **<Caps Lock>**: Press to toggle between uppercase and lowercase text as you type.
2. **<Insert>** key: Press to switch between character insert mode.

# Getting to know the PC

3. **Mute** key: Press to mute the volume.
4. **Volume down** key: Press to decrease the volume level.
5. **Volume up** key: Press to increase the volume level.
6. **Numeric keypad**: Use the numeric keypad to enter numbers and do calculations. Pressing <Num Lock> will activate or inactivate the numeric keypad.
7. **Cursor control keys** (left, right, up, down): Use these directional keys to move the mouse pointer to the desired location.
8. **<Application>** key: Press to open up the context menu which appears when you right-click the mouse.

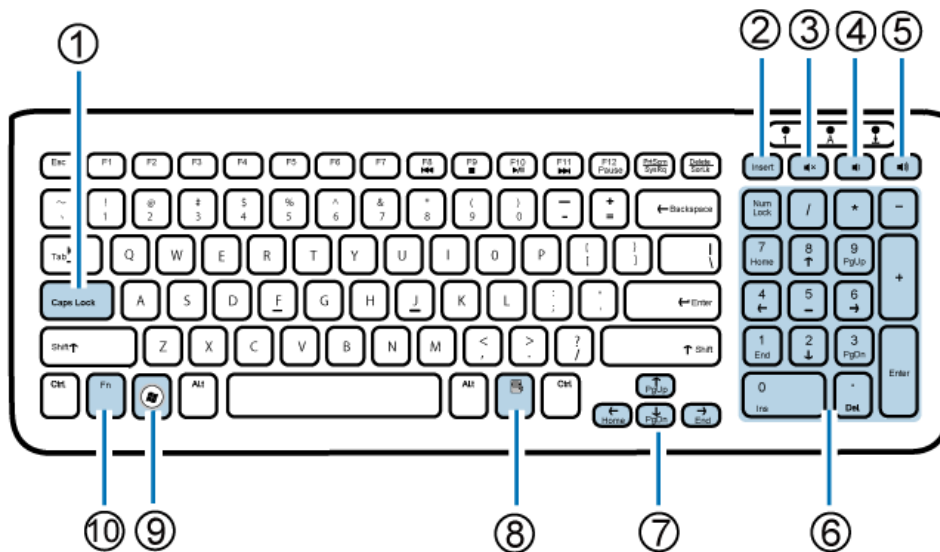

9. **<Windows>** key: Press to activate the **Start** menu.
  10. **<Fn>** (Function) key: Press to perform specific tasks.
- You can use the function hotkeys to quickly launch your favorite programs, files, and websites. To use the hotkeys, press and hold the <Fn> key, and then press the desired hotkey.

Function key	Performed task
<Fn> + <F8> (⏮)	Press to skip to the previous audio track or movie chapter.
<Fn> + <F9> (■)	Press to stop the playback.
<Fn> + <F10> (▶/  )	Press to start or pause the playback.
<Fn> + <F11> (⏭)	Press to play the next audio track or movie chapter.
<Fn> + <F12> (Pause)	When the system starts up, press to halt the startup process.



**To adjust keyboard functionality, click "Start" at the bottom left corner of your screen, select "Control Panel" to open the "Adjusting your computer's settings" window, then select "Keyboard", and make adjustments in the opened "Keyboard Properties" dialog box according to your preference.**

## Overview of the wired mouse (front view)

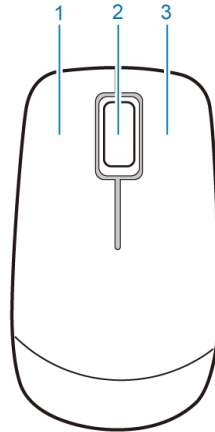

1. Left button: single-click or double-click to select items. To drag and drop items, click on the items and hold the left button, then drag them to the desired destination before releasing the button.
2. Central wheel: Rotate the wheel to scroll up and down a page.
3. Right button: Single-click to open a menu of the selected item.

## Indicator lights

The table below describes the status that LED indicators present.

	LED	Activities
1	<b>Power</b>	<ul style="list-style-type: none"><li>• When the computer is on, the LED indicator lights up in blue.</li><li>• When the computer is off, the LED indicator goes off.</li></ul>
2	<b>LCD display power</b>	<ul style="list-style-type: none"><li>• When the monitor is on, the LED indicator lights up in green.</li></ul>
3	<b>CD/DVD drive activity</b>	<ul style="list-style-type: none"><li>• When the CD/DVD drive is in use, the LED indicator flashes green.</li><li>• When the CD/DVD drive is not in use, the LED indicator goes off.</li></ul>

---

# Setting up the PC

---

This section describes how to set up your computer and make adjustments to the monitor.

## Preparing to setup your PC

Before attempting to set up your computer, to protect the computer and monitor, you should:

- find a flat open area on your desk to position your computer
- place a soft item like the computer packaging bag on the desk for padding



**It is suggested to install your computer in a space that allows for airflow as restricting the airflow may cause overheating which could impact the performance of your computer.**

---

1. Gently lay the screen face down on a flat clean padded surface.

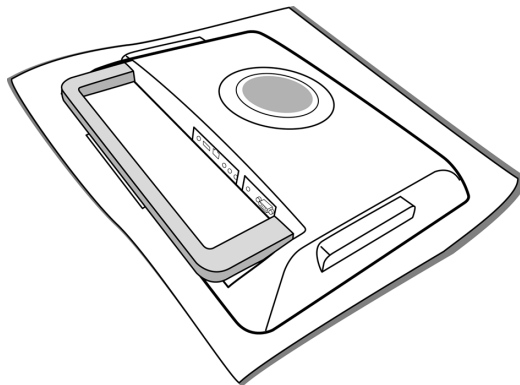

2. Pull up the computer stand until it is at the maximum height.

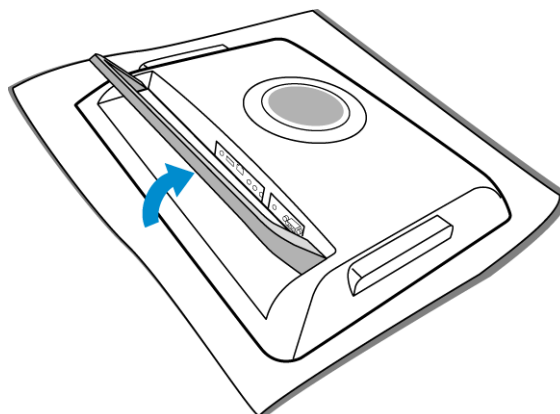

**Please ensure the computer stand has been pulled up to its fully extended position, so that your computer may stand firm and upright.**

---

# Setting up the PC

- Carefully lift the computer and adjust the angle of the screen.

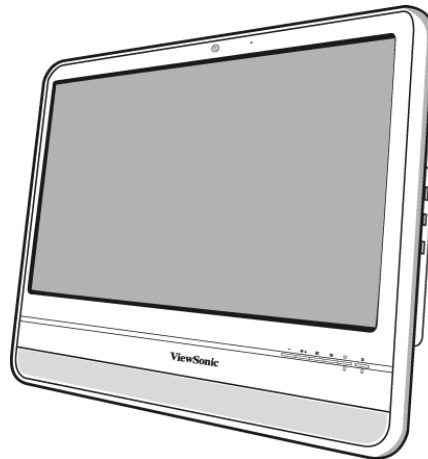

You may push the computer stand inwards to avoid unwanted reflections from other light sources.



**To prevent the computer from falling over at too small angles, stop pushing the computer stand when it reaches the detent stop (approximately 10° apart from the rear of the computer).**

Now you are ready to access some ports on the rear panel of the computer to make cable connections.

## Connecting the power



**The illustrations may differ from product supplied for your region.**

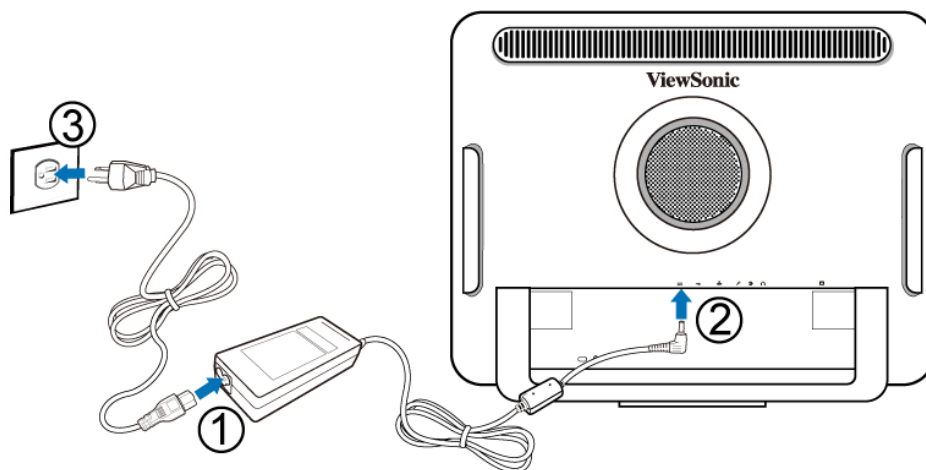

- Connect the power cable to the supplied power adapter.
- Connect the power plug to the power jack on the rear panel of the monitor.

3. Connect the power adapter to a nearby power outlet.



**Do not plug in or turn on the power to the computer until instructed to do so.**

## Connecting the wired keyboard and mouse

The complete computer installation includes the setup of the keyboard and mouse. Follow the procedures below to set up your keyboard and mouse.

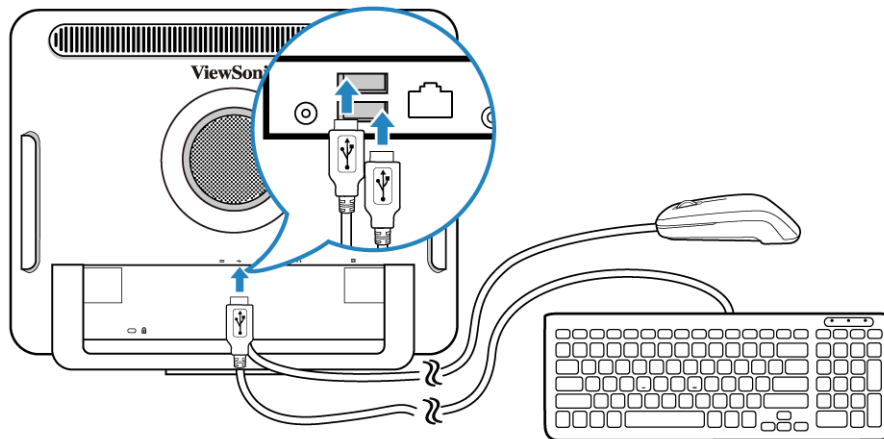

1. Connect the USB cable on the keyboard to a USB port on the rear panel of the computer.
2. Connect the USB cable on the mouse to the other USB port on the rear panel of the computer.

- **It is recommended that you use the USB ports on the rear panel for devices that usually remain connected, such as keyboards and mouse.**



- **For information about using the keyboard shortcut keys and mouse, see [Special keyboard buttons \(front view\)](#) and [Overview of the wired mouse \(front view\)](#).**

## Customizing the mouse settings

You may configure the mouse settings to meet your personal preferences. To modify the mouse settings, follow the procedures below.

1. Click the **Start** menu at the bottom left corner of your screen.
2. Select **Control Panel** to open the **Adjusting your computer's settings** window.
3. Select **Mouse** to open the **Mouse Properties** dialog box.
4. Make adjustments according to your preference.

## Turning on the PC

After you finish the installation of your computer, press the **Power** button on the front panel of the computer to turn it on. Then follow the on-screen instructions to complete the initial setup.

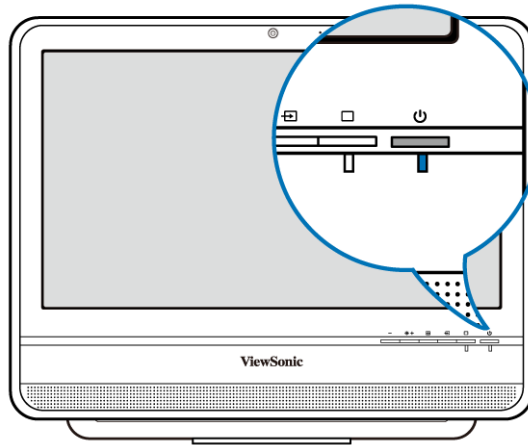

## Turning off the PC

To turn off the system, close all the active windows, and then click the **Start** menu at the bottom left corner of your screen, and then click **Shut Down** on the right side of the open tab.

Alternatively, after closing all the active windows, you may press the **Power** button on the front panel of the computer to turn off the system.

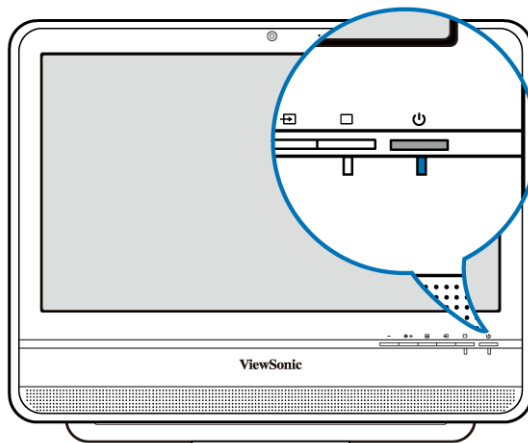

## Configuring the display

You may press the **Auto-adjust** button to automatically optimize and adjust the screen settings while displaying video source from the D-sub input jack.

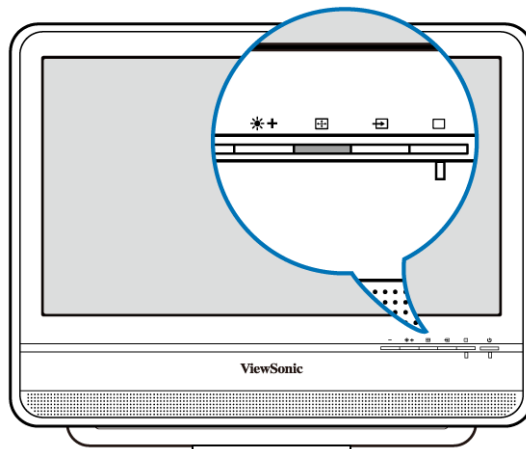

## Brightness control

To adjust the brightness level of the monitor, press the **Brightness/Increase** button to display the **Brightness** indicator, and then press the same button to increase the level or press the **Decrease** button to decrease the level.

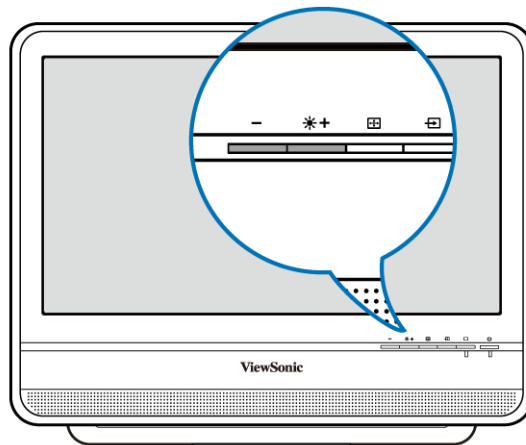



---

# Using the PC

---

This section describes more tasks your computer can perform, including connecting to the Internet, using the Webcam to communicate with your family and friends, enjoying your digital entertainment from CD and DVD, reading and writing to your memory cards, and taking control of your computer via the touchscreen technology.

## Connecting to the Internet

With the access to the Internet you can browse the Web, send e-mail or exchange instant messages with friends and family.

Before attempting to build the Internet connectivity with either a wired or wireless local area network, you need to purchase high-speed Internet service from an Internet service provider (ISP). Your ISP will offer various Internet connection options, and assist you in setting up the Internet access through them.

To set up your computer to access the Internet connection, the following items are needed:

- Broadband modem (DSL or cable) purchased from your Internet service provider (ISP).
- An Ethernet cable (sold separately)
  - to connect your computer and the broadband modem, or
  - to connect the broadband modem and a wireless router or access point which serves as an access point station to make transmission possible. (for a wireless network)
- For a wireless network connection, a wireless LAN (Local Area Network) card for your computer to connect with the router or access point. (sold separately; a built-in wireless LAN card is supplied with select models only.)



**For details about installing the wireless LAN card, router, or access point, please refer to the manuals that shipped with the product you purchased or contact that manufacturer.**

---

## Connecting to a wired network

1. Ensure the local area network is properly set up.
  - You have purchased the Internet service from an ISP.
  - You have set up the broadband modem (DSL or cable).
2. Connect the computer LAN port to the modem with an Ethernet cable.

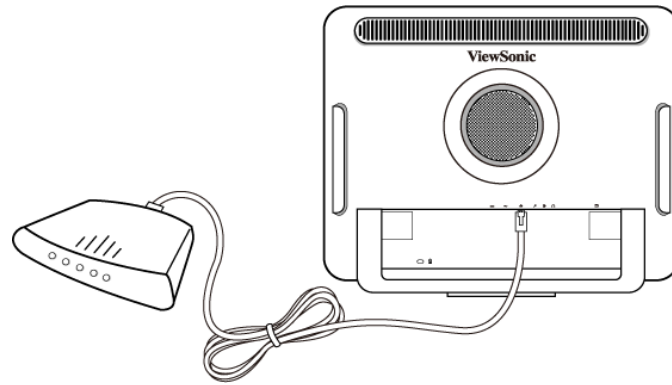



3. Open the Web browser and access any Web site to test the network connection.

## Connecting to a wireless network (for select models)

Wireless LAN (WLAN) connectivity has limited range, depending upon the equipment being used, the chosen frequency band, radiowave interference, and the physical landscape, including building structure. Circumstances will vary depending upon your particular situation.

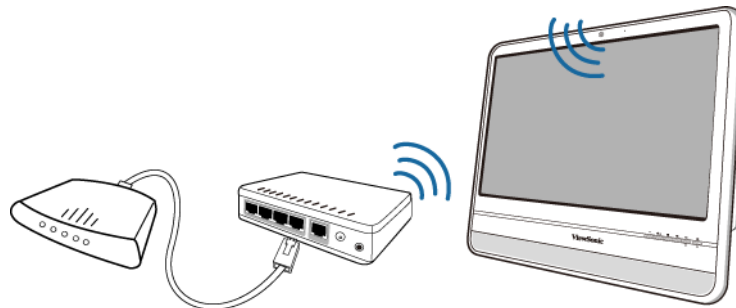
1. Make sure you
  - are located within the wireless network service area.
  - have purchased the Internet service from an ISP.
  - have inserted the wireless LAN card to the computer and installed its drivers.
  - have set up the broadband modem (DSL or cable).
  - have connected the modem to the wireless router or access point with an Ethernet cable.



2. Click the **Wireless Network** icon in the system tray, , to open a list of available wireless networks.
3. Choose a network you intend to join from the list.

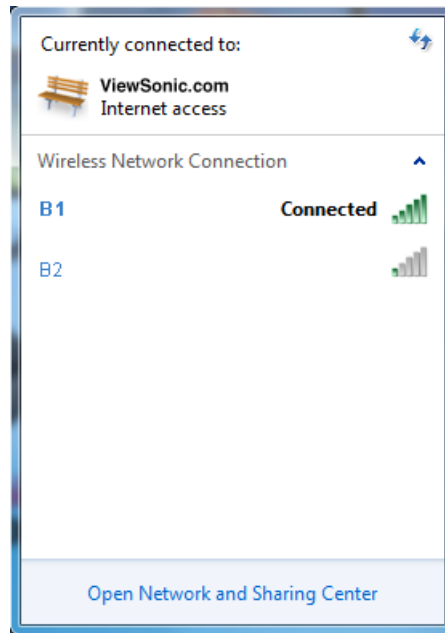

**If the selected network requires security authentication, please enter user name and password.**

4. If you are able to successfully connect to a wireless network, you will receive a message indicating that the connection has been established.
5. Open the Web browser and access any Web site to test the network connection.



**To disable WLAN manually, click "Disconnect" from the Wireless Network Connection list.**

## Using the webcam

Your computer comes with a built-in 1.3 megapixel webcam at the top center of the bezel. With this webcam, you can capture still images or record videos via the preinstalled image capture software, or you can chat online in real time via instant message programs.



**Check the ambient light conditions around the webcam to avoid getting images that appear too dark or too light.**

## Using the optical disc drive

Your computer comes with an optical disc drive, which supports music CDs, video CDs and DVD. You can also use it to burn CD-R/CD-RW or DVD+R/DVD-R/DVD+RW/DVD-RW/DVD-RAM discs.

The following tables show which formats are supported by the optical disc drive.

### CD-writable drives

Media Type	Read	Write	Rewritable
CD-R	Yes	Yes	Yes
CD-RW	Yes	Yes	Yes

### DVD-Writable drives

Media Type	Read	Write	Rewritable
CD-R	Yes	Yes	Yes
CD-RW	Yes	Yes	Yes
DVD+R	Yes	Yes	Yes
DVD-R	Yes	Yes	Yes
DVD+RW	Yes	Yes	Yes
DVD+R DL	Yes	Yes	Yes
DVD-R DL	Yes	Yes	Yes

## Inserting a disc



**When the optical disc drive is in use, the indicator lights up and flashes. When the indicator light is flashing, do not move the computer.**

1. Press the **Eject** button on the drive, as shown below.

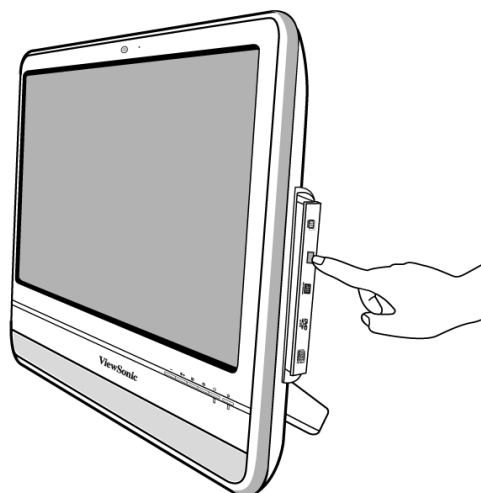

2. Gently pull out the disc tray.

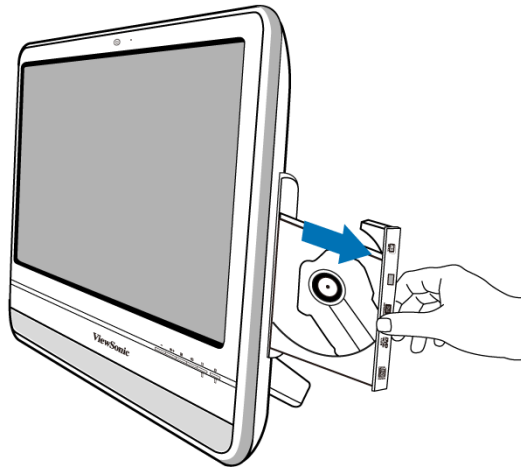

3. With the label side facing forward, place the disc in the center of the disc tray.

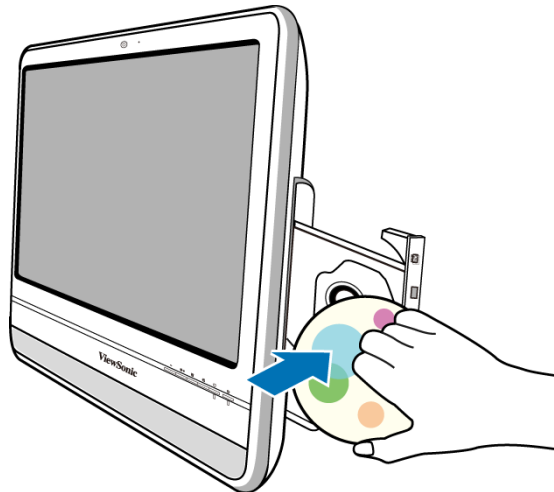

4. Gently push the disc tray back into the disk slot.
5. The optical disc drive indicator is on and your computer will start to read the disc you just inserted.

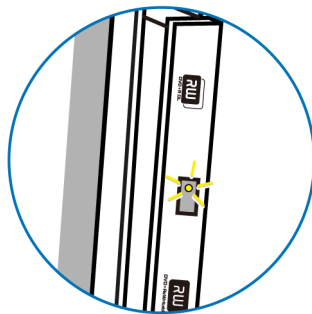

## Reading a disc

1. Follow the steps in the “**Inserting a disc**” section.
2. When prompted, choose the desired program to play the inserted disc.



**If no window appears on the desktop, click “Start”, select “All Programs”, and then select the desired software to play the inserted disc. For more instructions about the selected software, please see its manual or online help.**

## Writing to a disc



**Ensure that the discs you create do not violate copyright laws.**

1. Follow the steps in the “**Inserting a disc**” section.
2. When prompted, choose the desired program to record files to the inserted rewritable disc.



**If no window appears on the desktop, click “Start”, select “All Programs”, and then select the desired disc copying software to create your disc. For more instructions about the selected software, please see its manual or online help.**

3. Follow the on-screen instructions to complete burning process.

## Removing a disc

1. Ensure the optical disc driver indicator is off.
2. Press the **Eject** button on the drive.

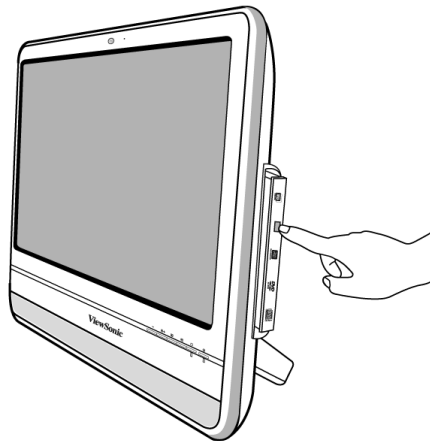

3. Pull out the disc tray and remove the disc.

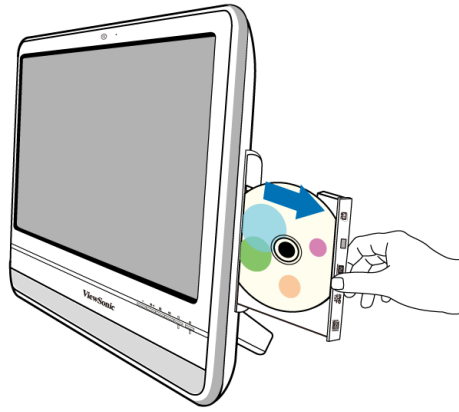

**Alternatively, you may click "Start", select "Computer" to open the Computer window, then right-click the disc drive icon, and select "Eject" from the menu.**



**If the disc tray doesn't open, please restart your system and repeat the above procedures.**

4. Gently push the disc tray back into the disk slot.

## Using memory cards

Your computer comes with a 4-in-1 media card reader which allows you to exchange and share your data stored on your memory cards with other devices, such as your mobile phones and digital cameras.

The media card reader supports the following memory card types:

- Secure Digital (SD)
- MultiMedia Card (MMC)
- Memory Stick (MS)
- Memory Stick Pro (MS Pro)

To use the media card reader, follow the direction arrow on your memory card to insert it into the slot until it clicks into place. Insert the card with the metallic connectors facing towards you.

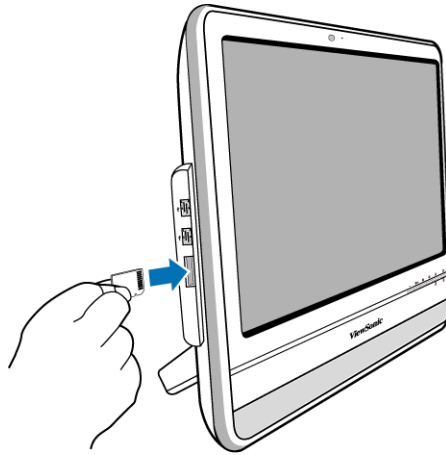

Your system will automatically detect the inserted memory card and then display the content of the memory card.



**If no window appears on the desktop, click "Start", select "Computer" to open the Computer window, then double-click the memory card icon to access the data stored on the memory card. If the Computer window does not show any memory card icon, check if the memory card is inserted in the correct direction.**

To remove a memory card, click **Start**, select **Computer** to open the **Computer** window, and right-click the memory card icon, then select **Eject** from the menu, and do not to remove the memory card until you have saved any changes.

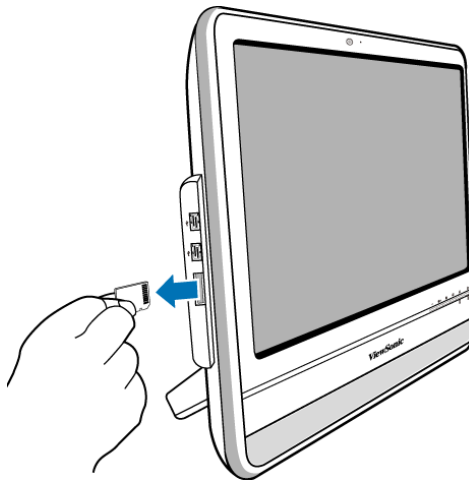

**Never remove the memory card or turn off the computer while the media card reader is still reading or writing files from the card, or you may lose data.**



**Always remove the inserted memory card from the media card reader before you turn off the computer.**



## Using the touch screen (for select models)

Your computer is equipped with a touch screen which has a high sensitivity level. You can control your PC with the touch of your finger or by using a stylus pen. Your fingertips and stylus pen work as the hand-held mouse pointer. When you control the computer with your fingertips on the screen, the hand-held mouse can work concurrently.

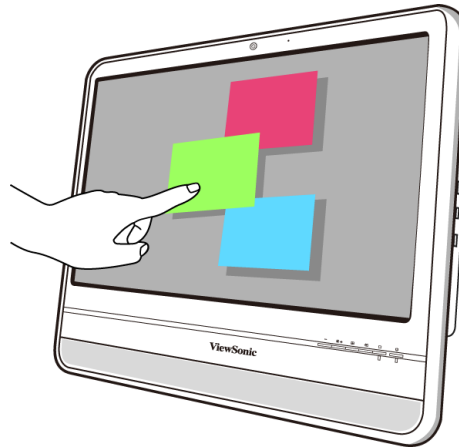

---

**When you press LCD display switch button to turn off the LCD monitor, the touch screen is still active. To avoid accidental or unintentional activation and inactivation of the functions or programs while the monitor is turned off, do not touch on the screen surface while the system is still running.**

---



---

**Do not apply pressure on the front of the display or around the screen borders to avoid damaging the touch screen. For more details about maintaining and cleaning the LCD screen, please see Cleaning the screen and computer.**

---

## Selecting items with your touch screen

The first time you use the touch screen, you have to execute the calibration software first.

Use the touch screen as follows:

- Tap once for a single mouse click.
- Tap twice for a double mouse click
- Press and hold an item to open the item's menu, then move your finger to the appropriate menu item. When you remove your finger, the item is selected.

---

# Using the Peripheral Devices

---

## Connecting USB devices

Your computer comes with 4 USB ports; two on the side panel and the other on the rear panel. To expand the functionality of your computer, you may connect your USB peripherals, such as digital still camera, digital video camera, printer, floppy disk drive. etc., to the USB ports of your computer.

To connect USB peripherals to the USB port, please follow the procedures below.

1. Choose a USB port you wish to use.

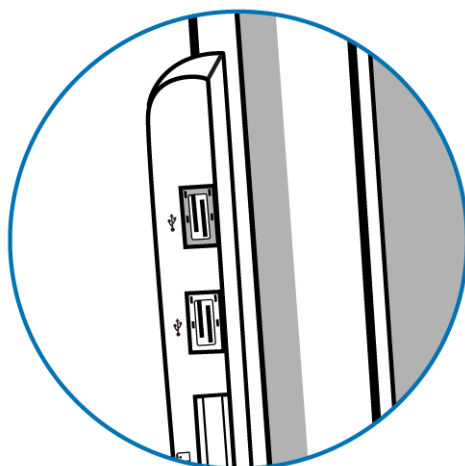

**It is recommended that you use the USB ports on the rear panel for devices that usually remain connected, such as your keyboard and mouse.**

---

2. If your USB device hasn't been connected with the USB cable, connect one end of the USB cable into the USB port on your device.
3. Connect the other end of the USB cable into the computer's USB port.



**The following USB device illustration is for reference only.**

---

# Using the Peripheral Devices

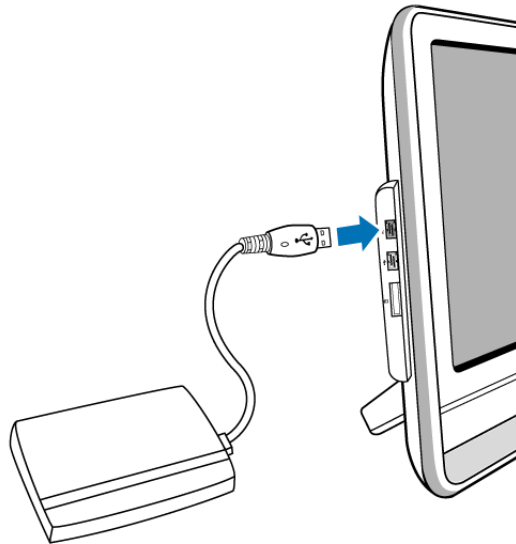

**There is only one direction to make the connection. Incorrect direction will cause damage to the USB device.**

4. Your system will automatically detect the connected USB device. You may review the contents of the device in the Windows Explorer.

## Removing USB devices

To avoid data or equipment damage while removing the USB devices from the computer, please always follow the procedures below.

1. Ensure all files or programs accessing the connected USB devices are closed.
2. Click the **Safely Remove Hardware and Eject Media** icon in the system tray.
3. Choose **Eject USB Flash Drive** from the opened menu.
4. A message appears in the system tray to notify that it is now safe to remove the hardware device.
5. Gently remove the USB device from the USB port on the computer.

---

# Cleaning and care

---

Your computer, keyboard, and mouse need occasional cleaning to prolong their life. Please read this section carefully to ensure proper care of your monitor, keyboard and mouse.

## Screen and computer

As your LCD screen is a product made of glass which is equipped with high touchscreen technology, it is recommended that you should handle the screen and computer with special care while performing maintenance on them, since vibrations or inappropriate operation may reduce the life of the devices.

- Slots and openings on the back or top of the cabinet are for ventilation. They must not be blocked or covered. Your computer should never be placed near or over a radiator or heat source, or in a built-in installation unless proper ventilation is provided.
- Never push objects or spill liquid of any kind into this product.
- To help maintain the best image quality on your monitor, use a screen saver and turn off your monitor when you are not using your computer.

## Cleaning the screen and computer

To get rid of the dust or fingerprints, be sure to clean the computer case and display regularly. The following procedures should be followed when cleaning your monitor:

- Turn off your computer.
- Disconnect the computer power cord from the rear panel of the computer. (Pull the plug, not the cord.)
- To clean the computer case, use a soft cloth dampened with water to wipe the case clean, and do not use solvents or abrasives.
- To clean the dust or fingerprints on the screen, gently wipe the screen with a dry, soft, and lint-free cloth to avoid any unwanted scratches. If using quality screen cleaner to remove the dirt on the screen surface as necessary, apply a small amount of the cleaner onto the cloth, and then carefully wipe the screen surface with it. Never spray cleaner directly onto the screen.

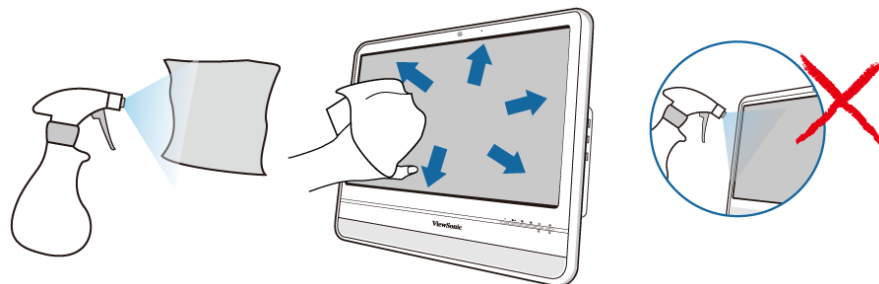

## Storing your computer

If you need to store your computer for an extended period of time, unplug your computer from the electric outlet and remove all connected cables before any action is taken. When transporting your computer, we recommend you pack the computer in its original packaging.

## CDs and DVDs (ViewSonic Wizard CD and System Recovery and Driver Disk)

Your computer is shipped with a ViewSonic Wizard CD, containing this user manual, and a System Recovery and Driver Disk, allowing you to reinstall the operating system. In case you need them for future usage, always store them in the original sleeves to avoid scratches and dirt, and keep them in a safe place.

## Cleaning the discs

If you notice problems while playing the CDs or DVDs, such as skipping, try to clean the discs by following the procedures below.

1. Hold the outer edge of the disc.
2. Use a soft lint-free cloth to wipe your CD or DVD (the unlabeled side) in a straight line from the center to the outer edge of the disc.

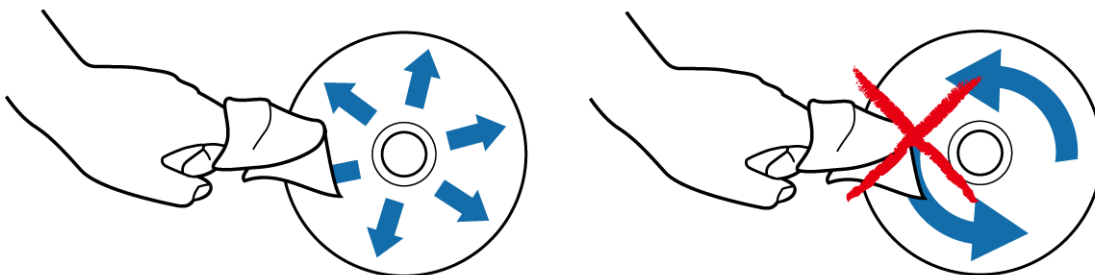

**To avoid damaging the surface of your disc, never wipe in a circular motion around the disc.**



**For stubborn spots or dirt, you can use a soft lint-free cloth moistened with some water or mild detergent to wipe across the disc, starting from the inside out in straight line, rinse the disc well, and then allow it to air dry completely.**

## Keyboard and mouse

### Cleaning your keyboard and mouse

Before starting to clean the keyboard or mouse, unplug the USB cable to disconnect the keyboard from the computer. To properly disconnect the USB cable, see **Removing USB devices**.

1. For wireless keyboard or mouse only, if your keyboard or mouse has a power button, turn it off.
2. For wireless keyboard or mouse only, remove installed batteries from the battery compartment.
3. For the keyboard, use a can of compressed air (purchased separately) to blow away any dust between the keys on the keyboard. You may even turn the keyboard upside to remove the dust trapped between the keys.
4. Use a soft lint-free cloth moistened with some water to wipe the keys and chassis of your keyboard or mouse. Do not allow water to seep into the internal components of keyboard or mouse.
5. Before reassembling and reconnecting the keyboard or mouse, ensure they are completely dry.

# BIOS Setup Utility

**BIOS Setup Utility** is a program for configuring the BIOS (Basic Input/Output System) settings of the computer.

BIOS is a layer of software called firmware that translates instructions from other layers of software into instructions that the computer hardware can understand. The BIOS settings are needed by your computer to identify the types of installed devices and establish special features.

This chapter tells you how to use the **BIOS Setup Utility**.

## When to Use the BIOS Setup Utility

You need to run the **BIOS Setup Utility** when:

- You see an error message on the screen requesting you to run Setup.
- You want to restore the factory default settings.
- You want to modify some specific settings of the hardware.
- You want to modify some specific settings to optimize system performance.



**The BIOS setup screen shown in this chapter is for your reference only. The actual items or settings on your VPC101 may differ.**

To run BIOS setup, press the <F2> key immediately when the ViewSonic logo appears on the screen during system startup. The logo shows up on the screen for only a few seconds, so you must press the <F2> key at the time. The BIOS setup main screen will appear as follows.

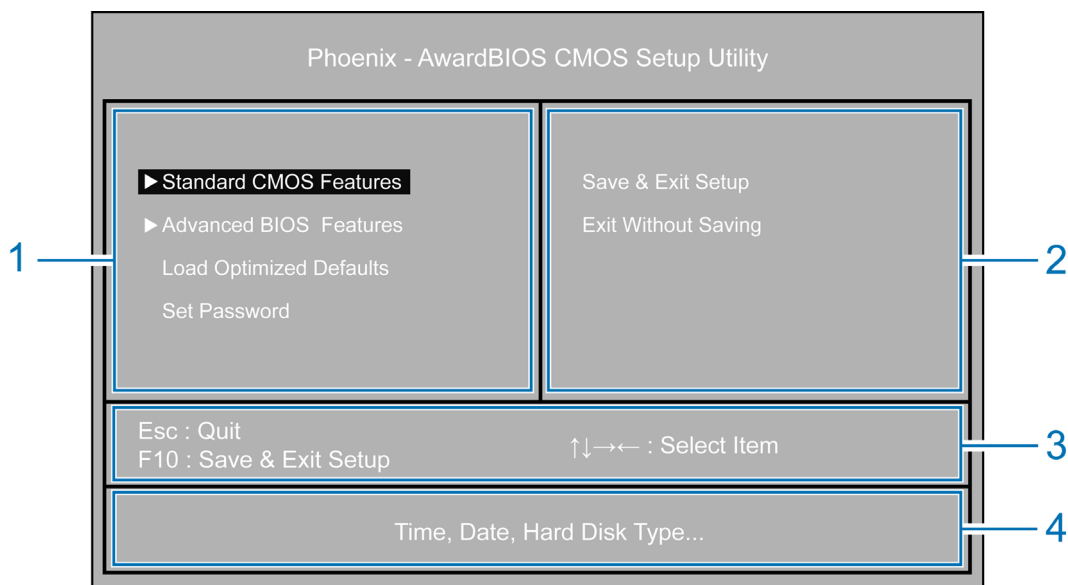

# BIOS Setup Utility

The BIOS setup main screen can be divided into four areas:

Area	Descriptions
1	Displays the configuration menus for your computer.
2	Displays the ways of exiting BIOS setup.
3	Displays keyboard instructions for moving around and making selections.
4	Displays brief information about the current menu selected.

The configuration menu with an arrow at the left of it, such as **Standard CMOS Features**, contains its own submenu. The submenu will appear as follows.



**The submenu screen shown below is for your reference only. The actual items or settings on your VCP101 may differ.**

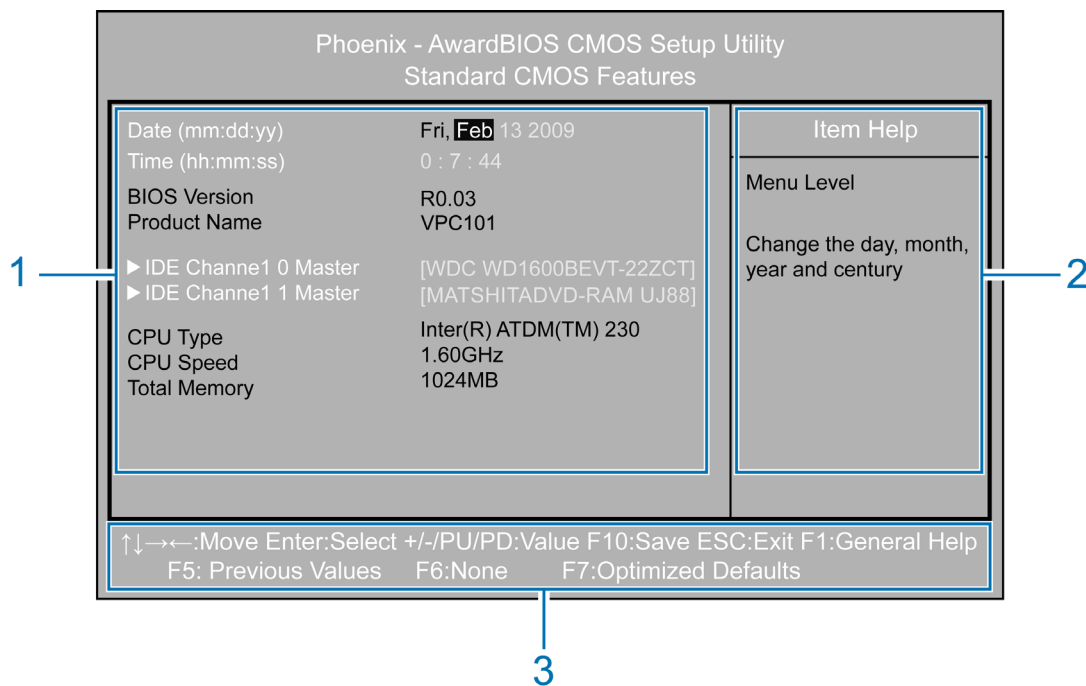

The submenu screen can be divided into three areas:

Area	Descriptions
1	Displays information regarding the current settings of the system.
2	Displays Help information about the current menu selected.
3	Displays keyboard instructions for moving around and making selections.



The **BIOS Setup Utility** provides a **General Help** screen. You can access this screen for assistance by pressing <F1>. From the displayed screen, you may learn the appropriate keys to use and the possible selections for the highlighted item. Pressing <Esc> will exit this screen.

## Standard CMOS Features menu

The **Standard CMOS Features** menu contains the basic configuration settings of the system and shows some system information, such as the BIOS version, CPU type and speed, and the system memory, etc.

A brief description of the adjustable menus displays in the **Descriptions** box below.

Menu	Descriptions
<b>Date (mm:dd:yy)</b>	Allows you to set the date of the system. Use <<-> or <-> to select an item, and then press <Page Up> or <Page Down> to change the value.
<b>Time (hh:mm:ss)</b>	Allows you to set the time of the system. Use <<-> or <-> to select an item, and then press <Page Up> or <Page Down> to change the value.
<b>IDE Channel 0 Master</b>	Displays the currently installed hard drive. Press <Enter> to access its submenu for more information. It is recommended that you set <b>Auto</b> for the available options.
<b>IDE Channel 1 Master</b>	Displays the currently installed optical drive. Press <Enter> to access its submenu for more information. It is recommended that you set <b>Auto</b> for the available options.

## Advanced BIOS Features menu

The **Advanced BIOS Features** menu displays all the bootable devices present on the system. It offers options for setting boot device priority, boot setting configurations, security, and video memory size.

A brief description of the adjustable menus displays in the **Descriptions** box below.

Menu	Descriptions
<b>Hard Disk Boot Priority</b>	Press <Enter> to access its submenu. Use <↑> or <↓> to specify a device and then use <+> or <-> to change the sequence. Press <Esc> to save the changes and exit the menu.
<b>CD-ROM Boot Priority</b>	
<b>Network Boot Priority</b>	

<b>First Boot Device</b>	<p>Press &lt;Enter&gt; to access its submenu. Use &lt;↑&gt; or &lt;↓&gt; to specify a device. Press &lt;Enter&gt; to save the changes or &lt;Esc&gt; to cancel the change and exit the menu.</p> <p> <b>To select a boot device manually, press &lt;F9&gt; when the ViewSonic logo appears on the screen during system startup. The Boot Menu will appear. Use &lt;←&gt; or &lt;→&gt; to select a boot device, and then press &lt;Enter&gt; to confirm.</b></p>
<b>Second Boot Device</b>	
<b>Third Boot Device</b>	
<b>Boot Other Device</b>	<p>Press &lt;Enter&gt; to access its submenu. Use &lt;↑&gt; or &lt;↓&gt; to enable or disable the system to boot from other devices if it fails to boot from the first, second, and third boot device.</p> <p>Press &lt;Enter&gt; to save the changes or &lt;Esc&gt; to cancel the change and exit.</p>
<b>Security Option</b>	<p>Press &lt;Enter&gt; to access its submenu. Use &lt;↑&gt; or &lt;↓&gt; to control authorized access to the BIOS setup screen and the system. The following two options are provided.</p> <ul style="list-style-type: none"> <li>• <b>Setup:</b> The password is required when access to the BIOS setup screen.</li> <li>• <b>System:</b> The password is required when the system is powered on and when access to the BIOS setup screen.</li> </ul> <p>Press &lt;Enter&gt; to save the changes or &lt;Esc&gt; to cancel the change and exit the menu.</p>
<b>Video Memory Size</b>	<p>Press &lt;Enter&gt; to access its submenu. Use &lt;↑&gt; or &lt;↓&gt; to specify the amount of system memory reserved for the video controller use. Press &lt;Enter&gt; to save the changes or &lt;Esc&gt; to cancel the change and exit the menu.</p>



**If you are not familiar with the items in the Advanced BIOS Features menu, you are advised to keep the default.**

## Load Optimized Defaults menu

The **Load Optimized Defaults** menu allows you to load the default factory settings for optimal system performance.

When you select this menu and press <Enter>, a message window will appear.

- Typing <Y> will load BIOS defaults for all items.
- Typing <N> will cancel this command.

## Set Password menu

The **Set Password** menu allows you to set password in order to safeguard your system against unauthorized use.

When you select this menu and press <Enter>, the **Enter Password** window will appear.

- To enable the password, set the password up to eight characters, then press <Enter>. The password just typed will replace any previously set password. When asked to confirm the password, type the password again and press <Enter> to save the changes.

You should further decide when the password is required. Select "**Security Option**" from the Advanced BIOS Features menu, and press <Enter> to access its submenu.

- If the **Security Option** is set to **Setup**, the password is required when you access the BIOS setup main screen.
- If the **Security Option** is set to **System**, the password is required both at boot and when you access the BIOS setup main screen.
- To disable or clear the set password, simply press <Enter>. A message will appear confirming the password will be disabled. When the password is disabled, you can enter the BIOS setup main screen without entering any password.



**Do NOT set the BIOS security password without having memorized it or written it down and stored it with your VPC101 warranty documentation.**

---

## Save & Exit Setup menu

After finished with your settings, you must save and exit so that the new settings can take effect.

When you select this menu and press <Enter>, a message window will appear.

- Typing <Y> will save settings to CMOS and exit BIOS setup.
- Typing <N> will cancel this command.

## Exit Without Saving menu

The **Exit Without Saving** menu allows you to exit BIOS setup without saving the settings that you have just specified.

When you select this menu and press <Enter>, a message window will appear.

- Typing <Y> and then pressing <Enter> will disregard any changes and restart the system.
- Typing <N> will cancel this command and return to the BIOS setup main screen.

---

# System Recovery

---

Your All-in-One PC supports system recovery to enable users to restore the system to its default settings. This function is useful in the event of a system failure or when you forget system passwords.

## When to Use System Recovery

You need to run system recovery:

- In the event of a system or hardware failure.
- You need to restore the system back to its default settings.
- You forgot the system password.

System recovery will format the hard disk and restore the system to its default settings. Thus all files and other data on drive C: will be deleted.

You may run system recovery with:

- **ViewSonic® Recovery Manager** - helps you reinstall the factory-shipped operating system and hardware drivers. For details, see **Running ViewSonic® Recovery Manager**.
- **Recovery discs** - allowing you to create recovery discs from factory default system image. Then you may recover your system from the recovery discs you have created, when the system is abnormal or damaged. For details, see **Running Recovery Disc Creation Tool** and **Using the recovery DVD**.

## Running ViewSonic® Recovery Manager

Your All-in-One PC uses ViewSonic® Recovery Manager for system recovery functions. To run ViewSonic® Recovery Manager, follow the steps below:

1. Turn on the All-in-One PC. The system boots up and the ViewSonic® logo appears.
2. When the screen displays **F3...**, quickly press the <F3> button on the keyboard.



**If Windows operating system starts up before you press <F3> and you still wish to run System Recovery, restart the All-in-One PC then follow the same procedures above.**

---

3. Click **ViewSonic® Recovery Manager**.



4. Click **OK**.

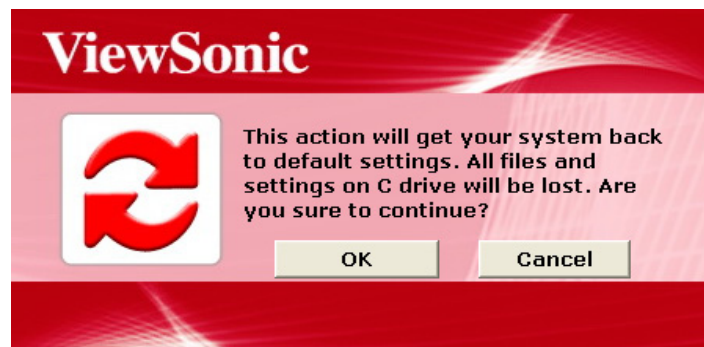

5. Another confirmation message appears, as below. Click **OK**.



6. Click **OK** to continue.



System recovery is initiated and the following screen appears.

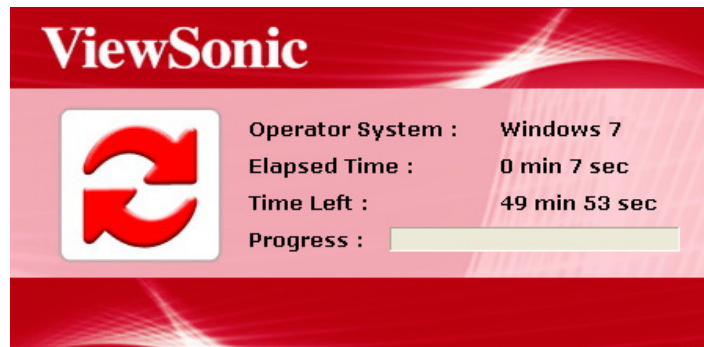

7. After the system has been restored, the following window appears.



8. Click **OK** to restart your All-in-One PC.



**Restarting may take several seconds to finish.**

9. After restarting, **Windows Setup Wizard** appears to help you configure basic settings. Follow the on-screen instructions to complete setup and start using your All-in-One PC.

## Running Recovery Disc Creation Tool

You can use Recovery Disc Creation Tool to create a recovery disc that includes factory default system image. This image contains the operating system, drivers, and software program files that were originally installed on your computer at the factory.



**The recovery disc you create can be used only with your computer, and it works on factory-installed Windows operating systems only. It is strongly recommended to create factory recovery DVD immediately once your computer is ready for use.**

To run Recovery Disc Creation Tool, follow the steps below:

1. Close all open programs.
2. Click **Start**, then click **All Programs** to open the list of programs installed on your computer.

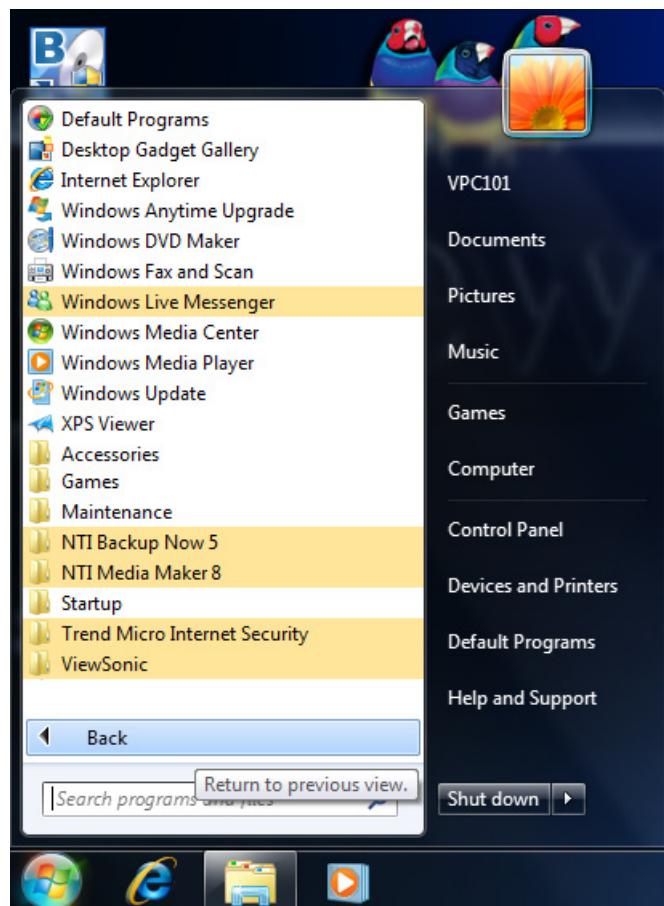

3. Click **ViewSonic** and select **Recovery Disc Creation Tool**.

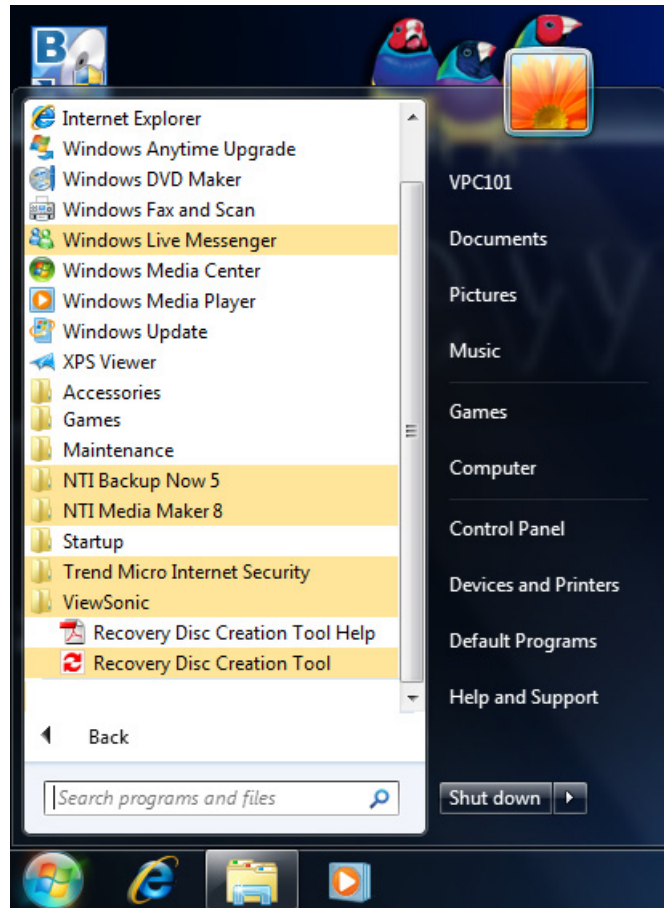

4. Click **Recovery Disc Creation Tool**.



5. Click **YES**.





6. Insert a blank disc when prompted to do so, and then click **YES**.



7. Click **OK** to continue.



8. Follow the on-screen instructions to complete the disc burning process.
9. The following window appears to inform you that the recovery disc has been created. Click **OK**.



10. Store the recovery disc in a safe place for future use.

## Using the recovery DVD

To restore your system drive (C: drive) to the factory default configuration with the recovery disc you have created, follow the steps below:

1. Insert the recovery disc into the disc slot and then restart and boot from CD.
2. When the screen displays the following message, quickly press any key within 2 seconds.

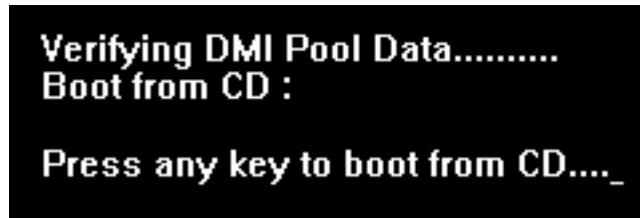

3. When the following window appears, click **Recovery to Factory Default**.



4. A confirmation window appears. Click **YES**.

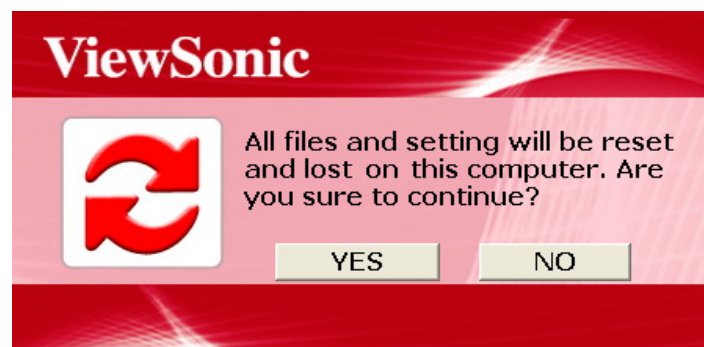

5. Click **YES** to continue recovering your computer to its original factory condition.



6. Click **OK** to continue.



System recovery is initiated and the following screen appears.

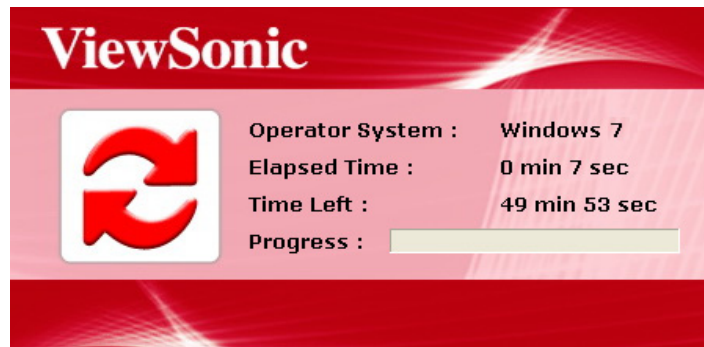

7. After the system has been restored, the following window appears. Click **OK** to restart your All-in-One PC.



**Restarting may take several seconds to finish.**



8. After restarting, follow the on-screen instructions to complete setup and start using your All-in-One PC.

# Troubleshooting

The section describes situations that you may encounter while using the computer and provides troubleshooting steps.

Before you begin troubleshooting, verify the following items:

- If you have added or removed a program or a hardware before the problem appeared, make sure that your computer has met all the pre-installation requirements, review if the installation procedures are correct, and check if the program or hardware is properly installed.
- If an error message appears while the program or hardware is in use, write down the message and follow the on-screen instruction if any. For further details, refer to the documentation or user manual of the program or hardware.

## Frequently asked questions (FAQ)

### Power problems

Symptom	Possible solution
<b>I have pressed the Power button, but my computer cannot start up.</b>	<ul style="list-style-type: none"><li>• Check the power cable and power adapter are connected.</li></ul>
	<ul style="list-style-type: none"><li>• Check the <b>Power</b> button indicator.<ul style="list-style-type: none"><li>- If the indicator does not light up, your computer is not being supplied power from an external power source via the power adapter. Check the connection between your computer, the power adapter, and the nearby outlet.</li><li>- If the indicator flashes in blue, your computer has entered Sleep mode. Move your mouse or click any button on the keyboard to wake the system.</li><li>- If the <b>Power</b> button indicator lights up in blue, the computer is being supplied normally with power. Reconnect the power adapter and restart the system.</li></ul></li></ul>
	<ul style="list-style-type: none"><li>• Check if the <b>LCD display power</b> indicator stays in green.<ul style="list-style-type: none"><li>- If the indicator lights up in amber, your monitor has entered Sleep mode. Press the <b>Power</b> button on the front panel to turn on the screen.</li></ul></li></ul>
	<ul style="list-style-type: none"><li>• Certain operating system files may be damaged or missing. If so, you have to back up all your data first, and then recover your system. Check the supplied System Recovery and Driver Disk for details.</li></ul>

## Internet access problems

Symptom	Possible solution
<b>My computer cannot access a modem or a wireless router or access point.</b>	<ul style="list-style-type: none"><li>• Verify that you have performed a correct pre-installation for your Internet connection type.<ul style="list-style-type: none"><li>- If you are using a wireless Internet connection, make sure that your computer has installed a wireless LAN card in order to connect with a wireless router or access point. For details about setting up your wireless router or access point, refer to the documentation or user manual of the unit. For details about setting up your modem, contact your ISP (Internet service provider) for assistance.</li><li>- If you are using a wired Internet connection, make sure that your computer is using an Ethernet cable, instead of a telephone cable, to connect with the broadband modem which is purchased from your ISP. For assistance setting up your modem, contact your ISP.</li></ul></li></ul>
<b>The wireless Internet connection is unstable.</b>	<ul style="list-style-type: none"><li>• Check the wireless interference.<ul style="list-style-type: none"><li>- Reset your wireless router or access point to factory defaults and reconfigure the settings. For details about setting your wireless router or access point, refer to the documentation or user manual of the unit.</li><li>- Update the firmware of your wireless router or access point to the latest version available on the manufacturer's site.</li><li>- Try moving the wireless router or access point in a central position. A couple of feet will sometimes make a big difference in signal strength.</li><li>- If you are using an access point, try changing the channel, as another access point may be interfering.</li><li>- Contact your ISP to ensure they are not experiencing technical problems.</li></ul></li></ul>

## Optical discs problems

Symptom	Possible solution
When a CD or DVD is inserted into the optical disc drive, there is no response.	<ul style="list-style-type: none"> <li>• Check the optical disc drive indicator is on.</li> </ul>
	<ul style="list-style-type: none"> <li>• Check the inserted disc is not dirty, bent, or damaged. If you need to clean the disc, see <b>Cleaning the discs</b>.</li> </ul>
	<ul style="list-style-type: none"> <li>• Check if the disc is properly inserted into the optical drive, with the label side facing toward you and the disc is centered in the tray.</li> </ul>
	<ul style="list-style-type: none"> <li>• Try another CD or DVD (preferably an unused one) to test if the optical disc drive works well.</li> </ul>
	<ul style="list-style-type: none"> <li>• If you are inserting a DVD, check the region of the disc. It may not comply with the region set for your optical disc drive. Check the DVD package to learn if the region code is compatible with your optical disc drive.</li> </ul>
	<ul style="list-style-type: none"> <li>• Try using other programs to read the data on your CD or DVD.</li> </ul>
The inserted disc doesn't slide out when I press the Eject button.	<ul style="list-style-type: none"> <li>• Ensure the computer is on.</li> </ul>
	<ul style="list-style-type: none"> <li>• Ensure the optical disc driver indicator is on while you press the <b>Eject</b> button on the optical disc drive.</li> </ul>
	<ul style="list-style-type: none"> <li>• Click <b>Start &gt; Computer</b>, right-click the disc drive icon, and then select <b>Eject</b> from the menu to remove the disc.</li> </ul>
	<ul style="list-style-type: none"> <li>• Try restarting your computer and then try pressing the <b>Eject</b> button on the optical disc drive again.</li> </ul>
	<ul style="list-style-type: none"> <li>• If the <b>Eject</b> button does not work, open the tray by inserting a sharp, pointed object into the hole next to the <b>Eject</b> button.</li> </ul>
I cannot write (burn) a disc (CD or DVD).	<ul style="list-style-type: none"> <li>• Check if the disc is properly inserted into the optical drive, with the label side facing toward you and the disc is centered in the tray.</li> </ul>
	<ul style="list-style-type: none"> <li>• Check the inserted disc is not dirty, bent, or damaged. If recording stops during a recording session, the disc probably is damaged. Please remove it and insert a different disc.</li> </ul>
	<ul style="list-style-type: none"> <li>• Ensure that the inserted disc is writable, and it must be blank or appendable (with space to add more data files).</li> </ul>
	<ul style="list-style-type: none"> <li>• Try writing the disc with other recording programs as some programs cannot write certain disc types.                             <ul style="list-style-type: none"> <li>- If you intend to write data to DVD, make sure that you are recording the data with a DVD burning program.</li> </ul> </li> </ul>
	<ul style="list-style-type: none"> <li>• Select a slower write speed if you are not under a time constraint.</li> </ul>
	<ul style="list-style-type: none"> <li>• Check if the added data files exceed the available space on the inserted writable disc.</li> </ul>
	<ul style="list-style-type: none"> <li>• Ensure that there is enough space available on the hard disk drive to store the temporary files that are created during the writing process.                             <ul style="list-style-type: none"> <li>- Click <b>Start &gt; Computer</b> to check the space available on your hard disk drive.</li> </ul> </li> </ul>

## Display problems

Symptom	Possible solution
There is nothing visible on the screen.	<ul style="list-style-type: none"> <li>• Check the power cable and power adapter are well connected.</li> </ul>
	<ul style="list-style-type: none"> <li>• Check the <b>Power</b> button indicator.               <ul style="list-style-type: none"> <li>- If the indicator does not light up, your computer is not being supplied power from an external power source via the power adapter. Check the connection between your computer, the power adapter, and the nearby outlet.</li> <li>- If the indicator flashes in blue, your computer has entered Sleep mode. Move your mouse or click any button on the keyboard to wake the system.</li> <li>- If the <b>Power</b> button indicator lights up in blue, the computer is being supplied normally with power. Reconnect the power adapter and restart the system.</li> </ul> </li> </ul>
	<ul style="list-style-type: none"> <li>• Check if the <b>LCD display power</b> indicator stays green.               <ul style="list-style-type: none"> <li>- If the indicator lights up in amber, your monitor has entered Sleep mode. Press the <b>Power</b> button on the front panel to turn on the screen.</li> </ul> </li> </ul>
	<ul style="list-style-type: none"> <li>• Check if the brightness level of the display is adjusted correctly, and is not set too low or too high. Use the <b>Brightness</b> control by pressing the <b>Brightness/Increase</b> or <b>Decrease</b> buttons on the front panel to adjust the brightness level.</li> </ul>
The images on the screen are too large or too small, or the images are blurred.	<ul style="list-style-type: none"> <li>• Press the <b>Auto-adjust</b> button on the front panel of the computer.</li> </ul>
	<ul style="list-style-type: none"> <li>• Check if the monitor is running at its native resolution.               <ul style="list-style-type: none"> <li>- Right-click the desktop, and then select <b>Screen Resolution</b>. In the opened window, set the <b>Resolution</b> to 1366 x 768, and then click <b>Apply</b> and <b>OK</b> to complete the settings.</li> </ul> </li> </ul>
The images on the screen are too bright or too dark.	<ul style="list-style-type: none"> <li>• Press the <b>Auto-adjust</b> button on the front panel of the computer.</li> </ul>
	<ul style="list-style-type: none"> <li>• Check if the brightness level of the display is adjusted correctly, and is not set too low or too high. Use the <b>Brightness</b> control by pressing the <b>Brightness/Increase</b> or <b>Decrease</b> buttons on the front panel to adjust the brightness level.</li> </ul>

## Keyboard and mouse problems

Symptom	Possible solution
Keyboard or mouse commands are not recognized by the computer.	<ul style="list-style-type: none"> <li>• If you are using a wired keyboard or mouse, check the cable connection between the unit and your computer.</li> <li>• If you are using a wireless keyboard or mouse, check the following items. <ul style="list-style-type: none"> <li>- Ensure the USB receiver is properly connected to the computer, and the keyboard or mouse is within its range.</li> <li>- If your keyboard or mouse has a power button, turn it on.</li> <li>- Press the <b>Connect</b> button on the keyboard or mouse to rebuild the connection between the unit and your computer.</li> <li>- Try replacing the batteries in the wireless keyboard or mouse.</li> <li>- Restarting the system to detect the wireless connection again.</li> </ul> </li> </ul>
I cannot type numbers using the numeric keypad.	<ul style="list-style-type: none"> <li>• Check if the <b>Num Lock</b> indicator on your keyboard is on. <ul style="list-style-type: none"> <li>- If the <b>Num Lock</b> indicator is off, that means the numeric keypad is not activated. Press the &lt;Num Lock&gt; key to activate the numeric keypad.</li> </ul> </li> </ul>
The cursor moves slowly and does not respond to the movement of the mouse.	<ul style="list-style-type: none"> <li>• If you are using a traditional mouse, check the following items. <ul style="list-style-type: none"> <li>- Use a mouse pad or other rough surface under the mouse.</li> <li>- Clean the mouse. Remove the mouse compartment cover and ball from the mouse and carefully wipe the mouse ball with a moistened cloth or scrap the rollers with a piece of firm paper to remove any dirt. Then leave the mouse ball for a while to dry out before reassembling the mouse.</li> </ul> </li> <li>• If you are using an optical mouse (either wired or wireless), refer the following items. <ul style="list-style-type: none"> <li>- Use a mouse pad or white sheet of paper under the mouse.</li> <li>- Clean the mouse by gently wiping the light sensor lens on the bottom of the mouse with a lint-free cloth.</li> </ul> </li> </ul>
The cursor moves too fast or too slow.	<ul style="list-style-type: none"> <li>• You may configure the cursor speed to meet your personal preferences. <ul style="list-style-type: none"> <li>- Click <b>Start &gt; Control Panel &gt; Mouse</b> to open the <b>Mouse Properties</b> dialog box.</li> </ul> <p>Click <b>Pointer Options</b> tab and drag the <b>Motion</b> slider toward <b>Slow</b> or <b>Fast</b> to adjust the speed at which the cursor responds to mouse movement.</p> <p>When done, click <b>OK</b> to finish the configuration.</p> </li> </ul>



## Sound and microphone problems

Symptom	Possible solution
I hear noise when connecting a headphone to the computer.	<ul style="list-style-type: none"> <li>• Check if the earphone works well.                             <ul style="list-style-type: none"> <li>- Connect the earphone to other devices, such as a radio, to see if you can still hear that noise. If the noise persists, the earphone may be out of order.</li> </ul> </li> </ul>
	<ul style="list-style-type: none"> <li>• If you hear the noise only while inserting the earphone to the computer, it is resulted from high instantaneous current. This is a normal phenomenon.</li> </ul>
I do not hear sound from the built-in speakers.	<ul style="list-style-type: none"> <li>• Check if the speaker volume is set too low or is muted.                             <ul style="list-style-type: none"> <li>- Click the volume icon, , in the system tray to check the Windows volume controls.</li> <li>- If you are using a program which has its own volume control, ensure the volume level is properly set.</li> </ul> </li> </ul>
	<ul style="list-style-type: none"> <li>• Unplug your headphone and external microphone if they have been connected to your computer.</li> </ul>
The external microphone does not work.	<ul style="list-style-type: none"> <li>• Check if the external microphone is properly connected into the microphone jack on your computer.</li> </ul>
Certain audio files cannot be played, and the Codec error messages appear.	<ul style="list-style-type: none"> <li>• Check if Windows Media Player is set to automatically download codecs.                             <ul style="list-style-type: none"> <li>- Right-click on the menu bar, select <b>Tools</b> from the opened menu, and then click <b>Options</b>. On the <b>Player</b> tab, in the <b>Automatic updates</b> area, select <b>Once a day</b>, and then click <b>Apply</b> and <b>OK</b> to complete the settings.</li> </ul> </li> <li>Then try playing the file again. If the audio file still cannot be played, it might require a codec that is not supported by Windows Media Player.</li> <li>For more information about available codecs, see the documentation for Windows Media Player at the Microsoft web site.</li> </ul>

## Miscellaneous problems

Symptom	Possible solution
<b>Certain video files cannot be played, and the Codec error messages appear.</b>	<ul style="list-style-type: none"> <li>• Check if Windows Media Player is set to automatically download codecs.               <ul style="list-style-type: none"> <li>- Right-click on the menu bar, select <b>Tools</b> from the opened menu, and then click <b>Options</b>.</li> <li>- On the <b>Player</b> tab, in the <b>Automatic updates</b> area, select <b>Once a day</b>, and then click <b>Apply</b> and <b>OK</b> to complete the settings.</li> </ul> </li> </ul> <p>Then try playing the file again. If the video file still cannot be played, it might require a codec that is not supported by Windows Media Player.</p> <p>For more information about available codecs, see the documentation for Windows Media Player at the Microsoft web site.</p>
<b>The media card reader cannot read my memory card.</b>	<ul style="list-style-type: none"> <li>• Ensure that the memory card is fully inserted into the card reader slot.</li> </ul>
	<ul style="list-style-type: none"> <li>• Ensure that the memory card is one of the supported types. For more information, see <b>Media card reader</b>.</li> </ul>
	<ul style="list-style-type: none"> <li>• Try restarting your computer.               <ul style="list-style-type: none"> <li>- When the computer is turned on, insert the card again.</li> <li>- Never insert or remove your memory cards when they are still in use, as this can cause loss of data or permanent damage to the card.</li> </ul> </li> </ul>
<b>USB devices quit working unexpectedly.</b>	<ul style="list-style-type: none"> <li>• Check if your USB devices are turned on.               <ul style="list-style-type: none"> <li>- Some USB devices are designed to conserve battery power by turning off automatically after a few minutes of inactivity. For example, your digital camera. Check if the connected USB device is turned on.</li> </ul> </li> </ul>
	<ul style="list-style-type: none"> <li>• Check if the USB port is working well.               <ul style="list-style-type: none"> <li>- Try using another USB port to connect your USB device and see if the device is detected.</li> <li>- Try connecting a low-powered USB device, such as a wired mouse, to the USB port to check if the port is working well.</li> </ul> </li> </ul>
	<ul style="list-style-type: none"> <li>• If you are using a USB hub, the power requirements of the USB port may be exceeded.               <ul style="list-style-type: none"> <li>- Try connecting your USB device directly to the USB port on your computer.</li> </ul> </li> </ul>
	<ul style="list-style-type: none"> <li>• Check if you need to pre-install software before connecting your USB device. Read the documentation or user manual of the product.</li> </ul>

# Specifications

Model	VPC101
Processor	Intel® Atom 230 processor, 1.6GHz Single Core, FSB 533MHz Intel® Atom 330 processor, 1.6GHz Dual Core, FSB 533MHz (for select models)
Chipset	Intel® 945GC + ICH7
Operating System	Microsoft Windows 7 Home Premium
Memory Type	1GB DDR2 SDRAM 533 MHz
Memory Capacity	Expandable to 2GB
Hard Drive	<ul style="list-style-type: none"><li>• One 2.5-inch hard-drive</li><li>• SATA 5400rpm 160 GB / 250GB (for select models)</li></ul>
Graphics	Processor: Intel® GMA950 integrated graphics
Adapter	65 Watt AC Adapter 100 - 240V at 50/60 Hz
Display	<ul style="list-style-type: none"><li>• 18.5" Widescreen WXGA TFT LCD (1366 x 768 resolution)</li><li>• Brightness: 250 nits</li><li>• Contrast Ratio: 1000:1</li><li>• Response Time: 5 ms</li></ul>
Ports and Connectors	<ul style="list-style-type: none"><li>• Audio in Jack: 1</li><li>• Headphone Jack: 1</li><li>• Microphone Input: 1</li><li>• Ethernet Port: 1</li><li>• USB Port(s): 4 (2.0 compliant)</li><li>• D-Sub (VGA) Input: 1</li><li>• DC-In: 1</li></ul>
Keyboard	USB keyboard and USB mouse
Media Card Reader	4-in-1 memory card reader (MS/MS-Pro/SD/MMC)
Network	Integrated Intel® 10/100/1000 (Gigabit) Ethernet
Wireless Network (for select models)	Integrated Intel® 802.11b/g Wireless Networking

# Specifications

Optical Drive (for select models)	8x super multi-format DVD +/- RW dual layer drive (up to 8.5 GB) <ul style="list-style-type: none"> <li>• Write Max.: 8x DVD+R, 8x DVD-R, 6x DVD+R DL, 6x DVD-R DL, 8x DVD+RW, 6x DVD-RW, 5x DVD-RAM, 24x CD-R, 24x CD-RW</li> <li>• Read Max.: 8x DVD-ROM, 24x CD-ROM</li> <li>• Slim form factor</li> </ul>
Web Camera (for select models)	1.3 Megapixel Web Cam and analog microphone
Audio	<ul style="list-style-type: none"> <li>• Sound System: Intel® High Definition Audio</li> <li>• 3D stereo enhanced sound system</li> <li>• Speakers (Total): 2 x 2 Watt stereo speakers</li> </ul>
Environment Requirements	<ul style="list-style-type: none"> <li>• Operating Temperature: 0 °C - 35 °C</li> <li>• Storage Temperature: -20 °C - 60 °C</li> <li>• Operating Relative Humidity: 10% ~ 90% Non-condensing</li> <li>• Storage Relative Humidity: 10% ~ 90% Non-condensing</li> </ul>
Dimension	465.8 mm (W) x 381.7 mm (H) x 82.1 mm (D) 18.3" (W) x 15" (H) x 3.2" (D)
Weight	Net: 5.0 kg / 11 lbs Gross: 7.5 kg / 16.52 lbs



**Intel®, the Intel logo, Intel Core, and Core Inside are trademarks of Intel Corporation in the U.S. and other countries.**

# Other information

## Customer Support

For technical support or product service, see the table below or contact your reseller.



**You will need the product serial number.**

Country/Region	Website	T = Telephone F = FAX	Email
Australia/New Zealand	www.viewsonic.com.au	AUS= 1800 880 818 NZ= 0800 008 822	service@au.viewsonic.com
Canada	www.viewsonic.com	T (Toll-Free)= 1-866-463-4775 T (Toll)= 1-424-233-2533 F= 1-909-468-3757	service.ca@viewsonic.com
Europe	www.viewsoniceurope.com	www.viewsoniceurope.com/uk/support/call-desk/	
Hong Kong	www.hk.viewsonic.com	T= 852 3102 2900	service@hk.viewsonic.com
India	www.in.viewsonic.com	T= 1800 11 9999	service@in.viewsonic.com
Ireland (Eire)	www.viewsoniceurope.com/ uk/	www.viewsoniceurope.com/uk/ support/call-desk/	service_ie@viewsoniceurope.com
Korea	www.kr.viewsonic.com	T= 080 333 2131	service@kr.viewsonic.com
Latin America (Argentina)	www.viewsonic.com/la/	T= 0800-4441185	soporte@viewsonic.com
Latin America (Chile)	www.viewsonic.com/la/	T= 1230-020-7975	soporte@viewsonic.com
Latin America (Columbia)	www.viewsonic.com/la/	T= 01800-9-157235	soporte@viewsonic.com
Latin America (Mexico)	www.viewsonic.com/la/	T= 001-8882328722	soporte@viewsonic.com
Renta y Datos, 29 SUR 721, COL. LA PAZ, 72160 PUEBLA, PUE. Tel: 01.222.891.55.77 CON 10 LINEAS Electroser, Av Reforma No. 403Gx39 y 41, 97000 Mérida, Yucatán. Tel: 01.999.925.19.16 Other places please refer to <a href="http://www.viewsonic.com/la/soporte/index.htm#Mexico">http://www.viewsonic.com/la/soporte/index.htm#Mexico</a>			
Latin America (Peru)	www.viewsonic.com/la/	T= 0800-54565	soporte@viewsonic.com
Macau	www.hk.viewsonic.com	T= 853 2870 0303	service@hk.viewsonic.com
Middle East	ap.viewsonic.com/me/	Contact your reseller	service@ap.viewsonic.com
Puerto Rico & Virgin Islands	www.viewsonic.com	T= 1-800-688-6688 (English) T= 1-866-379-1304 (Spanish) F= 1-909-468-3757	service.us@viewsonic.com soporte@viewsonic.com
Singapore/Malaysia/ Thailand	www.viewsonic.com.sg	T= 65 6461 6044	service@sg.viewsonic.com
South Africa	ap.viewsonic.com/za/	Contact your reseller	service@ap.viewsonic.com
United Kingdom	www.viewsoniceurope.com/ uk/	www.viewsoniceurope.com/uk/ support/call-desk/	service_gb@viewsoniceurope.com
United States	www.viewsonic.com	T (Toll-Free)= 1-800-688-6688 T (Toll)= 1-424-233-2530 F= 1-909-468-3757	service.us@viewsonic.com

## Limited Warranty

### VIEWSONIC® ALL-IN-ONE PC

#### What the warranty covers:

ViewSonic warrants its products to be free from defects in material and workmanship during the warranty period. If a product proves to be defective in material or workmanship during the warranty period, ViewSonic will, at its sole option, repair or replace the product with a similar product. Replacement Product or parts may include remanufactured or refurbished parts or components. The replacement unit will be covered by the balance of the time remaining on the customer's original limited warranty. ViewSonic provides no warranty for the third-party software included with the product or installed by the customer.

#### How long the warranty is effective:

ViewSonic VPC products are warranted for (1) year from the first consumer purchase for parts and labor.

User is responsible for the back up of any data before returning the unit for service. ViewSonic is not responsible for any data lost.

#### Who the warranty protects:

This warranty is valid only for the first consumer purchaser.

#### What the warranty does not cover:

1. Any product on which the serial number has been defaced, modified or removed.
2. Damage, deterioration or malfunction resulting from:
  - a. Accident, misuse, neglect, fire, water, lightning, or other acts of nature, unauthorized product modification, or failure to follow instructions supplied with the product.
  - b. Any damage of the product due to shipment.
  - c. Removal or installation of the product.
  - d. Causes external to the product, such as electrical power fluctuations or failure.
  - e. Use of supplies or parts not meeting ViewSonic's specifications.
  - f. Normal wear and tear.
  - g. Any other cause which does not relate to a product defect.
3. Any product exhibiting a condition commonly known as "image burn-in" which results when a static image is displayed on the product for an extended period of time.
4. Removal, installation, one way transportation, insurance, and set-up service charges.

#### How to get service:

1. For information about receiving service under warranty, contact ViewSonic Customer Support (Please refer to Customer Support page). You will need to provide your product's serial number.
2. To obtain warranty service, you will be required to provide (a) the original dated sales slip, (b) your name, (c) your address, (d) a description of the problem, and (e) the serial number of the product.
3. Take or ship the product freight prepaid in the original container to an authorized ViewSonic service center or ViewSonic.
4. For additional information or the name of the nearest ViewSonic service center, contact ViewSonic.

### **Limitation of implied warranties:**

There are no warranties, express or implied, which extend beyond the description contained herein including the implied warranty of merchantability and fitness for a particular purpose.

### **Exclusion of damages:**

ViewSonic's liability is limited to the cost of repair or replacement of the product. ViewSonic shall not be liable for:

1. Damage to other property caused by any defects in the product, damages based upon inconvenience, loss of use of the product, loss of time, loss of profits, loss of business opportunity, loss of goodwill, interference with business relationships, or other commercial loss, even if advised of the possibility of such damages.
2. Any other damages, whether incidental, consequential or otherwise.
3. Any claim against the customer by any other party.
4. Repair or attempted repair by anyone not authorized by ViewSonic.

### **Effect of state law:**

This warranty gives you specific legal rights, and you may also have other rights which vary from state to state. Some states do not allow limitations on implied warranties and/or do not allow the exclusion of incidental or consequential damages, so the above limitations and exclusions may not apply to you.

### **Sales outside the U.S.A. and Canada:**

For warranty information and service on ViewSonic products sold outside of the U.S.A. and Canada, contact ViewSonic or your local ViewSonic dealer.

The warranty period for this product in mainland China (Hong Kong, Macao and Taiwan Excluded) is subject to the terms and conditions of the Maintenance Guarantee Card.

For users in Europe and Russia, full details of warranty provided can be found in [www.viewsoniceurope.com](http://www.viewsoniceurope.com) under Support/Warranty Information.





## Free Manuals Download Website

<http://myh66.com>

<http://usermanuals.us>

<http://www.somanuals.com>

<http://www.4manuals.cc>

<http://www.manual-lib.com>

<http://www.404manual.com>

<http://www.luxmanual.com>

<http://aubethermostatmanual.com>

Golf course search by state

<http://golfingnear.com>

Email search by domain

<http://emailbydomain.com>

Auto manuals search

<http://auto.somanuals.com>

TV manuals search

<http://tv.somanuals.com>