

ViewSonic®

VPC190 All-in-One PC

- User Guide
- Guide de l'utilisateur
- Bedienungsanleitung
- Guía del usuario
- Руководство пользователя
- Οδηγός χρηστών
- 使用手冊 (繁體)
- 사용자 안내서
- دليل المستخدم



ViewSonic®

Model No. : VS13111

Table of Contents

Compliance Information	i
Important Safety Instructions	iii
Declaration of RoHS Compliance	iv
Copyright Information	v
Product Registration	vi
Chapter 1 Getting Started	1
Package Contents	2
Features	3
All-in-one	3
Space saver	3
High video quality	3
Mountable	3
Low power consumption	3
System Overview	4
Chapter 2 Installation	8
Attaching the Stand	9
Tilting the Screen	9
Removing the Stand	9
Connecting USB Devices	10
Connecting a USB Keyboard	10
Connecting a USB Mouse	11
Connecting the Power	11
Connecting Audio Components	12
Connecting the Headset	12
Connecting a Microphone	12
Connecting to a Network	12
Chapter 3 Operating	13
Using the Power Button	14
Turning On the All-in-One PC	14
Turning Off the All-in-One PC	14
Using the Card Reader	14
Inserting the card	14
Removing the card	14
Using the Optical Disc Drive	15
Inserting a Disc	15
Removing a Disc	15
Chapter 4 BIOS Setup Utility	16
When to Use the BIOS Setup Utility	17
Starting BIOS Setup	17

Moving Around and Making Selections	17
Menu	18
Sub-menu	18
General Help	18
Main Menu	19
Advanced Menu	19
Boot Menu	24
Boot Settings Configuration	25
Security Menu	26
Exit Menu	28
Chapter 5 System Recovery	29
When to Use System Recovery	30
Running ViewSonic Recovery Manager	30
Use ViewSonic Recovery DVD Disc	32
Chapter 6 Troubleshooting	33
Chapter 7 Other Information	37
Customer Support	37
Limited Warranty	38

Compliance Information

For U.S.A.

This device complies with part 15 of FCC Rules. Operation is subject to the following two conditions: (1) this device may not cause harmful interference, and (2) this device must accept any interference received, including interference that may cause undesired operation.

This equipment has been tested and found to comply with the limits for a Class B digital device, pursuant to part 15 of the FCC Rules. These limits are designed to provide reasonable protection against harmful interference in a residential installation. This equipment generates, uses, and can radiate radio frequency energy, and if not installed and used in accordance with the instructions, may cause harmful interference to radio communications. However, there is no guarantee that interference will not occur in a particular installation. If this equipment does cause harmful interference to radio or television reception, which can be determined by turning the equipment off and on, the user is encouraged to try to correct the interference by one or more of the following measures:

- Reorient or relocate the receiving antenna.
- Increase the separation between the equipment and receiver.
- Connect the equipment into an outlet on a circuit different from that to which the receiver is connected.
- Consult the dealer or an experienced radio/TV technician for help.

Warning: You are cautioned that changes or modifications not expressly approved by the party responsible for compliance could void your authority to operate the equipment.

For Canada

This Class B digital apparatus complies with Canadian ICES-003.
Cet appareil numérique de la classe B est conforme à la norme NMB-003 du Canada.

CE Conformity for European Countries



The device complies with the EMC Directive 2004/108/EC and Low Voltage Directive 2006/95/EC.

Following information is only for EU-member states:

The mark shown to the right is in compliance with the Waste Electrical and Electronic Equipment Directive 2002/96/EC (WEEE).

The mark indicates the requirement NOT to dispose the equipment as unsorted municipal waste, but use the return and collection systems according to local law.

If the batteries, accumulators and button cells included with this equipment, display the chemical symbol Hg, Cd, or Pb, then it means that the battery has a heavy metal content of more than 0.0005% Mercury or more than, 0.002% Cadmium, or more than 0.004% Lead.



FCC Radiation Exposure Statement

This equipment should be installed and operated with minimum distance 20cm between the radiator & your body.

This wireless module device complies with part 15 of FCC Rules. Operation is subject to the following two conditions: (1) this device may not cause harmful interference, and (2) this device must accept any interference received, including interference that may cause undesired operation.

Industry Canada Notice

This wireless module device complies with Canadian RSS-210. To prevent radio interference to the licensed service, this device is intended to be operated indoors and away from windows to provide maximum shielding. Equipment (or its transmitting antenna) that is installed outdoors is subject to licensing. The installer of this radio equipment must ensure that the antenna is located or pointed such that it does not emit RF field in excess of Health Canada limits for the general population; consult Safety Code 6, obtainable from Health Canada's web site www.hc-sc.gc.ca/rpb.

R&TTE Compliance Statement

This wireless module device complies with the Essential Requirements of the R&TTE Directive of the European Union (1999/5/EC). This equipment meets the following conformance standards:

ETSI EN 300 328V1.7.1
EN 301 489-01 V1.6.1
EN 301 489-17 V1.2.1
EN 62311

Notified Countries: Germany, UK, Netherlands, Belgium, Sweden, Denmark, Finland, France, Italy, Spain, Austria, Ireland, Portugal, Greece, Luxembourg, Estonia, Latvia, Lithuania, Czech Republic, Slovakia, Slovenia, Hungary, Poland and Malta.

ENERGY STAR® information

The computer complies with the ENERGY STAR® requirements of less than 15 min of user inactivity for the display and less than 30 min of inactivity for the computer.

Move the mouse or click any button on the keyboard to wake the computer from Sleep mode.

Important Safety Instructions

1. Read these instructions completely before using the equipment.
2. Keep these instructions in a safe place.
3. Heed all warnings.
4. Follow all instructions.
5. Do not use this equipment near water. Warning: To reduce the risk of fire or electric shock, do not expose this apparatus to rain or moisture.
6. Clean with a soft, dry cloth. If further cleaning is required, see “Cleaning the Display” in this guide for further instructions.
7. Do not block any ventilation openings. Install the equipment in accordance with the manufacturer’s instructions.
8. Do not install near any heat sources such as radiators, heat registers, stoves, or other devices (including amplifiers) that produce heat.
9. Do not attempt to circumvent the safety provisions of the polarized or grounding-type plug. A polarized plug has two blades with one wider than the other. A grounding type plug has two blades and a third grounding prong. The wide blade and the third prong are provided for your safety. If the plug does not fit into your outlet, consult an electrician for replacement of the outlet.
10. Protect the power cord from being tread upon or pinched, particularly at the plug, and the point where it emerges from the equipment. Be sure that the power outlet is located near the equipment so that it is easily accessible.
11. Only use attachments/accessories specified by the manufacturer.
12. Use only with the cart, stand, tripod, bracket, or table specified by the manufacturer, or sold with the equipment. When a cart is used, use caution when moving the cart/equipment combination to avoid injury from tipping over.
13. Unplug this equipment when it will be unused for long periods of time.
14. Refer all servicing to qualified service personnel. Service is required when the unit has been damaged in any way, such as: if the power-supply cord or plug is damaged, if liquid is spilled onto or objects fall into the unit, if the unit is exposed to rain or moisture, or if the unit does not operate normally or has been dropped.
15. Risk of explosion if battery is replaced by an incorrect type. Dispose of used batteries according to the instructions.



Declaration of RoHS Compliance

This product has been designed and manufactured in compliance with Directive 2002/95/EC of the European Parliament and the Council on restriction of the use of certain hazardous substances in electrical and electronic equipment (RoHS Directive) and is deemed to comply with the maximum concentration values issued by the European Technical Adaptation Committee (TAC) as shown below:

Substance	Proposed Maximum Concentration	Actual Concentration
Lead (Pb)	0.1%	< 0.1%
Mercury (Hg)	0.1%	< 0.1%
Cadmium (Cd)	0.01%	< 0.01%
Hexavalent Chromium (Cr ⁶⁺)	0.1%	< 0.1%
Polybrominated biphenyls (PBB)	0.1%	< 0.1%
Polybrominated diphenyl ethers (PBDE)	0.1%	< 0.1%

Certain components of products as stated above are exempted under the Annex of the RoHS Directives as noted below:

Examples of exempted components are:

1. Mercury in compact fluorescent lamps not exceeding 5 mg per lamp and in other lamps not specifically mentioned in the Annex of RoHS Directive.
2. Lead in glass of cathode ray tubes, electronic components, fluorescent tubes, and electronic ceramic parts (e.g. piezoelectronic devices).
3. Lead in high temperature type solders (i.e. lead-based alloys containing 85% by weight or more lead).
4. Lead as an alloying element in steel containing up to 0.35% lead by weight, aluminium containing up to 0.4% lead by weight and as a copper alloy containing up to 4% lead by weight.

Copyright Information

Copyright © ViewSonic® Corporation, 2010. All rights reserved.

Microsoft®, Windows®, Windows NT®, and the Windows® logo are registered trademarks of Microsoft® Corporation in the United States and other countries.

ViewSonic®, the three birds logo, OnView, ViewMatch, and ViewMeter are registered trademarks of ViewSonic® Corporation.

Intel®, Pentium®, and Atom™ are registered trademarks of Intel Corporation.

Award® is a registered trademark of Phoenix Technologies Ltd.

AMI® is a registered trademark of American Megatrends Inc.

ENERGY STAR® is a registered trademark of the U.S. Environmental Protection Agency (EPA).

As an ENERGY STAR® partner, ViewSonic Corporation has determined that this product meets the ENERGY STAR®

Disclaimer: ViewSonic® Corporation shall not be liable for technical or editorial errors or omissions contained herein; nor for incidental or consequential damages resulting from furnishing this material, or the performance or use of this product.

In the interest of continuing product improvement, ViewSonic® Corporation reserves the right to change product specifications without notice. Information in this document may change without notice.

No part of this document may be copied, reproduced, or transmitted by any means, for any purpose without prior written permission from ViewSonic® Corporation.

Product Registration

To meet your future needs, and to receive any additional product information as it becomes available, please register your product on the Internet at: **www.viewsonic.com**. The ViewSonic Wizard CD-ROM also provides an opportunity for you to print the registration form, which you may mail or fax to ViewSonic.

For Your Records

Product Name:	VPC190 ViewSonic All-in-One PC
Model Number:	VS13111
Document Number:	VPC190-1_UG_ENG Rev. 1A 11-18-09
Serial Number:	_____
Purchase Date:	_____

Product disposal at end of product life

The lamp in this product contains mercury. Please dispose of in accordance with local, state or federal laws.

ViewSonic is concerned about the preservation of our environment. Please dispose of this product properly at the end of its useful life. For the recycling information, please refer to our website:

1. USA: www.viewsonic.com/company/green/recycle-program/
2. Europe: www.viewsoniceurope.com/uk/support/recycling-information/
3. Taiwan: recycle.epa.gov.tw

Specifications

Item	Description
Processor	Intel Atom D510, 1.66GHz, Dule Core, FSB 667 MHz
Operating System	Windows 7 Home Premium
Chipset	Intel NM10
Memory	2GB DDR2 SO-DIMM 800MHz
Storage	6.35cm/2.5", SATA 5400rpm 160GB
LAN	Gigabit Ethernet
Audio	Stereo HD speakers 3W x 2
LCD Display	48cm/19" TFT LCD Display (18.5" viewable) 1366 x 768 native resolution
Webcam	1.3 Mega pixel camera with digital mic. x2
Keyboard	USB 100 keys
Mouse	USB Optical mouse
Input/Output ports	USB 2.0 x6 RJ45 LAN Connector x1 Microphone in x1 Headphone out x1 4 in 1 Card reader (SD(SD 2.0 included)/MMC/MS/MS Pro.)
Built-in Drive	Slot in 8X DVD SuperMulti slim type
Wireless LAN	802.11 b/g/n
Power Supply	19V DC; 65W power adapter
Dimension	18.1 x 14.7 x 7.2 inches(WxHxD) 460 x 374 x 182 mm(WxHxD)
Weight	16.5 lb (7.5 kg)

Chapter 1 Getting Started

Congratulations on your purchase of the ViewSonic VPC 190 All-In-One PC! The VPC 190 All-In-One PC is engineered for powerful computing performance. Unlike conventional computers, this All-in-One PC is portable and can be easily moved anytime, anywhere. With its built-in components, it is flexible yet economical, providing users with maximum computing experience without compromising system performance.

Read this chapter for more information about the following topics:

- Package contents
- Features
- System Overview

Getting Started

Package Contents

Check the contents of your package. It should contain:

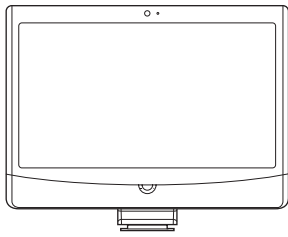

All-in-One-PC



Stand

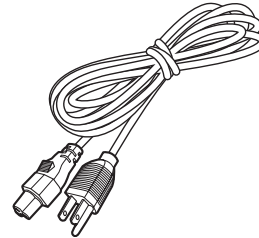

Power Cord

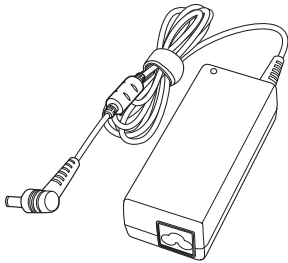

Power Adapter

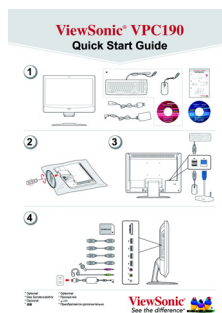

Quick Guide



System Recovery
and
User Guide Disk

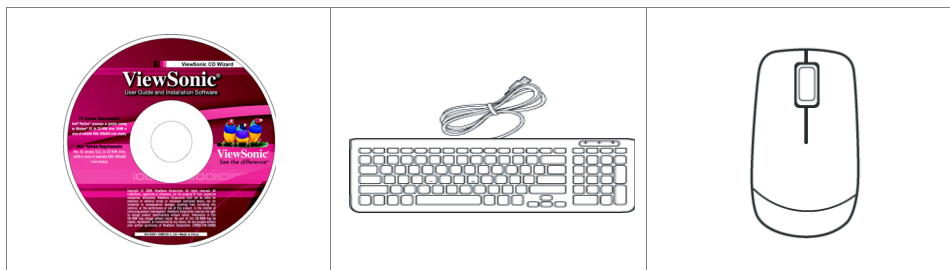

Driver
and
User Guide Disk

USB Keyboard

USB Mouse

NOTE

Your keyboard and mouse may vary depending on specific country configuration.

Getting Started

Features

All-in-one

The functionality of a standard computer and monitor are combined together in this all-in-one PC. With a built-in card reader, an optical disc drive, and I/O ports, you can connect various peripherals to maximize computer performance.

Space saver

The slim and sleek design provides more desk space. Because of its compactness, fewer cables are required which creates a tidy and uncluttered work space.

High video quality

The 48cm/19" (18.5" viewable) LCD display supports an optimal resolution of 1366x768.

Mountable

For more flexibility options, use a standard VESA mount to attach this All-in-One PC on the wall.

Low power consumption

This All-in-One PC consumes a maximum of 65 watts of power with active PFC.

Getting Started

System Overview

Front View

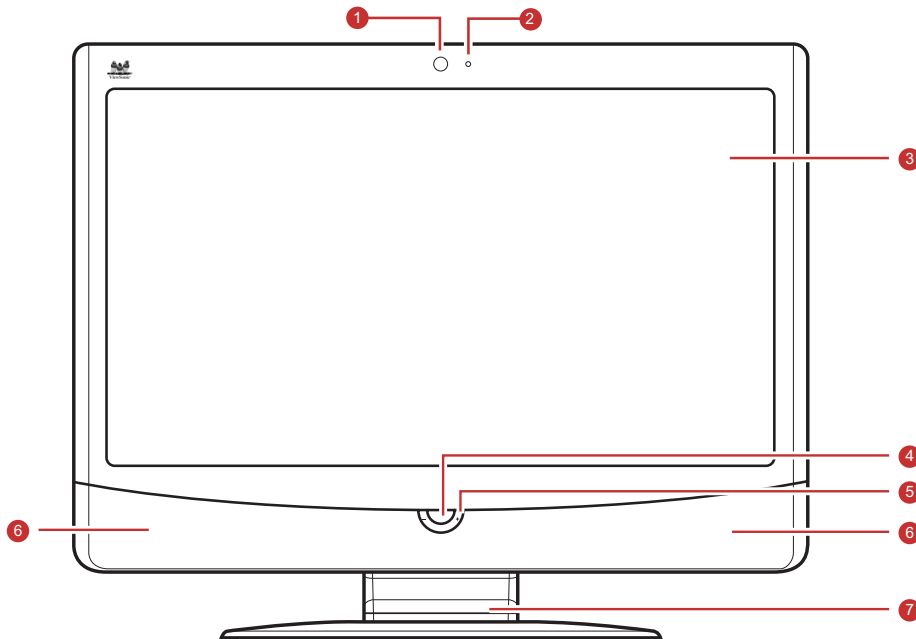

No.	Item	Description
1	Webcam	Use for taking pictures, recording videos, and video conferencing.
2	Microphone	Use for chatting and other interactive applications.
3	LCD display	Provides visual output on a 1366 x 768 resolution display.
4	Power button	Press to power on / off the All-in-One PC.
5	LCD Light Adjustment	You can adjust LCD light by push "+" and "-"
6	Stereo speakers	Output high quality sound with Hi-Fi function.
7	Stand	Holds the All-in-One PC in place.

Getting Started

Rear View

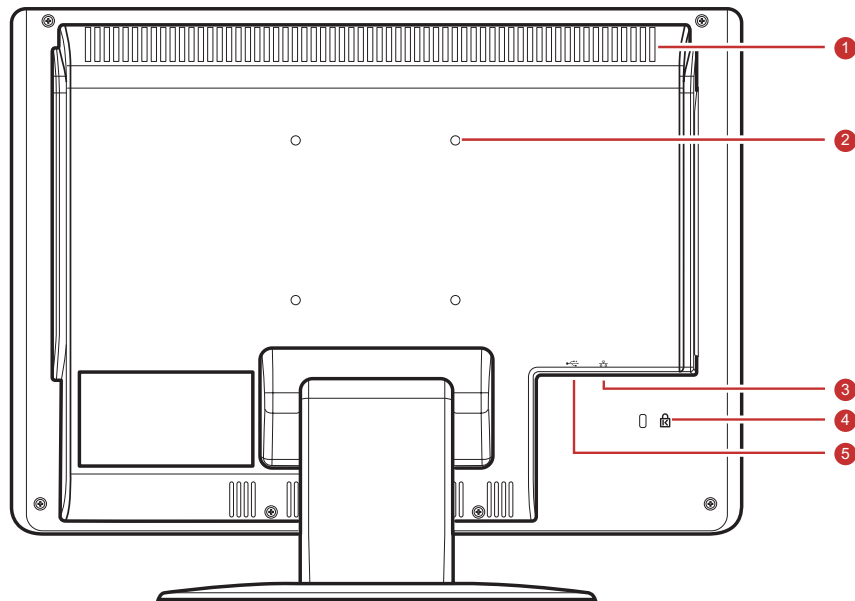

No.	Item	Description
1	Cooling Vents	Used for air convection to prevent the All-in-One from overheating. Do not cover the cooling vent.
2	VESA mount holes	Mount the All-in-One PC on the wall using VESA mounts.
3	Kenstington Lock Slot	Use to lock the PC.
4	RJ-45 LAN jack	Connects to a local area network (LAN) using a network cable.
5	USB port	Connect USB devices such as a mouse, keyboard, printer, scanner, and other peripherals.

NOTE

VESA mounts are not included in the package and are sold separately.

Getting Started

Side Views

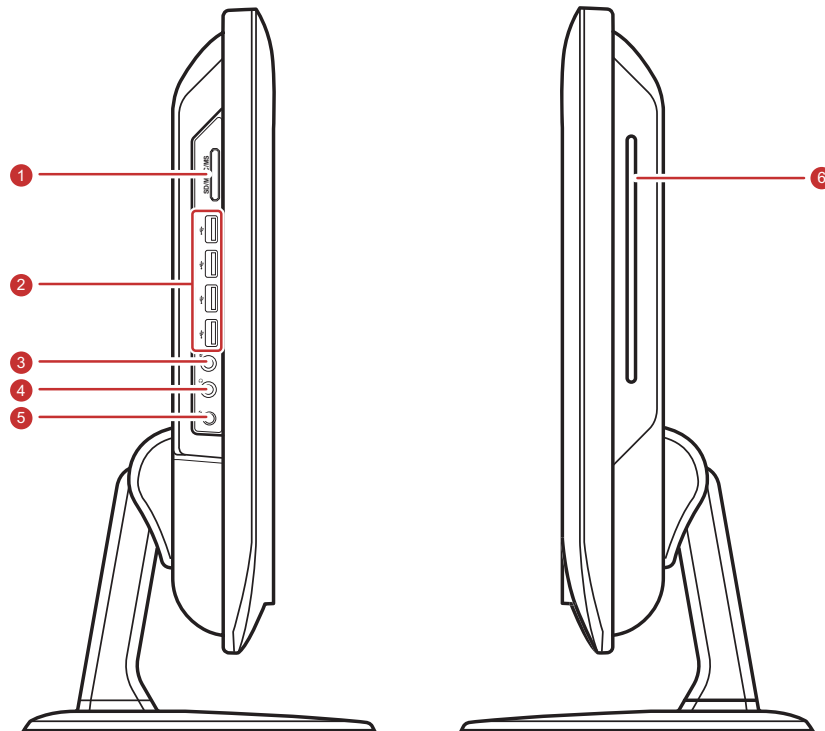

No.	Item	Description
1	4 in 1 Card Reader	Use to read SD (SD 2.0 included), MMC, MS, and MS Pro cards.
2	USB ports	Connect USB devices such as a mouse, keyboard, printer, scanner, and other peripherals.
3	External microphone jack	Connects a external microphone to the All-in-One PC.
4	Headphone jack	Connects a headphone to the All-in-One PC.
5	Power jack inlet	Use to connect the power adapter.
6	Optical disk drive	Plays or records DVD or CD disk

Chapter 2 Installation

This chapter will guide you in installing necessary and additional components to maximize the system performance of your All-in-One PC. The following topics are covered:

- Attaching the Stand
- Tilting the Screen
- Removing the Stand
- Connecting USB Devices
- Connecting the Power
- Connecting Audio Components
- Connecting to a Network

Installation

Attaching the Stand

1. Lay the All-in-One PC on a flat and stable surface.
2. Use a soft cloth to protect the display screen.
3. Attach the stand. Tighten the stand until it is firmly locked in place. Tighten the 3 screws on the bottom of the stand.

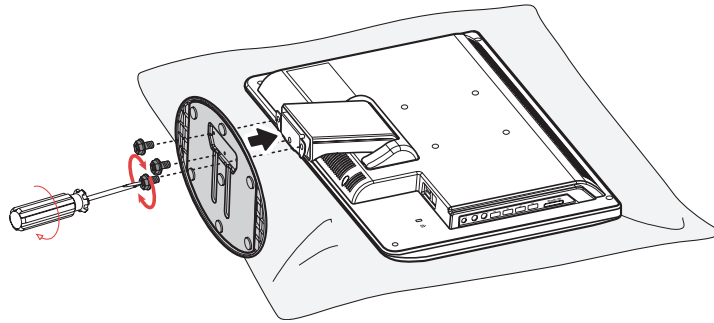

Tilting the Screen

After installing the stand, the screen can be tilted up to 20° to suit user's preference.

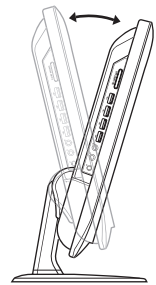

Removing the Stand

Should there be a need to detach the stand (i.e., for wall mounting), follow the steps below:

1. Lay the All-in-One PC on flat and stable surface. Use a soft cloth to protect the display screen.
2. Remove the 3 screws located on the bottom of the stand(A)
3. Pull the stand off (B)

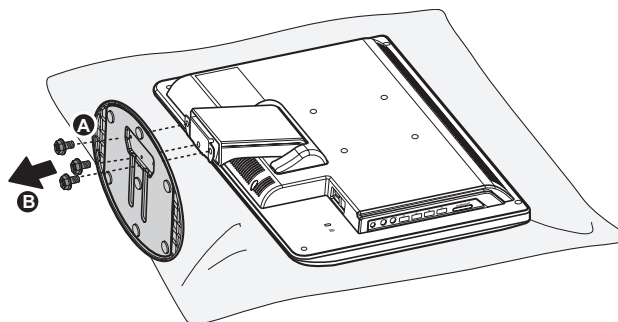

Installation

Connecting USB Devices

You can connect a keyboard and a mouse using the USB ports on the rear of your All-in-One PC. Before making any connections, ensure that the All-in-One PC is turned off.

Your All in One PC has six USB ports. Four are located on the side (see picture to right) and two are on the bottom of the PC.

Use these ports to connect USB devices, such as a printer, scanner, keyboard, mouse, USB memory drive and a digital camera among others.

Simply plug the USB cable of the device to the USB port of the All-in-One PC.

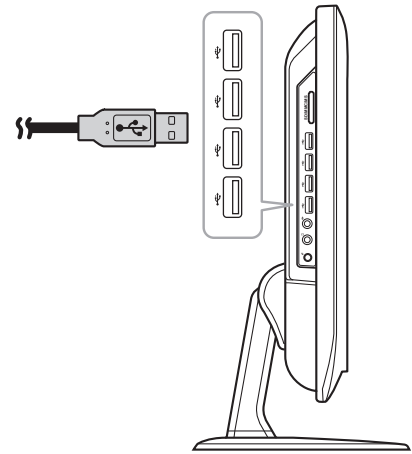

Connecting a USB Keyboard

Plug the keyboard's USB cable into the USB port of the All-in-One PC.

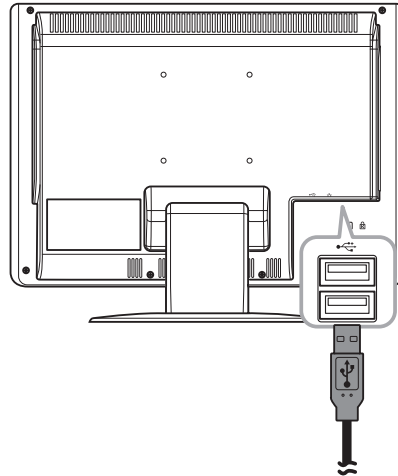

Installation

Connecting a USB Mouse

Plug the mouse's cable into the USB port of the All-in-One PC.

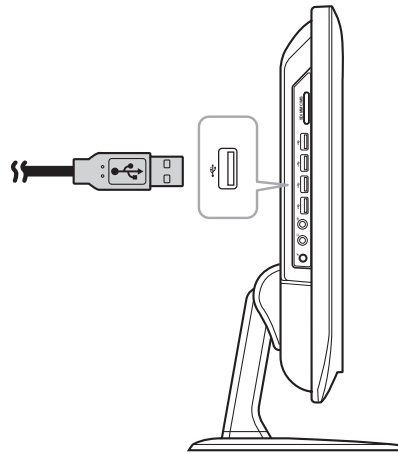

Connecting the Power

1. Connect the power adapter to the power jack of the All-in-One PC.
2. Connect the power cord to the power adapter.
3. Plug the power cord into an electrical outlet.

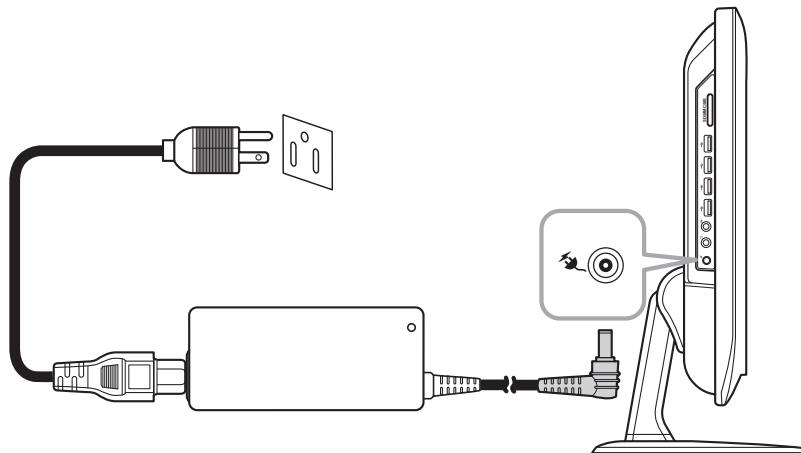

NOTE

When disconnecting the power, always unplug the power cord from the electrical outlet first. Use the cord's head to unplug, never pull the cable.

Installation

Connecting Audio Components

Connecting the Headset

Plug the stereo headphone cable into the Headphone jack (light green) of your All-in-One PC.

Connecting a Microphone

Plug the microphone cable into the Microphone jack (pink) of your All-in-One PC.

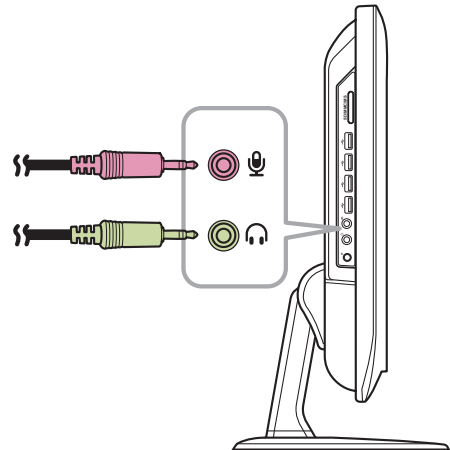

Connecting to a Network

Connect to a local area network (LAN) using the RJ-45 LAN jack of your All-in-One PC.

1. Plug one end of the network cable to the RJ-45 LAN jack at the rear of your All-in-One PC.
2. Connect the other end to a network hub or a wall socket.

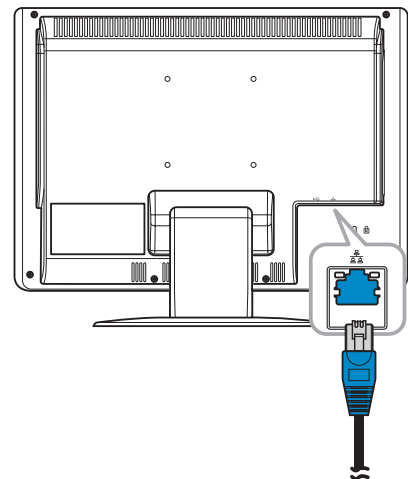

To ensure proper connection, check the LAN jack's LED indicators.

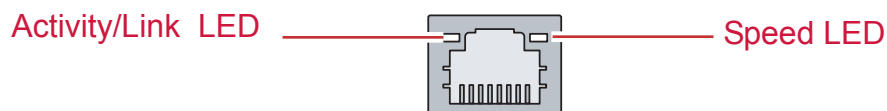

LED	Color	LED Status	Condition
Activity/Link LED	Green	Off	LAN link is not established.
		On (Steady)	LAN link is established.
		On (Flashing)	The All-in-One PC is communicating with other computers on the network.
Speed LED	Green	Off	10 Mbit/sec data rate is selected.
		On	100 Mbit/sec data rate is selected.
	Yellow	On	1000 Mbit/sec data rate is selected.

Chapter 3 Operating

This chapter describes some of the basic All-in-One PC operations. The following topics are covered:

- Using the Power Button
- Using the Card Reader
- Using the Optical Disc Drive
- Using the Keyboard

Using the Power Button

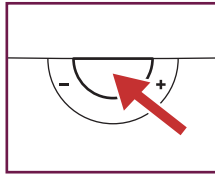

Turning On the All-in-One PC

Press the power button to turn on your All-in-One PC.

WARNING

Do not turn off your computer before it fully boots or it may cause an error the next time you turn on your All-in-One PC.

Turning Off the All-in-One PC

In Windows 7® Home Premium, click Start > shutdown > or push the power button.

NOTE

You can configure Windows to automatically shut down when you press the power button. To do this, click Start > Control Panel > Power Options > Advanced tab. In the Power buttons option, select “Shut down” from the list. Be sure to shut down all running applications before powering off.

Using the Card Reader

The built in card reader supports four types of memory cards, such as SD (SD 2.0 included), MMC, MS, and MS Pro.

Inserting the card

1. Insert the card with the metallic connectors facing towards you.
2. Push gently until the card clicks into place.

Removing the card

NOTE

Before removing a memory card, use the configuration utility on the taskbar to stop the memory card operation. Failure to do so may result in data loss.

1. Push the card gently to eject it.
2. Pull the card out from the port.

Using the Optical Disc Drive

Inserting a Disc

1. Insert the disc into the drive with the disc label facing you.
2. Gently push the disc into the disc tray.

Removing a Disc

1. From Windows 7, click Start > Computer.
2. Right click on the disc drive, then select Eject to eject the disc.
3. Gently pull out the disc from the disc tray.

WARNING

Do not remove the disc while the computer is still reading or playing it.

Chapter 4 BIOS Setup Utility

BIOS Setup Utility is a program for configuring the BIOS (Basic Input/Output System) settings of the computer.

BIOS is a layer of software called firmware that translates instructions from other layers of software into instructions that the computer hardware can understand.

The BIOS settings are needed by your computer to identify the types of installed devices and establish special features.

This chapter tells you how to use the BIOS Setup Utility.

BIOS Setup Utility

When to Use the BIOS Setup Utility

You need to run the BIOS Setup Utility when:

- You see an error message on the screen requesting you to run Setup.
- You want to restore the factory default settings.
- You want to modify some specific settings of the hardware.
- You want to modify some specific settings to optimize system performance.

Starting BIOS Setup

A keyboard is required to access and make selections in the BIOS Setup Utility. Make sure the keyboard is properly installed before you power up your All-in-One PC.

NOTE

The Setup screens shown in this chapter are for your reference only. The actual items or settings may slightly differ from that on your computer.

- The Setup utility may have been updated after the publication of this user guide.
- The settings you select in your operating system might override similar settings in the Setup.

To run BIOS Setup, follow the steps below:

1. Turn on the All-in-One PC.
2. When the ViewSonic® logo appears, quickly press the **Delete** button on the keyboard.

NOTE

If Windows operating system starts up before you press the Delete button and you still wish to enter the BIOS Setup, restart the All-in-One PC then follow the same procedures above.

Moving Around and Making Selections

The following table lists the control keys you will use to move around and select BIOS settings.

Key	Function
<F1>	General help window
<ESC>	Exit current menu
“Æ keys	Select a different menu
! Ø keys	Select Item
<Tab> or <Shift-Tab>	Cycle cursor up/down

BIOS Setup Utility

Key	Function
<Home> or <End>	Move cursor to top/bottom of the window
<PgUp> or <PgDn>	Move cursor to next/previous page
<Enter>	Go to Sub Menu
<->	Select the previous value/setting of the field
<+>	Select the next value/setting of the field
<F7>	Discard Changes
<F8>	Load Fail Safe Defaults
<F9>	Load the Optimal Defaults
<F10>	Save Change and Exit

Menu

The BIOS Setup Utility is divided into Five menu categories: Main, Advanced, Boot, Security, and Exit. Use the left and right arrow keys to move through the menu selections.

Sub-menu

Inside the menu window are the sub-menus. Highlighted items denote that the submenu options can be changed. Use the up and down arrow keys to move through the sub-menu.

A sub-menu with a pointer symbol on the left indicates that more options can be launched from this item. To exit a sub-menu, press [Esc].

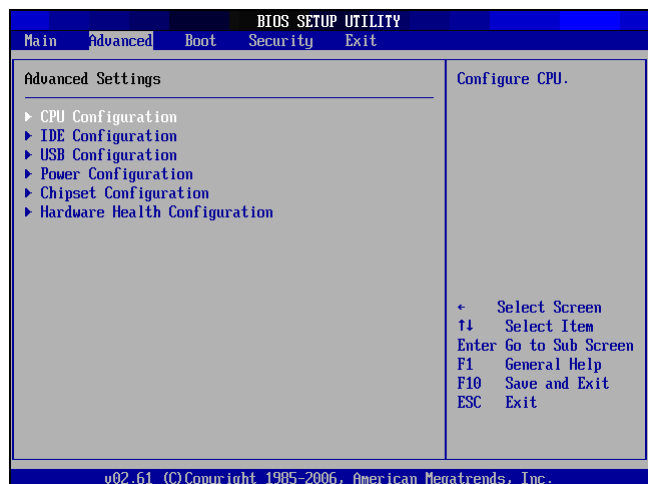

General Help

You can access help from any menu. Press [F1] to view the general help window. It lists the appropriate keys to use to browse and configure BIOS settings.

BIOS Setup Utility

Main Menu

The Main menu lets you adjust the system time and date. It also displays the processor, memory and BIOS version information.

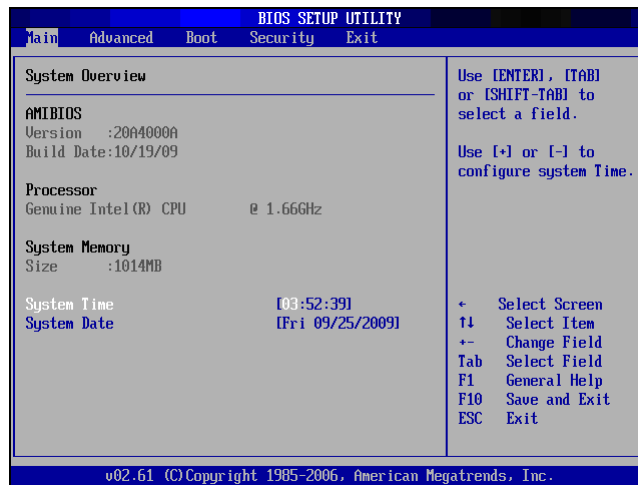

To adjust the time, go to **System Time**. To adjust the date, go to **System Date**.

Press [Tab] or [Shift Tab] to go to the next / previous field, then use + or - keys to adjust the values.

Advanced Menu

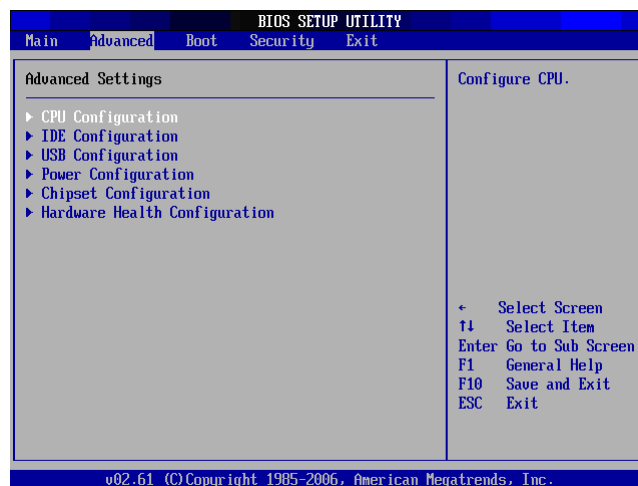

WARNING

If you are not familiar with these settings, it is recommended to use the default configuration for the Advanced Menu options. Setting the wrong values may cause the system to malfunction.

BIOS Setup Utility

The Advanced Menu lets you view and configure the following:

CPU Configuration

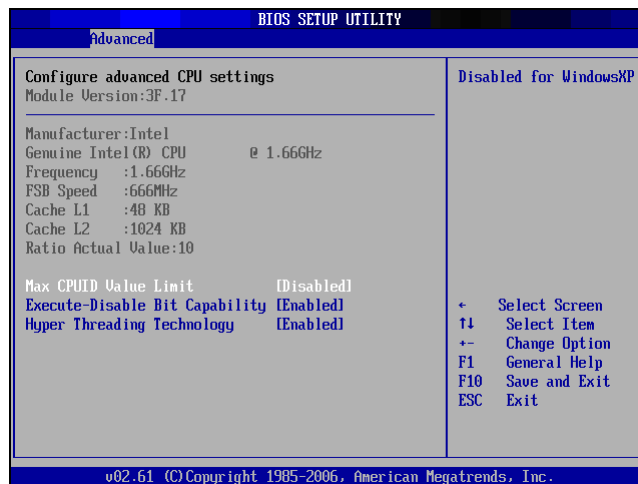

The CPU Configuration displays your All-in-One PC's CPU specification, such as the module version, manufacturer, frequency, speed among others. This submenu allows you to enable or disable the following settings:

Max CPUID Value Limit: It is recommended that you leave it at the default setting of Disabled. You should only enable it if you intend to use the Intel Pentium 4 processor with Hyper-Threading Technology with an operating system that does not support it.

Execute Disable Bit Capability: Help prevent certain classes of malicious buffer overflow attacks when combined with a supporting operating system.

Hyper Threading Technology: Hyper Threading Technology provides faster response time and improves system performance. With Hyper Threading Technology:

- You can run demanding applications simultaneously without slowing down system response time. For example, you can run multimedia applications or play the latest games and still perform a virus scan in the background.
- You can have faster Internet applications.
- It is compatible with 32-bit applications and also ready for the future 64-bit technology.

BIOS Setup Utility

IDE Configuration

The IDE Configuration displays the status of IDE devices installed in your All-in-One PC. When the system starts up, BIOS automatically detects the connected IDE devices.

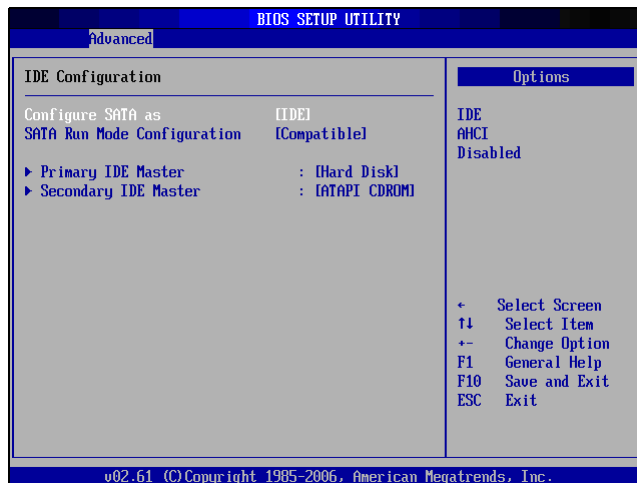

Select Primary IDE Master and press [Enter] to launch the SATA Primary IDE Master settings screen.

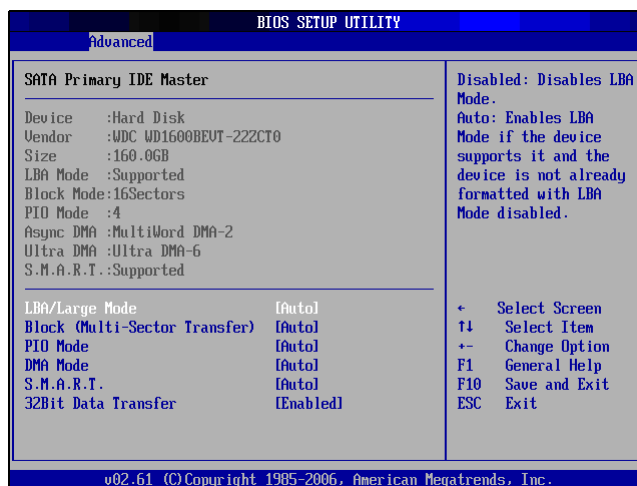

WARNING

If you are not familiar with these configurations, it is recommended to allow BIOS to auto detect the devices. Do not manually change these settings to ensure system performance.

BIOS Setup Utility

USB Configuration

The USB Configuration sub-menu allows you to configure the USB Configuration and USB Mass Storage Device settings.

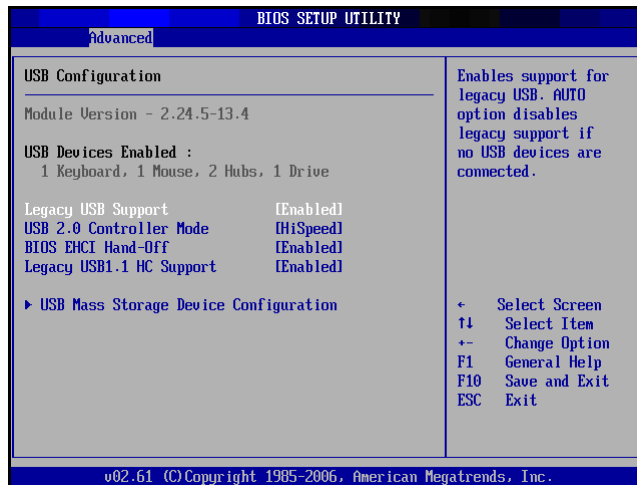

Select USB Mass Storage Device Configuration and press [Enter] to launch the USB Mass Storage Device Configuration screen.



BIOS Setup Utility

Power Configuration

The Power Configuration sub-menu allows you to configure the mode to restore on AC power loss.



Chipset Configuration

Chipset Configuration sub-menu allows you to enable or disable PXE booting.

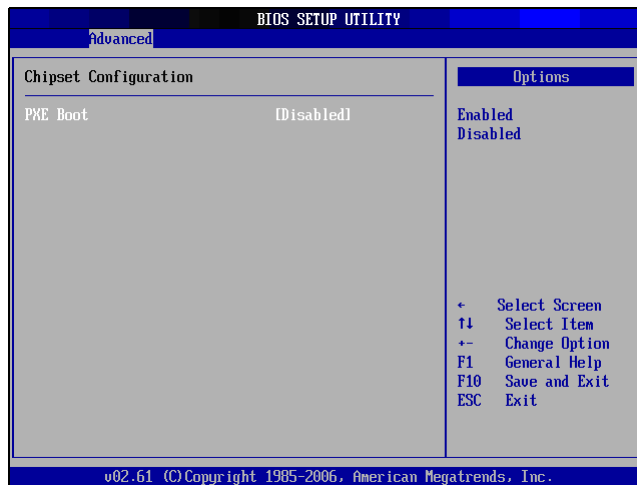

BIOS Setup Utility

Hardware Health Configuration

This sub-menu displays the hardware condition of your All-in-One PC.

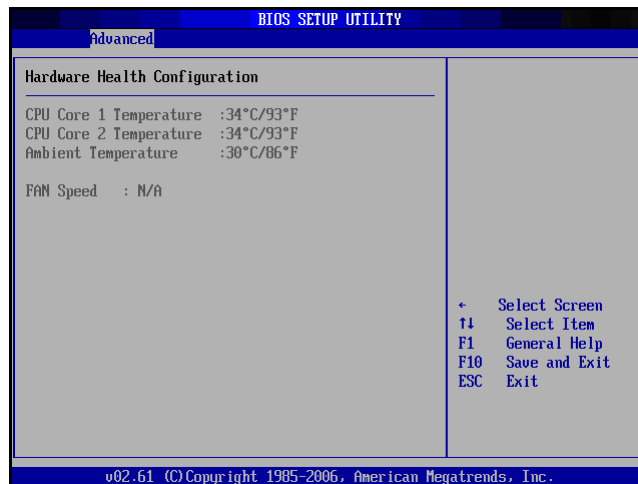

Boot Menu

The Boot menu lets you configure settings and the boot sequence to follow when the system boots up.



NOTE

The available sub-menu options may vary depending on the installed devices on your All-in-One PC.

BIOS Setup Utility

Boot Settings Configuration

With this sub-menu, you can configure the type of system boot to execute.

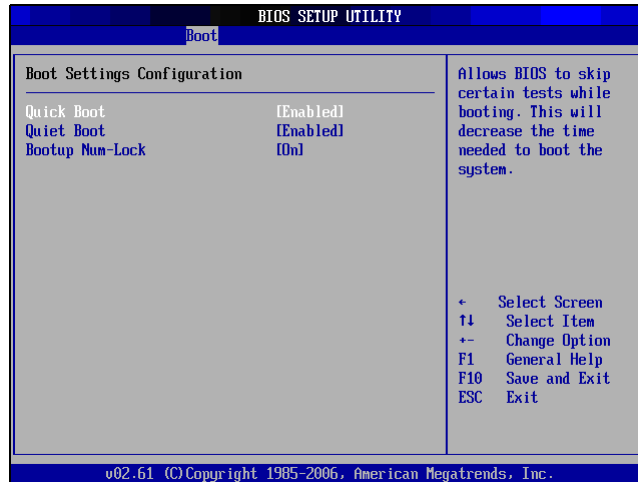

- **Quick Boot:** Enable Quick Boot to allow BIOS to skip certain tests while booting. This will decrease the time needed to boot the system.
- **Quiet Boot:** When disabled, the normal POST (Power On Self Test) messages are displayed when the system boots up. When enabled, ViewSonic logo is displayed instead.
- **Bootup Num-Lock:** Turn the "Power-on state for Numlock" on or off.

Boot Device Priority

This sub-menu lets you specify the boot priority sequence from the available devices.



To change the specified device, press [Enter] to select an available device from the list.

BIOS Setup Utility

Boot Menu

When the ViewSonic® logo appears, quickly press the **F11** button on the keyboard, Then you will enter **Boot Menu**. It allow you select the boot device.

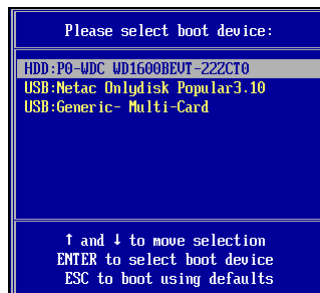

Security Menu

The Security menu displays the security settings and lets you set up and change the supervisor or user password. Available options on this screen may vary depending on the type of passwords set.

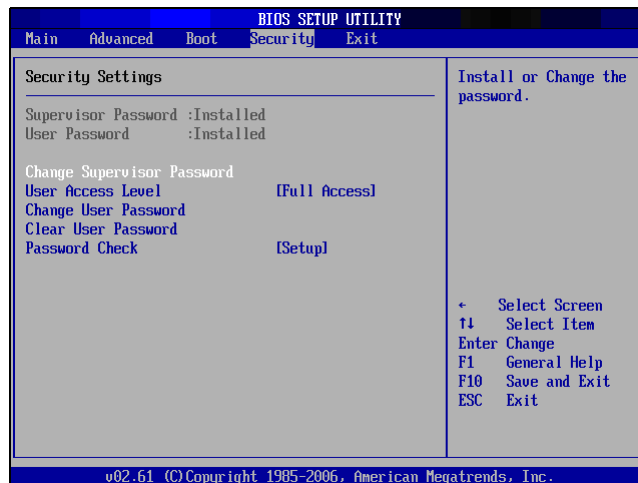

Supervisor Password

The Supervisor can access and change setup utilities. He can also define the limitation of user access.

To set or change the supervisor password:

1. Select Change Supervisor Password.
2. Type the password, then press [Enter]. The password can be an alphanumeric character of up to 6 characters in length.
3. Re-type the password to confirm, then press [Enter].

Once the Supervisor password is set, you can change the User Access Level. The access level options are:

- **Full Access:** Users can access and change all BIOS settings.
- **Limited:** Users are only allowed to change basic settings such as date and time.
- **No Access:** Users cannot access the BIOS Setup Utility.

BIOS Setup Utility

- **View Only:** Users can view the BIOS Setup Utility but cannot change the settings.

User Password

To set or change the user password:

1. Select Change User Password.
2. Type the password, then press [Enter]. The password can be an alphanumeric character of up to 6 characters in length.
3. Re-type the password to confirm, then press [Enter].

The Access level defined by the Supervisor determines the users' setup utility access.

Password Check

When a Supervisor or User password has been set, the Password Check option will be available in the Security Menu. With this option, you can configure when the system will prompt you for the password:

- **Setup:** You are required to enter the password every time you access the BIOS Setup Utility.
- **Always:** You are required to enter the password on every system boot.

Clear the Password

Deleting the Supervisor Password

1. Select Change Supervisor Password.
2. When prompted to enter the new password, just press [Enter].
3. A message will appear to confirm password is uninstalled. Press [Enter].

Deleting the User Password

1. Select Clear User Password.
2. A message will appear to confirm clearing of password, select Ok then press [Enter].

NOTE

Once you have set the Supervisor Password, you cannot start your computer without entering the password. Be sure not to forget the password. Write down your password and keep it safe and private from other people.

BIOS Setup Utility

Exit Menu

The Exit menu lets you save or discard any modifications made to the BIOS or load system default values.

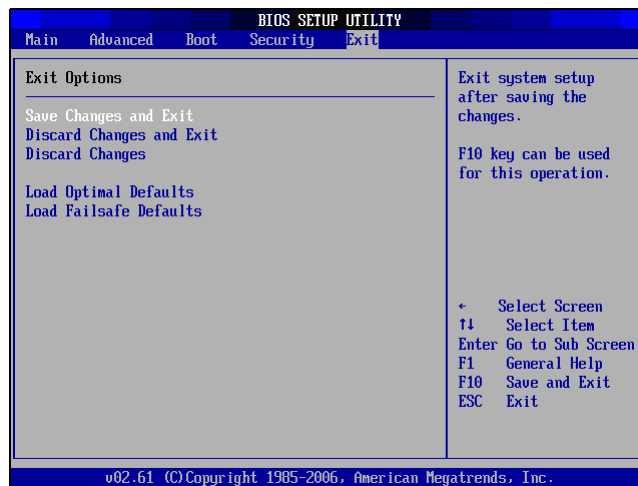

Save Changes and Exit

Select this option to save modified settings and exit BIOS.

Discard Changes and Exit

Select this option to exit BIOS without saving the modified settings.

Discard Changes

Select this option to discard any changes.

Load Optimal Defaults

Select this option to load optimal default values.

Load Failsafe Defaults

Select this option to load fail safe default values.

To perform an option, do the following:

1. Select an item.
2. Press [Enter]. A confirmation message appears.
3. Select Ok to proceed or Cancel to cancel the operation.

Chapter 5 System Recovery

Your All-in-One PC supports system recovery to enable users to restore the system to its default settings. This function is useful in the event of a system failure or when you forget system passwords.

This chapter covers the following topics:

- When to Use System Recovery
- Running ViewSonic Recovery Manager
- Use ViewSonic Recovery DVD Disc

System Recovery

When to Use System Recovery

You need to run system recovery:

- In the event of a system or hardware failure.
- You need to restore the system back to its default settings.
- You forgot the system password.

System recovery will format the hard disk and restore the system to its default settings. However all files and other data on drive C: will be deleted.

Running ViewSonic Recovery Manager

Your All-in-One PC uses ViewSonic Recovery Manager for system recovery functions.

To run ViewSonic Recovery Manager, follow the steps below:

1. Turn on the All-in-One PC. The system boots up and the ViewSonic logo appears.
2. When the screen displays F3..., quickly press the F3 button on the keyboard.



NOTE

If Windows operating system starts up before you press F3 and you still wish to run System Recovery, restart the All-in-One PC then follow the same procedures above.

The window below appears.



System Recovery

3. Click Recover to Factory Default.

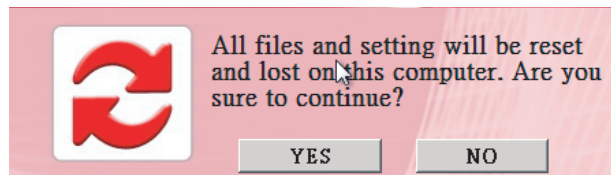

4. Click Yes. Another confirmation message appears, as below.

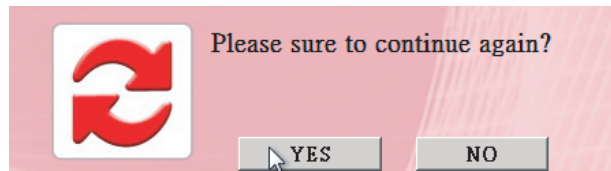

5. Click Yes. A message appears on the screen.



6. Click OK. System recovery is initiated.

7. After the system has been restored, the following window appears.

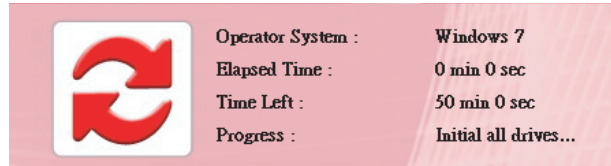

8. Click OK to restart your All-in-One PC.

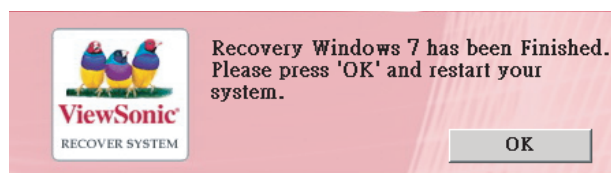

9. After restarting, Windows Setup Wizard appears to help you configure basic settings.

10. Follow the on screen instructions to complete setup and start using your All-in-One PC.

System Recovery

Use ViewSonic Recovery DVD Disc

[Caution]

ViewSonic Recovery DVD Disc will destroy all of data in hard disk.

1. Turn on the All-in-One PC. The system boots up and the ViewSonic logo appear.
2. Insert ViewSonic Recovery DVD Disc into DVD-ROM.
3. Boot from DVD-ROM
4. When the screen displays "Press any key to boot from CD or DVD...", quickly press the any key on the keyboard..

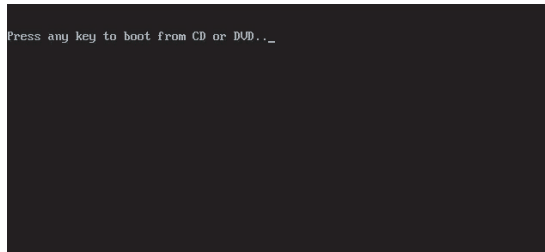

NOTE

If you can not boot from DVD-ROM before you press Any Key, please restart the All-in-One PC.

Then press [F11] button on the keyboard to select DVD-ROM as boot device.

The window below appears. You can follow the steps of "Running ViewSonic Recovery Manager" to recover your Windows OS.



Chapter 6 Troubleshooting

This chapter lists some common problems that you may encounter when using your All-in-One PC and describes solutions on how to solve them.

Troubleshooting

My All-in-One PC does not start.

- Check that the All-in-One PC is connected to an electrical outlet and it is turned on.
- Check that the power cord and all cables are connected firmly.

When I turn on my computer, the message "Operating system not found" appears or Windows does not start

- Check if there is a non-bootable CD inside the optical disk drive. If there is a non-bootable CD in the drive, remove the CD then restart the computer.
- Check boot settings in the BIOS Setup Utility, see Chapter 4.

My LCD does not display anything

- Check that the All-in-One PC is connected to an electrical outlet and it is turned on.
- The All-in-One PC may be in Standby mode. Press any key to activate the display.

My computer "locks up"

- Try restarting the All-in-One PC. On the Windows taskbar, click Start > Turn Off Computer > Restart.
- Press the power switch.
- If your computer locks up while playing a DVD-ROM/CD-ROM, stop the DVDROM/CD-ROM, and restart the computer by pressing Ctrl+Alt+Delete.

I cannot play a CD-ROM

- Make sure the label of the CD-ROM is facing up.
- If the CD-ROM requires software, make sure the software is installed according to the program's instructions.
- Moisture condensation may have occurred. Leave the computer for at least 1 hour while the computer is turned on.
- Clean the CD-ROM.
- Check the speaker volume.

Troubleshooting

I cannot play a DVD-ROM

- If a region code warning appears when you are using the DVD player, it could be that the DVD-ROM you are trying to play is incompatible with the DVD-ROM drive in your All-in-One PC. The region code is listed on the disc's packaging.
- If you hear audio but cannot see video, your computer's video resolution may be set too high. For best results, change the display settings, click Start > Control Panel > Settings.
- If you see video but cannot hear audio, check all of the following: Make sure your DVD player's mute setting is off. Check the master volume setting in the audio Mixer.
- Check that the drivers are installed properly, click Start > Control Panel > System > Device Manager.
- A dirty or damaged disc may cause the computer to "hang" while it tries to read the disc. If necessary, reboot the computer, remove the disc, and then check that it is not dirty or damaged.

My speakers have no sound

- Check the master volume setting in the audio Mixer.
- If you are using an application that has its own volume control, check that the volume is turned up.
- If you have connected an audio cable to the Headphone connector, disconnect the cable.

My internet connection has problems

- Have your phone company check that your phone line is free from any line noise.
- If your problem is fax-related, check that there are no problems with the fax machine and that it is compatible with fax modems.
- If you are having a problem connecting with your Internet Service Provider (ISP), check that the ISP is not experiencing technical problems, or If you have a second phone line available, try connecting the modem to that line.
- Check the ADSL settings and connection and make sure All-in-One PC is properly configured for Internet access.
- The wireless LAN data transfer speed is affected by distance and obstructions between devices and access points. To maximize the data transfer speed, please choose any access point you may be using closer to All-in-One PC.

Troubleshooting

My microphone does not work

- For webcam built-in microphone, please go to Start > Control Panel > Sounds and Audio Devices > Audio to check if it is muted.
- If you are using an external microphone, check that the microphone is plugged into the Microphone connector.

My mouse does not work

- Check that the mouse is plugged into the mouse connector.
- If you connected the mouse while your computer is on, you must restart your computer.

My computer does not shut down

- It is best to shut down your computer using the Shut Down command. Using other methods, including those listed here, may result in loss of unsaved data. If the ShutDown command does not work properly, follow these steps:
 - Restart the computer by pressing Ctrl+Alt+Delete.
 - Press the power switch to turn off the power.
 - Unplug the All-in-One PC from the power adapter.

Chapter 7 Other Information

Customer Support

For technical support or product service, see the table below or contact your reseller.



You will need the product serial number.

Country/Region	Website	T = Telephone F = FAX	Email
Australia/New Zealand	www.viewsonic.com.au	AUS= 1800 880 818 NZ= 0800 008 822	service@au.viewsonic.com
Canada	www.viewsonic.com	T (Toll-Free)= 1-866-463-4775 T (Toll)= 1-424-233-2533 F= 1-909-468-1202	service.ca@viewsonic.com
Europe	www.viewsoniceurope.com	www.viewsoniceurope.com/uk/Support/Calldesk.htm	
Hong Kong	www.hk.viewsonic.com	T= 852 3102 2900	service@hk.viewsonic.com
India	www.in.viewsonic.com	T= 1800 11 9999	service@in.viewsonic.com
Ireland (Eire)	www.viewsoniceurope.com/ uk/	www.viewsoniceurope.com/uk/ support/call-desk/	service_ie@viewsoniceurope.com
Korea	www.kr.viewsonic.com	T= 080 333 2131	service@kr.viewsonic.com
Latin America (Argentina)	www.viewsonic.com/la/	T= 0800 666 0194	soporte@viewsonic.com
Latin America (Chile)	www.viewsonic.com/la/	T= 800 440 303	soporte@viewsonic.com
Latin America (Columbia)	www.viewsonic.com/la/	T= 01 800 915 6588	soporte@viewsonic.com
Latin America (Mexico)	www.viewsonic.com/la/	T= 001 800 514 6518	soporte@viewsonic.com
Renta y Datos, 29 SUR 721, COL. LA PAZ, 72160 PUEBLA, PUE. Tel: 01.222.891.55.77 CON 10 LINEAS Electroser, Av Reforma No. 403Gx39 y 41, 97000 Mérida, Yucatán. Tel: 01.999.925.19.16 Other places please refer to http://www.viewsonic.com/la/soporte/index.htm#Mexico			
Latin America (Peru)	www.viewsonic.com/la/	T= 0800 53458	soporte@viewsonic.com
Macau	www.hk.viewsonic.com	T= 853 2870 0303	service@hk.viewsonic.com
Middle East	ap.viewsonic.com/me/	Contact your reseller	service@ap.viewsonic.com
Puerto Rico & Virgin Islands	www.viewsonic.com	T= 1-800-688-6688 (English) T= 1-866-379-1304 (Spanish) F= 1-909-468-1202	service.us@viewsonic.com soporte@viewsonic.com
Singapore/Malaysia/ Thailand	www.viewsonic.com.sg	T= 65 6461 6044	service@sg.viewsonic.com
South Africa	ap.viewsonic.com/za/	Contact your reseller	service@ap.viewsonic.com
United Kingdom	www.viewsoniceurope.com/ uk/	www.viewsoniceurope.com/uk/ support/call-desk/	service_gb@viewsoniceurope.com
United States	www.viewsonic.com	T (Toll-Free)= 1-800-688-6688 T (Toll)= 1-424-233-2530 F= 1-909-468-1202	service.us@viewsonic.com

Limited Warranty

VIEWSONIC® ALL-IN-ONE PC

What the warranty covers:

ViewSonic warrants its products to be free from defects in material and workmanship during the warranty period. If a product proves to be defective in material or workmanship during the warranty period, ViewSonic will, at its sole option, repair or replace the product with a similar product. Replacement Product or parts may include remanufactured or refurbished parts or components. The replacement unit will be covered by the balance of the time remaining on the customer's original limited warranty. ViewSonic provides no warranty for the third-party software included with the product or installed by the customer.

How long the warranty is effective:

ViewSonic VPC products are warranted for (1) year from the first consumer purchase for parts and labor.

User is responsible for the back up of any data before returning the unit for service. ViewSonic is not responsible for any data lost.

Who the warranty protects:

This warranty is valid only for the first consumer purchaser.

What the warranty does not cover:

1. Any product on which the serial number has been defaced, modified or removed.
2. Damage, deterioration or malfunction resulting from:
 - a. Accident, misuse, neglect, fire, water, lightning, or other acts of nature, unauthorized product modification, or failure to follow instructions supplied with the product.
 - b. Any damage of the product due to shipment.
 - c. Removal or installation of the product.
 - d. Causes external to the product, such as electrical power fluctuations or failure.
 - e. Use of supplies or parts not meeting ViewSonic's specifications.
 - f. Normal wear and tear.
 - g. Any other cause which does not relate to a product defect.
3. Any product exhibiting a condition commonly known as "image burn-in" which results when a static image is displayed on the product for an extended period of time.
4. Removal, installation, one way transportation, insurance, and set-up service charges.

How to get service:

1. For information about receiving service under warranty, contact ViewSonic Customer Support (Please refer to Customer Support page). You will need to provide your product's serial number.
2. To obtain warranty service, you will be required to provide (a) the original dated sales slip, (b) your name, (c) your address, (d) a description of the problem, and (e) the serial number of the product.
3. Take or ship the product freight prepaid in the original container to an authorized ViewSonic service center or ViewSonic.
4. For additional information or the name of the nearest ViewSonic service center, contact ViewSonic.

Limitation of implied warranties:

There are no warranties, express or implied, which extend beyond the description contained herein including the implied warranty of merchantability and fitness for a particular purpose.

Exclusion of damages:

ViewSonic's liability is limited to the cost of repair or replacement of the product. ViewSonic shall not be liable for:

1. Damage to other property caused by any defects in the product, damages based upon inconvenience, loss of use of the product, loss of time, loss of profits, loss of business opportunity, loss of goodwill, interference with business relationships, or other commercial loss, even if advised of the possibility of such damages.
2. Any other damages, whether incidental, consequential or otherwise.
3. Any claim against the customer by any other party.
4. Repair or attempted repair by anyone not authorized by ViewSonic.

Effect of state law:

This warranty gives you specific legal rights, and you may also have other rights which vary from state to state. Some states do not allow limitations on implied warranties and/or do not allow the exclusion of incidental or consequential damages, so the above limitations and exclusions may not apply to you.

Sales outside the U.S.A. and Canada:

For warranty information and service on ViewSonic products sold outside of the U.S.A. and Canada, contact ViewSonic or your local ViewSonic dealer.

The warranty period for this product in mainland China (Hong Kong, Macao and Taiwan Excluded) is subject to the terms and conditions of the Maintenance Guarantee Card.

For users in Europe and Russia, full details of warranty provided can be found in www.viewsoniceurope.com under Support/Warranty Information.



Free Manuals Download Website

<http://myh66.com>

<http://usermanuals.us>

<http://www.somanuals.com>

<http://www.4manuals.cc>

<http://www.manual-lib.com>

<http://www.404manual.com>

<http://www.luxmanual.com>

<http://aubethermostatmanual.com>

Golf course search by state

<http://golfingnear.com>

Email search by domain

<http://emailbydomain.com>

Auto manuals search

<http://auto.somanuals.com>

TV manuals search

<http://tv.somanuals.com>