

VP-8258 Plus Smart Dock Installation Guide

Hardware

Smart Dock

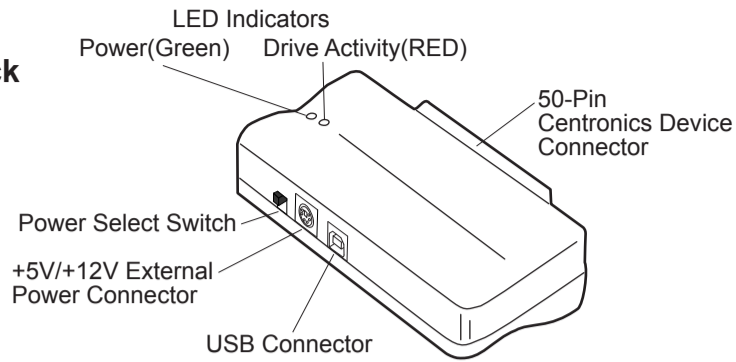

IDE Interface Boards

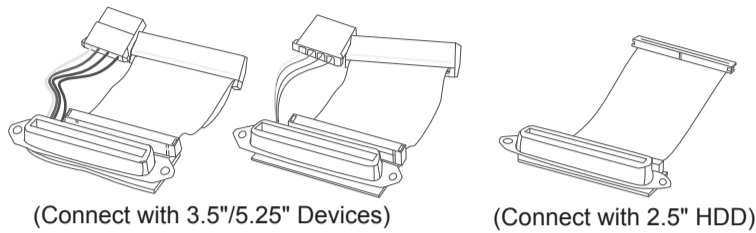

b. Internal devices such as IDE hard drives or ATA/ATAPI devices can be connected with the IDE Interface boards.

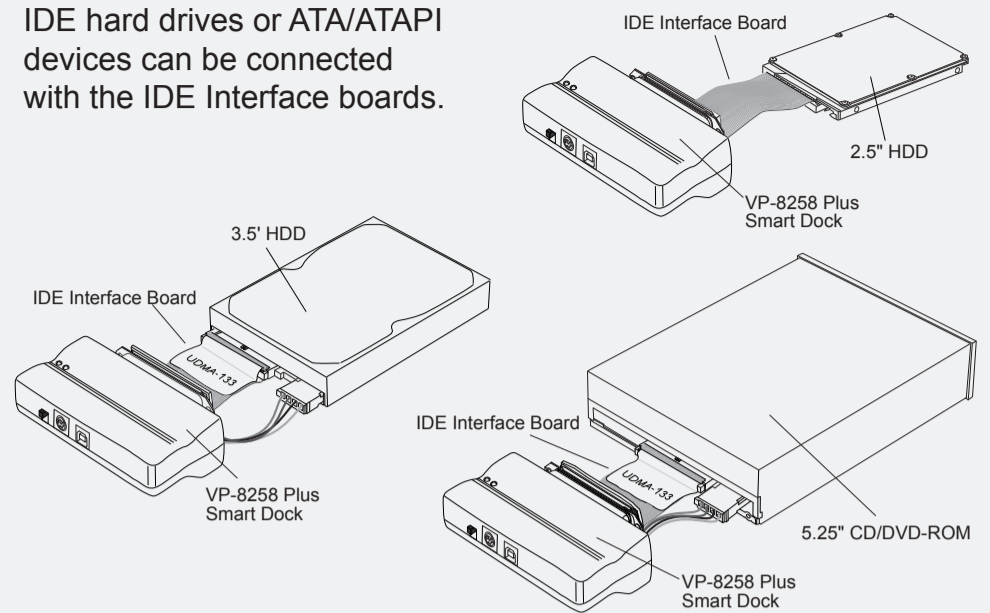

Setting up the VP-8258 Plus Smart Dock for Operation

Perform the following steps (in the order given) to set up the VP-8258 Plus Smart Dock with your peripheral device for operation:

(For Windows 98 users: Verify that the Windows 98 driver is installed.)

Important : Make sure the Power Select switch on the VP-8258 Plus Smart Dock is set to the Power OFF position before proceeding.

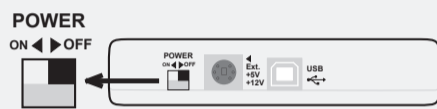

1. Plug the 50-pin Centronics connector of the VP-8258 Plus Smart Dock into the connector on the device you plan to connect to your computer.

a. External devices that provide a 50-pin centronics interface connector support direct connection with the VP-8258 Plus Smart Dock.

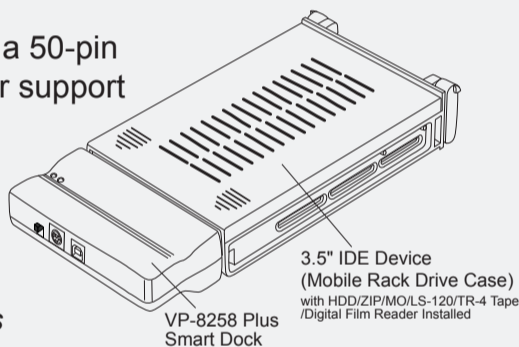

Proceed with the following steps to mount the 3.5" IDE device in the Mobile Rack Drive Case.

(1). Remove the drive Case cover by sliding it towards the back of the unit.

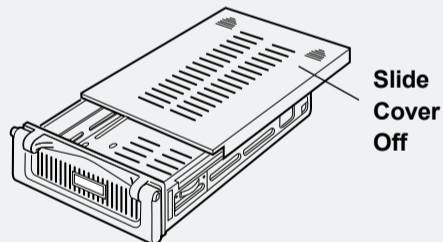

(2). If you plan to install a drive that features removable media such as a zip, TR-4 tape, MO, LS-120 drive, or ATA Flash memory reader, remove the center part of the front panel.

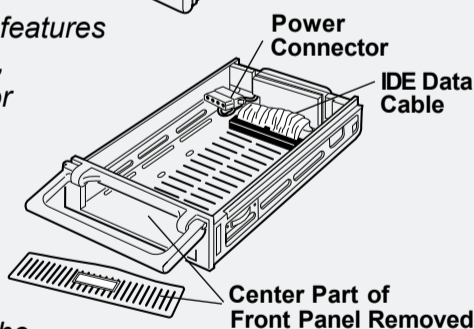

(3). Connect the cables from the Mobile Rack drive case to the appropriate pin connectors of the 3.5" IDE device. Attach the power and IDE cables from the Mobile Rack drive case to the 3.5" IDE device. The colored stripe on the IDE cable should be closest to the power connector.

(4). Carefully position the 3.5" IDE device inside the Mobile Rack drive case. Secure the device in place using the supplied mounting screws. Use the mounting holes on the sides or bottom, depending on the design of the device.

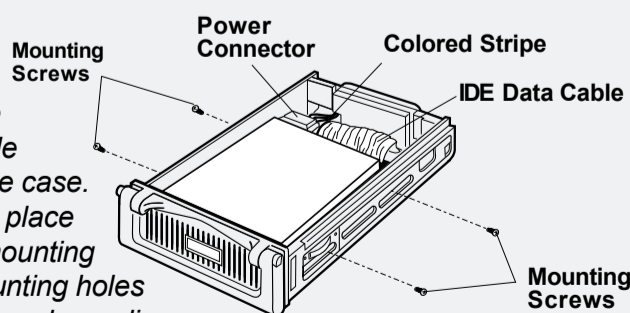

(5). Replace the drive tray cover by sliding it back on.

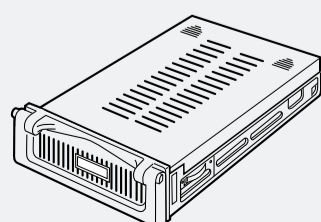

2. Using the +5V/+12V AC/DC Power Adapter:

- With the Power Select switch in the OFF position, plug in the connector-end of the power adapter into its corresponding +5V/+12V power-in connector on the VP-8258 Plus Smart Dock.
- Plug one end of the power cord into the power adapter and the other end into an AC power source outlet.

3. Set the Power Select Switch to an ON position: *Note that the green LED on the Smart Dock should be lit, indicating power ON.* This allows the device to warm up before connecting to the computer's USB Port.

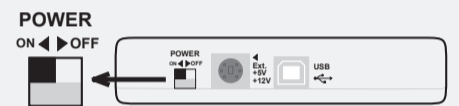

Important: All drive devices must be powered up and ready to use before plugging into the computer's USB Port.

4. Plug one end of the USB cable into the USB port on your computer; plug the other end into the USB port on the VP-8258 Plus Smart Dock.

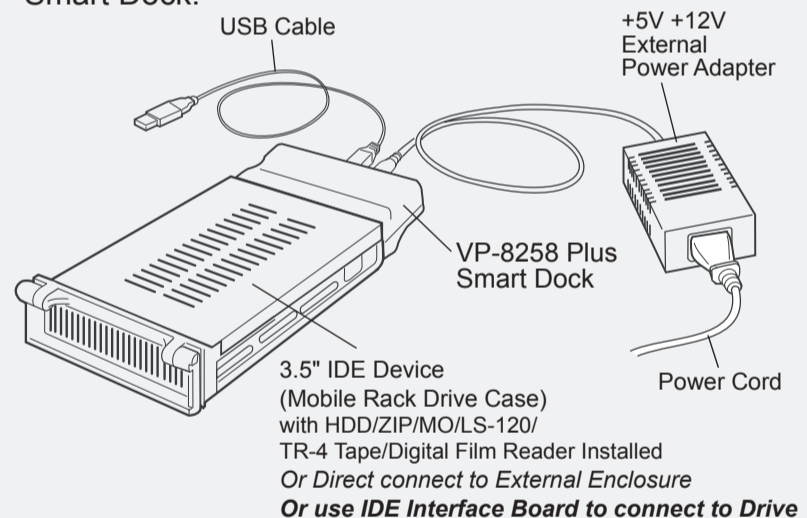

5. Viewing the screen, note that the plug-and-play feature will recognize the new device and assign it as a new drive. Hard disk drive partitions will also be auto-detected and assigned drive letters.

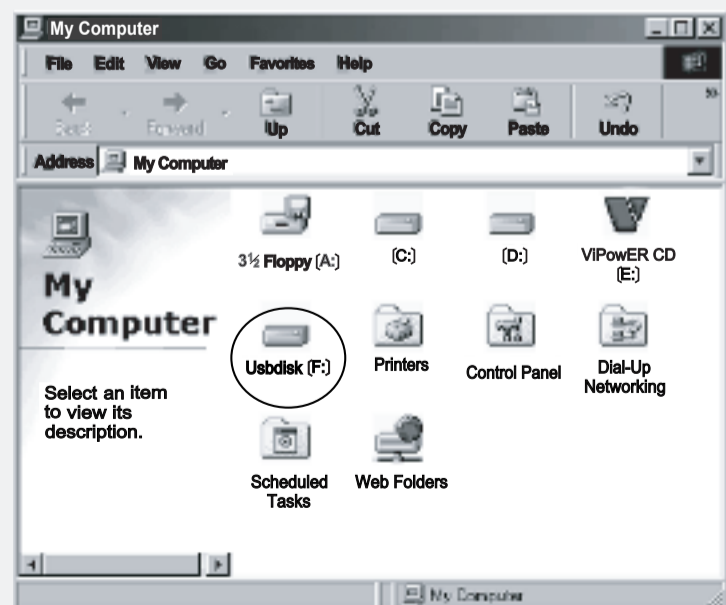

The device is now ready to use with the VP-8258 Plus Smart Dock.

Free Manuals Download Website

<http://myh66.com>

<http://usermanuals.us>

<http://www.somanuals.com>

<http://www.4manuals.cc>

<http://www.manual-lib.com>

<http://www.404manual.com>

<http://www.luxmanual.com>

<http://aubethermostatmanual.com>

Golf course search by state

<http://golfingnear.com>

Email search by domain

<http://emailbydomain.com>

Auto manuals search

<http://auto.somanuals.com>

TV manuals search

<http://tv.somanuals.com>