

# ViewSonic®

## PJD6220/PJD6230/PJD6240 DLP Projector

IMPORTANT: Please read this User Guide to obtain important information on installing and using your product in a safe manner, as well as registering your product for future service. Warranty information contained in this User Guide will describe your limited coverage from ViewSonic Corporation, which is also found on our web site at <http://www.viewsonic.com> in English, or in specific languages using the Regional selection box in the upper right corner of our website.

"Antes de operar su equipo lea cuidadosamente las instrucciones en este manual"



- User Guide
- Guide de l'utilisateur
- Bedienungsanleitung
- Guía del usuario
- Guida dell'utente
- Guia do usuário
- Användarhandbok
- Käyttöopas
- Руководство пользователя
- 使用手冊 (繁體)
- 使用手冊 (简体)

Model No. : VS11949  
VS11986  
VS11990

# Compliance Information

## FCC Statement

This device complies with part 15 of FCC Rules. Operation is subject to the following two conditions: (1) this device may not cause harmful interference, and (2) this device must accept any interference received, including interference that may cause undesired operation.

This equipment has been tested and found to comply with the limits for a Class B digital device, pursuant to part 15 of the FCC Rules. These limits are designed to provide reasonable protection against harmful interference in a residential installation. This equipment generates, uses, and can radiate radio frequency energy, and if not installed and used in accordance with the instructions, may cause harmful interference to radio communications. However, there is no guarantee that interference will not occur in a particular installation. If this equipment does cause harmful interference to radio or television reception, which can be determined by turning the equipment off and on, the user is encouraged to try to correct the interference by one or more of the following measures:

- Reorient or relocate the receiving antenna.
- Increase the separation between the equipment and receiver.
- Connect the equipment into an outlet on a circuit different from that to which the receiver is connected.
- Consult the dealer or an experienced radio/TV technician for help.

**Warning:** You are cautioned that changes or modifications not expressly approved by the party responsible for compliance could void your authority to operate the equipment.

## For Canada

- This Class B digital apparatus complies with Canadian ICES-003.
- Cet appareil numérique de la classe B est conforme à la norme NMB-003 du Canada.

## CE Conformity for European Countries

 The device complies with the requirements of the EEC directive 2004/108/EC as amended by 92/31/EEC and 93/68/EEC Art.5 with regard to “Electromagnetic compatibility”, and 2006/95/EC as amended by 93/68/EEC Art.13 with regard to “Safety.”

## Following information is only for EU-member states:

The mark shown to the right is in compliance with the Waste Electrical and Electronic Equipment Directive 2002/96/EC (WEEE).

The mark indicates the requirement NOT to dispose the equipment as unsorted municipal waste, but use the return and collection systems according to local law.



# Important Safety Instructions

1. Read these instructions.
2. Keep these instructions.
3. Heed all warnings.
4. Follow all instructions.
5. Do not use this unit near water.
6. Clean with a soft, dry cloth. If still not clean, see “Cleaning the Display” in this guide for further instructions.
7. Do not block any ventilation openings. Install the unit in accordance with the manufacturer’s instructions.
8. Do not install near any heat sources such as radiators, heat registers, stoves, or other devices (including amplifiers) that produce heat.
9. Do not defeat the safety purpose of the polarized or grounding-type plug. A polarized plug has two blades with one wider than the other. A grounding type plug has two blades and a third grounding prong. The wide blade and the third prong are provided for your safety. If the provided plug does not fit into your outlet, consult an electrician for replacement of the obsolete outlet.
10. Protect the power cord from being walked on or pinched particularly at plugs. Convenience receptacles and the point where they exit from the unit. Be sure that the power outlet is located near the unit so that it is easily accessible.
11. Only use attachments/accessories specified by the manufacturer.
12.  Use only with the cart, stand, tripod, bracket, or table specified by the manufacturer, or sold with the unit. When a cart is used, use caution when moving the cart/unit combination to avoid injury from tipping over.
13. Unplug this unit when unused for long periods of time.
14. Refer all servicing to qualified service personnel. Servicing is required when the unit has been damaged in any way, such as: if the power-supply cord or plug is damaged, if liquid is spilled onto or objects fall into the unit, if the unit is exposed to rain or moisture, or if the unit does not operate normally or has been dropped.

# Declaration of RoHS Compliance

This product has been designed and manufactured in compliance with Directive 2002/95/EC of the European Parliament and the Council on restriction of the use of certain hazardous substances in electrical and electronic equipment (RoHS Directive) and is deemed to comply with the maximum concentration values issued by the European Technical Adaptation Committee (TAC) as shown below:

Substance	Proposed Maximum Concentration	Actual Concentration
Lead (Pb)	0.1%	< 0.1%
Mercury (Hg)	0.1%	< 0.1%
Cadmium (Cd)	0.01%	< 0.01%
Hexavalent Chromium (Cr <sup>6+</sup> )	0.1%	< 0.1%
Polybrominated biphenyls (PBB)	0.1%	< 0.1%
Polybrominated diphenyl ethers (PBDE)	0.1%	< 0.1%

Certain components of products as stated above are exempted under the Annex of the RoHS Directives as noted below:

Examples of exempted components are:

1. Mercury in compact fluorescent lamps not exceeding 5 mg per lamp and in other lamps not specifically mentioned in the Annex of RoHS Directive.
2. Lead in glass of cathode ray tubes, electronic components, fluorescent tubes, and electronic ceramic parts (e.g. piezoelectronic devices).
3. Lead in high temperature type solders (i.e. lead-based alloys containing 85% by weight or more lead).
4. Lead as an alloying element in steel containing up to 0.35% lead by weight, aluminium containing up to 0.4% lead by weight and as a copper alloy containing up to 4% lead by weight.

# Copyright Information

Copyright © ViewSonic Corporation, 2008. All rights reserved.

Macintosh and Power Macintosh are registered trademarks of Apple Inc.

Microsoft, Windows, Windows NT, and the Windows logo are registered trademarks of Microsoft Corporation in the United States and other countries.

ViewSonic, the three birds logo, OnView, ViewMatch, and ViewMeter are registered trademarks of ViewSonic Corporation.

VESA is a registered trademark of the Video Electronics Standards Association. DPMS and DDC are trademarks of VESA.

PS/2, VGA and XGA are registered trademarks of International Business Machines Corporation.

Disclaimer: ViewSonic Corporation shall not be liable for technical or editorial errors or omissions contained herein; nor for incidental or consequential damages resulting from furnishing this material, or the performance or use of this product.

In the interest of continuing product improvement, ViewSonic Corporation reserves the right to change product specifications without notice. Information in this document may change without notice.

No part of this document may be copied, reproduced, or transmitted by any means, for any purpose without prior written permission from ViewSonic Corporation.

## Product Registration

To meet your future needs, and to receive any additional product information as it becomes available, please register your product on the Internet at: [www.viewsonic.com](http://www.viewsonic.com). The ViewSonic® Wizard CD-ROM also provides an opportunity for you to print the registration form, which you may mail or fax to ViewSonic.

### For Your Records

<b>Product Name:</b>	<b>PJD6220/PJD6230/PJD6240</b> <b>ViewSonic DLP Projector</b>
<b>Model Number:</b>	<b>VS11949/VS11986/VS11990</b>
<b>Document Number:</b>	<b>PJD6220_PJD6230_PJD6240_UG_ENG Rev. 1B 08-19-08</b>
<b>Serial Number:</b>	_____
<b>Purchase Date:</b>	_____



The lamp in this product contains mercury.

Please dispose of in accordance with local, state or federal laws.

## Notes on the AC Power Cord

AC Power Cord must meet the requirement of countries where you use this projector. Please confirm your AC plug type with the graphics below and ensure that the proper AC Power Cord is used. If the supplied AC Power Cord does not match your AC outlet, please contact your sales dealer. This projector is equipped with a grounding type AC line plug. Please ensure that your outlet fits the plug. Do not defeat the safety purpose of this grounding type plug. We highly recommend using a video source device also equipped with a grounding type AC line plug to prevent signal interference due to voltage fluctuations.

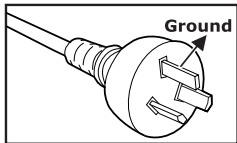

For Australia and  
Mainland China

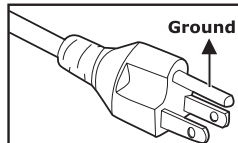

For the U.S.A. and Canada

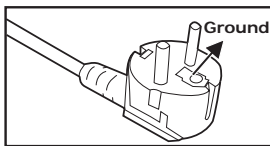

For Continental Europe

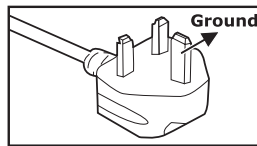

For the U.K.

# CONTENTS

<b>Introduction .....</b>	<b>1</b>
Projector Features.....	1
Package Contents.....	2
Projector Overview.....	3
<b>Using the Product .....</b>	<b>5</b>
Control Panel .....	5
Connection Ports.....	6
Remote Control .....	7
Installing the Batteries.....	8
Remote Control Operation .....	9
<b>Installation .....</b>	<b>10</b>
Connecting the Projector.....	10
Powering On/Off the Projector .....	11
Adjusting the Projector .....	12
<b>Menu Operation .....</b>	<b>14</b>
<b>Network Control.....</b>	<b>19</b>
<b>Maintenance.....</b>	<b>30</b>
Cleaning the Lens .....	30
Cleaning the Projector Housing .....	30
Replacing the Lamp .....	31
<b>Specifications .....</b>	<b>33</b>
<b>Appendix .....</b>	<b>34</b>
LED Indicator Messages .....	34
RS-232 Command and Configuration .....	35
Compatibility Modes.....	40
Troubleshooting .....	41

# Introduction

## Projector Features

The projector integrates high-performance optical engine projection and a user - friendly design to deliver high reliability and ease of use.

The projector offers the following features:

- Single chip 0.55" Texas Instruments DLP® technology
- XGA (1024 x 768 pixels)
- Auto image re-sizing (Auto-Sync.) to 1024 x 768 full screen with scaling compression compatibility for VGA, SVGA, XGA and SXGA\*
- Compatibility with Macintosh® computers
- Compatibility with NTSC, PAL, SECAM and HDTV
- D-Sub 15-pin terminal for analog video connectivity
- User-friendly, multi-language on-screen display
- Advanced electronic keystone correction
- Network function for remote management
- Closed Captioning included

A lightbulb icon with the word "NOTE" written inside it, indicating a note or important information.

*\* means compressed.*



## Package Contents

When you unpack the projector, make sure you have all these components:

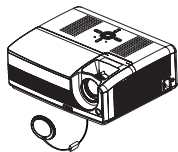

Projector with Lens Cap

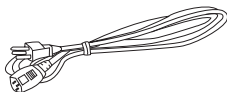

AC Power Cord

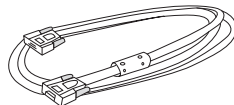

VGA Cable (D-SUB to D-SUB)



Composite Video Cable



S-Video Cable



Remote Control (IR)



AAA size batteries for remote control

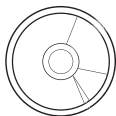

User's Manual

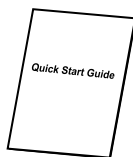

Quick Start Guide

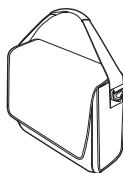

Projector Carrying Case



VGA - Component Adapter

### NOTE

- Save the original shipping carton and packing material; they will come handy if you ever to ship your unit. For maximum protection, repack your unit as it was originally packed at the factory.
- Accessories and components may vary by retailer and region.

# Projector Overview

## Front View

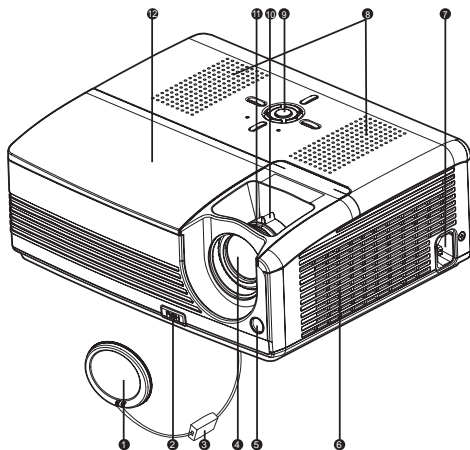

- |                                  |                   |
|----------------------------------|-------------------|
| ① Lens cap                       | ⑦ AC power socket |
| ② Elevator button                | ⑧ Speaker         |
| ③ Lens cap strap                 | ⑨ Control panel   |
| ④ Projection lens                | ⑩ Zoom ring       |
| ⑤ Front IR remote control sensor | ⑪ Focus ring      |
| ⑥ Ventilation holes              | ⑫ Lamp cover      |

## Rear View

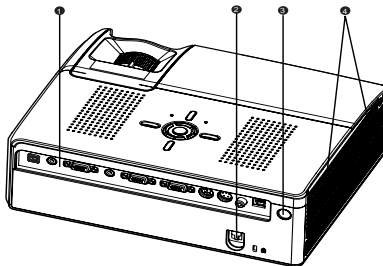

- ❶ Connection ports
- ❷ Kensington lock
- ❸ Rear IR remote control sensor
- ❹ Ventilation holes

## Bottom View

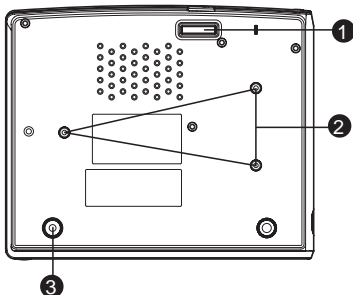

- ❶ Elevator foot
- ❷ Ceiling mount (M4 x L7.5mm)
- ❸ Tilt-adjustment foot

### NOTE

- *This projector can be used with a ceiling mount for support. The ceiling mount is not included in the package.*

# Using the Product

## Control Panel

### LED

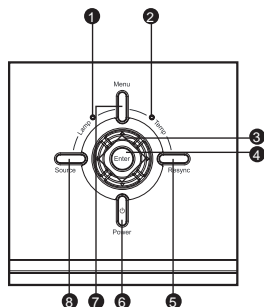

- ❶ **Lamp** (Lamp LED indicator)  
Refer to “LED Indicator Messages”.
- ❷ **Temp** (Temperature LED indicator)  
Refer to “LED Indicator Messages”.

### Button Function

- ❸ **Four directional buttons**  
Use four directional buttons to select items or make adjustments to your selection.
- ❹ **Enter**  
Enter to sub-menu and confirm the menu selection. Activate in Color Setting, Lamp Counter Reset and Factory Default menu operations.
- ❺ **Resync**  
Resynchronize the projector to the input signal from a computer.
- ❻ **Power**  
Turn the projector on or off.
- ❼ **Menu**  
Display or exit the on-screen display menus.
- ❽ **Source**  
Manually select an input source.

# Connection Ports

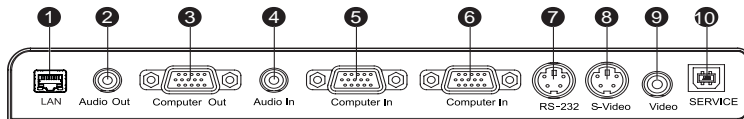

- 1 **LAN**  
For network control.
- 2 **Audio Out**  
Connect to a speaker or other audio input equipment.
- 3 **Computer Out**  
Connect to a computer display, etc.
- 4 **Audio In**  
Connect an audio output from video equipment to this jack.
- 5 **Computer In**  
Connect image input signal (analog RGB or component) to this jack.
- 6 **Computer In**  
Connect image input signal (analog RGB or component) to this jack.
- 7 **RS-232**  
When operating the projector via a computer, connect this to the controlling computer's RS-232C port.
- 8 **S-Video**  
Connect S-Video output from video equipment to this jack.
- 9 **Video**  
Connect composite video output from video equipment to this jack.
- 10 **SERVICE**  
This connector is for firmware update.

# Remote Control

- 1 Power**  
Turn the projector on or off.
- 2 Four directional buttons**  
-Use four directional buttons to select items or make adjustments to your selection.  
- The right button acts as Blank Screen function. Cut off the screen temporarily. Press again to cancel the Blank Screen function.
- 3 MENU**  
Display or exit the on-screen display menus.
- 4 Laser**  
Aim the remote at the viewing screen, press and hold this button to activate the laser pointer.
- 5 Four directional buttons**  
(Computer mode only)  
Act as computer keyboard (four directional buttons). This function is only available when the projector is connected to a computer via a USB cable.
- 6 Left** (Computer mode only)  
Act as mouse left button. This function is only available when the projector is connected to a computer via a USB cable.
- 7 ViewMatch**  
Switch in between high brightness performance or Accuracy color performance.
- 8 Source**  
Manually select an input source.
- 9 Right** (Computer mode only)  
Act as mouse right button. This function is only available when the projector is connected to a computer via a USB cable.
- 10 Enter**  
Confirm the selection.
- 11 Freeze**  
Press "Freeze" to pause the screen image.  
Press again to cancel the Freeze function.

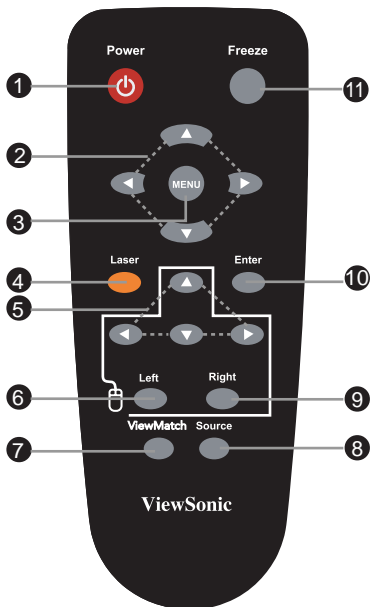

## Installing the Batteries

1. Open the battery cover in the direction shown.

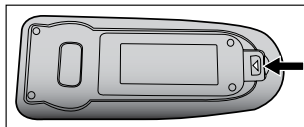

2. Install batteries as indicated by the diagram inside the compartment.

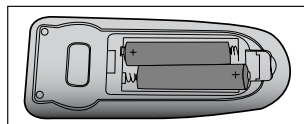

3. Close the battery cover into position.

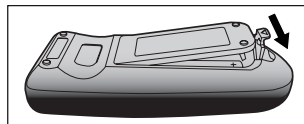

### NOTE

- *Keep the batteries out of the reach of children. There is a danger of death by accidentally swallowing the batteries.*
- *Do not recharge the used batteries or expose the batteries to fire or water.*
- *Do not dispose of the used batteries along with household waste. Dispose of used batteries according to local regulations.*
- *Danger of explosion may happen if batteries are incorrectly replaced. Replace only with the same type recommended by the manufacturer.*

## Remote Control Operation

Point the remote control at the infrared remote sensor and press a button.

- Operating the projector from the front

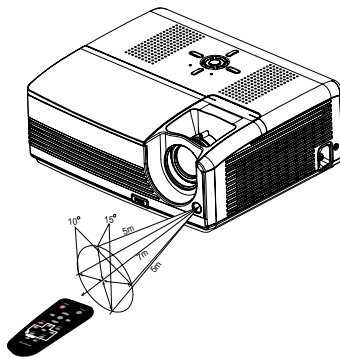

- Operating the projector from the rear

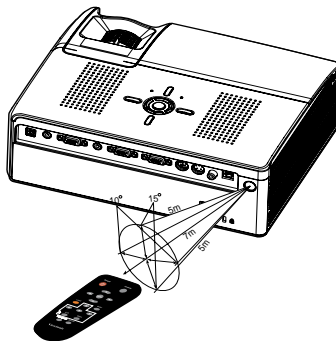

- Do not point the laser pointer directly to the people's eyes (especially small children). There is a danger of injury to the eyes.
- The remote control may not operate when there is sunlight or other strong light such as a fluorescent lamp shining on the remote sensor.
- Operate the remote control from a position where the remote sensor is visible.
- Do not drop the remote control or jolt it.
- Keep the remote control out of locations with excessively high temperature or humidity.
- Do not get water on the remote control or place wet objects on it.
- Do not disassemble the remote control.



# Installation

## Connecting the Projector

- 1 VGA Cable (D-Sub to D-Sub)
- 2 Audio Cable
- 3 RS-232 Cable
- 4 USB Cable
- 5 VGA (D-Sub) to HDTV (RCA) Cable
- 6 S-Video Cable
- 7 Composite Video Cable
- 8 Internet Cable

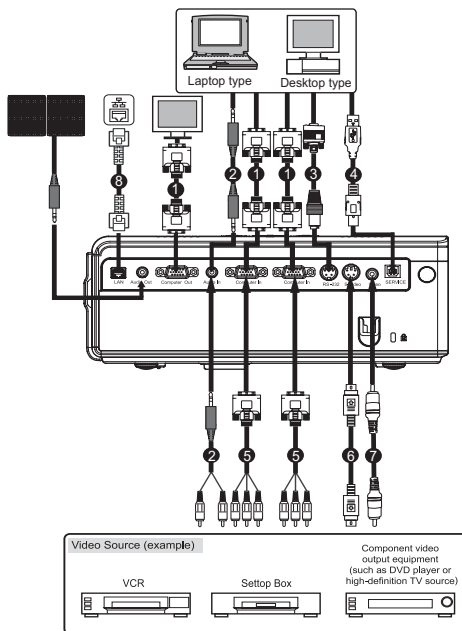

### NOTE

- When connecting cable, power cords of both a projector and external equipment should be disconnected from AC outlet.
- The figure above is a sample connection. This does not mean that all of these devices can or must be connected simultaneously.
- The cables that come with the projector may differ from the above illustration. The included cables are based on actual shipment delivery.

## Powering On/Off the Projector



### Powering On the Projector:

1. Remove the projector lens cap.
2. Complete the AC power cord and peripheral signal cable(s) connections.
3. Press  button to turn on the projector.  
The projector takes a minute or so to warm up.
4. Turn on your source (computer, notebook, DVD, etc.). The projector automatically detects your source.
  - If you are connecting multiple sources to the projector simultaneously, press the **Source** button.

#### Warning:

- Remove the lens cap first before powering on.
- Never look into the lens when the lamp is on. This can damage your eyes. It is especially important that children are not allowed to look into the lens.

### Powering Off the Projector:

1. Press  button to turn off the projector lamp. You will see a message "Power off? Press Power again" appear on the screen.
2. Press  button again to confirm.
  - The cooling fans continue to operate for cooling cycle.
  - When the Lamp LED begins flashing, the projector has entered stand-by mode.
  - If you want to turn the projector back on, you must wait until the projector has completed the cooling cycle and has entered stand-by mode. Once in stand-by mode, simply press  button to restart the projector.
3. Disconnect the AC power cord from the electrical outlet and the projector.
4. Do not turn on the projector immediately following a power off procedure.

## Adjusting the Projector

### Adjusting the Projector Height

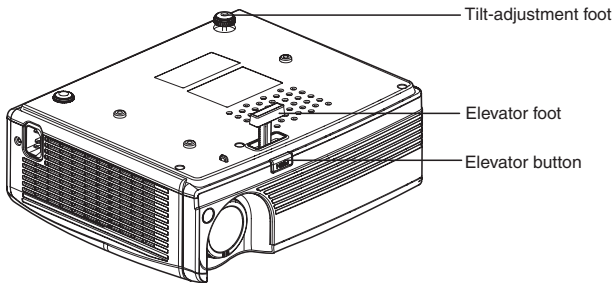

The projector is equipped with an elevator foot to adjust the image height. To raise or lower the image:

1. To raise or lower the image, press the elevator button and raise or lower the front of the projector. Release the button to lock the adjustment.
2. To level the image on the screen, turn the tilt-adjustment foot to fine-tune the height.

**NOTE**

- To avoid damaging the projector, make sure that the elevator foot and tilt-adjustment foot are fully retracted before placing the projector in its carrying case.

### Adjusting the Projector Zoom and Focus

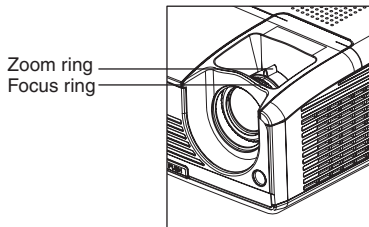

1. Focus the image by rotating the focus ring. A still image is recommended for focusing.
2. Adjust the image by sliding the zoom ring.

## Adjusting Projection Image Size

Refer to the graphic and table below to determine the screen size and projection distance.

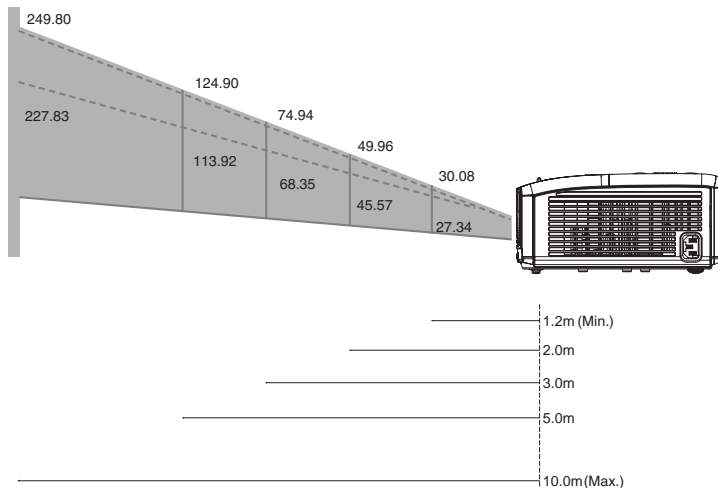

Projection Distance (meters)	Screen Size (for 4:3 aspect ratio diagonal length)	
	Wide (inches)	Tele (inches)
1.2	30.08	27.34
2	49.96	45.57
3	74.94	68.35
5	124.90	113.92
10	249.80	227.83

### NOTE

- Position the projector in a horizontal position; other positions can cause heat build-up and damage to the projector.
- Make sure the heat ventilation holes are not blocked.
- Do not use the projector in a smoky environment. Smoke residue may cause build-up on critical parts (i.e. DMD, lens assembly, etc.)

# Menu Operation

The projector has multilingual on-screen display menus that allow you to make image adjustments and change a variety of settings.

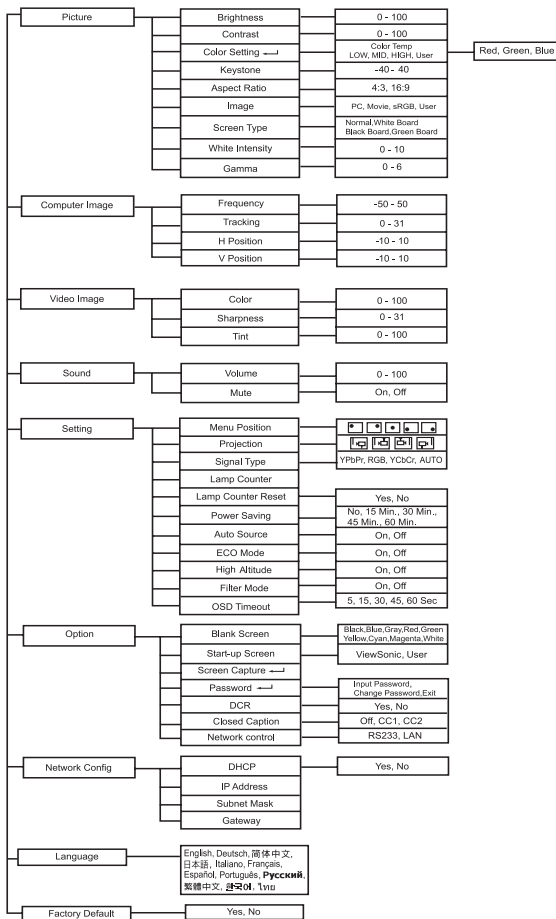

## How to operate

1. Press the **Menu** button on the control panel or the **MENU** button on the remote control to open the OSD menu.
2. When OSD is displayed, use ▲ / ▼ to select any feature in the main menu.
3. After selecting the desired main menu feature, press ► to enter sub-menu for feature setting.
4. Adjust the settings with ◀ / ▶.
5. Press the **Menu** button on the control panel or the **MENU** button on the remote control, the screen will return to the main menu.
6. To exit OSD, press the **Menu** button on the control panel or the **MENU** button on the remote control again. The OSD menu will close and the projector will automatically save the new settings.

## Picture (Computer / Video Mode)

### Brightness

Brighten or darken the image.

### Contrast

Set the difference between light and dark areas.

### Color Setting

Adjust the color temperature. At higher temperature the screen looks colder; at lower temperature, the screen looks warmer. If you select "User", "Red", "Green" and "Blue" can be adjusted.

### Keystone

Correct the keystone distortion.

### Aspect Ratio

Select how the picture fits on the screen:

- 4:3 : The input source will be scaled to fit the projection screen.
- 16:9 : The input source will be scaled to fit the width of the screen.

### Image

There are many factory presets optimized for various types of images.

- PC : For computer or notebook.
- Movie : For home theater.
- sRGB : For PC standard color.
- User : Memorize user's settings.

### Screen Type

Select the projection screen type.

### White Intensity

Increase the brightness of white areas.

## **Gamma**

Effect the represent of dark scenery. With greater gamma value, dark scenery will look brighter.

## **Computer Image (Computer Mode)**

### **Frequency**

Adjust the timing of the projector relative to the computer.

### **Tracking**

Adjust the phase of the projector relative to the computer.

### **H Position (Horizontal Position)**

Adjust the image left or right within the projection area.

### **V Position (Vertical Position)**

Adjust the image up or down within the projection area.

## **Video Image (Video Mode)**

### **Color**

Adjust the intensity of colors.

### **Sharpness**

Sharpen or soften the image.

### **Tint**

Shift colors toward red or green.

## **Sound (Computer / Video Mode)**

### **Volume**

Adjust the volume level.

### **Mute**

Cut off the sound temporarily.

## **Setting (Computer / Video Mode)**

### **Menu Position**

Choose the menu location on the display screen.

### **Projection**

Adjust the picture to match the orientation of the projector: upright or upside-down, in front of or behind the screen. Invert or reverse the image accordingly.

### **Signal Type**

Specify the source to the Computer In terminal that you wish to project.

- Auto : Automatically choose the most suitable chroma subsampling scheme.  
Recommended!!
- YPbPr : For component 480p,576p,720p,1080i signals.
- RGB : For RGB video format. No subsampling. All information is accurately transmitted.
- YCbCr : For component 480i,576i signals.

**Lamp Counter**

Display the lamp's elapsed operating time (in hours).

**Lamp Counter Reset**

Reset the lamp counter to 0 hours.

**Power Saving**

If no operation is performed for a specific period of time, the power to the projector is automatically turned off.

**Auto Source**

Automatically scan the input source.

**ECO Mode**

Use this function to dim the projector lamp light output which will lower power consumption and increase lamp life.

**High Altitude**

Turning on High Altitude mode operates the fans at full speed continuously to allow for proper high altitude cooling of the projector.

**Filter Mode**

When an optional air filter is attached, be sure to turn on the "Filter Mode"; otherwise, the machine can overheat and shutdown automatically.

**OSD Timeout**

Duration OSD menu stays active (at idle state by second).

**Option (Computer / Video Mode)****Blank Screen**

Blank the screen temporarily, and select the screen color when this function is active.

**Start-up Screen**

Select start-up screen when the projector is powered on or when no signal is input. "User" is the screen that you captured.

**Screen Capture**

Capture the current projection screen as a start-up screen.

**Password**

Set or change the password. When the password function is added, image projection requires an entry of the preset password at power-on.

**DCR (Dynamic Contrast Ratio)**

Enable DCR will further enhance contrast ratio by darkening the black scenes. Disable DCR will resume to normal contrast performance. DCR will impact lamp life and system noise performance.

**Closed Caption (Video and S-Video sources only)**

Enable or Disable closed captions by selecting CC1 (closed caption 1, the most common channel), CC2 or OFF.



## Network Control

Select either RS232 or LAN for network control. If RS232 is selected, user will not able to control the projector via LAN network and vice versa.

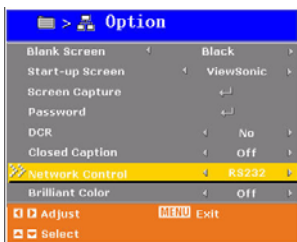

## Network Config

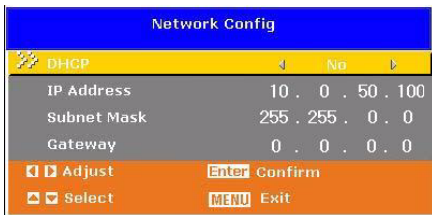

### DHCP

- Enable: Assign an IP address to the projector from the DHCP server automatically.
- Disable: Assign an IP address manually.

### IP Address

Select an IP address.

### Subnet Mask

Select subnet mask number.

### Gateway

Select the default gateway of the network connected to the projector.

### Language (Computer / Video Mode)

Select the language used by the on-screen menu.

### Factory Default (Computer / Video Mode)

Restore all menu settings to factory default settings.

# Network Control

This feature provides the ability to remotely control and manage the projector through the network.

**Note:** 1024x768 viewing resolution is recommended.

## Preparation:

1. Connect one end of the internet cable to the LAN connector on projector.
2. Connect the other end of the internet cable to an available LAN connector on the RJ45 outlet.
3. Make sure the PC/NB is also connected to the internet.
4. Turn on the projector and computer.

**There are two ways to connect to the network control:**

### A. Auto IP address setting (DHCP):

1. Enable DHCP from the projector OSD, under Network Config.

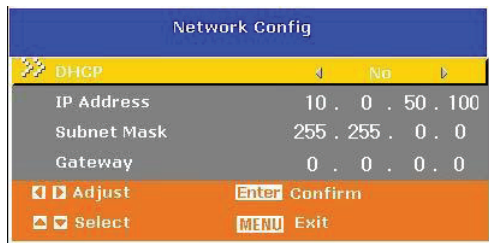
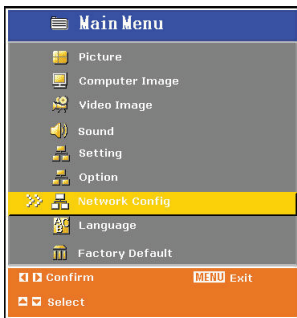

2. Please wait for the PC server to release IP address to the projector. DHCP icon will pop up on the bottom right corner, once the IP address is received by the projector. (It will take approx. 15 ~ 20 seconds).
3. Enter “Given IP address (For example <http://10.0.50.100/>)” into the address bar of the web browser and press “Enter” key or click “Go” button.

### B. Manual IP address setting:

1. From your computer, go to **Start > Control Panel > Network Connection** and right click to select **Properties**.

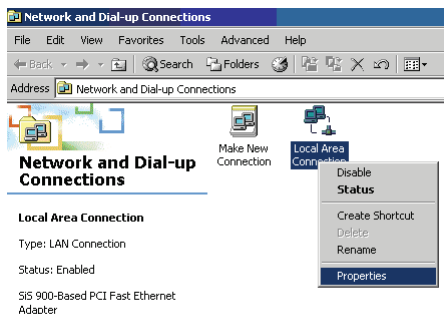

2. Select “Intel Protocol (TCP/IP)” and click “Properties”.

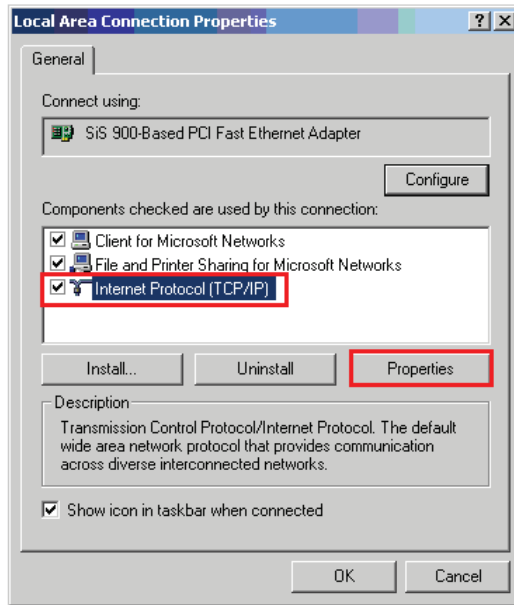

3. Set your IP address on your computer, and click **OK**.

- Click “Use the following IP address”
- **IP address: 10.0.50.105**, (set the last number different to the projector IP address).
- **Subnet mask: 255.255.0.0**

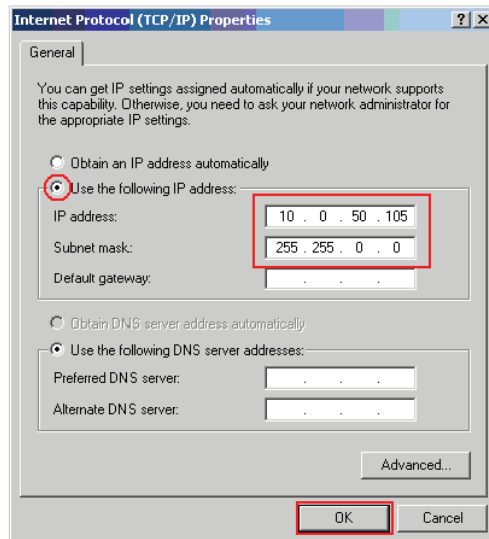

- Enter “**http://10.0.50.100/**” into the address bar of the web browser and press “Enter” key or click “Go” button.



- After the connection is completed, the control screen will be as below

**ViewSonic**  **Projector Network Control** V0.46

---

Status
Control Panel
Network
Alert Setting
Schedule
Logout

---

**Status**

**IP Address:** 172.21.2.152  
**Group Name:** 123456  
**Projector Name:** PJD6230  
**System Status:** Inactive  
**Input Source:**  
**Lamp Hours:**  
**Filter Hours:**  
**Projector Status:** Normal  
**Date(y/m/d):** 2008/07/03  
**Time:** 15:22:11

**Authority on the network control of Administrator & User:**

Item	Description	Administrator	User
Status	Show current projector status and network configuration settings.	√	√
Date & Time Setting	Date & Time setting by user.	√	×
Control Panel	Control the projector via network.	√	√
Network	Network configuration & Password setup.	√	×
Alert Setting	Show and setup Alert configurations.	√	×
Schedule	Show and setup Scheduling configurations.	√	×

## Login

Enter “<http://10.0.50.100/>” into the address bar of the web browser and press “Enter” key or click “Go” button.

If the administrative and user password is disabled, it will directly go into the Status page.

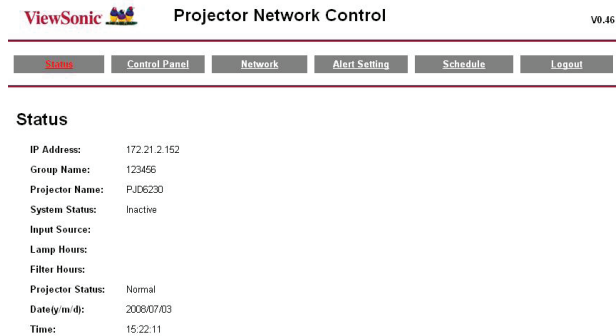

The screenshot shows the 'Status' page of the ViewSonic Projector Network Control interface. At the top, there is a navigation bar with buttons for 'Status', 'Control Panel', 'Network', 'Alert Setting', 'Schedule', and 'Logout'. The 'Status' page displays the following information:

IP Address:	172.21.2.152
Group Name:	123456
Projector Name:	PJD6230
System Status:	Inactive
Input Source:	
Lamp Hours:	
Filter Hours:	
Projector Status:	Normal
Date(y/m/d):	2008/07/03
Time:	15:22:11

## If the Administrative & User password is enabled

Select your User Name and enter password to login.



The screenshot shows the 'Login' page of the ViewSonic Projector Network Control interface. At the top, there is a navigation bar with buttons for 'Status', 'Control Panel', 'Network', 'Alert Setting', 'Schedule', and 'Logout'. The 'Login' page displays the following information:

Projector Name: PJD6230

Login

User Name: administrator

Password: |

Submit

## Status Information:

The screenshot shows the ViewSonic Projector Network Control interface. At the top left is the ViewSonic logo, and at the top right is the version number 'V0.46'. Below the title bar is a navigation menu with buttons for 'Status', 'Control Panel', 'Network', 'Alert Setting', 'Schedule', and 'Logout'. The 'Status' button is highlighted. The main content area displays the following status information:

**Status**

IP Address: 172.21.2.152  
Group Name: 123456  
Projector Name: PJD6230  
System Status: Power ON  
Input Source: S-Video  
Lamp Hours: 21 hrs  
Filter Hours: 0 hrs  
Projector Status: Normal  
Date(y/m/d): 2008/07/03  
Time: 15:30:48

All screen images in this manual are shown when you login with the Administrator ID. The image will differ if you login with User ID.

Item	Description
IP Address	Show current IP address.
Group Name	Show group name.
Projector Name	Show projector name.
System Status	Show if projector is Power On or Inactive *.
Input Source	Show current input source.
Lamp Hours	Show lamp used hours on current projector.
Filter Hours	Show filter used hours on current projector.
Projector Status	Show current projector status, either function normally or error found.
Date(y/m/d)	Show date set on current projector.
Time	Show time set on current projector.

\* when system status shows “Inactive”, it could either mean the projector is “Power Off”, or projector’s network control is set to be RS232 (Please refer to Network Control, Page 18 to link with the project).

# Control Panel

ViewSonic 
Projector Network Control
v0.46

Status
Control Panel
Network
Alert Setting
Schedule
Logout

### Control Panel

**Date Setting:** 2008 July 2 15:40

**Time Setting:**

Projector Name: PJD6230	Audio	Option	
Power: <input type="button" value="Power Off"/>	Volume: 50	ViewMatch: <input type="button" value="OFF"/>	
Input Source: <input type="button" value="Computer 2"/>	Mute: <input type="button" value="OFF"/>	White Intensity: 10	
<b>Picture</b>	<b>Setting</b>	Gamma: 0	
Brightness: 50	Menu Position: <input type="button" value="Top Left"/>	Signal Type: <input type="button" value="AUTO"/>	
Contrast: 50	Projection: <input type="button" value="Front-Desk"/>	Fiber Mode: <input type="button" value="OFF"/>	
Color Temperature: MID	Auto Source: ON	Power Saving: <input type="button" value="NO"/>	
Keystone: 0	ECO Mode: <input type="button" value="OFF"/>	Start UP Screen: <input type="button" value="ViewSonic"/>	
Picture Mode: PC	High Altitude: <input type="button" value="OFF"/>	Closed Caption: <input type="button" value="OFF"/>	
Aspect Ratio: 4:3	OSD Timeout: 30 Sec.	Blank Screen: <input type="button" value="OFF"/>	
Freeze: <input type="button" value="OFF"/>	Language: <input type="button" value="English"/>		
<b>Computer Image</b>	Factory Default: <input type="button" value="NO"/>		
Frequency: 0			
Tracking: 6			
H Position: 0			
V Position: 0			
<b>Video Image</b>			
Color: 128			
Tint: 128			
Sharpness: 128			

Item	Description
<b>Date Setting</b>	Update date setting on the projector.
<b>Time Setting</b>	Update time setting on the projector. Click "Enter" button to save the settings.
<b>Projector Name</b>	Show projector name on the current projector.
<b>Power</b>	Power On or Power Off the projector via network.
<b>Input Source</b>	Select input source.
<b>Picture</b>	
Brightness	Adjusts the brightness setting.
Contrast	Adjusts the contrast setting.
Color Temperature	Selects the color temperature setting.
Keystone	Adjusts the keystone setting.
Picture Mode	Selects the picture mode setting.
Aspect Ratio	Selects the aspect ratio setting.
Freeze	Enable or disable the freeze function.
<b>Computer Image</b>	
Frequency	Adjusts the frequency.
Tracking	Adjusts the tracking.
H Position	Adjusts the horizontal position.
V Position	Adjusts the vertical position.

<b>Video Image</b>	
Color	Adjusts the color setting.
Tint	Adjusts the tint setting.
Sharpness	Adjusts the sharpness setting.
<b>Audio</b>	
Volume	Adjusts the volume setting.
Mute	Enable or disable the mute function.
<b>Setting</b>	
Menu Position	Adjusts the menu position.
Projection	Selects the projection setting.
Auto Source	Enable or disable the auto source function.
ECO mode	Enable or disable the ECO function.
High Altitude	Enable or disable the high altitude function.
OSD Timeout	Selects the OSD timeout setting.
Language	Selects preferred OSD language.
Factory Default	Enable or Disable factory default.
<b>Option</b>	
ViewMatch	Enable or disable ViewMatch.
White Intensity	Selects the white intensity setting.
Gamma	Selects the Gamma setting.
Signal Type	Selects the signal type setting.
Filter Mode	Enable or disable filter mode.
Power Saving	Selects the power saving setting.
Start-up Screen	Selects the start-up screen setting.
Closed Caption	Selects the closed caption setting.
Blank screen	Enable or disable blank function.



■ *If the adjustment did not display properly. Please “refresh” or “reload” the browser again.*



**Network**

<b>Network</b>	<input checked="" type="radio"/> DHCP	<input type="radio"/> Manual	<b>Password</b>	<input type="radio"/> Enable	<input checked="" type="radio"/> Disable
IP Address	<input type="text" value="172.21.2.152"/>		Administrator	<input type="text"/>	
Subnet Mask	<input type="text" value="255.255.0.0"/>		New Password	<input type="text"/>	
Gateway	<input type="text" value="172.21.3.1"/>		Confirm Password	<input type="text"/>	
DNS Server	<input type="text" value="172.21.1.27"/>		User	<input type="text"/>	<input type="radio"/> Enable <input checked="" type="radio"/> Disable
Group Name	<input type="text" value="123456"/>		New Password	<input type="text"/>	
Projector Name	<input type="text" value="PJD6230"/>		Confirm Password	<input type="text"/>	
	<input type="button" value="Submit"/>			<input type="button" value="Submit"/>	

Item	Description
<b>Network</b>	
DHCP	Assign an IP address to the projector from the DHCP server automatically.
Manual	Assign an IP address manually.
IP Address	Setup IP address when DHCP is disable.
Subnet Mask	Setup subnet mask when DHCP is disable.
Gateway	Setup gateway when DHCP is disable.
DNS Server	Setup DNS server address when DHCP is disable.
Group Name	Create projector group. (Max length: 6 characters)
Projector Name	Create projector naming of the current projector. (Max length: 16 characters)
<b>Password</b>	
Administrator -Enable	Enable administrative password function.
Administrator -Disable	Disable administrative password function.
New Password	Setup administrative password. (Max length: 4 characters)
Confirm Password	Re-enter administrative password.
User - Enable	Enable user password function.
User - Disable	Disable user password function.
New Password	Setup user password. (Max length: 4 characters)
Confirm Password	Re-enter user password.

Click "Submit" button to save the settings.

■ *If password is lost, please contact local ViewSonic customer support.*

# Alert Setting



## Alert Setting

<b>Email Setting</b>	<b>SMTP Setting</b>	<b>Alert Condition</b>
To <input type="text"/>	Server <input type="text"/>	<input checked="" type="checkbox"/> Fan Lock
Cc <input type="text"/>	User Name <input type="text"/>	<input checked="" type="checkbox"/> Over Temperature
Subject <input type="text" value="ViewSonic-PJD6230 Alert"/>	Password <input type="text"/>	<input checked="" type="checkbox"/> Lamp Fail
From <input type="text" value="test.mail@viewsonic.com"/>		<input checked="" type="checkbox"/> Lamp Time Alert
		<input checked="" type="checkbox"/> Schedule Execution Error
		<input type="button" value="Submit"/> <input type="button" value="Issue Test Mail"/>

Item	Description
<b>Email Setting</b>	
To	Setup the mail alert attendee. (Max length: 40 characters)
Cc	Setup the backup mail alert attendee. (Max length: 40 characters)
Subject	Setup the subject of the alert e-mail. (Max length: 30 characters)
From	Setup the sender e-mail address. (Max length: 40 characters)
<b>SMTP Setting</b>	
Server	To enter the SMTP server (Mail server) name of the company. For example: mail.viewsonic.com (Max length: 30 characters)
User Name	Enter user name of the sender's e-mail account. (Max length: 20 characters)
Password	Enter password of the sender's e-mail account. (Max length: 14 characters)
<b>Alert Condition</b>	
Fan Lock	The cooling fan is not operating.
Over Temperature	The projector internal is over heated.
Lamp Fail	The lamp does not light up.
Lamp Time Alert	Lamp is approaching the end of its useful life in full power operation. Replacement is suggested.
Schedule Execution Error	Schedule Execution Error.

Click "Submit" button to save the settings, then click "Issue Test Mail" to send a test mail to check whether all settings and functions are correct.

## Schedule

The schedule function is divided into two scheduling categories, as shown below:

**Weekly Schedule:** defines the date of each week will execute the command

**ViewSonic**  **Projector Network Control** V0.46

---

**Status** **Control Panel** **Network** **Alert Setting** **Schedule** **Logout**

---

**Weekly Schedule** **Specific Day**

### Weekly Schedule

Power On Time:  0 : 0 : 0  
Input Source:

Power Off Time:  0 : 0 : 0

NO.	Week	Power On	Power Off	Input Source	Cancel
1	Thursday	12:07	12:31	Composite	<input type="button" value="Cancel"/>
2	Everyday	8:00	10:00	Computer 1	<input type="button" value="Cancel"/>
3					<input type="button" value="Cancel"/>
4					<input type="button" value="Cancel"/>
5					<input type="button" value="Cancel"/>

Click “Submit” button to create new schedule. To delete schedule, click “Cancel”.

**Specific Day:** defines the month and day that will execute the command.

**ViewSonic**  **Projector Network Control** V0.46

---

**Status** **Control Panel** **Network** **Alert Setting** **Schedule** **Logout**

---

**Weekly Schedule** **Specific Day**

### Specific Day

Power On Time:  2008 / January / 1 : 0 : 0  
Input Source:

Power Off Time:  2008 / January / 1 : 0 : 0

NO.	Power On	Power Off	Input Source	Cancel
1	2008/1/3 13:00	2008/1/3 14:00	Computer 1	<input type="button" value="Cancel"/>
2				<input type="button" value="Cancel"/>
3				<input type="button" value="Cancel"/>
4				<input type="button" value="Cancel"/>
5				<input type="button" value="Cancel"/>

Click “Submit” button to create new schedule. To delete schedule, click “Cancel”.

## Logout:



**Logout.**

**Please click Go or Refresh to re-login Network Control.**

# Maintenance

The projector needs proper maintenance. You should keep the lens clean as dust, dirt or spots will project on the screen and diminish image quality. If any other parts need replacing, contact your dealer or qualified service personnel. When cleaning any part of the projector, always switch off and unplug the projector first.

Warning:

Never open any of the covers on the projector. Dangerous electrical voltages inside the projector can cause severe injury. Do not attempt to service this product yourself. Refer all servicing to qualified service personnel.

## Cleaning the Lens

Gently wipe the lens with lens cleaning paper. Do not touch the lens with your hands.

## Cleaning the Projector Housing

Gently wipe with a soft cloth. If dirt and stains are not easily removed, use a soft cloth dampened with water, or water and neutral detergent, and wipe dry with a soft, dry cloth.



- *Turn off the projector and remove the AC power cord from the power outlet before beginning maintenance work.*
- *Make sure the lens is cool before cleaning.*
- *Do not use detergents or chemicals other than those noted above. Do not use benzene or thinners.*
- *Do not use chemical sprays.*
- *Use a soft cloth or lens paper only.*

## Replacing the Lamp

As the projector operates over time, the brightness of the projector lamp gradually decreases and the lamp becomes more susceptible to breakage. We recommend replacing the lamp if a warning message is displayed. Do not attempt to replace the lamp yourself. Contact the qualified service personnel for replacement.



- *The lamp becomes high temperature after turning off the projector with the power button. If you touch the lamp, you may scald your finger. When you replace the lamp, wait for at least 45 minutes for the lamp to cool down.*
- *Do not touch the lamp glass at any time. The lamp may explode due to improper handling, including the touching of the lamp glass.*
- *Lamp lifetime may differ from lamp to lamp and according to the environment of use. There is no guarantee of the same lifetime for each lamp. Some lamps may fail or terminate their lifetime in a shorter period of time than other similar lamps.*
- *A lamp may explode as a result of vibration, shock or degradation as a result of hours of use as its lifetime draws to an end. Risk of explosion may differ according to the environment or conditions in which the projector and lamp are being used.*
- *Wear protective gloves and eyeglasses when fixing or detaching the lamp.*
- *Faster on-off-cycles will damage the lamp and reduce lamp life. Wait at least for 5 minutes to turn off the projector after powering on.*
- *Do not operate the lamp in proximity to paper, cloth, or other combustible material nor cover it with such materials. Otherwise it could cause a fire.*
- *Do not operate the lamp in an atmosphere containing an inflammable substance, such as thinner. Otherwise it could cause a fire or explosion.*
- *Thoroughly ventilate the area or the room when operating the lamp in an oxygen atmosphere (in the air). If ozone is inhaled, it could cause headaches, nausea, dizziness, etc.*
- *The inorganic mercury is involved in the lamp. If the lamp bursts, the mercury inside the lamp will go out of the projector. Leave the area immediately if the lamp shatters while being operated and ventilate the area for at least 30 minutes in order to avoid the inhalation of mercury fumes. Otherwise it could be harmful to user's health.*

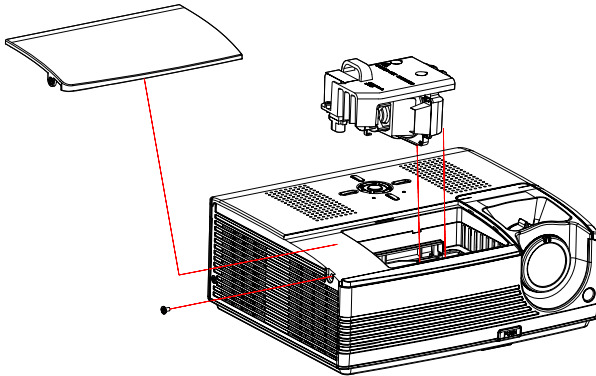

1. Turn off the projector.
2. If the projector is installed in a ceiling mount, remove it from the mount.
3. Unplug the power cord.
4. Loosen the screw in the side of the lamp cover and remove the cover.
5. Remove the screws from the lamp module, raise the handle, and lift out the module.
6. Insert the new lamp module into the projector and tighten the screws.
7. Replace the lamp cover and tighten the screw.
8. Turn on the projector. If the lamp does not turn on after the warm-up period, reinstall the lamp.
9. Reset the lamp hour. Refer to the "Setting" menu.



- *Dispose of the used lamp according to local regulations.*
- *Ensure that screws are tightened properly. Screws not tightened fully may result in injury or accidents.*
- *Since the lamp is made of glass, do not drop the unit and do not scratch the glass.*
- *Do not reuse the old lamp. This could cause the lamp to explode.*
- *Be sure to turn off the projector and unplug the AC power cord before replacing the lamp.*
- *Do not use the projector with the lamp cover removed.*

# Specifications

Display Type	Single 0.55" DLP panel
Resolution (Pixels)	XGA (1024 x 768)
Lens	Manual Zoom (1.1x)
Screen Size	30" – 250"
Lamp	PJD6220: 180W; PJD6230: 200W; PJD6240: 260W
Input / Output Source	D-Sub 15 pin, S-video, composite video, USB, RS-232, Audio In, Audio Out, LAN (RJ-45 connector)
Speaker	10 W (5W x 2)
Video Compatibility	NTSC 3.58, NTSC4.43 PAL-60, M, N SECAM, HDTV (480i/p, 576i/p, 720p, 1080i)
Scanning Frequency	
Horizontal Freq.	31 - 79 KHz
Vertical Freq.	50 - 85 Hz
Environment	Operating: Temperature: 5°C to 35°C Humidity: 30%-85% Storage: Temperature: -20°C to 60°C Humidity: 30%-85%
Power Requirement	AC 100 - 240 V, 50 - 60 Hz
Dimension	271 x 223 x 110 mm
Weight	2.9 kg (6.4lb)

Note: Design and Specifications are subject to change without prior notice.



# Appendix

## LED Indicator Messages

LED Type	Color	Status	Meaning
LAMP LED TEMP LED	Green Off	Flash -	The projector is in standby mode.
LAMP LED TEMP LED	Green Green	Solid Flash	The projector system has some problems with its fan, so the projector cannot start up.
LAMP LED TEMP LED	Green Green	Solid Solid	The lamp is in good condition and is projecting at maximum brightness.
LAMP LED TEMP LED	Amber Green	Solid Solid	The lamp has reached its end of life and must be changed soon. The lamp will continue to operate until it fails. Change the lamp. If the lamp is off, then the ballast will become malfunction.
LAMP LED TEMP LED	Amber Amber	Solid Solid	The projector is shutting and the fan motor is cooling the lamp for shutdown. Do not unplug the power cord or turn the power off before the Lamp LED changes to flashing. The fan motor will turn off when the lamp has cooled.
LAMP LED TEMP LED	Green Red	Solid Flash	Temperature is too high. The lamp will turn off. The fan motor is cooling the lamp.
LAMP LED TEMP LED	Amber Off	Solid -	The lamp ignition failed. If temperature is too high, the fans will cool the lamp.

# RS-232 Command and Configuration

## RS232 Serial Remote Control Command

Item	Description	Comment
Baud Rate	19200	
Parity Bit	none	
Data Bit	8	
Stop Bit	1	
Assign Port	COM1	

## Power On Command

Send String	BE, EF, 10, 05, 00, C6, FF, 11, 11, 01, 00, 01, 00
Response	06
Comment	

## Power Off Command

Send String	BE, EF, 03, 06, 00, DC, DB, 69, 00, 00, 00, 00, 00
Response	06

## Source Command

Send String	BE, EF, 02, 06, 00, 57, D0, 2E, 00, 00, 00, 00, 00
Response	06
Comment	

## Auto-Sync Command

Send String	BE, EF, 02, 06, 00, 86, D1, 2F, 00, 00, 00, 00, 00
Response	06
Comment	

## Menu(for OSD) Command

Send String	BE, EF, 02, 06, 00, E9, D3, 30, 00, 00, 00, 00, 00
Response	06
Comment	

## Up (for OSD) Command

Send String	BE, EF, 02, 06, 00, 6D, D2, 34, 00, 00, 00, 00, 00
Response	06
Comment	

**Down (for OSD) Command**

Send String	BE, EF, 02, 06, 00, 0B, D2, 32, 00, 00, 00, 00, 00
Response	06
Comment	

**Left (for OSD) Command**

Send String	BE, EF, 02, 06, 00, DA, D3, 33, 00, 00, 00, 00, 00
Response	06
Comment	

**Right (for OSD) Command**

Send String	BE, EF, 02, 06, 00, 38, D2, 31, 00, 00, 00, 00, 00
Response	06
Comment	

**Blank Screen Command**

Send String	BE, EF, 02, 06, 00, DF, DF, 66, 00, 00, 00, 00, 00
Response	06
Comment	

**Keystone Command**

Send String	BE, EF, 02, 06, 00, 3D, DE, 64, 00, 00, 00, 00, 00
Response	06
Comment	

**Keystone Up Command**

Send String	BE, EF, 03, 06, 00, 10, DB, 65, 00, 00, 00, 00, 00
Response	06
Comment	

**Keystone Down Command**

Send String	BE, EF, 03, 06, 00, 23, DB, 66, 00, 00, 00, 00, 00
Response	06
Comment	

**Image Command**

Send String	BE, EF, 03, 06, 00, F2, DA, 67, 00, 00, 00, 00, 00
Response	6
Comment	

**ViewMatch** Command

Send String	BE,EF,03,06,00,38,5A,88,00,00,00,00
Response	6
Comment	

**Aspect Ratio** Command

Send String	BE, EF, 03, 06, 00, 0D, DA, 68, 00, 00, 00, 00, 00
Response	06
Comment	

**ECO On** Command

Send String	BE, EF, 03, 06, 00, EF, DB, 6A, 00, 00, 00, 00, 00
Response	06
Comment	

**ECO Off** Command

Send String	BE, EF, 03, 06, 00, 3E, DA, 6B, 00, 00, 00, 00, 00
Response	06
Comment	

**Auto Source On** Command

Send String	BE, EF, 03, 06, 00, 89, DB, 6C, 00, 00, 00, 00, 00
Response	06
Comment	

**Auto Source Off** Command

Send String	BE, EF, 03, 06, 00, 58, DA, 6D, 00, 00, 00, 00, 00
Response	06
Comment	

**Factory Reset** Command

Send String	BE, EF, 03, 06, 00, 6B, DA, 6E, 00, 00, 00, 00, 00
Response	06
Comment	

**Lamp Hour** Command

Send String	BE, EF, 03, 06, 00, BA, DB, 6F, 00, 00, 00, 00, 00
Response	Lamp Hour
Comment	

**Firmware Version** Command

Send String	BE, EF, 03, 06, 00, D5, D9, 70, 00, 00, 00, 00, 00
Response	Version
Comment	

**System Status** Command

Send String	BE, EF, 03, 06, 00, 04, D8, 71, 00, 00, 00, 00, 00
Response	03 :Projector ON (Normal Mode)
Comment	

**Volume** Command

Send String	BE, EF, 02, 06, 00, F8, DC, 71, 00, 00, 00, 00, 00
Response	06
Comment	

**Volume+** Command

Send String	BE, EF, 02, 06, 00, F1, DE, 68, 00, 00, 00, 00, 00
Response	06
Comment	

**Volume-**Command

Send String	BE, EF, 02, 06, 00, 20, DF, 69, 00, 00, 00, 00, 00
Response	06
Comment	

**Mute (Audio)** Command

Send String	BE, EF, 02, 06, 00, 0E, DE, 67, 00, 00, 00, 00, 00
Response	06
Comment	

Change to **Computer1 (Analog RGB)** Channel Command

Send String	BE, EF, 03, 19, 00, 19, 29, 01, 47, 02, CC, CC, 00
Response	06
Comment	

Change to **YcbCr** Channel Command

Send String	BE, EF, 03, 19, 00, 89, E8, 01, 47, 02, CC, CC, 00
Response	06
Comment	

Change to **S-Video** Channel Command

Send String	BE, EF, 03, 19, 00, E8, 69, 01, 47, 02, CC, CC, 00
Response	06
Comment	

Change to **Composite Video** Channel Command

Send String	BE, EF, 03, 19, 00, 78, A8, 01, 47, 02, CC, CC, 00
Response	06
Comment	

Change to **HDTV(Y-Pb-Pr)** Channel Command

Send String	BE, EF, 03, 19, 00, DA, 2B, 01, 47, 02, CC, CC, 00
Response	06
Comment	

Change to **Computer2(Analog RGB)** Channel Command

Send String	BE, EF, 03, 19, 1E, 90, 72, 01, 47, 02, CC, CC, 00
Response	06
Comment	

\* The output effects of Change to YcbCr Channel Command and Change to HDTV(Y-Pb-Pr) Channel Command are the same as that of Change to Computer1 (Analog RGB) Channel Command.

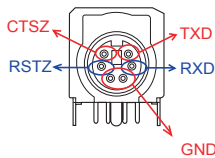

## Compatibility Modes

### Computer:

Compatibility	Resolution	H-Sync [KHz]	V-Sync [Hz]
VGA	640 x 480	31.5	59.9
		37.9	72.8
		37.5	75.0
		43.3	85.0
SVGA	800 x 600	35.2	56.3
		37.9	60.3
		48.1	72.2
		46.9	75.0
		53.7	85.1
XGA	1024 x 768	48.4	60.0
		56.5	70.1
		60.0	75.0
		68.7	85.0
SXGA	1152 x 864	64.0	70.0
		67.5	75.0
	1280 x 960	60.0	60.0
		75.0	75.0
		64.0	60.0
WXGA	1280 x 768	47.8	60.0
		60.3	74.9
		68.6	84.8
	1280 x 800	49.7	59.8
		62.8	74.9

### Video:

Signal	Horizontal Frequency (kHz)	Vertical Frequency (Hz)
480i	15.8 kHz	60 Hz
480p	31.5 kHz	60 Hz
576i	15.6 kHz	50 Hz
576p	31.3 kHz	50 Hz
720p	45.0 kHz	60 Hz
720p	37.5 kHz	50 Hz
1080i	33.8 kHz	60 Hz
1080i	28.1 kHz	50 Hz

## Troubleshooting

Refer to the symptoms and measures listed below before sending the projector for repairs. If the problem persists, contact your local reseller or service center. Please refer to "Indicator Messages" as well.

### Start-up problems

If no lights turn on:

- Be sure that the power cord is securely connected to the projector and the other end is plugged into an outlet with power.
- Press the power button again.
- Unplug the power cord and wait for a short while, then plug it in and press the power button again.

### Image problems

If the searching source is displayed:

- Press the **Source** button one or more times to select another active input source.
- Be sure the external source is turned on and connected.
- For a computer connection, ensure your notebook computer's external video port is turned on. Refer to the computer manual.

If the image is out of focus:

- Be sure the lens cover is open.
- While displaying the on-screen menu, adjust the focus ring. (The image size should not change; if it does, you are adjusting the zoom, not the focus.)
- Check the projection lens to see if it needs cleaning.

If the image is flickering or unstable for a computer connection:

- Press the **Resync** button on the control panel.
- Press the **Menu** button on the control panel or the **MENU** button on the remote control, go to **Computer Image** and adjust **Frequency** or **Tracking**.

### Remote control problems

If the remote control does not operate:

- Be sure nothing is blocking the remote control receiver on the front or back of the projector. Use the remote control within the effective range.
- Aim the remote control at the screen or at the front or back of the projector.
- Move the remote control so it is more directly in front of or behind the projector and not as far to the side.



# Customer Support

For technical support or product service, see the table below or contact your reseller.

**Note :** You will need the product serial number.

Country/Region	Web Site	T=Telephone F=Fax	E-mail
Australia/New Zealand	www.viewsonic.com.au	AUS=1800 880 818 NZ=0800 008 822	service@au.viewsonic.com
Canada	www.viewsonic.com	T (Toll-Free)= 1-866-463-4775 T (Toll)= 1-424-233-2533 F= 1-909-468-1202	service.ca@viewsonic.com
Europe/Middle East/Baltic countries/North Africa	www.viewsoniceurope.com	Contact your reseller	
Hong Kong	www.hk.viewsonic.com	T= 852 3102 2900	service@hk.viewsonic.com
India	www.in.viewsonic.com	T= 1800 11 9999	service@in.viewsonic.com
Korea	www.kr.viewsonic.com	T= 080 265 9080	service@kr.viewsonic.com
Latin America (Argentina)	www.viewsonic.com/la/	T= 0800 666 0194	soporte@viewsonic.com
Latin America (Brazil)	www.viewsonic.com/la/	T= 0800 891 6984	soporte@viewsonic.com
Latin America (Chile)	www.viewsonic.com/la/	T= 800 440 303	soporte@viewsonic.com
Latin America (Columbia)	www.viewsonic.com/la/	T= 01 800 915 6588	soporte@viewsonic.com
Latin America (Mexico)	www.viewsonic.com/la/	T= 001 800 514 6518	soporte@viewsonic.com
Renta y Datos, 29 SUR 721, COL. LA PAZ, 72160 PUEBLA, PUE. Tel: 01.222.891.55.77 CON 10 LINEAS Electroser, Av Reforma No. 403Gx39 y 41, 97000 Merida, Yucatan. Tel: 01.999.925.19.16 Other places please refer to <a href="http://www.viewsonic.com/la/soporte/index.htm#Mexico">http://www.viewsonic.com/la/soporte/index.htm#Mexico</a>			
Latin America (Peru)	www.viewsonic.com/la/	T= 0800 53458	soporte@viewsonic.com
Macau	www.hk.viewsonic.com	T= 853 700 303	service@hk.viewsonic.com
Puerto Rico & Virgin Islands	www.viewsonic.com	T= 1-800-688-6688 (English) T= 1-866-379-1304 (Spanish) F= 1-909-468-1202	service.us@viewsonic.com soporte@viewsonic.com
Singapore/Malaysia/Thailand	www.ap.viewsonic.com	T= 65 6461 6044	service@sg.viewsonic.com
South Africa	www.viewsoniceurope.com	www.viewsoniceurope.com/uk/Support/Calldesk.htm	
United Kingdom	www.viewsoniceurope.com/uk/	www.viewsoniceurope.com/uk/Support/Calldesk.htm	
United States	www.viewsonic.com	T (Toll-Free)= 1-800-688-6688 T (Toll)= 1-424-233-2530 F= 1-909-468-1202	service.us@viewsonic.com

# Limited Warranty

## VIEWSONIC® PROJECTOR

### What the warranty covers:

ViewSonic warrants its products to be free from defects in material and workmanship, under normal use, during the warranty period. If a product proves to be defective in material or workmanship during the warranty period, ViewSonic will, at its sole option, repair or replace the product with a like product. Replacement product or parts may include remanufactured or refurbished parts or components.

### How long the warranty is effective:

**North and South America:** 3 years for all parts excluding the lamp, 3 years for labor, 1 year for the original lamp from the date of the first consumer purchase.

**Europe:** 3 years for all parts excluding the lamp, 3 years for labor, 1 year for the original lamp from the date of the first consumer purchase.

**Other regions or countries:** Please check with your local dealer or local ViewSonic office for the warranty information.

Lamp warranty subject to terms and conditions, verification and approval. Applies to manufacturer's installed lamp only.

All accessory lamps purchased separately are warranted for 90 days.

### Who the warranty protects:

This warranty is valid only for the first consumer purchaser.

### What the warranty does not cover:

1. Any product on which the serial number has been defaced, modified or removed.
2. Damage, deterioration or malfunction resulting from:
  - a. Accident, misuse, neglect, fire, water, lightning, or other acts of nature, unauthorized product modification, or failure to follow instructions supplied with the product.
  - b. Repair or attempted repair by anyone not authorized by ViewSonic.
  - c. Any damage of the product due to shipment.
  - d. Removal or installation of the product.
  - e. Causes external to the product, such as electric power fluctuations or failure.
  - f. Use of supplies or parts not meeting ViewSonic's specifications.
  - g. Normal wear and tear.
  - h. Any other cause which does not relate to a product defect.
3. Any product exhibiting a condition commonly known as "image burn-in" which results when a static image is displayed on the product for an extended period of time.
4. Removal, installation, and set-up service charges.

### How to get service:

1. For information about receiving service under warranty, contact ViewSonic Customer Support (please refer to "Customer Support" page). You will need to provide your product's serial number.
2. To obtain warranted service, you will be required to provide (a) the original dated sales slip, (b) your name, (c) your address, (d) a description of the problem, and (e) the serial number of the product.
3. Take or ship the product freight prepaid in the original container to an authorized ViewSonic service center or ViewSonic.
4. For additional information or the name of the nearest ViewSonic service center, contact ViewSonic.

**Limitation of implied warranties:**

There are no warranties, express or implied, which extend beyond the description contained herein including the implied warranty of merchantability and fitness for a particular purpose.

**Exclusion of damages:**

ViewSonic's liability is limited to the cost of repair or replacement of the product. ViewSonic shall not be liable for:

1. Damage to other property caused by any defects in the product, damages based upon inconvenience, loss of use of the product, loss of time, loss of profits, loss of business opportunity, loss of goodwill, interference with business relationships, or other commercial loss, even if advised of the possibility of such damages.
2. Any other damages, whether incidental, consequential or otherwise.
3. Any claim against the customer by any other party.

**Effect of state law:**

This warranty gives you specific legal rights, and you may also have other rights which vary from state to state. Some states do not allow limitations on implied warranties and/or do not allow the exclusion of incidental or consequential damages, so the above limitations and exclusions may not apply to you.

**Sales outside the U.S.A. and Canada:**

For warranty information and service on ViewSonic products sold outside of the U.S.A. and Canada, contact ViewSonic or your local ViewSonic dealer.

The warranty period for this product in mainland China (Hong Kong, Macao and Taiwan Excluded) is subject to the terms and conditions of the Maintenance Guarantee Card.

For users in Europe and Russia, full details of warranty provided can be found in [www.viewsoniceurope.com](http://www.viewsoniceurope.com) under Support/Warranty Information.

# Mexico Limited Warranty

## VIEWSONIC® PROJECTOR

### What the warranty covers:

ViewSonic warrants its products to be free from defects in material and workmanship, under normal use, during the warranty period. If a product proves to be defective in material or workmanship during the warranty period, ViewSonic will, at its sole option, repair or replace the product with a like product. Replacement product or parts may include remanufactured or refurbished parts or components & accessories.

### How long the warranty is effective:

3 years for all parts excluding the lamp, 3 years for labor, 1 year for the original lamp from the date of the first consumer purchase.

Lamp warranty subject to terms and conditions, verification and approval. Applies to manufacturer's installed lamp only. All accessory lamps purchased separately are warranted for 90 days.

### Who the warranty protects:

This warranty is valid only for the first consumer purchaser.

### What the warranty does not cover:

1. Any product on which the serial number has been defaced, modified or removed.
2. Damage, deterioration or malfunction resulting from:
  - a. Accident, misuse, neglect, fire, water, lightning, or other acts of nature, unauthorized product modification, unauthorized attempted repair, or failure to follow instructions supplied with the product.
  - b. Any damage of the product due to shipment.
  - c. Causes external to the product, such as electrical power fluctuations or failure.
  - d. Use of supplies or parts not meeting ViewSonic's specifications.
  - e. Normal wear and tear.
  - f. Any other cause which does not relate to a product defect.
3. Any product exhibiting a condition commonly known as "image burn-in" which results when a static image is displayed on the product for an extended period of time.
4. Removal, installation, insurance, and set-up service charges.

### How to get service:

For information about receiving service under warranty, contact ViewSonic Customer Support (Please refer to the attached Customer Support page). You will need to provide your product's serial number, so please record the product information in the space provided below on your purchase for your future use. Please retain your receipt of proof of purchase to support your warranty claim.

For Your Records

Product Name: \_\_\_\_\_ Model Number: \_\_\_\_\_  
Document Number: \_\_\_\_\_ Serial Number: \_\_\_\_\_  
Purchase Date: \_\_\_\_\_ Extended Warranty Purchase? \_\_\_\_\_ (Y/N)  
If so, what date does warranty expire? \_\_\_\_\_

1. To obtain warranty service, you will be required to provide (a) the original dated sales slip, (b) your name, (c) your address, (d) a description of the problem, and (e) the serial number of the product.
2. Take or ship the product in the original container packaging to an authorized ViewSonic service center.
3. Round trip transportation costs for in-warranty products will be paid by ViewSonic.

### Limitation of implied warranties:

There are no warranties, express or implied, which extend beyond the description contained herein including the implied warranty of merchantability and fitness for a particular purpose.

### Exclusion of damages:

ViewSonic's liability is limited to the cost of repair or replacement of the product. ViewSonic shall not be liable for:

1. Damage to other property caused by any defects in the product, damages based upon inconvenience, loss of use of the product, loss of time, loss of profits, loss of business opportunity, loss of goodwill, interference with business relationships, or other commercial loss, even if advised of the possibility of such damages.
2. Any other damages, whether incidental, consequential or otherwise.
3. Any claim against the customer by any other party.
4. Repair or attempted repair by anyone not authorized by ViewSonic.

<b>Contact Information for Sales &amp; Authorized Service (Centro Autorizado de Servicio) within Mexico:</b>	
<b>Name, address, of manufacturer and importers:</b> México, Av. de la Palma #8 Piso 2 Despacho 203, Corporativo Interpalmas, Col. San Fernando Huixquilucan, Estado de México Tel: (55) 3605-1099 <a href="http://www.viewsonic.com/la/soporte/index.htm">http://www.viewsonic.com/la/soporte/index.htm</a>	
<b>NÚMERO GRATIS DE ASISTENCIA TÉCNICA PARA TODO MÉXICO: 001.866.823.2004</b>	
<b>Hermosillo:</b> Distribuciones y Servicios Computacionales SA de CV. Calle Juarez 284 local 2 Col. Bugambilias C.P: 83140 Tel: 01-66-22-14-9005 E-Mail: <a href="mailto:disc2@hmo.megared.net.mx">disc2@hmo.megared.net.mx</a>	<b>Villahermosa:</b> Compumantenimientos Garantizados, S.A. de C.V. AV. GREGORIO MENDEZ #1504 COL. FLORIDA C.P. 86040 Tel: 01 (993) 3 52 00 47 / 3522074 / 3 52 20 09 E-Mail: <a href="mailto:compumantenimientos@prodigy.net.mx">compumantenimientos@prodigy.net.mx</a>
<b>Puebla, Pue. (Matriz):</b> RENTA Y DATOS, S.A. DE C.V. Domicilio: 29 SUR 721 COL. LA PAZ 72160 PUEBLA, PUE. Tel: 01(52).222.891.55.77 CON 10 LINEAS E-Mail: <a href="mailto:datos@puebla.megared.net.mx">datos@puebla.megared.net.mx</a>	<b>Veracruz, Ver.:</b> CONEXION Y DESARROLLO, S.A DE C.V. Av. Americas # 419 ENTRE PINZÓN Y ALVARADO Fracc. Reforma C.P. 91919 Tel: 01-22-91-00-31-67 E-Mail: <a href="mailto:gacosta@qplus.com.mx">gacosta@qplus.com.mx</a>
<b>Chihuahua</b> Soluciones Globales en Computación C. Magisterio # 3321 Col. Magisterial Chihuahua, Chih. Tel: 4136954 E-Mail: <a href="mailto:Cefeo@soluglobales.com">Cefeo@soluglobales.com</a>	<b>Cuernavaca</b> Compusupport de Cuernavaca SA de CV Francisco Leyva # 178 Col. Miguel Hidalgo C.P. 62040, Cuernavaca Morelos Tel: 01 777 3180579 / 01 777 3124014 E-Mail: <a href="mailto:aquevedo@compusupportcva.com">aquevedo@compusupportcva.com</a>
<b>Distrito Federal:</b> QPLUS, S.A. de C.V. Av. Coyoacán 931 Col. Del Valle 03100, México, D.F. Tel: 01(52)55-50-00-27-35 E-Mail : <a href="mailto:gacosta@qplus.com.mx">gacosta@qplus.com.mx</a>	<b>Guadalajara, Jal.:</b> SERVICRECE, S.A. de C.V. Av. Niños Héroeas # 2281 Col. Arcos Sur, Sector Juárez 44170, Guadalajara, Jalisco Tel: 01(52)33-36-15-15-43 E-Mail: <a href="mailto:mmiranda@servicrece.com">mmiranda@servicrece.com</a>
<b>Guerrero Acapulco</b> GS Computación (Grupo Sesicomp) Progreso #6-A, Colo Centro 39300 Acapulco, Guerrero Tel: 744-48-32627	<b>Monterrey:</b> Global Product Services Mar Caribe # 1987, Esquina con Golfo Pérsico Fracc. Bernardo Reyes, CP 64280 Monterrey N.L. México Tel: 8129-5103 E-Mail: <a href="mailto:aydeem@gps1.com.mx">aydeem@gps1.com.mx</a>
<b>MERIDA:</b> ELECTROSER Av Reforma No. 403Gx39 y 41 Mérida, Yucatán, México CP97000 Tel: (52) 999-925-1916 E-Mail: <a href="mailto:rrrb@sureste.com">rrrb@sureste.com</a>	<b>Oaxaca, Oax.:</b> CENTRO DE DISTRIBUCION Y SERVICIO, S.A. de C.V. Murguía # 708 P.A., Col. Centro, 68000, Oaxaca Tel: 01(52)95-15-15-22-22 Fax: 01(52)95-15-13-67-00 E-Mail: <a href="mailto:gpotai2001@hotmail.com">gpotai2001@hotmail.com</a>
<b>Tijuana:</b> STD Av Ferrocarril Sonora #3780 L-C Col 20 de Noviembre Tijuana, Mexico	<b>FOR USA SUPPORT:</b> ViewSonic Corporation 381 Brea Canyon Road, Walnut, CA. 91789 USA Tel: 800-688-6688 (English); 866-323-8056 (Spanish); Fax: 1-800-685-7276 E-Mail: <a href="http://www.viewsonic.com">http://www.viewsonic.com</a>



**ViewSonic®**

## Free Manuals Download Website

<http://myh66.com>

<http://usermanuals.us>

<http://www.somanuals.com>

<http://www.4manuals.cc>

<http://www.manual-lib.com>

<http://www.404manual.com>

<http://www.luxmanual.com>

<http://aubethermostatmanual.com>

Golf course search by state

<http://golfingnear.com>

Email search by domain

<http://emailbydomain.com>

Auto manuals search

<http://auto.somanuals.com>

TV manuals search

<http://tv.somanuals.com>