

ViewSonic®



PLED-W500

LED Projector

User Guide

IMPORTANT: Please read this User Guide to obtain important information on installing and using your product in a safe manner, as well as registering your product for future service. Warranty information contained in this User Guide will describe your limited coverage from ViewSonic Corporation, which is also found on our web site at <http://www.viewsonic.com> in English, or in specific languages using the Regional selection box in the upper right corner of our website. "Antes de operar su equipo lea cuidadosamente las instrucciones en este manual"

Model No. VS14048

Compliance Information

FCC Statement

This device complies with part 15 of FCC Rules. Operation is subject to the following two conditions: (1) this device may not cause harmful interference, and (2) this device must accept any interference received, including interference that may cause undesired operation.

This equipment has been tested and found to comply with the limits for a Class B digital device, pursuant to part 15 of the FCC Rules. These limits are designed to provide reasonable protection against harmful interference in a residential installation. This equipment generates, uses, and can radiate radio frequency energy, and if not installed and used in accordance with the instructions, may cause harmful interference to radio communications. However, there is no guarantee that interference will not occur in a particular installation. If this equipment does cause harmful interference to radio or television reception, which can be determined by turning the equipment off and on, the user is encouraged to try to correct the interference by one or more of the following measures:

- Reorient or relocate the receiving antenna.
- Increase the separation between the equipment and receiver.
- Connect the equipment into an outlet on a circuit different from that to which the receiver is connected.
- Consult the dealer or an experienced radio/TV technician for help.

Warning: You are cautioned that changes or modifications not expressly approved by the party responsible for compliance could void your authority to operate the equipment.

For Canada

- This Class B digital apparatus complies with Canadian ICES-003.
- Cet appareil numérique de la classe B est conforme à la norme NMB-003 du Canada.

CE Conformity for European Countries

CE The device complies with the EMC Directive 2004/108/EC and Low Voltage Directive 2006/95/EC.

Following information is only for EU-member states:

The mark is in compliance with the Waste Electrical and Electronic Equipment Directive 2002/96/EC (WEEE).

The mark indicates the requirement NOT to dispose the equipment including any spent or discarded batteries or accumulators as unsorted municipal waste, but use the return and collection systems available.

If the batteries, accumulators and button cells included with this equipment, display the chemical symbol Hg, Cd, or Pb, then it means that the battery has a heavy metal content of more than 0.0005% Mercury or more than, 0.002% Cadmium, or more than 0.004% Lead.



Important Safety Instructions

1. Read these instructions.
2. Keep these instructions.
3. Heed all warnings.
4. Follow all instructions.
5. Do not use this unit near water.
6. Clean with a soft, dry cloth.
7. Do not block any ventilation openings. Install the unit in accordance with the manufacturer's instructions.
8. Do not install near any heat sources such as radiators, heat registers, stoves, or other devices (including amplifiers) that produce heat.
9. Do not defeat the safety purpose of the polarized or grounding-type plug. A polarized plug has two blades with one wider than the other. A grounding type plug has two blades and a third grounding prong. The wide blade and the third prong are provided for your safety. If the provided plug does not fit into your outlet, consult an electrician for replacement of the obsolete outlet.
10. Protect the power cord from being walked on or pinched particularly at plugs. Convenience receptacles and the point where they exit from the unit. Be sure that the power outlet is located near the unit so that it is easily accessible.
11. Only use attachments/accessories specified by the manufacturer.
12. Use only with the cart, stand, tripod, bracket, or table specified by the manufacturer, or sold with the unit. When a cart is used, use caution when moving the cart/unit combination to avoid injury from tipping over. 
13. Unplug this unit when unused for long periods of time.
14. Refer all servicing to qualified service personnel. Servicing is required when the unit has been damaged in any way, such as: if the power-supply cord or plug is damaged, if liquid is spilled onto or objects fall into the unit, if the unit is exposed to rain or moisture, or if the unit does not operate normally or has been dropped.

Declaration of RoHS Compliance

This product has been designed and manufactured in compliance with Directive 2002/95/EC of the European Parliament and the Council on restriction of the use of certain hazardous substances in electrical and electronic equipment (RoHS Directive) and is deemed to comply with the maximum concentration values issued by the European Technical Adaptation Committee (TAC) as shown below:

Substance	Proposed Maximum Concentration	Actual Concentration
Lead (Pb)	0.1%	< 0.1%
Cadmium (Cd)	0.01%	< 0.01%
Hexavalent Chromium (Cr ⁶⁺)	0.1%	< 0.1%
Polybrominated biphenyls (PBB)	0.1%	< 0.1%
Polybrominated diphenyl ethers (PBDE)	0.1%	< 0.1%

Certain components of products as stated above are exempted under the Annex of the RoHS Directives as noted below:

Examples of exempted components are:

1. Lead in glass of cathode ray tubes, electronic components, fluorescent tubes, and electronic ceramic parts (e.g. piezoelectronic devices).
2. Lead in high temperature type solders (i.e. lead-based alloys containing 85% by weight or more lead).
3. Lead as an alloying element in steel containing up to 0.35% lead by weight, aluminium containing up to 0.4% lead by weight and as a copper alloy containing up to 4% lead by weight.

Copyright Information

Copyright © ViewSonic® Corporation, 2012. All rights reserved.

Macintosh and Power Macintosh are registered trademarks of Apple Inc.

Microsoft, Windows, Windows NT, and the Windows logo are registered trademarks of Microsoft Corporation in the United States and other countries.

ViewSonic, the three birds logo, OnView, ViewMatch, and ViewMeter are registered trademarks of ViewSonic Corporation.

VESA is a registered trademark of the Video Electronics Standards Association. DPMS and DDC are trademarks of VESA.

PS/2, VGA and XGA are registered trademarks of International Business Machines Corporation.

Disclaimer: ViewSonic Corporation shall not be liable for technical or editorial errors or omissions contained herein; nor for incidental or consequential damages resulting from furnishing this material, or the performance or use of this product.

In the interest of continuing product improvement, ViewSonic Corporation reserves the right to change product specifications without notice. Information in this document may change without notice.

No part of this document may be copied, reproduced, or transmitted by any means, for any purpose without prior written permission from ViewSonic Corporation.

Product Registration

To meet your future needs, and to receive any additional product information as it becomes available, please register your product on the Internet at: www.viewsonic.com. The ViewSonic® Wizard CD-ROM also provides an opportunity for you to print the registration form, which you may mail or fax to ViewSonic.

For Your Records	
Product Name:	PLED-W500 ViewSonic LED Projector
Model Number:	VS14048
Document Number:	PLED-W500_UG_ENG Rev. 1C 07-31-12
Serial Number:	_____
Purchase Date:	_____

Product disposal at end of product life

The lamp in this product contains mercury which can be dangerous to you and the environment. Please use care and dispose of in accordance with local, state or federal laws.

ViewSonic respects the environment and is committed to working and living green. Thank you for being part of Smarter, Greener Computing. Please visit ViewSonic website to learn more.

USA & Canada: <http://www.viewsonic.com/company/green/recycle-program/>

Europe: <http://www.viewsoniceurope.com/uk/kbase/article.php?id=639>

Taiwan: <http://recycle.epa.gov.tw/recycle/index2.aspx>

Notes on the AC Power Cord

AC Power Cord must meet the requirement of countries where you use this projector. Please confirm your AC plug type with the graphics below and ensure that the proper AC Power Cord is used. If the supplied AC Power Cord does not match your AC outlet, please contact your sales dealer. This projector is equipped with a grounding type AC line plug. Please ensure that your outlet fits the plug. Do not defeat the safety purpose of this grounding type plug. We highly recommend using a video source device also equipped with a grounding type AC line plug to prevent signal interference due to voltage fluctuations.

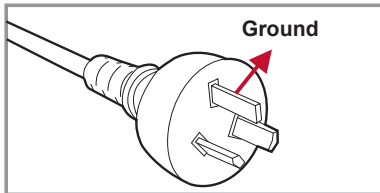

For Australia and Mainland China

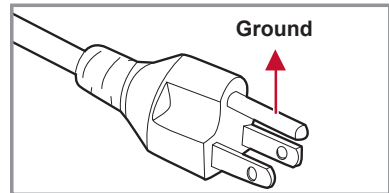

For the U.S.A and Canada

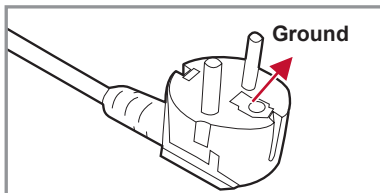

For Continental Europe

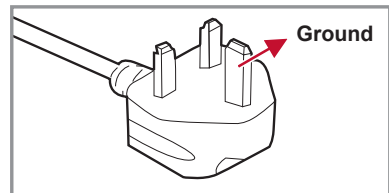

For the U.K.

Table of Contents

Introduction 7

Package Overview	7
Product Overview	8
Main Unit.....	8
Control Panel.....	9
Connection Ports	10
Remote Control.....	11

Installation 12

Connecting to Computer/Notebook.....	12
Connecting to Video Sources.....	13
Connecting to Multi-media Devices.....	14
Powering On/Off the Projector	15
Powering On the Projector.....	15
Powering Off the Projector.....	16
LED Indicator Messages.....	16
Adjusting the Projected Image	17
Adjusting the Projector's Height.....	17
Adjusting the Projector's Focus	18
Adjusting Projection Image Size	18

User Controls 19

Using the Control Panel	19
Using the Remote Control.....	20
On-screen Display Menus	22
How to operate	22
Structure	23
PICTURE	24
PICTURE Advanced	26
PICTURE Advanced Input	27
SCREEN	28
SETTING	29
SETTING Signal (RGB)	31
SETTING Advanced.....	32
SETTING Advanced Security.....	33

OPTIONS.....	35
OPTIONS LED Settings.....	37
OPTIONS Advanced	38
Media Arena	39
How to operate	39
Structure	42
SETUP.....	42
SETUP Photo Setting	43
SETUP Music Setting	44
SETUP Video Setting.....	45
SETUP Firmware Upgrade	46
Internal Memory.....	47
File Transfer.....	47
Projection with Wireless Presentation..	48
Projection with MobiShow	49
MobiShow Utility for iPhone.....	49
MobiShow Utility for Android.....	50
Using the MobiShow	50
MobiShow Photo Viewer.....	51
MobiShow PtG2.....	52
Using the PtG2 Converter.....	53

Appendices 54

Troubleshooting.....	54
Image Problems.....	54
Projector Problems	57
Multi-media Problems	57
On Screen Messages	58
Piscl Support Languages, Character Encodings and Fonts.....	59
Compatibility Modes	64
Multi-media Format Supported.....	68
Ceiling Mount Installation	70
Specifications	71

Introduction

Package Overview

Unpack and inspect the box contents to ensure all parts listed below are in the box. If something is missing, please contact our customer service.

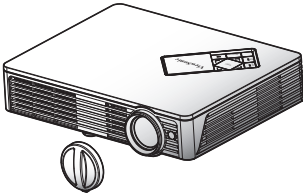

Projector with lens cap



Remote Control



AAA Batteries x 2
(For remote control)

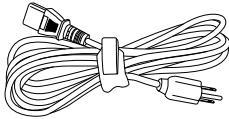

AC Power Cord

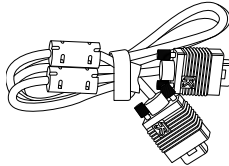

VGA Cable

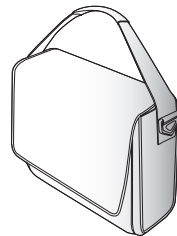

Soft Carrying Bag

Documentation:

- User's Guide (DVD)
- Quick Start Card
- Warranty Card

NOTE

- Due to different applications in each Country, some regions may have different accessories.

Product Overview

Main Unit

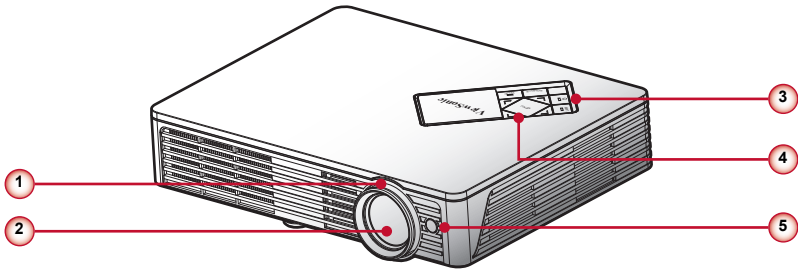

(Front View)

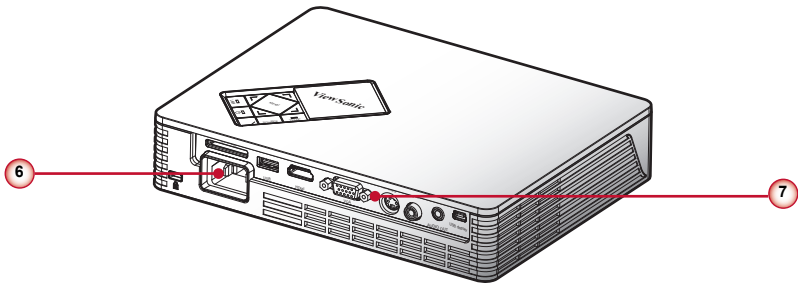

(Rear View)

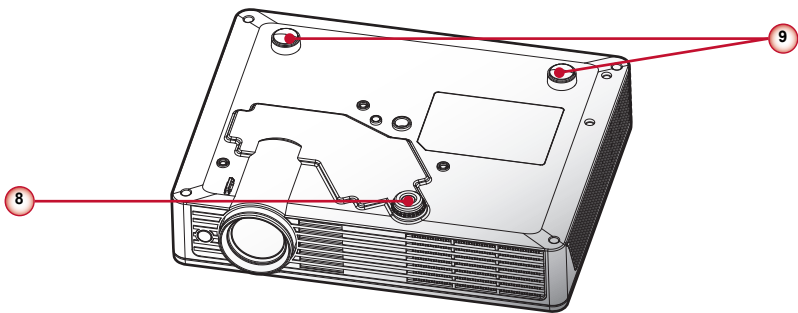

(Bottom View)

-
- | | |
|----------------------------------|------------------------------------|
| 1. Focus Ring | 6. Power Socket |
| 2. Zoom Lens | 7. Input / Output Connection Ports |
| 3. Power Button / LED Indicators | 8. Elevator Foot |
| 4. Control Panel | 9. Rubber Feet |
| 5. IR Receiver | |

Control Panel

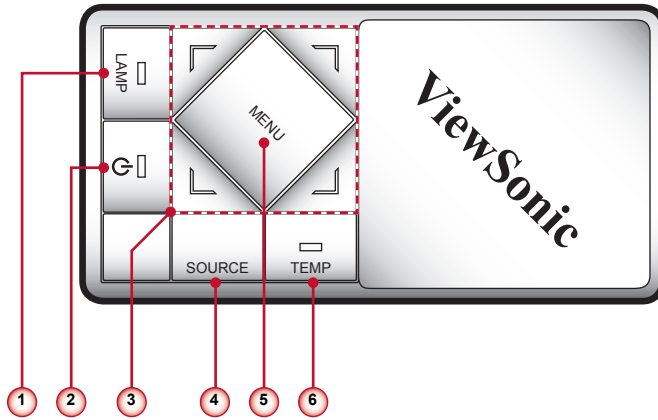

1. Lamp LED
2. ⏻ / Power LED
3. Four directional select keys
4. Source
5. Menu
6. Temp LED

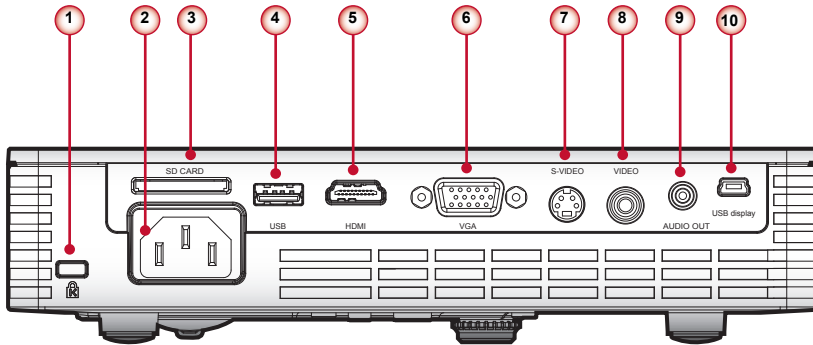

Connection Ports

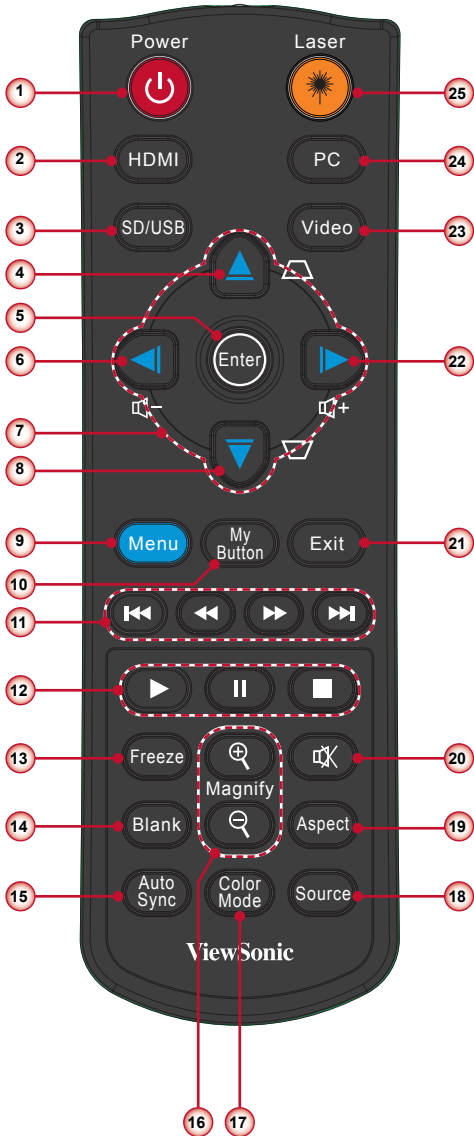

1. Kensington™ Lock Port
2. Power Socket
3. SD Card Reader
4. USB Connector
5. HDMI Connector
6. VGA Connector (PC analog signal/HDTV/component video input)
7. S-Video Connector
8. Composite Video Input Connector
9. Audio Output Connector
10. Mini USB Connector

Remote Control



1. Power 
2. HDMI
3. SD/USB
4. Keystone 
5. Enter
6. Volume -
7. Four Directional Select Keys
8. Keystone 
9. Menu
10. My Button
11. Previous/Rewind/Fast Forward/Next
12. Play/Pause/Stop
13. Freeze
14. Blank
15. Auto Sync
16. Magnify +/-
17. Color Mode
18. Source
19. Aspect
20. Mute
21. Exit
22. Volume +
23. Video
24. PC
25. Laser

Installation

Connecting to Computer/Notebook

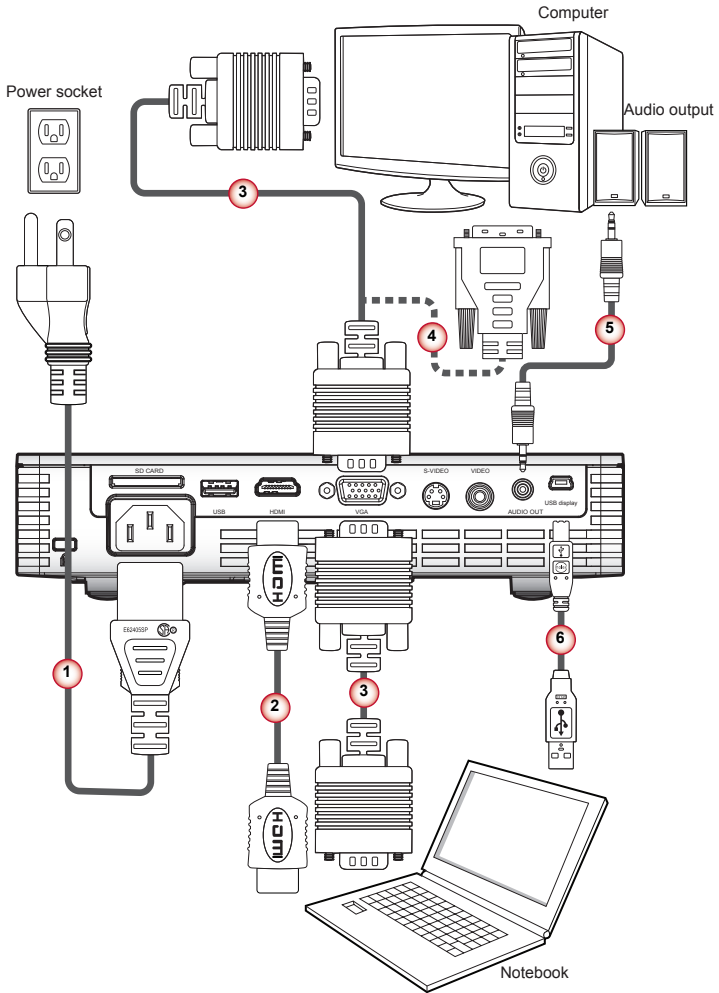

1. Power Cord
2. HDMI Cable *
3. VGA Cable
4. VGA to DVI-A Cable *
5. Audio Cable *
6. USB Cable * (Mini B type to A type)



- Due to the difference in applications for each country, some regions may have different accessories.
- * Optional accessory

Connecting to Video Sources

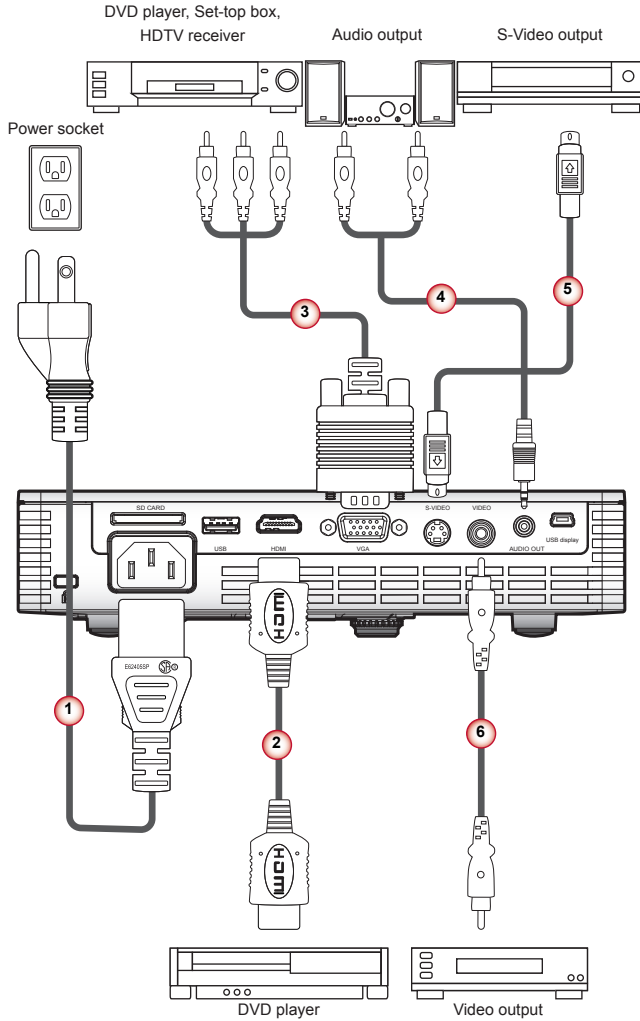

1. Power Cord
2. HDMI Cable *
3. VGA to HDTV (RCA) Cable *
4. Audio Cable *
5. S-Video Cable *
6. Composite Video Cable *



- Due to the difference in applications for each country, some regions may have different accessories.
- * Optional accessory

Connecting to Multi-media Devices

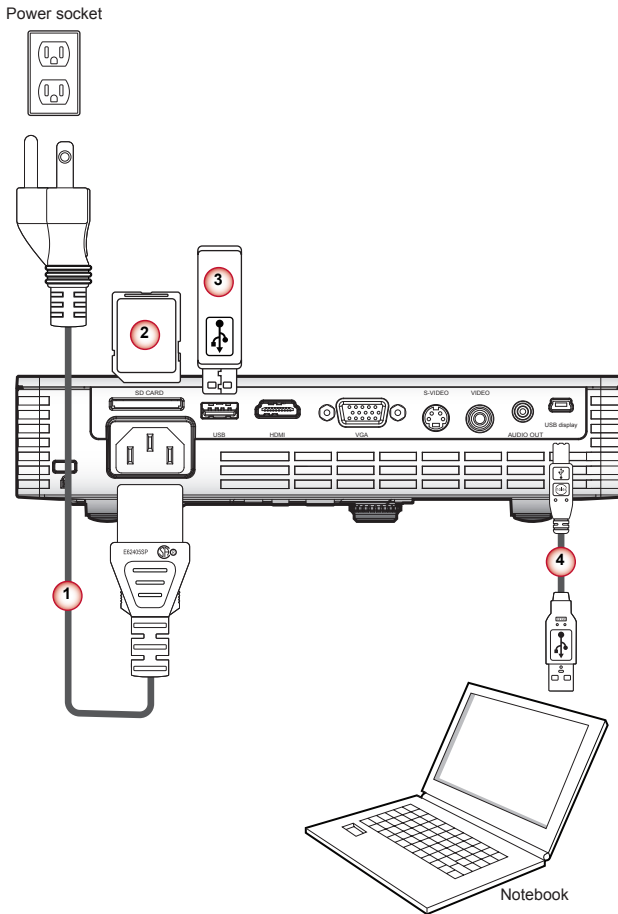

1. Power Cord
2. SD Card *
3. USB Flash Drive *
4. USB Cable * (Mini B type to A type)

NOTE

- Due to the difference in applications for each country, some regions may have different accessories.
- * Optional accessory

Powering On/Off the Projector

Powering On the Projector

1. Remove the lens cap. ❶
2. Securely connect the power cord and signal cable. When connected, the Power LED will flash red.
3. Turn on the lamp by pressing “⏻” button on the control panel or on the remote control. The Power LED will turn blue. ❷
4. Turn on your source that you want to display on the screen (computer, notebook, video player, etc). The projector will detect the source automatically and will display on the screen.
5. If you connected multiple sources at the same time, press the “Source” button on the remote control to switch between inputs.

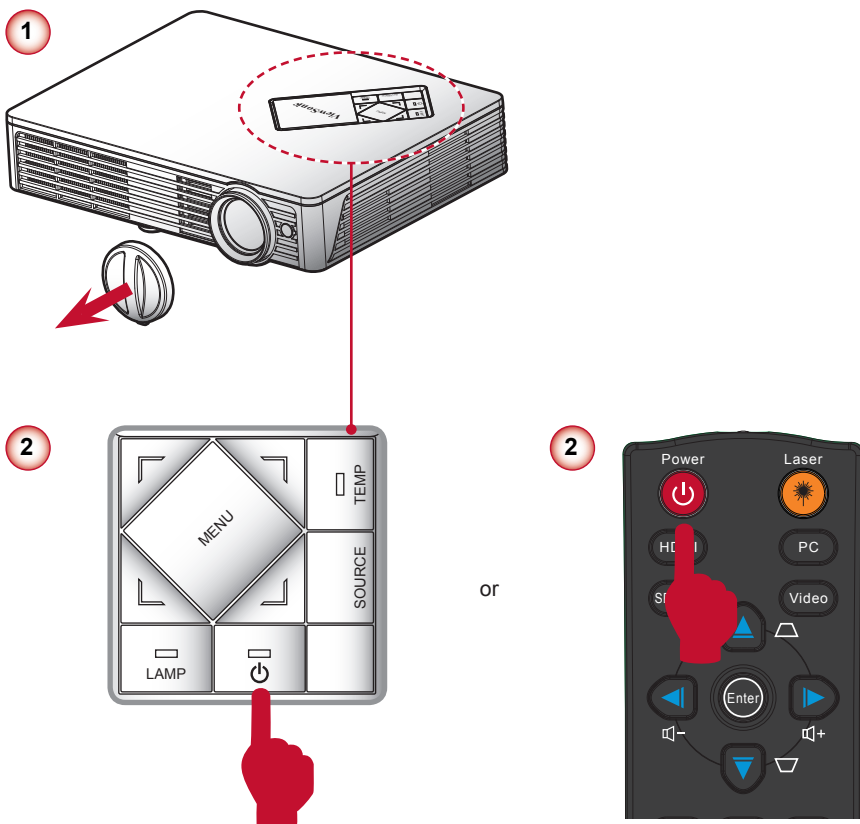

Powering Off the Projector

1. Press the “⏻” button on the control panel or on the remote control to turn off the projector. The following message will be displayed on the screen. Press the “⏻” button again to confirm.

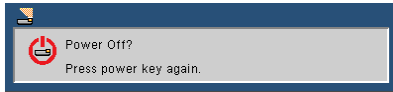

2. The Power LED will turn red and blink rapidly after the projector is turned off. And the fans will continue to operate for about 30 seconds to ensure that the system cools properly.
3. Once the system has finished cooling, the Power LED will stop blinking and turn solid red to indicate standby mode.
4. It is now safe to unplug the power cord.

LED Indicator Messages

Message	Lamp LED (Red)	Temp LED (Red)	Power LED (Red)	Power LED (Blue)
Power Plug	Flash ON to OFF 100ms	Flash ON to OFF 100ms	Flash ON to OFF 100ms	-
Standby	-	-	ON	-
Power button ON	-	-	-	ON
Cooling state	-	-	0.5 second H(ON), 0.5 second L(OFF) flashing	-
Power button OFF: Cooling completed; Standby Mode	-	-	ON	-
Firmware download	ON	ON	ON	-
Thermal sensor error, OSD showing as below: 1. Make sure air in and outlets are not blocked. 2. Make sure the environment temperature is under 40 degree C.	-	ON	-	ON
Fan lock error, OSD showing as below: The projector will switch off automatically.	-	0.5 second H(On), 0.5 second L(Off) flashing	-	ON
Lamp error (LED, LED driver, Light sensor)	ON	-	-	ON

Adjusting the Projected Image

Adjusting the Projector's Height

The projector is equipped with elevator foot for adjusting the image height.

- To raise the image:

Use screw in foot to raise the image to the desired height angle and fine-tune the display angle. ❶

- To lower the image:

Use screw in foot to lower the image to the desired height angle and fine-tune the display angle. ❷

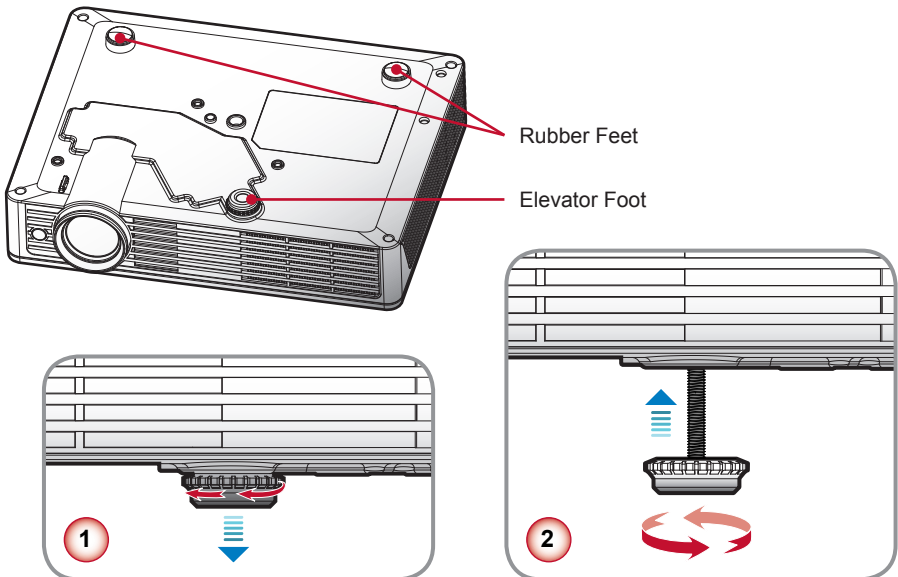

Adjusting the Projector's Focus

To focus the image, rotate the focus ring until the image is clear.

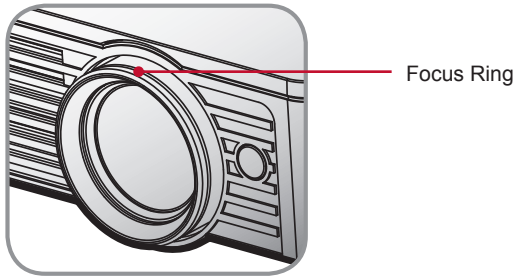

Adjusting Projection Image Size

Refer to the graphics and table show as below to determine the screen size and projection distance.

- Adjusting the vertical image position

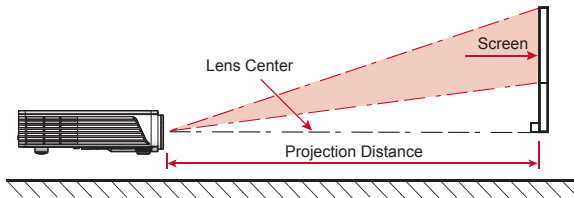

- $Projection\ distance\ (m) = 1.4 \times Screen\ size\ (m) \times 0.848$
Ex.: Projection distance (0.9m) = 1.4 x Screen size (0.76) x 0.848
 Tolerance is around 5%

Projection Distance		Screen Size (16:10)	
Inch	m	Inch	m
35.4	0.9	30	0.76
39.4	1.0	33	0.84
47.2	1.2	40	1.02
51.2	1.3	43	1.09
63	1.6	53	1.35
74.8	1.9	63	1.60
86.6	2.2	73	1.85
94.5	2.4	80	2.03





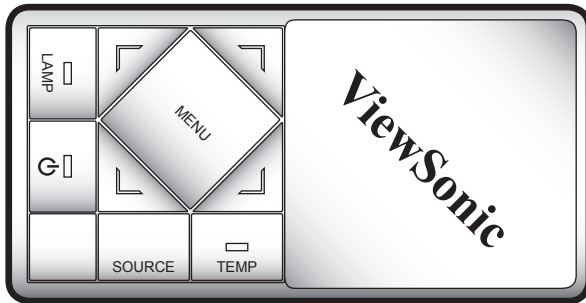

- *This table is for user's reference only.*

User Controls







Using the Control Panel

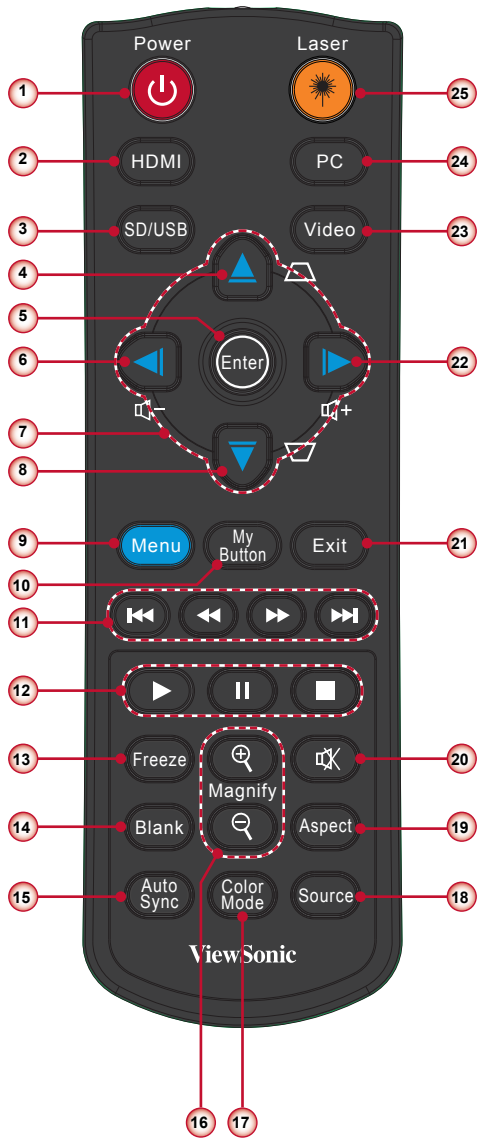

Name	Description
Power 	Turn the projector on/off.
Menu	Launch the on-screen display (OSD).
Source	Select an input signal.
Four Directional Select Keys	Use     to select items or make adjustments to your selection.
Lamp LED	Indicate the projector's lamp status.
Power LED	Indicate the projector's status.
Temp LED	Indicate the projector's temperature status.

Using the Remote Control



Name		Description
1	Power 	Turn the projector on/off.
2	HDMI	Choose HDMI source.
3	SD/USB	Choose SD/USB sources.
4	Keystone 	Adjust image distortion caused by tilting the projector.
5	Enter	Confirm your item selection.
6	Volume -	Decrease the volume level.
7	Four Directional Select Keys	Use     to select items or make adjustments to your selection.
8	Keystone 	Adjust image distortion caused by tilting the projector.
9	Menu	Launch the on-screen display (OSD).
10	My Button	User definable key for customized function.
11	Previous/Rewind/ Fast Forward/Next	Control the multimedia file to previous, rewind, fast forward or next.
12	Play/Pause/Stop	Control the multimedia file to play, pause and stop.
13	Freeze	Freeze the screen image. Press this button again to unlock.
14	Blank	Hide the screen picture.
15	Auto Sync	Automatically synchronizes the projector to the input source.
16	Magnify +/-	Magnifies or reduces the projected picture size.
17	Color Mode	Select the color mode from Brightest, PC, Movie, Picture and User.
18	Source	Select an input signal.
19	Aspect	Select the display aspect ratio.
20	Mute	Momentarily turns off/on the sound.
21	Exit	Leave current page or items or to close OSD.
22	Volume +	Increase the volume level.
23	Video	Choose composite/S-Video source.
24	PC	Choose PC source.
25	Laser	Press to use laser pointer.

On-screen Display Menus







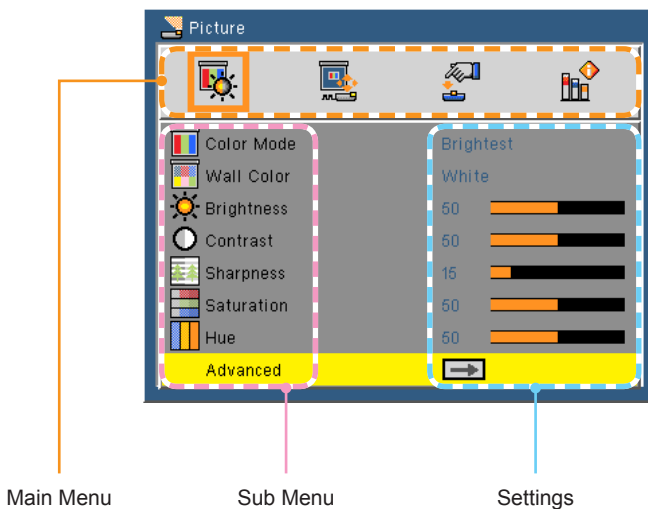

The Projector has multilingual On-screen Display menus that allow you to make image adjustments and change a variety of settings. The projector will automatically detect the source.

How to operate

1. To open the OSD menu, press the “Menu” button on the remote control or on the control panel.
2. When OSD is displayed, use the ◀▶ buttons to select any item in the main menu. While making a selection on a particular page, press the ▼ button to enter sub menu.
3. Use the ▲▼ buttons to select the desired item and adjust the settings by the ◀▶ buttons.
4. If the setting has  icon, you could press the ▶ button to enter another sub menu. Press the “Menu” button to close the sub menu after adjustment.
5. After adjusting the settings, press the “Menu” button to go back to the main menu.
6. To exit, press the “Menu” button again. The OSD menu will be closed and the projector will automatically save the new settings.



Structure

Main Menu	Sub Menu	Settings	
PICTURE	Color Mode	Brightest / PC / Movie / Picture / User	
	Wall Color	White / Light Yellow / Light Blue / Pink / Dark Green	
	Brightness	0~100	
	Contrast	0~100	
	Sharpness	0~31	
	Saturation	0~100	
	Hue	0~100	
	Advanced	Gamma	0 / 1 / 2
		Color Temp.	Low / Middle / High
		Color Space	AUTO / RGB / YUV
		Input	HDMI / VGA / COMPOSITE / S-Video / USB Display / Exit
SCREEN	Aspect Ratio	AUTO / 4:3 / 16:9 / 16:10	
	Overscan	Off / On	
	Digital Zoom	-5~25 (80%~200%)	
	Auto Keystone	Off / On	
	V Keystone	-40~40	
	Ceiling Mount	AUTO /  	
SETTING	Language	English / Deutsch / Français / Italiano / Español / Português / Polski / Русский / Svenska / Norsk / 简体中文 / 日本語 / 한국어 / Türkçe / 繁體中文	
	Orientation	 	
	Menu Location	    	
	Signal	Phase	0~31
		Clock	-5~5
		H. Position	-10~10
		V. Position	-10~10
		Exit	
	Mute	Off / On	
	Volume	0~100	
	3D	Off / On	
	3D Invert	Off / On	
	Advanced	Logo	On / Off
		Closed Caption	Off / CC1 / CC2 / CC3 / CC4
		Security	
		Exit	
Reset	No / Yes		
SETTING Advanced	Security	Security	Off / On
		Change Password	
		Exit	
OPTIONS	Auto source	Off / On	
	Fan Mode	AUTO / High Altitude	
	Information Hide	Off / On	
	Background Color	Black / Blue	
	LED Settings	LED Hours Used	
		ECO Mode	Off / On
		Clear LED Hours	
		Exit	
	Information		
	Advanced	Direct Power On	Off / On
		Auto Power Off (min)	0~180
Keypad Lock		Off / On	
Exit			
LED Calibration	No / Yes		

PICTURE

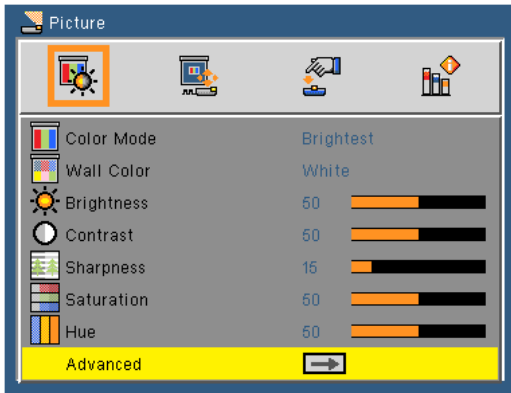

Color Mode

There are many factory presets optimized for various types of images. Use the ◀ or ▶ button to select the item.

- ▶ Brightest: Maximum brightness from PC input.
- ▶ PC: For computer or notebook.
- ▶ Movie: For home theater.
- ▶ Picture: For graphic picture.
- ▶ User: User defined settings.

Wall Color

Use this function to choose a proper color according to the wall. It will compensate the color deviation due to the wall color to show the correct image tone.

Brightness

Adjust the brightness of the image.

- ▶ Press the ◀ button to darken image.
- ▶ Press the ▶ button to lighten the image.

Contrast

The contrast controls the degree of difference between the lightest and darkest parts of the picture. Adjusting the contrast changes the amount of black and white in the image.

- ▶ Press the ◀ button to decrease the contrast.
- ▶ Press the ▶ button to increase the contrast.

Sharpness

Adjust the sharpness of the image.

- ▶ Press the ◀ button to decrease the sharpness.
- ▶ Press the ▶ button to increase the sharpness.

Saturation

Adjust a video image from black and white to fully saturated color.

- ▶ Press the ◀ button to decrease the amount of saturation in the image.
- ▶ Press the ▶ button to increase the amount of saturation in the image.

Hue

Adjust the color balance of red and green.

- ▶ Press the ◀ button to increase the amount of green in the image.
- ▶ Press the ▶ button to increase the amount of red in the image.

 NOTE

- *"Sharpness", "Saturation" and "Hue" functions are only supported under video mode.*

Advanced

Refer to page 26.

PICTURE | Advanced

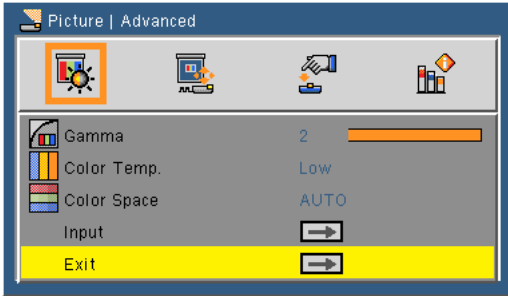

Gamma

Effects the representation of dark scenery. With greater gamma value, dark scenery will look brighter.

Color Temp.

Adjust the color temperature. At higher temperature, the screen looks colder; at lower temperature, the screen looks warmer.

Color Space

Select an appropriate color matrix type from AUTO, RGB or YUV.

Input

Refer to page 27.

PICTURE | Advanced | Input

Use this option to enable/disable input sources. Press ► button to enter the sub menu and select which sources you require. Press the “Enter” button to finalize the selection. The projector will not search for inputs that are not selected.

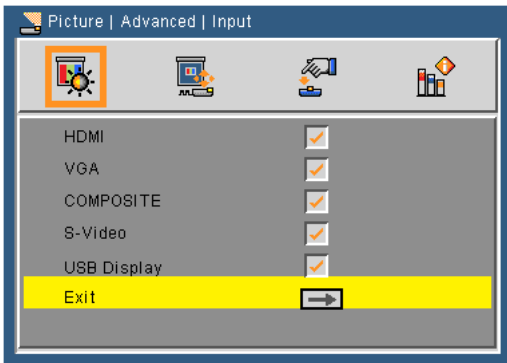

NOTE

- SD card and USB A are not in the auto source route, please manually select them.

- ▶ USB Display (display over USB) can be easily operated to project a computer's screen by using a single USB cable (mini B type to A type) without any other drivers.
 1. Choose source: Press the “PC” button on the remote control to choose source from the mini USB connector.
 2. Connection: Connect the USB cable to the mini USB of projector and USB type A of the computer.
 3. Automatically projected: When detecting the computer, the screen will be automatically projected out.
 4. End the projection: When unplugging the USB cable, the projection will be stopped.

NOTE

- Only one computer can be connected at one time.

SCREEN



Aspect Ratio

- ▶ AUTO: Automatically selects the appropriate display format.
- ▶ 4:3: This format is for 4×3 input sources.
- ▶ 16:9: This format is for 16×9 input sources, like HDTV and DVD enhanced for Wide screen TV.
- ▶ 16:10: This format is for 16×10 input sources, like widescreen laptops.

Overscan

Overscan function removes the noise in a video image. Overscan the image to remove video encoding noise on the edge of video source.

Digital Zoom

Press the ◀ button to reduce the size of an image.

Press the ▶ button to magnify an image on the projection screen.



Auto Keystone

- ▶ Choose “On” to automatically start the keystone adjustment.
- ▶ Choose “Off” to manually adjust the keystone.

V Keystone

Press the ◀ or ▶ button to adjust image distortion vertically. If the image looks trapezoidal, this option can help make the image rectangular.

Ceiling Mount

- ▶ AUTO: Automatically inverts the image when the projector is mounted on the ceiling.
- ▶  Desktop Front: The image is projected straight on the screen.
- ▶  Ceiling Front: When selected, the image will turn upside down.

SETTING

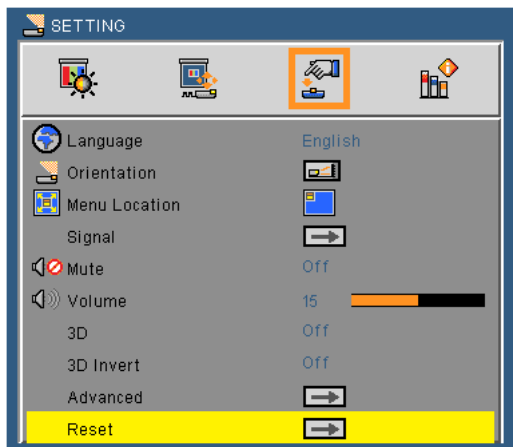

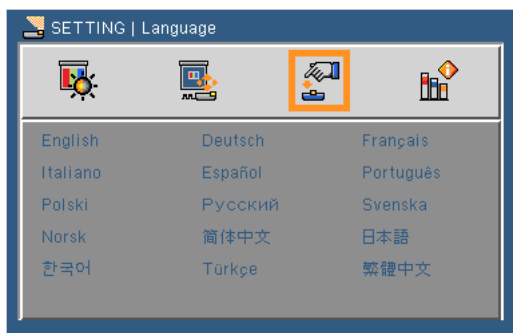

Language

Choose the multilingual OSD menu. Press the ◀ or ▶ button into the sub menu and then use the ▲ or ▼ button to select your preferred language. Press “Enter” on the remote control to finalize the selection.



Orientation

- ▶  Desktop Front: This is the default selection. The image is projected straight on the screen.
- ▶  Desktop Rear: When selected, the image will appear reversed.

Menu Location

Choose the menu location on the display screen.

Signal

Refer to page 31.

Mute

- ▶ Choose “On” to turn mute on.
- ▶ Choose “Off” to turn mute off.

Volume

- ▶ Press the ◀ button to decrease the volume.
- ▶ Press the ▶ button to increase the volume.

3D

- ▶ Choose “On” to enable 3D function.
- ▶ Choose “Off” to disable 3D function.



■ *The 3D display performance will depend on the 3D glasses you applied.*

3D Invert

- ▶ Choose “On” to invert left and right frame contents.
- ▶ Choose “Off” to display default frame contents.

Advanced

Refer to page 32.

Reset

Choose “Yes” to return the parameters on all menus to the factory default settings.

SETTING | Signal (RGB)



Phase

Synchronize the signal timing of the display with the graphic card. If the image appears to be unstable or flickers, use this function to correct it.

Clock

Change the display data frequency to match the frequency of your computer's graphic card. Use this function only if the image appears to flicker vertically.

H. Position

- ▶ Press the ◀ button to move the image left.
- ▶ Press the ▶ button to move the image right.

V. Position

- ▶ Press the ◀ button to move the image down.
- ▶ Press the ▶ button to move the image up.

NOTE

- "H. Position" and "V. Position" ranges will depend on input source.

SETTING | Advanced

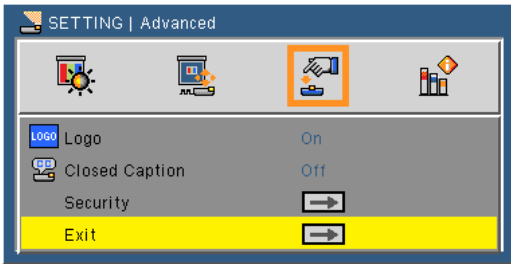

Logo

Use this function to set the desired startup screen. If changes are made they will take effect the next time the projector is powered on.

- ▶ On: The default startup screen.
- ▶ Off: No logo is displayed.

Closed Caption

Use this function to enable close caption and activate the closed caption menu. Select an appropriate closed captions option: Off, CC1, CC2, CC3, CC4.

Security

Refer to page 33.

SETTING | Advanced | Security

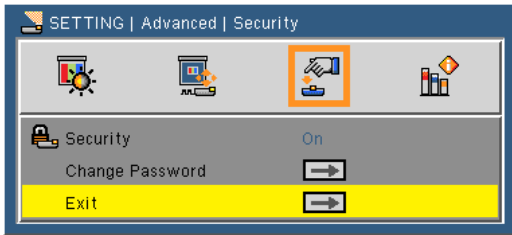

Security

- ▶ On: Choose "On" to use security verification when turning on the projector.
- ▶ Off: Choose "Off" to be able to switch on the projector without password verification.

Change Password

- ▶ First time:
 - Press the ► button to set the password.
 - The password has to be 6 digits.
 - Use number buttons on the remote control to enter your new password and then press "Enter" to confirm it.
- ▶ Change Password:
 - Press the ► button to input the old password.
 - Use number buttons to enter the current password and then press "Enter" to confirm it.
 - Enter a new password (6 digits in length) using the number buttons on the remote control, then press "Enter" to confirm it.
 - Enter the new password again and press "Enter" to confirm it.
- ▶ If the incorrect password is entered for 3 times, the projector will automatically shut down.
- ▶ If you have forgotten your password, please contact your local office for support.

NOTE

- Password default value is "123456" (first time).
- When you input the password, you must press the "Enter" button and other number button on the remote control at the same time.



OPTIONS

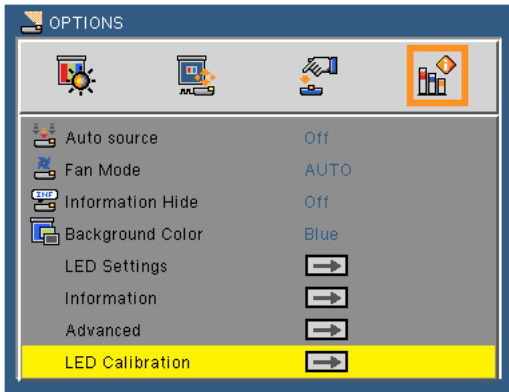

Auto Source

- ▶ On: The projector will search for other signals if the current input signal is lost.
- ▶ Off: The projector will only search current input connection.

Fan Mode

- ▶ AUTO: The built-in fans automatically run at a variable speed according to the internal temperature.
- ▶ High Altitude: The built-in fans run at high speed. The built-in fans run at a high speed. Select this option when using the projector at altitudes approximately 2500 feet/760 meters or higher.

Information Hide

- ▶ On: Choose “On” to hide the info message.
- ▶ Off: Choose “Off” to show the “searching” message.

Background Color

Use this feature to display a “Black” or “Blue” screen when no signal is available.

LED Settings

Refer to page 37.

Information

Display the projector information for source, resolution, software version, color space and aspect ratio on the screen.

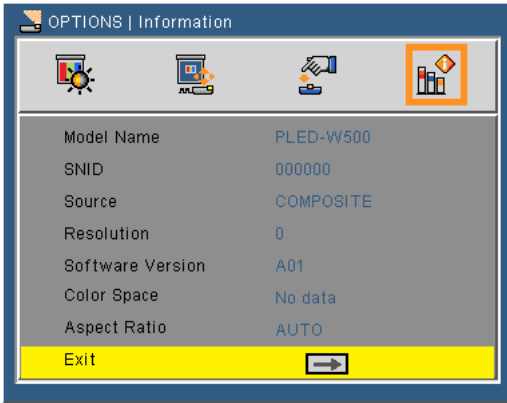

Advanced

Refer to page 38.

LED Calibration

Use this function to adjust LED color performance. Please wait for 10 seconds to finish the white color fine tune process.

This function will start to work after the LED used hour being greater than 500 and you continues using the projector for more than 2 hours.



- *If you didn't implement the LED calibration after the LED used hour being greater than 500 and you continues using the projector for more than 2 hours, it will pop up the message to remind you.*

OPTIONS | LED Settings

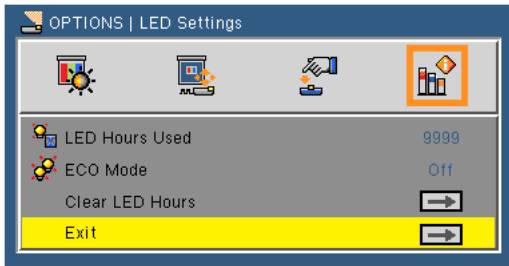

LED Hours Used

Display the projection time.

ECO Mode

Choose "On" to dim the projector lamp which will lower power consumption and extend the lamp life. Choose "Off" to return to normal mode.

Clear LED Hours

Reset the lamp hour counter after replacing the lamp.

OPTIONS | Advanced

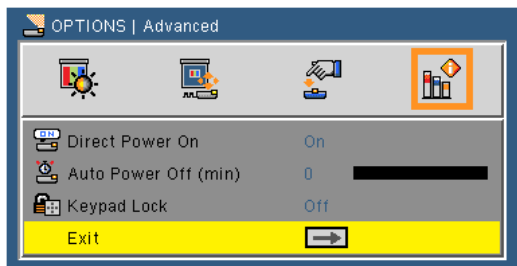

Direct Power On

Choose "On" to activate Direct Power mode. The projector will automatically power on when AC power is supplied, without pressing the "⏻" button on the projector control panel or on the remote control.

Auto Power Off (min)

Sets the countdown timer interval. The countdown timer will start, when there is no signal being sent to the projector. The projector will automatically power off when the countdown has finished (in minutes).

Keypad Lock

When the keypad lock function is "On", the control panel will be locked. However, the projector can be operated by the remote control. By selecting "Off", you will be able to reuse the control panel.

Media Arena

Media Arena is an interactive PC-less presentation solution. Through SD card reader, USB connector and internal memory, you can easily access various photo, video and music media formats (See format supported table). The stylish user interface gives you the best experience while playing media files.







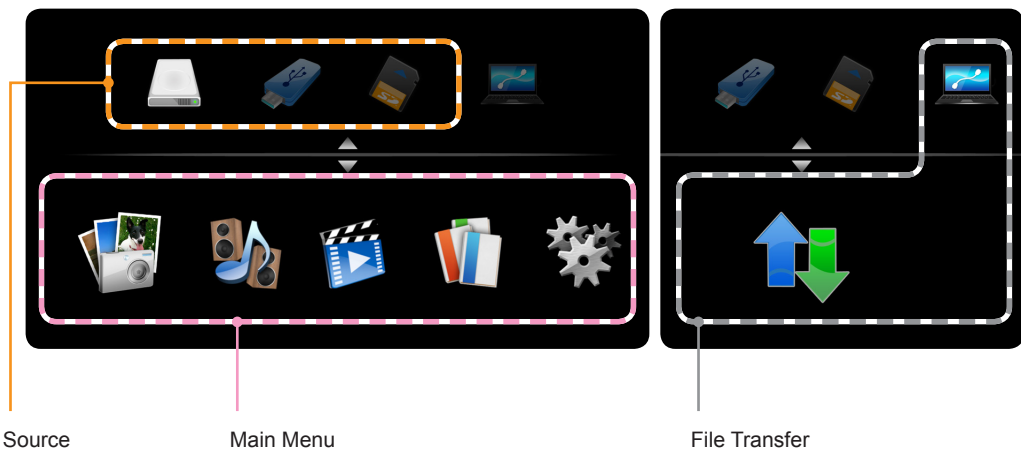

How to operate

1. To open the Media Arena, insert a SD card/USB flash drive to the SD card reader /USB connector on the rear of the projector.
2. When the main menu is displayed, use the ◀▶ buttons on the remote control to select a source device. Press the “Enter” button or ▼ buttons on the control panel to make a selection.
3. Use the ◀▶ buttons on the remote control to select any item in the main menu. Press the “Enter” button or ▼ buttons on the control panel to make a selection.
4. Use the ▲▼ buttons to select the desired file and open/play it by the ▶ button.
5. Press the “Exit” button to back the main menu or previous folder.

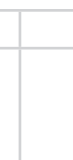

- The tool bar displayed on the bottom will disappear in three seconds if there is no action.
- The tool bar will disappear in three seconds if you play a media file with full screen.

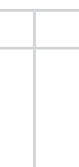

	Internal Memory	USB	SD Card
Source			
Main Menu	Photo 	Music 	Video 
	Office Reader 	Setup 	
	File Transfer	Connect PC 	File Transfer 

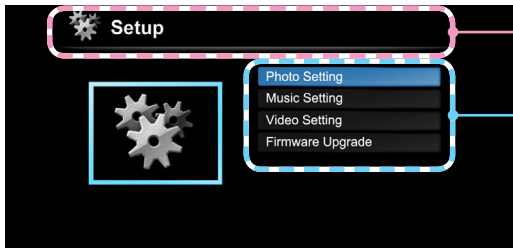

Main Menu

Sub Menu

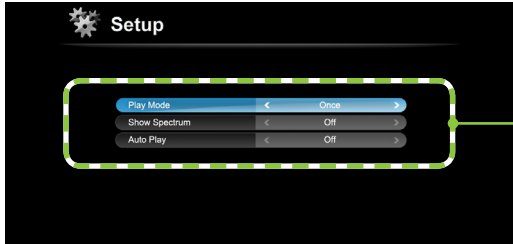

Settings



■ Office Reader:

1. All IPR, including but not limited to copyright, in the Picstel Products is owned by Picstel suppliers.
2. The End User may not:
 - Make copies of the Picstel Products or make them available for use by third parties.
 - Reverse engineer, disassemble, reverse translate, or in any way decode the Picstel Products or any copy or part of it in order to derive any source code, save only as is permitted by any applicable law.
3. Picstel make no representations or warranties whether express or implied (by statute or otherwise) relating to the performance, quality, merchantability or fitness for a particular purpose of the Picstel Products or otherwise and all such representations or warranties are specifically disclaimed and excluded.
4. Picstel agrees and acknowledges that Picstel and the Picstel Products will not be specifically mentioned in the end user license agreement.



- Diverse format, font and graphic in your original MS Office files might affect the decoding speed and display result.

Structure

Main Menu	Sub Menu	Settings	
Photo	File List		
Music	File List		
Video	File List		
Office Reader	File List		
Setup	Photo Setting	Display Ratio	Auto / Full
		Slideshow Duration	5 Sec. / 15 Sec. / 30 Sec. / 1 Min. / 5 Min. / 15 Min.
		Slideshow Repeat	On / Off
	Music Setting	Slideshow Effect	Random / Snake / Partition / Erase / Blinds / Lines / GridCross / Cross / Spiral / Rect / Off
		Play Mode	Once / Repeat Once / Repeat / Random
		Show Spectrum	On / Off
		Auto Play	Off / On
	Video Setting	Display Ratio	Auto / Original Size
		Play Mode	Once / Repeat Once / Repeat / Random
		Auto Play	Off / On
	Firmware Upgrade		

SETUP

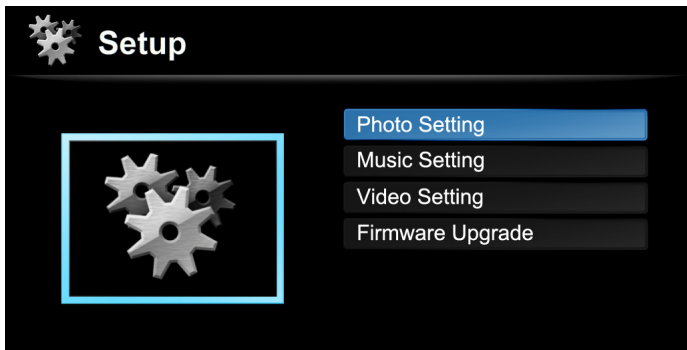

Photo Setting

Access the photo settings.

Music Setting

Access the music settings.

Video Setting

Access the video settings.

Firmware Upgrade

To do firmware upgrade.

SETUP | Photo Setting

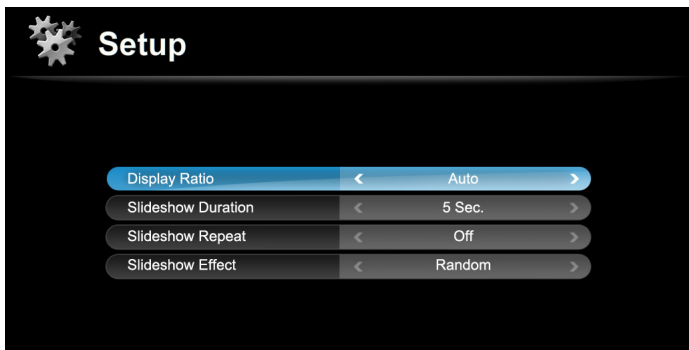

Display Ratio

Press ◀ or ▶ to select the display ratio.

- ▶ Auto: Fit full screen without keeping the original aspect ratio.
- ▶ Full: Keep original aspect ratio and resize to fit horizontal or vertical direction of the screen.

Slideshow Duration

Press ◀ or ▶ to select the slideshow duration.

Slideshow Repeat

- ▶ Choose "On" to repeat slideshow always.
- ▶ Choose "Off" to stop slideshow when it goes to the last page.

Slideshow Effect

Press ◀ or ▶ to select what slideshow effect you want. There are various kinds: Random, Snake, Partition, Erase, Blinds, Lines, GridCross, Cross, Spiral, Rect and Off.

SETUP | Music Setting

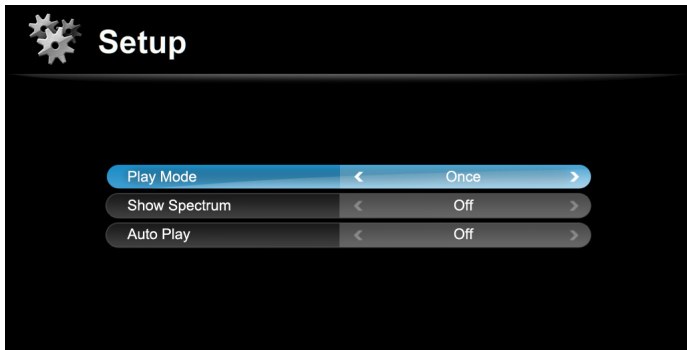

Play Mode

Press ◀ or ▶ to select the play mode.

- ▶ Once
- ▶ Repeat One
- ▶ Repeat
- ▶ Random

Show Spectrum

Choose “On” to show the spectrum plot while music is playing.

Auto Play

Choose “On” to play the music automatically while entering the file list.

SETUP | Video Setting

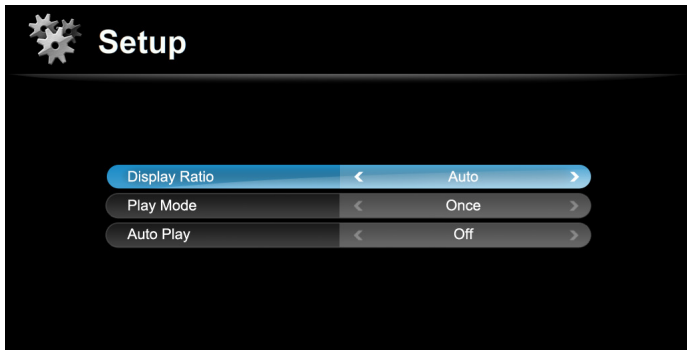

Display Ratio

Press ◀ or ▶ to select the display ratio.

- ▶ Auto: Fit full screen without keeping the original aspect ratio.
- ▶ Full: Keep original aspect ratio and resize to fit horizontal or vertical direction of the screen.

Play Mode

Press ◀ or ▶ to select the play mode.

- ▶ Once
- ▶ Repeat One
- ▶ Repeat
- ▶ Random

Auto Play

Choose "On" to play the video automatically while entering the file list.

SETUP | Firmware Upgrade

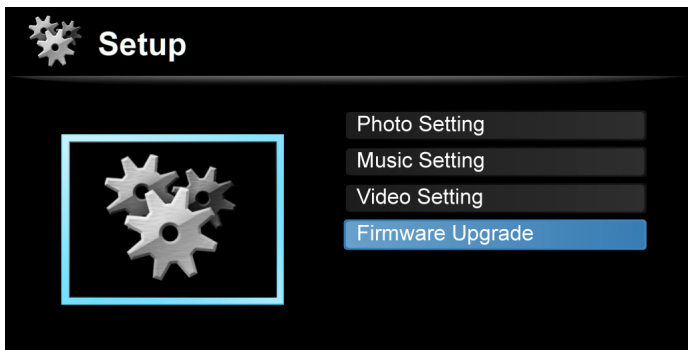

Firmware upgrade needs to be operated via SD card. Please download the latest firmware version of "PLED_W500_MM.bin" and save in your SD card.

Step

- ▶ Step 1: Insert the SD card to the SD card reader of the projector.
- ▶ Step 2: Move the bar to "Firmware Upgrade" and click on "Enter".
- ▶ Step 3: Click on "Yes" to start firmware upgrade.
- ▶ Step 4: Wait until the upgrade process complete.
- ▶ Step 5: The projector will automatically restart after upgrade complete.

Internal Memory

Internal memory is a form of computer data storage.

File Transfer

File Transfer can transfer your computer's data to the projector's internal memory by using a single USB cable (mini B type to A type). Your computer will detect the projector's "Internal Memory" as a storage device.

1. Press the "Enter" to select "File Transfer".
2. Connection: Connect the USB cable to the mini USB of projector and USB type A of the computer.
3. After the projector's memory is recognized by your computer, you can move your mouse to copy your movie/music/file to the projector's memory.

Projection with Wireless Presentation

1. Plug in an USB WiFi adapter (WPD-100) in USB type A slot of projector.
2. Press the “SD/USB” button on the remote control to choose the source to USB A and press “Enter”.
3. Follow the instructions to finish the installation.



192.168.100.10

To Project using Wireless Presentation

- 1 Select PLED-W500 from laptop/PC's wireless access point menu.
- 2 Open MirrorOp Lite Software, key in IP 192.168.100.10 and choose Connect to start projection.

To Install Wireless Presentation

- 1 Select PLED-W500 from laptop/PC's wireless access point menu.
 - 2 Open a Web browser and enter the wireless IP 192.168.100.10. The WEB Manager shows up.
 - 3 Choose Download and OS to start download MirrorOp Lite.
 - 4 Install MirrorOP Lite.
 - 5 Open MirrorOp Lite Software to start projection.
- Note: Disable firewall if encounter connection difficulty.

NOTE

- **Operating System:**
 1. For Windows: Windows XP SP2/SP3 (32 and 64-bit) / Vista (32 and 64-bit) / Windows 7 (32 and 64-bit).
 2. For Macintosh: Mac OS X 10.5, 10.6, 10.7
 - Recommended Models: MacBook after 2009-01-21 / All series of MacBook Pro / MacBook Air after 2010-06-08.
- Enable your WLAN of Notebook and select the access point labeled PLED-W500 to connect wirelessly. The Server IP indicates the IP address (192.168.100.10) which your projector uses to connect to the wireless network.

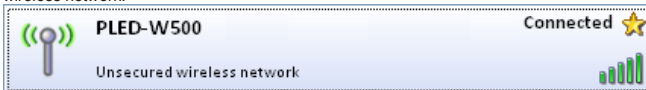

4. Execute the shortcut on desktop and you will see the UI shown as below.





Projection with MobiShow

MobiShow allows content projection from a Wi-Fi-enabled smartphone (Android, iPhone). Install application - MobiShow on smartphone and connect to wireless projector.

NOTE

- Windows Mobile is not supported.

MobiShow Utility for iPhone

1. Turn on WiFi on your phone.
2. Connect your phone to internet network.
3. Launch the App Store  and download the MobiShow application. 
4. Follow the instructions to finish the installation.
5. Remember to synchronize your picture or PTG2 file with your iPhone or iPad.

NOTE

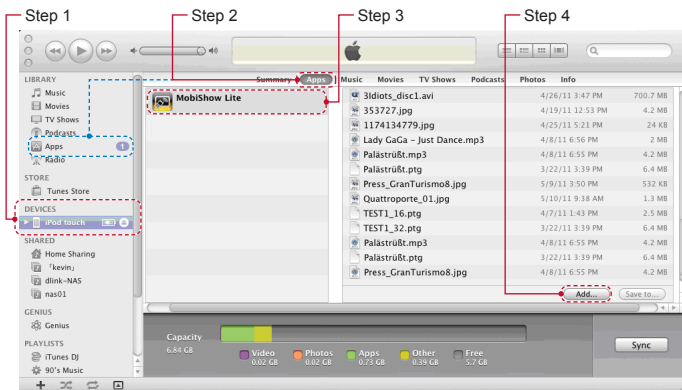

- Synchronize Files with iTunes
 1. Click "iTunes" icon  to launch the application on PC/Laptop.
 2. Connect your iPhone/iPod/iPad to PC/Laptop.
 3. Click the iPhone/iPod/iPad device under "Devices" on the left-hand side. (Step 1)
 4. Click the "Apps" tab to show the application list. (Step 2)
 - Some tabs may not appear if you do not have corresponding content in your library.
 5. Click "MobiShow" item and you can see everything uploaded by MobiShow. (Step 3)
 6. Click "Add" button and select the file to upload to your iPhone/iPod/iPad. (Step 4)



NOTE

- For more information, please visit <http://www.viewsonic.com/download.php?assetId=24433>



MobiShow Utility for Android

1. Turn on WiFi on your phone.
2. Connect your phone to internet network.
3. Open the Android Market  and download the MobiShow application. 
4. Follow the instructions to finish the installation.

Using the MobiShow

1. Enable the WiFi and connect to the Access Point where the MobiShow compatible device connected.
2. Select “MobiShow” icon  to launch the client software.
3. MobiShow client will start to search for MobiShow compatible devices automatically.



4. Select “Photo”  icon to project the photo files.
5. Select “PtG” icon  to do a PC-less presentation with Presentation-to-Go. (PtG)

MobiShow | Photo Viewer

You can use MobiShow to project photos stored on your phone to big screen. The photos will be prepared for playback on big screens rather than for the tiny screens of your phone.

Open and select the photo file, then project it on the big screen through MobiShow compatible device.

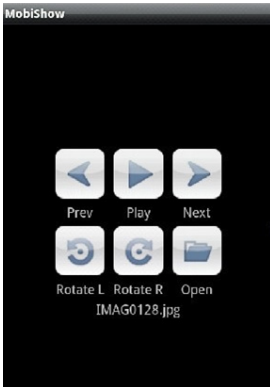

For Android system

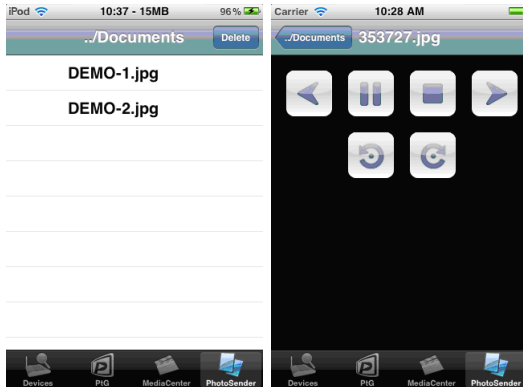

For iPhone/iPod/iPad

- ▶ Prev/Next: Tap to go to the previous or next item on the slide.
- ▶ Pause/Stop: Pause or stop playing photo.
- ▶ Rotate L/R: Rotate photo to left or right.

NOTE

- "Photo Viewer" supports Jpeg format only.

MobiShow | PtG2

You can use MobiShow to do the PC-less interactive presentation by PtG2 (Presentation to Go). When the PtG2 file is open, the PtG2 slides will be projected, and the following screen is displayed on your phone for you to control your PtG2 presentation.



- You need to use "PtG2 converter" to convert the PowerPoint file to the PtG2 file first.

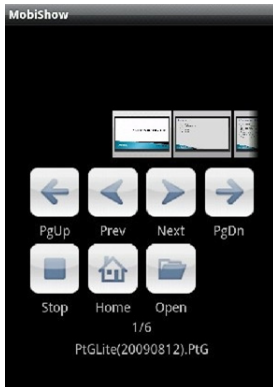

For Android system

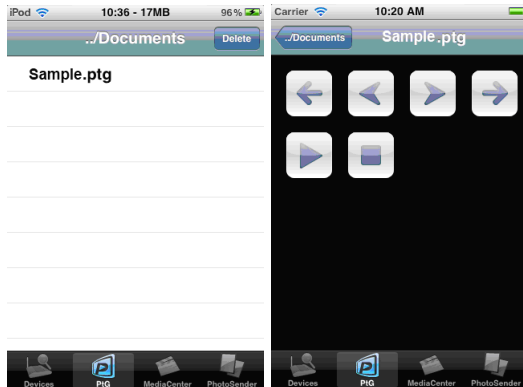

For iPhone/iPod/iPad

- ▶ Prev/Next: Tap to go to the previous or next item on the slide.
- ▶ PgUp/ PgDn: Tap to go to previous or next slide.
- ▶ Stop: Tap to stop projecting the file. The icon will become "Play" if the file is not being played. Tap "Play" again to play the file if it is stopped.
- ▶ Home: Tap to go to the first slide.
- ▶ Jump: Tap and MobiShow client will show thumbnails of every slide in the PtG file. You can select and go to any slide.
- ▶ Open: Tap to select another PtG2 file.



- PtG/PtG2 converts the file to 800x600 or 1024x768 resolutions.

Using the PtG2 Converter

1. Download the “PtG2-setup-v2.0.1.2.exe” from your PLED-W500 projector with connecting the USB cable to your computer/laptop via file transfer.



NOTE

- For more information of File Transfer, please refer to page 47.

2. Install “PtG2-setup-v2.0.1.2.exe” in your computer/laptop.
3. Open “Programs -> PtG Utility -> PtG2 Converter” from the Start menu. The following control panel is displayed on your desktop when it is launched.



Icon	Item	Description
	Convert	Select a PowerPoint file and start conversion. PtG2 Converter will open the PowerPoint file and convert it to PtG2 format. You can see the conversion process on your desktop.
	Preview	Expand or collapse the preview pane.
	Play	Playback the selected PtG2 file.
	Open	Select a PtG2 file.

NOTE

- Please close PowerPoint program before conversion.

Appendices

Troubleshooting

If you experience a problem with your projector, please refer to the following information. If a problem persists, please contact your local reseller or service center.

Image Problems

? No image appears on-screen

- ▶ Ensure all the cables and power connections are correctly and securely connected as described in the “Installation” section.
- ▶ Ensure the pins of connectors are not crooked or broken.
- ▶ Check if the projection lamp has been securely installed.
- ▶ Make sure you have removed the lens cap and the projector is switched on.

? Partial, scrolling or incorrectly displayed image

- ▶ Press “Auto” on the remote control or on the control panel.
 - If you are using a PC:
 - For Windows 95, 98, 2000, XP, Windows 7:
 1. Open the “My Computer” icon, the “Control Panel” folder, and then double click on the “Display” icon.
 2. Select the “Settings” tab.
 3. Verify that your display resolution setting is lower than or equal to 1080p.
 4. Click on the “Advanced Properties”.
 - For Windows Vista:
 1. From the “My Computer” icon, open the “Control Panel” folder, and double click the “Appearance and Personalization”
 2. Select “Personalization”.
 3. Click “Adjust screen resolution” to display “Display Settings”. Click on the “Advanced Settings”.

- If the projector is still not projecting the whole image, you will also need to change the monitor display you are using. Refer to the following steps.
 1. Select the “Change” under the “Monitor” tab.
 2. Click on “Show all devices”. Next, select “Standard monitor types” under the SP box; choose the resolution mode you need under the “Models” box.
 3. Verify that the resolution setting of the monitor display is lower than or equal to 1080p.
- If you are using a Notebook:
 - First, follow the steps above to adjust resolution of the computer.
 - Press the toggle output settings. example: [Fn]+[F4]

Notebook Brand	Function Keys
Acer	[Fn]+[F5]
Asus	[Fn]+[F8]
Dell	[Fn]+[F8]
Gateway	[Fn]+[F4]
IBM/Lenovo	[Fn]+[F7]
HP/Compaq	[Fn]+[F4]
NEC	[Fn]+[F3]
Toshiba	[Fn]+[F5]
Mac Apple	System Preference -> Display -> Arrangement -> Mirror display

- If you experience difficulty changing resolutions or your monitor freezes, restart all equipment including the projector.

? The screen of the Notebook or PowerBook computer is not displaying your presentation

Some Notebook PCs may deactivate their own screens when a second display device is in use. Each has a different way to be reactivated. Refer to your computer’s documentation for detailed information.

? Image is unstable or flickering

- ▶ Adjust the “Phase” to correct it. Refer to the “SETTING | Signal” section for more information.
- ▶ Change the monitor color setting from your computer.

? **Image has vertical flickering bar**

- ▶ Use “Clock” to make an adjustment. Refer to the “SETTING | Signal” section for more information.
- ▶ Check and reconfigure the display mode of your graphic card to make it compatible with the product.

? **Image is out of focus**

- ▶ Make sure the lens cap is removed.
- ▶ Adjust the “Focus Ring” on the projector lens.
- ▶ Make sure the projection screen is within the required distance of 1.71-9.84 feet (0.52-3.00 meters) from the projector.

? **The image is stretched when displaying 16:9 DVD title**

When you play anamorphic DVD or 16:9 DVD, the projector will show the best image in 16: 9 format on projector side.

- ▶ If you play 4:3 format DVD title, please change the format as 4:3 in projector OSD.
- ▶ If the image is still stretched, you will also need to setup the display format as 16:9 (wide) aspect ratio type on your DVD player.

? **Image is too small or too large**

- ▶ Move the projector closer to or further from the screen.
- ▶ Press “Menu” on the remote control or on the control panel. Go to “SCREEN” --> “Aspect Ratio” and try the different settings.

? **Image has slanted sides:**

- ▶ If possible, reposition the projector so that it is centered on the screen and below the bottom of the screen.
- ▶ Use “SCREEN” --> “V Keystone” from the OSD to make an adjustment.

? **Image is reversed**

- ▶ If the projector is mounted on the ceiling, select “SCREEN” --> “Auto Ceil Mount” from the OSD and adjust the projection direction.
- ▶ If the projector is placed on the desk, select “SETTING” --> “Orientation” from the OSD and adjust the projection direction.

Projector Problems

? The projector stops responding to all controls

- ▶ If possible, turn off the projector, then unplug the power cord and wait at least 20 seconds before reconnecting power.

Multi-media Problems

? USB/SD read fail

- ▶ Please make sure the USB device or SD card is good and well inserted. Remove to try for several times if necessary.

? USB drive fail

- ▶ USB does not support USB hub function and which power consumption is over 500mA.

? Media file not found or can't be opened in file list

- ▶ The files by un-supported codec won't be shown on file list. Please check the media support table again in this manual.

On Screen Messages

- Power off confirm

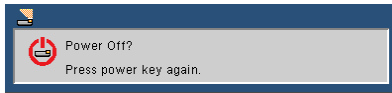

- Fan lock error

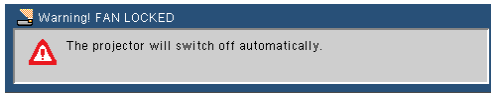

- No source found

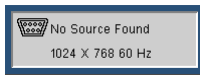

- Out of display range

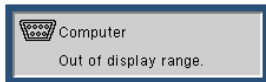

- Mute



- Thermal sensor error

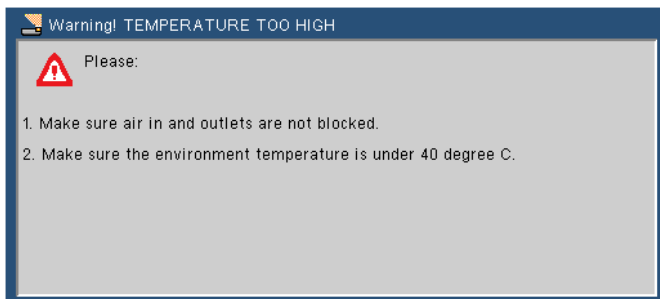

Piscel Support Languages, Character Encodings and Fonts

1. Office reader language supported (Piscel's font):

1	Czech	6	Germany	11	Polish	16	Thai
2	Danish	7	Hungarian	12	Iberian Portuguese	17	Turkish
3	Dutch	8	Italian	13	Russian	18	Vietnamese
4	English	9	Japanese	14	Spanish	19	Traditional Chinese
5	French	10	Korea	15	Swedish	20	Simplified Chinese

2. Internationalization and languages

Feature	Support	Notes
International language formatting	Partial	Some local date formats, special layout styles.
Vertical text (as used in Chinese)	No	
Local numbering sequence formats	No	

3. Font

Feature	Support	Notes
Fonts embedded in MS Office documents	No	
Fonts linked and downloaded with documents (eg HTML)	No	
Compressed TrueType fonts for MS Windows Mobile	No	
Bitmap fonts	No	
Hinting of glyph shapes	No	
Vertical reading or vertical cursor advance	No	
Multiple colours within font glyphs	No	

4. Autoshapes

Feature	Support	Notes
Gradient fill	Most	Vertical, horizontal, diagonal, centre-square two colour gradients.
Line dash style	No	Shown as solid lines
Arrowhead end styles	Partial	Not all line ending shapes
Shape control point	Most	The control points of most shapes behave consistently with MS Office.
Text within autoshapes	Partial	Text can appear in autoshapes in Excel and PowerPoint.
Action button images	No	

5. MS Word

Feature	Support	Notes
Bold text	Partial	Not supported in Simple Chinese font.
Text alignment: <ul style="list-style-type: none"> Fully Justified 	No	Displayed as left aligned text.
Tab stops	Partial	Supports default tab stops and custom position tab stops. Supports left aligned tab stops only. Tabs with leader characters are not supported.
Tables with Indentation, Bullets, Numbering and style changes	Partial	Multiple numbered lists in different columns, and some style features are not supported
Table border styles	Partial	Supports - single solid line - double solid line
Nested tables	Partial	Some nested tables are incorrectly displayed
Vertical cell merging	No	
Page margins and borders	Partial	Page margins are supported, but we do not display page borders
Document Views	Partial	ePAGE always opens up a document in 'print' view format.
Comments	No	
Footnotes/endnotes	No	
Change tracking	No	
Continuous sections	No	Continuous section breaks will be shown as "next page breaks". If a document has multiple continuous section breaks within a page, FileViewer will display this as multiple pages.
Fields and equations	No	
"Ruby" Kanji and Kana	No	
Line styles	Most	Only solid line styles are supported. All line weights are supported
Line dash styles	Some	Only solid dash styles are supported. Dashed and dotted lines are rendered as solid lines
Gradient fill colours in autoshapes	Most	Horizontal, vertical, diagonal, centre-square
Supports Word Art	No	
Flows text around positioned images according to rules set within the original Word document <ul style="list-style-type: none"> Square wrapping style Tight wrapping style 	Partial	Image is positioned either to left or right margin, and text flowed to one side.
Flows text around positioned images according to rules set within the original Word document <ul style="list-style-type: none"> Variable (edited) wrap points 	No	Image will appear with square wrapping.

6. MS Excel

Feature	Support	Notes
Supports page size	No	Not meaningful as view shows worksheet, not print view
Supports headers and footers: <ul style="list-style-type: none"> • Workbook name • Current date • Current time • Page number plus/minus n • Total pages in workbook • Ampersand character 	No	
Displays cell row and column headings	No	
Retains "frozen titles" for rows and columns when scrolling	No	
Displays page breaks within a worksheet (both horizontal and vertical breaks)	No	Not needed as sheet is not printed
Supports background image on worksheets	No	
Supports cell background fill pattern	No	
Provides facility to either hide or display rows, columns or sheets that are hidden	No	
Supports scenarios, displays names of scenarios contained in worksheet	No	Displays only the default scenario
Provides facility to select scenario and display cell contents accordingly	No	
Supports all number formats: <ul style="list-style-type: none"> • Number • Currency • Accounting • Date • Time • Percentage • Fraction • Scientific • Special • Custom 	Partial	Individual number format support is detailed in the section "Number format support"
Bold text	Partial	When used with a bold font installed. Not supported in Chinese Simple font.
Indentation	No	
Displays comments associated with a cell	No	
Supports hyperlinks to other files and web pages	No	
Supports hyperlinks attached to graphics and images	No	
Displays screen tips associated with hyperlinks	No	
Animated GIF images contained in Excel documents.	No	
Line styles	Most	Only solid line styles are supported. All line weights are supported
Line dash styles	Some	Only solid dash styles are supported. Dashed and dotted lines are rendered as solid lines
Text boxes	Partial	Including vertical alignment of text within box, but not text formatting or styling.
Autoshapes	Most	Refer to the section on 'Autoshapes' for more information.

Feature	Support	Notes
Gradient fill colours in autoshapes	Most	Horizontal, vertical, diagonal, centre-square
Supports WordArt	No	
Marks cells that have been changed using the Excel Highlight Changes command	No	
Displays lists according to any filters that are applied	No	
Supports pivot tables	No	
Displays form controls (buttons, check boxes, listboxes etc)	Partial	Displays ActiveX Controls, not 'regular' Form Controls. Also, ActiveX Controls are only displayed as static (non-interactive) objects.
Runs macros or scripts associated with form controls	No	
Displays phonetic guides for Japanese text: <ul style="list-style-type: none"> ● Hiragana ● Full width katakana ● Half width katakana 	No	

7. MS Excel Chart

Feature	Support	Notes
Supports Excel 95 (BIFF7) charts	No	
Supports Excel 5 (BIFF5) format charts	No	
Chart Legends	Partial	
Data Labels	No	
Grid Lines	Partial	
Tickmarks on lines	Partial	
Rotated text in charts	No	
Supports Organisation charts	No	
Supports Radar charts	No	
Supports Scatter charts	No	
Supports Area charts	No	
Supports Surface charts	No	
Supports Bubble charts	No	
Supports Doughnut charts	No	
Supports Stock charts	No	
Supports Combination charts	No	

Feature	Support	Notes
Supports Chart data tables	No	
Displays chart embedded within a chart which is a separate page	No	
Error bars	No	
Line markers	No	
Bitmap fill patterns	No	
3D effects in any chart	No	

8. MS PowerPoint

Feature	Support	Notes
Bold text	Partial	Not supported in Simple Chinese font.
Numbered lists	No	
Line dash styles	Some	Only solid dash styles are supported. Dashed and dotted lines are rendered as solid lines
Animations and slide transitions	No	
Hyperlinks and actions	No	
Smart Art diagrams	No	

9. Adobe PDF

Feature	Support	Notes
Supports later PDF documents using backwards compatible features	Partial	The PDF format has been carefully designed to encourage backwards compatibility, allowing older applications to read newer files in many cases. This is supported where feasible.
Bold text	Partial	Not supported in Simple Chinese font.
Table border styles	Partial	Supports - single solid line - double solid line
Transformed images	Partial	Supports image rotation by 90, 180, 270 degrees, flipped images
Monochrome and Colour content <ul style="list-style-type: none"> ● DeviceGray ● DeviceRGB ● DeviceCMYK ● CalGray* ● CalRGB* ● Indexed ● DeviceN 	Most	Calgray and CalRGB are treated as DeviceGray and DeviceRGB

Compatibility Modes

- VGA Analog
 - PC signal

Modes	Resolution	V. Frequency [Hz]	H. Frequency [Hz]
VGA	640x480	60	31.5
	640x480	72	37.9
	640x480	75	37.5
	640x480	85	43.3
SVGA	800x600	56	35.1
	800x600	60	37.9
	800x600	72	48.1
	800x600	75	46.9
	800x600	85	53.7
XGA	1024x768	60	48.4
	1024x768	70	56.5
	1024x768	75	60.0
	1024x768	85	68.7
SXGA	1280x1024	60	64.0
	1280x1024	72	77.0
	1280x1024	75	80.0
QuadVGA	1280x960	60	60.0
	1280x960	75	75.2
SXGA+	1400x1050	60	65.3

- Extended wide timing

Modes	Resolution	V. Frequency [Hz]	H. Frequency [Hz]
WXGA	1280x768	60	47.8
	1280x720	60	44.8
	1280x800	60	49.6
	1366x768	60	47.7
	1440x900	60	59.9
WSXGA+	1680x1050	60	65.3

- Component signal

Modes	Resolution	V. Frequency [Hz]	H. Frequency [Hz]
480i	720x480(1440x480)	59.94(29.97)	15.7
576i	720x576(1440x576)	50(25)	15.6
480p	720x480	59.94	31.5
576p	720x576	50	31.3
720p	1280x720	60	45.0
720p	1280x720	50	37.5
1080i	1920x1080	60(30)	33.8
1080i	1920x1080	50(25)	28.1
1080p	1920x1080	23.97/24	27.0
1080p	1920x1080	60	67.5
1080p	1920x1080	50	56.3

- HDMI Digital
 - PC signal

Modes	Resolution	V. Frequency [Hz]	H. Frequency [Hz]
VGA	640x480	60	31.5
	640x480	72	37.9
	640x480	75	37.5
	640x480	85	43.3
SVGA	800x600	56	35.1
	800x600	60	37.9
	800x600	72	48.1
	800x600	75	46.9
	800x600	85	53.7
XGA	1024x768	60	48.4
	1024x768	70	56.5
	1024x768	75	60.0
	1024x768	85	68.7
SXGA	1280x1024	60	64.0
	1280x1024	72	77.0
	1280x1024	75	80.0
QuadVGA	1280x960	60	60.0
	1280x960	75	75.2
SXGA+	1400x1050	60	65.3

- Extended wide timing

Modes	Resolution	V. Frequency [Hz]	H. Frequency [Hz]
WXGA	1280x768	60	47.8
	1280x720	60	44.8
	1280x800	60	49.6
	1366x768	60	47.7
	1440x900	60	59.9
WSXGA+	1680x1050	60	65.3

- Video signal

Modes	Resolution	V. Frequency [Hz]	H. Frequency [Hz]
480i	720x480(1440x480)	59.94(29.97)	15.7
576i	720x576(1440x576)	50(25)	15.6
480p	720x480	59.94	31.5
576p	720x576	50	31.3
720p	1280x720	60	45.0
720p	1280x720	50	37.5
1080i	1920x1080	60(30)	33.8
1080i	1920x1080	50(25)	28.1
1080p	1920x1080	23.97/24	27.0
1080p	1920x1080	60	67.5
1080p	1920x1080	50	56.3
Graphic source monitor range limits		Horizontal scan rate:	30k - 100kHz
		Vertical scan rate:	50 - 85Hz
		Max. pixel rate	150MHz

Multi-media Format Supported

JPEG Decode	Supports JPEG picture formats
	Thumbnails preview
	Supports BMP picture formats
Video Decode and Movie Formats	Supports MJPEG
	Supports H263, H264
	Supports AVI, MOV movie formats
	Supports 3gp movie format
Music Formats	Supports PCM, ADPCM audio formats
	Supports WMA/OGG/MP3
Card Reader Interface	Supports SD memory card
	Supports SDHC memory card
USB Interface	Supports mass storage class
	Supports USB2.0

- Photo Format

Image type (ext name)	Sub type	Encode type	Max pixels
Jpeg / Jpg	Baseline	YUV420	No Limitation
		YUV422	
		YUV440	
		YUV444	
	Progressive	YUV420	5120 X 3840
		YUV422	
		YUV440	
		YUV444	
BMP			No Limitation

- Video Format

File format	Video format	MAX resolution	MAX bit rate	Frame rate	Audio format	Remark
AVI MKV DIVX	DIVX4/5/6 XVID MPEG-2/4 H.264 M-JPEG WMV3	1080P	20Mbps	30fps	AC3 DTS MPEG1/2/3 PCM ADPCM AAC	No support VC-1 AP H. 264 support less than 4 reference frames
TS	MPEG-2 H.264	1080P	20Mbps	30fps	AC3 DTS MPEG1/2/3 LPCM AAC	H. 264 support less than 4 reference frames
DAT VOB MPG MPEG	MPEG-1 MPEG-2	1080P	20Mbps	30fps	MPEG1/2/3 AC3 DTS LPCM	-
MOV MP4 3GP	MPEG-4 H.264 H.263	1080P	20Mbps	30fps	AC3 AMR PCM AAC	H. 264 support less than 4 reference frames
RM RMVB	RV3 RV4	720P	5Mbps	30fps	Cook (RA6) AAC (RA9) RACP (RA10)	-
WMV	WMV3	1080P	20Mbps	30fps	WMA2 WMA3	No support VC-1 AP



■ Doesn't support B-Frame function.

- Music Format

Music type (ext name)	Sample rate (KHz)	Bit rate (Kbps)
MP3	8-48	8-320
WMA	22-48	5-320
OGG	8-48	64-320
ADPCM-WAV	8-48	32-384
PCM-WAV	8-48	128-1536
AAC	8-48	8-256

Ceiling Mount Installation

If you wish to use a third party ceiling mount kit, please ensure the screws which are used to attach a mount to the projector meet the following specifications:

- Screw type: M3
 - Diameter: 3 mm
 - Length: 25 mm



■ Please note that damage resulting from incorrect installation will invalidate the warranty.

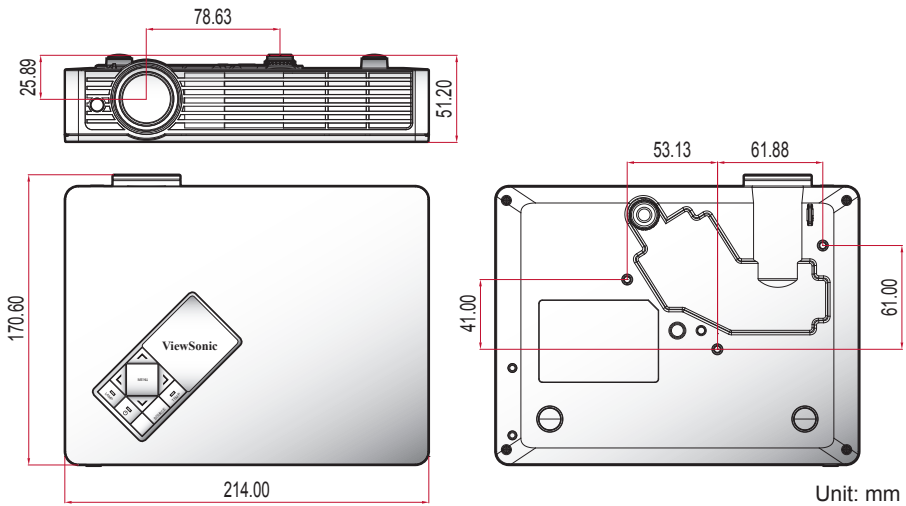

Specifications

Projection system	DLP®
Resolution	WXGA (1280 x 800)
Computer compatibility	IBM PC and compatibles, Apple Macintosh, iMac and VESA standards: SXGA, XGA, SVGA, VGA, WXGA
Video compatibility	NTSC (3.58/4.43), PAL (B/D/G/H/I/M/N), SECAM (B/D/G/ K/ K1/L), HDTV (480i, 576i, 480p, 576p, 720p, 1080i, 1080p)
Aspect ratio	Auto, 4:3, 16:9, 16:10
Displayable colors	1.07 billion colors
Projection lens	F# 1.5, f = 13.92 mm
Projection screen size	30" - 80"
Projection distance	0.9 m - 2.4 m
Throw ratio	1.4
Horizontal scan rate	30 k - 100 kHz
Vertical refresh scan rate	50 - 85 Hz
Keystone correction	+/- 40 degrees
Weight	1.2 Kg (2.6 lbs)
Dimensions (W x D x H)	214mm x 164mm x 42.5mm
Power supply	AC 100 - 240 V, 50 - 60 Hz
Power consumption	<ul style="list-style-type: none"> • Normal mode: 120W +/- 20% @ 110Vac (Bright mode @ full power) • ECO mode: 60W +/-20% @ 110Vac (Video mode @ eco power) • Standby < 0.5 W
Operating temperature	5°C to 35°C / 41°F to 95°F
I/O connectors	<ul style="list-style-type: none"> • Power socket x 1 • SD card reader x 1 • USB A x 1 • HDMI x 1 • VGA x 1 • S-Video x 1 • Composite x 1 • Audio output x 1 • Mini USB B x 1

Standard package contents

- AC power cord x 1
- VGA cable x 1
- Remote control x 1
- AAA Batteries (for remote control) x 2
- Soft carrying bag x 1
- User's guide (DVD) x 1
- Quick start card x 1
- Warranty card x 1



NOTE

- *Design and specifications are subject to change without prior notice.*

Customer Support

For technical support or product service, see the table below or contact your reseller.

Note : You will need the product serial number.

Country/Region	Website	T = Telephone F = FAX	Email
Australia/New Zealand	www.viewsonic.com.au	AUS= 1800 880 818 NZ= 0800 008 822	service@au.viewsonic.com
Canada	www.viewsonic.com	T (Toll-Free)= 1-866-463-4775 T (Toll)= 1-424-233-2533 F= 1-909-468-3757	service.ca@viewsonic.com
Europe	www.viewsoniceurope.com	www.viewsoniceurope.com/uk/Support/Calldesk.htm	
Hong Kong	www.hk.viewsonic.com	T= 852 3102 2900	service@hk.viewsonic.com
India	www.in.viewsonic.com	T= 1800 266 0101	service@in.viewsonic.com
Ireland (Eire)	www.viewsoniceurope.com/uk/	www.viewsoniceurope.com/uk/support/call-desk/	service_ie@viewsoniceurope.com
Korea	www.kr.viewsonic.com	T= 080 333 2131	service@kr.viewsonic.com
Latin America (Argentina)	www.viewsonic.com/la/	T= 0800-4441185	soporte@viewsonic.com
Latin America (Chile)	www.viewsonic.com/la/	T= 1230-020-7975	soporte@viewsonic.com
Latin America (Columbia)	www.viewsonic.com/la/	T= 01800-9-157235	soporte@viewsonic.com
Latin America (Mexico)	www.viewsonic.com/la/	T= 001-8882328722	soporte@viewsonic.com
Renta y Datos, 29 SUR 721, COL. LA PAZ, 72160 PUEBLA, PUE. Tel: 01.222.891.55.77 CON 10 LINEAS Electroser, Av Reforma No. 403Gx39 y 41, 97000 Mérida, Yucatán. Tel: 01.999.925.19.16 Other places please refer to http://www.viewsonic.com/la/soporte/index.htm#Mexico			
Latin America (Peru)	www.viewsonic.com/la/	T= 0800-54565	soporte@viewsonic.com
Macau	www.hk.viewsonic.com	T= 853 2870 0303	service@hk.viewsonic.com
Middle East	ap.viewsonic.com/me/	Contact your reseller	service@ap.viewsonic.com
Puerto Rico & Virgin Islands	www.viewsonic.com	T= 1-800-688-6688 (English) T= 1-866-379-1304 (Spanish) F= 1-909-468-3757	service.us@viewsonic.com soporte@viewsonic.com
Singapore/Malaysia/Thailand	www.viewsonic.com.sg	T= 65 6461 6044	service@sg.viewsonic.com
South Africa	ap.viewsonic.com/za/	Contact your reseller	service@ap.viewsonic.com
United Kingdom	www.viewsoniceurope.com/uk/	www.viewsoniceurope.com/uk/support/call-desk/	service_gb@viewsoniceurope.com
United States	www.viewsonic.com	T (Toll-Free)= 1-800-688-6688 T (Toll)= 1-424-233-2530 F= 1-909-468-3757	service.us@viewsonic.com

Limited Warranty

VIEWSONIC® PROJECTOR

What the warranty covers:

ViewSonic warrants its products to be free from defects in material and workmanship, under normal use, during the warranty period. If a product proves to be defective in material or workmanship during the warranty period, ViewSonic will, at its sole option, repair or replace the product with a like product. Replacement product or parts may include remanufactured or refurbished parts or components.

Limited Three (3) year General Warranty

Subject to the more limited one (1) year warranty set out below, North and South America: Three (3) years warranty for all parts excluding the lamp, three (3) years for labor, and one (1) year for the original lamp from the date of the first consumer purchase; Europe except Poland: Three (3) years warranty for all parts excluding the lamp, three (3) years for labor, and ninety (90) days for the original lamp from the date of the first consumer purchase; Poland: Two (2) years warranty for all parts excluding the lamp, two (2) years for labor, and ninety (90) days for the original lamp from the date of the first consumer purchase.

Limited One (1) year Heavy Usage Warranty:

Under heavy usage settings, where a projector's use includes more than fourteen (14) hours average daily usage, North and South America: One (1) year warranty for all parts excluding the lamp, one (1) year for labor, and ninety (90) days for the original lamp from the date of the first consumer purchase; Europe: One (1) year warranty for all parts excluding the lamp, one (1) year for labor, and ninety (90) days for the original lamp from the date of the first consumer purchase.

Other regions or countries: Please check with your local dealer or local ViewSonic office for the warranty information.

Lamp warranty subject to terms and conditions, verification and approval. Applies to manufacturer's installed lamp only. All accessory lamps purchased separately are warranted for 90 days.

Who the warranty protects:

This warranty is valid only for the first consumer purchaser.

What the warranty does not cover:

1. Any product on which the serial number has been defaced, modified or removed.
2. Damage, deterioration, failure, or malfunction resulting from:
 - a. Accident, abuse, misuse, neglect, fire, water, lightning, or other acts of nature, improper maintenance, unauthorized product modification, or failure to follow instructions supplied with the product.
 - b. Operation outside of product specifications.
 - c. Operation of the product for other than the normal intended use or not under normal conditions.
 - d. Repair or attempted repair by anyone not authorized by ViewSonic.
 - e. Any damage of the product due to shipment.
 - f. Removal or installation of the product.
 - g. Causes external to the product, such as electric power fluctuations or failure.
 - h. Use of supplies or parts not meeting ViewSonic's specifications.
 - i. Normal wear and tear.
 - j. Any other cause which does not relate to a product defect.
3. Removal, installation, and set-up service charges.

How to get service:

1. For information about receiving service under warranty, contact ViewSonic Customer Support (please refer to "Customer Support" page). You will need to provide your product's serial number.
2. To obtain warranted service, you will be required to provide (a) the original dated sales slip, (b) your name, (c) your address, (d) a description of the problem, and (e) the serial number of the product.
3. Take or ship the product freight prepaid in the original container to an authorized ViewSonic service center or ViewSonic.
4. For additional information or the name of the nearest ViewSonic service center, contact ViewSonic.

Limitation of implied warranties:

There are no warranties, express or implied, which extend beyond the description contained herein including the implied warranty of merchantability and fitness for a particular purpose.

Exclusion of damages:

ViewSonic's liability is limited to the cost of repair or replacement of the product. ViewSonic shall not be liable for:

1. Damage to other property caused by any defects in the product, damages based upon inconvenience, loss of use of the product, loss of time, loss of profits, loss of business opportunity, loss of goodwill, interference with business relationships, or other commercial loss, even if advised of the possibility of such damages.
2. Any other damages, whether incidental, consequential or otherwise.
3. Any claim against the customer by any other party.

Effect of state law:

This warranty gives you specific legal rights, and you may also have other rights which vary from state to state. Some states do not allow limitations on implied warranties and/or do not allow the exclusion of incidental or consequential damages, so the above limitations and exclusions may not apply to you.

Sales outside the U.S.A. and Canada:

For warranty information and service on ViewSonic products sold outside of the U.S.A. and Canada, contact ViewSonic or your local ViewSonic dealer.

The warranty period for this product in mainland China (Hong Kong, Macao and Taiwan Excluded) is subject to the terms and conditions of the Maintenance Guarantee Card.

For users in Europe and Russia, full details of warranty provided can be found in www.viewsoniceurope.com under Support/Warranty Information.

4.3: Projector Warranty

PRJ_LW01 Rev. 1h 06-25-07

Mexico Limited Warranty

VIEWSONIC® PROJECTOR

What the warranty covers:

ViewSonic warrants its products to be free from defects in material and workmanship, under normal use, during the warranty period. If a product proves to be defective in material or workmanship during the warranty period, ViewSonic will, at its sole option, repair or replace the product with a like product. Replacement product or parts may include remanufactured or refurbished parts or components & accessories.

How long the warranty is effective:

3 years for all parts excluding the lamp, 3 years for labor, 1 year for the original lamp from the date of the first consumer purchase.

Lamp warranty subject to terms and conditions, verification and approval. Applies to manufacturer's installed lamp only.

All accessory lamps purchased separately are warranted for 90 days.

Who the warranty protects:

This warranty is valid only for the first consumer purchaser.

What the warranty does not cover:

1. Any product on which the serial number has been defaced, modified or removed.
2. Damage, deterioration or malfunction resulting from:
 - a. Accident, misuse, neglect, fire, water, lightning, or other acts of nature, unauthorized product modification, unauthorized attempted repair, or failure to follow instructions supplied with the product.
 - b. Any damage of the product due to shipment.
 - c. Causes external to the product, such as electrical power fluctuations or failure.
 - d. Use of supplies or parts not meeting ViewSonic's specifications.
 - e. Normal wear and tear.
 - f. Any other cause which does not relate to a product defect.
3. Any product exhibiting a condition commonly known as "image burn-in" which results when a static image is displayed on the product for an extended period of time.
4. Removal, installation, insurance, and set-up service charges.

How to get service:

For information about receiving service under warranty, contact ViewSonic Customer Support (Please refer to the attached Customer Support page). You will need to provide your product's serial number, so please record the product information in the space provided below on your purchase for your future use. Please retain your receipt of proof of purchase to support your warranty claim.

For Your Records

Product Name: _____

Model Number: _____

Document Number: _____

Serial Number: _____

Purchase Date: _____

Extended Warranty Purchase? _____ (Y/N)

N)

If so, what date does warranty expire? _____

1. To obtain warranty service, you will be required to provide (a) the original dated sales slip, (b) your name, (c) your address, (d) a description of the problem, and (e) the serial number of the product.
2. Take or ship the product in the original container packaging to an authorized ViewSonic service center.
3. Round trip transportation costs for in-warranty products will be paid by ViewSonic.

Limitation of implied warranties:

There are no warranties, express or implied, which extend beyond the description contained herein including the implied warranty of merchantability and fitness for a particular purpose.

Exclusion of damages:

ViewSonic's liability is limited to the cost of repair or replacement of the product. ViewSonic shall not be liable for:

1. Damage to other property caused by any defects in the product, damages based upon inconvenience, loss of use of the product, loss of time, loss of profits, loss of business opportunity, loss of goodwill, interference with business relationships, or other commercial loss, even if advised of the possibility of such damages.
2. Any other damages, whether incidental, consequential or otherwise.
3. Any claim against the customer by any other party.
4. Repair or attempted repair by anyone not authorized by ViewSonic.

Contact Information for Sales & Authorized Service (Centro Autorizado de Servicio) within Mexico:	
Name, address, of manufacturer and importers: México, Av. de la Palma #8 Piso 2 Despacho 203, Corporativo Interpalmas, Col. San Fernando Huixquilucan, Estado de México Tel: (55) 3605-1099 http://www.viewsonic.com/la/soporte/index.htm	
NÚMERO GRATIS DE ASISTENCIA TÉCNICA PARA TODO MÉXICO: 001.866.823.2004	
Hermosillo: Distribuciones y Servicios Computacionales SA de CV. Calle Juarez 284 local 2 Col. Bugambillas C.P: 83140 Tel: 01-66-22-14-9005 E-Mail: disc2@hmo.megared.net.mx	Villahermosa: Compumantenimientos Garantizados, S.A. de C.V. AV. GREGORIO MENDEZ #1504 COL. FLORIDA C.P. 86040 Tel: 01 (993) 3 52 00 47 / 3522074 / 3 52 20 09 E-Mail: compumantenimientos@prodigy.net.mx
Puebla, Pue. (Matriz): RENTA Y DATOS, S.A. DE C.V. Domicilio: 29 SUR 721 COL. LA PAZ 72160 PUEBLA, PUE. Tel: 01(52).222.891.55.77 CON 10 LINEAS E-Mail: datos@puebla.megared.net.mx	Veracruz, Ver.: CONEXION Y DESARROLLO, S.A DE C.V. Av. Americas # 419 ENTRE PINZÓN Y ALVARADO Fracc. Reforma C.P. 91919 Tel: 01-22-91-00-31-67 E-Mail: gacosta@qplus.com.mx
Chihuahua Soluciones Globales en Computación C. Magisterio # 3321 Col. Magisterial Chihuahua, Chih. Tel: 4136954 E-Mail: Cefeo@soluglobales.com	Cuernavaca Compusupport de Cuernavaca SA de CV Francisco Leyva # 178 Col. Miguel Hidalgo C.P. 62040, Cuernavaca Morelos Tel: 01 777 3180579 / 01 777 3124014 E-Mail: aquevedo@compusupportcva.com
Distrito Federal: QPLUS, S.A. de C.V. Av. Coyoacán 931 Col. Del Valle 03100, México, D.F. Tel: 01(52)55-50-00-27-35 E-Mail : gacosta@qplus.com.mx	Guadalajara, Jal.: SERVICIRECE, S.A. de C.V. Av. Niños Héroes # 2281 Col. Arcos Sur, Sector Juárez 44170, Guadalajara, Jalisco Tel: 01(52)33-36-15-15-43 E-Mail: mmiranda@servicirece.com
Guerrero Acapulco GS Computación (Grupo Sasicomp) Progreso #6-A, Colo Centro 39300 Acapulco, Guerrero Tel: 744-48-32627	Monterrey: Global Product Services Mar Caribe # 1987, Esquina con Golfo Pérsico Fracc. Bernardo Reyes, CP 64280 Monterrey N.L. México Tel: 8129-5103 E-Mail: aydeem@gps1.com.mx
MÉRIDA: ELECTROSER Av Reforma No. 403Gx39 y 41 Mérida, Yucatán, México CP97000 Tel: (52) 999-925-1916 E-Mail: rrrb@sureste.com	Oaxaca, Oax.: CENTRO DE DISTRIBUCION Y SERVICIO, S.A. de C.V. Murguía # 708 P.A., Col. Centro, 68000, Oaxaca Tel: 01(52)95-15-15-22-22 Fax: 01(52)95-15-13-67-00 E-Mail: gpotai2001@hotmail.com
Tijuana: STD Av Ferrocarril Sonora #3780 L-C Col 20 de Noviembre Tijuana, Mexico	FOR USA SUPPORT: ViewSonic Corporation 381 Brea Canyon Road, Walnut, CA. 91789 USA Tel: 800-688-6688 (English); 866-323-8056 (Spanish); Fax: 1-800-685-7276 E-Mail: http://www.viewsonic.com



ViewSonic®

Free Manuals Download Website

<http://myh66.com>

<http://usermanuals.us>

<http://www.somanuals.com>

<http://www.4manuals.cc>

<http://www.manual-lib.com>

<http://www.404manual.com>

<http://www.luxmanual.com>

<http://aubethermostatmanual.com>

Golf course search by state

<http://golfingnear.com>

Email search by domain

<http://emailbydomain.com>

Auto manuals search

<http://auto.somanuals.com>

TV manuals search

<http://tv.somanuals.com>