

ViewSonic®

WPG-360

Wireless Presentation Gateway

- **User Guide**
- **Guide de l'utilisateur**
- **Bedienungsanleitung**
- **Guía del usuario**
- **Руководство пользователя**
- **使用手冊 (繁中)**
- **使用手冊 (簡中)**



Model No. : VS13670

Compliance Information

For U.S.A.

This device complies with part 15 of FCC Rules. Operation is subject to the following two conditions: (1) this device may not cause harmful interference, and (2) this device must accept any interference received, including interference that may cause undesired operation.

This equipment has been tested and found to comply with the limits for a Class B digital device, pursuant to part 15 of the FCC Rules. These limits are designed to provide reasonable protection against harmful interference in a residential installation.

This equipment generates, uses, and can radiate radio frequency energy, and if not installed and used in accordance with the instructions, may cause harmful interference to radio communications. However, there is no guarantee that interference will not occur in a particular installation. If this equipment does cause harmful interference to radio or television reception, which can be determined by turning the equipment off and on, the user is encouraged to try to correct the interference by one or more of the following measures:

- Reorient or relocate the receiving antenna.
- Increase the separation between the equipment and receiver.
- Connect the equipment into an outlet on a circuit different from that to which the receiver is connected.
- Consult the dealer or an experienced radio/TV technician for help.

Warning: You are cautioned that changes or modifications not expressly approved by the party responsible for compliance could void your authority to operate the equipment.

For Canada

- This Class B digital apparatus complies with Canadian ICES-003.
- Cet appareil numérique de la classe B est conforme à la norme NMB-003 du Canada.

CE Conformity for European Countries

 The device complies with the EMC Directive 2004/108/EC and Low Voltage Directive 2006/95/EC.

Following information is only for EU-member states:

The mark shown to the right is in compliance with the Waste Electrical and Electronic Equipment Directive 2002/96/EC (WEEE).

The mark indicates the requirement NOT to dispose the equipment as unsorted municipal waste, but use the return and collection systems according to local law.

If the batteries, accumulators and button cells included with this equipment, display the chemical symbol Hg, Cd, or Pb, then it means that the battery has a heavy metal content of more than 0.0005% Mercury, or more than 0.002% Cadmium, or more than 0.004% Lead.



FCC Radiation Exposure Statement

This equipment should be installed and operated with minimum distance 20cm between the radiator & your body.

This wireless module device complies with part 15 of FCC Rules. Operation is subject to the following two conditions: (1) this device may not cause harmful interference, and (2) this device must accept any interference received, including interference that may cause undesired operation.

Industry Canada Notice

This wireless module device complies with Canadian RSS-210. To prevent radio interference to the licensed service, this device is intended to be operated indoors and away from windows to provide maximum shielding. Equipment (or its transmitting antenna) that is installed outdoors is subject to licensing. The installer of this radio equipment must ensure that the antenna is located or pointed such that it does not emit RF field in excess of Health Canada limits for the general population; consult Safety Code 6, obtainable from Health Canada's web site www.hc-sc.gc.ca/rpb.

R&TTE Compliance Statement

This device complies with the Essential Requirements of the R&TTE Directive of the European Union (1999/5/EC). This equipment meets the following conformance standards:

ETSI EN 300 328

EN 301 489-01

EN 301 489-17

EN 62311

Notified Countries: Germany, UK, Netherlands, Belgium, Sweden, Denmark, Finland, France, Italy, Spain, Austria, Ireland, Portugal, Greece, Luxembourg, Estonia, Latvia, Lithuania, Czech Republic, Slovakia, Slovenia, Hungary, Poland and Malta.

Declaration of RoHS Compliance

This product has been designed and manufactured in compliance with Directive 2002/95/EC of the European Parliament and the Council on restriction of the use of certain hazardous substances in electrical and electronic equipment (RoHS Directive) and is deemed to comply with the maximum concentration values issued by the European Technical Adaptation Committee (TAC) as shown below:

Substance	Proposed Maximum Concentration	Actual Concentration
Lead (Pb)	0,1%	< 0,1%
Mercury (Hg)	0,1%	< 0,1%
Cadmium (Cd)	0,01%	< 0,01%
Hexavalent Chromium (Cr6+)	0,1%	< 0,1%
Polybrominated biphenyls (PBB)	0,1%	< 0,1%
Polybrominated diphenyl ethers (PBDE)	0,1%	< 0,1%

Certain components of products as stated above are exempted under the Annex of the RoHS Directives as noted below:

Examples of exempted components are:

1. Mercury in compact fluorescent lamps not exceeding 5 mg per lamp and in other lamps not specifically mentioned in the Annex of RoHS Directive.
2. Lead in glass of cathode ray tubes, electronic components, fluorescent tubes, and electronic ceramic parts (e.g. piezoelectronic devices).
3. Lead in high temperature type solders (i.e. lead-based alloys containing 85% by weight or more lead).
4. Lead as an alloying element in steel containing up to 0.35% lead by weight, aluminium containing up to 0.4% lead by weight and as a copper alloy containing up to 4% lead by weight.

Copyright Information

Copyright © ViewSonic® Corporation, 2011. All rights reserved.

ViewSonic®, the three birds logo, OnView®, ViewMatch™, and ViewMeter® are registered trademarks of ViewSonic® Corporation.

Disclaimer: ViewSonic® Corporation shall not be liable for technical or editorial errors or omissions contained herein; nor for incidental or consequential damages resulting from furnishing this material, or the performance or use of this product.

In the interest of continuing product improvement, ViewSonic® Corporation reserves the right to change product specifications without notice. Information in this document may change without notice.

No part of this document may be copied, reproduced, or transmitted by any means, for any purpose without prior written permission from ViewSonic® Corporation.

Product Registration

To meet your future needs, and to receive any additional product information as it becomes available, please register your product on the Internet at: www.viewsonic.com.

For Your Records	
Product Name:	WPG-360 Wireless Presentation Gateway
Model Number:	VS13670
Document Number:	WPG-360_UG_ENG Rev. 1B 05-16-11
Serial Number:	_____
Purchase Date:	_____

Product disposal at end of product life

ViewSonic respects the environment and is committed to working and living green. Thank you for being part of Smarter, Greener Computing. Please visit ViewSonic website to learn more.

USA & Canada: <http://www.viewsonic.com/company/green/recycle-program/>

Europe: <http://www.viewsoniceurope.com/uk/support/recycling-information/>

Taiwan: <http://recycle.epa.gov.tw/recycle/index2.aspx>

Table of Contents

1-1 Package Contents	1
1-2 Requirements	2
1-3 Highlights.....	3
1-4 Part Names	4
1-5 Setup	5
1-5 Setup	6
Chapter II Using WPG	9
2-1 Check the IP address of WPG.....	9
2-2 Connect to WPG by wireless network	10
2-3 Manual Network Connection Setting	11
2-3-1 Windows XP IP address setup:	12
2-3-2 Windows Vista / 7 IP address setup:	13
2-3-3 Macintosh IP address setup:	14
Chapter III Using Application Software.....	15
3-1 Download and launch Application Software.....	15
3-2-1 Using application software	17
3-2-2 Menu List.....	18
3-3 Quarter Split Screen	19
3-4 Broadcast	20
3-5 Capture Display	21
3-6 USB Display	22
Chapter IV Configure WPG.....	23
4-1 Conference Control	23
4-2 Connect to Web Configuration Menu.....	25
4-3 Status & Info	26
4-4 Network Settings	27
4-5 Wireless Settings.....	28
4-5-1 'Basic' Settings	28
4-5-2 'Advanced' Settings.....	30
4-5-3 'Security' Settings.....	31
4-5-3-1 Encryption: Disabled	31
4-5-3-2 Encryption: WEP	32
4-5-3-3 Encryption: WPA pre-shared key	33
4-5-4 'WPS' Settings.....	34
4-6 Projection Setting	35
4-7 Password Setting.....	36
4-8 Configuration Tools.....	37
4-8-1 Configuration Tools	37

4-8-2 <i>Firmware Upgrade</i>	38
4-9 Restart	39
4-10 Logout	40
Chapter V Appendix	41
5-1 Hardware Specification	41
5-2 Troubleshooting	42

Chapter I Product Introduction

Congratulations on your purchase of ViewSonic Wireless Presentation Gateway WPG-360. This section introduces you to the WPG-360 (referred to as the WPG in this user guide).

1-1 Package Contents

- (1) WPG-360
- (2) IR receiver extension cable
- (3) AC adapter extension cable
- (4) VGA cable
- (5) Remote controller
- (6) USB cable
- (7) AC adapter
- (8) CD-ROM
- (9) Quick Installation Guide

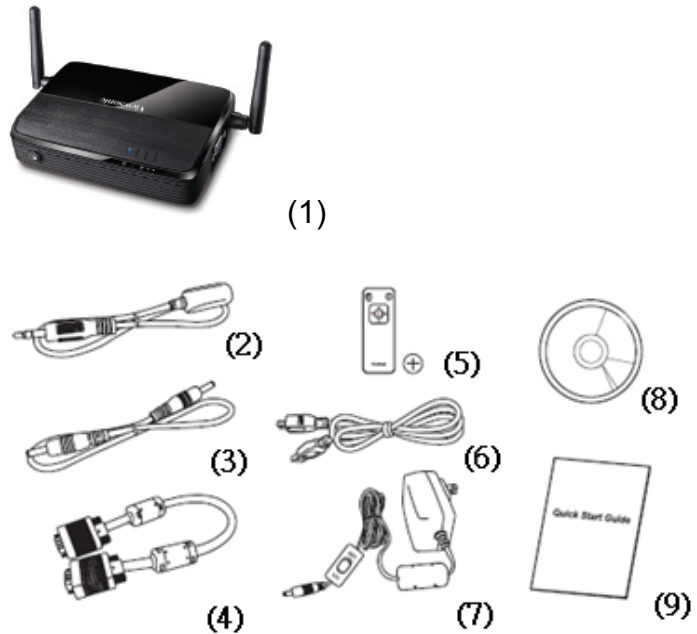

1-2 Requirements

PC CPU Speed	Intel Pentium 4/1.5 GHz or higher (Recommend Intel Core 2 Duo CPU)
Memory	512 MB of RAM or higher (Recommend 1GB of RAM)
Operating System	Windows XP 32 bit or above (Recommend Windows XP 32 bit) MAC OS X 10.5 and 10.6 (Intel Version only)
Network	100Mbps Wired Fast Ethernet / 11Mbps 802.11b wireless Ethernet (Recommend 54Mbps 802.11g wireless Ethernet)
USB	USB 1.1 / 2.0 Port (Recommend USB 2.0 port)

1-3 Highlights

Thanks again for choosing the product. This product allows multiple users to connect to the same projector by wired or wireless network and avoiding the hassle of using VGA cable.

Features

1. 802.11 b/g/n Wireless compatibility
2. Supports both Wireless and Ethernet connectivity
3. VGA connections
4. Conference control
5. Supports multiple users at the same time *with* Quarter split screen
6. WPS (Wi-Fi Protected Setup)
7. Output Resolution: 1400x1050, 1280x800, 1024x768, 800x600
8. Upgrade software via the Internet
9. Network security
10. Presentation remote
11. Video capture, to capture screen image for projection
12. USB display(Not support in MAC)
13. Broadcast for computer desktop or images.

1-4 Part Names

Front View

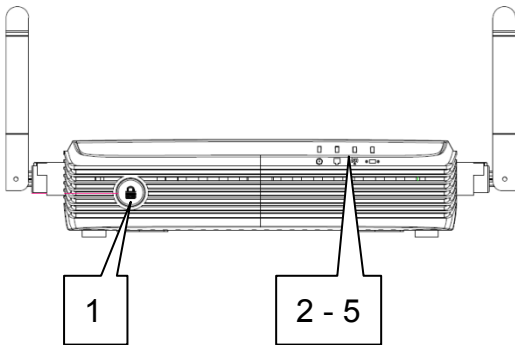

Back View

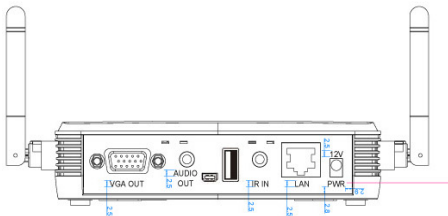

Side View

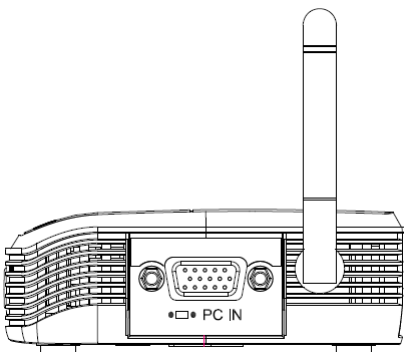

Item No.	Description
1	WPS: Single Click when the device is ON. Turn On: Single Click when the device is OFF.
2	'POWER' LED
3	'LAN' LED
4	'WIRELESS' LED
5	'PC IN' LED

Name	Description
12V	Connect to A/C adapter / ViewSonic projector's D/C power outlet
LAN	10/100Mbps fast Ethernet port
IR IN	Connect to IR receiver
USB A	For mouse function
USB B	Connect to computer for USB display
Audio Out	Stereo audio output
VGA OUT	VGA video output
Antenna	Receives wireless signal

Name	Description
PC IN	Connect to computer's VGA output port

Note:

1) *WPS stands for Wi-Fi Protected Setup.*

Remote Controller

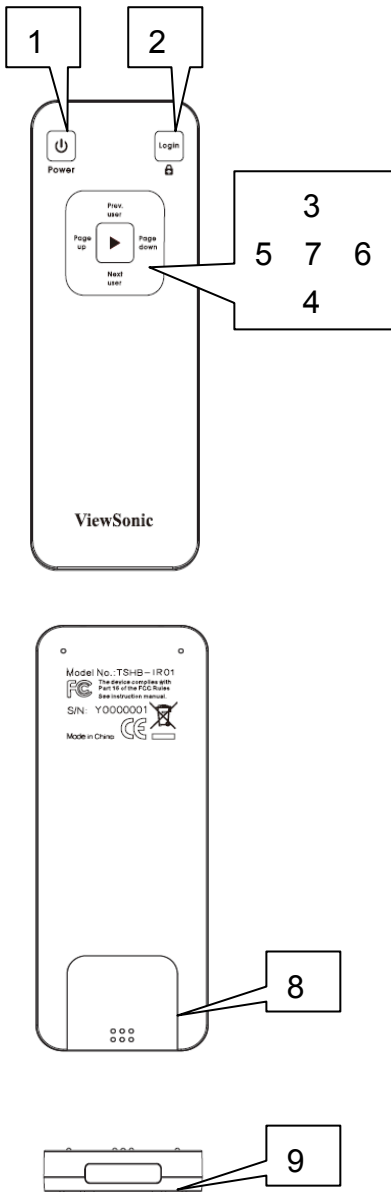

Item No.	Description
1 Power	Stand-by mode on/off
2 Login	Show user list: Single Click.
2 	WPS: Press and hold for 3 seconds.
3 Prev.user	Move up to select user for presentation
4 Next user	Move down to select user for presentation
5 Page up	Go to previous page
6 Page down	Go to next page
7 Confirm	Confirm selected user for presentation
8 Battery Lid	Press battery lid and push it downward by your thumb to open battery compartment
9 IR LED	Infrared signal transmitter

Note:

1) Remote controller effective distance is 7 meters. This distance will be shortened in some environments, or when the battery is low.

2) If there's strong light source near WPG and / or remote controller, remote controller may not be able to function properly.

1-5 Setup

Connecting with your device

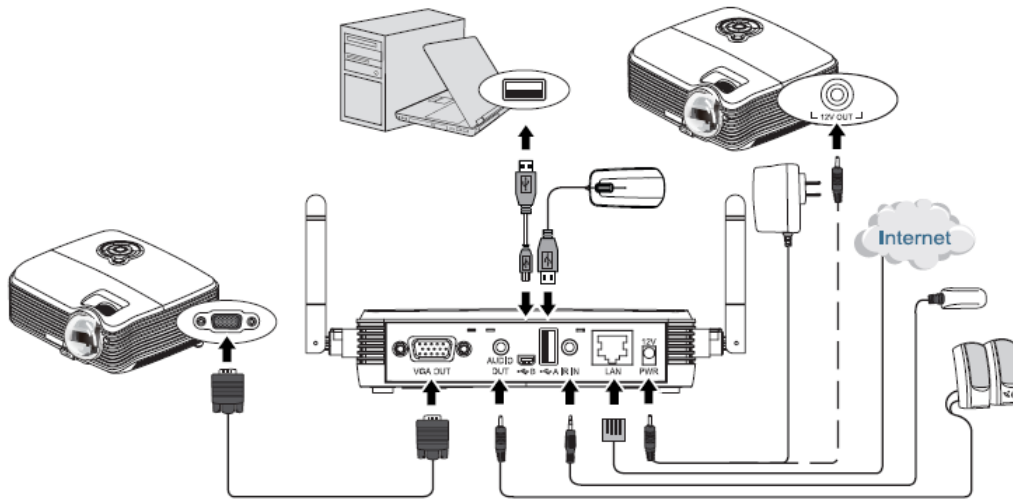

Start-up instructions

	<p>Connect one end of the VGA cable to the external display, and the other to WPG VGA-out port locates at back.</p>
	<p>Connect the Ethernet cable to the LAN port</p>

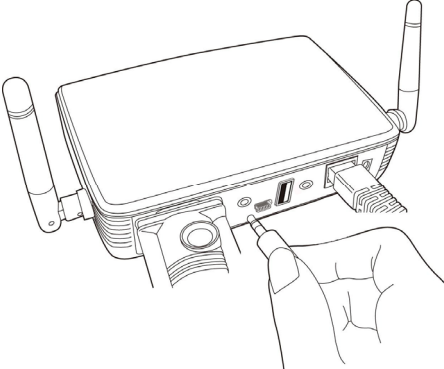
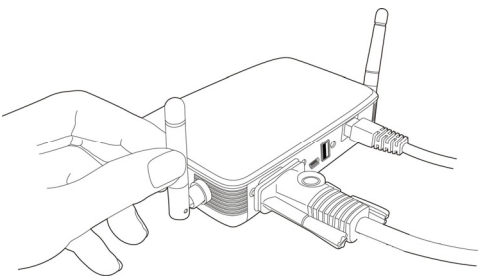
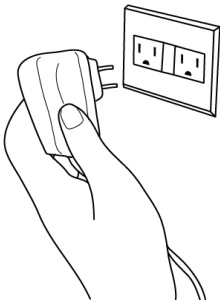
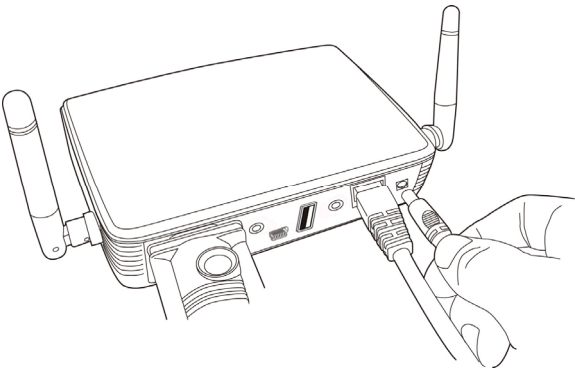
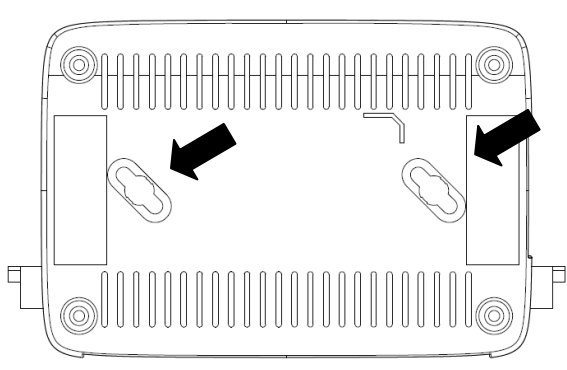
	<p>Connect the IR receiver extending cable to 'IR IN' port located at the back of WPG, and place the IR receiver at a place where you can point the remote controller to it easily</p>
	<p>Adjust the antennas so they are perpendicular to the ground.</p>
	<p>Connect the A/C power adapter to the electrical outlet on the wall.</p>
	<p>Connect A/C power adapter to the power jack labeled as '12V' at the back of WPG.</p>
	<p>To fix the product placement, please use two wall mount holes located at the back of the product.</p>

 <p>The image shows the start screen of the ViewSonic WPG-360. At the top left is the ViewSonic logo. To its right is a blue box labeled 'LOGIN CODE:'. Below this are two sections: 'To Project using Wireless Presentation Gateway' and 'To Install Wireless Presentation Gateway Software', each with a list of numbered steps. At the bottom left, there are labels for 'Device Name:', 'Wired IP:', and 'Wireless IP:'. At the bottom right, there are two input fields labeled 'User Name' and 'IP'.</p>	<p>If you can see this start screen display on projector, indicates WPG-360 is working and all connection cables are correctly connected.</p>
---	---

Note:

DO NOT USE VELCRO STICKER ALONE TO FIX THE PRODUCT ON THE WALL!

Chapter II Using WPG

2-1 Check the IP address of WPG

When WPG is powered on, check the connected display, you can find the IP address and login code Instruction Page:

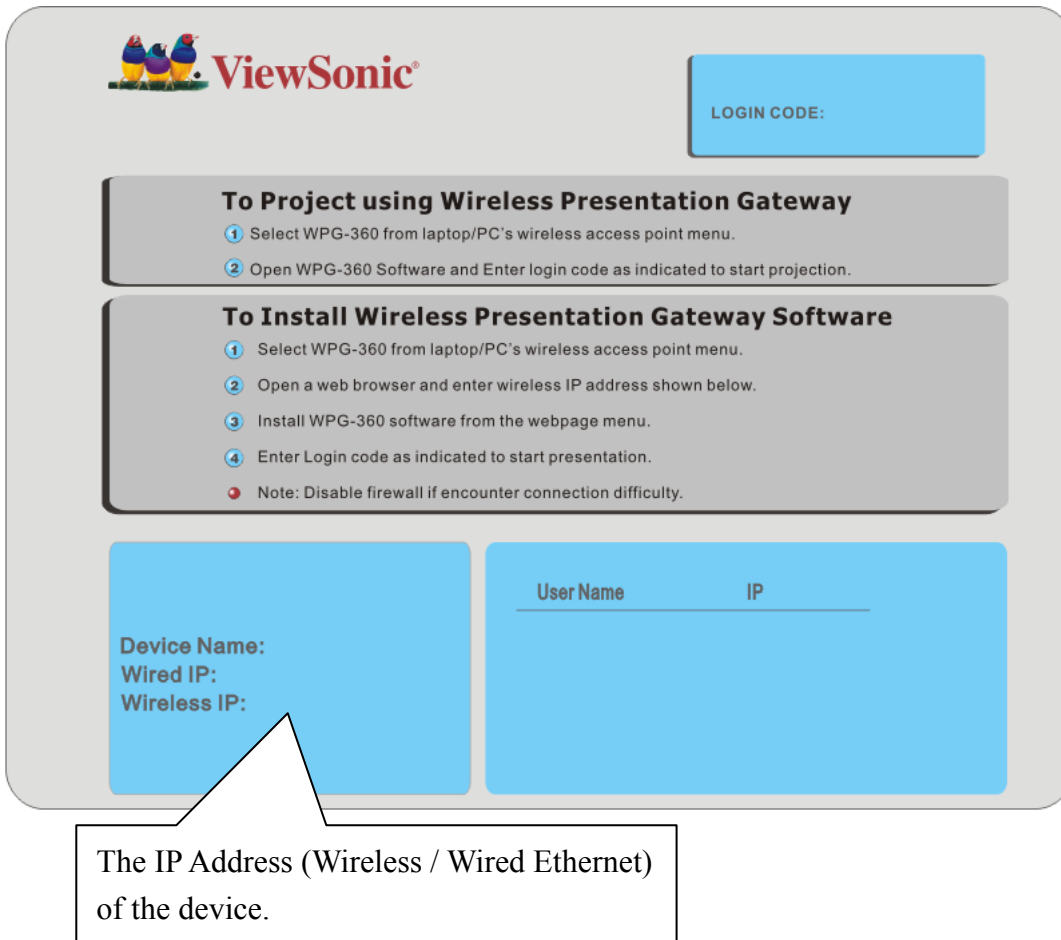

You can connect to WPG by the IP address of the connection type you're using (wired / wireless).

2-2 Connect to WPG by wireless network

Use your computer's Wireless Network Connection window to access an available wireless network. Select the device from the list. Click Connect. The default device name is WPG-360.

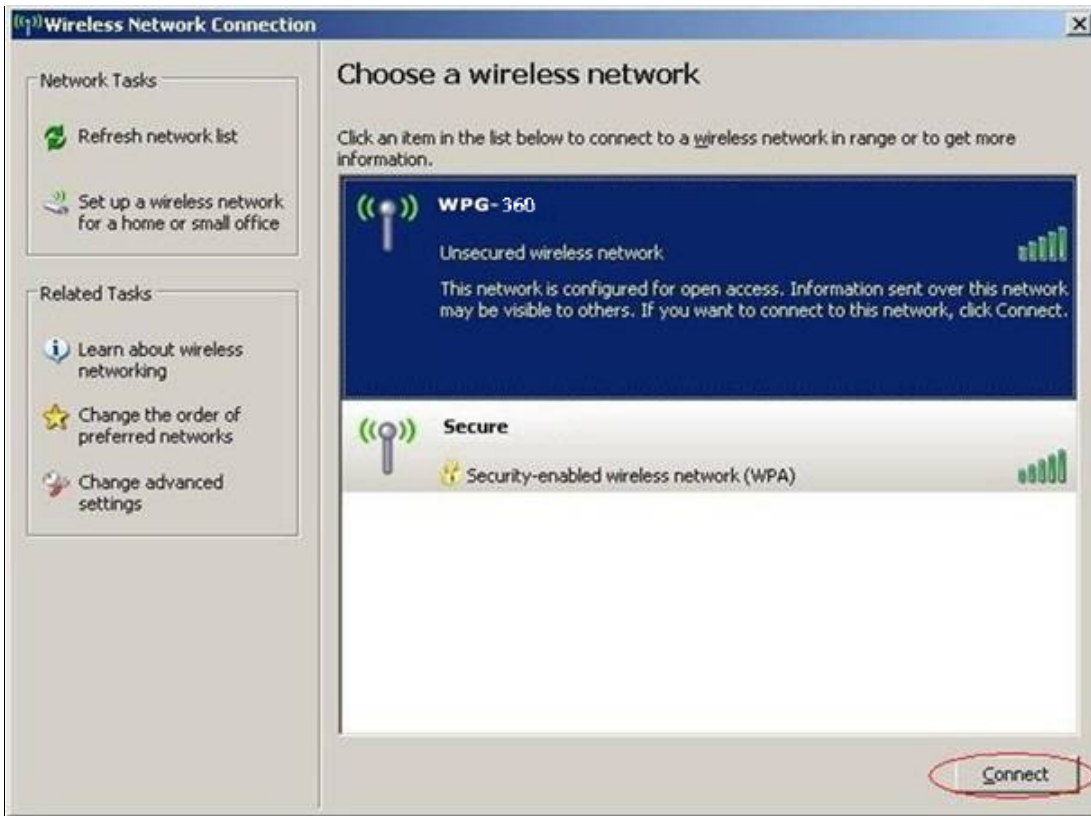

Note: If using a wireless client other than Windows, the screen above may look differently. For more details, see your PC user guide.

2-3 Manual Network Connection Setting

If there's no DHCP server available on your LAN, please follow the following instructions to set the IP address of the computer.

If the operating system of your computer is....

- | | |
|-------------------|------------------------------|
| Windows XP | - please go to section 2-3-1 |
| Windows Vista / 7 | - please go to section 2-3-2 |
| Macintosh | - please go to section 2-3-3 |

2-3-1 Windows XP IP address setup:

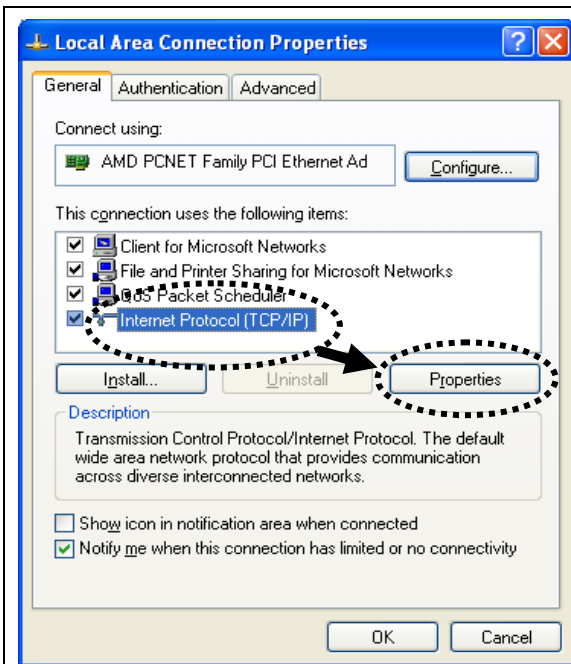

Click 'Start' from windows toolbar locate at bottom, open control panel, then select *Network and Internet Connections*, click *Network Connections*, and then double-click *Local Area Connection*, *Local Area Connection Status* window will appear, and then click 'Properties'

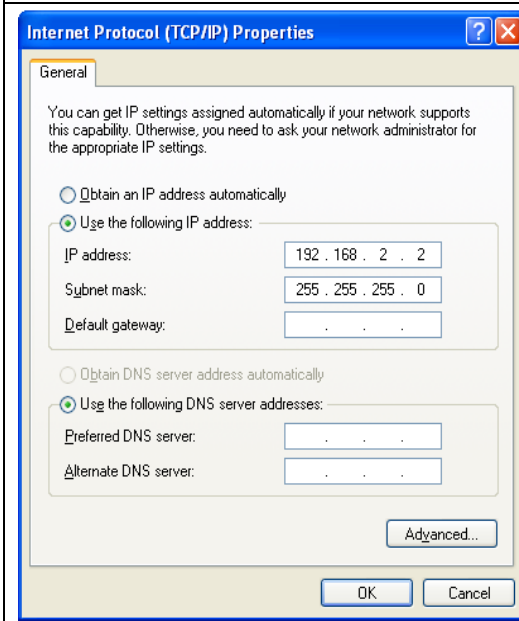

Select 'Use the following IP address', then input the following settings in respective field:

IP address: 192.168.0.x (where x is an integer greater or less than 200, if there's more than one computer need to use this WPG on the same network, each computer should use an unique number)

Subnet Mask: 255.255.255.0

Click 'OK' when finish.

2-3-2 Windows Vista / 7 IP address setup:

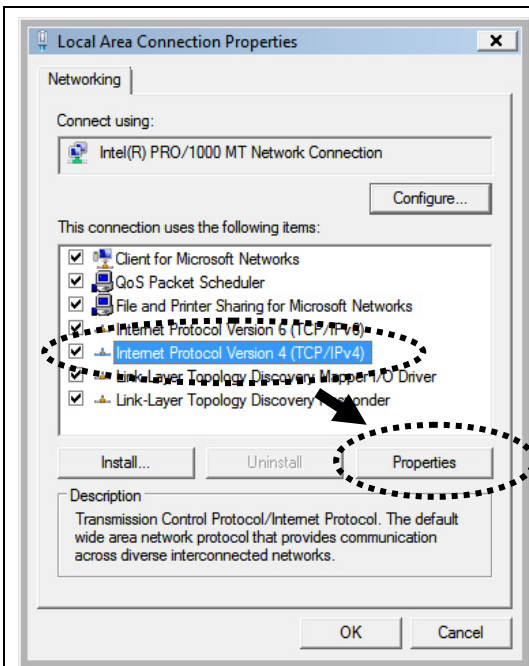

Click 'Start' from windows toolbar locate at bottom to select control panel. Click *View Network Status and Tasks*, then click *Manage Network Connections*. Right-click *Local Area Network*, then select '*Properties*'. *Local Area Connection Properties* window will appear, select 'Internet Protocol Version 4 (TCP / Ipv4)', and then click 'Properties'

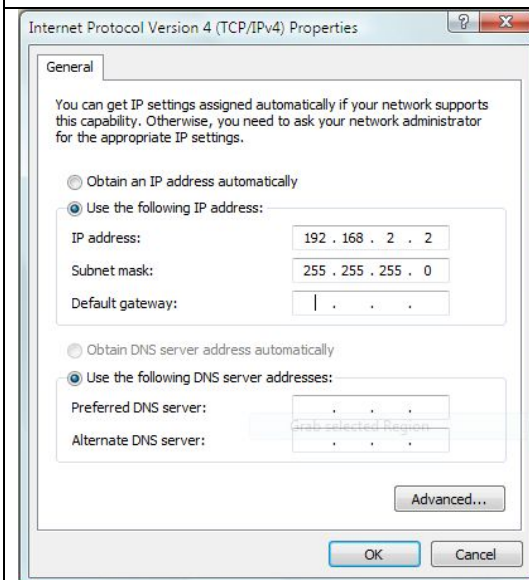

Select 'Use the following IP address', then input the following settings in respective field:

IP address: 192.168.0.x (where x is an integer greater or less than 200, if there's more than one computer need to use this WPG on the same network, every computer should use an unique number)

Subnet Mask: 255.255.255.0

Click 'OK' when finish.

2-3-3 Macintosh IP address setup:

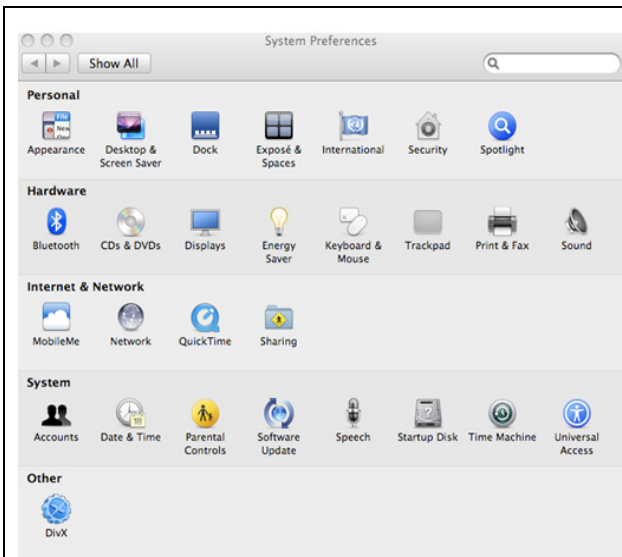

Select 'System Preferences', and double-click 'Network'.

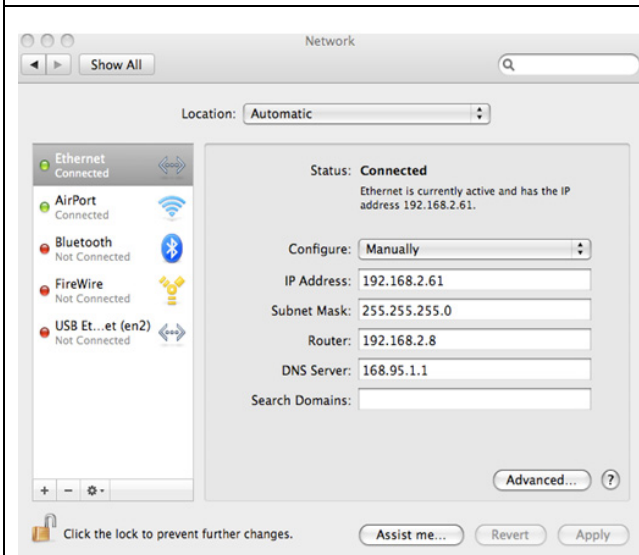

Select 'Manually' in 'Configure' field, then input the following settings in respective field:



IP address: 192.168.0.x (where x is an integer greater or less than 200, if there's more than one computer need to use this WPG on the same network, every computer should use an unique number)
Subnet Mask: 255.255.255.0

Chapter III Using Application Software

3-1 Download and launch Application Software

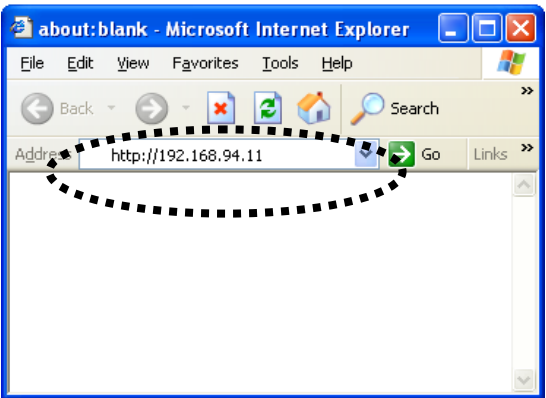
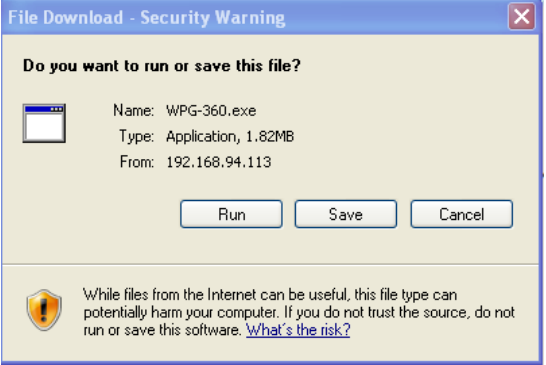
Before any computer can use the WPG, application software must be installed first. Please follow instructions to download and install WPG application software according to your system:

	<p>Use the web browser to connect to the IP address shown on WPG (Wireless / Wired IP address)</p> <p>WPG's IP address is shown at the Instruction page.</p>
	<p>Click 'For Windows' or 'For MAC' button to download application software.</p> <p>For Windows XP, please download and install the video driver.</p>
	<p>A window is prompted, to execute, please check "run", or "save" to save application software for future usage.</p> <p>During the MAC application software installation, you will also be asked to install "soundflower" program to make your MAC PC to output audio correctly, please install it before going to next step.</p>

	<p>If you see this message (or anything similar from your antivirus program) when running WPG, please click 'Unblock' to allow WPG client software to access network, or WPG client program will not be able to work properly.</p>
	<p>WPG will auto detect 'Server IP' and 'User Name', please input login code as shown on instruction page.</p>
	<p>If login code is correct, application software will appear.</p>

NOTE:

- If your computer display's resolution is not 1024x768, you'll receive a message:

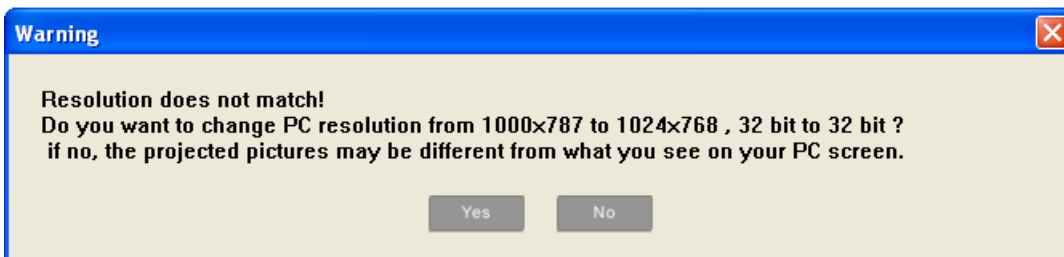

Click 'Yes' to adjust your computer display's resolution automatically, or click 'No' to keep original resolution, but some display area on projector may not be able to be used.

- If no WPG is found on your network, please check if WPG device is turned on or Ethernet cable is well-connected.

3-2-1 Using application software



No.	Name	Function Description				
1	Menu	Access menu list.				
2	Play / Pause	Start / pause presentation. When pausing a progressing presentation, the displaying image will freeze; press play button again to resume				
3	Minimize	Minimizes Application Software window				
4	Close	Closes Application Software window				
5	Stop	Stop a progressing presentation				
6	Presentation Mode / Video Mode	Switches between presentation/Video mode				
7	Broadcast	You can broadcast some specific content to more than one WPGs on your network.				
8	Capture Display	Displays a specific area from your computer desktop to the projector.				
9	'1' to '4'	Quarter split display control. Click number 1 to 4 to start / stop presentation of corresponding quarter split display area. <table border="1" style="margin-left: auto; margin-right: auto;"> <tbody> <tr> <td>1</td> <td>2</td> </tr> <tr> <td>3</td> <td>4</td> </tr> </tbody> </table>	1	2	3	4
1	2					
3	4					

3-2-2 Menu List

Besides the buttons, you can also click 'Menu' button to access menu list.

Item Name	Function Description
Administrator	Go to 'ADMIN' page of web menu
Information	Check the information of connected WPG.
Source Select	Switch to different input source. VGA1: Displays your computer's display content on projector. VGA2: Display 'VGA IN' port's display content on projector. Search: Search for other available WPG.
Projection Control	Controls the projection: Play: Start presentation. Pause: Pauses presentation. Stop: Stop presentation. Blank: Blank displaying image. Output Resolution: Changes display resolution and you can check 'Follow Desktop' to equivalent to output based on original user desktop resolution setting. Mode Setting: <ul style="list-style-type: none"> • Presentation Mode: Premium setting for data presentation. • Video Mode: Premium setting for smooth video. • Custom: Customize the display quality level.
Enable Audio	The option is only available in MAC. After selected, if you do not install "soundflower" program during the MAC application software installation, you will be asked to install it to make your MAC PC to output audio correctly.
Advanced	Broadcast: You can broadcast some specific content to more than one WPGs on your network. Capture Display: Displays a specific area from your computer desktop to the projector.
Logout	Logout from WPG.
Exit	Close menu list

3-3 Quarter Split Screen

When there is more than one presenter, you can use this function to display up to 4 presenter's content to present on display screen simultaneously.

To use Quarter Split Function, please login to WPG, and select a key (1 to 4) to present:



Number 1 to 4 correspond to different area of display screen:

1	2
3	4

When you click a number, your content will be displayed in corresponding Quarter-Split display area

To show content in full-screen mode, simply click 'Play' button; to resume to Quarter-Split display, simply click number key 1 to 4.

NOTE: When 'Presentation Lock' is checked, no one will be able to interrupt a progressing presentation.

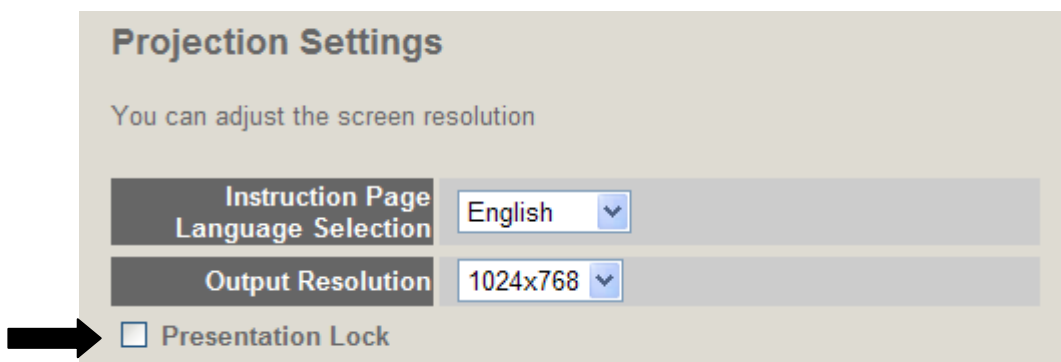

3-4 Broadcast

With this function, you can broadcast the content to multi-WPGs simultaneously on your network just by simple check the desired WPGs on the list.

To activate broadcast function, click broadcast button  or select Menu -> Advanced -> Broadcast, then broadcast control panel will appear:

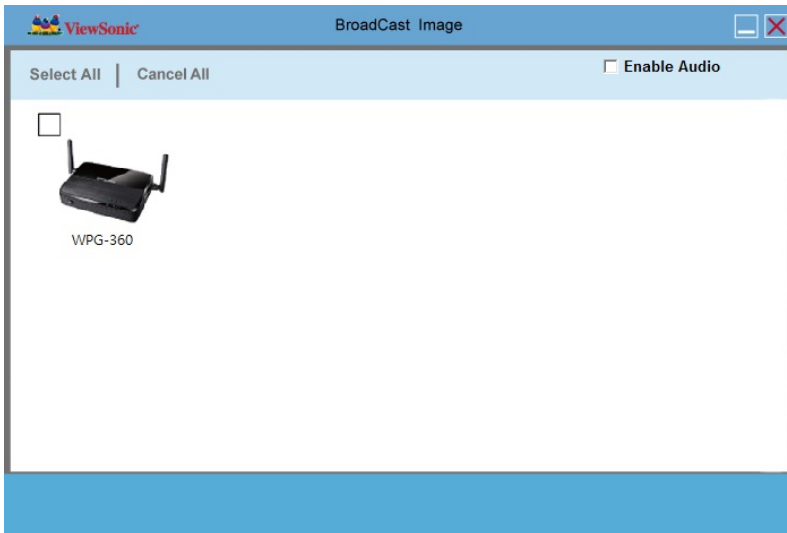

Descriptions of every function will be given below:

Item	Description
Select All	Select all WPGs found on your network.
Cancel All	Unselect all selected WPGS.
Enable Audio	For Windows: Check to enable or disable audio. For MAC: Click  to enable or disable audio.

NOTE:

- Broadcast will not work when doing the presentation. Please stop the presentation before use.

NOTE:

- The maximum length of device name display at broadcast is 15 characters.

3-5 Capture Display

To display a specific area from your computer desktop to the projector.

To use this function, click 'Capture Display' button , or or select Menu -> Advanced -> Capture Display.

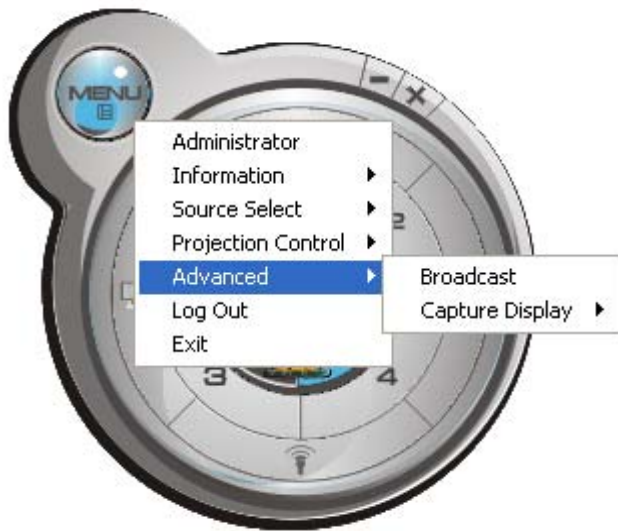

Descriptions of every function will be given below:

Item	Description
Select Object	<p>For Windows: Select an object (a window, explorer bar, notification area etc.) on your computer's player for projection.</p> <p>For MAC: It requires "Get" and "Set" two steps to make your computer's player for projection.</p> <p>Get: Select "Get" to get a frame on your computer's player.</p> <p>Set: Select "Set" to confirm the frame of the player for projection.</p> <p>Close: To unlock the frame of your player for projection.</p>
Select Area	Select a desired area on your computer's desktop for projection.

When you selected an object or area for projection, click 'Play' button to start projection. In this mode, only the object or area you selected will be displayed on projector.

3-6 USB Display

The function allows to project your computer's desktop on screen via the connection of Mini USB Type B to USB Type A cable.

Once the connection and detection are succeed, a inquiry window will automatically pop up

to ask you to execute "vsPresenter" to make the desktop of your PC output to the screen. If the inquiry window is not pop up, please access to the disk "vsPresenter" from "COMPUTER" and execute "vsPresenter.exe".





NOTE:

- Only "Play", "Stop", "Pause", "Minimize", and "Close" keys are available during the USB display operation.
- If the image can not be projected, please disable firewall on your system.
- USB display will not work when someone is doing the presentation. Please stop the presentation before use.
- The function is not available in MAC.
- Please do not store any data to the disk of "vsPresenter" under "COMPUTER", or the system will not work properly.
- USB Display will not work when presentation or broadcast function is operating. Please stop them before use.

Chapter IV Configure WPG

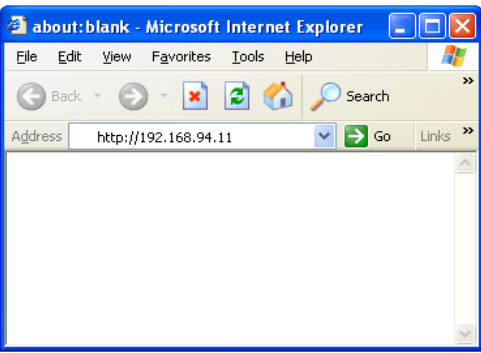
4-1 Conference Control

When there is more than one presentation login to WPG, you can control the content from different presenter via Conference Control webpage.

	<p>Use the web browser to connect to the IP address of WPG (Wireless / Wired IP address). WPG's IP address can be found at the lower-left corner of Instruction page (refer to chapter 2-1).</p>															
	<p>Click 'Conference Control' from WPG's web user interface.</p>															
 <table border="1"><thead><tr><th>Action</th><th>Name</th><th>IP Address</th><th>Status</th><th>Connection time</th></tr></thead><tbody><tr><td></td><td>User 1</td><td>192.168.2.59</td><td>Quered</td><td>02:09:42</td></tr><tr><td></td><td>User 2</td><td>192.168.2.51</td><td>Quered</td><td>02:09:29</td></tr></tbody></table>	Action	Name	IP Address	Status	Connection time		User 1	192.168.2.59	Quered	02:09:42		User 2	192.168.2.51	Quered	02:09:29	<p>All users currently logged in will be displayed here. To select a user's display content in certain area of Quarter-Split Display, click number 1 to 4; to display in full-screen, click button of the presenting user. To stop a progressing presentation, click </p>
Action	Name	IP Address	Status	Connection time												
	User 1	192.168.2.59	Quered	02:09:42												
	User 2	192.168.2.51	Quered	02:09:29												

NOTE:

- When "Administrator Mode" is enabled, all buttons of the application software will be disabled.

To select user by remote controller:

When there is more than one connected application software, you can also use remote controller to select one of them to display the content (same as 'Conference control' function described in last chapter). Press 'Login' button on remote control.



The image shows the ViewSonic WPG-360 web interface. At the top left is the ViewSonic logo with three colorful birds. To the right is a blue box labeled "LOGIN CODE:". Below this are two grey boxes with instructions. The first box is titled "To Project using Wireless Presentation Gateway" and contains two numbered steps: 1. Select WPG-360 from laptop/PC's wireless access point menu. 2. Open WPG-360 Software and Enter login code as indicated to start projection. The second box is titled "To Install Wireless Presentation Gateway Software" and contains four numbered steps: 1. Select WPG-360 from laptop/PC's wireless access point menu. 2. Open a web browser and enter wireless IP address shown below. 3. Install WPG-360 software from the webpage menu. 4. Enter Login code as indicated to start presentation. Below these boxes are two blue boxes. The left one contains labels for "Device Name:", "Wired IP:", and "Wireless IP:". The right one contains a table with two columns: "User Name" and "IP".

ViewSonic

LOGIN CODE:

To Project using Wireless Presentation Gateway

- 1 Select WPG-360 from laptop/PC's wireless access point menu.
- 2 Open WPG-360 Software and Enter login code as indicated to start projection.

To Install Wireless Presentation Gateway Software

- 1 Select WPG-360 from laptop/PC's wireless access point menu.
- 2 Open a web browser and enter wireless IP address shown below.
- 3 Install WPG-360 software from the webpage menu.
- 4 Enter Login code as indicated to start presentation.

Note: Disable firewall if encounter connection difficulty.

Device Name:
Wired IP:
Wireless IP:

User Name	IP
-----------	----

You can use 'Prev.' and 'Next' button on the remote controller to move the bar, then click ► button to select the presenting user.

4-2 Connect to Web Configuration Menu

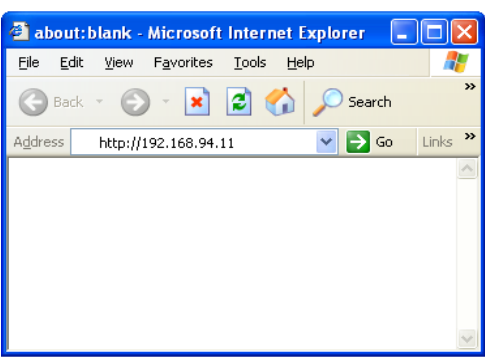
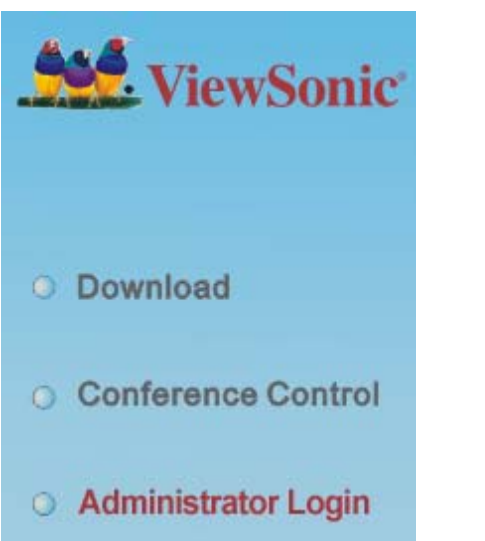
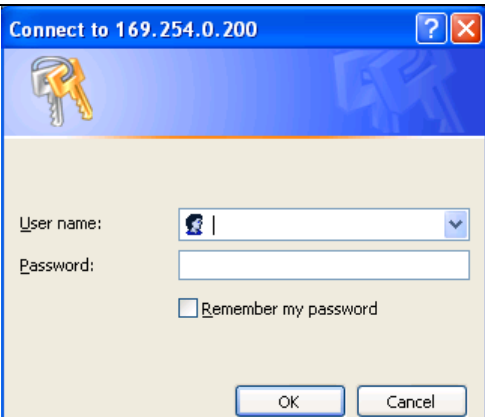
	<p>Use the web browser to connect to the IP address of WPG (Wireless / Wired IP address). WPG's IP address can be found at the lower-left corner of Instruction page (refer to chapter 2-1).</p>
	<p>Click 'Administrator Login' link on the left.</p>
	<p>Please input 'admin' as username. For 1st time login you don't have to input password, just click 'OK' to continue. You can change password after login.</p> <p>If you set password before, please input password in 'Password' field.</p>

4-3 Status & Info

Displays system information, like system software version and IP address. Many useful information can be obtained here when you need help about system configuration and firmware upgrade.

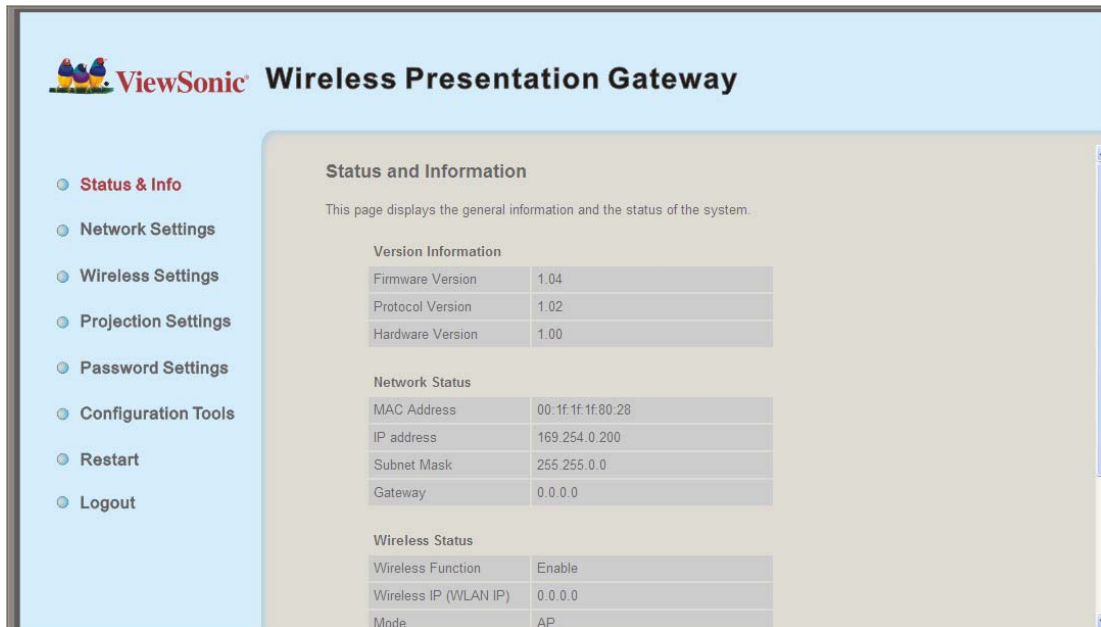

The screenshot shows the 'ViewSonic Wireless Presentation Gateway' web interface. The left sidebar contains a menu with the following items: Status & Info (selected), Network Settings, Wireless Settings, Projection Settings, Password Settings, Configuration Tools, Restart, and Logout. The main content area is titled 'Status and Information' and includes a descriptive sentence: 'This page displays the general information and the status of the system.' Below this, there are three tables of system information.

Version Information	
Firmware Version	1.04
Protocol Version	1.02
Hardware Version	1.00

Network Status	
MAC Address	00:1f:1f:1f:80:28
IP address	169.254.0.200
Subnet Mask	255.255.0.0
Gateway	0.0.0.0

Wireless Status	
Wireless Function	Enable
Wireless IP (WLAN IP)	0.0.0.0
Mode	AP

4-4 Network Settings

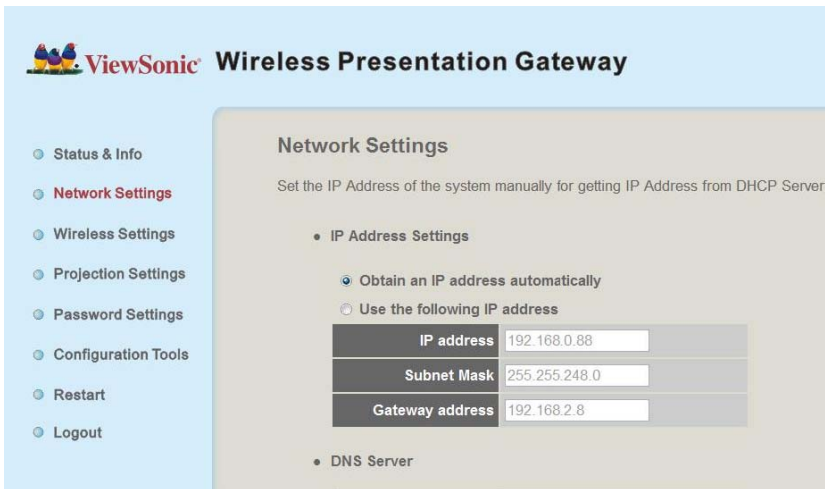

Displays and configures the network settings.

Obtain an IP address automatically
 Use the following IP address

IP address	192.168.0.88
Subnet Mask	255.255.248.0
Gateway address	192.168.2.8

• DNS Server

DNS address	<input type="text"/>
Secondary DNS Address (optional)	<input type="text"/>

Item	Description
Obtain an IP address automatically	WPG will obtain an IP address from DHCP server automatically.
Use the following IP address	Set WPG IP address manually. Fill the fields below to setup IP address.
DNS Server	Please input the IP address of the DNS (Domain Name Service) server.

Click 'Apply' button to save the settings.

NOTE: When the configuration settings are changed, you must restart the network connection. You can restart the network connection by clicking "Restart" on the web configuration menu.

4-5 Wireless Settings

The screenshot shows the 'ViewSonic Wireless Presentation Gateway' configuration interface. On the left is a navigation menu with options: Status & Info, Network Settings, **Wireless Settings**, Projection Settings, Password Settings, Configuration Tools, Restart, and Logout. The main content area has tabs for 'Basic', 'Advanced', 'Security', and 'WPS'. The 'Basic' tab is active, displaying the 'Wireless Settings' section. A descriptive text states: 'This page allows you to define Device Name (SSID), and Channel for the wireless connection. These parameters are used for the wireless stations to connect to the Access Point.' Below this is a table of settings:

Wireless Function :	Enable ▾
Mode:	AP ▾
Band:	2.4 GHz (B+G+N) ▾
Device Name (SSID):	WPG-360
Channel Number:	11 ▾
Associated Clients:	Show Active Clients

At the bottom right of the settings area are 'Apply' and 'Cancel' buttons.

Configures wireless network settings.

4-5-1 'Basic' Settings

This is a close-up view of the 'Wireless Settings' section from the previous screenshot. It shows the 'Basic' tab selected. The settings are as follows:

Wireless Function :	Enable ▾
Mode:	AP ▾
Band:	2.4 GHz (B+G+N) ▾
Device Name (SSID):	WPG-360
Channel Number:	11 ▾
Associated Clients:	Show Active Clients

Displays and configures the wireless settings.

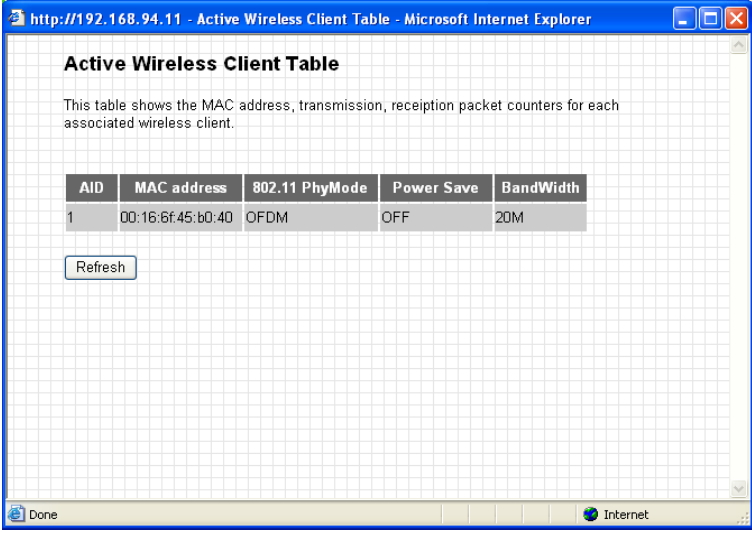
Item	Description
Wireless Function	Select 'Enable' to enable wireless network function; 'Disable' to disable it.
Mode	Select wireless mode. Only AP (Access Point) mode is supported.
Band	Select the wireless band. Available options are: 2.4GHz (B) - 802.11b clients only. 2.4GHz (N) - 802.11 Draft-n clients only. 2.4GHz (B+G) - 802.11b and 802.11n clients. 2.4GHz (G) - 802.11g clients only. 2.4GHz (B+G+N) - 802.11b, 802.11g, and 802.11n clients.
Device Name (SSID)	Input the Device Name of presentation gateway here. Default is "WPG-360".
Channel Number	Select the wireless channel number: 1 to 13. (1 to 11 in certain version of product)
Associated Client	Shows all connected wireless clients (wired clients will not be displayed here).  <p>Click 'Refresh' button to reload list.</p>

Click 'Apply' button to save the settings.

NOTE: When the configuration settings are changed, you must restart the network connection. You can restart the network connection by clicking "Restart" on the web configuration menu.

4-5-2 'Advanced' Settings

Fragment Threshold:	<input type="text" value="2346"/> (256-2346)
RTS Threshold:	<input type="text" value="2347"/> (0-2347)
Beacon Interval:	<input type="text" value="100"/> (20- 1024 ms)
DTIM Period:	<input type="text" value="3"/> (1-10)
Data Rate:	<input type="button" value="Auto"/> ▾
N Data Rate:	<input type="button" value="Auto"/> ▾
Channel Width:	<input checked="" type="radio"/> Auto 20/40 MHZ <input type="radio"/> 20 MHZ
Preamble Type:	<input checked="" type="radio"/> Short Preamble <input type="radio"/> Long Preamble
Broadcast ESSID:	<input checked="" type="radio"/> Enable <input type="radio"/> Disable
CTS Protect:	<input type="radio"/> Auto <input type="radio"/> Always <input checked="" type="radio"/> None
Tx Power:	<input type="button" value="100 %"/> ▾
WMM:	<input type="radio"/> Enable <input checked="" type="radio"/> Disable

Display and configures the advanced settings.

Item	Description
Fragment Threshold	Set the Fragment threshold of wireless radio. Default value is 2346.
RTS Threshold	Set the RTS threshold of wireless radio. Default value is 2347.
Beacon Interval	Set the beacon interval of wireless radio. Default value is 100.
DTIM Period	Set the DTIM period of wireless radio. Default value is 3.
Data Rate	Change data transfer rate. Default value is 'Auto' and it's recommended to use default setting.
N Data Rate	Same as above, but only for 802.11n clients.
Channel Width	Set channel width of wireless radio. Default setting is 'Auto 20/40 MHz'.
Preamble Type	Set the type of preamble of wireless radio, Default setting is 'Short Preamble'.
Broadcast Device Name (SSID)	Decide if the product will broadcast its own device name or not. You can hide the device name of this product (set the option to 'Disable')
CTS Protect	Enable to reduce the chance of radio signal collisions between 802.11b and 802.11g wireless access points. It's recommended to

	set this option to 'Auto' or 'Always'.
Tx Power	You can set the output power of wireless radio.
Turbo Mode	Enhances the data transfer rate of network. Default setting is "Enable".
WMM	Wi-Fi MultiMedia Quality of Service is a set of features for Wi-Fi networks that improve the user experience for audio, video, and voice applications by prioritizing data traffic. Default setting is "Disable".

Click 'Apply' button to save the settings.

NOTE: When the configuration settings are changed, you must restart the network connection. You can restart the network connection by clicking "Restart" on the main menu.

4-5-3 'Security' Settings

4-5-3-1 Encryption: Disabled

Disables wireless encryption.

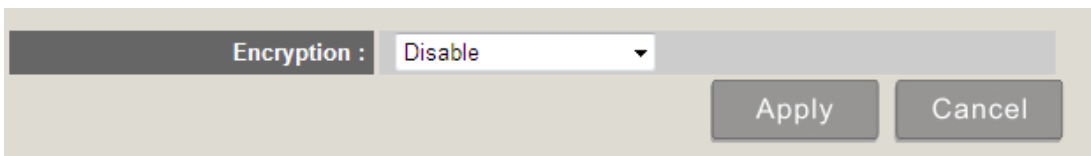

4-5-3-2 Encryption: WEP

Enable WEP encryption. Wireless clients must support WEP encryption and know the encryption key you set here.

Security Settings

This page allows you setup the wireless security. Turn on WEP or WPA by using Encryption Keys could prevent any unauthorized access to your wireless network.

Encryption :	WEP ▾
Key Length :	64-bit ▾
Key Format :	Hex (10 characters) ▾
Default Tx Key :	Key 1 ▾
Encryption Key 1 :	<input type="text"/>
Encryption Key 2 :	<input type="text"/>
Encryption Key 3 :	<input type="text"/>
Encryption Key 4 :	<input type="text"/>

Display and configures the encryption settings.

Item	Description
Key Length	Select WEP key length (64 bit or 128 bit), longer WEP key provides better security. Recommend to select '128-bit' for better security.
Key Format	Select key format: ASCII or Hex. ASCII: 5 characters (64 bit key length) / 13 characters (128 bit key length) HEX: 10 characters (64 bit key length) / 26 characters (128 bit key length)
Default Tx Key	You can set up to four sets of WEP key and decide which key is being used by default here. Default setting is '1'
Encryption Key 1 to 4	Input WEP key characters here. Use any alphanumerical characters (0-9, a-z, and A-Z) if you select 'ASCII' key format, and use characters 0-9, a-f, and A-F for HEX

Click 'Apply' button to save the settings.

NOTE: When the configuration settings are changed, you must restart the network connection. You can restart the network connection by clicking "Restart" on the main menu.

4-5-3-3 Encryption: WPA pre-shared key

Enable WEP encryption. Wireless clients must support WPA encryption and know the encryption passphrase you set here.

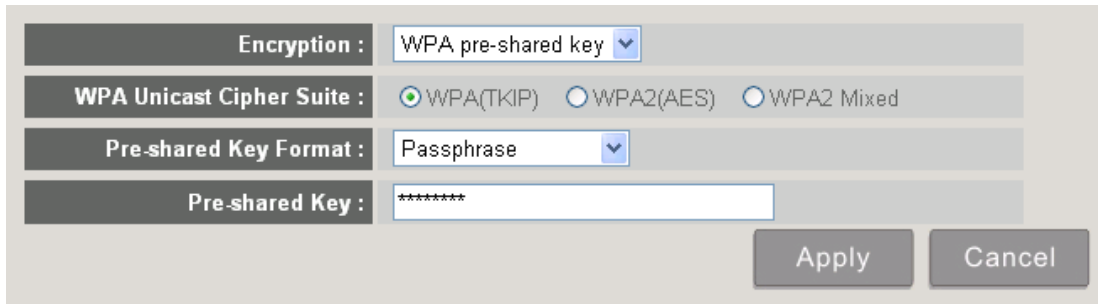

The screenshot shows a configuration window for WPA encryption. It contains four rows of settings:

- Encryption :** A dropdown menu set to "WPA pre-shared key".
- WPA Unicast Cipher Suite :** Three radio buttons: "WPA(TKIP)" (selected), "WPA2(AES)", and "WPA2 Mixed".
- Pre-shared Key Format :** A dropdown menu set to "Passphrase".
- Pre-shared Key :** A text input field containing seven asterisks (*****).

At the bottom right, there are two buttons: "Apply" and "Cancel".

Display and configures the encryption settings.

Item	Description
WPA Unicast Cipher Suite	Select the type of WPA cipher suite. Select 'WPA (TKIP) for maximum compatibility and WPA2 (AES) / WPA2 Mixed for better security.
Pre-shared Key Format	Select the type of pre-shared key: Passphrase or HEX characters.
Pre-shared Key	Input WPA Passphrase here. Passphrase: 8 or more alphanumerical characters, up to 63 characters Hex: 64 characters (0-9, a-f, and A-F)

Click 'Apply' button to save the settings.

NOTE: When the configuration settings are changed, you must restart the network connection. You can restart the network connection by clicking "Restart" on the main menu.

4-5-4 'WPS' Settings

In this menu, you can use WPS (Wi-Fi Protected Setup) to setup secure wireless connections quickly and easily with WPS-compatible wireless clients.

• **Wi-Fi Protected Setup Information**

WPS Status:	Configured
Self PinCode:	33860671
Device Name (SSID)	WPG-360
Authentication Mode	Disable
Passphrase Key	

• **Device Configure**

Config Mode:	Registrar
Configure via Push Button:	Start PBC
Configure via Client PinCode:	<input type="text"/> Start PIN

Display and configures the WPS setting.

Item	Description
Enable WPS	Check this box to enable WPS functionality; uncheck to disable WPS.
WPS Status	Displays WPS configuration status: Configured (WPS ready), or Unconfigured. If you set wireless security as described in previous section already, WPS status will be 'Configured'.
Self PinCode	Displays WPS self pin code. This code will be used when pin-style WPS pairing mode is being used, and WPS wireless clients will need to know this code.
Device Name (SSID)	Displays the device name of this WPG.
Authentication Mode	Displays current wireless authentication mode.
Passphrase Key	Here uses asterisk mark (*) to show WPA passphrase key.
Config Mode	Select WPS configuration mode: 'Registrar' and 'Enrollee'. Default and recommend setting: Registrar.
Configure via Push Button	Click "Start PBC" to handshake with other device with WPS function. NOTE 1: When WPG is in 'Registrar mode', another wireless device must set to 'Enrollee' mode; and vice versa. NOTE 2: When no WPS connection is established within 2 minutes, this mode will be turned off. NOTE 3: You can also press 'WPS' button located on the front of wireless presentation gateway to enter WPS mode, too.
Configure via Client PinCode	Input the PIN code (up to 8 characters) of the WPS-enabled device here, then click 'Start PIN' button, then WPG will establish connection with it automatically.

4-6 Projection Setting

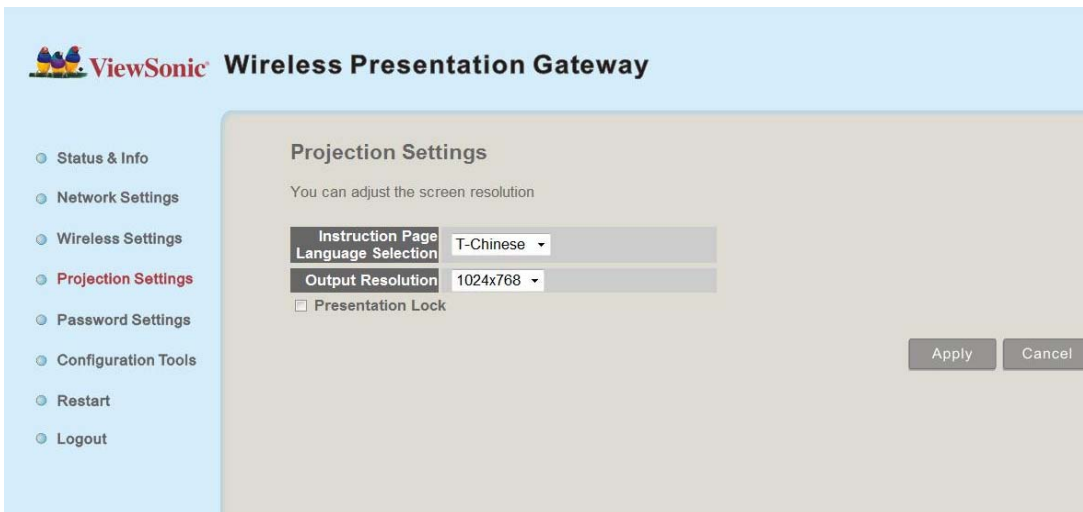

Displays and configures the projection setting.

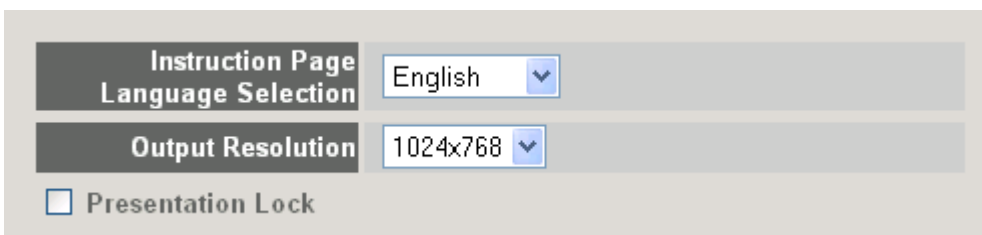

Item	Description
Instruction Page Language Selection	Select the displaying language.
Output Resolution	Select output resolution for projection.
Presentation lock	Check this box to prevent other users to interrupt current presentation.

Click 'Apply' button to save the settings.

NOTE: When the configuration settings are changed, you must restart the network connection. You can restart the network connection by clicking "Restart" on the main menu.

4-7 Password Setting

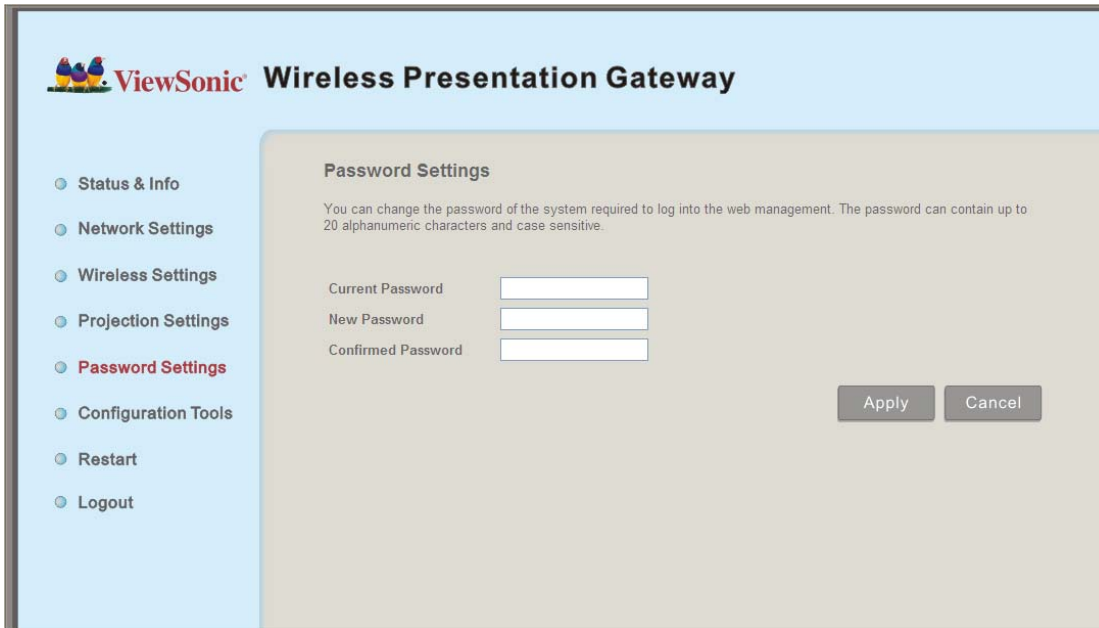

Displays and configures the password setting.

Current Password	<input type="text"/>
New Password	<input type="text"/>
Confirmed Password	<input type="text"/>

Item	Description
Current Password	Input current password here.
New Password / Confirmed Password	New Password: Enter new password. Confirmed Password: Confirmed the new entered password.

Click 'Apply' button to save the settings.

NOTE: When the configuration settings are changed, you must restart the network connection. You can restart the network connection by clicking "Restart" on the main menu.

4-8 Configuration Tools

4-8-1 Configuration Tools



Allows you to backup / restore the setting of WPG.

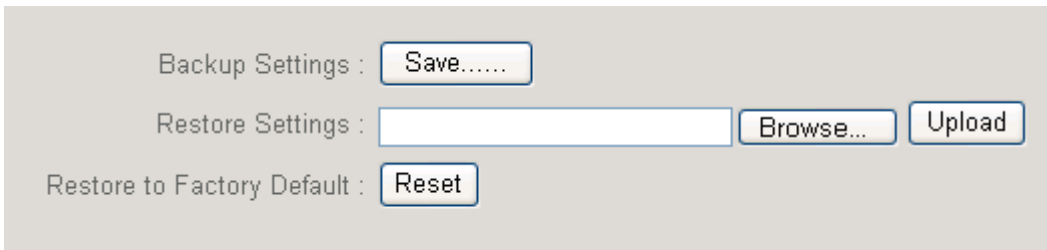

Displays and configures the configuration tools.

Item	Description
Backup Settings	Click 'Save...' button to save wireless presentation gateway's current setting as a file and store it on your computer.
Restore Settings	Click 'Browse...' button to select a previously-saved configuration file stored in your computer's folder.
Reset	Reset all settings of wireless presentation gateway back to factory default settings.

4-8-2 Firmware Upgrade

Upgrade the firmware of this WPG.

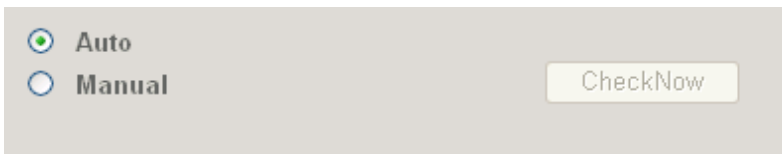
A screenshot of a firmware upgrade control panel. It features two radio button options: 'Auto' (selected) and 'Manual'. To the right of these options is a button labeled 'CheckNow'.

Auto
 Manual

CheckNow

Select 'Auto', WPG will download and upgrade latest firmware automatically once WPG connects to Internet.

Note:

- *It's recommended to use wired Ethernet connection to perform firmware upgrade.*
- *The upgrade might take more than 30 minutes, vary by Internet speed. Please be patient during the upgrade, and do not turn off the power until the device restarts and resumes the screen back to instruction page.*

4-9 Restart

Restart WPG when the device is not working properly or to apply changes made on web configuration menu.



Note: Restart takes about 60 seconds.

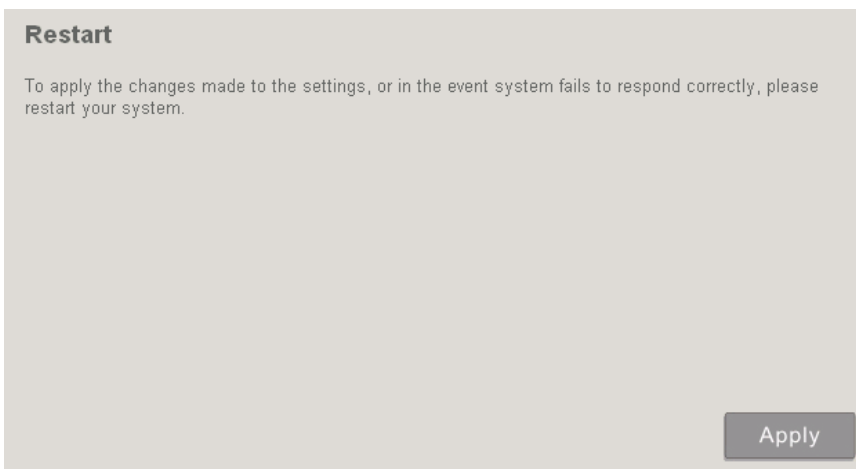

Click 'Apply' to restart the WPG.

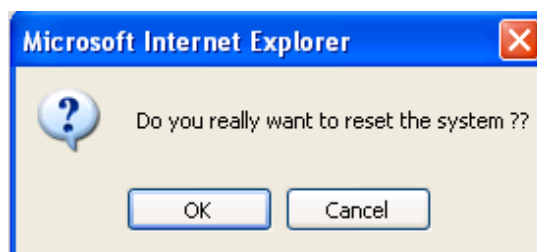

Click 'OK' to restart the WPG, or click 'Cancel' to abort.

4-10 Logout

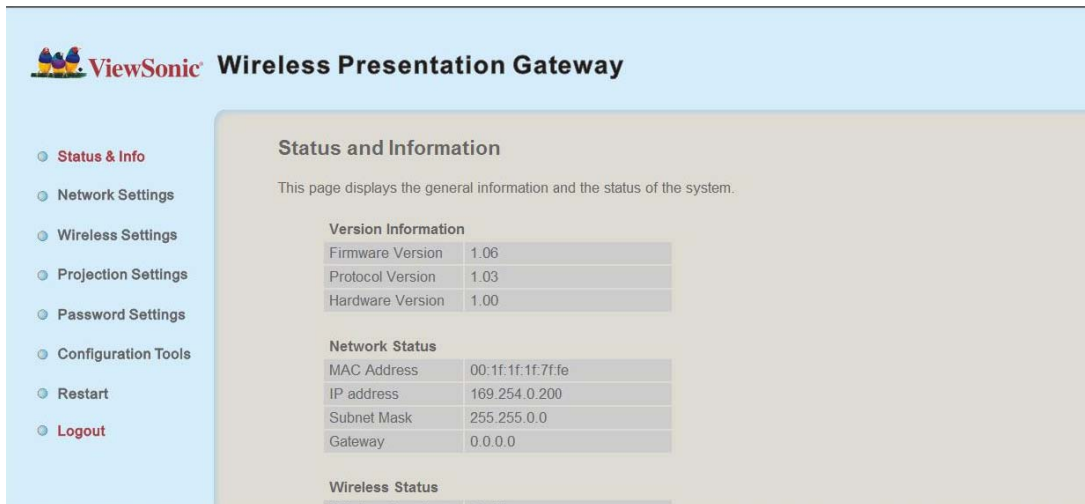

If you wish to logout from web configuration menu, click 'Logout'.

Chapter V Appendix

5-1 Hardware Specification

Product name	WPG-360
Power Supply	External power supply (12V DC, 1A)
Dimensions	133.4 x 92.4 x 31.08mm
Weight	218.5g (0.48lbs)
Connectivity	VGA Connector : VGA OUT ----- D-sub 15 pin mini x 1(Black) x 1 PC IN -----D-sub 15 pin mini x1(Blue) x 1 Audio Output Interface: 3.5mm jack x 1 USB Connector : USB Type A ----- For mouse control. USB Mini Type B ----- For USB display. Wired Network Interface : 10/100Mbps auto-sensing/auto-cross-over Ethernet port x 1 Wireless Network Interface : Built-in 802.11b/g/n
Output Resolution	1400x1050, 1280x800, 1024 x 768, 800x600
Environmental Requirements	Operating Temperature: 0 ~ 40°C Operating Humidity: 5 ~ 85%, non-condensing
Operating System	Supported OS : 1. Windows XP 32/63-bit (SP2 or higher) 2. Windows Vista 32/63-bit (SP1 or higher) 3. MAC OS 10.5 / 10.6 (Intel Version only) Supported Web browsers : 1. Microsoft Internet Explorer 6.0 (SP2) or higher 2. Mozilla's Firefox 3.0 or later 3. Safari
Software	Wireless Presentation Gateway software application

5-2 Troubleshooting

Scenario: Can't connect to wireless presentation gateway

Solution:

1. Check the LED lights located at the front of WPG. If 'Power' LED does not light, do the following check:

- Check the connection of A/C adapter, and if the electrical outlet you used with A/C adapter is functioning properly.
- Press 'Power' button on remote controller to see if 'Power' LED lights now.

2. Check the network connection.

3. Make sure you connected to correct IP address.

4. If you're using wireless network, make sure you connected to correct device.

5. If you're using wireless network, check the WEP / WPA password.

Scenario: Remote controller does not work

Solution: 1. Replace the battery of remote controller with a new one (CR-2032 lithium battery).

2. Please point the IR transmitter (located at the top of remote controller) to the IR receiver of WPG.

3. Make sure the IR receiver of WPG (labeled as 'Remote') is not blocked by any object.

4. If there's strong / fluorescent light source near IR transmitter / receiver, remote controller may not be able to function properly.

5. If the distance between IR transmitter / receiver is longer than 7 meters, remote controller may not working properly.

6. Make sure the IR extending cable is correctly inserted to 'IR IN' jack at the back of WPG, not 'AUDIO OUT' jack.

Scenario: No image displayed on WPG's display

Solution:

1. Check the connection between video display and WPG.
2. Make sure the video display you're using supports the video output mode you selected (in VGA mode).
3. Make sure the video display is switched on.

Scenario: I hear noise when WPG is operating.

Solution: If you smell something strange or even see smoke come out from WPG, unplug the A/C adapter (if possible), and return the WPG back to dealer of purchase immediately.

Scenario: No image output via USB display in Windows system

Solution:

1. Make sure the cable is well-connected between WPG-360 and your PC.
2. Make sure no one is doing the presentation.
3. Please access to the disk "vsPresenter" from "COMPUTER" and execute "vsPresenter.exe".

Scenario: No audio output in MAC

Solution:

1. Please make sure "Enable Audio" is selected.
2. An inquiry window will pop up to ask you to install extra program to you're your MAC PC to output audio to WPG-360.

Scenario: No image display when operating some media players (e.g. Windows Media Player) under Windows XP.

Solution:

1. Please download video driver from the "Download" page and install to your computer. Please always reboot the computer to make it effectively after the installation.
2. The video driver installation inquiry will automatically pop up whenever WPG-360

application software is activated. Once installed, it will not be shown next time.

NOTE:

- If certain web content (e.g. youtube) could not be displayed, please go to “Device Manager” of the computer and uninstall the “mirage driver”.

Scenario: When USB mouse does not work at certain application programs under Windows Vista or Windows 7.

Solution:

1. Please go to “Change User Account settings”, uncheck “Use User Account Control (UAC) to help protect your computer” (for Windows Vista) or set to “Never notify” (for Windows 7).

Customer Support

For technical support or product service, see the table below or contact your reseller.

NOTE: You will need the product serial number.

Country/Region	Website	T = Telephone F = FAX	Email
Australia/New Zealand	www.viewsonic.com.au	AUS= 1800 880 818 NZ= 0800 008 822	service@au.viewsonic.com
Canada	www.viewsonic.com	T (Toll-Free)= 1-866-463-4775 T (Toll)= 1-424-233-2533 F= 1-909-468-3757	service.ca@viewsonic.com
Europe	www.viewsoniceurope.com	www.viewsoniceurope.com/uk/support/call-desk/	
Hong Kong	www.hk.viewsonic.com	T= 852 3102 2900	service@hk.viewsonic.com
India	www.in.viewsonic.com	T= 1800 266 0101	service@in.viewsonic.com
Ireland (Eire)	www.viewsoniceurope.com/uk/	www.viewsoniceurope.com/uk/ support/call-desk/	service_ie@viewsoniceurope.com
Korea	www.kr.viewsonic.com	T= 080 333 2131	service@kr.viewsonic.com
Latin America (Argentina)	www.viewsonic.com/la/	T= 0800-4441185	soporte@viewsonic.com
Latin America (Chile)	www.viewsonic.com/la/	T= 1230-020-7975	soporte@viewsonic.com
Latin America (Columbia)	www.viewsonic.com/la/	T= 01800-9-157235	soporte@viewsonic.com
Latin America (Mexico)	www.viewsonic.com/la/	T= 001-8882328722	soporte@viewsonic.com
Renta y Datos, 29 SUR 721, COL. LA PAZ, 72160 PUEBLA, PUE. Tel: 01.222.891.55.77 CON 10 LINEAS Electroser, Av Reforma No. 403Gx39 y 41, 97000 Mérida, Yucatán. Tel: 01.999.925.19.16 Other places please refer to http://www.viewsonic.com/la/soporte/index.htm#Mexico			
Latin America (Peru)	www.viewsonic.com/la/	T= 0800-54565	soporte@viewsonic.com
Macau	www.hk.viewsonic.com	T= 853 2870 0303	service@hk.viewsonic.com
Middle East	ap.viewsonic.com/me/	Contact your reseller	service@ap.viewsonic.com
Puerto Rico & Virgin Islands	www.viewsonic.com	T= 1-800-688-6688 (English) T= 1-866-379-1304 (Spanish) F= 1-909-468-3757	service.us@viewsonic.com soporte@viewsonic.com
Singapore/Malaysia/ Thailand	www.ap.viewsonic.com	T= 65 6461 6044	service@sg.viewsonic.com
South Africa	ap.viewsonic.com/za/	Contact your reseller	service@ap.viewsonic.com
United Kingdom	www.viewsoniceurope.com/uk/	www.viewsoniceurope.com/uk/ support/call-desk/	service_gb@viewsoniceurope.com
United States	www.viewsonic.com	T (Toll-Free)= 1-800-688-6688 T (Toll)= 1-424-233-2530 F= 1-909-468-3757	service.us@viewsonic.com

Limited Warranty

Please go to the Customer Support table in this guide for the ViewSonic website in your region to get warranty information.



Free Manuals Download Website

<http://myh66.com>

<http://usermanuals.us>

<http://www.somanuals.com>

<http://www.4manuals.cc>

<http://www.manual-lib.com>

<http://www.404manual.com>

<http://www.luxmanual.com>

<http://aubethermostatmanual.com>

Golf course search by state

<http://golfingnear.com>

Email search by domain

<http://emailbydomain.com>

Auto manuals search

<http://auto.somanuals.com>

TV manuals search

<http://tv.somanuals.com>