

DESIGNER SERIES
BUILT-IN / FREESTANDING
MICROWAVE OVEN

Use and Care Manual



VIKING RANGE CORPORATION

Service Information

If service is required:

1. Call your dealer or authorized service agency. The name of the authorized service agency can be obtained from the dealer or distributor in your area.
2. Have the following information readily available:
 - a. Model number
 - b. Serial number
 - c. Date purchased
 - d. Name of dealer from whom purchased
3. Clearly describe the problem that you are having.

If you are unable to obtain the name of an authorized service agency, or if you continue to have service problem, contact Viking Range Corporation at (888) 845-4641 or write to:

VIKING RANGE CORPORATION
PREFERRED SERVICE
111 Front Street
Greenwood, Mississippi (MS) 38930 USA

Record the information indicated below. You will need it if service is ever required. The model and serial number for your microwave oven are located on the left side of the microwave oven cavity on an identification label.

Model Number _____ Serial Number _____

Date of Purchase _____ Date Installed _____

Dealer's Name _____

Address _____

If service requires installation of parts, use only authorized parts to ensure protection under the warranty.

PLEASE RETAIN THIS MANUAL FOR FUTURE REFERENCE

Table of Contents

2 Service Information	19-23 Sensor Options
3 Table of Contents	20-22 Sensor Options Chart
4-5 Important Safety Instructions	23 Frozen Foods Chart
5 Precautions to Avoid Possible Exposure to Excessive Microwave Energy	24-36 Cooking
6-7 Installation Instructions	24 Breakfast and Lunch
8 Grounding Instructions	25-26 Breakfast Chart
9-13 Information You Need to Know	26 Lunch Chart
9 About Your Microwave Oven	27 15 Minute Dinners and Preset Recipes
9 About Children and the Microwave	28-30 15 Minute Dinners
10 About Food	30-32 Preset Recipes
11 About Utensils and Coverings	33-35 Defrost
12 About Microwave Cooking	36 Beverages
13 About Safety	36 Beverages Chart
14-15 Part Names	37-40 Other Convenient Features
13 Microwave Oven Parts	37 Warm/Hold
14 Control Panel	37 Multiple Sequence Cooking
16 Before Operating	38 More or Less Time Adjustment
16 To Set the Clock	38-39 Help (Control pad)
16 Language/Weight Selection	40 Touch On
16 Stop/Clear	40 Timer
17-18 Manual Operation	40 Help (Display indicator)
17 Time Cooking	41 Demonstration Mode
17 To Set Power Level	41 Add-A-Minute
18 Manual Defrost	41-42 Cleaning and Care
	43 Specifications
	44 Service Call Check
	45 Warranty

Important Safety Instructions

When using electrical appliances basic safety precautions should be followed, including the following:

WARNING - To reduce the risk of burns, electric shock, fire, injury to persons or exposure to excessive microwave energy:

1. READ ALL INSTRUCTIONS BEFORE USING THE APPLIANCE.
2. Read and follow the specific "PRECAUTIONS TO AVOID POSSIBLE EXPOSURE TO EXCESSIVE MICROWAVE ENERGY" on page 5.
3. This appliance must be grounded. Connect only to properly grounded outlet. See "GROUNDING INSTRUCTIONS" on page 8.
4. Install or locate this appliance only in accordance with the provided installation instructions.
5. Some products such as whole eggs and sealed containers—for example, closed glass jars—may explode and should not be heated in this microwave oven.
6. Stir liquids briskly before, during and after heating to avoid eruption.
7. Use this appliance only for its intended use as described in this manual. Do not use corrosive chemicals or vapors in this appliance. This type of microwave oven is specifically designed to heat, cook or dry food. It is not designed for industrial or laboratory use.
8. As with any appliance, close supervision is necessary when used by children.
9. Do not operate this appliance if it has a damaged cord or plug, if it is not working properly or if it has been damaged or dropped.
10. This appliance should be serviced only by qualified service personnel. Contact nearest Viking Authorized Servicer for examination, repair or adjustment.
11. Do not cover or block any openings on the appliance.
12. Do not store or use this appliance outdoors. Do not use this product near water—for example, near a kitchen sink, in a wet basement or near a swimming pool, and the like.
13. Do not immerse cord or plug in water.
14. Keep cord away from heated surfaces.
15. Do not let cord hang over edge of table or counter.
16. See door surface cleaning instructions on page 41.
17. To reduce the risk of fire in the microwave oven cavity:
 - a. Do not overcook food. Carefully attend appliance if paper, plastic or other combustible materials are placed inside the microwave oven to facilitate cooking.

- b. Remove wire twist-ties from paper or plastic bags before placing bag in microwave oven.
 - c. If materials inside the microwave oven should ignite, keep microwave oven door closed, turn microwave oven off and disconnect the power cord or shut off power at the fuse or circuit breaker panel.
 - d. Do not use the cavity for storage purposes. Do not leave paper products, cooking utensils or food in the cavity when not in use.
18. If the microwave oven is installed as a built-in, observe the following instructions:
- a. Do not operate any heating or cooking appliance beneath this appliance.
 - b. Do not mount unit over or near any portion of a heating or cooking appliance.
 - c. Do not mount over a sink.
 - d. Do not store anything directly on top of the appliance surface when the appliance is in operation.
19. If the microwave oven light fails, consult a VIKING AUTHORIZED SERVICER.

SAVE THESE INSTRUCTIONS

PRECAUTIONS TO AVOID POSSIBLE EXPOSURE TO EXCESSIVE MICROWAVE ENERGY

- (a) Do not attempt to operate this microwave oven with the door open since open-door operation can result in harmful exposure to microwave energy. It is important not to defeat or tamper with the safety interlocks.
- (b) Do not place any object between the microwave oven front face and the door or allow soil or cleaner residue to accumulate on sealing surfaces.
- (c) Do not operate the microwave oven if it is damaged. It is particularly important that the microwave oven door close properly and that there is no damage to the: (1) door (bent), (2) hinges and latches (broken or loosened), (3) door seals and sealing surfaces.
- (d) The microwave oven should not be adjusted or repaired by anyone except properly qualified service personnel.

Installation Instructions

Unpacking and Examining Your Microwave Oven

Remove all packing materials from inside the microwave oven cavity; however, DO NOT REMOVE THE WAVEGUIDE COVER, which is located on the right cavity wall. Read enclosures and SAVE the Installation/Use and Care Manual.

Check the microwave oven for any damage, such as misaligned or bent door, damaged door seals and sealing surfaces, broken or loose door hinges and latches and dents inside the cavity or on the door. If there is any damage, do not operate the microwave oven and contact your dealer or VIKING AUTHORIZED SERVICER.

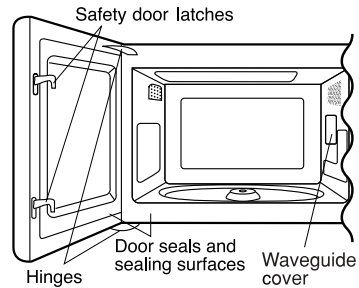

Choosing a Location for Your Microwave Oven on the Counter

You will use the microwave oven frequently so plan its location for ease of use. It's wise, if possible, to have counter space on at least one side of the microwave oven. Allow at least 2 inches on the sides, top and at the rear of the microwave oven for air circulation.

Choosing a Location for Your Built-in Microwave Oven

Your microwave oven can be built into a cabinet or wall by itself or above an oven. To install a microwave oven above a built-in oven, the applicable trim kits are as follows:

VIKING Designer Series:

- For installation with an electric 27" wide single oven (DESO170 / DESO175) use built-in trim kit DMTK270.
- For installation with an electric 30" wide single oven (DESO100 / DESO105) use built-in trim kit DMTK300.

Do not build in above any other gas or electric oven.

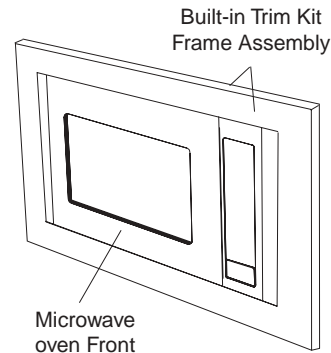

See built-in trim kit installation instructions for proper location when building in above the specified ovens. Carefully follow both the oven installation instructions and built-in trim kit instructions.

The opening in the wall or cabinet must be within the following dimensions:

A HEIGHT : 16 3/4" - 17"

B WIDTH : 24 3/8" - 24 11/16"

C DEPTH : minimum 20"

Outlet should NOT be in the shaded area as indicated.

Over Oven Installation

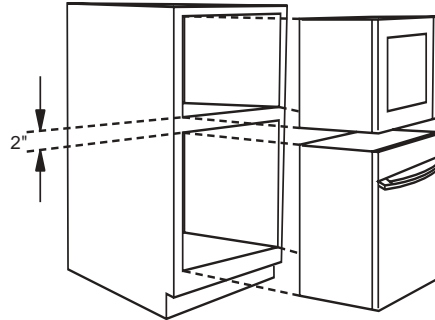

1. If the dimension of DEPTH (C) is more than 21", the outlet location may be any area on the rear wall.
2. The floor of the opening should be constructed of plywood strong enough to support the weight of the microwave oven and floor load (about 100 pounds). The floor should be level for proper operation of the microwave oven. Be sure to check the local building code as it may require that the opening be enclosed with sides, ceiling and rear partition. The proper functioning of the microwave oven does not require the enclosure.

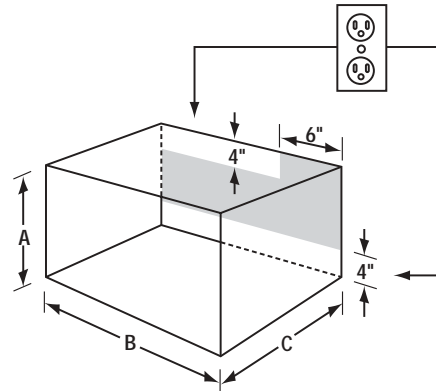

The built-in trim kit includes all the necessary parts and easy-to-follow instructions for installation as well as location of the power supply.

The ease of assembly for these kits will allow installation into an existing wall opening in less than an hour (if power outlet is already properly located).

All it takes are four steps and a Phillips screw driver.

Grounding Instructions

This appliance must be grounded. This microwave oven is equipped with a cord having a grounding wire with a grounding plug. It must be plugged into a wall receptacle that is properly installed and grounded in accordance with the National Electrical Code and local codes and ordinances. In the event of an electrical short circuit, grounding reduces risk of electric shock by providing an escape wire for the electric current.

WARNING – Improper use of the grounding plug can result in a risk of electric shock.

Electrical Requirements

The electrical requirements are a 120 volt 60 Hz, AC only, 15 amp. or more protected electrical supply. It is recommended that a separate circuit serving only this appliance be provided.

The microwave oven is equipped with a 3-prong grounding plug. It must be plugged into a wall receptacle that is properly installed and grounded. Should you only have a 2-prong outlet, have a qualified electrician install a correct wall receptacle.

A 3-prong adapter may be purchased and used temporarily if local codes allow. Follow package directions.

A short power-supply cord is provided to reduce risk of becoming entangled in or tripping over a longer cord.

Extension Cord

If it is necessary to use an extension cord, use only a 3-wire extension cord that has a 3-blade grounding plug and a 3-slot receptacle that will accept the plug on the microwave oven. The marked rating of the extension cord should be AC 115-120 volt, 15 amp. or more.

Be careful not to drape the cord over the countertop or table where it can be pulled on by children or tripped over accidentally.

Notes:

1. If you have any questions about the grounding or electrical instructions, consult a qualified electrician or service person.
2. Neither Viking nor the dealer can accept any liability for damage to the microwave oven or personal injury resulting from failure to observe the correct electrical connection procedures.

Radio or TV Interference

Should there be any interference caused by the microwave oven to your radio or TV, check that the microwave oven is on a different electrical circuit, relocate the radio or TV as far away from the microwave oven as feasible or check position and signal of receiving antenna.

Permanent and Correct Installation

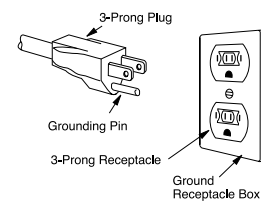

Temporary Use

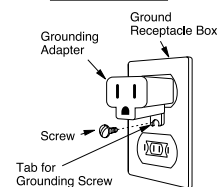

Information You Need To Know

About Your Microwave oven

This Installation/Use and Care Manual is valuable: read it carefully and always save it for reference.

A good microwave cookbook is a valuable asset. Check it for microwave cooking principles, techniques, hints and recipes.

NEVER use the microwave oven without the turntable and support nor turn the turntable over so that a large dish could be placed in the microwave oven. The turntable will turn both clockwise and counterclockwise.

ALWAYS have food in the microwave oven when it is on to absorb the microwave energy.

When using the microwave oven at power levels below 100%, you may hear the magnetron cycling on and off. It is normal for the exterior of the microwave oven to be warm to the touch when cooking or reheating.

Condensation is a normal part of microwave cooking. Room humidity and the moisture in food will influence the amount of moisture that condenses in the microwave oven. Generally, covered foods will not cause as much condensation as uncovered ones. Vents on the microwave oven back must not be blocked.

The microwave oven is for food preparation only. It should not be used to dry clothes or newspapers.

Your microwave oven is rated 1100 watts by using the IEC Test Procedure. In using recipes or package directions, check food a minute or two before the minimum time and add time accordingly.

About Children and the Microwave

Children below the age of 7 should use the microwave oven with a supervising person very near to them. Between the ages of 7 and 12, the supervising person should be in the same room.

The child must be able to reach the microwave oven comfortably; if not, he/she should stand on a sturdy stool.

At no time should anyone be allowed to lean or swing on the microwave oven door.

Children should be taught all safety precautions: use potholders, remove coverings carefully, pay special attention to packages that crisp food because they may be extra hot.

Don't assume that because a child has mastered one cooking skill he/she can cook everything.

Children need to learn that the microwave oven is not a toy. See page 38 for Child Lock feature.

About Food

FOOD	DO	DON'T
Eggs, sausages, nuts, seeds, fruits & vegetables	<ul style="list-style-type: none"> • Puncture egg yolks before cooking to prevent "explosion". • Pierce skins of potatoes, apples, squash, hot dogs and sausages so that steam escapes. 	<ul style="list-style-type: none"> • Cook eggs in shells. • Reheat whole eggs. • Dry nuts or seeds in shells.
Popcorn	<ul style="list-style-type: none"> • Use specially bagged popcorn for the micro-wave oven. • Listen while popping corn for the popping to slow to 1 or 2 seconds or use special Popcorn pad. 	<ul style="list-style-type: none"> • Pop popcorn in regular brown bags or glass bowls. • Exceed maximum time on popcorn package.
Baby food	<ul style="list-style-type: none"> • Transfer baby food to small dish and heat carefully, stirring often. Check temperature before serving. • Put nipples on bottles after heating and shake thoroughly. "Wrist" test before feeding. 	<ul style="list-style-type: none"> • Heat disposable bottles. • Heat bottles with nipples on. • Heat baby food in original jars.
General	<ul style="list-style-type: none"> • Cut baked goods with filling after heating to release steam and avoid burns. • Stir liquids briskly before, during and after heating to avoid "eruption". • Use deep bowl, when cooking liquids or cereals, to prevent boilovers. 	<ul style="list-style-type: none"> • Heat or cook in closed glass jars or air tight containers. • Can in the microwave as harmful bacteria may not be destroyed. • Deep fat fry. • Dry wood, gourds, herbs or wet papers.

About Utensils and Coverings

It is not necessary to buy all new cookware. Many pieces already in your kitchen can be used successfully in your new microwave oven. Make sure the utensil does not touch the interior walls during cooking.

Use these utensils for safe microwave cooking and reheating:

- glass ceramic (Pyroceram®), such as Corningware®.
- heat-resistant glass (Pyrex®)
- microwave-safe plastics
- paper plates
- microwave-safe pottery, stoneware and porcelain
- browning dish (Do not exceed recommended preheating time. Follow manufacturer's directions.)

These items can be used for short time reheating of foods that have little fat or sugar in them:

- wood, straw, wicker

DO NOT USE

- metal pans and bakeware
- dishes with metallic trim
- non-heat-resistant glass
- non-microwave-safe plastics (margarine tubs)
- recycled paper products
- brown paper bags
- food storage bags
- metal twist-ties

Should you wish to check if a dish is safe for microwaving, place the empty dish in the microwave oven and microwave on HIGH for 30 seconds. A dish which becomes very hot should not be used.

The following coverings are ideal:

- Paper towels are good for covering foods for reheating and absorbing fat while cooking bacon.
- Wax paper can be used for cooking and reheating.
- Plastic wrap that is specially marked for microwave use can be used for cooking and reheating. DO NOT allow plastic wrap to touch food. Vent so steam can escape.
- Lids that are microwave-safe are a good choice because heat is kept near the food to hasten cooking.
- Microwave oven cooking bags are good for large meats or foods that need tenderizing. DO NOT use metal twist ties. Remember to slit bag so steam can escape.

How to use aluminum foil in your microwave oven:

- Small flat pieces of aluminum foil placed smoothly on the food can be used to shield areas that are either defrosting or cooking too quickly.
- Foil should not come closer than one inch to any surface of the microwave oven.

Should you have questions about utensils or coverings, check a good microwave cookbook or follow recipe suggestions.

ACCESSORIES There are many microwave accessories available for purchase. Evaluate carefully before you purchase so that they meet your needs. A microwave-safe thermometer will assist you in determining correct doneness and assure you that foods have been cooked to safe temperatures. Viking is not responsible for any damage to the microwave oven when accessories are used.

About Microwave Cooking

- Arrange food carefully. Place thickest areas towards outside of dish.
- Watch cooking time. Cook for the shortest amount of time indicated and add more as needed. Food severely overcooked can smoke or ignite.
- Cover foods while cooking. Check recipe or cookbook for suggestions: paper towels, wax paper, microwave plastic wrap or a lid. Covers prevent spattering and help foods to cook evenly.
- Shield with small flat pieces of aluminum foil any thin areas of meat or poultry to prevent overcooking before dense, thick areas are cooked thoroughly.
- Stir foods from outside to center of dish once or twice during cooking, if possible.
- Turn foods over once during microwaving to speed cooking of such foods as chicken and hamburgers. Large items like roasts must be turned over at least once.
- Rearrange foods such as meatballs halfway through cooking both from top to bottom and from the center of the dish to the outside.
- Add standing time. Remove food from microwave oven and stir, if possible. Cover for standing time which allows the food to finish cooking without overcooking.
- Check for doneness. Look for signs indicating that cooking temperatures have been reached.

Doneness signs include:

- Food steams throughout, not just at edge.
- Center bottom of dish is very hot to the touch.
- Poultry thigh joints move easily.
- Meat and poultry show no pinkness.
- Fish is opaque and flakes easily with a fork.

About Safety

- Check foods to see that they are cooked to the United States Department of Agriculture's recommended temperatures.

To test for doneness, insert a meat thermometer in a thick or dense area away from fat or bone. NEVER leave the thermometer in the food during cooking, unless it is approved for microwave oven use.

TEMP	FOOD
160°F (71°C)	... for fresh pork, ground meat, boneless white poultry, fish, seafood, egg dishes and frozen prepared food.
165°F (74°C)	... for leftover, ready-to-reheat refrigerated, and deli and carry-out "fresh" food.
170°F (77°C)	... white meat of poultry.
180°F (82°C)	... dark meat of poultry.

- ALWAYS use potholders to prevent burns when handling utensils that are in contact with hot food. Enough heat from the food can transfer through utensils to cause skin burns.
- Avoid steam burns by directing steam away from the face and hands. Slowly lift the farthest edge of a dish's covering and carefully open popcorn and microwave oven cooking bags away from the face.
- Stay near the microwave oven while it's in use and check cooking progress frequently so that there is no chance of overcooking food.
- NEVER use the cavity for storing cookbooks or other items.
- Select, store and handle food carefully to preserve its high quality and minimize the spread of foodborne bacteria.
- Keep waveguide cover clean. Food residue can cause arcing and/or fires.
- Use care when removing items from the microwave oven so that the utensil, your clothes or accessories do not touch the safety door latches.
- Keep aluminum foil used for shielding at least 2.5 cm (1 inch) away from walls, ceiling and door of microwave oven.

Part Names

Microwave Oven Parts

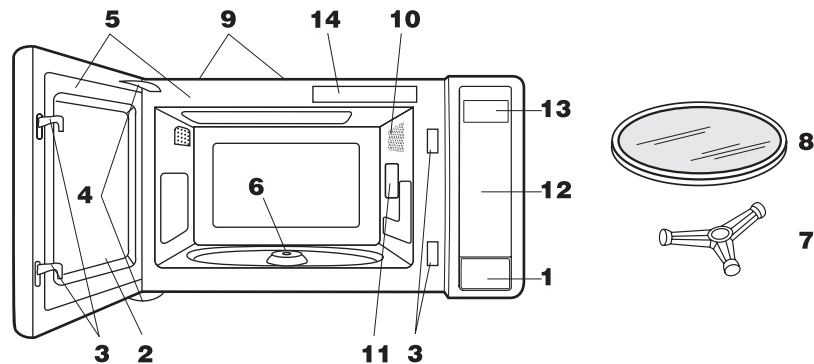

- | | |
|---|--|
| 1 One touch door open button
Push to open door. | 8 Removable turntable
Place the turntable on the
turntable support securely.
The turntable will rotate clockwise
or counterclockwise. Only remove
for cleaning. |
| 2 Microwave oven door with see-
through window | 9 Ventilation openings (Rear) |
| 3 Safety door latches
The microwave oven will not
operate unless the door is
securely closed. | 10 Microwave oven light
It will light when microwave oven
is operating or door is open. |
| 4 Door hinges | 11 Waveguide cover: DO NOT
REMOVE. |
| 5 Door seals and sealing surfaces | 12 Auto-Touch control panel |
| 6 Turntable motor shaft | 13 Interactive display: 99 minutes,
99 seconds |
| 7 Removable turntable support
Carefully place the turntable
support in the center of the
microwave oven floor. | 14 COOKING menu label |

Control Panel

The two-line, Interactive Display spells out operating steps and shows cooking hints. When HELP is lighted in the display, touch the Help pad to read a specific hint which may assist you.

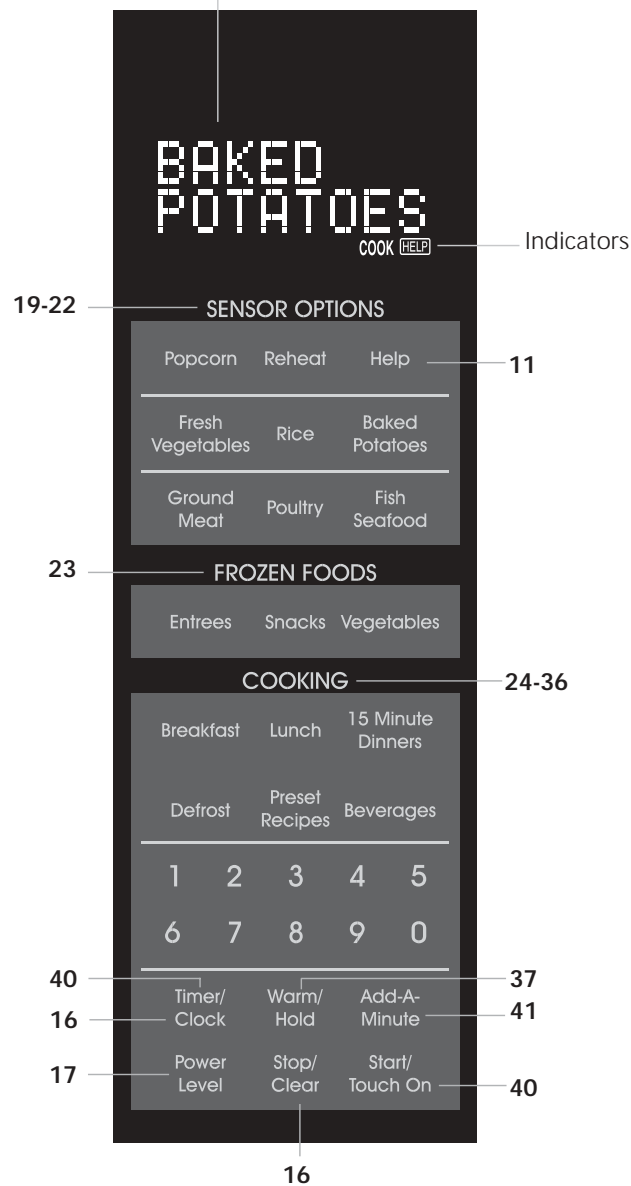

Number next to the control panel illustration indicates pages on which there are feature descriptions and usage information.

Before Operating

- Before operating your new microwave oven make sure you read and understand this Installation/Use and Care Manual completely.
- Before the microwave oven can be used, follow these procedures:
 1. Plug in the microwave oven. Close the door. The microwave oven display will show **WELCOME**.
 2. Touch the Stop/Clear pad. **0** will appear.
 3. Set clock.

To Set the Clock

- Suppose you want to enter the correct time of day 12:30 (A.M. or P.M.).

PROCEDURE	DISPLAY		
1. Touch Timer/Clock pad and number 2 pad.	<table border="1"><tr><td>ENTER</td><td>TIME OF DAY</td></tr></table>	ENTER	TIME OF DAY
ENTER	TIME OF DAY		
2. Enter the correct time of day by touching the numbers in sequence. Touch Timer/Clock pad again.	<table border="1"><tr><td>12:30</td></tr></table>	12:30	
12:30			

This is a 12 hour clock. If you attempt to enter an incorrect clock time, **ERROR** will appear in the display. Touch the Stop/Clear pad and re-enter the time.

- If the electrical power supply to your microwave oven should be interrupted, the display will intermittently show **WELCOME** after the power is reinstated. If this occurs during cooking, the program will be erased. The time of day will also be erased. Simply touch Stop/Clear pad and reset the clock for the correct time of day.

Language/Weight Selection

The microwave oven comes set for English and U.S. Customary Unit-pounds. To change, touch Help and the number 4 pad. Continue to touch the number 4 pad until your choice is selected. Then touch Start/Touch On. See page 39.

Stop/Clear



Touch the Stop/Clear pad to:

1. Erase if you make a mistake during programming.
2. Cancel timer.
3. Stop the microwave oven temporarily during cooking.
4. Return the time of day to the display.
5. Cancel a program during cooking, touch twice.

Manual Operation

Time Cooking

Your microwave oven can be programmed for 99 minutes and 99 seconds (99.99). Always enter the seconds after the minutes, even if they are both zeros.

PROCEDURE	DISPLAY
1. Enter cooking time.	
2. Touch Start/Touch On pad.	

To Set Power Level

There are eleven preset power levels.

Using lower power levels increases the cooking time which is recommended for foods such as cheese, milk and long slow cooking of meats. Consult cook-book or recipes for specific recommendations.

TOUCH POWER LEVEL PAD NUMBER OF TIMES FOR DESIRED POWER	APPROXIMATE PERCENTAGE OF POWER	COMMON WORDS FOR POWER LEVELS
Power Level x 1	100%	High
Power Level x 2	90%	
Power Level x 3	80%	
Power Level x 4	70%	Medium High
Power Level x 5	60%	
Power Level x 6	50%	Medium
Power Level x 7	40%	
Power Level x 8	30%	Med Low/Defrost
Power Level x 9	20%	
Power Level x 10	10%	Low
Power Level x 11	0%	

- Suppose you want to defrost for 5 minutes at 30%.

PROCEDURE	DISPLAY
1. Enter defrost time.	5.00
2. Touch Power Level pad eight times or hold down until the desired power appears.	30 PERCENT
3. Touch Start/Touch On pad.	5.00 COOK
4. When the defrost time is complete, a long tone will sound and END will appear in the display.	END

Manual Defrost

If the food that you wish to defrost is not listed on the Super Defrost and Auto Charts or is above or below the limits in the "Amount" column on the Super Defrost and Auto Charts (pages 33 and 35), you need to defrost manually.

You can defrost any frozen food, either raw or previously cooked, by using Power Level 3. Follow the exact 4-step procedure found under To Set Power Level. Estimate defrosting time and press Power Level eight times for 30% power.

For either raw or previously cooked frozen food the rule of thumb is approximately 4 minutes per pound. For example, defrost 4 minutes for 1 pound of frozen spaghetti sauce.

Always stop the microwave oven periodically to remove or separate the portions that are defrosted. If food is not defrosted at the end of the estimated defrosting time, program the microwave oven in 1 minute increments at 30% until totally defrosted.

When using plastic containers from the freezer, defrost only long enough to remove from the plastic in order to place in a microwave-safe dish.

SENSOR OPTIONS

The Viking Sensor is a semi-conductor device that detects the vapor (moisture and humidity) emitted from the food as it heats. The sensor adjusts the cooking times and power level for various foods and quantities.

Using Sensor Settings:

1. After microwave oven is plugged in, wait 2 minutes before using SENSOR OPTIONS.
2. Be sure the exterior of the cooking container and the interior of the microwave oven are dry. Wipe off any moisture with a dry cloth or paper towel.
3. The microwave oven works with foods at normal storage temperature. For example, popcorn would be at room temperature.
4. Any SENSOR OPTIONS selection can be programmed with More or Less Time Adjustment. See page 38.
5. More or less food than the quantity listed in the chart should be cooked following the guidelines in any microwave cookbook.
6. During the first part of SENSOR OPTIONS, the food name will appear on the display. Do not open the microwave oven door or touch Stop/Clear during this part of the cooking cycle. The measurement of vapor will be interrupted. If this occurs, an error message will appear. To continue cooking, touch the Stop/Clear pad and cook manually.

When the sensor detects the vapor emitted from the food, remainder of cooking time will appear. The door may be opened when remaining cooking time appears on the display. At this time, you may stir or season food, as desired.

7. If the sensor does not detect vapor properly when popping popcorn, the microwave oven will turn off, and the correct time of day will be displayed. If the sensor does not detect vapor properly when cooking other foods, **ERROR** will be displayed, and the microwave oven will turn off.
8. Check food for temperature after cooking. If additional time is needed, continue to cook manually.
9. Each food has a cooking hint. Touch Help pad when the HELP indicator is lighted in the display.

Covering Foods:

Some foods work best when covered. Use the cover recommended in the SENSOR OPTIONS chart for these foods.

1. Casserole lid.
2. Plastic wrap: Use plastic wrap recommended for microwave cooking. Cover dish loosely; allow approximately 1/2 inch to remain uncovered to

allow steam to escape. Plastic wrap should not touch food.

3. Wax paper: Cover dish completely; fold excess wrap under dish to secure. If dish is wider than paper, overlap two pieces at least one inch to cover.

Be careful when removing any covering to allow steam to escape away from you.

Example:

You can cook many foods by simply selecting the food and touching Start/Touch On. You don't need to calculate cooking time or power level.

- Suppose you want to reheat canned chili.

1. Touch Reheat pad.
2. Touch Start/Touch On pad.

When the sensor detects the vapor emitted from the food, the remainder of cooking time will appear.

Note:

The Fresh Vegetables and Poultry settings have 2 choices. Follow directions in the Interactive Display to choose desired option.

Sensor Options Chart

FOOD	AMOUNT	PROCEDURE
Popcorn	1 package	Use only popcorn packaged for microwave oven use. Try several brands to decide which you like the best. Do not try to pop unpopped kernels.
	1.5 - 3.5 oz bag	Touch Popcorn pad and then Start/Touch On.
Reheat	4 - 36 oz	Place in dish or casserole slightly larger than amount to be reheated. Flatten, if possible. Cover with lid, plastic wrap or wax paper. Use covers such as plastic wrap or lids with larger quantities of more dense foods such as stews. After reheating, stir well, if possible. Foods should be very hot. If not, continue to heat with variable power and time. After stirring, re-cover and allow to stand 2 to 3 minutes.

Sensor Options Chart (continued)

FOOD	AMOUNT	PROCEDURE															
Fresh Vegetables: Soft		Wash and place in casserole. Add no water if vegetables have just been washed. Cover with lid for tender vegetables. Use plastic wrap for tender-crisp vegetables. Touch Fresh Vegetables, number 1 and Start/Touch On.															
Broccoli	.25 - 2.0 lb																
Brussels sprouts	.25 - 2.0 lb																
Cabbage	.25 - 2.0 lb																
Cauliflower (flowerets)	.25 - 2.0 lb																
Cauliflower (whole)	1 med.																
Spinach	.25 - 1.0 lb																
Zucchini	.25 - 2.0 lb																
Baked apples	2 - 4 med.																
Fresh vegetables: Hard			Place in casserole. Add 1-4 tbsp water. Cover with lid for tender vegetables. Use plastic wrap cover for tender-crisp vegetables. Touch Fresh Vegetables, number 2 and Start/Touch On.														
Carrots, sliced	.25 - 1.5 lb																
Corn on the cob	2 - 4																
Green beans	.25 - 1.5 lb																
Winter squash:																	
diced	.25 - 1.5 lb																
halves	1 - 2																
Rice	.5 - 2.0 cups	Place rice into a deep casserole dish and add double quantity of water. Cover with lid or plastic wrap. After cooking, stir, cover and let stand 3 to 5 minutes or until all liquid has been absorbed.															
		<table border="1"> <thead> <tr> <th>Rice</th> <th>Water</th> <th>Size of casserole dish</th> </tr> </thead> <tbody> <tr> <td>.5 cup</td> <td>1 cup</td> <td>1.5 quart</td> </tr> <tr> <td>1 cup</td> <td>2 cups</td> <td>2 quart</td> </tr> <tr> <td>1.5 cups</td> <td>3 cups</td> <td>2.5 or 3 quart</td> </tr> <tr> <td>2 cups</td> <td>4 cups</td> <td>3 quart or larger</td> </tr> </tbody> </table>	Rice	Water	Size of casserole dish	.5 cup	1 cup	1.5 quart	1 cup	2 cups	2 quart	1.5 cups	3 cups	2.5 or 3 quart	2 cups	4 cups	3 quart or larger
Rice	Water	Size of casserole dish															
.5 cup	1 cup	1.5 quart															
1 cup	2 cups	2 quart															
1.5 cups	3 cups	2.5 or 3 quart															
2 cups	4 cups	3 quart or larger															
Baked Potatoes	1 - 8 med.	Pierce. Place on paper-towel-lined turntable. After cooking, remove from microwave oven, wrap in aluminum foil and let stand 5 to 10 minutes.															

Sensor Options Chart (continued)

FOOD	AMOUNT	PROCEDURE
Ground Meat	.25 - 2.0 lb	Use this setting to cook ground beef or turkey as patties or in a casserole to be added to other ingredients. Place patties on a microwave-safe rack and cover with wax paper. Place ground meat in a casserole and cover with wax paper or plastic wrap. When microwave oven stops, turn patties over or stir meat in casserole to break up large pieces. Re-cover and touch Start/Touch On. After cooking, let stand, covered, for 2 to 3 minutes.
Poultry: Boneless	.5 - 2.0 lb	Use boneless breast of chicken or turkey. Cover with vented plastic wrap. Touch Poultry, number 1 and Start/Touch On pads. When microwave oven stops, rearrange. Re-cover and touch Start/Touch On pad. After cooking, let stand, covered, 3 to 5 minutes. Poultry should be 160°F.
Bone-in	.5 - 3.0 lb	Arrange pieces with meatiest portions toward outside of glass dish or microwave safe rack. Cover with vented plastic wrap. Touch Poultry, number 2 and Start/Touch On pads. After cooking, let stand, covered, 3 to 5 minutes. Dark meat should be 180°F and white meat should be 170°F.
Fish/Seafood	.25 - 2.0 lb	Arrange in ring around shallow glass dish (roll fillet with edges underneath). Cover with vented plastic wrap. After cooking, let stand, covered for 3 minutes.

Frozen Foods Chart

FOOD	AMOUNT	PROCEDURE
Entrees	6 - 17 oz	Use this pad for frozen convenience foods. It will give satisfactory results for most brands. You may wish to try several and choose your favorite. Remove package from outer wrapping and follow package directions for covering. After cooking, let stand, covered, for 1 to 3 minutes.
Snacks	3 - 8 oz	Use for frozen French fries, cheese sticks, appetizers etc. Remove from outer package. Follow package directions for how to wrap or cover. Be careful when removing from the microwave oven as snack may be very hot.
Vegetables	.25 - 1.5 lb	Add no water. Cover with lid or plastic wrap. After cooking, stir and let stand, covered, for 3 minutes.

COOKING

Your microwave oven has 6 convenience pads to assist with meal preparation. There are some foods in the Breakfast, Lunch, 15 Minute Dinners and Preset Recipes that use the sensor. See the sensor cooking information on page 19. For foods not using the sensor, follow the directions in the Interactive Display to enter quantity.

Breakfast and Lunch

Breakfast and Lunch are for cooking and heating popular foods that take a short amount of time.

- Suppose you want to use Breakfast to cook 2 servings of hot cereal.

PROCEDURE	DISPLAY			
1. Touch Breakfast pad.	<table border="1"> <tr> <td>SEE LABEL</td> <td>SELECT FOOD</td> <td>NUMBER</td> </tr> </table>	SEE LABEL	SELECT FOOD	NUMBER
SEE LABEL	SELECT FOOD	NUMBER		
2. Select desired Breakfast setting by touching desired number pad. (Ex: Touch number 3 pad to select hot cereal.)	<table border="1"> <tr> <td>HOT CEREAL</td> <td>ENTER NUMBER</td> <td>OF SERVINGS</td> </tr> </table>	HOT CEREAL	ENTER NUMBER	OF SERVINGS
HOT CEREAL	ENTER NUMBER	OF SERVINGS		
3. Enter quantity. (Ex: Touch number 2 pad for servings.) Touch Start/Touch On pad.	<table border="1"> <tr> <td>2 SERVINGS</td> <td>PRESS START</td> </tr> </table>	2 SERVINGS	PRESS START	
2 SERVINGS	PRESS START			
After cooking, follow the directions in the display.				

Note:

1. Heat rolls/muffins setting has 2 choices. Follow directions in the Interactive Display to choose desired option.
2. Breakfast can be programmed with More or Less Time Adjustment. Touch the Power Level pad once or twice before touching Start/Touch On pad. See page 38.
3. Each food has a cooking hint. Touch Help pad when the HELP indicator is lighted in the display.
4. Should you attempt to enter more or less than the allowed amount, an error message will appear in the display.
More or less than the quantity listed in the chart should be cooked following the guidelines in any microwave book.
5. The final cooking result will vary according to the food condition (e.g. initial temperature, shape, quality, covering). Check food for temperature after cooking. If additional time is needed, continue to cook manually.

Breakfast Chart

FOOD	AMOUNT	PROCEDURE
1. Scrambled Eggs	1 - 9 eggs	For each egg, use 1 teaspoon of butter or margarine and 1 tablespoon of milk. Place butter or margarine in dish, measuring cup or casserole large enough for the egg to expand. Mix egg and milk together. Pour onto butter or margarine in dish. Place in microwave oven and program. When audible signals are heard, stir egg mixture moving the cooked portion to the center of the dish and uncooked portion to the outside. After cooking, stir and let stand, covered, until set. Note that eggs will be slightly undercooked when removed from the microwave oven.
2. Bacon	2 - 6 slices	Place bacon on paper plate, lined with paper towel. Bacon should not extend over the rim of plate. Cover with another paper towel. Allow bacon to stand a few minutes after removing from the microwave oven to complete the cooking.
3. Hot Cereal	1 - 6 servings	Use individual packets or bulk cereal in your favorite variety: oatmeal, oat bran, cream of wheat, farina or wheatena. Follow package directions for the correct amount of water or milk. To prevent boil overs, it is very important to choose a large container because microwave cooking of cereal causes high boiling. If the microwave oven stops, stir and touch Start/Touch On. After cooking, stir and let stand, covered, for 2 minutes.
4. Rolls & Muffins		Use this pad to warm rolls, muffins, biscuits, bagels etc. Large items should be considered as 2 or 3 regular size. Arrange on plate, cover with paper towel.
Fresh	1 - 10 pieces	To warm fresh rolls and muffins, touch Breakfast, number 4 pad, and touch number 1 pad. Then enter desired quantity and touch Start/Touch On pad. For refrigerated rolls or muffins, it may be necessary to double the entered amount to ensure the proper serving temperature. For example, enter quantity of 2 for 1 refrigerated muffin.

Breakfast Chart (continued)

*It is not necessary to enter amount.

FOOD	AMOUNT	PROCEDURE
Frozen	1 - 10 pieces	For frozen rolls and muffins, touch Breakfast pad and touch number 4 pad, then number 2 pad. Then enter desired quantity and touch Start/Touch On pad.
5. Frozen Breakfast Foods*	1 (3 - 6 oz)	This setting works well for frozen breakfast entrees, pancakes, waffles, burritos etc. Follow manufacturer's directions for how to prepare for microwaving. Allow to stand 1 or 2 minutes after cooking.

Lunch Chart

*It is not necessary to enter amount.

FOOD	AMOUNT	PROCEDURE
1. Meal in the Cup*	1 cup (6 - 8 oz)	This setting is ideal for individual portions of canned food packed in a small microwaveable container, usually 6 to 8 ounces. Remove inner metal lid and replace outer microwaveable lid. After cooking, stir food and allow to stand 1 or 2 minutes.
2. Hot Dogs in Buns*	1 - 4 pieces	Place hot dog in bun. Wrap each with paper towel or napkin.
3. Soup*	1 - 8 cups	Place in bowl or casserole. Cover with lid or plastic wrap. At end, stir, re-cover and let stand 1 to 3 minutes.
4. Microwave Pizza*	1 (6 - 8 oz)	Use for frozen microwave pizza. Remove from package and unwrap. Follow package directions for use of package and/or silver crisping disk.
5. Frozen Sandwich*	1 (3 - 6 oz)	Use for frozen microwaveable sandwiches. Remove from package and follow directions for placing in the microwave oven.

15 Minute Dinners and Preset Recipes

15 Minute Dinners and Preset Recipes each offer five simple-to-prepare but great tasting meals. Follow the specific directions on the Recipe Card and in the Interactive Display.

- Suppose you want to use 15 Minute Dinners to cook Saucy Chicken.

PROCEDURE	DISPLAY		
1. Touch 15 Minute Dinners pad.	SEE LABEL	SELECT RECIPE	NUMBER
2. Select desired 15 Minute Dinners setting by touching desired number pad. (Ex: Touch number 1 pad to select Saucy Chicken.) Follow the Recipe Card for ingredients and instructions. Touch Start/Touch On pad.	SEE RECIPE	CARD	PRESS START
3. When the microwave oven stops, the display will show the instruction number on the Recipe Card. Follow the instructions on the Recipe Card. Touch Start/Touch On pad.	CHECK RECIPE	INSTRUC-TIONS 2	PRESS START
4. At end, the display will show the instruction number on the Recipe Card. Follow the instructions on the Recipe Card.	CHECK RECIPE	INSTRUC-TIONS 3	

15 Minute Dinners (Recipes serve 6)

1. SAUCY CHICKEN

1 Place in a 3-quart casserole:

- 1 tablespoon oil
- 1/2 pound mushrooms, sliced
- 1 onion, chopped
- 1 tablespoon minced garlic

Stir well and cover. Touch 15 Minute Dinners, number 1 to select SAUCY CHICKEN and then touch Start/Touch On.

2 Blend together:

- 8 ounces reduced fat cream cheese, softened
- 1/4 cup milk

Stir into the cream cheese mixture:

- 1 10-ounce package of frozen peas
- 2 cups cooked, thinly sliced chicken breast
- Salt and pepper to taste

At pause, drain liquid from mushrooms etc. Add cream cheese/peas/chicken mixture and stir together. Re-cover. Touch Start/Touch On.

3 At end, stir in 1 cup shredded Monterey Jack cheese.

Serve on top of baked potatoes or cooked pasta.

2. HAWAIIAN PORK

1 Place in 3-quart casserole:

- 1 tablespoon oil
- 1 pound boneless pork loin, cut into 1-inch strips, seasoned with salt and pepper

Stir well and cover. Touch 15 Minute Dinners, number 2 to select HAWAIIAN PORK and then touch Start/Touch On.

2 Combine well in a large bowl:

- 1 cup peach or apricot preserves
- 1/4 cup barbecue sauce
- 2 tablespoons soy sauce
- 2 tablespoons cornstarch
- 1 cup coarsely chopped onions

At pause, add preserves/barbecue sauce mixture and stir together well. Re-cover. Touch Start/Touch On.

3 At pause, add:

- 1 8-ounce can sliced water chestnuts, drained
- 1 green pepper, seeded and cut into 2-inch thin strips
- 1 red pepper, seeded and cut into 2-inch thin strips
- 1 20-ounce can pineapple chunks, drained

Stir to combine. Re-cover. Touch Start/Touch On.

4 At end, stir again.

Serve on cooked rice.

3. FIESTA CHILI

1 Place in 3-quart casserole:

1¹/₄ pounds ground turkey

1/2 cup diced onions

1/2 cup diced red pepper

Break up turkey and stir in onions and red pepper. Cover. Touch 15 Minute Dinners, number 3 to select FIESTA CHILI and then touch Start/Touch On.

2 At pause, drain and add to the casserole:

8 ounces chunky salsa

1 11-ounce can of Mexican corn, drained

1 15-ounce can chili with beans

1-3 teaspoons chili powder

Stir together well. Re-cover. Touch Start/Touch On.

3 At end, stir well.

Serve over cooked rice or nacho chips. Top with 2 cups shredded Monterey Jack or Cheddar cheese.

4. GLAZED SALMON

1 Combine:

1/4 cup orange juice concentrate

2 tablespoons honey mustard

1 tablespoon grated fresh ginger or 2 teaspoons ground ginger

Place in 7" x 11" glass casserole:

1¹/₂ pound salmon fillet

Drizzle 1/2 of the orange mixture over top of salmon. Cover with plastic wrap. Touch 15 Minute Dinners, number 4 to select GLAZED SALMON and then touch Start/Touch On.

2 At pause, place around edge of salmon:

3 cups broccoli florets

1 red pepper cut into thin strips

Drizzle remaining orange mixture over vegetables. Top all with 2 tablespoons toasted sesame seeds. Re-cover. Touch Start/Touch On.

3 At end, allow to stand, covered, for 3 to 5 minutes.

Serve with buttered rice, pasta or potatoes garnished with parsley.

5. HEALTHY FRITTATA

1 Grease 9" pie plate. Place in it:

- 1/2 pound mushrooms, sliced
- 3/4 cup chopped onion
- 1 tablespoon minced garlic
- 1/4 pound chopped low-fat smoked sausage

Cover with plastic wrap. Touch 15 Minute Dinners, number 5 to select HEALTHY FRITTATA and then touch Start/Touch On.

2 At pause, drain and set aside.

In a medium bowl, combine and stir together well:

- 3 large eggs
- 1/2 cup nonfat sour cream
- 1 tablespoon Dijon mustard
- 1/2 teaspoon salt
- 1/8 teaspoon pepper

Add and stir together:

- 1/2 10-ounce package frozen chopped spinach, thawed and squeezed dry
- 1 cup shredded Swiss cheese

Pour mixture in bowl over top of mushroom/onion/sausage mixture. Mix together carefully.

Do not cover. Press Start/Touch On.

3 At end, remove from microwave oven and allow to stand for 3 to 5 minutes.

Serve with tossed salad and sliced tomatoes for brunch.

Preset Recipes (Recipes serve 6)

1. BEEF WRAPS

1 Place in a 2-quart casserole:

- 1 pound ground beef

Break apart and cover. Touch Preset Recipes, number 1 to select BEEF WRAPS and then touch Start/Touch On.

2 At pause, drain fat and break ground beef into small pieces. Add to casserole:

- 1 10-ounce package frozen chopped spinach, thawed and drained
- 1 1/2 cups salsa
- 1-3 teaspoons chili powder

Stir together well. Re-cover. Touch Start/Touch On.

3 At end, stir well and place in 8 warmed corn tortillas. Top with 1 cup shredded Cheddar cheese.

2. MEXICAN CHICKEN

1 Place in layers in a 3-quart casserole:

- 2 cups instant rice
- 1 cup prepared fajita sauce mixed with $\frac{1}{2}$ cup chicken broth or bouillon
- 2 10-ounce packages frozen seasoning mix (onion, peppers, parsley and celery)
- 1 pound boneless chicken breast, cut into 1-inch thin strips

Cover. Touch Preset Recipes, number 2 to select MEXICAN CHICKEN and then touch Start/Touch On.

2 At pause, stir together being sure that chicken strips are separated and mixed into the rice/sauce. Re-cover. Press Start/Touch On.

3 At end, stir.

Serve with buttered green beans and toasted tortillas.

3. ITALIAN SALAD

1 To cook pasta: Place in 3-quart casserole:

- 6 cups very hot tap water

Cover. Touch Preset Recipes, number 3 to select ITALIAN SALAD and then touch Start/Touch On.

2 At pause, add:

- 8 ounces tricolored rotini or fusilli pasta
- 1 teaspoon salad oil

Do not cover. Touch Start/Touch On.

3 At end, drain pasta and set aside.

To cook chicken: Place in 9" pie plate:

- 1 pound boneless chicken breast, cut into 1-inch thin strips

Cover. Press Start/Touch On.

4 At pause, rearrange moving less done pieces to the outside of the pie plate.

Re-cover. Press Start/Touch On.

5 Drain and set aside.

To make salad: Place in large salad bowl:

- Cooked rotini or fusilli
- Cooked chicken breast
- 2 tomatoes, cut into eighths
- $\frac{1}{2}$ cup sliced black olives
- 1 cup mozzarella cheese, shredded
- $\frac{1}{4}$ cup red onion, chopped
- $\frac{3}{4}$ -1 cup oil-vinegar type dressing with pesto

Toss together to coat all pieces. Serve immediately or chill to serve later.

Ideal when served with warm crusty rolls.

4. TUNA MACARONI

1 To cook macaroni: Place in 3-quart casserole:

6 cups very hot tap water

Cover. Touch Preset Recipes, number 4 to select TUNA MACARONI and then touch **Start/Touch On**.

2 At pause, add:

2 cups elbow macaroni

1 teaspoon salad oil

Do not cover. Touch **Start/Touch On**.

3 At end, drain macaroni and set aside in the casserole.

Combine in bowl:

1 can cream of celery soup

1/2 cup milk

1/2 cup nonfat sour cream

Add to macaroni in casserole:

Soup/milk/sour cream mixture

1 6¹/₂-ounce can solid white water packed tuna fish, drained and flaked

1 cup frozen peas

1 cup shredded Cheddar cheese

Salt and pepper to taste

Stir together until well mixed. Cover. Touch **Start/Touch On**.

4 At end, stir again.

Serve with fresh carrot sticks, tossed salad and dinner rolls.

5. GARDEN MEDLEY

1 Place in 2¹/₂-quart casserole:

1 pound peeled baking potatoes, cut into eighths and thinly sliced

1 1⁴/₂-ounce can diced tomatoes

2 teaspoons minced garlic

1 teaspoon thyme leaves

Cover. Touch Preset Recipes, number 5 to select GARDEN MEDLEY and then touch **Start/Touch On**.

2 At pause, stir well and add:

1 16-ounce package frozen stir fry mixed vegetables

2 cups thinly sliced summer squash

Re-cover. Touch **Start/Touch On**.

3 At end, sprinkle top with 4 ounces shredded Cheddar cheese.

Serve with spinach salad and chilled melon.

DEFROST

Defrost automatically defrosts all the foods found in the Super Defrost and Auto Defrost Charts.

Super Defrost

Super Defrost rapidly defrosts specific foods and weights found in the Super Defrost Chart (number 1-3). For these choices, it is not necessary to enter weight.

- Suppose you want to defrost 1.0 pound boneless poultry.

PROCEDURE	DISPLAY			
1. Touch Defrost pad.	<table border="1"><tr><td>SEE LABEL</td><td>SELECT FOOD</td><td>NUMBER</td></tr></table>	SEE LABEL	SELECT FOOD	NUMBER
SEE LABEL	SELECT FOOD	NUMBER		
2. Touch the number pad 2 to select boneless poultry. Touch Start/Touch On pad.	<table border="1"><tr><td>1.0 POUND</td><td>BONELESS CHICKEN</td><td>PRESS START</td></tr></table>	1.0 POUND	BONELESS CHICKEN	PRESS START
1.0 POUND	BONELESS CHICKEN	PRESS START		
3. The microwave oven will stop so the food can be checked. The display will show: Touch Start/Touch On pad.	<table border="1"><tr><td>TURN OVER</td><td>SEPARATE INTO</td><td>PIECES</td></tr></table>	TURN OVER	SEPARATE INTO	PIECES
TURN OVER	SEPARATE INTO	PIECES		
4. After defrost cycle ends, follow the directions.	<table border="1"><tr><td>LET STAND</td><td>3-5 MINUTES</td></tr></table>	LET STAND	3-5 MINUTES	
LET STAND	3-5 MINUTES			

Note:

1. To defrost other foods above or below the weights allowed on the Super Defrost and Auto Defrost Charts, use time and 30% power. See Manual Defrost on page 10.
2. Any setting in the Defrost can be programmed with More or Less Time Adjustment. Touch the Power Level pad once or twice before touching Start/Touch On pad.
3. Touch Help pad when the HELP indicator is lighted in the display for a helpful hint.
4. If you attempt to enter more or less than the amount as indicated in the chart, an error message will appear in the display.

Super Defrost Chart

*It is not necessary to enter amount.

FOOD	AMOUNT	PROCEDURE
1. Ground Meat*	1.0 lb	At pause, turn over, removed any thawed pieces and break remainder apart. At end, let stand, covered, for 3 to 5 minutes.
2. Boneless Chicken*	1.0 lb	At pause, turn over and separate into pieces. At end, let stand, covered, for 3 to 5 minutes.
3. Bone-in Chicken Pieces*	2.0 lb	At pause, turn over and separate into pieces. At end, let stand, covered, for 3 to 5 minutes.

Note for Super Defrost:

Super Defrost provides just enough defrosting that the foods can be used in recipes or for cooking. There will be some ice crystals remaining.

Auto Defrost

- Suppose you want to defrost a 2.0 pound steak, using Auto Defrost.

PROCEDURE	DISPLAY
1. Touch Defrost pad.	SEE LABEL SELECT FOOD NUMBER
2. Select desired Defrost setting by touching the desired number pad. (Ex: Touch the number pad 5 to select steak.)	STEAKS CHOPS OR FISH ENTER WEIGHT IN POUNDS
Enter weight. (Ex: Touch number pads 2 and 0 for 2.0 lb.) Touch Start/Touch On pad.	2.0 POUNDS PRESS START
3. The microwave oven will stop so the food can be checked. The display will show:	TURN FOOD OVER COVER EDGES
4. After the 1st stage, open the door. Turn steak over and shield any warm portions. Close the door. Touch Start/Touch On.	
5. After the 2nd stage, open the door. Shield any warm portions. Close the door. Touch Start/Touch On.	CHECK FOOD COVER EDGES
6. After defrost cycle ends, follow the directions.	LET STAND COVERED

Auto Defrost Chart

FOOD	AMOUNT	PROCEDURE
4. Ground Meat	.5 - 3.0 lb	Remove any thawed pieces after each stage. Let stand, covered, for 5 to 10 minutes.
5. Steaks, Chops or fish	.5 - 4.0 lb	After each stage, rearrange and if there are warm or thawed portions, shield with small flat pieces of aluminum foil. Remove any meat or fish that is almost defrosted. Let stand, covered, for 10 to 20 minutes.
6. Chicken Pieces	.5 - 3.0 lb	After each stage, rearrange pieces or remove portions should they become warm or thawed. Let stand, covered, for 10 to 20 minutes.
7. Roast	2.0 - 4.0 lb	Start defrosting with fat side down. After each stage, turn roast over and shield the warm portions with aluminum foil. Let stand, covered, for 30 to 60 minutes.
8. Casserole or Soup	1 - 8 cups	After audible signal, stir if possible. At end, stir well and let stand, covered, for 5 to 10 minutes.

Note for Auto Defrost:

Check foods when microwave oven signals. After final stage, small sections may still be icy. Let stand to continue thawing. Do not defrost until all ice crystals are thawed.

Shielding prevents cooking from occurring before the center of the food is defrosted. Use small smooth strips of aluminum foil to cover edges and thinner sections of the food.

Beverages

Beverages enables you to reheat coffee or tea to a more suitable drinking temperature or to make instant coffee or tea.

- Suppose you want to reheat 2 cups of coffee.

PROCEDURE	DISPLAY						
1. Touch Beverages pad.	<table border="1"> <tr> <td>SEE LABEL</td> <td>SELECT FOOD</td> <td>NUMBER</td> </tr> </table>	SEE LABEL	SELECT FOOD	NUMBER			
SEE LABEL	SELECT FOOD	NUMBER					
2. Select desired Beverages setting by touching desired number pad. (Ex: Touch number 2 pad to reheat coffee.) Enter quantity by touching same number pad 2 repeatedly. (Ex: Touch number 2 pad 4 times.)	<table border="1"> <tr> <td>REHEAT</td> <td>CONTINUE</td> </tr> <tr> <td>PRESSING 2</td> <td>FOR CUPS</td> </tr> <tr> <td>2 CUPS</td> <td>PRESS START</td> </tr> </table>	REHEAT	CONTINUE	PRESSING 2	FOR CUPS	2 CUPS	PRESS START
REHEAT	CONTINUE						
PRESSING 2	FOR CUPS						
2 CUPS	PRESS START						
3. Touch Start/Touch On pad.							

Note:

1. Beverages can be programmed with More or Less Time Adjustment. Touch the Power Level pad once or twice after selecting the amount. See page 38.
2. Touch Help pad when the HELP indicator is lighted in the display, for a helpful hint.
3. More or less than the quantity listed in the chart should be made following the guidelines in any microwave book.

Beverages Chart

FOOD	AMOUNT	PROCEDURE
1. To Make Coffee or Tea	1 - 8 cups	Use this setting for heating COLD TAP WATER to a temperature somewhat below the boiling point to make instant coffee or tea. Touch number 1 pad for 1 cup increase per touch. Stir liquid briskly before and after heating to avoid "eruption".
2. To Reheat Beverage	.5 - 2.0 lb	This setting is good for restoring a cooled beverage to a better drinking temperature. Touch number 2 pad for a 0.5 cup increase per touch. Stir after heating.

Other Convenient Features

Warm/Hold

Warm/Hold allows you to keep food warm up to 30 minutes.

To use, simply touch the Warm/Hold pad and enter the appropriate time (up to 30 minutes). You can also program Warm/Hold with manual cooking to keep food warm continuously after cooking.

Direct Use

- Suppose you want to keep a cup of soup warm for 15 minutes.

1. Touch Warm/Hold pad.
2. Touch Start/Touch On pad.

The microwave oven will start automatically. The display will show **15.00** and count down. **KEEP WARM** will appear in the display every 10 seconds.

With Manual Cooking

- Suppose you want to cook a cup of soup for 2 minutes at 70% and keep the soup warm for 15 minutes.

1. Enter cooking time.
2. Touch Power Level pad 4 times for 70% power.
3. Touch Warm/Hold pad. Enter desired time.
4. Touch Start/Touch On pad.

The operation will start. When the cooking time is complete, a long tone will sound and Warm/Hold will start. **KEEP WARM** will appear in the display every 10 seconds.

Note:

1. To use Warm/Hold after previous cooking has ended, touch Warm/Hold pad within 3 minutes after cooking, closing the door or touching the Stop/Clear pad.
2. Warm/Hold cannot be programmed with **SENSOR OPTIONS** or **COOKING** features.

Multiple Sequence Cooking

Your microwave oven can be programmed for up to 4 automatic cooking sequences, switching from one power level setting to another automatically.

Sometimes cooking directions tell you to start on one power level and then change to a different power level. Your microwave oven can do this automatically.

- Suppose you want to cook roast beef for 5 minutes at 100% and then continue to cook for 30 minutes at 50%.

1. First enter cooking time. Then touch Power Level pad for 100% power.
2. Then enter second cooking time. Touch Power Level pad 6 times for 50% power.
3. Touch Start/Touch On pad.

Note:

1. If 100% is selected as the final sequence, it is not necessary to touch the Power Level pad.
2. If you wish to know power level, simply touch the Power Level pad. As long as your finger is touching the Power Level pad, the power level will be displayed.
3. Warm/Hold can be programmed continuously even if 4 cooking sequences have been set.

More or Less Time Adjustment

Should you discover that you like any of the SENSOR OPTIONS or COOKING (except for 15 Minute Dinners and Preset Recipes) settings slightly more done, touch the Power Level pad once before touching the Start/Touch On pad.

The display will show **MORE**.

Should you discover that you like any of the SENSOR OPTIONS or COOKING (except for 15 Minute Dinners and Preset Recipes) settings slightly less done, touch the Power Level pad twice before touching the Start/Touch On pad.

The display will show **LESS**.

Help (Control pad)

Help provides 5 features which make using your microwave oven easy because specific instructions are provided in the interactive display.

1. Child Lock

The Child Lock prevents unwanted microwave oven operation such as by small children. The microwave oven can be set so that the control panel is deactivated or locked. To set, touch Help, the number 1 and Start/Touch On pads. Should a pad be touched, **CHILD LOCK** will appear in the display.

To cancel, touch Help and Stop/Clear pads.

2. Audible Signal Elimination

If you wish to have the microwave oven operate with no audible signals, touch Help, the number 2 and Stop/Clear pads.

To cancel and restore the audible signal, touch Help, the number 2 and Start/Touch On pads.

3. Auto Start

If you wish to program your microwave oven to begin cooking automatically at a designated time of day, follow this procedure:

- Suppose you want to start cooking a stew for 20 minutes on 50% at 4:30. Before setting, check to make sure the clock is showing the correct time of day.
1. Touch Help pad.
 2. Touch number 3.
 3. To enter the start time at 4:30, touch numbers 4, 3 and 0.
 4. Touch Timer/Clock pad.
 5. To enter cooking program, touch numbers 2, 0, 0, and 0 for cooking time and then touch Power Level pad 6 times.
 6. Touch Start/Touch On pad.

Note:

1. Auto Start can be used for manual cooking if clock is set.
2. If the microwave oven door is opened after programming Auto Start, it is necessary to touch the Start/Touch On pad for Auto Start time to appear in the readout so that the microwave oven will automatically begin programmed cooking at the chosen Auto Start time.
3. Be sure to choose foods that can be left in the microwave oven safely until the Auto Start time. Acorn or butternut squash are often a good choice.
4. If you wish to know the time of day, simply touch the Clock pad. As long as your finger is touching the Clock pad, the time of day will be displayed.

4. Language / Weight Selection

The microwave oven comes set for English and U.S. Customary Unit-pounds. To change, touch Help and the number 4 pads. Continue to touch the number 4 pad until your choice is selected from the table below. Then, touch Start/Touch On pad.

Touch number 4 pad for language and standard of weight.

TOUCH NUMBER 4	LANGUAGE	STANDARD OF WEIGHT	DISPLAY	
Once	English	LBS	ENGLISH	LB
Twice	English	KG	ENGLISH	KG
3 times	Spanish	LBS	ESPAÑOL	LB
4 times	Spanish	KG	ESPAÑOL	KG
5 times	French	LBS	FRANCAIS	LB
6 times	French	KG	FRANCAIS	KG

5. Clock On/Off

If you wish to turn the clock display off, touch Help, the number 5 and Stop/Clear pads.

To cancel and restore the clock, touch Help, the number 5 and Start/Touch On pads.

Touch On

Touch On allows you to cook at 100% power by touching the Start/Touch On pad continuously. Touch On is ideal for melting cheese, bringing milk to just below boiling etc. The maximum cooking time is 3 minutes.

- Suppose you want to melt cheese on a piece of toast.
1. Continuously touch Start/Touch On pad. The cooking time will begin counting up.
 2. When the cheese is melted to desired degree, remove finger from Start/Touch On pad. Microwave oven stops immediately.

Note:

1. Note time it takes for frequently used foods and program that time in the future.
2. Touch Start/Touch On pad within 3 minutes after cooking, opening and closing the door or touching the Stop/Clear pad.
3. Touch On can only be used 3 times in a row. If more times are needed, open and close door or touch Stop/Clear pad.

Timer

- Suppose you want to time a 3-minute long distance phone call.

PROCEDURE	DISPLAY						
1. Touch Timer/Clock pad.	<table border="1"><tr><td>TO SET</td><td>KITCHEN TIMER</td><td>PRESS 1</td></tr><tr><td></td><td>TO SET CLOCK</td><td>PRESS 2</td></tr></table>	TO SET	KITCHEN TIMER	PRESS 1		TO SET CLOCK	PRESS 2
TO SET	KITCHEN TIMER	PRESS 1					
	TO SET CLOCK	PRESS 2					
2. Touch the number 1 pad.	<table border="1"><tr><td>ENTER TIME</td></tr></table>	ENTER TIME					
ENTER TIME							
3. Enter time. Touch Timer/Clock pad. The Timer will count down.	<table border="1"><tr><td>3.00 TIMER</td><td>PRESS TIMER</td></tr></table>	3.00 TIMER	PRESS TIMER				
3.00 TIMER	PRESS TIMER						
4. After the Timer cycle ends, the display will indicate the following message.	<table border="1"><tr><td>TIMER IS FINISHED</td></tr></table>	TIMER IS FINISHED					
TIMER IS FINISHED							

Note:

To cancel the Timer during programming, touch the Stop/Clear pad.

Help (Display indicator)

Each setting of SENSOR OPTIONS provides a cooking hint. If you wish to check, touch HELP pad whenever HELP is lighted in the Interactive Display for these hints.

Demonstration Mode

To demonstrate, touch Timer/Clock, the number 0 and then touch Start/Touch On pad and hold for 3 seconds. **DEMO ON DURING DEMO NO OVEN POWER** will appear in the display. Cooking operations and specific special features can now be demonstrated with no power in the microwave oven. For example, touch Add-A-Minute pad and the display will show **1.00** and count down quickly to **END**.

To cancel, touch Timer/Clock, then the number 0 and Stop/Clear pads. If easier, unplug the microwave oven from the electrical outlet and replug.

Add-A-Minute

Add-A-Minute allows you to cook for a minute at 100% by simply touching the Add-A-Minute pad. You can also extend cooking time in multiples of 1 minute by repeatedly touching the Add-A-Minute pad during manual cooking.

- Suppose you want to heat a cup of soup for one minute.

Touch Add-A-Minute pad.

Note:

1. To use Add-A-Minute, touch pad within 1 minute after cooking, closing the door, touching the Stop/Clear pad or during cooking.
2. Add-A-Minute cannot be used with SENSOR OPTIONS, COOKING or Warm/Hold.

Cleaning and Care

Disconnect the power cord before cleaning or leave the door open to inactivate the microwave oven during cleaning.

Exterior

The outside surface is painted. Clean the outside with mild soap and water; rinse and dry with a soft cloth. Do not use any type of household or abrasive cleaner.

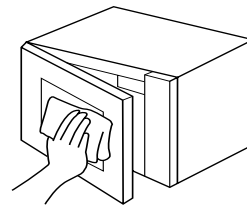

Door

Wipe the window on both sides with a damp cloth to remove any spills or spatters. Metal parts will be easier to maintain if wiped frequently with a damp cloth. Avoid the use of spray and other harsh cleaners as they may stain, streak or dull the door surface.

Touch Control Panel

Care should be taken in cleaning the touch control panel. If the control panel becomes soiled, open the microwave oven door before cleaning. Wipe the panel with a cloth dampened slightly with water only. Dry with a soft cloth. Do

not scrub or use any sort of chemical cleaners. Close door and touch Stop/Clear pad.

Interior

Cleaning is easy because little heat is generated to the interior surfaces; therefore, there is no baking and setting of spills or spattering. To clean the interior surfaces, wipe with a soft cloth and warm water. **DO NOT USE ABRASIVE OR HARSH CLEANERS OR SCOURING PADS.** For heavier soil, use baking soda or a mild soap; rinse thoroughly with hot water. **NEVER SPRAY OVEN CLEANERS DIRECTLY ONTO ANY PART OF THE MICROWAVE OVEN.**

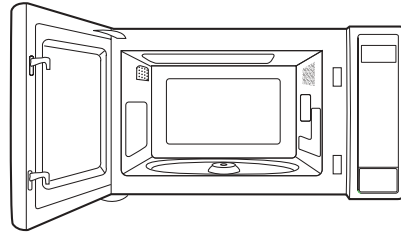

Waveguide Cover

The waveguide cover is made from mica so requires special care. Keep the waveguide cover clean to assure good microwave oven performance. Carefully wipe with a damp cloth any food spatters from the surface of the cover immediately after they occur. Built-up splashes may overheat and cause smoke or possibly catch fire. Do not remove the waveguide cover.

Odor Removal

Occasionally, a cooking odor may remain in the microwave oven. To remove, combine 1 cup water, grated peel and juice of 1 lemon and several whole cloves in a 2-cup glass measuring cup. Boil for several minutes using 100% power. Allow to set in microwave oven until cool. Wipe interior with a soft cloth.

Turntable/Turntable Support

The turntable and turntable support can be removed for easy cleaning. Wash them in mild, sudsy water; for stubborn stains use a mild cleanser and non abrasive scouring sponge. They are also dishwasher-safe. Use upper rack of dishwasher. The turntable motor shaft is not sealed, so excess water or spills should be wiped up immediately.

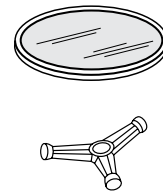

Specifications

DMOS200 / CDMOS200

AC Line Voltage:	Single phase 120V, 60Hz, AC only
AC Power Required:	1500 watts, 13.0 amps.
Output Power:	1100 watts*
Frequency:	2450 MHz
Outside Dimensions:	24" (W) x 13 ³ / ₈ " (H) x 19 ¹ / ₄ " (D)
Cavity Dimensions:	17 ³ / ₈ " (W) x 10 ¹ / ₂ " (H) x 18 ⁵ / ₈ " (D)
Microwave oven Capacity:	2.0 Cu. Ft. (56.6 Liters)
Cooking Uniformity:	Turntable system
Weight:	Approx. 46 lb (20.9 kg)

- ★ The International Electrotechnical Commission's standardized method for measuring output wattage. This test method is widely recognized.

In compliance with standards set by:

FCC – Federal Communications Commission Authorized.

DHHS – Complies with Department of Health and Human Services (DHHS) rule, CFR, Title 21, Chapter I, Subchapter J.

 – This symbol on the nameplate means the product is listed by Underwriters Laboratories, Inc. for use in USA or Canada.

Service Call Check

Please check the following before calling for service:

Place one cup of water in a glass measuring cup in the microwave oven and close the door securely.

Operate the microwave oven for one minute at HIGH 100%.

- A Does the microwave oven light come on? YES _____ NO _____
- B Does the cooling fan work? YES _____ NO _____
(Put your hand over the rear ventilating openings.)
- C Does the turntable rotate? YES _____ NO _____
(It is normal for the turntable to turn in either direction.)
- D Is the water in the microwave oven warm? YES _____ NO _____

If "NO" is the answer to any of the above questions, please check electrical outlet, fuse and/or circuit breaker. If they are functioning properly, CONTACT YOUR NEAREST VIKING AUTHORIZED SERVICER.

A microwave oven should never be serviced by a "do-it-yourself" repair person.

Note:

If time appearing in the display is counting down very rapidly, check Demonstration Mode on page 41 and cancel.

Microwave Oven Warranty

ONE YEAR FULL WARRANTY

Viking Microwave Oven and all of their component parts and accessories, except as detailed below*, are warranted to be free from defective materials or workmanship in normal household use for a period of twelve (12) months from the date of original retail purchase. Viking Range Corporation, warrantor, agrees to repair or replace, at its option, any part which fails or is found to be defective during the warranty period.

Glass (including light bulbs), painted and decorative items are warranted to be free from defective materials or workmanship for a period of ninety (90) days from the date of original retail purchase. ANY DEFECTS MUST BE REPORTED TO THE SELLING DEALER WITHIN NINETY (90) DAYS FROM DATE OF ORIGINAL RETAIL PURCHASE.

FIVE YEAR LIMITED WARRANTY

If the magnetron tube fails due to defective materials or workmanship in normal household use during the second through fifth year from the date of original retail purchase it will be repaired or replaced, free of charge for the part itself, with the owner paying all other costs, including labor.

This warranty extends to the original purchaser of the product warranted hereunder and to each transferee owner of the product during the term of the warranty.

This warranty shall apply to products purchased and located here in the United States and Canada. Products must be purchased in the country where service is requested. Warranty labor shall be performed by an authorized Viking Range Corporation service agency or representative. Warranty shall not apply to damage resulting from abuse, accident, natural disaster, loss of electrical power to the product for any reason, alteration, outdoor use, improper installation, improper operation or repair or service of the product by anyone other than an authorized Viking Range Corporation service agency or representative. This warranty does not apply to commercial usage. Warrantor is not responsible for consequential or incidental damage whether arising out of breach of warranty, breach of contract, or otherwise. Some jurisdictions do not allow the exclusion or limitation of incidental or consequential damages, so the above limitation or exclusion may not apply to you.

Owner shall be responsible for proper installation, providing normal care and maintenance, providing proof of purchase upon request, and making the appliance reasonably accessible for service. If the product or one of its component parts contains a defect or malfunction during the warranty period, after a reasonable number of attempts by the warrantor to remedy the defects or malfunctions, the owner is entitled to either a refund or replacement of the product or its component part or parts. Warrantor's liability on any claim of any kind, with respect to the goods or services covered hereunder, shall in no case exceed the price of the goods or service or part thereof which gives rise to the claim.

WARRANTY SERVICE: Under the terms of this warranty, service must be performed by a factory authorized Viking Range Corporation service agent or representative. Service will be provided during normal business hours, and labor performed at overtime or premium rates shall not be covered by this warranty. To obtain warranty service, contact the dealer from whom the product was purchased, an authorized Viking Range Corporation service agent, or Viking Range Corporation. Provide model and serial number and date of original purchase. For the name of your nearest authorized Viking Range Corporation service agency, call the dealer from whom the product was purchased or Viking Range Corporation. **IMPORTANT:** Retain proof of original purchase to establish warranty period.

The return of the Owner Registration Card is not a condition of warranty coverage. You should, however, return the Owner Registration Card so that Viking Range Corporation can contact you should any question or safety arise which could affect you.

Any implied warranties of merchantability and fitness applicable to the above described elements or parts are limited in duration to the period of coverage of the applicable express written limited warranties set forth above. Some jurisdictions do not allow limitations on how long an implied warranty lasts, so the above limitation may not apply to you. This warranty gives you specific legal rights, and you may also have other rights which may vary from jurisdiction to jurisdiction.

Viking Range Corporation
111 Front Street
Greenwood, Mississippi (MS) 38930 USA (888) 845-4641

Specifications subject to change without notice
For more product information, call 1-888-VIKING1 (845-4641)
or visit the Viking web site at <http://www.vikingrange.com>

Free Manuals Download Website

<http://myh66.com>

<http://usermanuals.us>

<http://www.somanuals.com>

<http://www.4manuals.cc>

<http://www.manual-lib.com>

<http://www.404manual.com>

<http://www.luxmanual.com>

<http://aubethermostatmanual.com>

Golf course search by state

<http://golfingnear.com>

Email search by domain

<http://emailbydomain.com>

Auto manuals search

<http://auto.somanuals.com>

TV manuals search

<http://tv.somanuals.com>