

VIKING

USE AND CARE MANUAL

F1220L

(MS0206VR)

Freestanding Gas Ranges

Congratulations . . .

Your purchase of this product attests to the importance you place upon the quality and performance of the major appliances you use. With minimal care, as outlined in this guide, this product is designed to provide you with years of dependable service. Please take the few minutes necessary to learn the proper and efficient use and care of this quality product.

We appreciate your choosing a Viking Range Corporation product, and hope that you will again select our products for your other major appliance needs.

Table of Contents

Warnings	3
Important Safety Instructions	4
Cooking Utensils	6
Before You Use Your New Range	6
Basic Functions of Your Oven	7
Using Your Range	9
Oven Operation	16
Cleaning and Maintenance	29
Power Failure	34
Service Information	35
Warranty	Rear Cover



WARNING

- THIS RANGE CAN TIP
- INJURY TO PERSONS COULD RESULT
- INSTALL ANTI-TIP DEVICE PACKED WITH RANGE
- SEE INSTALLATION INSTRUCTIONS

WARNING

If the information in this manual is not followed exactly, a fire or explosion may result causing property damage, personal injury or death.

-Do not store or use gasoline or other flammable vapors and liquids in the vicinity of this or any other appliance.

WHAT TO DO IF YOU SMELL GAS

- Do not try to light any appliance
- Do not touch any electrical switch; do not use any phone in your building.
- Immediately call your gas supplier from a neighbor's phone. Follow the gas supplier's instructions.
- If you cannot reach your gas supplier, call the fire department.
- Installation and service must be performed by a qualified installer, service agency, or the gas supplier.

WARNING

1. Read all instructions before using the product.
2. Install or locate the product only in accordance with the provided Installation Instructions.

WARNING

NEVER use this appliance as a space heater to heat or to warm the room. Doing so may result in carbon monoxide poisoning and overheating of the oven.

WARNING

NEVER cover any slots, holes or passages in the oven bottom or cover an entire rack with materials such as aluminum foil. Doing so blocks air flow through the oven and may cause carbon monoxide poisoning. Aluminum foil linings may also trap heat, causing a fire hazard. This is based on safety considerations.

Important Safety Instructions

WARNING

To reduce the risk of fire, electrical shock, injury to persons, or damage when using the oven, follow basic precautions, including the following:

1. Your unit should be installed by a qualified technician. The appliance must be installed and electrically grounded according to local codes. Have this technician show the the location of the gas shut-off valve on the range so you know where and how to turn off the gas if necessary. **IN MASSACHUSETTS: All gas products must be installed by a "Massachusetts" licensed plumber or gasfitter.**
2. Do not attempt to repair or replace any part of this appliance unless specifically recommended in this manual. All servicing should be referred to a qualified technician. A qualified technician is required for any adjustments or conversions to Nat. or LP gas.
3. The "push-to-turn" knobs of this range are designed to be child-safe. However, children should not be left alone in the kitchen while the range is in use. Do not store items of interest to children over the unit. **CAUTION:** Children climbing to reach items could be seriously injured.
4. GREASE is flammable and should be handled carefully. Do not use water on grease fires. Never pick up a flaming pan. Smother flaming pan by covering utensil completely with well-fitting lid, cookie sheet or flat tray. Flaming grease outside of utensil can be extinguished with baking soda or, if available, a multipurpose dry chemical or foam type extinguisher.
5. Never leave the surface area unattended at high heat setting. Boil-overs cause smoking and greasy spill-overs which may ignite.
6. If you are "flaming" liquor or other spirits under an exhaust, **TURN THE FAN OFF.** The draft could cause the flames to spread out of control.
7. Wear proper apparel. Loose-fitting or hanging garments should never be worn while using the appliance.
8. Never use your range for warming or heating a room. This is based on safety considerations.
9. Use proper pan size. Select utensils having flat bottoms large enough to cover the burner. Using undersized utensils allows the flame to come up the side of the utensil, scorching the outside of the utensil and making cleanup harder.

10. The flame of the open-top burner should be adjusted to just cover the bottom of the pan or pot. Excessive burner setting may cause scorching of adjacent countertop surfaces, as well as the outside of the utensil. This is based on safety considerations.
11. Use dry pot holders. Moist or damp pot holders on hot surfaces may result in burns from steam. Do not let potholder touch hot surface areas. Do not use a towel or other bulky cloth.
12. To reduce the risk of burns, ignition of flammable materials, and spillage due to unintentional contact with the utensil, the handle of a utensil should be positioned so that it is turned inward toward the center of the range, and so that it does not extend over adjacent burners.
13. Surface areas near burners may become hot enough to cause burns. During and after use, do not touch areas near burners until they have had sufficient time to cool.
14. No oven liner protection coating such as aluminum foil should be used in or around any part of the oven. Improper oven liners may result in a risk of electric shock or fire. Keep oven free from grease build-up.
15. Once the unit is installed as outlined in the Installation Instructions, it is important that the fresh air supply is not obstructed. Ensure that the kitchen is well-ventilated. Keep natural venting holes open or install a mechanical ventilation device. Prolonged or intensive use of the appliance may call for additional (such as opening a window) or more effective ventilation (such as increasing the level of a mechanical ventilation if present).
16. The flueway must also remain clear.
17. Storage cabinet area above the unit must be 36" (91.4 cm) and cannot project more than 13" (33.0 cm) outward from the rear wall. Beware of potential hazards associated with retrieving items from such cabinets when the unit is in operation.
18. Keep area clean and free from combustible material, gasoline, and other flammable liquids.
19. Do not heat unopened food containers; buildup of pressure may cause the container to explode and result in injury.

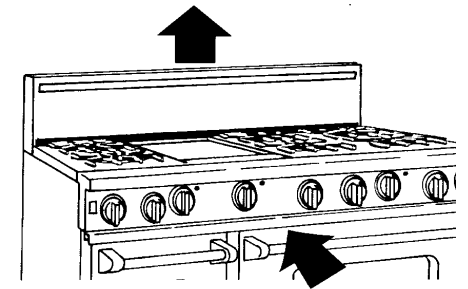

20. This appliance is not connected to a combustion products evacuation device. It shall be installed and connected in accordance with current installation regulations giving particular attention to the relevant requirements regarding ventilation.
21. No attempt should be made to operate the appliance during power outage.
22. A risk of tip-over may result if the appliance is not installed in accordance with installation instructions including excessive loading of the oven door or from abnormal usage.
23. Do not attempt to operate the appliance during power failure.
24. Never sit, step, stand, or lean on any part of the oven, or injury may result.
25. Use care when opening oven door. Let hot air or steam escape before removing or replacing food.

Cooking Utensils

Each cook has his or her own preference for the particular cooking utensils that are most appropriate for the type cooking being done. Any and all cooking utensils are suitable for use in the range and it is not necessary to replace your present domestic utensils with commercial cookware. This a matter of personal choice. As with any cookware, yours should be in good condition and free from excessive dents on the bottom to provide maximum performance and convenience. **NOTE: WHEN USING BIG POTS AND/OR HIGH FLAMES, IT IS RECOMMENDED TO USE THE FRONT BURNERS. THERE IS MORE ROOM IN THE FRONT AND POTENTIAL CLEANUP OF REAR OR APPLIANCE DUE TO STAINING OR DISCOLORATION WILL BE MINIMIZED.**

Before You Use Your New Range

All products are wiped clean with solvents at the factory to remove any visible signs of dirt, oil, and grease which may have remained from the manufacturing process. Before starting to cook, clean the range thoroughly with hot, soapy water.

Steel Griddle/Simmer Plate (If applicable)

The griddle is a heavy-weight, polished steel griddle that has a USDA authorized protective coating. Before using, remove protective coating using a Scotch Brite® soft scour pad. It is very important to season the griddle by coating lightly with cooking oil.

Grill (If applicable)

The grates should be removed and washed in hot soapy water, rinsed and then replaced prior to use. Other grill parts should be removed, dusted, and replaced making sure that no flammable materials have been accidentally placed in the grill.

Wok Pan w/Lid (If applicable)

Remove all packaging materials and temporary labels from the wok. Clean thoroughly with hot soapy water and dry thoroughly. Apply a light coat of vegetable oil (do not use corn oil) to the entire inside surface with a paper towel. Heat the wok on medium setting until the cooking surface turns golden brown. Repeat this procedure several times. This seasoning seals the pores of the metal, keeps food from sticking, and prevents the wok from rusting. Wipe off excess oil before using or storing.

Drip Tray/Pan

The drip tray should be pulled out and checked for flammable materials. Make sure to unwrap the drip pan and replace it in its proper place under the griddle or grill (if applicable).

Oven

Before first use, wipe interior with soapy water and dry thoroughly.

Basic Functions of Your Oven

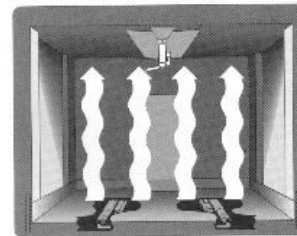

NATURAL AIRFLOW BAKE

Heat is radiated from the two bake burners in the bottom of the oven cavity and is circulated with natural airflow. This is your traditional bake setting

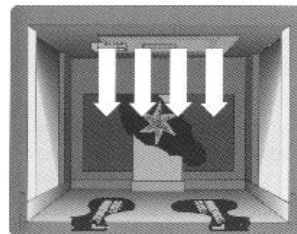

INFRARED BROIL

The broil burner at the top of the oven heats the metal screen until it glows. The glowing screen produces the infrared heat, searing the outside of broiled foods and sealing in juices.

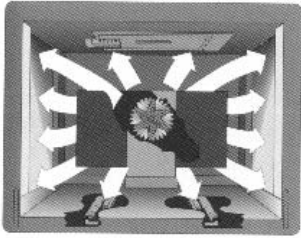

CONVECTION BAKE

Heat is radiated from the bake burners in the bottom of the oven cavity and is circulated by the motorized fan in the rear of the oven. It provides more even heat distribution throughout the oven cavity for all uses. Multiple rack use is possible for the largest baking job. When roasting, cool air is quickly replaced - searing meats on the outside and retaining more juices and natural flavor on the inside with less shrinkage.

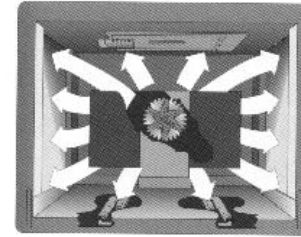

CONVECTION DEFROST

With temperature control off, air is circulated by a motorized fan in the rear of the oven. The fan accelerates natural defrosting of the food without heat. To avoid sickness and food waste, do not allow defrosted food to remain in the oven for more than two hours.

Using Your Range

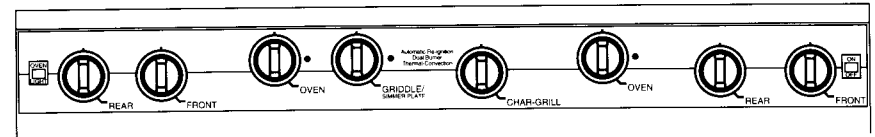

Lighting the Burners

Surface Burners-Automatic Reignition

To light the surface burners, turn the appropriate control knob counter clockwise to any position. This control is both a gas valve and an electric switch. Burners will ignite at any "on" position with the automatic reignition system. If the flame goes out for any reason, the burners will automatically reignite if the gas is still flowing. When gas is permitted to flow to the burners, the electric igniters start sparking. On all surface igniters you should hear a "clicking" sound. If you do not, turn off the control and check that the unit is plugged in and that the fuse or circuit breaker is not blown or tripped.

Within a few moments, enough gas will have traveled to the burner to be able to light. When the burner lights, turn the burner control to any position to adjust the flame size.

Setting the proper height for the desired cooking process and selected utensil will result in superior cooking performance, while also saving time and energy.

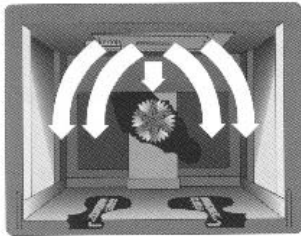
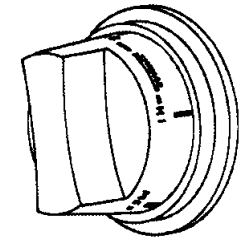

INFRARED CONVECTION BROIL

Exactly the same as regular broiling with the additional benefit of air circulation by the motorized fan in the rear of the oven. The cool air is quickly replaced-improving the already high performance of the infrared broil burner.

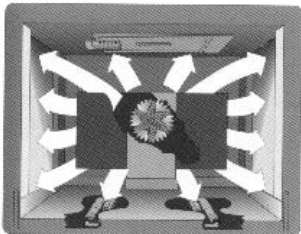

CONVECTION DEHYDRATE

With the temperature control on 175°F, warm air is radiated from the bake burners in the bottom of the oven cavity and is circulated by a motorized fan in the rear of the oven. Over a period of time, the water is removed from the food by evaporation. Removal of water inhibits growth of microorganisms and retards the activity of enzymes. It is important to remember that dehydration does not improve the quality, so only fresh, top-quality foods should be used.

Surface Cooking Tips

- Use low or medium flame heights when cooking in utensils that are poor conductors of heat, such as glass, ceramic, and cast-iron. Reduce the flame height until it covers approximately 1/3 of the utensil diameter. This will ensure more even heating within the utensil and reduce the likelihood of burning or scorching the food.
- Reduce the flame if it is extending beyond the bottom of the utensil. A flame that extends along the sides of the utensil is potentially dangerous, heats the utensil handle and kitchen instead of the food, and wastes energy.
- Reduce the flame height to the minimum level necessary to perform the desired cooking process. Remember that food cooks just as quickly at a gentle boil as it does at a rolling boil. Maintaining a higher boil than is necessary wastes energy, cooks away moisture, and causes a loss in food flavor and nutrient level.

TEMPERATURE SETTING GUIDELINES*

HEAT SETTING	USE
Simmer	Melting small quantities. Steaming rice.
HI-Simmer	Simmering small quantities, sauces.
Low	Melting large quantities
Low - Med	Low-temperature frying. (eggs, etc.) Simmering large quantities Heating milk, cream sauces, gravies, puddings.
Med	Sauteing and browning Braising, pan-frying Maintaining slow boil on large quantities.
Med-HI	High-temperature frying. Pan broiling Maintaining fast boil on large quantities
HI	Boiling water quickly. Deep-fat frying in large utensil

*NOTE: The above information is given as guide only. You may need to vary the heat settings to suit your personal requirements.

Griddle/Simmer Plate, Bake Burner, Infrared Burner

Turning the thermostat counter clockwise to any "on" position activates a glo-bar igniter and opens an electromechanical valve in the system to start the gas valve. The griddle has a power "ON" light which glows when the griddle thermostat is turned on. The light cycles on and off with the burner. It is not possible to use both the infrared burner and the bake burners at the same time. The design of the system will not permit this, both for control of bake/broiler and for safety of use.

Griddle/Simmer Plate Operation

- Turn the griddle control knob to desired temperature setting.
- Always turn off when not in use, or lower the heat between cooking loads.

Cooking Tips

- Preheat griddle at the desired temperature. Wait until light cycles off for indication that the desired temperature has been reached and the griddle is preheated.
- Use liquid cooking oil, cooking sprays, or butter for eggs, pancakes, French toast, fish and sandwiches. This will help to reduce sticking. Meats usually have enough natural oils.
- Remove food particles with a metal spatula during cooking to make the cleanup easier and to avoid including those particles in the food.
- Do not overheat the griddle. Turn it off when not in use, or lower heat between cooking loads.
- After using and cleaning the griddle, the surface should be wiped with a light film of cooking oil to protect the finish from rust and corrosion.

Griddle Cooking Chart

Food	°F	°C
Eggs	250-300	121-149
Bacon	325-300	163-177
Pancakes	375-400	191-177
French Toast	400	205
Fish Fillets	300	149
Hamburger	350	177
Steaks	350	177

Wok Operation (If applicable)

Using the Trivet Grate (Center Wok Grate)

The trivet grate converts the large burner grate to a grate suitable for use with large stock pots. To use the trivet grate, place the small grate in the center of the large grate. Turn the trivet grate until the feet on the trivet grate rests inside the notches located on the center ring of the large grate.

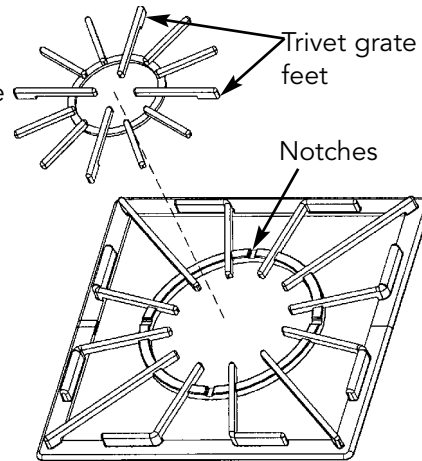

Grill Operation

- Turn on ventilator (separate product).
- Turn control knob to HI.
- Preheat on HI for 5 to 10 minutes.
- Place food on grill, cook as desired.

Grill Cooking Tips

- When grilling chicken, roasts, well done steaks or chops and thick pieces of meat, sear on HI. Then, reduce the heat setting to prevent excessive flare-up. This will allow the food to cook through without burning the outside.
- After steaks, chops, or hamburgers have been allowed to sear for approximately 1 minute, you may slide a spatula under the meat and turn it approximately 90° so that a waffle pattern will be seared onto the food.
- Use a metal spatula instead of tongs or a fork to turn the meat. A spatula will not puncture the meat allowing juices to escape.
- Turn the meat over only once. Juices are lost when steaks, chops or hamburgers are turned several times. The best time to turn the meat is after the juices have begun to bubble to the surface.
- To test for doneness, make a small slash in the center of the meat, not the edge. This will prevent loss of juices.
- Occasionally there may be flare-ups or flames above the grill due to drops of fat falling onto the flame spreader. It is normal to have some flare-up during grilling. Use a long handled spatula to move food to another area until the flames subside.

Grill Cooking Chart

FOOD	WEIGHT OR THICKNESS	FLAME SIZE	TOTAL SUGGESTED COOKING TIME	SPECIAL INSTRUCTIONS AND TIPS
Beef Hamburger	1/2-3/4" (1.3-1.9cm)	Med	8-15 minutes	Grill, turning once when juices rise to the surface. We recommend that ground chuck be used for hamburgers, as it will give you a juicer hamburger than ground round. Do not leave hamburgers unattended since a flare-up could occur quickly.
Steaks Rib, Club, Porterhouse, T-Bone Sirloin	Rare (140°F/60°C)	1"(2.5 cm) 1 1/2" (3.8 cm)	High High	Remove excess fat from edge. Slash remaining fat at 2" (5.1 cm) intervals to keep edges from curling. Grill, turning once.
	Medium (160°F/71°C)	1"(2.5 cm) 1 1/2" (3.8 cm)	Med to High	
	Well-done (170°F/77°C)	1"(2.5 cm) 1 1/2" (3.8 cm)	Med to High	
	Tenderloin	5 pounds (2.3 kg)	High	

Grill Cooking Chart

FOOD	WEIGHT OR THICKNESS	FLAME SIZE	TOTAL SUGGESTED COOKING TIME	SPECIAL INSTRUCTIONS AND TIPS
MEATS Pork Chops	1/2" (1.3 cm)	Med	20-40 minutes	Remove excess fat from edge. Slash remaining fat at two-inch intervals to keep edges from curling. Grill, turning once, and moving if necessary. Cook well done.
	1" (2.5cm)	Med	35-60 minutes	
		Med	45-60 minutes	
		Med	45-60 minutes	
Ribs		Med	45-60 minutes	Grill, turning occasionally. During the last few minutes, brush with barbeque sauce, turning several times.
Ham Steaks (fully cooked)	1/2" (1.3 cm)	High	12-15 minutes	Remove excess fat from edge. Slash remaining fat at two-inch intervals. Grill, turning once.
Hot Dogs		Med	5-10 minutes	Slit skin before cooking. Grill, turning once.
POULTRY Chicken Broiler/Fryer Halves or Quarters	2-3 pounds (.9-1.4 kg)	Low or Med	1-1 1/2 hours	Place skin side up. Grill, turn, and brush frequently with melted butter, margarine, oil, or marinade.
			40-60 minutes	
FISH AND SEAFOOD	3/4"-1" (1.9-2.5 cm)	Med to High	8-15 minutes	Grill, turning once; brush with melted butter, margarine, or oil to keep fish moist.
			12-20 minutes	
Whole Catfish Trout	4-8 ounces (113-227g)	Med to High		(Same as for steaks)

Cooking Substitute Charts

In many cases, a recipe requires an ingredient which is not readily available or calls for a unit of measure that is not easily recognized. The following charts have been provided as useful guides in these situations.

Ingredient Substitutes	
Recipe calls for:	Use:
1 Tbsp. Cornstarch	2 Tbsp. flour (thickening)
1 whole egg	2 egg yolks plus 1 Tbsp. water
1 c. whole milk	1 c. skim milk plus 2 Tbsp. margarine or 1/2 c. evaporated milk plus 1/2 c. water
1 oz unsweetened chocolate	3 Tbsp. cocoa powder plus 1 Tbsp. margarine
1 Tbsp. baking powder	1/2 tsp. cream of tartar plus 1/4 tsp. baking soda
1/2 c. butter	7 Tbsp. margarine or shortening
1 c. dairy sour cream	1 Tbsp. lemon juice plus 1 c. evaporated milk

Canned Food Sizes			
Sizes	Contents	Sizes	Contents
8 oz	1 cup	No. 303	2 cups
Picnic	1 3/4 cups	No. 2	2 1/2 cups
No. 300	1 3/4 cups	No. 3	4 cups
No. 1 tall	2 cups	No. 10	12 cups

Kitchen Equivalents and Metrics

<u>Measure</u>	<u>Equivalent</u>	<u>Metric*</u>
1 tablespoon	3 teaspoons	15 mL
2 tablespoons	1 ounce	30 mL
1 jigger	1 1/2 ounces	45 mL
1/4 cup	4 tablespoons	60 mL
1/3 cup	5 tbsp. plus 1 tsp.	80 mL
1/2 cup	8 tablespoons	125 mL
1 cup	16 tablespoons	250 mL
1 pint	2 cups	30 grams
1 pound	16 ounces	454 grams
2.21 pounds	35.3 ounces	1 kilogram

*Rounded for easier measuring

Oven Operation

Temperature Controls

Each oven has a temperature control dial. The control can be set at any temperature from 150°F to 550°F, or broil. Always be sure the controls are in the "Off" position when the oven is not in use.

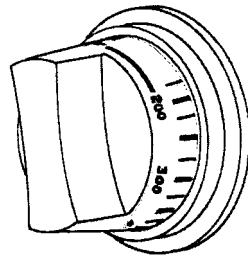

Natural Airflow Baking/ Convection Baking

Preheating

Preheating the oven is not necessary when using temperatures below 250°F. For best results, it is extremely important that you preheat the oven when baking cakes and other items that have critical baking temperatures. After the temperature control has been set, the Oven Indicator light goes out when the oven reaches that temperature. Preheating takes no longer than 10-15 minutes.

Natural Airflow Baking

This conventional baking/roasting is particularly suitable for dishes which require a high temperature. Many cookbooks contain recipes to be cooked in the conventional manner. This type of baking is only recommended for single-rack baking.

Convection Baking

For all convection functions, the convection fan switch on the right side of the control panel must be turned "ON".

Convection baking is the process of cooking food with a flow of heated air circulating throughout the oven cavity. The even circulating of this air equalizes the temperature throughout the oven cavity and eliminates the hot and cold spots found in conventional ovens. This feature can make a significant difference in foods prepared in the oven. A major benefit of convection baking is the ability to prepare food in quantity. The uniform air circulation makes this possible . . . a feature not possible in a standard oven. With this heating system, the air is distributed evenly throughout the oven by the hot air fan. The heat therefore reaches the food to be baked or roasted more quickly. With this heating method, foods can be baked and roasted at the same time with minimal taste transfer, even when different dishes are involved, such as cakes, fish, or meat. The hot air system is especially economical when thawing frozen food.

Rack Positions

Each convection oven is equipped with three tilt-proof racks, and each convectional oven is equipped with two-tilt proof racks. All ranges have five rack positions and the 24" deep models have an additional 6th rack position. Position 5 or 6 (depending on the model) is the farthest from the oven bottom. Position 1 is the closest to the oven bottom. The racks can be easily removed and arranged at various levels. For best results with conventional baking, do not use more than one rack at a time. It is also recommended when using two racks, to bake with the racks on position 4 and 2.

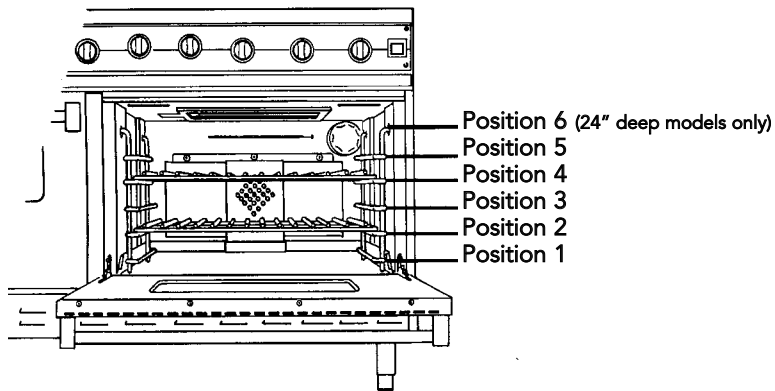

To Bake:

1. Arrange the oven racks in the desired position BEFORE heating the oven. If cooking on two racks at the same time, use rack positions 2 and 4.
2. Set the Temperature Control to the desired temperature.
3. Place the food in the oven after the Oven Indicator light goes out.

Pan Placement Tips

- When using large (15" x 13" [38 cm x 33 cm]) flat pans or trays that cover most of the rack, rack positions 2 or 3 produce the best results.
- Stagger pans in opposite directions when two racks and several pans are used. No pan should be directly above another.
- Allow 1 1/2" to 2" (3.8 cm to 5.1 cm) of air space around all sides of each pan for even air circulation.
- When baking on more than one rack, it is recommended to use the 2nd and 4th position for more consistent even baking.

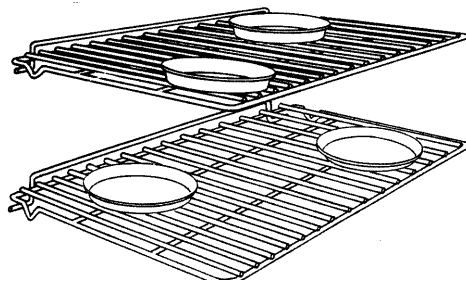

Baking Tips

- As a general rule, to convert conventional recipes to convection recipes, reduce the temperature by 25°F and the cooking time by approximately 10 to 15%.
- Some recipes, especially those that are homemade, may require adjustment and testing when converting from standard to convection modes. If unsure how to convert a recipe, begin by preparing the recipe in conventional bake. After achieving acceptable results, follow the convection guidelines listed for the similar food type. If the food is not prepared to your satisfaction during the first convection trial, adjust only one recipe variable at a time (cooking time, rack position, or temperature) and repeat the convection test. Continue adjusting one recipe variable at a time until satisfactory results are achieved.
- Make sure the oven racks are in the desired positions before you turn the oven on.
- For best results, always preheat the oven.
- Do not open the oven door frequently during baking. If you must open the door, the best time is during the last quarter of the baking time.
- Bake to shortest time suggested and check for doneness before adding more time. For baked goods, a stainless steel knife placed in the center of the product should come clean when done.
- Use good quality baking pans and sizes recommended in the recipe; warped, dented, or burned pans should not be used.
- Shiny metal pans are preferred for baking items such as cakes, cookies, and muffins because they produce light, golden crusts due to heat being reflected by the metal.
- Glass pans may also be used for cake baking. Reduce the oven temperature by 25 degrees when using a glass pan, but bake for the same amount of time called for in the recipe.
- Pies are best baked in pans which absorb and hold heat. Glass, enamel, dull-finished metal, and porcelain enamel finish give pies a golden brown crust.

Conventional Baking Chart

	Recommended Pan	Conventional Temperature		Conventional Time (min.)
		(°F)	(°C)	
BREADS				
Yeast Loaf	Loaf Pan	375	191	30-35
Yeast Rolls	Cookie Sheet	400	204	12-15
Biscuits	Cookie Sheet	400	204	8-10
Nut Breads	Loaf Pan	375	191	30-35
Cornbread	8"x8" (20x20 cm)	400	204	25-30
Corn Muffins	Muffin Tin	375	191	15-20
Fruit Muffins	Muffin Tin	375	191	15-20
CAKES/COOKIES				
Angelfood	Tube Pan	375	191	35-45
Bundt	Tube Pan	350	177	45-50
Cupcakes	Muffin tin	350	177	16-20
Layer, Sheet	13"x9" (23x33 cm)	350	177	40-50
Layer, Two	9" (23 cm) round	350	177	30-35
Pound	Loaf Pan	350	177	60-65
Brownies	13"x9" (23x33 cm)	350	177	25-30
Choc. Chip	Cookie Sheet	375	191	12-15
Sugar Cookies	Cookie Sheet	350	177	10-12
PIES/PASTRY				
Pie Crust	9" (23 cm) round	425	218	10-12
Two Crust, Fruit	9" (23 cm) round	375	191	55-60
Pumpkin Pie	9" (23 cm) round	375	191	40-45
Custard	6 - 4 oz cups	350	177	35-40
Cream Puffs	Cookie Sheet	400	204	30-35
MISCELLANEOUS				
Baked Potatoes	(4) 8 oz (227 gm)	375	191	60-75
Lasagna	9"x5" (23x13 cm)	375	191	55-60
Cheese Souffle	1 qt. (.95 L)	350	177	45-50
Stuffed Peppers	13"x9" (23x33 cm)	375	191	60-70
Quiche	9" (23 cm) round	400	204	25-30

Convection Baking Chart

	Recommended Pan	Convection Temperature		Convection Time (min.)
		(°F)	(°C)	
BREADS				
Yeast Loaf	Loaf Pan	350	177	25-35
Yeast Rolls	Cookie Sheet	375	191	11-13
Biscuits	Cookie Sheet	375	191	7-9
Nut Breads	Loaf Pan	350	177	20-25
Cornbread	8"x8" (20x20 cm)	375	191	15-20
Corn Muffins	Muffin Tin	350	177	10-12
Fruit Muffins	Muffin Tin	350	177	12-15
CAKES/COOKIES				
Angelfood	Tube Pan	350	177	30-35
Bundt	Tube Pan	325	163	35-40
Cupcakes	Muffin tin	350	177	15-17
Layer, Sheet	13"x9" (23x33 cm)	325	163	30-35
Layer, Two	9" (23 cm) round	325	163	25-30
Pound	Loaf Pan	325	163	45-50
Brownies	13"x9" (23x33 cm)	325	163	20-25
Choc. Chip	Cookie Sheet	350	177	9-10
Sugar Cookies	Cookie Sheet	325	163	7-10
PIES/PASTRY				
Pie Crust	9" (23 cm) round	400	204	7-9
Two Crust, Fruit	9" (23 cm) round	350	177	50-55
Pumpkin Pie	9" (23 cm) round	350	177	35-40
Custard	6 - 4 oz cups	Not Recommended		
Cream Puffs	Cookie Sheet	375	191	25-27
MISCELLANEOUS				
Baked Potatoes	(4) 8 oz (227 gm)	350	177	50-55
Lasagna	9"x5" (23x13 cm)	350	177	45-50
Cheese Souffle	1 qt. (.95 L)	325	163	35-40
Stuffed Peppers	13"x9" (23x33 cm)	350	177	45-50
Quiche	9" (23 cm) round	Not Recommended		

Solving Baking Problems

Baking problems can occur for many reasons. Check the chart for the causes and remedies for the most common problems. It is important to remember that the temperature setting and cooking times you are accustomed to using with your previous oven may vary slightly from those required with this oven. If you find this to be true, it is necessary for you to adjust your recipes and cooking times accordingly.

BAKING PROBLEM REMEDIES		
PROBLEM	CAUSE	REMEDY
Food browns unevenly	Improper heating Aluminum foil on rack or oven bottom Baking utensils too large for the recipe or oven. Several utensils crowded together	Preheat until oven indicator light goes out. Remove foil. Use correct size utensil. Leave at least 1 1/2" (3.8 cm) or more space between all utensils and oven walls.
Food too brown on bottom	Baking utensil too large Baking utensil dark or glass	Use correct utensil Lower oven temperature 25°F (-3.8 °C) for this type of utensil.
Food dries before browning	Oven temperature too high Oven door opened too frequently	Lower oven temperature Check food at minimum time.
Cookies too brown on bottom	Pans too deep Dark cookie sheet Oven temperature too high	Use a cookie sheet (not a baking pan). Use light, shiny cookie sheet. Lower oven temperature
Cookies too flat	Hot cookie sheet	Allow cookie sheet to cool between batches.
Cake too brown on bottom or crust forms on bottom	Oven temperature too high	Lower temperature; if using glass pan, lower 25°F (-3.8 °C)
Cakes burns on sides or not done in center than	Oven too hot Wrong pan size	Reduce temperature. Use recommended pan size; fill pan no more 2/3 full.

Conventional/Convection Roasting Tips

Always use the broiler pan and grid supplied with each oven. The hot air must be allowed to circulate around the item being roasted. Do not cover what is being roasted. Convection roasting seals in juices quickly for a moist, tender product. Poultry will have a light, crispy skin, and meats will be browned, not dry or burned. Cook meats and poultry directly from the refrigerator. There is no need for meat or poultry to stand at room temperature.

- Always roast meats fat side up. No basting is required when the fat side is up. Do not add water to the pan, as this will cause a steamed effect. Roasting is a dry-heat process.
- Poultry should be placed breast side up on the grid in the broiler pan. Brush poultry with melted butter, margarine, or oil before and during roasting.
- For convection roasting, do not use pans with tall sides, as this will interfere with the circulation of heated air over the food.
- If using a cooking bag, foil tent, or other cover, use conventional baking rather than convection.
- When using a meat thermometer, insert the probe halfway into the center of the thickest portion of the meat. (For poultry, insert the thermometer probe between the body and leg into the thickest part of the inner thigh.) The tip of the probe should not touch bone, fat, or gristle to ensure an accurate reading. Check the meat thermometer 2/3 of the way through the recommended roasting time. After reading the thermometer once, insert it 1/2" (1.3 cm) further into the meat, then take a second reading. If the second reading registers below the first, continue cooking the meat.
- Roasting times always vary according to the size, shape, and quality of meats and poultry. Less tender cuts of meat are best prepared in the conventional bake setting and may require moist cooking techniques. Remove roasted meats from the oven when the thermometer registers 5°F to 10°F (-15°C to -12°C) lower than the desired doneness. The meat will continue to cook after removal from the oven. Allow roasts to stand 15 to 20 minutes after roasting in order to make carving easier.

Conventional Roasting Chart

Type and Cut of Meat	Weight (lbs)	Conventional Temperature		Conventional Time (min./lb.)	Internal Temperature	
		(°F)	(°C)		(°F)	(°C)
BEEF						
Rib Roast	4 - 6	325	163			
•Rare				25	140	60
•Medium				30	155	68
•Well Done				40	170	77
Rump Roast	4 - 6	325	163			
•Medium				25	155	68
•Well Done				30	170	77
Tip Roast	3 - 4	325	163			
•Medium				35	155	68
•Well Done				40	170	77
LAMB						
Leg of Lamb	3 - 5	325	163	30	180	82
PORK						
Pork Loin	3 - 5	325	163	35	180	82
Pork Chops						
1" (2.5 cm) thick	1 - 1.5	350	177	55-60 (total time)	180	82
Shoulder (Bone-in)	5 - 8	325	163	30 - 35	180	82
Ham, (fully cooked)	5	325	163	18	140	60
POULTRY						
Chicken, whole	3 - 4	375	191	30	180	82
Chicken, quarters	4	350	177	20 - 25	180	82
Turkey, unstuffed	12 - 16	325	163	16 - 20	180	82
Turkey, stuffed	12 - 16	325	163	18 - 24	180	82
Turkey Breasts	4 - 6	350	177	25	180	82
Cornish Hens	1 - 2	350	177	55-60 (total time)	180	82

Convection Roasting Chart

Type and Cut of Meat	Weight (lbs)	Convection Temperature		Convection Time (min./lb.)	Internal Temperature	
		(°F)	(°C)		(°F)	(°C)
BEEF						
Rib Roast	4 - 6	300	149			
•Rare				20	140	48
•Medium				24	155	68
•Well Done				30	170	77
Rump Roast	4 - 6	300	149			
•Medium				20	155	68
•Well Done				24	170	77
Tip Roast	3 - 4	300	149			
•Medium				30	155	68
•Well Done				35	170	77
LAMB						
Leg of Lamb	3 - 5	300	149	30	180	82
PORK						
Pork Loin	3 - 5	300	149	30	180	82
Pork Chops						
1" (2.5 cm) thick	1 - 1.5	325	163	45-50 (total time)	180	82
Shoulder (Bone-in)	5 - 8	300	149	25 - 28	180	82
Ham, (fully cooked)	5	325	163	15	140	60
POULTRY						
Chicken, whole	3 - 4	350	177	25	180	82
Chicken, quarters	4	325	163	15 - 20	180	82
Turkey, unstuffed	12 - 16	300	149	11 - 14	180	82
Turkey, stuffed	12 - 16	300	149	10 - 16	180	82
Turkey Breasts	4 - 6	325	163	20	180	82
Cornish Hens	1 - 2	325	163	45-50 (total time)	180	82

Infrared Conventional Broiling

The broiler is an in-the-oven infrared broiler design-certified for residential use. The method preferred by professional cooks to sear in the nutrition, flavors, and juices of meat, poultry, and fish is now possible in the home. The infrared broiler cooks up to 50% faster than other methods. Its intense, penetrating heat produces a more attractive, professional finish. The broil burner heats the metal screen located at the top of the oven until it glows. The glowing screen produces the infrared heat, searing the outside of broiled food and sealing in the juices.

Broiling is a dry-heat cooking method using direct or indirect radiant heat. It is used for small individualized cuts such as steaks, chops, and patties. Broiling is most successful for cuts 1-2 inches (2.54-5.1 cm) thick. Conventional broiling is also more suitable for flat pieces of meat.

Infrared Convection Broiling

Convection broiling has the advantage of broiling food slightly quicker than conventional. Convection broiling of meats produces better results especially for extra thick cuts. The meat sears on the outside and retains more juices and natural flavor inside with less shrinkage.

Rack Positions:

The broiler uses infrared heat rays to help cook the food. Because these rays can travel only in straight lines, the effective cooking area of the broiler is reduced when using the higher rack positions. At high rack positions, the rays cannot reach all corners of the broiler grid, so larger pieces of meat might not broil sufficiently at the outer edges. Position 6 is the closest to the broiler and position 1 is the closest to the oven bottom. The effective cooking areas on the broiler grid for each rack position are as follows:

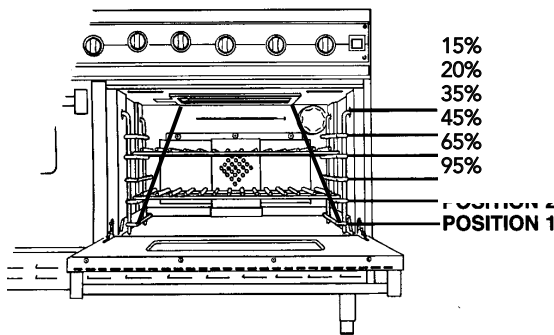

To use the Infrared Broiler:

1. Arrange the oven racks in the desired position.
2. Center food on cold broiler pan and grid supplied with your oven. Place broiler pan in oven and close the door.
3. Set the Temperature Control dial to BROIL.

Broiling Tips

- Always use a broiler pan and grid for broiling. They are designed to provide drainage of excess liquid and fat away from the cooking surface to help prevent spatter, smoke and fire.
- Place broiler pan with food in recommended rack position.
- To keep meat from curling, slit fatty edge.
- Brush chicken and fish with butter several times as they broil to prevent drying out. To prevent sticking, lightly grease broiler grid.
- Broil on first side for slightly more than half the recommended time, season and turn. Season second side just before removing.
- Always pull rack out to stop position before turning or removing food.
- Use tongs or a spatula to turn meats. Never pierce meat with a fork as this allows the juices to escape.
- Remove the broiler pan from the oven when you remove the food. Drippings will bake onto the pan if it is left in the heated oven after broiling. While pan is hot, place damp paper towel over grid. Drizzle with liquid dishwashing detergent and pour water over grid. This will make cleaning of the pan easier, or the broiler pan can be lined with aluminum foil to make cleaning easier. Be sure the foil extends up the side of the pan. Although it is not recommended, the grid can also be covered with foil. Be sure to slit openings to conform with the openings in the grid so melted fat can drain through to prevent spattering, smoking or possibility of grease fire.

Conventional/Convection Broiling Chart

Type and Cut of Meat	Weight	Rack	Conventional Time (Min.)	Convection Time (Min.)
BEEF				
Sirloin, 1" (2.54 cm)	12 oz	5		
•Rare			9	7
•Medium			11	9
•Well-done			14	11
T-Bone, 3/4" (1.9 cm)				
•Rare			7	5
•Medium			9	7
•Well-done			11	9
Hamburger, 1/2" (1.3 cm) 4 oz.				
•Rare			7	4
•Medium			9	7
•Well-done			11	9
CHICKEN				
Bnls Breast	1lb	4	18	15
Bone-in Breast	2 - 2 1/2 lb.	4	20	18
Quarters	2 - 2 1/2	4	18	15
HAM				
Ham slice, 1" (2.54 cm)	1lb.	4	22	18
LAMB				
Rib Chops	12 oz.	5	9	7
Shoulder	1lb.	5	7	6
PORK				
Loin Chops, 3/4" (1.9 cm)	1lb.	4	14	12
Bacon	1 lb.	4	8	6
FISH				
Salmon Steak	1 lb.	5	9	7
Filletts	1 lb.	5	8	6

Convection Dehydration

This oven is designed not only to cook, but also to dehydrate fruits and vegetables.

- Prepare the food as recommended.
- Arrange the food on drying racks. (Not included with oven; Contact a local store handling specialty cooking utensils.)
- Set the appropriate "low" temperature and turn the convection fan switch "ON".

Convection Defrosting

- Place the frozen food on a baking sheet.
- Set Temperature Control "OFF".*
- Turn the convection fan switch "ON".

*IMPORTANT:

Do not turn the Temperature Control on. Turning the convection fan on will accelerate the natural defrosting of the food without the heat.

*WARNING:

To avoid sickness and food waste, do not allow defrosted food to remain in the oven for more than two hours.

Cleaning and Maintenance

Any piece of equipment works better and lasts longer when maintained properly and kept clean. Cooking equipment is no exception. Your range must be kept clean and maintained properly.

Open Surface Burners (If applicable)

Wipe up spill-overs as soon as possible after they occur and before they get a chance to burn in and cook solid. In the event of a spill-over, follow these steps:

1. Allow the burner and grate to cool to a safe temperature level.
2. Lift off the open burner grates.
3. If the spill is contained in the bowl of the grate support, just remove the bowl and clean in warm soapy water.
4. Lift the grate support off.
5. Wash these parts in hot, soapy water and rinse clean.
6. If the spill has gone lower than the grate supports, draw out the drip pan and wash with hot, soapy water.

If ports on the burners are clogged, clean with a straight pin. Do not enlarge or distort the ports. Do not use a toothpick to clean the ports. When replacing burner caps, carefully align the tabs underneath the cap with the outside edge of burner. Make sure burner cap is level. Occasionally check the burner for proper size and shape. If flames lift off ports, are yellow, or are noisy when turned on, you may need to clean the burners or call a qualified technician for adjustment.

Sealed Surface Burners (If applicable)

Wipe up spill-overs as soon as possible after they occur and before they get a chance to burn in and cook solid. In the event of a spill-over, follow these steps:

1. Allow the burner and grate to cool to a safe temperature level.
2. Lift off the burner grates.
3. Remove the burner cap and clean per instructions below.
4. Wipe up any spills which remains on the sealed top surface.
5. Wash the grates and burner caps in hot, soapy water and rinse clean.
6. Replace burner cap and grate after drying thoroughly.

If ports on the burners are clogged, clean with a straight pin. Do not enlarge or distort the ports. Do not use a toothpick to clean the ports. Make sure burner cap is level. Occasionally check the burner for proper size and shape. If flames lift off ports, are yellow, or are noisy when turned on, you may need to clean the burners or call a qualified technician for adjustments.

Burner Caps

The surface burner caps should be routinely removed and cleaned. Always clean the burner caps after a spill over. Keeping the burner caps clean will prevent improper ignition and uneven flames. To clean, pull burner cap straight up from the burner base. Wipe off surface burner caps with warm, soapy water and a soft cloth after each use. Use a non-abrasive cleanser such as Bon Ami™ and a soft brush or soft Scotch Brite™ pad for cooked-on foods. Dry thoroughly after cleaning. For best cleaning and to avoid possible rusting, do not clean in dishwasher or self-cleaning oven. When replacing burner caps, carefully align the tabs underneath the cap with the outside edge of burner. Make sure burner cap is level.

Control Knobs

MAKE SURE THE CONTROL KNOBS POINT TO THE OFF POSITION BEFORE REMOVING. Pull the knobs straight off. Wash in detergent and warm water. Do not soak knobs. Dry completely and replace by pushing firmly onto stem. DO NOT USE any cleaners containing ammonia or abrasives. They could remove the graphics from the knob.

Control Panel

DO NOT USE any cleaners containing ammonia or abrasives. They could remove the graphics from the control panel. Use hot, soapy water and a soft clean cloth.

Sealed Burner Aluminum Base (If applicable)

The aluminum base should be wiped regularly with hot soapy water at the end of each cooling period. **Do not use** steel wool, abrasive cloths, cleanser, or powders. To remove encrusted materials, soak the area with at hot towel to loosen the material, then use a wooden or nylon spatula. **Do not use** a metal knife, spatula, or any other material tool to scrape the aluminum base. **NOTE:** For stubborn stains, use non-abrasive cleanser such as Bon Ami™ and a soft brush or soft Scotch Brite™ pad.

Griddle/Simmer Plate

1. After using the griddle, always remove the drip pan located below it by pulling the drip pan toward you. The drip pan needs to be cleaned after each use of the griddle. Cooked-off grease will drain from the griddle through the drain tube and accumulate in the drip pan. Wash in hot soapy water or with an antibacterial cleaner. The drip pan needs to be cleaned after each use. If grease is permitted to accumulate, fire hazard could occur, since the griddle burners are directly above the pan.
2. Rub the surface of a hot griddle with unsalted solid shortening, vegetable oil or spray it with a non-stick cooking spray. Thoroughly wipe it with a burlap or another rough cloth to remove food particles and other residue.
3. Stubborn spots may be removed by rubbing the surface with a rough grained nylon scrubbing pad with cooking oil. If necessary, flush the surface of a warm griddle (200°F/93°C) with club soda and wipe over entire surface with a paper towel. Coat lightly with cooking oil.
4. Special griddle cleaners are commercially available which may be used to remove heavy soil build-up. Follow manufacturer's directions exactly. Rinse the griddle with room temperature club soda after using these cleaners. Dry and coat lightly with cooking oil. Use griddle stones only when absolutely necessary and then with extreme caution. Wipe away any griddle-stone dust and food particles and coat lightly with cooking oil.
5. Using hot soapy water to clean the griddle will remove the cooked-in seasoning and will require re-seasoning by coating lightly with cooking oil.
6. **Never flood a hot griddle with cold water!** This promotes griddle warping and can cause the griddle plate to crack if continued over a period of time.

Grill

The grill grate may be cleaned immediately after cooking is complete and before turning off the flame. Wearing a barbecue mitt to protect your hand from heat, use a soft bristle barbecue brush to scrub the grill grate. Dip the brush frequently in a bowl of water. Steam is created as the water contacts the hot grate. The steam assists the cleaning process by softening the food particles. For thorough cleaning of the grill grate, soak 15 to 30 minutes in a hot water and detergent solution. After soaking, scrub with a soft scotch brite pad. **DO NOT USE** a steel wool pad or abrasive cleaners. They could damage the porcelain finish.

To disassemble for thorough cleaning, remove parts after they have cooled in the following order:

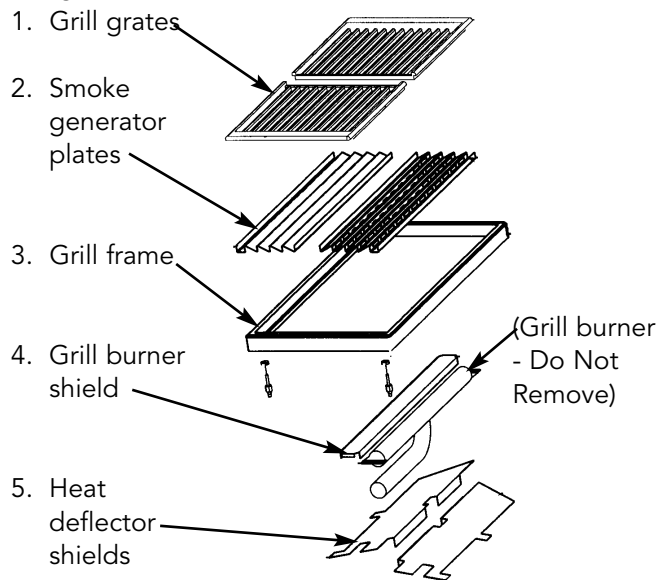

Clean greasy parts with a household grease solvent such as household ammonia and water. If necessary, a soap filled steel wool pad can be used on the grill frame shield, grill burner, and grill heat deflector.

After using the grill, always remove the drip pan located below it by pulling the drip pan toward you. The drip pan needs to be cleaned after each use of the griddle. Cooked-off grease will drain from the griddle through the drain tube and accumulate in the drip pan. Wash in hot soapy water or with an antibacterial cleaner. The drip pan needs to be cleaned after each use. If grease is permitted to accumulate, fire hazard could occur, since the grill burners are directly above the pan.

Brass Parts

CAUTION: All brass special ordered parts are coated with an epoxy coating. **DO NOT USE BRASS OR ABRASIVE CLEANERS ON THE BRASS OPTION PARTS.** All brass parts should be wiped regularly with hot soapy water.

Stainless Steel Parts

All stainless steel parts should be wiped regularly with hot, soapy water at the end of each cooling period and with liquid stainless steel cleaner when soapy water will not do the job. **Do not use** steel wool, abrasive cloths, abrasive cleaners, or powders. If necessary to scrape stainless steel to remove encrusted materials, soak the area with hot towels to loosen the material, then use a wooden or nylon spatula or scraper. **Do not use a metal knife, spatula, or any other metal tool to scrape stainless steel.** For occasional heavy cleaning use, a cleaner such as Liquid Zud can be used according to package directions. **Do not permit citrus or tomato juice to remain on stainless steel surface, as citric acid will permanently discolor stainless steel. Wipe up any spills immediately.**

Glass Surface

Clean with detergent and warm water. Glass cleaner can be used to remove fingerprints. If using glass cleaner ammonia, make sure that it does not run down on exterior door surface.

Wok Cast Iron Burner (If applicable)

For proper lighting and performance of the burner, keep the electric igniter and burner ports clean. It is necessary to clean these only when the flame does not burn blue completely around all rings of the burner, when there is a severe spillover or when the burner does not light, even though the electric spark igniter sparks. Clean the burner by scraping off burned on food soil. Use a wire, a straightened paper clip, or needle to clean the ports. **Do not use a toothpick; it could break off in the port. Be sure the venturi tube remains dry.**

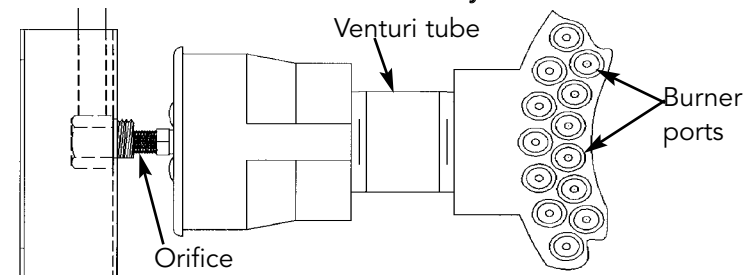

Broiler

There is no special care required for the infrared broiler. It is designed as self-contained unit, and no adjustments or cleaning are possible. Do not attempt to clean it. Its own operation burns off any impurities which may condense on it. Clean the broiler pan and grid after each use with detergent and hot water. For stubborn spots, use a soap-filled steel wool pad. The broiler pan and grid is also dishwasher safe.

Oven Racks

Clean with detergent and hot water. Stubborn spots can be scoured with a soap-filled steel wool pad.

Replacing Interior Oven Lights

CAUTION: DISCONNECT THE ELECTRIC POWER AT THE MAIN FUSE OR CIRCUIT BREAKER BEFORE REPLACING BULB.

1. Unscrew glass light cover.
2. Use an oven mitt during bulb removal to protect your hand in case the bulb breaks.
3. Replace the bulb with a 120 volt, 40-watt appliance bulb.
4. Replace the light cover
5. Reconnect power at the main fuse or circuit breaker.

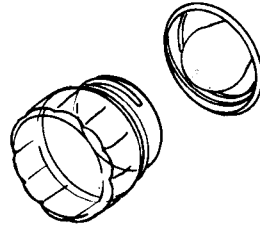

Power Failure

If power failure occurs, the electric ignitors will not work. The range surface burners can still be used, but only when the burners are lit manually with a match. The griddle cannot be used at all. Do not attempt to operate the oven. Make sure the oven control is in the "OFF" position.

Due to safety considerations and the possibility of personal injury in attempting to light and extinguish the burner, the grill should, under no circumstances, be used during a power failure. The grill burner control should always remain in the "OFF" position during a power failure. Momentary power failure can occur unnoticed. The range is affected only when the power is interrupted. When it comes back on, the range will function properly without any adjustments. A "brown-out" may or may not affect range operation, depending on how severe the power loss is.

Service Information

If service is required after checking the troubleshooting guide:

1. Call your dealer or authorized service agency. The name of the authorized service agency can be obtained from the dealer or distributor in your area.
2. Have the following information readily available:
 - Model Number
 - Serial Number
 - Date of Purchase
 - Name of dealer from whom purchased
3. Clearly describe the problem that you are having.

If you are unable to obtain the name of an authorized service agency, or if you continue to have service problems, contact Viking Range Corporation at (888) 845-4641 or write to:

VIKING RANGE CORPORATION
PREFERRED SERVICE
111 Front Street
Greenwood, Mississippi 38930 USA

Record the following information indicated below. You will need it if service is ever required. The serial number and model number for your range is located on the identification plate mounted on the interior left side of the burner box. To access this plate, remove the left side grates and grate supports

Model Number _____ Serial Number _____

Date of Purchase _____ Date Installed _____

Dealer's Name _____

Address _____

If service requires installation of parts, use only authorized parts to ensure protection under the warranty.

Please retain the manual for future reference

**PROFESSIONAL SERIES
FREESTANDING GAS RANGES WARRANTY**

ONE YEAR FULL WARRANTY

Freestanding gas ranges, all of their component parts and accessories, except as detailed below*, are warranted to be free from defective materials or workmanship in normal household use for a period of twelve (12) months from the date of original retail purchase. Viking Range Corporation, warrantor, agrees to repair or replace, at its option, any part which fails or is found to be defective during the warranty period.

*Glass (including light bulbs), painted and decorative items are warranted to be free from defective materials or workmanship for a period of ninety (90) days from the date of original retail purchase. ANY DEFECTS MUST BE REPORTED TO THE SELLING DEALER WITHIN NINETY (90) DAYS FROM DATE OF ORIGINAL RETAIL PURCHASE. Viking Range Corporation uses the most up-to-date processes and best materials available to produce all color finishes. However, slight color variation may be noticed because of the inherent differences in painted parts and porcelain parts as well as differences in kitchen lighting, product locations, and other factors.

FIVE YEAR LIMITED WARRANTY

Any surface burner, griddle burner, grill burner, or oven burner which fails due to defective materials or workmanship in normal household use during the second through fifth year from the date of original retail purchase will be repaired or replaced, free of charge for the part itself, with the owner paying all other costs, including labor.

TEN YEAR LIMITED WARRANTY

Any porcelain oven or porcelain inner door panel which rusts through due to defective materials or workmanship in normal household use during the second through the tenth year from the date of original retail purchase will be repaired or replaced, free of charge for the part itself, with the owner paying all other costs, including labor.

NINETY (90) DAY RESIDENTIAL PLUS WARRANTY This warranty applies to applications where use of the product extends beyond normal residential use. Examples are, but not limited to, bed and breakfasts, fire stations, private clubs, churches, etc. This warranty excludes all commercial locations such as restaurants, food service locations and institutional food service locations.

This warranty extends to the original purchaser of the product warranted hereunder and to each transferee owner of the product during the term of the warranty.

This warranty shall apply to products purchased and located in the United States and Canada. Products must be purchased in the country where service is requested. Warranty labor shall be performed by an authorized Viking Range Corporation service agency or representative. Warranty shall not apply to damage resulting from abuse, accident, natural disaster, loss of electrical power to the product for any reason, alteration, outdoor use, improper installation, improper operation, or repair or service of the product by anyone other than an authorized Viking Range Corporation service agency or representative. Warrantor is not responsible for consequential or incidental damage whether arising out of breach of warranty, breach of contract, or otherwise. Some jurisdictions do not allow the exclusion or limitation of incidental or consequential damages, so the above limitation or exclusion may not apply to you.

Owner shall be responsible for proper installation, providing normal care and maintenance, providing proof of purchase upon request, and making the appliance reasonably accessible for service. If the product or one of its component parts contains a defect or malfunction during the warranty period, after a reasonable number of attempts by the warrantor to remedy the defects or malfunctions, the owner is entitled to either a refund or replacement of the product or its component part or parts. Warrantor's liability on any claim of any kind, with respect to the goods or services covered hereunder, shall in no case exceed the price of the goods or service or part thereof which gives rise to the claim.

WARRANTY SERVICE: Under the terms of this warranty, service must be performed by a factory authorized Viking Range Corporation service agent or representative. Service will be provided during normal business hours, and labor performed at overtime or premium rates shall not be covered by this warranty. To obtain warranty service, contact the dealer from whom the product was purchased, an authorized Viking Range Corporation service agent, or Viking Range Corporation. Provide model and serial number and date of original purchase. For the name of your nearest authorized Viking Range Corporation service agency, call the dealer from whom the product was purchased or Viking Range Corporation.
IMPORTANT: Retain proof of original purchase to establish warranty period.

The return of the Owner Registration Card is not a condition of warranty coverage. You should, however, return the Owner Registration Card so that Viking Range Corporation can contact you should any question of safety arise which could affect you.

Any implied warranties of merchantability and fitness applicable to the above described surface burner, griddle burner, grill burner, oven burner, porcelain oven, or porcelain inner door panel are limited in duration to the period of coverage of the applicable express written limited warranties set forth above. Some jurisdictions do not allow limitations on how long an implied warranty lasts, so the above limitation may not apply to you. This warranty gives you specific legal rights, and you may also have other rights which may vary from jurisdiction to jurisdiction.

Specifications subject to change without notice

Free Manuals Download Website

<http://myh66.com>

<http://usermanuals.us>

<http://www.somanuals.com>

<http://www.4manuals.cc>

<http://www.manual-lib.com>

<http://www.404manual.com>

<http://www.luxmanual.com>

<http://aubethermostatmanual.com>

Golf course search by state

<http://golfingnear.com>

Email search by domain

<http://emailbydomain.com>

Auto manuals search

<http://auto.somanuals.com>

TV manuals search

<http://tv.somanuals.com>