

Use & Care Manual

Viking Range, LLC
111 Front Street
Greenwood, Mississippi 38930 USA
(662) 455-1200

For product information,
call 1-888-845-4641
or visit our web site in the US at www.vikingrange.com
or in Canada at www.brigade.ca

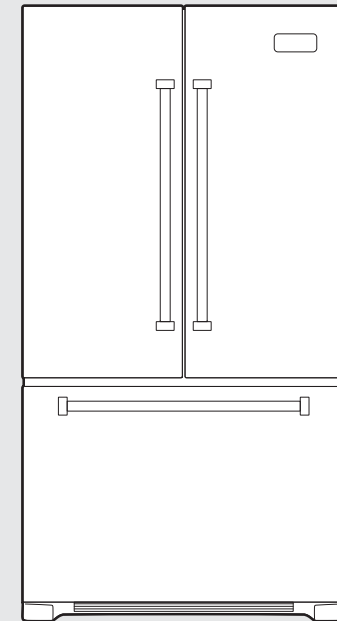

Counter-Depth
Freestanding French Door
Bottom-Mount Refrigerator/Freezer



F21168 EN
W10581472

(053113)

Congratulations

We hope you will enjoy and appreciate the care and attention we have put into every detail of your new, state-of-the-art refrigerator.

Your appliance is designed to offer years of reliable service. This Use and Care Guide will provide you with the information you need to become familiar with your refrigerator's care and operation.

Your complete satisfaction is our ultimate goal. If you have any questions or comments about this product, please contact the dealer from whom you purchased it, or contact our Consumer Support Center at 1-888-846-4641.

We appreciate your choice of our refrigerator and hope that you will again select our products for your other major appliance needs.

For more information about the complete and growing selection of products, contact your dealer or visit us online.

Table of Contents

Getting Started

Refrigerator Safety _____	4
Important Safety Instructions _____	5
Proper Disposal (of old refrigerator) _____	6

Product Controls

Using the Controls _____	7
Temperature Controls _____	8
Additional Control Center Features _____	8

Operation

Adjustable Humidity Zone and Adjustable Cold Zone _____	10
Opening & Closing Doors _____	11
Ice Maker _____	12
Water Dispenser _____	13
Water Filtration System _____	14
Water Filter _____	16
Water Filter Certifications _____	17

Product Care

Cleaning _____	18
Changing the Light Bulb _____	19
Troubleshooting _____	20
Service Information _____	26
Warranty _____	27

Refrigerator Safety

Your safety and the safety of others are very important.

We have provided many important safety messages in this manual and on your appliance. **ALWAYS** read and obey all safety messages.



This is the safety alert symbol.

This symbol alerts you to potential hazards that can and others.

All safety messages will follow the safety alert symbol and either the word **"DANGER"** or **"WARNING."**

DANGER

You can be killed or seriously injured if you don't immediately follow instructions.

WARNING

You can be killed or seriously injured if you don't follow instructions.

All safety messages will tell you what the potential hazard is, tell you how to reduce the chance of injury, and tell you what can happen if the instructions are not followed.

Important Safety Instructions

WARNING

To reduce the risk of fire, electric shock, or injury when using your refrigerator, follow these basic precautions:

- Plug into a grounded 3-prong outlet.
- **DO NOT** remove ground prong.
- **DO NOT** use an adapter.
- **DO NOT** use an extension cord.
- Disconnect power before servicing.
- Replace all parts and panels before operating.
- Remove doors from your old refrigerator.
- Use nonflammable cleaner.
- Keep flammable materials and vapors, such as gasoline, away from refrigerator.
- Use two or more people to move and install refrigerator.
- Disconnect power before installing ice maker (on ice maker kit ready models only).
- Use a sturdy glass when dispensing ice (on some models).

SAVE THESE INSTRUCTIONS

WARNING

State of California Proposition 65 Warning

- This product contains one or more chemicals known to the State of California to cause cancer.
- This product contains one or more chemicals known to the State of California to cause birth defects or other reproductive harm.

Proper Disposal (of old refrigerator)

! WARNING

Suffocation Hazard

Remove doors from your old refrigerator.

Failure to do so can result in death or brain damage.

IMPORTANT:

Child entrapment and suffocation are not problems of the past. Junked or abandoned refrigerators are still dangerous—even if they will sit for “just a few days”. If you are getting rid of your old refrigerator, please follow these instructions to help avoid accidents.

Before You Throw Away Your Old Refrigerator or Freezer:

- Take off the doors.
- Leave the shelves in place so that children may not easily climb inside.

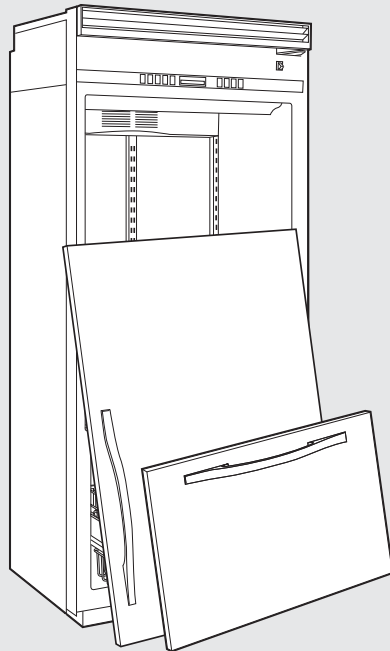

Using the Controls

The control center is located at the top front of the refrigerator compartment.

Temperature Controls

For your convenience, your temperature controls are preset at the factory. When you first install your refrigerator, make sure the controls are still set to the recommended set points as shown.

Recommended Settings

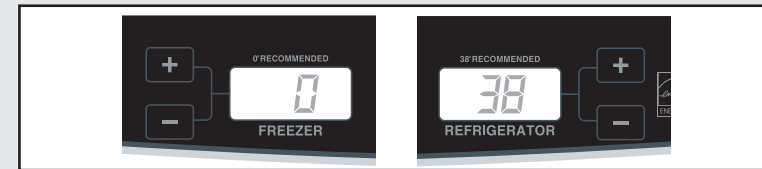

IMPORTANT:

- The recommended settings should be correct for normal household refrigerator use. The controls are set correctly when milk or juice is as cold as you like and when ice cream is firm.
 - When the power is on, the temperature display shows the actual temperature of the compartment.
 - Wait 24 hours for your refrigerator to cool completely before adding food. If you add food before the refrigerator has cooled completely, your food may spoil.
- Note:** Adjusting the refrigerator and freezer temperature controls to a colder than recommended setting will not cool the compartments any faster.
- If the temperature is too warm or too cold in the refrigerator or freezer, first check the air vents to be sure they are not blocked before adjusting the controls.

Cooling On/Off:

- Cooling On/Off turns off cooling for both compartments. It does not disconnect power to the refrigerator.
- Press and hold Cooling On/Off for 3 seconds. The LED will light up to indicate that cooling is Off. Press the button again to turn on the cooling. The LED will turn off.



Using the Controls (cont.)

Temperature Controls (cont.)

The REFRIGERATOR control adjusts the refrigerator compartment temperature. The FREEZER control adjusts the freezer compartment temperature.

If you need to adjust the temperature in either the refrigerator or freezer compartment, use the settings listed in the chart as a guide.

To Adjust Set Point Temperatures:

The first touch of the (+) or (-) touch pad displays the current temperature set point.



- Press the (+) or (-) touch pads until the desired temperature set point is displayed.

Note: Except when first turning on the refrigerator, **DO NOT** adjust either temperature control more than one setting at a time. Wait 24 hours between adjustments for the temperature to stabilize.

Condition/Reason	Adjustment
Refrigerator too warm	Adjust REFRIGERATOR Control 1° lower
Freezer too warm/too little ice	Adjust FREEZER Control 1° lower
Refrigerator too cold	Adjust REFRIGERATOR Control 1° higher
Freezer too cold	Adjust FREEZER Control 1° higher

Additional Control Center Features

Humidity Control

The Humidity Control feature turns on a heater to help reduce moisture on the door hinge seal. Use in humid environments or when you notice moisture on the door hinge seal. The refrigerator uses more energy when Humidity Control is on.

Using the Control (cont.)

Additional Control Center Features (cont.)

- Press Humidity Control when the environment is warm and more humid, or if you notice moisture on the door hinge seal. The indicator light will be lit when humidity control is **ON**.
- Press Humidity Control again to turn **OFF** and save energy when the environment is less humid.



Sabbath Mode

The Sabbath Mode is designed for those whose religious observances require turning off the lights and dispensers.

ON - All interior lights and alarm tones will be disabled.
OFF - All interior lights and alarm tones will be enabled.

- Press and hold the Sabbath Mode touch pad for 3 seconds or until the indicator light is lit to turn on this feature. Press and hold the Sabbath Mode touch pad again to turn off this feature.



Door Alarm

The Door Alarm feature sounds a chime every few seconds when the refrigerator door has been left open for 5 continuous minutes. The chime will sound until the door is closed or Door Alarm is turned off.

- Press the Door Alarm to turn this feature **ON** or **OFF**. The indicator light will be lit when the Door Alarm feature is on.



Max Cool

The Max Cool feature assists with periods of high refrigerator use, full grocery loads, or temporarily warm room temperatures.

- Press Max Cool to set the freezer and refrigerator to the lowest temperature settings. Press Max Cool again to return to the normal refrigerator set point.

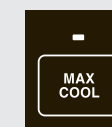

Note: The Max Cool feature will automatically shut off in approximately 12 hours.

Using the Controls (cont.)

Additional Control Center Features (cont.)

Filter Reset

The Filter Reset control allows you to restart the water filter status tracking feature each time you replace your water filter. See "Water Filtration System."

- Press and hold the Filter Reset touch pad for 3 seconds, until the Order or Replace light turns off.

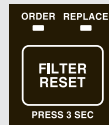

User Preferences

The control center allows you to set user preferences, if desired.

Temperature Display (F_C)

This preference allows you to change the temperature display.

F - Temperature in degrees Fahrenheit

C - Temperature in degrees Celsius

Alarm (AL)

This preference allows you to turn off the sound of all alarms.

ON - You will hear the alarm sound.

OFF - You will not hear the alarm sound.

To Access the User Preferences Menu:

1. Press and hold the Door Alarm touch pad for 3 seconds. The preference name will appear in the Freezer display and the preference status (**F** or **C**) or (**ON** or **OFF**) will appear in the Refrigerator display.
2. Use the Freezer (+) or (-) touch pads to scroll through the preference names. When the desired preference name is displayed, press the Refrigerator (+) or (-) touch pads to change the preference status.
3. Set your preferences by pressing and holding the Door Alarm touch pad for 3 seconds, or by shutting the refrigerator compartment door.

Adjustable Humidity Zone and Adjustable Cold Zone (cont.)

Adjustable Humidity Zone™

You can control the amount of humidity in the Adjustable Humidity Zone drawer. Adjust the control to any setting between **LOW** and **HIGH**. **LOW** (open) for best storage of fruits and vegetables with skins. **HIGH** (closed) for best storage of fresh, leafy vegetables.

Adjustable Cold Zone™

The Adjustable Cold Zone drawer is a full-width drawer with adjustable temperature control. This drawer can be used for large party trays, deli items, beverages or miscellaneous items.

Adjustable Cold Zone Control

The control, located on the right of the drawer, regulates the air temperature inside the drawer. Set control to "COLD" to provide normal refrigerator temperature. Use the **COLDEST** setting for meats or other deli items.

- Cold air directed to the drawer can decrease refrigerator temperature. Refrigerator control may need to be adjusted.
- **DO NOT** place leafy vegetables in the drawer. Colder temperatures could damage leafy produce.

To Remove:

- Lift lid. Pull drawer out to full extension. Tilt the drawer front up and pull straight out.

To Install:

- Push metal glide rails to the back of the refrigerator. Place drawer onto rails and slide drawer back until it falls into place.

Opening and Closing Doors

There are two refrigerator compartment doors. The doors can be opened and closed either separately or together. There is a vertically-hinged seal on the left refrigerator door.

- When the left side door is opened, the hinged seal automatically folds inward so that it is out of the way.
- When both doors are closed, the hinged seal automatically forms a seal between the two doors.

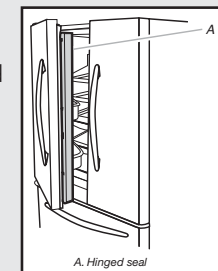

Ice Maker

IMPORTANT: Flush the water system before turning on the ice maker. See "Water Dispenser" section.

Turning the Ice Maker On/Off

To turn the ice maker **ON**, simply lower the wire shutoff arm. To manually turn the ice maker **OFF**, lift the wire shutoff arm to the **OFF** (arm up) position and listen for the click.

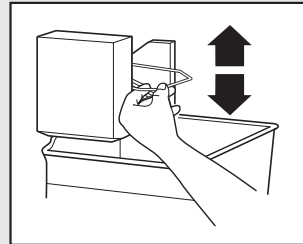

Note: Your ice maker has an automatic shutoff. As ice is made, the ice cubes will fill the ice storage bin and the ice cubes will raise the wire shutoff arm to the **OFF** (arm up) position. **DO NOT** force the wire shutoff arm up or down.

Auto Ice Storage Bin

Your ice storage bin has a lever which allows the storage bin to slide out with the drawer when it is pulled open or to stay in place.

- Move the lever to the right to attach the ice storage bin to the freezer drawer.
- Move the lever to the left to release the ice storage bin from the freezer drawer.

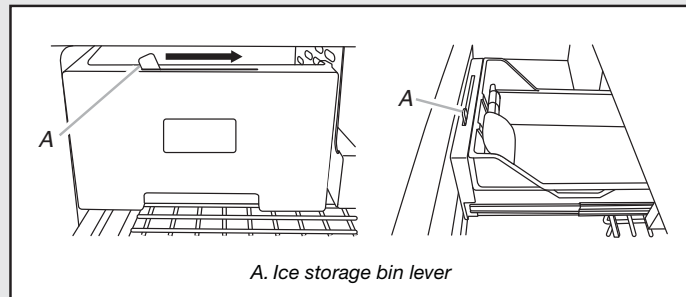

Ice Production Rate

- The ice maker should produce a complete batch of ice approximately every 3 hours.
- To increase ice production, lower the freezer and refrigerator temperature. See "Using the Controls" section. Wait 24 hours between adjustments.

Ice Maker (cont.)

Remember

- Allow 24 hours to produce the first batch of ice. Discard the first three batches of ice produced.
- The quality of your ice will be only as good as the quality of the water supplied to the ice maker. **AVOID** connecting the ice maker to a softened water supply. Water softener chemicals (such as salt) can damage parts of the ice maker and lead to poor quality ice. If a softened water supply cannot be avoided, make sure the water softener is operating properly and is well maintained.
- **DO NOT** use anything sharp to break up the ice in the bin. This can cause damage to the ice bin and dispenser mechanism.
- **DO NOT** store anything on top of the ice maker or in the ice storage bin.

Water Dispenser

IMPORTANT:

- After connecting the refrigerator to a water source or replacing the water filter, flush the water system. Use a sturdy container to depress and hold the water dispenser lever for 5 seconds, then release it for 5 seconds. Repeat until water begins to flow. Once water begins to flow, continue depressing and releasing the dispenser paddle (5 seconds on, 5 seconds off) until a total of 4 gal. (15 L) has been dispensed. This will flush air from the filter and water dispensing system, and prepare the water filter for use. Additional flushing may be required in some households. As air is cleared from the system, water may spurt out of the dispenser.

Note: After 5 minutes of continuous dispensing, the dispenser will stop dispensing water to avoid flooding. To continue dispensing, press the dispenser paddle again.

- Allow 24 hours for the refrigerator to cool down and chill water. Dispense enough water every week to maintain a fresh supply.

Dispensing Water

1. Hold a container under the dispenser spout while pressing the dispenser pad.
2. Release the dispenser pad to stop dispensing.

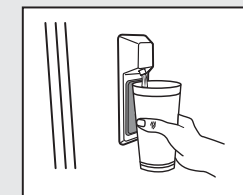

The water filter is located in the upper right-hand corner of the refrigerator compartment.

Water Filtration System

Note: DO NOT use with water that is microbiologically unsafe or of unknown quality without adequate disinfection before or after the system. Systems certified for cyst reduction may be used on disinfected waters that may contain filterable cysts.

Water Filter Status Lights

The water filter status lights will help you know when to change the water filter. When the Order light is on, it is almost time to change the water filter. When the Replace light is on, a new water filter should be installed. After replacing the water filter, press and hold Filter Reset for 3 seconds until the Order or Replace light turns off. See "Using the Controls" section.

Replacing the Water Filter

Replacement water filters are available through your local Viking Range Dealer. You may also order filters by calling 1-888-845-4641 or online at vikingrange.com

IMPORTANT: Air trapped in the water system may cause water and filter to eject. **ALWAYS** dispense water for at least 2 minutes before removing the filter or blue bypass cap.

1. Turn filter counterclockwise to remove.
2. Remove sealing label from replacement filter and insert the filter end into the filter head.
3. Turn the filter clockwise until it stops. Snap the filter cover closed.
4. Flush the water system. See "Water Dispenser" section.

Note: The dispenser feature may be used without a water filter installed. Your water will not be filtered. If this option is chosen, replace the filter with the blue bypass cap.

Refrigerator Water Filter Cartridge Model RWFFR

Specifications

Service Flow Rate (Maximum).....0.78 GPM (2.9 L/min)
 Rated Service Life RWFFR (750 gal. Max)750 gal./2838 liters
 Maximum Operating Temperature.....100°F/38°C
 Minimum Pressure Requirement35 psi/241 kPA
 Minimum Operating Temperature.....33°F/1°C
 Maximum Operating Pressure.....120 psi/827 kPA

Water Filtration System (cont.)

General Use Conditions

Read this Performance Data Sheet and compare the capabilities of this refrigerator with your actual water treatment needs. **DO NOT** use this product where water is microbiologically unsafe or of unknown quality without adequate disinfection before or after the system. System certified for cyst reduction may be used on disinfected water that may contain filterable cysts. **USE ONLY WITH COLD WATER SUPPLY. CHECK FOR COMPLIANCE WITH THE STATE AND LOCAL LAWS AND REGULATIONS.**



Tested and certified by NSF International against ANSI/NSF Standards 42 & 53 in models RWFFR for the reduction of:

<p>Standard No. 42 Aesthetic Effects: Taste and Odor Reduction Chlorine Taste & Odor Mechanical Filtration Unit Particulate Reduction Class I</p>	<p>Standard No. 53 Health Effects: Chemical Reduction Unit Lead, Atrazine, Lindane, Benzene, Carbofuran, p-Dichlorobenzene, Mercury, & Toxaphene Reduction Mechanical Filtration Unit Cyst, Turbidity & Asbestos Reduction</p>
--	---

The retractable water filtration system uses a RWFFR replacement cartridge. Timely replacement of filter cartridge is essential for performance satisfaction from this filtration system. Please refer to the applicable section of your Use & Care Guide for general operation, maintenance requirements and troubleshooting.

This system has been tested according to ANSI/NSF 42 and 53 for reduction of the substance listed above. The concentration of the indicated substances in water entering the system was reduced to a concentration less than or equal to the permissible limit for water leaving the system, as specified in ANSI/NSF 42 and 53.

Water Filter

Standard No. 42: Aesthetic Effects								
Parameter	USEPA MCL	Influent Challenge Concentration	Influent Average	Effluent		% Reduction		Min. Required Reduction
				Avg.	Max.	Avg.	Min.	
Chlorine	—	2.0 mg/L + 10%	1.88 mg/L	<0.051363 mg/L	0.06 mg/L	>97.26%	96.84%	50%
T & O	—	—	—	—	—	—	—	—
Particulate**	—	at least 10,000 particles/ml	57,000,000 #/ml	30,583 #/ml	69,000 #/ml	99.52%	98.94%	85%

Standard No. 53: Health Effects								
Parameter	USEPA MCL	Influent Challenge Concentration	Influent Average	Effluent		% Reduction		Min. Required Reduction
				Avg.	Max.	Avg.	Min.	
Turbidity	1NTU**	11 + 1 NTU***	10.7 NTU	.031 NTU	0.49 NTU	97.09%	95.20%	0.5NTU
Cysts	99.5% Red	Minimum 50,000/L	166,500 #/L	L <1 #/L	<1 #/L	>99.99%	>99.99%	>99.95%
Asbestos	99% Red	107 108 fibers/L; fibers >10 micrometers in length	155 MF/L	<1 MF/L	<1 MF/L	>99.99%	>99.99%	99%
Lead at pH 6.5	0.015 mg/L	0.15 mg/L + 10%	0.153 mg/L	<0.001 mg/L	<0.001 mg/L	>99.35%	>99.29%	0.10 mg/L
Lead at pH 8.5	0.015 mg/L	0.15 mg/L + 10%	0.150 mg/L	<0.001 mg/L	<0.001 mg/L	>99.33%	>99.29%	0.10 mg/L
Mercury at pH 6.5	0.002 mg/L	0.06 mg/L + 10%	0.006 mg/L	<0.003 mg/L	<0.005 mg/L	95.70%	90.91%	0.002 mg/L
Mercury at pH 8.5	0.002 mg/L	0.06 mg/L + 10%	0.006 mg/L	<0.008 mg/L	<0.015 mg/L	86.22%	75.93%	0.002 mg/L
Atrazine	0.003 mg/L	0.09 mg/L + 10%	0.009 mg/L	<0.002 mg/L	<0.002 mg/L	76.99%	75.31%	0.003 mg/L
Benzene	0.005 mg/L	0.15 mg/L + 10%	0.014 mg/L	<0.006 mg/L	<0.011 mg/L	95.71%	92.14%	0.005 mg/L
Carbofuran	0.04 mg/L	0.08 mg/L + 10%	0.081 mg/L	<0.001 mg/L	<0.001 mg/L	98.74%	98.46%	0.04 mg/L
p-Dichlorobenzene	0.075 mg/L	0.225 mg/L + 10%	0.208 mg/L	<0.005 mg/L	<0.005 mg/L	99.76%	99.74%	0.075 mg/L
Lindane	0.0002 mg/L	0.002 mg/L + 10%	0.002 mg/L	<0.000 mg/L	<0.001 mg/L	98.72%	96.50%	0.0002 mg/L
Toxaphene	0.003 mg/L	0.15 mg/L + 10%	0.015 mg/L	<0.001 mg/L	<0.001 mg/L	92.97%	91.67%	0.003 mg/L

*Tested using a flow rate of 0.78 gpm; pressure of 60psig; pH of 7.5 + 0.5; temp of 68° + 5°F (20° + 3°C).

**Measurement in Particles/ml. Particles used were 0.5 - 1 microns

***NTU - Nephelometric Turbidity Units

Water Filter Certifications

State of California
 Department of Public Health
 Water Treatment Device
 Certificate Number
 06 - 1790
 Date Issued: June 1, 2011

Trademark/Model Designation
 Viking, RWFFR-750

Replacement Elements
 RWFFR

Manufacturer: 3M Purification Inc.

The water treatment device(s) listed on this certificate have met the testing requirements pursuant to Section 116830 of the Health and Safety Code for the following health related contaminants:

Microbiological Contaminants and Turbidity

Cysts
 Turbidity

Inorganic/Radiological Contaminants

Asbestos
 Lead
 Mercury

Organic Contaminants

Atrazine
 Benzene
 Carbofuran
 Lindane
 p-Dichlorobenzene
 Toxaphene

Rated Service Capacity: 750 gals

Rated Service Flow: 0.78 gpm

Conditions of Certification:

Do not use where water is microbiologically unsafe or with water of unknown quality, except that systems certified for cyst reduction may be used on disinfected waters that may contain filterable cysts.

Operation

Operation

Cleaning

Both the refrigerator and freezer sections defrost automatically. However, clean both sections about once a month to avoid buildup of odors. Wipe up spills immediately.

IMPORTANT: Because air circulates between both sections, any odors formed in one section will transfer to the other. You must thoroughly clean both sections to eliminate odors. To avoid odor transfer and drying out of food, wrap or cover foods tightly.

⚠ WARNING

Explosion Hazard
Use nonflammable cleaner. Failure to do so can result in death, explosion, or fire.

To Clean Your Refrigerator:

Note: DO NOT use abrasive or harsh cleaners such as window sprays, scouring cleansers, flammable fluids, cleaning waxes, concentrated detergents, bleaches or cleansers containing petroleum products on plastic parts, interior and door liners or gaskets. **DO NOT** use paper towels, scouring pads, or other harsh cleaning tools.

1. Unplug refrigerator or disconnect power.
2. Hand wash, rinse, and dry removable parts and interior surfaces thoroughly. Use a clean sponge or soft cloth and a mild detergent in warm water.
3. Wash stainless steel and painted metal exteriors with a clean sponge or soft cloth and a mild detergent in warm water.
4. There is no need for routine condenser cleaning in normal home operating environments. If the environment is particularly greasy or dusty, or there is significant pet traffic in the home, the condenser should be cleaned every 2 to 3 months to ensure maximum efficiency.

If you need to clean the condenser:

- Remove the base grille.
 - Use a vacuum cleaner with a soft brush to clean the grille, the open areas behind the grille and the front surface area of the condenser.
 - Replace the base grille when finished.
5. Plug in refrigerator or reconnect power.

Changing the Light Bulb

Note: Not all appliance bulbs will fit your refrigerator. Be sure to replace the bulb with an appliance bulb of the same size, shape, and wattage (no greater than 40 watts).

Changing the Refrigerator Light Bulb

1. Unplug the refrigerator or disconnect power.
2. Slide the light shield toward the back of the compartment to release it from the light assembly.
3. Replace burned-out bulb(s) with appliance bulb(s) no greater than 40 watts.

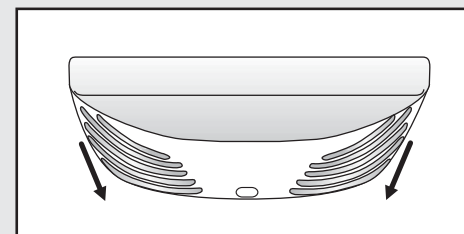

4. Replace the light shield by inserting the tabs on the shield into the liner holes on each side of light assembly. Slide the shield toward the front until it locks into place.

Note: To avoid damaging the light shield, **DO NOT** force the shield beyond the locking point.

5. Plug in refrigerator or reconnect power.

Changing the Freezer Light Bulb

1. Unplug refrigerator or disconnect power.
2. Remove the burned-out bulb and replace it with an appliance bulb no greater than 40 watts.
3. Plug in refrigerator or reconnect power.

Troubleshooting

⚠ WARNING



Electrical Shock Hazard

Plug into a grounded 3 prong outlet.

DO NOT remove ground prong.

DO NOT use an adapter.

DO NOT use an extension cord.

Failure to follow these instructions can result in death, fire, or electrical shock.

Refrigerator Operation

Problem	Cause	Solution
The refrigerator will not operate	Power cord unplugged? Is outlet working? Household fuse blown or circuit breaker tripped? Are controls on? New installation?	Plug into a grounded 3-prong outlet. Plug in a lamp to see if the outlet is working. Replace the fuse or reset the circuit breaker. If the problem continues, call an electrician. Make sure the refrigerator controls are on. See "Using the Controls". Allow 24 hours following installation for the refrigerator to cool completely. Note: Adjusting the temperature controls to coldest setting will not cool either compartment more quickly.
The motor seems to run too much	Normal operation	Your new refrigerator may run longer than your old one due to its high-efficiency compressor and fans. The refrigerator may run even longer if the room is warm, a large food load is added, doors are opened often, or if the doors have been left open.

Troubleshooting (cont.)

Refrigerator Operation

Problem	Cause	Solution
The refrigerator seems noisy	Refrigerator noise has been reduced over the years. Due to this reduction, you may hear intermittent noises from your new refrigerator that you did not notice from your old model. Listed on the right are some normal sounds with explanations.	Buzzing—heard when the water valve opens to fill the ice maker Pulsating—fans/compressor adjusting to optimize performance Hissing/Rattling—flow of refrigerant, movement of water lines, or from items placed on top of the refrigerator Sizzling/Gurgling—water dripping on the heater during defrost cycle Popping—contraction/expansion of inside walls, especially during initial cool-down Water running—may be heard when water melts during the defrost cycle and runs into the drain pan Creaking/Cracking—occurs as ice is being ejected from the ice maker mold.
The doors will not close completely	Door blocked open? Bin or shelf in the way?	Move food packages away from door. Push bin or shelf back in the correct position.

⚠ WARNING



Explosion Hazard

Use nonflammable cleaner.

Failure to do so can result in death, explosion, or fire.

Problem	Cause	Solution
The doors are difficult to open	Gaskets dirty or sticky?	Clean gaskets and contact surfaces with mild soap and warm water. Rinse and dry with soft cloth.

Troubleshooting (cont.)

Temperature and Moisture

Problem	Cause	Solution
Temperature is too warm	<p>New installation?</p> <p>Door(s) opened often or left open?</p> <p>Large load of food added?</p> <p>Controls set correctly for the surrounding conditions?</p>	<p>Allow 24 hours following installation for the refrigerator to cool completely.</p> <p>Allows warm air to enter refrigerator. Minimize door openings and keep doors fully closed.</p> <p>Allow several hours for refrigerator to return to normal temperature.</p> <p>Adjust the controls a setting colder. Check temperature in 24 hours. See "Using the Controls".</p>
<p>There is interior moisture buildup</p> <p>Note: Some moisture buildup is normal.</p>	<p>High humidity?</p> <p>Door(s) left open?</p>	<p>Minimize door openings and keep door(s) fully closed.</p> <p>Keep door(s) fully closed.</p>

Troubleshooting (cont.)

Ice and Water

Problem	Cause	Solution
The ice maker is not producing ice or not enough ice	<p>Refrigerator connected to a water supply and the supply shutoff valve turned on?</p> <p>Kink in the water source line?</p> <p>Ice maker turned on?</p> <p>New installation?</p> <p>Freezer door closed completely?</p> <p>Large amount of ice recently removed?</p> <p>Ice cube jammed in the ice maker ejector arm?</p> <p>Water filter installed on the refrigerator?</p> <p>Reverse osmosis water filtration system connected to your cold water supply?</p>	<p>Connect refrigerator to water supply and turn water shutoff valve fully open. A kink in the line can reduce water flow. Straighten the water source line.</p> <p>Make sure wire shutoff arm or switch (depending on model) is in the ON position. Wait 24 hours after ice maker installation for ice production to begin. Wait 72 hours for full ice production.</p> <p>Firmly close the freezer compartment door. If the freezer compartment door will not close all the way, see "The doors will not close completely".</p> <p>Allow 24 hours for ice maker to produce more ice. Remove ice from the ejector arm with a plastic utensil. Remove filter and operate ice maker. If ice volume improves, then the filter may be clogged or incorrectly installed. Replace filter or reinstall it correctly.</p> <p>This can decrease water pressure. See "Water Supply Requirements".</p>
<p>The ice cubes are hollow or small</p> <p>Note: This is an indication of low water pressure.</p>	<p>Water shutoff valve not fully open?</p> <p>Kink in the water source line?</p> <p>Water filter installed on the refrigerator?</p> <p>Reverse osmosis water filtration system connected to your cold water supply?</p>	<p>Turn the water shutoff valve fully open. A kink in the line can reduce water flow. Straighten the water source line.</p> <p>Remove filter and operate ice maker. If ice quality improves, then the filter may be clogged or incorrectly installed. Replace filter or reinstall it correctly.</p> <p>This can decrease water pressure. See "Water Supply Requirements".</p>

Troubleshooting (cont.)

⚠ WARNING

Cut Hazard Use a sturdy glass when dispensing ice. Failure to do so can result in cuts.

Ice and Water

Problem	Cause	Solution
Off-taste, odor or gray color in the ice	<p>New plumbing connections?</p> <p>Ice stored too long?</p> <p>Odor transfer from food?</p> <p>Are there minerals (such as sulfur) in the water?</p> <p>Water filter installed on the refrigerator?</p>	<p>New plumbing connections can cause discolored or off-flavored ice.</p> <p>Discard ice. Wash ice bin. Allow 24 hours for ice maker to make new ice.</p> <p>Use airtight, moisture proof packaging to store food.</p> <p>A water filter may need to be installed to remove the minerals.</p> <p>Gray or dark discoloration in ice indicates that the water filtration system needs additional flushing. Flush the water system before using a new water filter. Replace water filter when indicated. See "Water Filtration System".</p>
The water and ice dispenser will not operate properly	<p>Refrigerator connected to a water supply and the supply shutoff valve turned on?</p> <p>Kink in the water source line?</p> <p>New installation?</p> <p>Is the water pressure at least 35 psi (241 kPa)?</p>	<p>Connect refrigerator to water supply and turn water shutoff valve fully open.</p> <p>Straighten the water source line.</p> <p>Flush and fill the water system. See "Water and Ice Dispenser".</p> <p>The water pressure to the home determines the flow from the dispenser. See "Water Supply Requirements".</p>

Troubleshooting (cont.)

Ice and Water

Problem	Cause	Solution
The water and ice dispenser will not operate properly	<p>Water filter installed on the refrigerator?</p> <p>Refrigerator door closed completely?</p> <p>Recently removed the doors?</p> <p>Reverse osmosis water filtration system connected to your cold water supply?</p>	<p>Remove filter and operate dispenser. If water flow increases, the filter may be clogged or incorrectly installed. Replace filter or reinstall it correctly.</p> <p>Close the door firmly. If it does not close completely, see "The doors will not close completely".</p> <p>Make sure the water dispenser wire/tube assembly has been properly reconnected at the bottom of the refrigerator door. See "Refrigerator Doors and Drawer".</p> <p>This can decrease water pressure. See "Water Supply Requirements".</p>
Water is leaking from the dispenser system	<p>Glass not being held under the dispenser long enough?</p> <p>New installation?</p> <p>Recently changed water filter?</p> <p>Water on the floor near the base grille?</p>	<p>Hold the glass under the dispenser two to three seconds after releasing the dispenser lever.</p> <p>Flush the water system. See "Water and Ice Dispenser".</p> <p>Flush the water system. See "Water and Ice Dispenser".</p> <p>Make sure the water dispenser tube connections are fully tightened. See "Refrigerator Doors and Drawer".</p>
Water from the dispenser is warm	<p>New installation?</p> <p>Recently dispensed large amount of water?</p> <p>Water not been recently dispensed?</p> <p>Refrigerator connected to a cold water pipe?</p>	<p>Allow 24 hours after installation for the water supply to cool completely. Allow 24 hours for water supply to cool completely. The first glass of water may not be cool. Discard the first glass of water.</p> <p>Make sure the refrigerator is connected to a cold water pipe. See "Water Supply Requirements".</p>

Service Information

If service is required after checking the troubleshooting guide, call your dealer or authorized service agency. The name of the authorized service agency can be obtained from the dealer or distributor in your area.

When you make a service call, be sure to have the following information handy:

- Model Number
- Serial Number
- Date of Purchase
- Name of dealer from whom purchased

Be ready to clearly describe the problem that you are having with your refrigerator.

If you are unable to obtain the name of an authorized service agency, or if you continue to have service problems, contact Viking Range, LLC at (888) 845-4641 or write to:

**VIKING RANGE, LLC
PREFERRED SERVICE
111 Front Street
Greenwood, Mississippi 38930 USA**

Record the following information indicated below. You will need it if service is ever required.

The serial number and model numbers for your refrigerator are located on the upper wall, behind the lighting:

Model No. _____ Serial No. _____

Date of Purchase _____ Date Installed _____

Dealer's Name _____

Address _____

If service requires installation of parts, use only authorized parts to insure protection under the warranty.

Keep this manual with your refrigerator for future reference.

Warranty

FREESTANDING FRENCH DOOR BOTTOM MOUNT REFRIGERATOR/FREEZER WARRANTY THREE YEAR FULL WARRANTY

Freestanding french door bottom mount refrigerator/freezers and all of their component parts, **except as detailed below**[†], are warranted to be free from defective materials or workmanship in normal residential use for a period of three (3) years from the date of original retail purchase or closing date for new construction, whichever period is longer. Viking Range, LLC, warrantor, agrees to repair or replace, at its option, any part which fails or is found to be defective during the warranty period.

***FULL NINETY (90) DAY COSMETIC WARRANTY:** Product is warranted to be free from cosmetic defects in materials or workmanship (such as scratches on stainless steel, paint/porcelain blemishes, etc.) for a period of ninety (90) days from the date of original retail purchase or closing date for new construction, whichever period is longer. Any defects must be reported to the selling dealer within ninety (90) days from date of original retail purchase. Viking Range, LLC uses high quality processes and materials available to produce all color finishes. However, slight color variation may be noticed because of the inherent differences in painted parts and porcelain parts as well as differences in kitchen lighting, product locations, and other factors. Therefore, this warranty does not apply to color variation attributable to such factors.

†FULL NINETY (90) DAY WARRANTY IN "RESIDENTIAL PLUS" APPLICATIONS: This full warranty applies to applications where use of the product extends beyond normal residential use, but the warranty period for products used in such applications is ninety (90) days. Examples of applications covered by this warranty are bed and breakfasts, fire stations, private clubs, churches, yachts, etc. Under this "Residential Plus" warranty, the product, its components and accessories are warranted to be free from defective material or workmanship for a period of ninety (90) days from the date of original retail purchase. This warranty excludes use of the product in all commercial locations such as restaurants, food service locations and institutional food service locations.

SIX YEAR FULL WARRANTY ON SEALED REFRIGERATION PARTS AS LISTED
Any sealed refrigeration system component, as listed below, is warranted to be free from defective materials or workmanship in normal household use during the fourth through the sixth year from the date of original retail purchase. Viking Range, LLC, warrantor, agrees to repair or replace, at its option, any part which fails or is found to be defective during the warranty period.

Sealed Refrigeration System Components: Compressor, Evaporator, Condenser, Connecting Tubing, Dryer/Strainer

TWELVE YEAR LIMITED WARRANTY ON SEALED REFRIGERATION PARTS AS LISTED
Any sealed refrigeration system component, as listed above, which fails due to defective materials or workmanship in normal household use during the seventh through the twelfth year from the date of original retail purchase will be repaired or replaced, free of charge for the part itself, with the owner paying all other costs, including labor.

TERMS AND CONDITIONS

This warranty extends to the original purchaser of the product warranted hereunder and to each transferee owner of the product during the term of the warranty and applies to products purchased and located in the United States and Canada. Products must be purchased in the country where service is requested. If the product or one of its component parts contains a defect or malfunction during the full warranty period after a reasonable number of attempts by the warrantor to remedy the defect or malfunction, the owner is entitled to either a refund or replacement of the product or its component part or parts. Replacement of a component part includes its free installation, except as specified under the limited warranty. Under the terms of this warranty, service must be performed by a factory authorized Viking Range, LLC service agent or representative. Service will be provided during normal business hours, and labor performed at overtime or premium rates shall not be covered by this warranty.

Owner shall be responsible for proper installation, providing reasonable and necessary maintenance, providing proof of purchase upon request, and making the appliance reasonably accessible for service. The return of the Owner Registration Card is not a condition of warranty coverage. You should, however, return the Owner Registration Card so that Viking Range, LLC can contact you should any question of safety arise which could affect you.

This warranty gives you specific legal rights, and you may also have other rights which may vary from jurisdiction to jurisdiction.

WHAT IS NOT COVERED BY THIS WARRANTY: This warranty shall not apply to damage resulting from abuse, failure to provide reasonable and necessary maintenance, accident, delivery, negligence, natural disaster, loss of electrical power to the product for any reason, alteration, outdoor use, improper installation, improper operation, or repair or service of the product by anyone other than an authorized Viking Range, LLC service agency or representative. This warranty does not apply to commercial usage.

Free Manuals Download Website

<http://myh66.com>

<http://usermanuals.us>

<http://www.somanuals.com>

<http://www.4manuals.cc>

<http://www.manual-lib.com>

<http://www.404manual.com>

<http://www.luxmanual.com>

<http://aubethermostatmanual.com>

Golf course search by state

<http://golfingnear.com>

Email search by domain

<http://emailbydomain.com>

Auto manuals search

<http://auto.somanuals.com>

TV manuals search

<http://tv.somanuals.com>