



# *Freedom Mini-laptop User Guide*



[virginmedia.com](http://virginmedia.com)

VMFNM0609



# Hello there.

Welcome to Virgin Broadband. Thanks to your new Freedom Mini-laptop, you'll be able to get online and explore the web wherever and whenever you want to.

Before you dive in, take a few moments to find out exactly how it works. This booklet will tell you everything you need to know.

## Contents

1. Get to know your Freedom Mini-laptop	4
2. Safety first	6
2.1 LCD screen	6
2.2 Hard Disk Drive (HDD)	6
2.3 Battery pack	6
2.4 Keyboard	7
2.5 Touchpad	7
3. Taking it with you	8
3.1 Things to remember	8
4. Backing up	9
5. Getting started	10
5.1 Installing the battery	10
5.2 Removing the battery	11
5.3 Connecting the AC adapter	11
6. Using your Freedom Mini-laptop	12
6.1 Turning it on	12
6.2 Adjusting the brightness	12
6.3 Using the keyboard	12
6.4 The touchpad	13
6.5 Using your fingers	14
6.6 ClickLock function	14
6.7 Using the card reader	15

7. Internet connection	16
7.1 Connecting to a local network	16
7.2 Setting the network system	16
7.3 Wireless LAN	17
8. Your Freedom Mini-laptop's power	18
8.1 The battery pack	18
8.1.1 Checking your battery's power	18
8.1.2 Charging your battery	19
8.1.3 Low power warning	19
8.1.4 How long will your battery last?	19
8.1.5 Storing your battery	20
8.1.6 Prolonging your battery's life	20
8.2 Power management	21
8.2.1 Standby mode	21
8.2.2 Hibernate mode	21
8.2.3 Logging off	21
9. Adding external devices to your Freedom Mini-laptop	22
9.1 External monitors	22
9.1.1 Connecting an external monitor	22
9.2 Connecting a keyboard or mouse	22
9.3 Connecting audio devices	23
9.4 Lock port	23
10. Using BIOS Setup	24
11. Appendix	26
11.1 Troubleshooting	26
11.2 Specifications	28
11.3 Safety precautions	30
12. Freedom Mini-laptop Collect and Repair Warranty	32
12.1 Customer Services	35

# 1. Get to know your Freedom Mini-laptop

Well here she is. Why don't you two get acquainted.

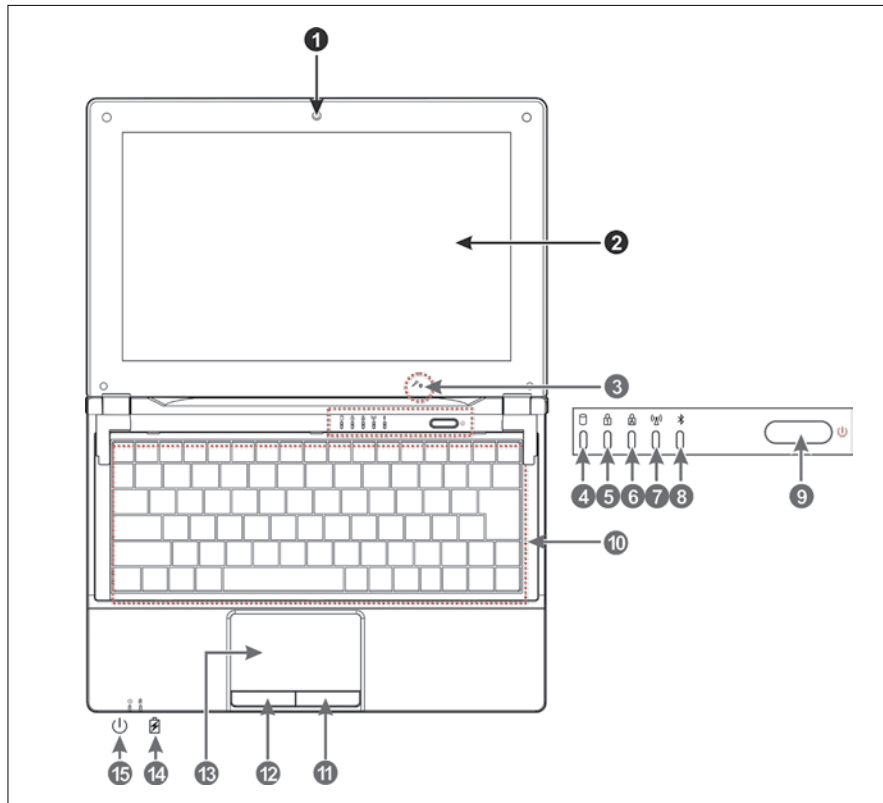

## From above

- |  |   |   |
|--|---|---|
| <ul style="list-style-type: none"> <li>1. Built-in Camera<br/><i>Click Fn+F1 to turn on or off the camera function.</i></li> <li>2. LCD Screen</li> <li>3. Microphone</li> <li>4. Hard Disk Drive Status Indicator Light is green when the Hard Disk Drive is in active mode.</li> </ul> | <ul style="list-style-type: none"> <li>5. Numeric Keypad Indicator<br/><i>Click Fn+NumLk to turn on the light and the numeric keypad is unlocked.</i></li> <li>6. Cap Lock Indicator<br/><i>Light is green when the cap keypad is unlocked.</i></li> <li>7. Wi-Fi/3G Indicator</li> <li>8. Bluetooth Indicator (if fitted)</li> <li>9. Turn me on here</li> </ul> | <ul style="list-style-type: none"> <li>10. Keyboard</li> <li>11. Right key</li> <li>12. Left key</li> <li>13. Touch Pad</li> <li>14. Charge Indicator Light<br/><i>is orange when being charged and is green when the battery is fully charged; light flashes when the battery is weak.</i></li> <li>15. Power Indicator</li> </ul> |
|--|---|---|

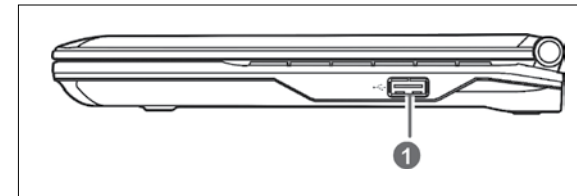

## Right side

- 1. USB Port (2.0)

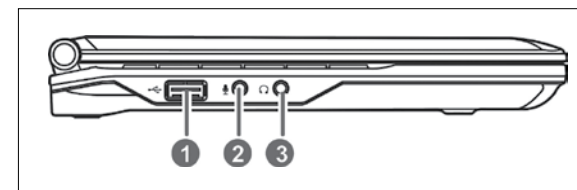

## Left side

- 1. USB Port (2.0)
- 2. Microphone Jack
- 3. Headphone Jack

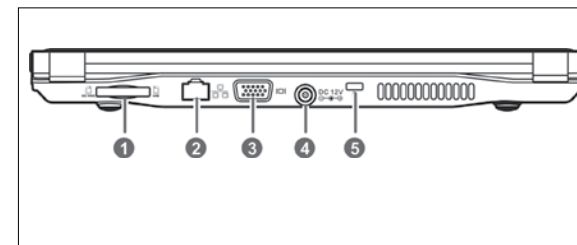

## Rear side

- 1. SD/MMC/MS Port
- 2. Ethernet/LAN Port
- 3. VGA Port
- 4. Power Jack
- 5. Lock Port

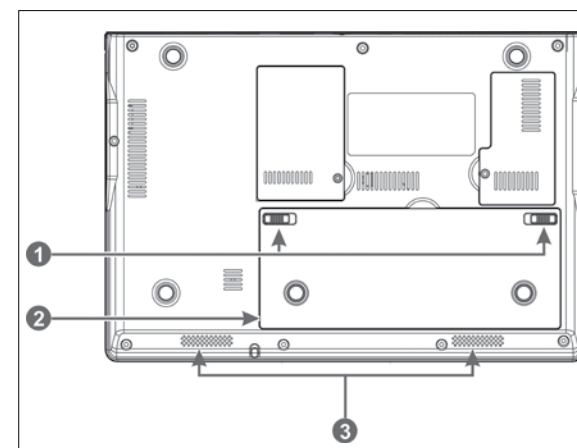

## Underneath

- 1. Battery Latches
- 2. Lithium Rechargeable Battery
- 3. Speakers

## 2. Safety first

*All the different parts and how to look after them.*

### 2.1 LCD screen

The screen is acrylic, but it's one of the most delicate parts of your Freedom Mini-laptop. Here are a few pointers for looking after it:

- Use a clean cloth to wipe the screen, being careful not to scratch it.
- Use a carry case to protect it.
- Open and close your Freedom Mini-laptop gently.
- Be careful not to drop anything on your Freedom Mini-laptop, or spill your tea on it.
- Don't use chemical cleaners, or wipe the screen with your hand.

### 2.2 Hard Disk Drive (HDD)

The Hard Disk Drive is the bit that stores all your data, look after it by keeping your Freedom Mini-laptop steady when in use.

### 2.3 Battery pack

- The battery likes temperatures between 20°C-30°C, anything else may shorten its life.
- The battery will short circuit if punctured or reassembled.
- Don't put the battery near or into the fire – it might explode.
- Your Local Authority will be able to tell you how you can recycle your battery.

### 2.4 Keyboard

It's easy for your keyboard to get grubby, here are a few tips for a spring clean:

- Use a little brush to remove dust from between the keys, then moisten a cloth with water and wipe the keys gently.
- Avoid using too much water – if water seeps into the keyboard, its circuit board could be damaged.

### 2.5 Touchpad

- The touchpad is pressure sensitive, so be careful not to scratch it or rest anything heavy on it.
- If it's dirty, moisten a soft cloth and wipe the pad smoothly.

## 3. Taking it with you

*The great thing about your Freedom Mini-laptop, is that it goes where you go.*

### 3.1 Things to remember

1. Don't forget to charge the battery.
2. Use a carry case to keep it safe.
3. If you're taking your Freedom Mini-laptop in the car, don't leave it in the sun, keep it someplace cool and shady.
4. If you're leaving the country, check the voltage type in the countries you're visiting. Your Freedom Mini-laptop comes with a universal AC adapter, so if anything, you'll only need a power cord to connect the different outlets.
5. Got everything you need? Spare battery, AC adapter, manual? Off you go then.

 It's best not to move the Freedom Mini-laptop while it's running, this could disturb the HDD – put it into standby or hibernation mode first.

## 4. Backing up

*Look after your data.*

While we've tested the Freedom Mini-laptop to make sure all your valuable documents will be safe, always remember to back up your information because there are many impossible to foresee events that could result in disaster. What if your Freedom Mini-laptop is stolen for example, or attacked by a virus?

## 5. Getting started

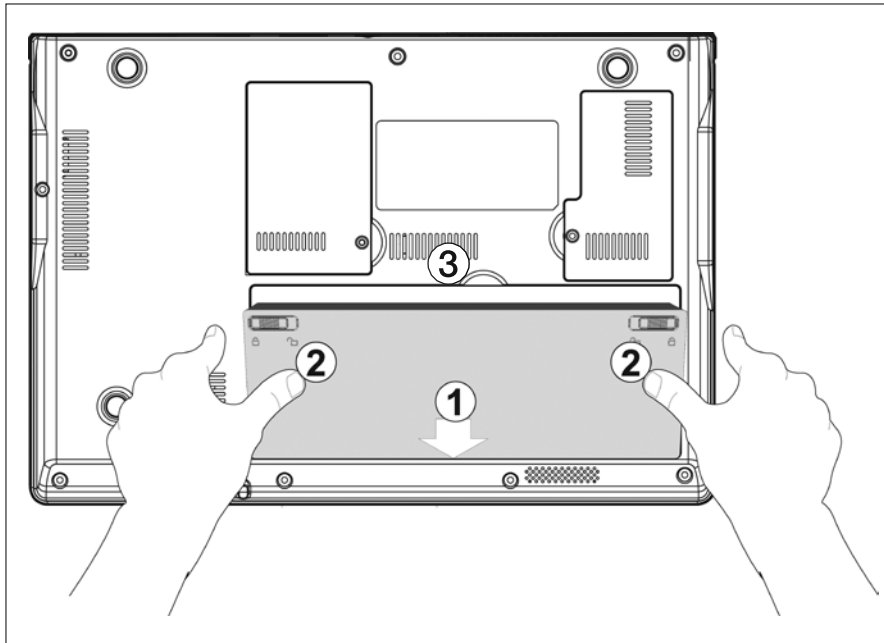

### 5.1 Installing the battery

Before getting started, you'll need to charge your Freedom Mini-laptop. You can power it with the AC adapter or use the removable battery pack.

If your Freedom Mini-laptop doesn't have its battery pack installed when you receive it, simply place the battery pack into the slots on the back of the Freedom Mini-laptop (① as shown above) and then press it down (② as shown above).

### 5.2 Removing the battery

1. First, turn off and unplug your Freedom Mini-laptop.
2. Turn the computer over on a flat clean surface so you can access the base.
3. Slide the battery latches inwards.
4. Pull the battery pack out toward ③ (as shown on the opposite page).



**WARNING!** For safety reasons, don't dismantle the battery pack, or dispose of it in a fire and keep it away from children.

Don't try and remove the battery pack while the Freedom Mini-laptop is turned on as this might result in loss of data.

### 5.3 Connecting the AC adapter

Your Freedom Mini-laptop comes with a universal AC adapter with an input voltage of 100V to 240V.

Follow the steps below to connect the adapter:

5. Connect the adapter to the power cord.
6. Plug the DC end of the adapter into the power jack of the Freedom Mini-laptop (Ⓐ).
7. Insert the AC end into a wall socket (Ⓑ).
8. Check the connections are correct before you turn on your Freedom Mini-laptop.

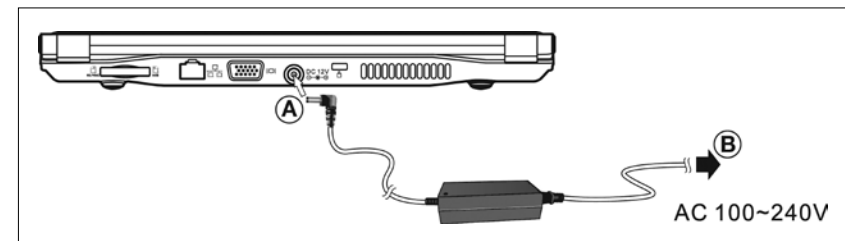

# 6. Using your Freedom Mini-laptop

## 6.1 Turning it on

Simply open up your Freedom Mini-laptop and hit the power button.

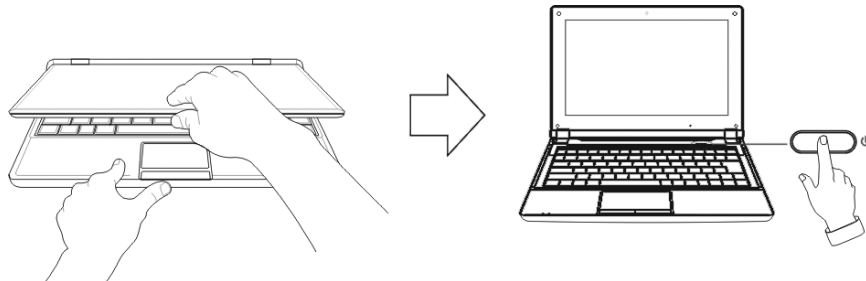

## 6.2 Adjusting the brightness

You can adjust the brightness of the screen using the following buttons:

Click	Function
<Fn>+<F10>	Shifts between the screen and an external monitor
<Fn>+<F11>	Decreases brightness
<Fn>+<F12>	Increases brightness

## 6.3 Using the keyboard

- Press <Fn+NumLk> to enable the keypad – the light indicates that the keypad is active.
- Press <Fn+NumLk> again to disable the keypad.

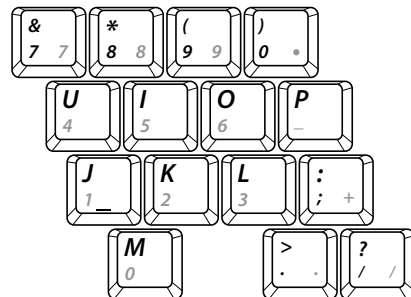

## Function keys

The following functions of these keys will only be activated when you press one of them at the same time as the <Fn> key. Press <Fn+NumLk> again to disable the keypad.











Click	Function
<Fn>+<F1>	Turns the camera window on or off
<Fn>+<F2>	Turns the Wi-Fi on or off
<Fn>+<F3>	Turns the mute on or off
<Fn>+<F4>	Turns the volume down
<Fn>+<F5>	Turns the volume up
<Fn>+<F10>	Shifts between the screen and an external monitor
<Fn>+<F11>	Decreases brightness
<Fn>+<F12>	Increases brightness

## 6.4 The touchpad

Move the cursor by lightly moving your finger across the touchpad. You'll soon get used to it.

## 6.5 Using your fingers

Your touchpad is highly sensitive and has the ability to understand a number of finger movements, which you can use for specific functions like zooming in or out. See below for more examples:

	Gesture	Function		Gesture	Function
	Move fingers apart	Zoom out		Flick right	Forward
	Move fingers together	Zoom in		Flick left	Back
	Slide fingers down	Next page		Move fingers clockwise	Rotate object clockwise
	Slide fingers up	Previous page		Move fingers anti-clockwise	Rotate object anti-clockwise

## 6.6 ClickLock function

ClickLock allows you to highlight or drag without having to keep the mouse button held down. To activate ClickLock:

1. Move the cursor to the  icon on the bottom right corner of the desktop screen, and right click on it, then select 'Settings' to enter the 'Mouse Properties' menu as shown (opposite).



2. Click the box by 'Turn on ClickLock' and then click 'Setting' to adjust the amount of time you need to hold down the mouse button before your click is 'locked'.



3. Click 'OK' to return to the 'Mouse Properties' menu and click 'Apply' followed by 'OK' to activate the ClickLock function.

4. Now the function is activated the mouse will lock after your designated amount of time, allowing you to drag this folder, for example, without holding down the mouse key. Click the right button of the mouse to drop the document or folder in its new position.



## 6.7 Using the card reader

Your Freedom Mini-laptop has a built-in memory card reader that's compatible with the following cards: Secure Digital, Multi-Media Card, Memory Stick. Your card manual provides more information.

The card can only be inserted in one direction (with the card's electrical contacts facing down). Forcing it may result in damage. To remove the card, stop its operation and pull it from the port.

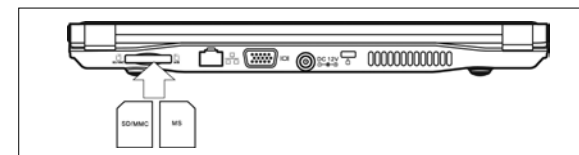



# 7. Internet connection

## 7.1 Connecting to a local network

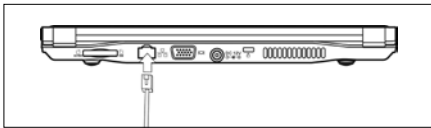

- When connecting to a network, make sure the network system is set up first, before connecting the LAN line to your Freedom Mini-laptop.

## 7.2 Setting the network system

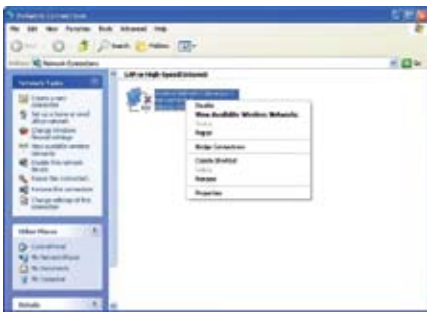

- Click on 'My Network Places', then left click on 'Properties' to enter the 'Network Connections' window, as shown left.

 Contact your Internet service provider for more information about the setting of IP and DNS.



- Right-click on 'Local Area Connections' then left click on 'Properties' to display the menu of 'Local Area Connection Properties', as shown left.
- On the 'Local Connections Properties' menu, left click on 'Internet Protocol (TCP/IP)', then left click on 'Properties' to enter the 'Internet Protocol TCP/IP Properties' window.
- Select 'General' and enter the address of your IP and DNS (Domain Name), or select 'Obtain an IP address automatically'.

## 7.3 Wireless LAN



- Click <Fn>+<F2> to switch your wireless network on or off. When your wireless network is on, the Wi-Fi indicator turns green and the Wi-Fi icon is displayed on the bottom right of the desktop.



- Right click your mouse on the Wi-Fi icon, then left click on 'View Available Wireless Networks' on the pop-up menu or double left click on the Wi-Fi icon to enter the 'Wireless Network Connection' window as shown left.



- To see the available wireless networks, simply left click on 'Refresh' and a list will be displayed. You can find out more about each of the wireless networks shown by selecting them with your mouse. Some networks are likely to ask you for a password before you can connect to them.

# 8. Your Freedom Mini-laptop's power

## 8.1 The battery pack

Your Freedom Mini-laptop is designed to work wherever and whenever you need it thanks to its removable, high capability battery pack.

### 8.1.1 Checking your battery's power

- To see how much power your battery has remaining, click on 'Start', then on 'Control Panel', and then double click on 'Power Options'. This will display the 'Power Options' window. From there clicking on the 'Power Meter' icon will display how much power your battery has left.

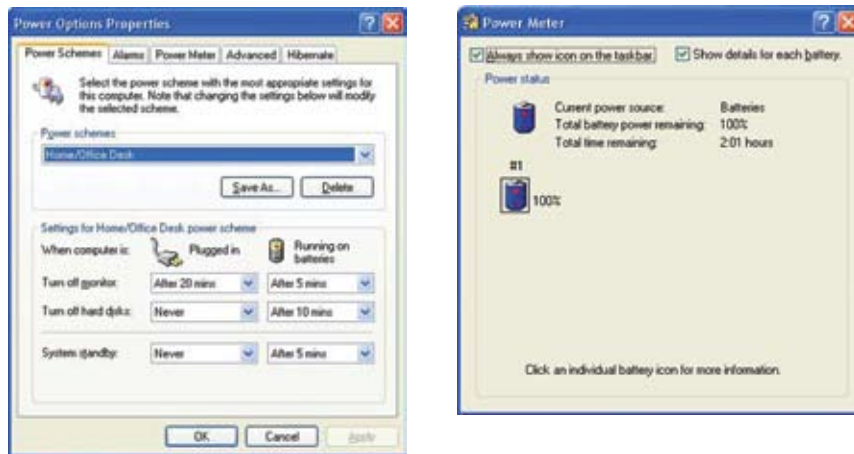

- To create a shortcut so you can always keep an eye on remaining battery power, click on 'Advanced' in the 'Power Options Properties' window, then select 'Always show icon on the taskbar'. The battery icon will then always appear bottom left on your desktop. To see how much battery power you have, simply move the cursor over this icon.



A battery pack can only be recharged so many times and over time its capacity will decrease. When the time comes to replace the battery with a new one, you can purchase a replacement battery by calling 0800 952 2294.



The battery should be fully charged before you use your Freedom Mini-laptop for the first time, so be sure to check the battery power before you get started.



Don't attempt to remove the battery pack while your Freedom Mini-laptop is switched on, this may result in loss of data or even damage the Freedom Mini-laptop itself.

### 8.1.2 Charging your battery

The first time you use your Freedom Mini-laptop, make sure you charge the battery pack to full capacity before you switch it on.

The battery pack will start charging as soon as your Freedom Mini-laptop is connected to a power supply, and the charge indicator light will come on. When the battery pack is fully charged it will stop charging automatically and the charge indicator light will go out.

### 8.1.3 Low power warning

When battery power is running low your Freedom Mini-laptop will let you know with an onscreen window advising you to recharge. Don't forget to save whatever you're doing if you don't have your AC adapter to hand at that point.

### 8.1.4 How long will your battery last?

The amount of time your battery will last is difficult to say precisely. It depends on a number of factors, including how you use your Freedom Mini-laptop, and perhaps most importantly, how you use its power saving features. You can help it to last longer by switching on its manage power function.

## 8.1.5 Storing your battery

It's best not to leave your battery fully discharged in your Freedom Mini-laptop for any length of time. If you're not using your Freedom Mini-laptop for a while, you should remove the battery and store it separately. Ideally, the battery should be stored at a temperature between 10°C and 35°C. Temperatures above or below this range may shorten its life. Exposing the battery to very high temperatures could result in fire or explosion.

## 8.1.6 Prolonging your battery's life

- Use the AC adapter whenever an external power source is available. Remember to fully charge the battery before you rely on it as a power source for any length of time.
- Your battery is at its most efficient between temperatures of 20°C and 30°C. Temperatures above and below these figures will shorten the battery's actual usage time.
- Please charge your battery at least once every three months or damage may occur.
- The life expectancy of your battery is approximately 300 recharges. It's a good idea to buy an extra battery as a backup ready to replace the original as soon as necessary.
- When removed from your Freedom Mini-laptop, store the battery in a cool and dry place, preferably at a temperature between 10°C and 30°C.
- Decrease the brightness of your LCD screen. You can also close the screen down if you're not using your Freedom Mini-laptop for a while.



Your battery is likely to short circuit if it's punctured or you attempt to take it apart.



Remember, that your Freedom Mini-laptop should never be disposed of as everyday waste. Check with local authorities to see how to dispose of electrical products. Never place your battery in or close to a fire, as it may explode.

## 8.2 Power management

### 8.2.1 Standby mode

- In standby mode, your Freedom Mini-laptop is conserving energy, but ready to operate again within a few seconds. Current data and status is stored in its RAM and the screen shut down, while the power indicator light remains on. Simply press the power button to get it to start up again.

### 8.2.2 Hibernate mode

- In hibernate mode, your Freedom Mini-laptop saves your current status and data to the hard disk before shutting down. In this mode the power indicator light is off. To restart your system, just press the power button. You can also initiate hibernate mode yourself. Click on 'Hibernate' within the 'Power Options Properties' window, then select 'Enable Hibernate'.

### 8.2.3 Logging off

- To log off from your Freedom Mini-laptop, click on 'Start', then select 'Turn Off Computer'.
- Your Freedom Mini-laptop will log itself off if it's running on battery power and that runs out while it's in standby mode. If this happens, you won't lose any data – this will be stored on the hard disk drive. Your Freedom Mini-laptop will operate again, once the battery is recharged or it's connected to an AC outlet.



If your system crashes at any time, you can turn your Freedom Mini-laptop off by pressing the Power button for 4 seconds. Pressing the Power button for over 2 seconds will also turn your Freedom Mini-laptop off in normal mode.

# 9. Adding external devices to your Freedom Mini-laptop

## 9.1 External monitors

- Your Freedom Mini-laptop has a dedicated VGA port for connecting an external monitor or other screen.

### 9.1.1 Connecting an external monitor

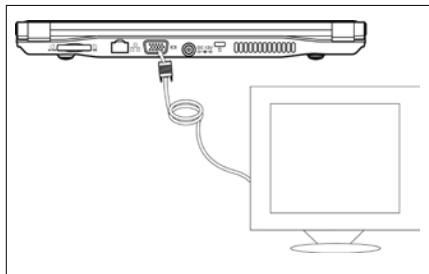

1. Turn off your Freedom Mini-laptop.
2. Insert the monitor's 15-pin D-sub monitor plug into the VGA port shown left.
3. Turn on your Freedom Mini-laptop again.

**i** You can shift between viewing on your Freedom Mini-laptop's screen and an external monitor by click <Fn>+<F10>.

## 9.2 Connecting a keyboard or mouse

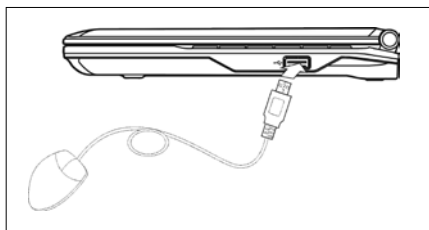

- Your Freedom Mini-laptop has an integrated UK standard keyboard with 82 keys. However, if you prefer to use an external keyboard or mouse, you can connect them via the USB port.

**!** When disconnecting an external keyboard or mouse from your Freedom Mini-laptop, please take care to grasp the connector itself rather than the cable, and pull firmly but gently to avoid damaging the cable.

## 9.3 Connecting audio devices

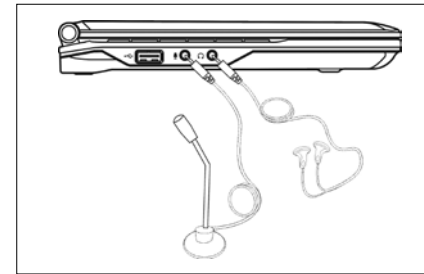

- You can connect headphones, speakers and microphones to your Freedom Mini-laptop via the connections indicated in the picture (left).

**i** Your Freedom Mini-laptop's integral speaker will turn off automatically when you connect headphones. Take care, though – sound levels that are comfortable on speakers can be excessively high in headphones. To avoid any chance of hearing damage, turn down the volume before putting on headphones and then raise the volume to a comfortable level once you have them on.

## 9.4 Lock port

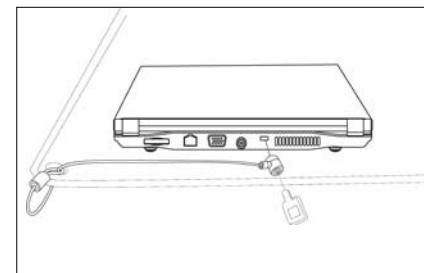

- You can secure your Freedom Mini-laptop to a desk or other immovable object by attaching a security cable to its integral lock port.

# 10. Using BIOS setup

Follow the simple steps below to enter the BIOS Setup Menu:



1. When you turn on your Freedom Mini-laptop, click the F2 button quickly as the system starts up. You should then access the 'Setup Utility' screen.

2. Use the arrow keys to select 'Boot', then click 'Enter' to get to the menu.

5. Click 'Shift' and the '+' or '-' keys to remove the option position and then use the arrow keys to select where you want the system to start up from. Once your selection is highlighted, click F10 to bring up a pop-up and click on 'Yes'.

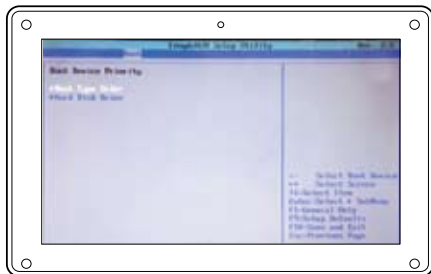

3. Use the arrow keys to select 'Legacy' and click 'Enter' to get to the menu.

4. Use the arrow keys to select 'Boot Type Order' and click 'Enter' to get to the menu.



Once you've carried out the sequence above you can switch to your temporary start up option simply by clicking F12 as soon as you turn on your Freedom Mini-laptop.

# 11. Appendix

## 11.1 Troubleshooting

### 1. My Freedom Mini-laptop's locked up and I can't turn it off.

Just press and hold the power button for 4 to 6 seconds and your Freedom Mini-laptop will shut down.

### 2. Is there anything I should check if my Freedom Mini-laptop locks up?

You can try:

- checking whether the power is low, and, if it is, connect to an AC outlet
- checking that you haven't switched the screen to the external monitor mode
- making sure that the indicator light of your AC adapter is on and your adapter is working properly
- removing any memory cards and any other external device.

### 3. What should I do if I spill liquid on my Freedom Mini-laptop?

You should:

- turn off your Freedom Mini-laptop by disconnecting the AC adapter and detaching its battery pack, rather than using the power button disconnect all external devices
- drain all the liquid you can from your Freedom Mini-laptop and then remove any remaining moisture so far as possible with a soft, dry cloth
- use a fan, if you have one, to help you dry your Freedom Mini-laptop and accessories
- ask for further advice at our Customer Support Centre, on 0800 952 2294.

### 4. I'm unable to restart my Freedom Mini-laptop after it has entered standby mode.

- If your Freedom Mini-laptop is in standby mode you should be able to restart it by pressing the power button. In standby mode the power indicator light remains on.
- Your Freedom Mini-laptop may have entered hibernate mode, indicated by the power indicator light flashing. Again, you should be able to restart it by pressing the power button.
- If you're still unable to restart, please contact our Customer Support Centre on **0800 952 2294**.

### 5. I can't get my Freedom Mini-laptop to start up. What might be causing a problem?

It could be:

- damage to your external or built-in memory, perhaps caused when an error has been saved to it, corrupting data
- an incompatible external device may cause your system to enter standby mode until it's removed
- an error in the drive programme or application programme: Your system may refuse to operate some files (files with the suffixes: .dll, .sys, .exe and so on) and enter standby or hibernate mode.

### 6. Is there anything I can do to recover my Freedom Mini-laptop when it's failing to start up?

You can try the following:

- remove any external devices and their associated software
- refresh the BIOS Setup (see Section 10)
- refresh the appropriate programme
- remove any application programmes causing problems
- reinstall the operating system.

If none of the above help, please send your Freedom Mini-laptop to your local service centre for repair.

### 7. When I use my Freedom Mini-laptop's camera the image is very unclear.

Check the built-in lens. If it's dirty try cleaning it with a soft, dry cloth.

### 8. When I use my Freedom Mini-laptop's video camera function, the images it produces are jerky and slow-moving.

- The video camera requires light to function effectively and the images it produces may be adversely affected by poor light conditions. Try adjusting the position of your Freedom Mini-laptop or of its subject to make the most of the available light.
- The image display may also be slowed down if you have a lot of other applications running. Closing any unnecessary applications may improve the image.

## 11.2 Specifications

Design and specifications are subject to change without notice.

Main Feature	
CPU	Intel Atom N270 (1.6GHz, 533MHz FSB)
CPU Power Consumption	2.5W MAX
L1 Cache Size	On-die, primary 32-kB instructions cache and 24-kB, write-back data cache
L2 Cache Size	512-kB on-die second level cache
Memory	1GB
Memory Type	DDRII 533MHz
Storage	
HDD Capacities (#)	120GB
Screen	
Screen Size	10.2"
Screen Type	TFT
Description	TFT LCD 1024X600 (WSVGA)
Built-in Camera	
Resolution	0.3 megapixel
Video/Audio Feature	
Video Card Type	Intel GMA 950
Video Card Capacity	Share Dynamic EMS Memory 128MB (max)
Audio System	Built-in speaker
Sound Card Type	HD Codec

Note: As a power saving feature the unit defaults to Wi-Fi disabled when starting up to conserve battery life. To switch it on press F2.

I/O Device	
Mouse	Touch Pad
Keyboard	UK 82-key keyboard
Condition	
Operating Temperature	5-35°C
Operating Humidity	35%-85%
Storage Temperature	-20-55°C
Storage Humidity	20%-93%
Power	
Adapter	AC 100~240V; DC 12V
Output Power (maximum)	≤36W
Battery (Type)	Lithium rechargeable battery
Voltage	7.4V
Port Standard	
LAN	LAN Type: 10/100Base-T Wireless Card: 802.11 b/g/n
Audio Port	Headphone Port, Speaker, Built-in Microphone, Microphone Port
USB Port	USB-A Port (x2), USB2.0
SD Card Port	Support SD/MMC/MS Card
VGA Port	D-15 Output
Physical Features	
Weight	No Battery With Battery
	About 0.9Kg About 1.1Kg
Dimensions	266*182*29mm (w*h*d)

## 11.3 Safety precautions

1. Don't press or touch the LCD screen. You may scratch or damage it.
2. Keep your Freedom Mini-laptop away from dirty or dusty environments as dust and other small particles can get inside and cause damage.
3. Don't place your Freedom Mini-laptop on uneven or unstable work surfaces.
4. Don't place or drop heavy objects on top of your Freedom Mini-laptop or insert any foreign objects into it.
5. Don't allow your Freedom Mini-laptop to be exposed to strong magnetic or electrical fields.
6. Don't allow the sun to shine directly onto your LCD screen as it may damage it.
7. Your Freedom Mini-laptop should only be used in environments with ambient temperatures between 5°C (41°F) and 35°C (95°F).
8. Don't expose your Freedom Mini-laptop to or use near liquids, rain, or other moisture.
9. Caution: there is a risk of explosion if the battery is replaced with an incorrect type. Dispose of used batteries according to the instructions.
10. Don't throw your Freedom Mini-laptop away in a standard rubbish collection. Check local regulations for the correct disposal of electrical products.
11. Please recycle the battery pack. Check with your local authority or retailer for recycling advice.
12. Your Freedom Mini-laptop and its AC adapter may produce some heat when operating or charging. To prevent discomfort or possible injury from heat exposure, it's best not to use your Freedom Mini-laptop on your lap or have it in prolonged contact with any other part of your body.
13. Input rating: Refer to the rating label on your Freedom Mini-laptop and make sure that your AC adapter complies with it. Only use attachments and accessories specified by the manufacturer.
14. Check the connections between your Freedom Mini-laptop and attached devices before turning it on.
15. Don't eat while using your Freedom Mini-laptop as dropping food on it may cause damage.
16. Always turn your Freedom Mini-laptop off if you want to install or remove external devices which don't support hot-plugging.
17. Disconnect your Freedom Mini-laptop from its AC outlet and remove any installed batteries before cleaning.
18. Keep your Freedom Mini-laptop away from younger children.
19. Repairs should only be carried out by a certified service technician as, otherwise, the manufacturer cannot be held responsible for any resulting damage.
20. Only use battery packs approved by the manufacturer or your Freedom Mini-laptop may be damaged.
21. Don't place your Freedom Mini-laptop on soft objects (e.g. bed, sofa or your lap) as this may block the heat dispersing vents and cause the computer to overheat and shut down.



# 12. Freedom Mini-laptop Collect and Repair Warranty

## 1. What this warranty covers

**1.1** We warrant that each Freedom Mini-laptop is free from defects in materials and workmanship under normal use during the warranty period. The warranty period for the Freedom Mini-laptop starts on the original date of delivery to you (the Customer) for a period of 12 months for everything except the battery, unless we inform you otherwise in writing. A 6 month warranty period is included against the battery from the original date of delivery to you.

**1.2** This warranty is offered as a collect and return service. Only the cost of the parts and labour involved in servicing any eligible repairs under this warranty are covered.

**1.3** This warranty also covers the cost of shipping to and from mainland UK and Northern Ireland addresses for all eligible repairs.

**1.4** This warranty also includes a technical support service via telephone for the full duration of the warranty. Call on 0800 952 2294. Support is available between the hours of 9.00am to 5.30pm on Business Days. ('Business Days' means a day not being Saturday or Sunday). This technical support service only provides support on the Freedom Mini-laptop and software installed on the Freedom Mini-laptop supplied by us.

## 2. How to get warranty service

**2.1** If the Freedom Mini-laptop does not function as warranted during the warranty period, you may obtain warranty services by dialling the number detailed above. The warranty service is only available in the UK, therefore additional charges (for cost of shipment) may apply for warranty claims outside of the UK.

## 3. What we will do to correct problems

**3.1** Where a Freedom Mini-laptop received by you does not work on arrival or within 28 days of the date of delivery, we will arrange for collection and replacement of the Freedom Mini-laptop at our cost. We will supply you with a replacement, or where there is no branded Freedom Mini-laptops in stock, with either a functionally equivalent or superior specification Freedom Mini-laptop.

**3.2** We will attempt to diagnose and resolve your problems over the telephone or e-mail. We may direct you to download and install designated software updates. If you contact us about a software issue i.e. an issue with the pre-installed software on the Freedom Mini-laptop, we shall direct you to the correct third party software provider for assistance.

**3.3** Some problems can be resolved with a replacement part that you can install yourself called a "Customer Replaceable Unit" or "CRU". If so, we will ship the CRU to you for you to install. You are given the opportunity to call us back and we will take you through the installation process or arrange for you to send the Freedom Mini-laptop back to complete the install.

**3.4** If the problem cannot be resolved over the telephone or remotely, through your application of software updates (which we will guide you through) or the installation of a CRU by you, we will arrange for service of the Freedom Mini-laptop at a third party UK repair centre. For warranty claims within mainland UK we will bear the costs of shipment to and from our warranty repair centre.

**3.5** If we determine that we are unable to repair the Freedom Mini-laptop, we will replace it with one that is at least functionally equivalent.

**3.6** If we determine that problems are as a result of Customer misuse, improper maintenance, accidents, modifications, unsuitable physical operating environments, power surges or natural disasters, our third party repair centre will offer to repair the Freedom Mini-laptop at a set price to you of £110 including vat and delivery charges.

Service levels:

**3.7** All technical support requests will be brought to a point of resolution within 24 hours of the initial fault being reported by you (excluding weekends and bank holidays). By resolution we mean either the fault is fixed or a time has been arranged with you to pick up the Freedom Mini-laptop to come back in for repair.

**3.8** Repairs will be carried out within a ten (10) Business Day timescale and will return the Freedom Mini-laptop to you within such timescale.

## 4. Replacement of Freedom Mini-laptop or part

**4.1** When the warranty service involves the replacement of a Freedom Mini-laptop or part, the replaced Freedom Mini-laptop or part goes back into the stock holding and the replacement Freedom Mini-laptop or part becomes your property.

**4.2** Only unaltered Freedom Mini-laptops and parts are eligible for replacement. For the purposes of this clause 'unaltered' means no hardware alterations have been made to the Freedom Mini-laptop by you. The replacement Freedom Mini-laptop or part provided may not be new, but it will be in good working order and at least functionally equivalent to the original Freedom Mini-laptop or part. The replacement Freedom Mini-laptop or part shall be warranted for the balance of the period remaining on the original Freedom Mini-laptop.

**4.3** Customer Responsibilities: Before we replace a Freedom Mini-laptop or part, you agree to:

1. remove all features, parts, options, alterations, and attachments not under warranty service;
2. ensure that the Freedom Mini-laptop or part is free of any legal obligations or restrictions that prevent its replacement; and
3. authorise us to service a Freedom Mini-laptop or part.

## 5. Additional customer responsibilities

Where applicable, before service is provided, you agree to:

1. follow the service request procedures that we specify;
2. backup or secure all programs and data contained in the Freedom Mini-laptop;
3. provide us with all system keys or passwords to perform the warranty service; and
4. ensure that all information about identified or identifiable individuals ("Personal Data") is deleted from the Freedom Mini-laptop or that, with respect to any Personal Data that you do not delete, you are in compliance with all applicable laws.

## 6. Use of personal information

**6.1** If you obtain services under this warranty, we will store, use and process information about your warranty service and contact information, including name, phone numbers, address, and e-mail address. We will only use this information to perform service under this warranty. We will only disclose customer information where required by law.

## 12.1 Customer Services

Call **0800 952 2294** to speak to one of our team (phone line open Monday to Friday 9am to 6pm excluding Bank holidays).

### 7. What this warranty does not cover

This warranty does not cover the following:

- uninterrupted or error-free operation of a Freedom Mini-laptop;
- loss of, or damage to, your data;
- any software programs, that were not provided with the Freedom Mini-laptop by us installed subsequently;
- failure or damage resulting from misuse, accident, modification, unsuitable physical or operating environment, natural disasters, power surges, or improper maintenance by you;
- damage caused by a non-authorized warranty service provider;
- return shipping costs for non-eligible warranty repairs of which you will be informed
- failure of, or damage caused by, any third party Freedom Mini-laptop, software, peripherals or components.

This warranty is voided by removal or alteration of identification labels on the Freedom Mini-laptop or its parts.

### 8. Limitations

**8.1** We are only responsible for loss or damage to the Freedom Mini-laptop while it is: 1) in our possession; or 2) in transit in those cases where we are responsible for the transportation.

**8.2** We are not responsible for any data including confidential, proprietary, or personal data contained in/on the Freedom Mini-laptop. You should remove and/or backup all such information from the Freedom Mini-laptop prior to its service or return.

**8.3** Under no circumstances shall we be liable for any of the following even if informed of their possibility: 1) third party claims against you for damages; 2) loss or damage to your data; or 3) special, incidental, indirect or consequential damages, including lost profits, business revenue, goodwill or anticipated savings.

## Free Manuals Download Website

<http://myh66.com>

<http://usermanuals.us>

<http://www.somanuals.com>

<http://www.4manuals.cc>

<http://www.manual-lib.com>

<http://www.404manual.com>

<http://www.luxmanual.com>

<http://aubethermostatmanual.com>

Golf course search by state

<http://golfingnear.com>

Email search by domain

<http://emailbydomain.com>

Auto manuals search

<http://auto.somanuals.com>

TV manuals search

<http://tv.somanuals.com>