

VISART®

OPERATION INSTRUCTIONS
10.4" PORTABLE TV with built-in multimedia Card Player

Shanghai Visart Technologies Co.,Ltd.

Dear Customer:

Welcome to the splendid Portable TV. Now you may enjoy new visual experiences and surprises from the marriage of advanced digital technology and new life philosophy. To fully apply the product, please read the manual carefully and keep it for later reference.

Table of Contents

Check List	
1. Introduction	1
2. Safety Precautions	1
3. Installation Instructions	1-4
3.1 Single Frame	1-3
3.2 Double Frame	3-4
4. Remote Control Guide	4-6
5. Setup Menu	6-11
5.1 SETUP MENU - MAIN PAGE	6-7
5.2 SETUP MENU - PHOTO	7
5.3 SETUP MENU - MUSIC	8
5.4 SETUP MENU - SLIDE SHOW	8-9
5.5 SETUP MENU - MOVIE	9
5.6 SETUP MENU - PREFERENCES PAGE	9-11
5.7 SETUP MENU - EXIT SETUP	11
6. OSD Setup Guide	11-15
6.1 AV Mode	11-13
6.1.1 VIDEO ADJUST	11-12
6.1.2 OSD ADJUST	12
6.1.3 INPUT SELECT	12-13
6.1.4 AUDIO	13
6.1.5 LANGUAGE SELECT	13
6.1.6 EXIT	13
6.2 TV Mode Settings	14-15
6.2.1 TV FUNCTION	14
6.2.2 TV MODE	15
7. TV Operation	15-16
7.1 AUTO CHANNEL SEARCH	15
7.2 CHANNEL SELECTION	15
7.3 DISPLAY CHANNEL	16
7.4 CHANNEL RECALL	16
8. AV Input/Output User Instruction	16
9. Product Specifications	17

Check List

When you open the box, make sure the following components are not missing.

- 1) Portable TV (1)
- 2) TV Stand (1)
- 3) Remote Control (1)
- 4) AV Cable (1)
- 5) CATV Cable (1)
- 6) Headphone (1)
- 7) Power Supply (1)
- 8) Warranty Card (1)
- 9) User Manual (1)

If you have any questions, please contact the retailer.

1 Introduction

10.4" Portable TV supports:
JPEG picture file.

WMA, MP3 sound files.

MPEG1, MPEG2 video files.

Background sound playing

13 different picture playing Modes.

CF, SM, MS, MSPRO, SD, MMC, IBM MICRODRIVE seven types of memory cards.

AV Input/Output

TV

Remote control support.

2 Safety Precautions

Please be aware of the following precautions.

1. Handle it carefully. Place machine on a soft cloth or surface before installation in order to prevent for scratches.
2. Spray a little of cleaner on soft cloth and wipe the panel.
3. Do not block the vent to prevent overheating.
4. Never disassemble or perform self-maintenance and repair, since opening or removing cover plate may cause high-voltage electric shock or other dangers. Have a qualified technician perform all product maintenance.

3 Installation Instructions

3.1 SINGLE FRAME

1. Front View (Fig. 1) :

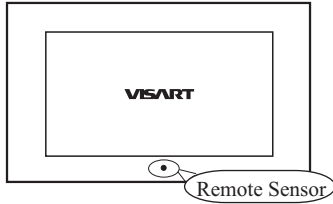

Fig. 1

2. Top View (Fig. 2) :

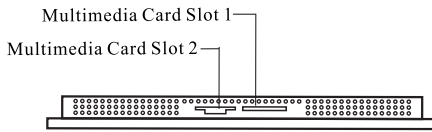

Fig. 2

Two slots for CF, SM, MS, MS PRO, SD, MMC, IBM MICRODRIVE: 7 types of memory cards supports.

3. Back View (Fig. 3) :

- Wall Hanging: can install onto the surface of a wall. Table Stand: use the stand to support the Portable TV for weight support.

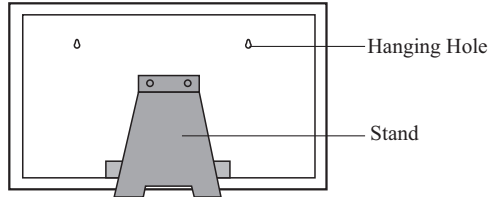

Fig. 3

• Input/output Introduction (Fig. 4) :

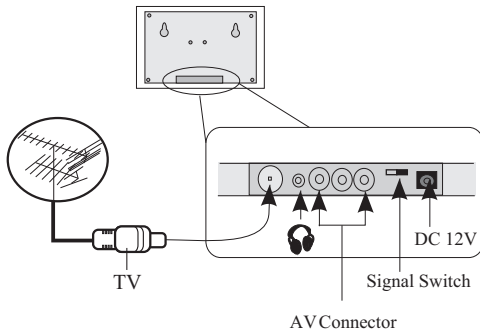

Fig. 4

- TV cable :Connect CATV cable orTV Antenna Cable toTV terminal.
- 🎧 : Headphone Input(Sound export) , can connect toheadphone.
- AV input: Connects with AV cable andmatch the cablewith the correctcolor input.
- Signal switch: switchAUDIO andVIDEO signal input/output.
- DC12V: Powerinput , install the powercord into theDC12V input.

4. Button Instructions (Right-hand side) (Fig. 5) :

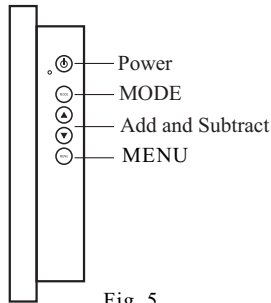

Fig. 5

Instruction :

- Power: on/off switch.
- MODE: Mode change, can switch TV, MEDIA PLAYER, AV.
- Add, Subtract: Multifunction support
 1. Before selecting any option, press "Add and Subtract" buttons for volume control
 2. Under TV, the buttons are for TV channel switch.
 3. Under OSD menu, the buttons are for selecting menu options and adjustments.
- MENU: Highlight OSD menu.

3.2 DOUBLE FRAME

1. Front View (Fig. 6) :

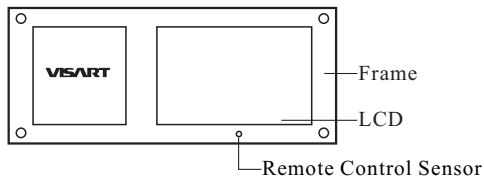

Fig. 6

2. Side View (Fig.7) :

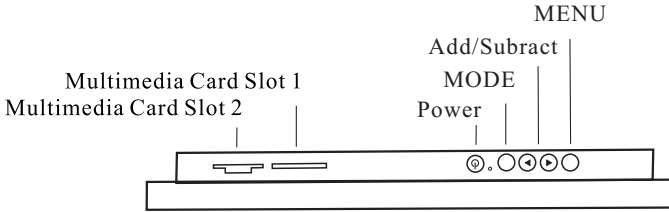

Fig. 7

Two slots for CF, SM, MS, MS PRO, SD, MMC, IBM MICRODRIVE: 7 types of memory cards supports.

Buttons instruction please go back to Single Frame Album instruction.

3. Digital Album display setup: (Review Single Frame Album for installation instruction)

- Wall setup : (hang horizontally) Able to hang on the wall
- Table setup : same as the Single Frame Album.

4. Back View (Fig.8) :

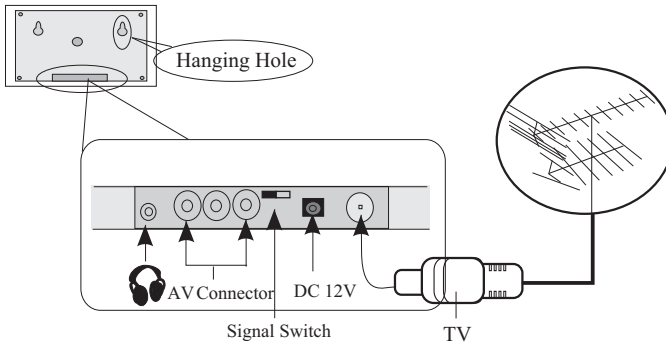
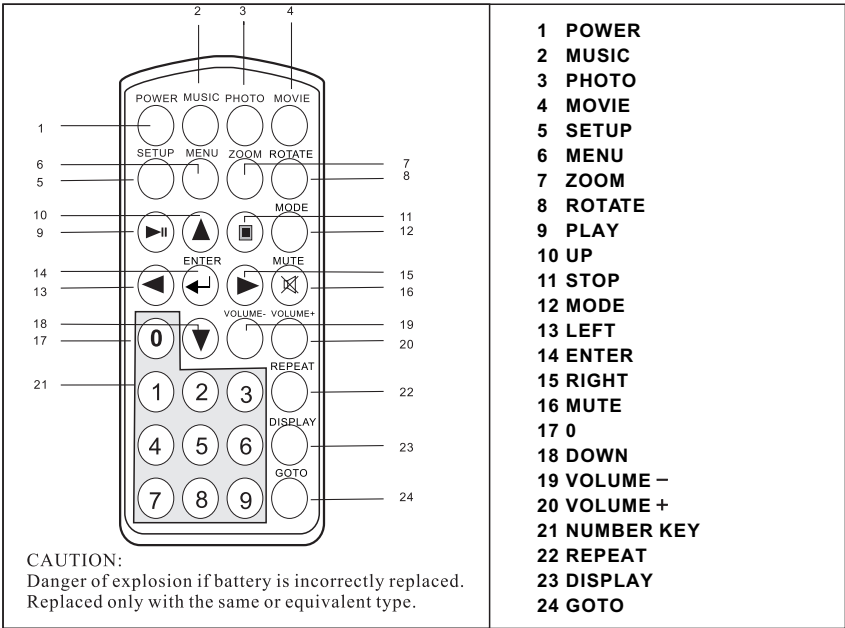

Fig. 8

- : Headphone Input (Sound export), can connect to headphone.
- AV input: Connects with AV cable and match the cable with the correct color input.
- Signal Switch: switch AUDIO and VIDEO signal input/output.
- DC 12V: Power input , install the powercord into the DC 12V input.
- TV cable: Connect CATV cable or TV Antenna Cable to TV terminal.

4 Remote Control Guide



- 1 POWER
- 2 MUSIC
- 3 PHOTO
- 4 MOVIE
- 5 SETUP
- 6 MENU
- 7 ZOOM
- 8 ROTATE
- 9 PLAY
- 10 UP
- 11 STOP
- 12 MODE
- 13 LEFT
- 14 ENTER
- 15 RIGHT
- 16 MUTE
- 17 0
- 18 DOWN
- 19 VOLUME -
- 20 VOLUME +
- 21 NUMBER KEY
- 22 REPEAT
- 23 DISPLAY
- 24 GOTO

- 1 POWER Press it to turn the machine on or off
- 2 MUSIC In selection menu, press the "MUSIC" key will select the music files. If do not select any files, then system will automatically play the first music file. (Media Player Mode)
- 3 PHOTO In selection menu, press the "PHOTO" key will select the picture files. If do not select any files, then the system will automatically play the first picture file. (Media Player Mode)
- 4 MOVIE In selection menu, press the "MOVIE" key will select the movie files. If do not select any files, then the system will automatically play the first movie file. (Media Player Mode)
- 5 SETUP Press for setup menu. Press setup again to exit the setup menu. (Media Player Mode)
- 6 MENU Press it to setup the System.
- 7 ZOOM Under the play selection, if the picture size does not match with the frame, then use the "ZOOM" button to enlarge the picture. Press once for double the size, twice for triple the size, three times for four times the size, and four times for the original size. After enlarging the picture, use the "▲▼◀▶" for surface adjustments.
- 8 ROTATE Under the play selection, use the "ROTATE" key for picture rotation. Rotate key only works under PHOTO menu.
- 9 PLAY
 - 1. Play and pause function. (Media Player Mode)
 - 2. When playing a picture and a music at the same time. Press once to stop playing the picture, press twice to stop both picture and music playing, and press three times to restore playing.
- 11 STOP Under play mode, press on the "STOP" button to stop playing. (Media Player Mode)
- 12 MODE Switch Picture display modes. There are 13 different display modes.
- 10/18 UP/DOWN In OSD menu, up and down switch. (▲▼)
- 13/15 LEFT/RIGHT In OSD menu, left and right switch. (◀▶), In setting, press for increase and decrease adjustment.

14 ENTER	Select an option from a menu.
16 MUTE	Mute (Sound off).
19/20 VOLUME	Volume control.
17/21 NUMBER ±	Numbers: from 0 to 9. Under media play selection, can press the number to select files, such as MP3, JPEG, WMA, MPEG files. Under TV mode, use the numbers for channel selection. Press Enter for instant channel change. (Or wait 2 seconds for auto channel change)
22 REPEAT	Under media play selection, press REPEAT to have MP3, MPEG or picture files repeat its play function.
23 DISPLAY	Under media play selection, use the DISPLAY key to have picture and music to play at the same time (Background music).
24 GOTO	In Photo, music, video, or file, user can switch between these 4 modes. As shown under the picture below.



Fig. 9

5 Setup Menu

Playing multimedia Files

1. Go back to product description for instruction on how to insert memory card onto the slots.

Reminder : Support CF, SM, MS, MS PRO, SD, MMC, IBM MICRODRIVE: 7 different types of memory cards.

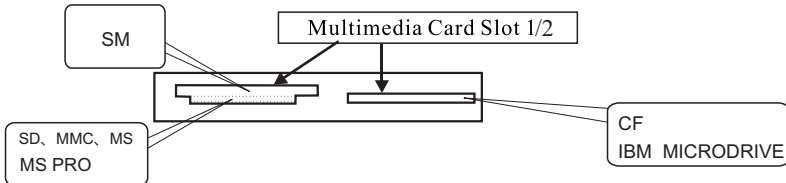

- display photo : press **PHOTO** key , and enter the photo menu. Use number keys (1-9) for photo selection and press **ENTER** to select the photo.
- display music : press **MUSIC** key, and enter music menu. Controlling instruction is the same as above.
- display movie : press **MOVIE** key , and enter movie menu. Controlling instruction is the same as above.
- When playing the above media, press **PLAY** to pause and press again to continue. Press **STOP** to stop playing.
- Background music (Can play music and photo at the same time):
 - Under PHOTO menu display mode, press **DISPLAY** can play photo and music at the same time. The first music and the first picture will be played at the same time.
 - Under MUSIC menu display mode, press **DISPLAY** and same instruction as above.
 - When music and photo is playing at the same time. Press **PLAY** once to stop playing photo, twice for both music and photo, and three to continue playing both.
- For other user instruction please go to Remote Control instruction.

5.1 SETUP MENU-MAIN PAGE

<p>SETUP MENU--MAIN PAGE</p> <p>PHOTO SETUP MUSIC SETUP SLIDE SHOW SETUP MOVIE SETUP PREFERENCES</p> <p>EXIT SETUP</p> <p>GENERAL SETUP</p> <p>MAIN PAGE</p>	<p>SETUP MENU-MAIN PAGE</p> <ul style="list-style-type: none"> • PHOTO SETUP(Change Photo settings) • MUSIC SETUP(Change Music settings) • SLIDESHOW SETUP(Change Slideshow settings) • MOVIE SETUP(Change Movie settings) • PREFERENCES (Change Menu settings) • EXIT SETUP(Exit MAIN PAGE) <p>Press SETUP key on remote control to open SETUP MENU.</p>
--	---

5.2 SETUP MENU-PHOTO

<p>SETUP MENU--PHOTO</p> <p>THUMBNAIL DIGEST ▶ ON TRANSITION MODE OFF ORIENTATION</p> <p>MAIN PAGE</p> <p>SETUP MENU--PHOTO</p> <p>PHOTO-THUMBNAIL DIGEST</p>	<p>PHOTO Thumbnail Digest Function Setup</p> <p>ON: Turn the function on OFF: Turn this function off</p> <ol style="list-style-type: none"> 1. Enter MAIN PAGE. 2. Press ENTER key to enter submenu PHOTO 3. Press (◀,▶) to highlight item to change, press ▲▼ to highlight your choice, press ENTER to save. 4. Press (◀) to go back to upper menu. then highlight MAIN PAGE to go back to previous menu.
---	---

<p>SETUP MENU--PHOTO</p> <p>THUMBNAIL DIGEST TRANSITION MODE ▶ FAST ORIENTATION NORMAL SLOW</p> <p>MAIN PAGE</p> <p>TRANSITION MODE</p> <p>PHOTO-TRANSITION MODE</p>	<p>PHOTO transition mode function setup</p> <table border="1"> <tr> <td>FAST</td> <td>NORMAL</td> <td>SLOW</td> </tr> </table> <ol style="list-style-type: none"> 1. Enter PHOTOS SETUP menu. 2. Press (▲,▼) to highlight ORIENTATION, press (▶) to show submenu on the right. Press (▲,▼) to select desired item. Press (ENTER) to save. 3. Press (◀) to return to previous menu. Select MAIN PAGE then press (ENTER) to return to previous menu. 	FAST	NORMAL	SLOW
FAST	NORMAL	SLOW		

<p>SETUP MENU--PHOTO</p> <p>THUMBNAIL DIGEST TRANSITION MODE ORIENTATION ▶ DEFAULTS IGNORE</p> <p>MAIN PAGE</p> <p>ORIENTATION</p> <p>PHOTO-ORIENTATION</p>	<p>PHOTO Orientation Function Setup</p> <table border="1"> <tr> <td>DEFAULTS</td> <td>IGNORE</td> </tr> </table> <ol style="list-style-type: none"> 1. Enter PHOTOS SETUP menu. 2. Press (▲,▼) to highlight ORIENTATION, press (▶) to show submenu on the right. Press (▲,▼) to select desired item. Press (ENTER) to save. 3. Press (◀) to return to previous menu. Select MAIN PAGE then press (ENTER) to return to previous menu. 	DEFAULTS	IGNORE
DEFAULTS	IGNORE		

5.3 SETUP MENU-MUSIC

<p>SETUP MENU--MUSIC</p> <p>REPEAT MODE ▸ ONE ALL OFF</p> <p>MAIN PAGE</p> <p>SETUP MENU--MUSIC</p> <p>MUSIC-REPEATMODE</p>	<p>MUSIC Repeat Function Setup</p> <p>ONE: Repeat one music file. (MP3)</p> <p>ALL: Repeat all music files.</p> <p>OFF: Turn Repeat function off.</p> <p>Instruction same as above</p>
---	--

5.4 SETUP MENU-SLIDE SHOW

<p>SETUP MENU--SLIDE SHOW</p> <p>SLIDESHOW MODE ▸ MANUAL AUTO</p> <p>FOLDER REPEAT</p> <p>INTERVAL TIME</p> <p>TRANSITION</p> <p>AUTO START</p> <p>MAIN PAGE</p> <p>SLIDESHOW MODE</p> <p>SLIDE SHOW-SLIDE SHOW MODE</p>	<p>SLIDE SHOW Playing Function Setup</p> <p>MANUAL: Slide show plays manually.</p> <p>AUTO: Slide show plays automatically.</p> <p>Instruction same as above</p>
--	--

<p>SETUP MENU--SLIDE SHOW</p> <p>SLIDESHOW MODE</p> <p>FOLDER REPEAT ▸ ON OFF</p> <p>INTERVAL TIME</p> <p>TRANSITION</p> <p>AUTO START</p> <p>MAIN PAGE</p> <p>FOLDER REPEAT</p> <p>SLIDE SHOW-FOLDER REPEAT</p>	<p>SLIDE SHOW Folder Repeat Function Setup</p> <p>ON: Turn Folder Repeat function on.</p> <p>OFF: Turn Folder Repeat function off.</p>
--	--

<p>SETUP MENU--SLIDE SHOW</p> <p>SLIDESHOW MODE</p> <p>FOLDER REPEAT</p> <p>INTERVAL TIME ▸ ONE SECOND THREE SECONDS FIVE SECONDS TEN SECONDS</p> <p>TRANSITION</p> <p>AUTO START</p> <p>MAIN PAGE</p> <p>INTERVAL TIME</p> <p>SLIDE SHOW-INTERVAL TIME</p>	<p>SLIDE SHOW Interval Time Setup</p> <p>ONE SECOND</p> <p>THREE SECONDS</p> <p>FIVE SECONDS</p> <p>TEN SECONDS</p>
---	---

SETUP MENU--SLIDE SHOW

SLIDESHOW MODE	FULL SCREEN
FOLDER REPEAT	TOP->BOTTOM
INTERVAL TIME	BOTTOM->TOP
TRANSITION	T/B->CENTER
AUTO START	CENTER->T/B
	BLIND: T/B
	LEFT->RIGHT
	RIGHT->LEFT
	L/R->CENTER

MAIN PAGE

TRANSITION

SLIDE SHOW-TRANSITION

SLIDE SHOW Transition function Setup

FULL SCREEN

TOP->BOTTOM	From top to bottom
BOTTOM->TOP	From bottom to top
T/B->CENTER	From top/bottom to center
CENTER->T/B	From Center to Top/bottom.
BLIND:T/B	Blinder
LEFT->RIGHT	From left to right
RIGHT->LEFT	From right to left
L/R->CENTER	From left/right to center

SETUP MENU--SLIDE SHOW

SLIDESHOW MODE
FOLDER REPEAT
INTERVAL TIME
TRANSITION
AUTO START

ON

OFF

MAIN PAGE

AUTO START

SLIDE SHOW-AUTO START

SLIDE SHOW Auto Start Function Setup

ON: Turn AUTO START on.

OFF: Turn AUTO START off.

5.5 SETUP MENU-MOVIE

SETUP MENU--MOVIE

INTERVAL TIME	FAST
REPEAT MODE	NORMAL

MAIN PAGE

INTERVAL TIME

MOVIE-INTERVAL TIME

MOVIE INTERVAL Time Function Setup

FAST

NORMAL

SETUP MENU--MOVIE

INTERVAL TIME	
REPEAT MODE	OFF
	ONE
	ALL

MAIN PAGE

REPEAT MODE

MOVIE-REPEATMODE

MOVIE Repeat Mode Setup

OFF: Turn Repeat function off.

ONE: Repeat one movie file.

ALL: Repeat all movie file.

5.6 SETUP MENU-PREFERENCES PAGE

<p style="text-align: center;">PREFERENCES PAGE</p> <table border="1" style="width: 100%;"> <tr><td>TV TYPE</td><td>▶ MULTI SYSTEM</td></tr> <tr><td>VIDEO OUTPUT</td><td>NTSC</td></tr> <tr><td>OSD LANG</td><td>PAL</td></tr> <tr><td>OSD MESSAGE</td><td></td></tr> <tr><td>DEFAULTS</td><td></td></tr> </table> <p style="text-align: center;">MAIN PAGE</p> <p>SET TV TYPE</p> <p style="text-align: center;">PREFERENCES PAGE-TV TYPE</p>	TV TYPE	▶ MULTI SYSTEM	VIDEO OUTPUT	NTSC	OSD LANG	PAL	OSD MESSAGE		DEFAULTS		<p>PREFERENCES PAGETV Type function Setup</p> <p>MULTI.SYSTEM: Change TV system (Media Player) automatically.</p> <p>NTSC: For U.S., Japan and Korea</p> <p>PAL: For countries adopting PAL system.</p>
TV TYPE	▶ MULTI SYSTEM										
VIDEO OUTPUT	NTSC										
OSD LANG	PAL										
OSD MESSAGE											
DEFAULTS											

<p style="text-align: center;">PREFERENCES PAGE</p> <table border="1" style="width: 100%;"> <tr><td>TV TYPE</td><td></td></tr> <tr><td>VIDEO OUTPUT</td><td>▶ S-VIDEO</td></tr> <tr><td>OSD LANG</td><td>YPBPR</td></tr> <tr><td>OSD MESSAGE</td><td>RGB</td></tr> <tr><td>DEFAULTS</td><td></td></tr> </table> <p style="text-align: center;">MAIN PAGE</p> <p>SET VIDEO OUTPUT</p> <p style="text-align: center;">PREFERENCES PAGE-VIDEO OUTPUT</p>	TV TYPE		VIDEO OUTPUT	▶ S-VIDEO	OSD LANG	YPBPR	OSD MESSAGE	RGB	DEFAULTS		<p>PREFERENCES PAGE VIDEO OUTPUT Setup</p> <p>S-VIDEO: S-Video signal output.</p> <p>YPBPR: YPBPR signal output.</p> <p>RGB: RGB signal output. Attention: Don't change this item.</p>
TV TYPE											
VIDEO OUTPUT	▶ S-VIDEO										
OSD LANG	YPBPR										
OSD MESSAGE	RGB										
DEFAULTS											

<p style="text-align: center;">PREFERENCES PAGE</p> <table border="1" style="width: 100%;"> <tr><td>TV TYPE</td><td></td></tr> <tr><td>VIDEO OUTPUT</td><td></td></tr> <tr><td>OSD LANG</td><td>▶ ENGLISH</td></tr> <tr><td>OSD MESSAGE</td><td>CHINESE</td></tr> <tr><td>DEFAULTS</td><td></td></tr> </table> <p style="text-align: center;">MAIN PAGE</p> <p>SET OSD LANGUAGE</p> <p style="text-align: center;">PREFERENCES PAGE-OSD LANG</p>	TV TYPE		VIDEO OUTPUT		OSD LANG	▶ ENGLISH	OSD MESSAGE	CHINESE	DEFAULTS		<p>PREFERENCES PAGE OSD Language Setup</p> <p>ENGLISH: OSD in English.</p> <p>CHINESE: OSD in Chinese.</p>
TV TYPE											
VIDEO OUTPUT											
OSD LANG	▶ ENGLISH										
OSD MESSAGE	CHINESE										
DEFAULTS											

<p style="text-align: center;">PREFERENCES PAGE</p> <table border="1" style="width: 100%;"> <tr><td>TV TYPE</td><td></td></tr> <tr><td>VIDEO OUTPUT</td><td></td></tr> <tr><td>OSD LANG</td><td></td></tr> <tr><td>OSD MESSAGE</td><td>▶ ON</td></tr> <tr><td>DEFAULTS</td><td>OFF</td></tr> </table> <p style="text-align: center;">MAIN PAGE</p> <p>OSD MESSAGE</p> <p style="text-align: center;">PREFERENCES PAGE-OSD MESSAGE</p>	TV TYPE		VIDEO OUTPUT		OSD LANG		OSD MESSAGE	▶ ON	DEFAULTS	OFF	<p>PREFERENCES PAGE OSD MESSAGE Setup</p> <p>ON: Turn OSD MESSAGE on.</p> <p>OFF: Turn OSD MESSAGE off.</p>
TV TYPE											
VIDEO OUTPUT											
OSD LANG											
OSD MESSAGE	▶ ON										
DEFAULTS	OFF										

<p style="text-align: center;">PREFERENCES PAGE</p> <table border="1" style="width: 100%;"> <tr><td>TV TYPE</td><td></td></tr> <tr><td>VIDEO OUTPUT</td><td></td></tr> <tr><td>OSD LANG</td><td></td></tr> <tr><td>OSD MESSAGE</td><td></td></tr> <tr><td>DEFAULTS</td><td>▶ RESET</td></tr> </table> <p style="text-align: center;">MAIN PAGE</p> <p>OSD DEFAULTS</p> <p style="text-align: center;">PREFERENCES PAGE-DEFAULTS</p>	TV TYPE		VIDEO OUTPUT		OSD LANG		OSD MESSAGE		DEFAULTS	▶ RESET	<p>PREFERENCES PAGE DEFAULTS Setup</p> <p>RESET: Restore manufacturer's defaults settings.</p>
TV TYPE											
VIDEO OUTPUT											
OSD LANG											
OSD MESSAGE											
DEFAULTS	▶ RESET										

Note:

PREFERENCES PAGE DEFAULTS is active only in initial status by press SETUP key. If not, please press "GOTO" key to return to initial status.

5.7 SETUP MENU-EXIT SETUP

<p>SETUP MENU--MAIN PAGE</p> <ul style="list-style-type: none"> PHOTO SETUP MUSIC SETUP SLIDE SHOW SETUP MOVIE SETUP PREFERENCES <hr/> <ul style="list-style-type: none"> EXIT SETUP <p>GENERAL SETUP</p> <p>MAIN PAGE</p>	<p>MAIN PAGE EXIT SETUP</p> <p>Press (▼,▲) to highlight EXIT SETUP Press ENTER to exit OSD menu.</p>
--	--

6 OSD Setup Guide

6.1 AV Mode

Remote Control Operation

Press MENU to highlight the OSD setting, press ◀ ▶ , to select submenu, press ▲ ▼ , to select aimed variable, then press ◀ ▶ to adjust numerical variable; If the variable is not numerical (such as "TV", "VIDEO"), press ▲ ▼ to select aimed variable, then press ENTER to confirm. Press RETURN button at the submenu to return till exit OSD, or you can wait for OSD exit automatically (please reference the detail OSD menu closing time setting).

Tips: You can also press ENTER, MENU buttons on remote control or OSD on the machine to return till exit the OSD setting.

VIDEO and MEDIA PLAYER Mode

The Specific Menus:

The specific of Menus are different for each mode of VIDEO, TV, MEDIA PLAYER, However, the same for VIDEO and MEDIA PLAYER Menus.

Select Menu:

- VIDEO ADJUST
- OSD ADJUST
- INPUT SELECT
- AUDIO
- LANGUAGE SELECT
- EXIT

6.1.1 VIDEO ADJUST

Operation under highlighting the variable			
BRIGHTNESS	reduce/increase the variable	HUE	reduce/increase the variable
CONTRAST	reduce/increase the variable	COLOR	
		TEMPERATURE	reduce/increase the variable
SHARPNESS	reduce/increase the variable	RESET	defaults recall
SATURATION	reduce/increase the variable	RETURN	return to Menu
Note: To ease the operation, the second function of multifunction buttons will be used (up, down, left, right at menu setting) , representing by :▲、▼、◀、▶			

6.1.2 OSD ADJUST

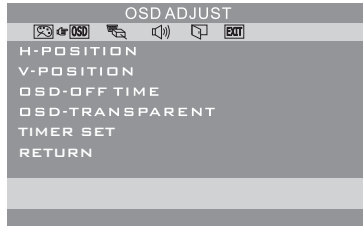

H-POSITION	Move horizontally	OSD-OFF TIME	OSD auto off time setup
V-POSITION	Move vertically	OSD-TRANSPARENT	OSD Transparency
TIMER SET	Timer function	RETURN	Return to Menu

TIMER SET is to set up the clock's On/Off time. It appears in the upper right corner of the screen. Timer is in function only "Timer On" is selected. Press ◀ or ▶ to turn TIMER ON or off. Press ▲ or ▼ to switch between ON, OFF, TIME, TIMER ON and TIMER OFF. When timer is on, three selections will be displayed on the screen, including "ON (On Time)", "OFF (Off Time)" and "TIME (Current Time)". Press numbered keys to adjust to the correct time. If the current time is 13:15:41, press 1, 3, 1, 5, 4, 1 as the arrow flashes. Confirm it after time adjust.

- ON: System is off, internal clock still runs, when it's time to start, system will be automatically turned on
- Off: System is on, when it's time to shut down, system will be automatically turned off.
- TIME: Current time

When Timer is set to "NO", auto-timer is off.

1. Press ENTER / MENU to enter submenu, then press ENTER / MENU to enter OSD ADJUST (or press ▼)

2. Press ◀, ▶ to highlight your choice.

3. Then press ENTER to highlight, press ◀, ▶ to change settings. Or Press ENTER for options

6.1.3 INPUT SELECT

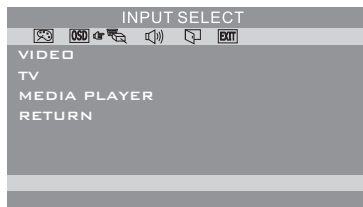

VIDEO	For VIDEO input signal	MEDIA PLAYER	For Media Player
TV	For TV signal	RETURN	Return to menu

1. Press **MENU** to enter submenu, then press **ENTER** to enter **INPUT SELECT** .
2. Highlight your selection, press **ENTER** to confirm.

6.1.4 AUDIO (AUDIO SETTING)

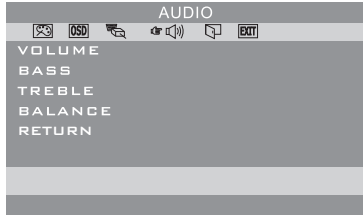

VOLUME	TREBLE
BASS	BALANCE

1. Press **MENU** to enter submenu, then press **ENTER** to open **AUDIO** menu .
(Or press **▼**)
2. Press **▼**、**▲** to highlight your choice.
3. Press **ENTER** to open and press **◀**、**▶** to change the settings. Or press **ENTER** for options

6.1.5 LANGUAGE SELECT (LANGUAGE SETTING)

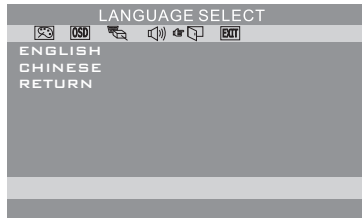

ENGLISH	CHINESE
---------	---------

1. Press **MENU** to enter submenu, then press **ENTER** to open **LANGUAGE SELECT** menu
2. Select a language, then press **ENTER** to confirm.

6.1.6 EXIT

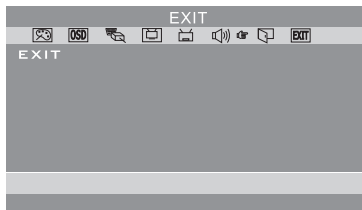

	press ENTER/MENU to quit OSD adjust.
--	---

6.2 TV MODE SETTINGS

Menu:

- VIDEO ADJUST
- OSD ADJUST
- INPUT SELECT
- TV FUNCTION
- TV MODE
- AUDIO
- LANGUAGE SELECT
- EXIT

The Operation for VIDEO ADJUST, OSD ADJUST, INPUT SELECT, AUDIO, LANGUAGE SELECT, EXIT are the same for VIDEO, MEDIA PLAYER mode are same, here are the details of TV function and TV mode setting.

6.2.1 TV FUNCTION

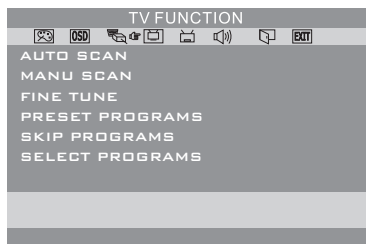

TV Function Menu	
AUTO SCAN	Auto search channels
MANU SCAN	Manual search channels
FINE TUNE	Covering manually full channel width, to the highest level of performance.
PRESET PROGRAMS	Able to change channels' sequence.
SKIP PROGRAMS	This function for skip a channel, ▼▲ on remote control to select a skip channel.
SELECT PROGRAMS	This function for select channel on the machine buttons, ▼▲ on machine to select channels.
1. Press remote control direction key to select, and press ENTER / MENU to confirm 2. Select PRESET PROGRAMS setup selection, press ◀ ▶ to adjust the aimed channel in the mid-bottom of OSD menu, press ENTER / MENU to realize preset function	

6.2.2 TV MODE

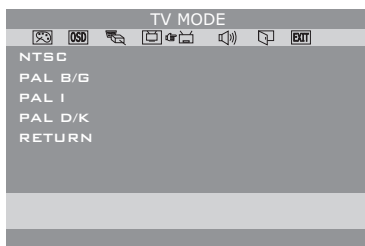

TV MODE	
NTSC	US, Japan, South Korea
PALB/G	Germany, Italy, Spain, Saudi Arabia and other countries adopting PAL B/G
PAL I	Hong Kong, UK.
PALD/K	China
1. Select ENTER / MENU to enter submenu , press " ◀ ▶ " button on remote control. 2. Then press ENTER / MENU to confirm.	

7 TV Mode Control Menu

7.1 AUTO CHANNEL SEARCH

First time use or TV moved to new area, needs to process auto channel search.

1. In TV Playing mode, press **MENU** to enter submenu. (Please compare system setting part in the front page.)
2. Press "**◀ ▶**" on the remote control to TV Menu, then press **ENTER** to enter setting.
3. Press "**▲ ▼**" on the remote control to Auto Channel Scan, press **ENTER** to enter "Auto Channel Scan". After auto scan finished, there will be auto play first channel, and channels can be watch normally.
4. To stop Auto Scan, press **ENTER** Key to quit.

7.2 CHANNEL SELECTION

To select channels, press "**▲ ▼**" or enter number of a channel on the remote control, then press **ENTER** to confirm. Also "Channel Selection" can be found in the submenu for select channels.

7.3 DISPLAY CHANNEL

While TV is in playing mode, press **DISPLAY** to show channel number on the top right corner screen.

7.4 CHANNEL RECALL

While TV is in playing mode, press **ENTER** to go back previous channel.

8 AV Input/Output User Instruction

This product has AV Connection. AV Device can directly connect with DVD, VCD player (PS. AV M status needs to change to, which AV input turn on)

User Instruction below :

AV Input & Output can be control by the switch.

AV Input: VIDEO Input (Connect DVD/VCD AV Output), AUDIO Input (Connect DVD /VCD Audio Output), needs to switch status to IN, then digital frame playing mode switch to Video mode, then AV signal can be play.

Instruction :

First Thing AV Signal Cable connected follow by color:

1. Take DVD, VCD's VIDEO (Yellow) Connect to Album TV's VIDEO AV.
2. Take DVD, VCD's AUDIO (Red, White) Connect to Album TV's AUDIO AV.

Then switch Digital frame's mode to VIDEO:

1. Press **MENU** into OSD system menu.
 2. Press "◀ ▶" switch to **INPUT SELECT** screen.
 3. Select **VIDEO** input mode, **ENTER** to confirm VIDEO input mode.
- Finished Instruction above will be able to watching DVD, VCD.

AV Output Status Description: System AV Signal can be output, need to connect AV input, then can play media from Album TV. Let Video Input/output switch to Out, also digital frame playing mode change to MEDIAPLAYER, then it will be able to play.

Panel: 10.4" TFTLCD

Active Area: 211.2 mm(H)*158.4(V)mm

Resolution: 640(W)* 480(H)

Horizontal frequency (H): 30 - 80KHZ

Vertical frequency (V): 60/75HZ

Lamp Lifetime: 50,000Hours

Brightness: 330cd/m²

Contract Ratio: 250 : 1

View Angle: Vertical 110°/Horizontal 140°

Input Power: DC 12V, 1.5A

Power Consumption: 25W

Supported Multimedia File: MPEG 1, MPEG 2

MP3, WMA

JPEG

Supported Memory card: CF, SM, SD, MMC, MS, MS PRO, IBM MICRODRIVE

Warnings:

The following information with regard to safety are recommended to be included as far as applicable:

- minimum distances around the apparatus for sufficient ventilation;
- the ventilation should not be impeded by covering the ventilation openings with items, such as newspapers, table-cloths, curtains, etc.;
- No naked flame sources, such as lighted candles, should be placed on the apparatus;

The apparatus shall not be exposed to dripping or splashing and that no objects filled with liquids, such as vases, shall be placed on the apparatus.

CAUTION

Danger of explosion if battery is incorrectly replaced.

Replaced only with the same or equivalent type.



Shanghai Visart Technologies Co., Ltd.

**Room 906 Hongcao Building, 421 Hongcao Road
Shanghai, China, P. R.
200233**

**Tel: 86-21-64955920
Fax: 86-21-64955921**

VISART USA Corporation

**1211 John Reed Court,
City of Industry, CA 91745**

**Tel: 1-626-855-3486
Fax: 1-626-855-1145
Tollfree: 1-866-4-VISART**

Http : [//www.visart.com](http://www.visart.com)

Free Manuals Download Website

<http://myh66.com>

<http://usermanuals.us>

<http://www.somanuals.com>

<http://www.4manuals.cc>

<http://www.manual-lib.com>

<http://www.404manual.com>

<http://www.luxmanual.com>

<http://aubethermostatmanual.com>

Golf course search by state

<http://golfingnear.com>

Email search by domain

<http://emailbydomain.com>

Auto manuals search

<http://auto.somanuals.com>

TV manuals search

<http://tv.somanuals.com>