



Use and Care Manual

Read And Save These Instructions



BarBoss[®], Drink Machine, Vita-Prep[®] & Vita-Pro[®]

High-Performance Commercial Blenders

Includes: BarBoss • Drink Machine
(Two-Step Timer, Two-Speed, Variable Speed)
Vita-Prep 3 • Vita-Prep • Vita-Pro

All Models

Important Safeguards

1. Read all instructions.
2. To protect against risk of electrical shock, do not put motor base in water or other liquid.
3. Close adult supervision is necessary when machine is used by or near children.
4. Unplug the power cord from the wall outlet when the Vita-Mix® machine is not in use, before disassembling, putting on or taking off parts, and before cleaning, other than washing the container.
5. Never contact moving parts, especially the blades.
6. Do not operate any machine with a damaged cord or plug, if the appliance malfunctions, or has been dropped or damaged in any manner. In the US and Canada, call **Vita-Mix Customer Service, 800-4DRINK4 (800-437-4654) or 440-235-0214** at once for examination, repair, possible replacement, or electrical or mechanical adjustment. If you live outside the United States or Canada, contact your local Vita-Mix Distributor, or telephone the Vita-Mix International Division at +1.440.782.2450 or email international@vitamix.com for a distributor in your country.
7. Do not use attachments not recommended or sold by Vita-Mix Corporation.
8. **Do not use outdoors.**
9. Do not let the power cord hang over edge of table or counter.
10. Do not place the machine on or near a hot gas or electrical burner, in a heated oven, or allow machine to touch hot surfaces. External heat sources can damage your machine.
11. Keep hands and utensils out of container while motor is running to prevent the possibility of severe personal injury and/or damage to the Vita-Mix machine. A rubber spatula may be used, but only when the Vita-Mix machine is not running. With the flexible rubber lid in place, the Vita-Mix accelerator tool (available with some models) may be used while motor is running.
12. **WARNING: Blade is sharp. Handle carefully.**
 - Never try to remove blade while container is sitting on the motor base.
 - Do not operate with loose, nicked or damaged blade – replace immediately.
 - To reduce the risk of personal injury, never place blade assembly on motor base without blender container properly attached.
13. The maximum normal load is equivalent to the ounces (liters) listed on the container, i.e., 64 oz. / 2.0 Ltr., 48 oz. / 1.4 Ltr. and substantially less with thick mixtures.
14. Container should not be more than 2/3 full when the accelerator tool is left in place while blending. Do not exceed 30 seconds of continuous blending with accelerator tool in place.
15. When making nut butters or oil based foods, do not process for more than one minute after mixture starts circulating. Overprocessing can cause dangerous overheating.

Important Safeguards

16. **CAUTION:** Cooling problems resulting in thermal shut-off and eventual motor damage may result if machine is operated in sound chambers other than those approved by Vita-Mix.
17. Always operate the Vita-Mix machine with a lid in place.
18. **CAUTION:** On all machines with timers, the light in the front panel START/STOP switch, when lit, indicates the power to blender is ON and blender could start. Turn power OFF, or unplug the machine before touching movable parts. Shut OFF the power switch at night or whenever the machine will be left unattended.
19. **WARNING:** When processing hot liquids:
 - The two-part latching lid must be securely locked in place. This allows steam to escape naturally and will prevent the lid from coming off when the machine is turned on.
 - Do not start processing hot liquids on HIGH speed. Always start processing hot liquids on LOW speed, then switch to HIGH speed while the machine is running.
 - Use caution with hot liquids. Liquids may spray from under the lid plug or escaping steam may cause scalding.
 - Do not process hot ingredients with the Vita-Mix non-latching lid.

Save These Safety Instructions

Enjoy the safety of this grounded machine. The Vita-Mix blender's U.S. power cord comes equipped with a three-prong (grounding) plug which mates with a standard three-prong wall outlet (Figure A). This cord will vary for countries outside the United States.

Adapters (Figure B) are available for two-prong outlets. Do not cut or remove the third (ground) prong from the plug or power cord.

Consult your electrician if you are not sure if the wall outlet is grounded through the building wiring. With a properly grounded two-prong wall outlet, ground the machine by attaching the tab on the adapter to the wall outlet cover by means of the screw in the center of the cover (Figure B).



**THREE-PRONG
ADAPTERS
ARE NOT TO
BE USED IN
CANADA.**

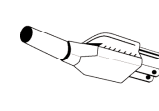

Figure A

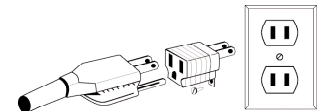
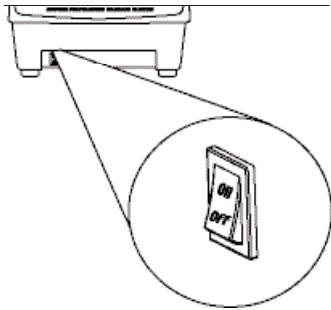

Figure B

The instructions appearing in this Use and Care Manual cannot cover every possible condition and situation that may occur. Common sense and caution must be practiced when operating and maintaining any appliance.

Control Panels

NOTE: Vita-Mix® blenders come with several different control options. Please be sure you are following the instructions for your blender model.



Timer & Pulse Model

(BarBoss®)

ON/OFF Power Switch. Located on the front of the machine below the control panel, the ON/OFF switch controls the power to the machine. While plugged in, switch to ON to ready the machine for blending. Shut OFF the power switch at night or whenever the machine will be left unattended.

TIMER Dial. Allows user to select a number of timed settings. All times are total times. Increments on timer are approximate seconds. Timer is activated *only* when the power switch is ON. Blender will shut off automatically at the end of the pre-set time.

START/STOP TIMER Switch. This is a lighted switch. When light is lit, power is ON. Depress START/STOP TIMER switch to activate timer setting and again to stop a blending cycle.

During operation, you may interrupt timer by pressing the START/STOP switch.

PULSE Switch. The PULSE switch can be used to quickly refresh product in the container by depressing the switch and holding down as long as needed. The Pulse switch can only be used when the power switch is ON.

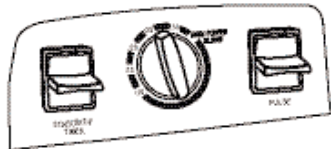

Note on Timers: Stop mid-cycle with the START/STOP switch, not the ON/OFF switch. If the ON/OFF switch was used, wait 30 seconds for power to recycle and the timer to reset before resuming operation.

Two-Step Timer Model

(Drink Machine)

ON/OFF Power Switch. Up for ON. Down for OFF.

TIMER Dial. Allows user to select a number of timed settings. All times are total times. Increments on timer are approximate seconds. Timer is activated *only* when the power switch is ON. Blender will shut off automatically at the end of the pre-set time.

START/STOP TIMER Switch. This is a lighted switch. When light is lit, power is ON. Depress START/STOP TIMER switch to activate timer setting and again to stop a blending cycle.

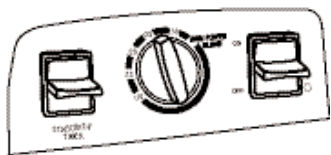

Note on Two-Step Timers: Stop mid-cycle with the START/STOP switch, not the ON/OFF switch. If the ON/OFF switch was used, wait 30 seconds for power to recycle and the timer to reset before resuming operation.

Variable Speed Model

(Drink Machine, Vita-Prep, Vita-Prep 3, Vita-Pro)

ON/OFF Power Switch. Up for ON. Down for OFF.

HIGH/VARIABLE Switch. HIGH overrides the VARIABLE SPEED dial and is the fastest speed available. Switch must be set to VARIABLE to use the VARIABLE SPEED dial.

VARIABLE SPEED Dial. Allows user to select continuously variable motor speeds ranging from 1,000 rpm to 24,000 rpm. Active only when HIGH/VARIABLE switch is set on VARIABLE position.

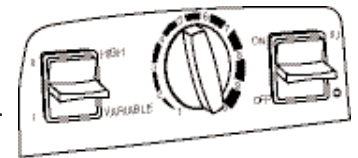

Two-Speed Model

(Drink Machine)

ON/OFF Power Switch. Up for ON. Down for OFF.

HIGH/LOW Switch. Up for HIGH. Down for LOW.

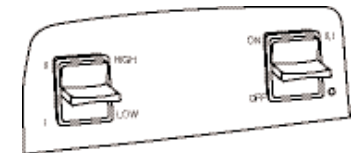

NOTE: Switches may become sticky from use. Unplug the machine and use a wet cloth, moistened with water and a mild detergent, to clean around the edges of the switch paddles until they function freely. Work the switches back and forth a few times to loosen any dried residue under switch. Leaving switches sticky will damage or burn out the switches. Clean carefully, using caution not to allow water or other liquids to infiltrate the switch. Dry with a soft cotton cloth.

Lid Assembly

NOTE: Vita-Mix® lids come in several different styles. Please be sure you are following the instructions for your style of lid.

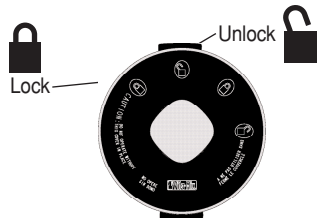

Figure A

Top view of lid showing Locking Icons.

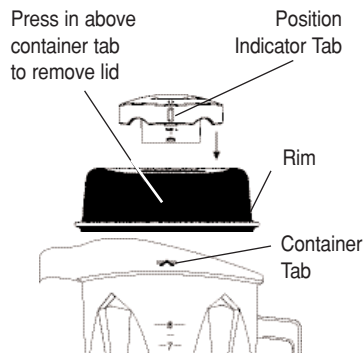

Figure B

Always lock lid when processing hot liquids. See warning on page 3.

Two-Piece Lid

64 oz. / 2.0 Ltr. Polycarbonate Container

The two-piece lid is easy to clean and easy to put on and take off.

- The lid has a continuous rim which latches inside the container tabs. Push one side of the rim under one tab, and with the heel of your hands push down, over the opposite tab, to snap lid into position.
- To remove lid, place hands around the lid, pressing thumbs above one of the container tabs. Push in and lift off.
- To secure lid plug: Position the lid plug over the lid and align either of the position indicator tabs with an unlocked icon. Press the plug into the lid and turn until an indicator tab is aligned with one of the locked icons. (Turn the lid over to be sure that plug is properly locked – the locking feet must be seated into the lid locking notches.) The bottom surface of the plug should be snug against the top of the lid.
- The lid plug can be removed when using the accelerator tool or adding ingredients. Turn plug to an unlocked icon to remove.

One-Piece Lid (Optional)

64 oz. / 2.0 Ltr. Polycarbonate Container

The one-piece lid is easy to put on or take off, and to clean, for quick operation.

- There is no latch on this lid. Simply hold the lid on when starting.
- Add ingredients through port in top.

CAUTION: Do not use non-latching one-piece lid when processing hot ingredients. Not for use with an accelerator tool.

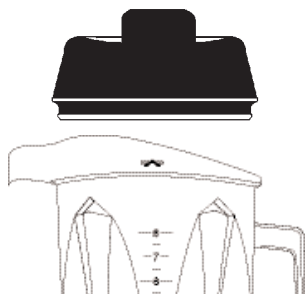

Figure C

NOTE: Brand new lids may be a little stiff. This is temporary. To make new lids easier to insert and remove, rub a light coating of cooking oil around rim where it seals. Place it in container for several minutes, remove and lightly wipe oil off lid.

Two-Piece Lid

Compact 32 oz. / 0.9 Ltr. Polycarbonate/ Stackable Container

The two-piece lid is easy to clean and easy to put on, take off and seal.

- The lid has a continuous rim which fits tightly inside the container. Push lid into container until the side latches are snapped under the container lip.
- To remove lid, pull up gently on the side lid latches.
- To secure lid plug: Position the lid plug over the lid and align either of the position indicator tabs with one of the unlocked icons. Press the plug into the lid and turn until an indicator tab is aligned with a locked icon. (Turn the lid over to be sure that plug is properly locked – the locking feet must be seated into the lid locking notches.) The bottom surface of the plug should be snug against the top of the lid.
- The lid plug can be removed when using the accelerator tool or adding ingredients. Turn plug to an unlocked icon to remove.

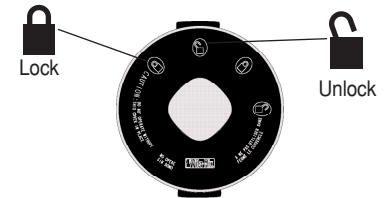

Figure D

Top view of lid showing Locking Icons.

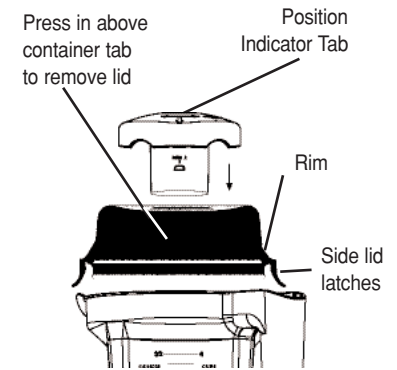

Figure E

Always lock lid when processing hot liquids. See warning on page 3.

Two-Piece Lid

48 oz. / 1.4 Ltr. Polycarbonate/Stackable Container

The two-piece lid is easy to clean and easy to put on, take off and seal.

- Push lid into container until the side latches are snapped under container lip. (See F(1) - F(3).)
- To remove fully latched lid, squeeze tabs together on both sides of the container, pull upward and off.
- The lid plug can be removed when using the accelerator tool. Twist plug to fasten or remove.

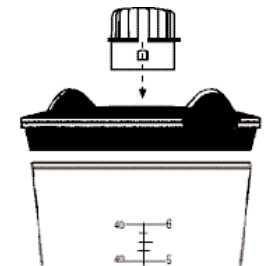
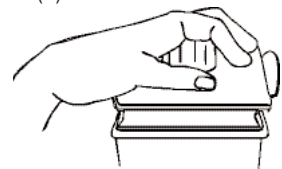

Figure F

F(1) Unsealed/Unlatched



Lid resting on container using hand to stabilize.

F(2) Sealed

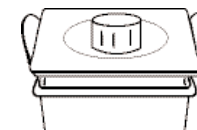

Lid pushed into container. Side latches are not under container lip.

F(3) Fully Latched

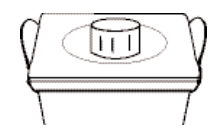

Side latches are snapped under container lip.

General Instructions

Two-Speed or Variable Speed Drink Machines, Vita-Pro®, Vita-Prep® and Vita-Prep® 3

1. Place liquids and soft foods in container first, solid items and ice last. Although not necessary for processing, you may want to cut or break food into smaller pieces for precise measuring of ingredients. Thawed or partially thawed fruit is recommended. High-speed is recommended for heavy-duty blending.
 2. Set the container on the motor base by aligning it over the centering pad anchored to the base. **(Motor must be completely stopped before positioning container.)** Containers are not to be used for hard, dry materials. Avoid running the blender with the container empty.
 3. Always use a lid when blending. If blending hot ingredients, the lid must be securely locked in place. **When processing hot liquids, DO NOT use a non-latching or one-piece lid.**
 4. Plug the machine into the nearest outlet (if unplugged). Select desired speed setting. Most foods are blended on HIGH speed. Start heavy or thick foods on the recommended speed then switch to HIGH once the mixture begins processing.
 - 4a. If mixture stops circulating, you have likely trapped an air bubble. Either insert the accelerator tool through the lid while blending (see page 11), or stop the motor, remove the container from the base and stir or scrape the mixture from the sides of container into the center using a rubber spatula to press any air bubbles away from the blades. Replace the lid and continue blending.
 - 4b. Due to the blending speed of the machine, processing times are greatly reduced over other manufacturers' machines. Until you become accustomed to the speed, watch your mixture carefully to avoid over-blending.
-  **Warning: If you detect a change in the sound of the machine or if a hard or foreign object comes into contact with the blades, do not serve the drink/food. Inspect your blade assembly for loose, nicked or missing parts. If parts are loose, missing or nicked, replace with new blade assembly. (See page 10.)**
6. After the blender has been stopped, wait until the blade comes to a complete stop before removing the lid or container from the motor base.

Bar Boss® and Timer Blender Instructions

1. Place liquids and soft foods in container first, solid items and ice last. Although not necessary for processing, you may want to cut or break food into smaller pieces for precise measuring of ingredients. Thawed or partially thawed fruit is recommended. High-speed is recommended for heavy-duty blending.
2. Set the container on the motor base by aligning it over the centering pad anchored to the base. **(Motor must be completely stopped before positioning container.)** Containers are not to be used for hard, dry materials. Avoid running the blender with the container empty.
3. Always use a lid when blending. If blending hot ingredients, the lid must be securely locked in place. **When processing hot liquids, DO NOT use a non-latching or one-piece lid.**

4. Plug the machine into the nearest outlet (if unplugged). Press ON/OFF switch to ON. Activate the timer by selecting the desired timer setting on the dial and then depressing the START/STOP TIMER switch on the left.
 - 4a. If mixture stops circulating, you have likely trapped an air bubble. Either insert the accelerator tool through the lid while blending (see page 11), or stop the motor, remove the container from the base and stir or scrape the mixture from the sides of container into the center using a rubber spatula to press any air bubbles away from the blades. Replace the lid and continue blending.
 - 4b. Due to the blending speed of the machine, processing times are greatly reduced over other manufacturers' machines. Until you become accustomed to the speed, watch your mixture carefully to avoid over-blending.
 - 4c. If stopping the machine mid-cycle, use the START/STOP switch, not the ON/OFF switch. If the ON/OFF switch was used, wait 30 seconds for power to recycle and the timer to reset before resuming operation.

Note: The START/STOP TIMER switch on your machine is lit when power is ON. Avoid moveable parts. The machine may stop working if it is overloaded on low speed. Reset the machine by turning power off for 30 seconds.
-  **Warning: If you detect a change in the sound of the machine or if a hard or foreign object comes into contact with the blades, do not serve the drink. Inspect your blade assembly for loose, nicked or missing parts. If parts are loose, missing, or nicked, replace with new blade assembly. (See page 10.)**
5. After the blender has been stopped, wait until the blade comes to a complete stop before removing the lid or container from the motor base.
 6. **To use the PULSE switch to refresh drinks:** Make sure the power is ON. With the container on the motor base, depress the PULSE switch. Release the switch to stop the motor.
 7. Press the ON/OFF switch to OFF when not in use.

NOTE: The thermal protector may shut the motor off to protect it from overheating. To restart, wait for motor to cool down with the power off (up to 45 minutes). Cooling may be quickened by placing the motor base in a cool spot. **Unplug first.** To speed up the process, try circulating the air with a vacuum or fan aimed at the bottom of the base. When the thermal protector shuts the motor off, review your processing techniques and your instructions. Your recipes may be too thick (add liquid), be processed too long at too low a speed setting, or have too much material in them. If the motor seems to be overheating but the thermal protector has not turned the machine off, stop the machine and remove the container from the base.

Follow these instructions for the Two-Speed or Variable Speed Drink Machines, Vita-Pro and Vita-Preps: Set the dial on HIGH (#10). Turn the machine ON and let the machine run for 1 minute. Be careful never to touch any moving part while in use.

Follow these instructions for the BarBoss and Timer Blenders: Set the timer for 20 seconds. Turn the machine ON and let the machine run for 20 seconds. Repeat this step 3 times for a total of 1 minute. Be careful never to touch any moving parts while in use.

Blade Assembly

Blade Agitator Assembly. The blade assembly includes a precision-hardened stainless steel blade with enclosed steel ball bearings for maximum durability. The rugged blade assembly literally explodes molecules of food and ice in the container, helping every batch to homogenize more effectively. The blade does not need to be removed for normal cleaning. (Refer to the information below to remove or replace.)

Drive Spline. Mates with drive socket on the motor base to turn the blade. **NOTE:** Removing and replacing your container while the coupling is still rotating will strip the drive spline "teeth." (This part is NOT removable.)

Retainer Nut. Must be snug. Order the available Retainer Nut Wrench for best results. (Refer to the information below to remove or replace.)

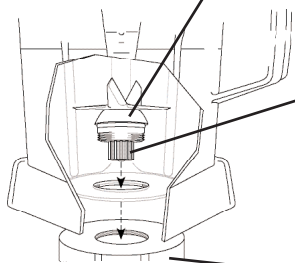

⚠ Never use a blade assembly with loose, damaged or nicked components.

Blade Assembly Removal

CAUTION: Do not remove blades unless absolutely necessary! At times, it may be necessary to give your blades additional cleaning. An easy-to-use blade assembly removal wrench (Item #15596) may be purchased through your Vita-Mix Distributor. **Never attempt to take the blade assembly itself apart. This will void the warranty.**

Turn the container upside down and grip firmly. Insert retainer nut wrench in groove of retainer nut and rotate counterclockwise to loosen. Then grip blades with a cloth and remove retainer nut by hand.

Replacing Blade Assembly

With the container upside down, grip blades with cloth, insert into the container bottom and align with flat sides of container opening. Place retainer nut on and hand tighten. Last, carefully turn clockwise until secure, using wrench. **Do not force.** If it is not tight enough, you will notice increased container noise.

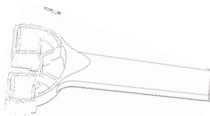

Retainer Nut Wrench

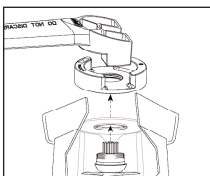

Retainer Nut Wrench in use.

Accelerator Tool/Motor Base

The accelerator tool prevents an air bubble from forming while blending and allows for the processing of very thick and/or difficult-to-process frozen mixtures. While the machine is running, use the accelerator tool to push ingredients into the blades.

Accelerator Tool use:

- If thick mixtures stop circulating, you may have trapped an air bubble. Insert the accelerator tool through the lid and stir to release it.
- Use it only with the lid locked in place and lid plug removed.
- The splash disk (near the top of the accelerator tool) and lid prevent the accelerator tool from hitting the blades.
- The container should not be more than 2/3 full when the accelerator tool is used.
- Do not use the accelerator tool for more than 30 consecutive seconds (to avoid overheating).
- Holding the accelerator tool straight should allow extra thick ingredients to circulate. If not, point the accelerator tool toward the side or corner of the container.

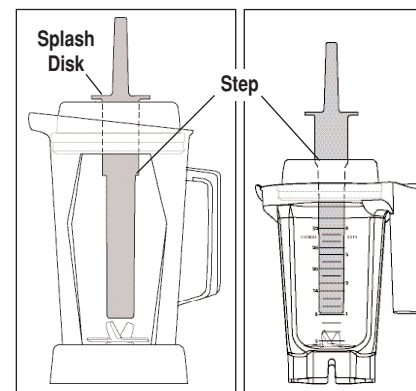

NOTE: The accelerator tool has a small "step" on it to prevent contact with the blades. Do not push the accelerator tool "step" past the lip of the 32 oz. / 0.9 Ltr. compact container. The accelerator tool cannot be used with a one-piece non-latching lid.

⚠ DO NOT force the accelerator tool into the 32 oz. / 0.9 Ltr. container. Excessive force may cause the accelerator tool to extend too far into the container and may cause damage to the blades. **DO NOT** use the older accelerator tool that has a straight and smooth surface and no "step." Use of the older model may cause damage to the blades.

⚠ When processing hot liquids:

- The two-part latching lid must be securely locked in place. This allows steam to escape naturally and will prevent the lid from coming off when the machine is turned on.
- Do not start processing hot liquids on HIGH speed. Always start processing hot liquids on LOW speed, then switch to HIGH speed while the machine is running.
- Use caution with hot liquids. Liquids may spray from under the lid plug or escaping steam may cause scalding.
- Do not process hot ingredients with the Vita-Mix non-latching lid.

Motor Base

Power Cord. Your machine is equipped with a 6 ft. / 1.8 m power cord. Store the unused portion neatly underneath. Plastic cord retainer clips hold the cord securely. They are flexible and will return to position after the cord is lifted out. There is no need to unscrew the cord retainer clips to let out more cord.

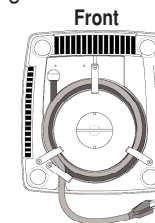

Back

Care and Cleaning

Care Note

To ensure that you get the longest possible life from your Vita-Mix machine, we recommend the following products, when used as directed by the supplier:

CLEANING PRODUCTS

Solid Supra, Solid Power,	Ecolab, Inc. , St. Paul, MN 800-352-5326 www.ecolab.com
Guardian Acclaim, Solid Guardian Plus, Solid Super Impact, Solid Insure Diverpak.	Diversey , Livonia, MI 800-521-8140
Eclipse H2, Liqui-Safe L7 Acclean	Klenzade Products Division of Ecolab St. Paul, MN 612-293-2165
Poly-Brite	
Glow MB-1	Wesmar Company, Inc. Seattle, WA 206-783-5344 www.wesmar.com
Lustre NC-25 Lustre Plus	
PSRA 41-D, PSRA 41-E	Anderson Chemical Co. Litchfield, MN 800-366-2477 www.andersonchemical.com
Liqui-Ware 1, Liqui-Ware MC D-Flex, Sur-Met	

RINSE AIDS

Solid Rinse Dry	Ecolab, Inc. , St. Paul, MN 800-352-5326 www.ecolab.com
Solid Brilliance Jet Dry, Rinse Dry	

DESTAINER

NuWare	Diversey , Livonia, MI 800-521-8140
------------------	---

NOTE: Do not use abrasive cleaning agents or concentrated bleach when cleaning. Do not use any cleaners containing Quaternary Sanitizers on polycarbonate components (i.e., containers). Do not use any of the following cleaning products: automatic dishwashing detergents, oven cleaners, steel wool or other abrasive pads.

ADDITIONAL NOTE: Do not let mixtures, liquids and food products dry in the container. Rinse throughout use. Dry product may lock around the blade and weaken/tear the bearings seal when restarted. Do not place containers in the freezer. Extremely low temperature combined with hot ingredients and/or the immediate rapid action of the blade may crack the container. Due to the nature of polycarbonates, microwaving and automatic dishwashing are not recommended. Follow the cleaning instructions on page 13.

SUPPLIER

Ecolab, Inc. , St. Paul, MN 800-352-5326 www.ecolab.com
Diversey , Livonia, MI 800-521-8140
Klenzade Products Division of Ecolab St. Paul, MN 612-293-2165
Wesmar Company, Inc. Seattle, WA 206-783-5344 www.wesmar.com
Anderson Chemical Co. Litchfield, MN 800-366-2477 www.andersonchemical.com

SUPPLIER

Ecolab, Inc. , St. Paul, MN 800-352-5326 www.ecolab.com
Diversey , Livonia, MI 800-521-8140

Motor Base/Control Panel

1. Unplug the power cord.
2. Gently wash the outside surface with a damp soft cotton cloth moistened with a mild solution of warm water and nonabrasive detergent or nonabrasive liquid spray cleaner. **NEVER IMMERSE MOTOR BASE IN WATER OR OTHER LIQUID.**
3. Thoroughly clean switches so that they work freely. They may become sticky. Use a wet cloth, moistened with water* and a mild detergent, to clean around the edges of the switch paddles until they function freely. Work the switches back and forth a few times to loosen any dried residue under switch. Leaving switches sticky will damage or burn out the switches. Clean carefully, using caution not to allow water or other liquids to infiltrate the switch.
4. Dry with a soft cotton cloth.

* Be sure to wring excess water out of cloth or sponge when cleaning around the controls or any electrical part.

Lid

Separate the lid and plug. Wash in warm soapy water. Rinse clean under running water and dry. Reassemble before use. (See page 6-7.)

Container

For maximum container life, do not wash in dishwasher.

1. To Clean: Fill container 1/4 full with warm (110°F/43°C) water and add a couple drops of liquid dishwashing detergent.** Return container to motor base and firmly position the two-piece lid. Run machine for 30 seconds. Empty container. Repeat this step.
2. To Rinse: Fill container 3/4 full with warm (110°F/43°C) water – do not add soap. Return container to motor base and firmly position the two-piece lid. Run machine for 30 seconds. Empty container.
3. If any solid residue remains, remove the blade assembly (see page 10) and wash all container parts in warm soapy water. Rinse and drain. Reassemble before next step. Do not soak the blade agitator assembly.
4. To Sanitize: If all solid residue is gone after step 2 or after completion of step 3, fill container 3/4 full with a sanitizing solution mix.*** Return container to motor base and firmly position the two-piece lid. Run machine on a high speed for 30 seconds. Turn machine off and allow mixture to stand in the container for an additional 1-1/2 minutes. Pour out bleach mixture.
5. Return container to motor base and run machine empty for an additional 5 seconds. Do not rinse after sanitizing. Allow container to air dry.

** To prolong polycarbonate container life, Vita-Mix recommends using soaps with a low Ph balance, such as a liquid dishwashing detergent (Ivory Liquid®). Due to the nature of polycarbonates, automatic dishwashing is not recommended.

*** Recommended sanitizing solution: 1.5 tsp. / 7.4 ml institutional or household bleach in 2 qt. / 2.0 Ltr. water.

Parts List

BarBoss® and Drink Machines

NOTE: Vita-Mix® blenders come in several similar styles. Please be sure you are following the parts list for your blender model.

Item #	Part
755	Lid plug for 64 oz. / 2.0 Ltr. polycarbonate container
1192	Lid only (no plug) for 64 oz. / 2.0 Ltr. polycarbonate container
1191	Lid assembly for 64 oz. / 2.0 Ltr. polycarbonate container
756	64 oz. / 2.0 Ltr. polycarbonate container, ice blade & lid assemblies
758	64 oz. / 2.0 Ltr. polycarbonate container only
1159	Lid plug for 48 oz. / 1.4 Ltr. polycarbonate/stackable container
15526	Lid only (no plug) for 48 oz. / 1.4 Ltr. polycarbonate/stackable container
15507	Lid assembly for 48 oz. / 1.4 Ltr. polycarbonate/stackable container
15506	48 oz. / 1.4 Ltr. polycarbonate/stackable container, ice blade & lid assemblies
15502	48 oz. / 1.4 Ltr. polycarbonate/stackable container only
1151	Blade agitator assembly (ice blade)
836	Heavy-duty retainer nut
791	Sound-reducing centering pad
891	Drive socket
PLS207	Variable speed control knob / timer control knob
760	Accelerator Tool
PLS112	Rubber Feet
XDM034	Use and Care manual (not shown)

NOTE: Other than the drive socket, blade assembly and retainer nut, this unit is not user serviceable.

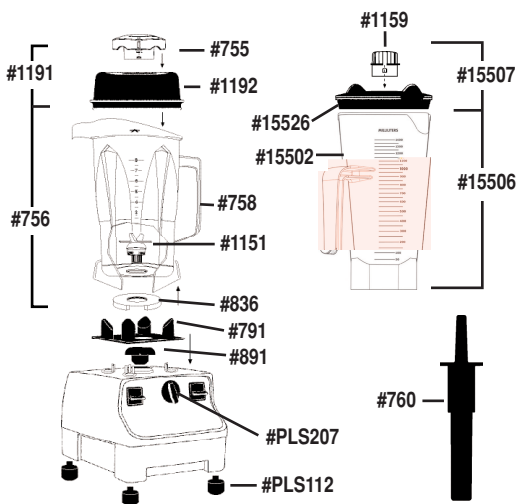

Items Sold Separately:

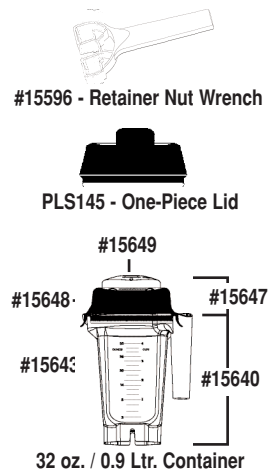

Vita-Pro® and Vita-Prep®

NOTE: Vita-Mix blenders come in several similar styles. Please be sure you are following the parts list for your blender model.

Item #	Part
755	Lid plug for 64 oz. / 2.0 Ltr. polycarbonate container
1192	Lid only (no plug) for 64 oz. / 2.0 Ltr. polycarbonate container
1191	Lid assembly for 64 oz. / 2.0 Ltr. polycarbonate container
1195	64 oz. / 2.0 Ltr. polycarbonate container, wet blade & lid assemblies
758	64 oz. / 2.0 Ltr. polycarbonate container only
1159	Lid plug for 48 oz. / 1.4 Ltr. polycarbonate/stackable container
15526	Lid only (no plug) for 48 oz. / 1.4 Ltr. polycarbonate/stackable container
15507	Lid assembly for 48 oz. / 1.4 Ltr. polycarbonate/stackable container
15504	48 oz. / 1.4 Ltr. polycarbonate/stackable container, wet blade & lid assemblies
15502	48 oz. / 1.4 Ltr. polycarbonate/stackable container only
1152	Blade agitator assembly (wet blade)
836	Heavy-duty retainer nut
791	Sound-reducing centering pad
891	Drive socket
PLS207	Variable speed control knob / timer control knob
760	Accelerator Tool
PLS112	Rubber Feet
XDM034	Use and Care manual (not shown)

NOTE: Other than the drive socket, blade assembly and retainer nut, this unit is not user serviceable.

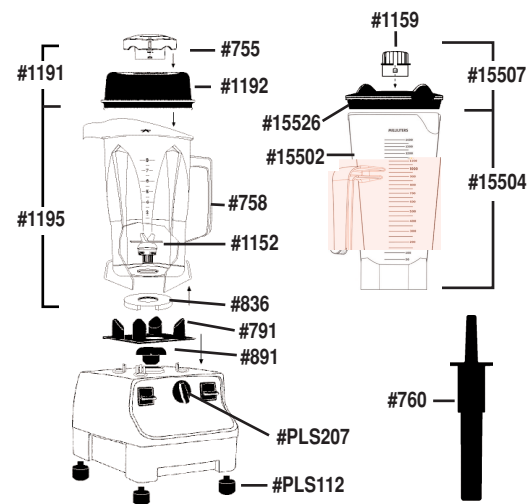

Items Sold Separately:

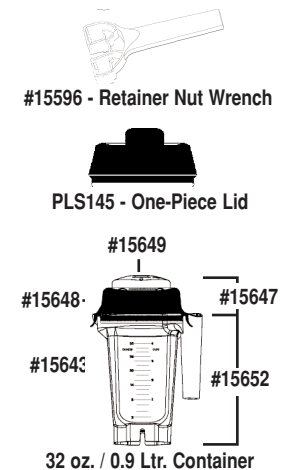

Troubleshooting

<p>1. Problem:</p> <ul style="list-style-type: none"> • Increased vibration • Leaking from bottom of container • Increased container noise 	<p>Solution #1: Check blade assembly for loose, damaged or nicked components and replace.</p> <p>Solution #2: Tighten retainer nut with retainer nut wrench moving clockwise until it is snug. See page 10.</p>
<p>2. Problem:</p> <ul style="list-style-type: none"> • Machine will not run 	<p>Solution #1: Double-check to make sure power cord is firmly in power outlet.</p> <p>Solution #2: Check to make sure switches are clean and moving freely.</p> <p>Solution #3: The thermal protector may have shut the machine off. Turn power off for up to 45 minutes to reset. Note: Cooling may be quickened by placing the motor base in a cool spot. (Unplug first.) Try circulating the air with a fan or vacuum aimed at the bottom of the motor base.</p>
<p>3. Problem:</p> <ul style="list-style-type: none"> • Loud noise from blade area • Blades don't spin 	<p>Solution: Drive Socket may be broken. Check for a fine crack down the center or worn teeth – replace with a new drive socket (Item #891). Instructions are included with part.</p>
<p>4. Problem:</p> <ul style="list-style-type: none"> • BarBoss Pulse/Timer Blender will not run when START/STOP TIMER switch is activated 	<p>Solution: Check ON/OFF power switch to make sure the switch is in the ON position.</p> <p>Note: START/STOP TIMER switch is lit when power is on.</p>

Cooling the motor:

Machine may stop working if it is overloaded on low speed. Reset by turning power off for 30 seconds. Do not turn power off midway through a blending cycle. To interrupt cycle, press START/STOP TIMER switch one time. See page 4.

If you cannot fix your machine with these suggestions, technical help is available by calling **800-4DRINK4 (800-437-4654)** or **440-235-0214**. If outside the United States and Canada, contact your local Vita-Mix Distributor or telephone the Vita-Mix International Division at +1.440.782.2450 or email international@vitamix.com for a distributor in your country.

Specifications

Dimensions:

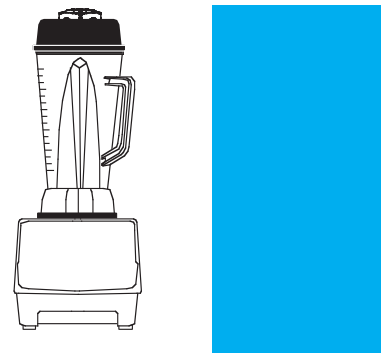

.....64 oz. / 2.0 Ltr.

Overall Dimensions of 64 oz. / 2.0 Ltr. Polycarbonate Container with lid and base:
20 in. / 51 cm High x 8 in. / 20.3 cm Deep x 9 in. / 22.9 cm Deep

Overall Dimensions of 48 oz. / 1.4 Ltr. Polycarbonate Container with lid and base:
17.5 in. / 44 cm High x 8 in. / 20.3 cm Wide x 9 in. / 22.9 cm Deep

Ship weight of machine: 13 lbs. / 5.9 kg

Power Requirements:

Volts: 120 VAC
Amps: 11.5 (2+ peak hp*)
 12.5 (3+ peak hp*)
Hz: 50/60

Volts: 220-240 VAC
Watts: 750-850 (2+ peak hp*)
Watts: 1100-1200 (3+ peak hp*)
Hz: 50/60

Volts: 100 VAC (Japan)
Watts: 900 (2+ peak hp*)
Watts: 975 (3+ peak hp*)
Hz: 50/60

Volts: 120 VAC EMC (Taiwan)
Amps: 11.5 (2+ peak hp*)
Hz: 60

*varies with voltage

Warranty

Limited Warranty

Vita-Mix® Corporation warrants your Commercial Vita-Mix machine to be free from defects in materials and workmanship for a period of three years from the date of purchase when used in accordance with the accompanying instruction booklet.

Provisions of this limited warranty are void if your Vita-Mix machine has been subjected to obvious abuse, negligence, accident, alteration, or failure to follow operating instructions, or product exposure to abnormal or extreme conditions. Cosmetic changes such as discoloration of parts of the product in the hands of the user or the effects of the use of abrasive cleaners will not be warranted or considered defects. The cleaning or removal of food products along with any damage caused by allowing them to build up is not covered by this limited warranty. Warranty is void if the Vita-Mix machine is put into a sound reduction chamber that does not allow proper cooling.

In the event your Vita-Mix machine needs service or repair covered by the terms of this warranty, please call the Vita-Mix Corporation for shipping instructions. The Vita-Mix machine must be sent in original or sufficient packaging.

This limited warranty is in lieu of any other warranty expressed or implied. No representative or any other person is authorized to make any other warranty or to assume any liability not strictly in accordance with the foregoing. This limited warranty gives you specific legal rights which may vary from state to state. Proof of purchase may be required to prove date of purchase.

Outside the United States and Canada, other warranties may apply. Call or check with your Vita-Mix Distributor for details or telephone the Vita-Mix International Division at +1.440.782.2450 or email international@vitamix.com.

In case of shipping damage, notify the shipper or carrier immediately. Outside the United States and Canada, contact your local Vita-Mix Distributor.

Service Contract

PLEASE NOTE: The Service Contract outlined in the following paragraphs applies only to customers in the United States and Canada. Customers in all other countries should contact their local Vita-Mix® Distributor for service details.

This Vita-Mix machine includes a 1-Year Service Contract effective from date of purchase. In the event your machine should need parts or repairs covered under this Service Contract, call Vita-Mix Customer Service immediately for instructions. Proof of date of purchase may be required. This does not cover abuse, misuse, tampering, improper installation or extreme conditions.

The Vita-Mix Service Contract includes the following:

1. One extra drive socket – to facilitate simple repairs and prevent down time – is included and packaged with each machine.
2. Additional drivers and accelerator tool, unless defective, are not covered. **NOTE:** to determine if you have a defective part, please order a replacement part through Vita-Mix Customer Service and, when the new part arrives, return the old part in the same packaging. Vita-Mix will inspect the returned part and, if defective, issue a refund for the price of the new part. A part will be considered defective if no abuse or neglect was involved with its break. Non-defective parts sent to Vita-Mix for inspection will not be returned if deemed unusable. Service Contract covers functionality of the machine but not abuse or lack of recommended maintenance.
3. In the Continental United States, sender pays freight one way to Vita-Mix Corporation. The Vita-Mix Corporation will pay UPS ground freight charges to return the machine to the sender. Sender pays costs for special shipping requests. **Outside the Continental United States, other service contracts may apply.**

Before returning this product for any reason, including repair, please first contact our **Customer Service Department**. In the US and Canada, call **800-4DRINK4 (800-437-4654) or 440-235-0214 to receive a “RETURN AUTHORIZATION” NUMBER. Any return without a “Return Authorization” Number will not be processed and will be returned to sender.** Outside the United States, contact your local Vita-Mix Distributor.

NOTE: Within the United States, Limited Warranty and Service Contract are honored directly through the Vita-Mix Corporation, Cleveland, Ohio USA. Non-warranty repairs can be performed by any CFESA service center. For machines sold in the United States, call Vita-Mix: 800-4DRINK4 (800-437-4654) or 440-235-0214. If you live outside the United States or Canada, contact your local Vita-Mix Distributor, or telephone the Vita-Mix International Division at +1.440.782.2450 or email international@vitamix.com for a distributor in your country.

Additional Vita-Mix® Accessories Available!



To rinse containers quickly between servings, the **Vita-Mix Rinse-o-matic®** is ideal. Rinses clean in seconds!
Item #1410



To scrub tough ingredients, use the new **Vita-Mix Container Brush**. Soft, flexible fibers scrub in seconds but won't scratch!
Item #15639



For more information on these accessories, call 800-4DRINK4 (800-437-4654) or 440-235-0214. If you live outside the United States or Canada, contact your local Vita-Mix Distributor or telephone the Vita-Mix International Division at +1.440.782.2450 or email international@vitamix.com for a distributor in your country.

To see the complete line of Vita-Mix products, visit www.vitamix.com/foodservice



VITA-MIX® CORPORATION
Foodservice Division

8615 Usher Road, Cleveland, Ohio 44138-2103 USA

©2006 Vita-Mix Corporation. No part of this publication may be reproduced or transmitted in any form or by any means, electronic or mechanical, including photocopy, recording or any information storage and retrieval system without the written permission of the Vita-Mix Corporation.

Free Manuals Download Website

<http://myh66.com>

<http://usermanuals.us>

<http://www.somanuals.com>

<http://www.4manuals.cc>

<http://www.manual-lib.com>

<http://www.404manual.com>

<http://www.luxmanual.com>

<http://aubethermostatmanual.com>

Golf course search by state

<http://golfingnear.com>

Email search by domain

<http://emailbydomain.com>

Auto manuals search

<http://auto.somanuals.com>

TV manuals search

<http://tv.somanuals.com>