

VIV-CV-530V

Digital Binocular Camera

User Manual



Vivitar[®]
we make it easy[™]

© 2011 Sakar International, Inc. All rights reserved.

Windows and the Windows logo are registered trademarks of Microsoft Corporation.

All other trademarks are the property of their respective companies.

Table of Contents

| | |
|--|----|
| Introduction..... | 3 |
| Camera Maintenance and Care..... | 3 |
| Key Features | 4 |
| What's Included | 4 |
| Computer System Requirements..... | 5 |
| A Quick Look at Your Camera | 6 |
| Preparing Your Camera for Use | 7 |
| Starting Your Camera..... | 8 |
| Taking Photos..... | 9 |
| The Camera Modes | 10 |
| Installing the Vivitar Experience Image Manager Software and Camera Driver | 15 |
| Connecting your Camera to the Computer | 16 |
| Getting Photos and Videos from your Camera to your Computer..... | 16 |
| Getting Started! | 17 |
| Using Your Camera as a Webcam | 18 |
| Sakar Warranty Card..... | 20 |
| Technical Support..... | 21 |
| Technical Specifications | 21 |
| Frequently Asked Questions..... | 22 |

Introduction

Thank you for purchasing your VIV-CV-530V 5 X 30 Digital Binocular Camera. This camera can be used as a digital camera, binoculars as well as a Webcam. To download photos and videos to your computer, captured with this easy to use, portable and compact device, you need only connect the USB cable from your computer to your camera after installing the **Vivitar Experience Image Manager** Software and camera driver.

The **Vivitar Experience Image Manager** will help you get the most out of your camera. It is packed with powerful, yet easy to use features that allow you to share your photos and videos with friends and family.

Everything you need to take quality digital photos and videos is included with your camera. Please read this manual carefully **FIRST** in order to get the most out of your digital camera.

Important Notice:

Please do not plug the camera into the USB port of your computer until you have installed the Vivitar Experience Image Manager Software and the camera's driver. Plugging in your camera at this stage will cause the device to not be recognized by the computer and no images will be downloaded.

Note: Webcam Feature: In order to speak with your friends over the Internet, you will need a headset and microphone available at your local computer retailer.

Camera Maintenance and Care

The digital telescopic camera is a precision device and must be kept and used carefully.

Care must be taken that:

1. Your camera does not fall or collide with any hard object
2. Not used close to or in water or rainy weather
3. Not be used in very hot, very cold or moist environments
4. Not be used in situations where there is high vibrations
5. **DO NOT USE** the binocular to view the sun directly

Key Features

- **Vivitar Experience Image Manager** Software for managing and enhancing your photos, printing, sending photos by e-mails, effortlessly upload to your social network accounts and much more
- 2 camera resolutions – 320 x 240 (QVGA), 640 x 480 (VGA)
- 16 Megabytes Built-in SDRAM Memory
- Self-timer for photos
- Easy short video capture
- Fluorescent lighting settings for 50/60 Hz
- LCD display to show the image counter and status
- USB connector for fast downloads
- Delete last picture or all pictures
- Auto power off to conserve battery life

What's Included

- Digital Binocular Camera
- Vivitar Experience Image Manager Software and driver installation CD
- USB cable
- Neck Strap
- Quick Start Guide

Computer System Requirements

To be able to download photos and videos to your PC or Macintosh, you will need the following minimum configuration:

WINDOWS OS

Microsoft® Windows XP with Service Pack 3, Windows Vista with Service Pack 1 or Windows 7

Pentium® 4 processor (or above)

250 MB available hard disk space

512 MB of RAM

16-bit Color display, 1024 X 768 recommended screen resolution

CD-ROM Drive

QuickTime® 6 or higher

Microsoft® Internet Explorer 7 or higher

Windows Media Player 10 or higher

Internet connection required to access social networks and web conferencing applications

MAC OS

Intel processor running Mac OS X v10.5.x or later

250 MB free hard disk space

256 MB RAM

Display: 1024 X 768 recommended screen resolution

QuickTime® 6 or higher

Internet connection required to access social networks and web conferencing applications

A Quick Look at Your Camera

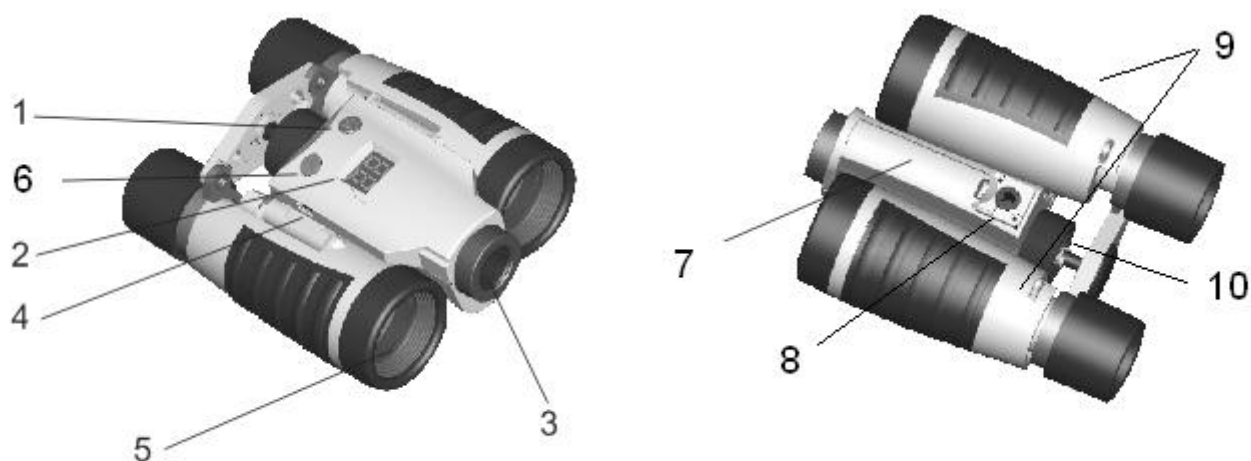

1. M - Power / Mode button
2. LCD Panel
3. Optical Lens
4. USB Slot
5. Telescope and Viewfinder
6. S – Shutter / OK button
7. Battery Compartment
8. Tripod socket
9. Barrels
10. Focus Wheel

Preparing Your Camera for Use

Battery Installation

Your camera requires one (1) AAA battery. Alkaline battery recommended.

Insert the battery into the camera:

1. Open the battery cover at the bottom of the camera.
2. Insert the battery according to the polarity (+ and -) indicated on the inside of the battery compartment.
3. Close the battery cover.

WARNING: Opening the battery compartment and/or removing the battery will erase the photos currently stored in the camera. Download your photos and videos as often as possible so as not to lose them. Photos may also be lost when the batteries runs low.

The LCD will flash when your batteries are running low. This indicates that the battery should be replaced. Remember, before you open the battery compartment to change the battery, please download your photos you have on the camera. When the battery voltage drops, the LCD will display “Lo” and the camera will turn off automatically.

Note: If you do not intend to use your camera for an extended period, remove the battery to avoid leakage and corrosion.

Starting Your Camera

Press the **M – Power / Mode** button on the top of the camera to turn on the camera. The camera will emit a beep to confirm that your camera is on and ready for use.

Energy Saving Feature:

To conserve battery power, if the camera is not in use for 30 seconds, it automatically switches off.

Note: In order to download the photos and videos captured with this camera you need to install the Vivitar Experience Image Manager Software and camera driver. See the “Installing the Vivitar Experience Image Manager Software and Camera Driver” section of this manual to learn how to install the software before connecting the camera to your computer.

Taking Photos

Capturing Pictures

1. Compose your shot by looking through the telescope view finder with both eyes focused.
2. Aim the binocular in the direction of the object you wish to capture.
3. Adjust the IPD (the distance between 2 eyes) by holding the binocular with both hands and pushing or moving one or both of the barrels until you can see one circle of view.
4. Focus the camera by observing an object at least 15 feet / 5 meters away.
5. Rotate the center focus wheel until the observed object is clear.
6. Hold the camera steady and press the **Shutter** button to take a photo.
7. The camera will beep when the photo is taken. The number of photos left to take in that resolution is displayed on the LCD screen.

Note: If there are more than 99 photos left to take, the hundreds digit will appear on the LCD for a split second when you take the photo. Thereafter the last two digits will appear.

How to Proceed when your Camera Memory is Full

If the camera beeps twice continuously or if a "□□" appears on the LCD, this is an indication that the memory is full. When the camera memory is full no further photos can be taken until the existing photos have been downloaded and cleared from the camera's memory.

In order to continue taking photos you will need to:

1. Use the Vivitar Experience Image Manager application to download all the photos and videos from you camera to your computer.
2. After the photos have been downloaded and appear on your computer, you should delete all the photos from your camera.
3. Once your camera memory is empty you are now ready to capture more photos and videos.

The Camera Modes

Navigating the Camera Modes

To enter the different camera modes, continue to press the **MODE** button until you have selected the mode of your choice. Once you have selected the mode, press the **Shutter** button to confirm your choice.

Powering On Your Camera

To power on your camera, press the **MODE** button.

Powering Off Your Camera

To power off your camera:

Power Off Mode

1. Press the **MODE** button until the  icon appears on the LCD screen.
2. Press the **Shutter** button and the camera will switch off.

Note: Energy save mode

In order to conserve battery power, if the camera is not used within 30 seconds, the camera will automatically switch off.

Continuous Shoot Mode

When enabled, the Continuous Shoot mode allows you to take continuous rapid snapshots with a single click of the Shutter button.

This feature can be effective when trying to capture a particular moment in a sporting event or other scenes with quick movements.

1. Press the **MODE** button until the  icon appears on the LCD screen.
3. Press and hold down the **Shutter** button for the camera to continuously capture photos.
4. The camera will beep for each image being captured and the countdown digits will appear while the images are being taken.

5. Lift your finger off the **Shutter** button to stop capturing images.

Note: The photos will continue to be taken until the Shutter button is released or the camera's memory is full.

6. The photos will be saved as JPEG images.

Note: Photos taken in Continuous Shoot Mode may fail under poor lighting conditions.

Video Mode **RI**

Video mode allows you to capture videos that are saved in AVI format.

1. Press the **MODE** button until the **RI** icon appears on the LCD screen.
2. To begin capturing video, press and hold down the **Shutter** button until you want to stop shooting the video or until the memory is full. While the camera is capturing the video, the LCD screen displays rotating-lines.
3. The video is automatically saved to the camera's memory.

Note: As this is a twain camera you will need to download the photos and videos to the computer often in order not to lose them. If the battery runs low before you have downloaded the images, all the images in the camera's memory will be erased without being able to retrieve them.

Self-Timer Mode **SE**



The Self-Timer feature allows you to set a delay between the time that the camera's Shutter button is pressed and the actual capture of the picture. This is an optimal feature if you don't just want to take the picture but would also like to be in the picture yourself.

It is recommended that you place the camera on a flat surface or use a tripod stand when you use the Self-Timer.

1. Press the **MODE** button until the **SE** icon appears on the LCD screen.
2. Press the **Shutter** button.
3. A 10 second count down will start (the camera will beep once a second).
4. After 10 seconds a photo will be taken.

Clear Last Mode (Delete Last Photo) -

To delete the last photo taken:

1. Press the **MODE** button until the  icon appears on the LCD screen.
2. Press the **Shutter** button. The LCD display then flashes .
3. Press the **Shutter** button again within 5 seconds and the last photo will be deleted permanently.
4. The LCD counter then displays the updated maximum number of photos that can be taken at the current resolution and compression.

Clear All Mode (Delete All Photos)

To delete all photos on the camera:











1. Press the **MODE** button until the  icon appears on the LCD screen.
2. Press the **Shutter** button. The photo counter flashes.
3. Press the **Shutter** button again within 5 seconds and all photos in the camera will be permanently deleted.
4. The LCD counter is reset to show the maximum number of photos that can be taken at the current resolution and compression.

Photo Resolution Mode

There are 2 photo resolutions to select from:

 (VGA resolution) or  (QVGA resolution)

1. Press the **MODE** button until the  or  icon appears on the LCD screen.
2. If the LCD displays , this means the present resolution is Low resolution  and in order to change to High resolution  click the **Shutter** button within 5 seconds.
3. If the LCD displays , this means the present resolution is High resolution  and in order to change to Low resolution  click the **Shutter** button within 5 seconds.
4. All photos taken after changing the resolution setting will be taken at the new resolution.

5. The photo resolution setting can be changed at any time.
6. The amount of pictures that can be taken at the selected resolution appears on the LCD screen.
7. As there are only 2 digits on the screen, the camera will flash the hundreds digits before showing the tens and units digits on capturing a picture in order to show you how many pictures you can continue to take at that resolution.

Compression Mode *CP* / *nP*

Your camera gives you an additional mode to compress your images so that you can capture more pictures.

There are 2 photo compressions to select from:

Non-Compressed - *nP* and Compressed - *CP*

By default your camera is in non- Compressed *nP* mode. If you are in the non-Compressed mode the opposite mode *CP* icon will appear on the LCD. This means that you are in the *nP* mode.

1. Press the **MODE** button until the *nP* or *CP* icon appears on the LCD screen.
2. If the LCD displays *nP*, this means the image is in compressed mode *CP* and in order to change to no compression *nP* click the **Shutter** button.
3. If the LCD displays *CP*, this means the present compression is no compression *nP* and in order to change to compression mode *CP* click the **Shutter** button.
4. All photos taken after changing compression will be at the new compression.
5. The compression setting can be changed at any time.
6. The amount of pictures that can be taken at the selected compression appears on the LCD screen.
7. As there are only 2 digits on the screen, the camera will flash the hundreds digits before showing the tens and units digits on capturing a picture in order to show you how many pictures you can continue to take at that resolution.

Note: Photos taken at no compression take up more of the camera's memory and therefore fewer photos can be taken at non-compression than with compression.

The photo resolution and compression settings determine the number of photos that can be taken and the amount of memory required for each photo.

The following table tells you how many photos can be taken based on the image resolution and compression:

Number of Captured Photos (According to Resolution and Compression settings)

| Resolution | Compression | |
|----------------------------|--------------------|------------|
| <i>Hr</i> VGA (640 x 480) | <i>nP</i> | 20 photos |
| <i>Hr</i> VGA (640 x 480) | <i>CP</i> | 40 photos |
| <i>Lr</i> QVGA (320 x 240) | <i>nP</i> | 80 photos |
| <i>Lr</i> QVGA (320 x 240) | <i>CP</i> | 160 photos |

Frequency - *FS* / *FB*

The camera has 2 Frequency settings:

FS - 50HZ for Asia and Europe and *FB* - 60HZ for the U.S. and Japan.

To set the camera for the correct frequency:

1. Press the **MODE** button until the *FS* or *FB* icon appears on the LCD screen.
2. If the LCD displays *FS*, this means the present frequency is 60HZ *FB* and in order to change to 50HZ *FS* click the **Shutter** button.
3. If the LCD displays *FB*, this means the present frequency is 50HZ *FS* and in order to change to 60HZ *FB* click the **Shutter** button.
4. All photos taken after changing frequency will be at the new frequency.
5. The frequency setting can be changed at any time.

Note: Using the incorrect frequency setting under fluorescent lighting could result in poor images or video flickering (when using the WebCam). Set the camera for the correct frequency for the country that you are in.

Installing the Vivitar Experience Image Manager Software and Camera Driver

Warning: Do not plug your camera into the computer until the Vivitar Experience Image Manager Software installation is complete.

1. Insert the installation CD into your CD-ROM drive. The Vivitar Experience Image Manager will begin to install.
2. Please review the license terms.
On PC and Macintosh: Click the “I accept the terms of this license agreement” and then click “Next” to continue.
3. On PC only: Let the “Vivitar Experience Image Manager” installer create the folder to where the program will be installed, and then click “Install”.
4. Please wait while the application continues the installation process on your computer. Follow all instructions.
Note: On the MAC: A window to ‘Install Camera Drivers’ opens. Click ‘Install’ then click ‘Close’ once installation is complete.
5. On PC: Click the “Close” button when the installation is complete.
The application automatically opens.
On MAC: Close the ‘Perian pane’ System Preferences window that appears as the last step in the installation.
The application automatically opens.
6. If you closed the application, click on the Vivitar Experience Image Manager from your computer to open and run the application.



Connecting your Camera to the Computer

1. Use the USB cable that came with your camera to connect your camera to your computer.
2. Plug the one end of the USB cable into the USB slot on the side of the camera and plug the other end into an available USB port on your computer.
3. Your camera will automatically turn on.
4. The first time you connect the device to the computer you will have to wait a few moments until the computer recognizes the device.

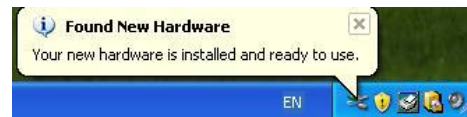

Getting Photos and Videos from your Camera to your Computer

Important: Do not disconnect the cable during transfer. Doing so will cancel the transfer of any files on their way to your computer.

1. Select the "Get Images" button from the Main menu.



2. The “Get Images from device” window opens.
3. You can select to download photos, videos or both.
4. Select your camera (removable disk) from the device window. If your camera is the only USB device connected then it will be selected automatically.
5. Select a location on the computer where to place the new photo and video files.
6. Add the new photo and video files to albums if desired.
7. Select to remove the media files from the selected device (removable disk) after the import.
8. Click the “Get Media” button to transfer the photos and videos from your camera to your computer.
9. A media download progress bar appears on the bottom left showing the number of media files downloading to your computer. A message appears when the download is complete.
10. The photo and video files that you selected are now downloaded to your computer to the selected folder and albums ready for your use.

Getting Started!

Using the Vivitar Experience Image Manager, you can:

- Upload and manage photos and videos to and from the most popular photo sharing and social networking sites - Facebook, Flickr, Picasa, MySpace, Photobucket, Twitpic, Twitgoo and YouTube
- Seamlessly transfer photos and videos from one social network to another
- Organize your images by creating offline and online albums
- Edit images using automatic and manual tools
- Use automatic “Geotagging” with built in Google Maps

For more details on how to use the Vivitar Experience Image Manager open the ‘Help guide’ from the Help menu or click the “Take a Tour” button on the application’s Home page.

Using Your Camera as a Webcam

Your camera, when plugged into your computer, can also be used as a Webcam with most instant messenger and web conferencing applications that support video.

On PC: The webcam driver is installed on your computer when you install the Vivitar Experience Image Manager Software for this device.

1. Open your web conferencing application to activate the video camera option.
2. Rotating lines will appear on the camera's LCD screen to show that it is active and in webcam mode.
3. Place your camera as desired and begin to use as a webcam.

Note:

- Use the settings option of your web conferencing application to change the settings if needed.
- If you have a built-in camera on your computer, use the settings option of your web conferencing application to choose this 'Dual Mode Camera'.
- The camera does not have a microphone.

On Mac: The webcam driver is installed on your computer when you install the Vivitar Experience Image Manager for this device.

To preview the webcam video feature and open the Webcam application window, please follow these instructions:

1. Click the "Macintosh HD" icon on the desktop
2. Click the "Library" folder
3. Click the "QuickTime" folder
4. Click the "DT03_pccam" to open the Webcam application for Mac.
5. Once you see the object appearing in the Webcam application window, close the window and open your instant messenger or web conferencing application to begin using this camera as a webcam on your computer.

Note:

- Use the Control menu / Video settings option of this web conferencing application to change the settings if needed.
- If you have a built-in camera on your computer, use the settings option of your web conferencing application to choose this 'Dual Mode Camera'.
- The camera does not have a microphone.

After you connect your camera to your computer, the camera will remain on all the while it is plugged into the USB and it won't be switched off. On disconnecting the USB cable the camera will automatically switch off.

Sakar Warranty Card

This warranty covers for the original consumer purchaser only and is not transferable.

Products that fail to function properly **UNDER NORMAL USAGE**, due to defects in material or workmanship. Your product will be repaired at no charge for parts or labor for a period of one year.

What Is Not Covered By Warranty:

Damages or malfunctions not resulting from defects in material or workmanship and damages or malfunctions from other than normal use, including but limited to, repair by unauthorized parties, tampering, modification or accident.

What To Do When Service Is Required:

When returning your defective product (postage pre-paid) for service, your package should include:

1. Copy of **original** bill of sale
2. A detailed written description of the problem.
3. Your return address and telephone number (Daytime)

MAIL TO ADDRESS BELOW:

| <u>Sakar US</u> | <u>Sakar UK/Europe</u> | <u>Sakar Australia</u> |
|---|---|--|
| Sakar International Attention: Service Department 195 Carter Drive Edison, NJ 08817 | Attention: Service Department 2D, Siskin Parkway East 4020 Middlemarch Business Park Coventry, CV3 4PE | Return faulty camera to the Refund Counter at the store where purchased |

Technical Support

For technical support issues please visit our website at www.vivitar.com. You can find manuals, software and FAQ's at the website. Can't find what you are looking for? E-mail us at support@vivitar.com and one of our technical support team members will answer your questions. For phone support in the US please call 1-800-592-9541, in the UK call 0800 917 4831, in Australia call 1800-006-614. If you would like to call from anywhere else, please visit www.vivitar.com for your local toll free number.

Technical Specifications

| | |
|-----------------------|--|
| Image Sensor | 1/5 inch CMOS |
| Image Specification | 640 x 480 (VGA); 320 x 240 (QVGA) |
| Memory | 16MB SDRAM |
| Number of pictures | Hr 20 VGA; Lr 80 QVGA (non- compressed) Hr 40 CIF; Lr 160 QVGA (compressed) |
| Lens | 1/5 inch Fixed Lens: f=3.9mm/F2.8 |
| AVI pixel format | 320 x 240pixels |
| Shutter speed Range | 1/60~ 1/1500 second |
| LCD display | 2 digit display |
| Self-Timer | Timer with 10 sec. delay |
| Frame rate | 12 frames per second |
| Video Frame rate | 8 frames per second in AI or Ct mode |
| Expose/ white balance | Auto/Automatic |
| Power source | 1 x 1.5V AAA alkaline / USB 5V |
| Auto power off | 30 sec. |
| PC interface | USB 1.1 |
| Operating systems | Windows XP (SP 3), Vista (SP1) and 7 Mac OSX v10.5.x and above |

Frequently Asked Questions

Q: I have taken photos, but my computer says "No photos in camera." What do I do?

A: Ensure that you have taken photos with your camera. Press the Shutter button a few times to take some sample photos and try again. If you still get a no photos error, this indicates that the software was not installed correctly or your computer may not meet the minimum system requirements (see the Computer System Requirements section of this manual).

Q: How do I make sure I don't lose important pictures?

A: Your camera uses SDRAM memory, which requires a constant electric current to store your photos. Should your camera lose power (for instance if the batteries die, run out of power or are removed) all stored pictures will be lost. We recommend always downloading your photos to your computer as soon as possible to prevent unintentional data loss.

Q: If I have a MAC, will the camera work?

A: Yes. This twain camera also works as a Digital Camera and Webcam on Macintosh computers. Be sure to follow all the installation instruction for installing the driver for this camera on your MAC.

Q: If the webcam does not work?

A: Make sure you have connected the camera correctly into an available USB port or hub and the webcam application is opened.

On first plugging the camera into the computer, allow the computer to recognize your camera first before opening the software or webcam application.

This device complies with the part 15 of the FCC rules. Operation is subject to the following two conditions: (1) this device may not cause harmful interference, and (2) this device must accept any interference received, including interference that may cause undesired operation.

Caution: changes or modifications not expressly approved by the party responsible for compliance could void the user's authority to operate the equipment.

NOTE: This equipment has been tested and found to comply with the limits for a Class B digital device, pursuant to Part 15 of the FCC Rules. These limits are designed to provide reasonable protection against harmful interference in a residential installation. This equipment generates. Uses and can radiate radio frequency energy and, if not installed and used in accordance with instructions, may cause harmful interference to radio communications. However, there is no guarantee that interference will not occur in a particular installation. If this equipment does cause harmful interference to radio or –television reception, which can be determined by turning the equipment off and on, the user is encouraged to try to correct the interference by one or more of the following measures:

- Reorient or relocate the receiving antenna.
- Increase the separation between the equipment and receiver.
- Connect the equipment into an outlet on a circuit different from that to which the receiver is connected.
- Consult the dealer or experienced radio/TV technician for help.

Free Manuals Download Website

<http://myh66.com>

<http://usermanuals.us>

<http://www.somanuals.com>

<http://www.4manuals.cc>

<http://www.manual-lib.com>

<http://www.404manual.com>

<http://www.luxmanual.com>

<http://aubethermostatmanual.com>

Golf course search by state

<http://golfingnear.com>

Email search by domain

<http://emailbydomain.com>

Auto manuals search

<http://auto.somanuals.com>

TV manuals search

<http://tv.somanuals.com>