

# DVR 925HD Digital Video Camera

## User Manual



**Vivitar**<sup>®</sup>  
we make it easy™

© 2010 Sakar International, Inc. All rights reserved.

Windows and the Windows logo are registered trademarks of Microsoft Corporation.

All other trademarks are the property of their respective companies.

## Contents

Introduction .....	2
What Your Camera Includes.....	2
Parts of the Camera .....	3
Initial Camera Setup.....	4
Main Camera Modes .....	6
Camera Technical Specifications.....	7
Computer System Requirements – Windows.....	8
Computer System Requirements – Macintosh .....	8
Charging the Lithium Battery .....	9
Using Your Digital Camera .....	9
Changing Camera Mode .....	10
Navigating the Menus.....	11
Photo Capture Mode .....	12
Photo Playback Mode .....	26
Video Capture Mode .....	32
Video Playback Mode.....	44
Connecting the Camera to the TV and HDTV .....	46
Installing the Software .....	48
Connecting the Camera to the Computer.....	49
Getting Photos and Videos from your Camera to Your Computer .....	50
Get started!.....	51
Transfer media from my camera to my computer manually (Using Windows).....	51
Transfer media from my camera to my computer manually (Using Macintosh).....	52
Camera Maintenance .....	52
Sakar Warranty Card.....	53
Technical Support.....	54
Troubleshooting.....	54

## Introduction

Thank you for purchasing this camera. Everything you need to take quality digital photos and videos is included with your camera.

Vivitar makes capturing those special moments as easy as possible.

**Note:** Your camera needs an SD Memory card (up to 32GB) for normal use.

SD Memory cards are not included and need to be purchased separately.

Please read this manual carefully first in order to get the most out of your digital camera.

## What Your Camera Includes

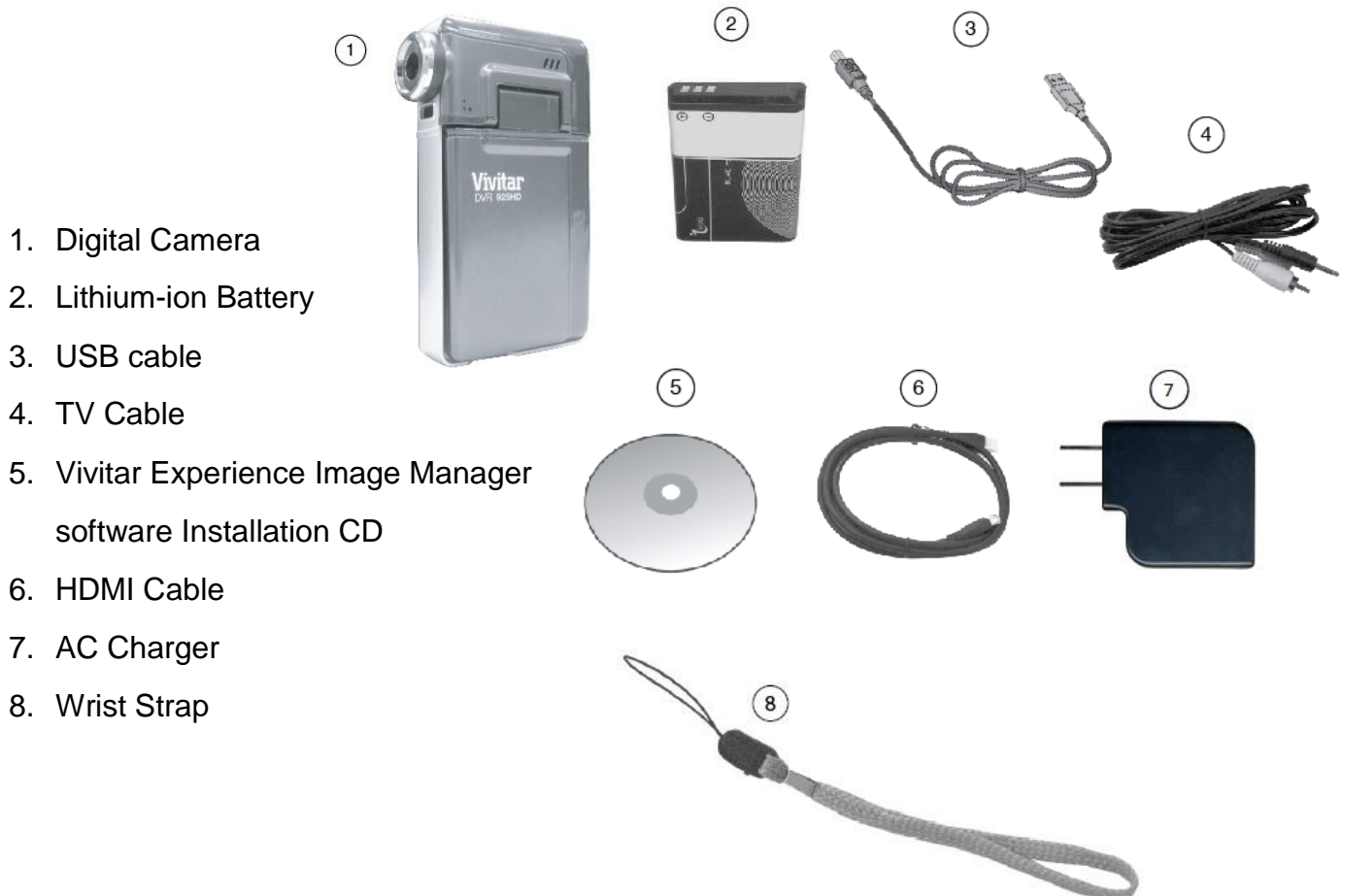

Note: SD Memory Card not included

## Parts of the Camera

1. Power button
2. Zoom Out/ Zoom In /OK/MENU Button
3. Photo Shutter Button
4. Video Shutter Button
5. Right /ViviLink Button
6. Left/LED Light Button
7. MODE button
8. USB Slot
9. TV-Out Slot
- 10.HDMI Slot
- 11.Wrist Strap Connector
- 12.Digital Lens
- 13.LCD Screen
- 14.LED Light
- 15.Memory Card Slot
- 16.Battery Compartment
- 17.Microphone
- 18.Speaker
- 19.Tripod Socket

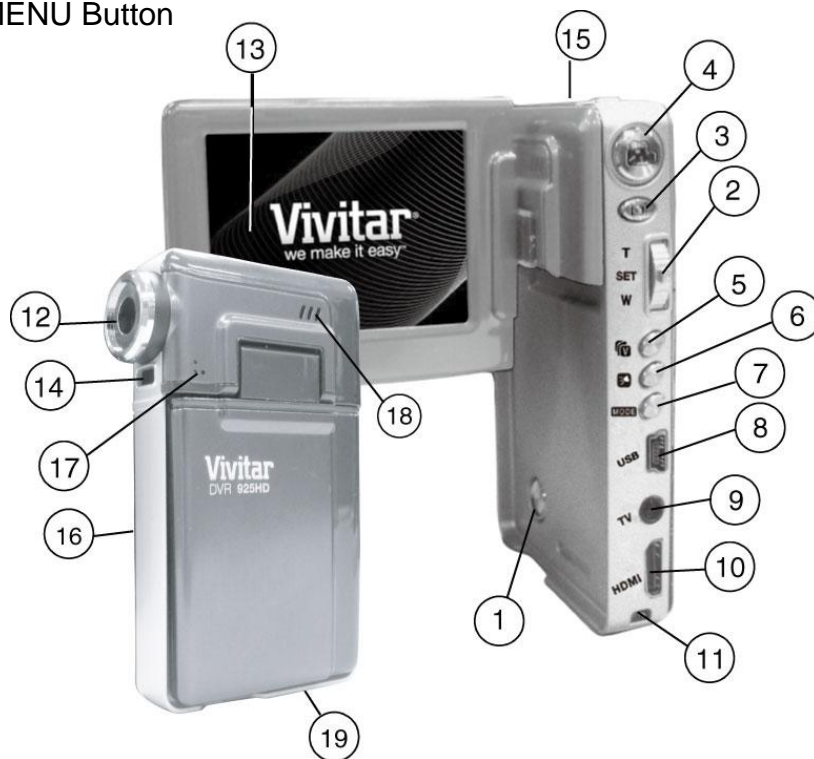

# Initial Camera Setup

## Installing the Battery



## Installing the Memory Card



- SD Memory card (up to 32GB) needed for normal use

## Turning On the Camera



## Using the Camera



Selecting the modes

Accessing the menu

When powering the camera ON for the first time you may manually go through and setup some of the features of your camera.

### Powering the Camera ON

- 1) Make sure the battery has been inserted properly into your digital camera.

First, open the battery compartment on the side of the camera.

Insert the battery in accordance with the polarity indicated.

Then return and close the battery cover.

- 2) Make sure an SD card has been inserted into your camera.

First, locate the SD card slot on the bottom of the camera.

Insert a compatible SD memory card correctly in the direction shown.

Then press the memory card until you hear a “Click” sound.

- 3) Flip and twist the LCD Screen open.

NOTE: The the LCD Screen can also be turned facing out so that you can see yourself within the scene you are capturing.

- 4) Press the POWER  button to turn on the camera.

### Setting the Camera Language

To select a language for the camera, press the **OK/Menu** button. Press the **Right/ViviLink Button** until the Language menu is viewed. Select the language of your choice and press the **OK** button to confirm the selection.

### Setting the Date and Time

To set the Date and Time as desired, press the **OK/Menu** button. Press the **Right/ViviLink Button** until the Date/Time menu is viewed, then scroll down by pressing down the **W/Zoom Out** button and select “Date Setup” and press the **OK** button to confirm the selection and move to the next part of the setup.

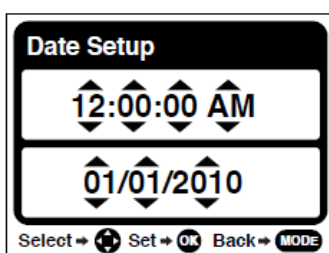

## Main Camera Modes

Your camera has different modes for the various camera functions.

You can switch modes by pressing the **MODE** button on your camera after the camera has been powered ON.



### Video Capture Mode

---

Use this mode to capture videos with your digital camera.

This is the default mode when the camera is powered ON. To take a video, aim your camera as desired and press the **Video Shutter** button to start the record. A red record indicator will appear on the LCD screen while record is in progress. To stop the record, press the **Video Shutter** button again. The video will be automatically saved to your camera's memory card.

To access the various menus for the Video Capture mode, press the **OK** button while in the Video Capture mode.



### Photo Capture Mode

---

Use this mode to capture pictures with your camera.

After turning on your camera, press the **MODE** button once to open the Photo Capture mode. To take a picture, aim your camera as desired and press the **Photo Shutter** button. The picture will be automatically saved to your camera's memory card.

To access the various menus for the Photo Capture mode, press the **OK** button while in the Photo Capture mode.



### Playback Mode (Photos & Videos)

---

Use this mode to view and manage the photos and videos on your camera.

After turning on your camera, press the **MODE** button twice to open the Playback mode for photos and videos. You can scroll through the photos and videos that you've previously taken to view, edit or delete them as desired. To access the various menus for the Playback mode for photos and videos, press the **OK** button while in the Playback mode.

## Camera Technical Specifications

Image Sensor	CMOS Sensor
Image Resolution	(8M) 3264x2448, (7M HD) 3648X2048 pixels, (5M) 2592x1944 pixels, (3M) 2048x1536 pixels, (2M) 1600x1200 pixels, (2M HD) 1920x1080 pixels and (VGA) 640x480 pixels
Video Resolution	1280x720 (25fps), 640X480pixels (30fps), 320X240pixels (30 fps)
File Format	JPEG/AVI
Internal Memory	1 Test Photo Use Only
External Memory	SD Card (up to 32GB)
LCD Display	2.4 Inch TFT
Lens	f=7.23mm F2.8, Fix Focus
Zoom	4X Digital Zoom
Exposure	-3.0EV ~ +3.0EV
White Balance	Auto, Daylight, Cloudy, Incandescent , Fluorescent
ISO	Auto / 100 / 200 / 400
Scene	Auto / Scenery / Portrait / Night Scenery / Night Portrait / High Sensitivity / Sport / Beach / Party
Flash	Auto/Force/Red Eye/Off
Self-Timer	2, 5 or 10 second delay
Anti-Shake	Yes
Micophone	Yes
Speaker	Yes
Print Photos	Yes
Face Detect	Yes
Smile Capture	Yes
Interface	USB 2.0 (HS)
System Requirements	Windows XP and above / Mac OSX 10.5 and above
Battery	Lithium Battery
Working Temperature	0~40 °C



## Computer System Requirements – Windows

To be able to download photos and videos to your PC, you will need the following minimum configuration:

- Pentium 4 processor or above with Windows XP service pack 2, Windows Vista or Windows 7
- 512 MB RAM, with 100MB of free disk space
- 1024 x 768 Recommended screen resolution
- 16-bit color or higher display adaptor
- CD-ROM Drive
- QuickTime 6 or higher
- Microsoft Internet Explorer 7 or higher
- Windows Media Player 10 or higher
- Internet connection required

## Computer System Requirements – Macintosh

Macintosh with Intel processor running Mac OS X v10.5 or later

- 256 MB RAM, 100 MB free disk space
- Display: 1024 x 768 or higher-resolution monitor
- QuickTime 6 or higher
- Internet connection required

## Charging the Lithium Battery

Only use the Lithium Battery that is included in the packaging.

To charge the Lithium Battery insert the battery into the camera in the direction as shown.

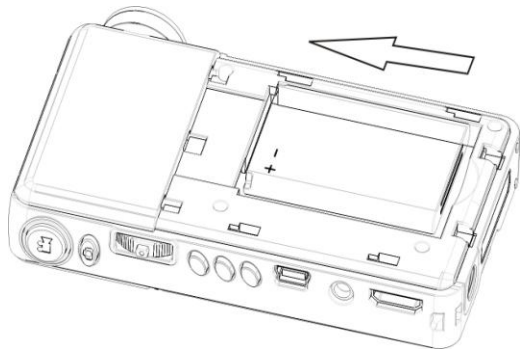

- 5) Make sure the camera is powered off.
- 6) Plug in the AC Adapter included in the package and connect the other end to the USB slot of the camera.
- 7) Alternatively, connect the USB cable to the USB slot on the camera and to the USB port of your computer.
- 8) The LED on the camera lights up.
- 9) When fully charged after a few hours the LED will turn off.

## Using Your Digital Camera

Make sure the batteries have been inserted properly into your digital camera. If your camera comes with a rechargeable lithium battery, make sure it is fully charged before the first use.

### Powering the camera ON

Press the Power button  to turn your camera ON. The camera will be in Video Capture mode to start.

## Powering the camera OFF

While the camera is on, you can press the Power button  again at any point to turn your camera OFF. You will see a “Goodbye” splash screen and then the camera will power off completely.

**Note:** Your digital camera also has an Auto Power Off feature that will automatically turn off your camera after a specific period of time that your camera is left idle. The Auto Power Off settings can be set from the Auto Power Off settings menu.

## Changing Camera Mode

Your camera has three main modes:

- 1) **Photo Capture Mode** - Use this mode to capture photos with your camera.
- 1) **Video Capture Mode** - Use this mode to capture videos with your camera.
- 2) **Playback Mode (for photos and videos)** - Use this mode to view the photos and videos you have already taken with your camera.

When the camera is first powered ON, the Video Capture Mode will be active. The icons that appear on the LCD screen are the best default settings so that you can begin to capture and enjoy clear quality videos and photos.

To change the active camera mode, make sure the camera is powered ON and press the **MODE** button.



When in Photo Capture Mode, this icon will display on the top-left corner of the LCD display



When in Video Capture Mode, this icon will display on the top-left corner of the LCD display



When in Playback Mode, this icon will display on the top-left corner of the LCD display

## Navigating the Menu

Each camera mode has a set of menus specific to that mode.

- 1) Press the **OK** button to open the menus for the current mode.
- 2) Press the **LEFT/ViviLink Button** or **RIGHT/LED Button** direction control buttons to scroll between the various menus for the current mode.
- 3) Press the **UP/ T-Zoom In** or **DOWN/ W-Zoom Out** direction control buttons to highlight the desired menu selection.
- 4) Press the **OK** button to confirm and select the highlighted menu option.
- 5) If the selection can be remembered by the camera, a  selection icon will appear to the right of the selected menu option. Changes made to these options will remain as is until you decide to change them again at a later time.
- 6) Some menu options are single-use functions that are not remembered by the camera and do not display this icon when selected.
- 7) At any time you can press the **MODE** button to exit the menus and return to the previous screen.

## Photo Capture Mode

The Photo Capture mode allows you to capture pictures with your digital camera.

### Taking a Picture

1) While in Photo Capture mode, use the LCD display to direct the camera at the scene you would like to capture.

2)  Click the **T/Zoom In and W/Zoom Out** buttons to zoom in/out if desired.

**Note:** The actual shape of these buttons may vary per camera model.

3)  Click the **Shutter** button to take the picture.

4) The picture will automatically be saved to the memory or SD card.

### Photo Capture Mode Quick Function Buttons

Your digital camera has four Quick Function buttons:

Button	Action
Left/LED	Selects the LED Light On/Off
T/Up	Zooms In
Vivilink/Right	Opens the ViviLink for Photos Menu
W/Down	Zooms Out

### Hide/Show the LCD Icons

The display of the icons on the LCD screen can be hidden or visible as desired.

1) Hold the **MODE** button for 2 seconds to hide the display of the icons on the screen.

2) Press the **MODE** button again to redisplay the icons on the screen.

## Photo Capture Mode Menus

The following are the menus that appear in your camera's Photo Capture Mode:

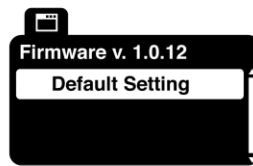
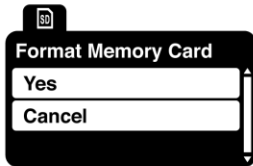
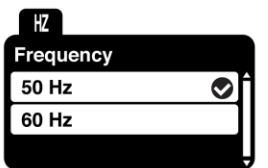
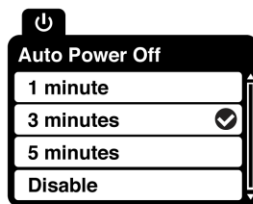
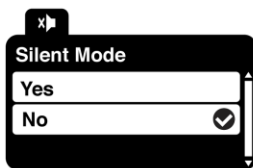
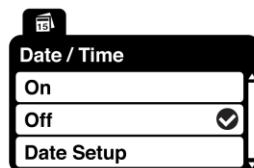
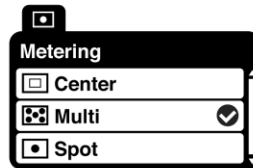
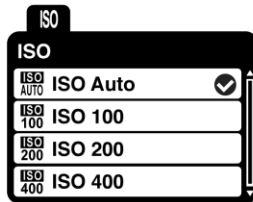
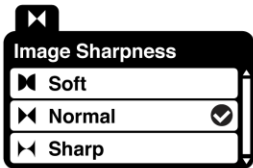
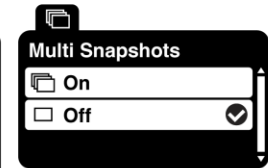
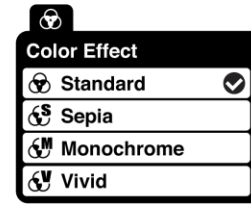
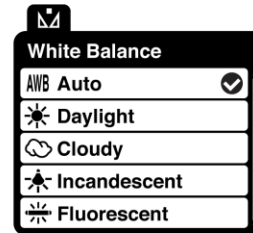
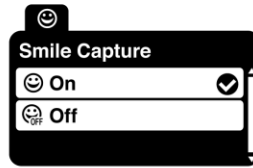
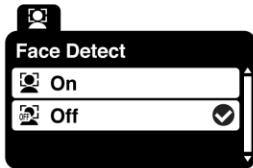
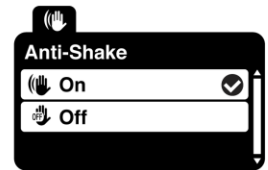
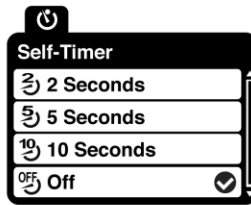
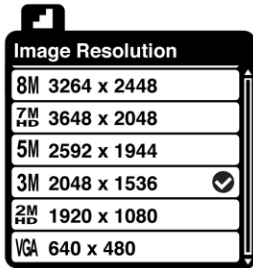

## Scene Menu

The Scene Menu allows you to choose scene settings that allow your camera to adapt properly to your current environment.

- 1) Press the **OK** button to open the menus for the current mode.
- 2) Press the **LEFT** or **RIGHT** direction control buttons to scroll and select the chosen menu.
- 3) Press the **UP** or **DOWN** direction control buttons to scroll through the menu options.
- 4) Press the **OK** button to select the desired option.
- 5) A  selected option icon will appear on the selected item.
- 6) Press the **LEFT** or **RIGHT** button to select the next menu item.
- 7) Press the **MODE** button to exit the menu and return to your previous mode.
- 8) An icon reflecting your selection will display on the LCD screen.
- 9) Remember that this setting will be saved by your camera until you manually change the setting or restore the camera's default factory settings.

## Image Resolution Menu

The Image Resolution menu allows you to choose the desired size of the images taken by your camera. Keep in mind that images with a higher resolution will also take up more of your camera's memory.

- 1) Press the **OK** button to open the menus for the current mode.
- 2) Press the **LEFT** or **RIGHT** direction control buttons to scroll and select the chosen menu.
- 3) Press the **UP** or **DOWN** direction control buttons to scroll through the menu options.
- 4) Press the **OK** button to select the desired option.
- 5) A  selected option icon will appear on the selected item.
- 6) Press the **LEFT** or **RIGHT** button to select the next menu item.
- 7) Press the **MODE** button to exit the menu and return to your previous mode.
- 8) An icon reflecting your selection will display on the LCD screen.
- 9) Remember that this setting will be saved by your camera until you manually change the setting or restore the camera's default factory settings.

## Image Quality Menu ★

The Image Quality menu allows you to select the desired quality level of the images taken by your camera. Keep in mind that images with a higher image quality level will also take up more memory on your camera.

- 1) Press the **OK** button to open the menus for the current mode.
- 2) Press the **LEFT** or **RIGHT** direction control buttons to scroll and select the chosen menu.
- 3) Press the **UP** or **DOWN** direction control buttons to scroll through the menu options.
- 4) Press the **OK** button to select the desired option.
- 5) A  selected option icon will appear on the selected item.
- 6) Press the **LEFT** or **RIGHT** button to select the next menu item.
- 7) Press the **MODE** button to exit the menu and return to your previous mode.
- 8) An icon reflecting your selection will display on the LCD screen.
- 9) Remember that this setting will be saved by your camera until you manually change the setting or restore the camera's default factory settings.

## Self-Timer Menu ⏰

The Self-Timer menu allows you to set a delay between the time that the camera's shutter button is pressed and the actual capture of the picture.

This is an optimal feature if you don't just want to take the picture but would also would like to be in the picture yourself. Just set the desired self-timer delay, press the shutter button on your camera and position yourself in front of the camera as desired.

- 1) Press the **OK** button to open the menus for the current mode.
- 2) Press the **LEFT** or **RIGHT** direction control buttons to scroll and select the chosen menu.
- 3) Press the **UP** or **DOWN** direction control buttons to scroll through the menu options.
- 4) Press the **OK** button to select the desired option.
- 5) A  selected option icon will appear on the selected item.
- 6) Press the **LEFT** or **RIGHT** button to select the next menu item.
- 7) Press the **MODE** button to exit the menu and return to your previous mode.



- 8) An icon reflecting your selection will display on the LCD screen.
- 9) Remember that this setting will be saved by your camera until you manually change the setting or restore the camera's default factory settings.

## Anti-Shake Menu

The Anti-Shake feature reduces image distortion that can be caused by movement of the camera while capturing the image.

- 1) Press the **OK** button to open the menus for the current mode.
- 2) Press the **LEFT** or **RIGHT** direction control buttons to scroll and select the chosen menu.
- 3) Press the **UP** or **DOWN** direction control buttons to scroll through the menu options.
- 4) Press the **OK** button to select the desired option.
- 5) A  selected option icon will appear on the selected item.
- 6) Press the **LEFT** or **RIGHT** button to select the next menu item.
- 7) Press the **MODE** button to exit the menu and return to your previous mode.
- 8) An icon reflecting your selection will display on the LCD screen.
- 9) Remember that this setting will be saved by your camera until you manually change the setting or restore the camera's default factory settings.

## Face Detect Menu

The Face Detect feature when set to 'On' allows the camera to use a subject's face as the basis for balancing the other colors and focus in the camera's display. This feature is meant to ensure that the color and focus of your pictures will be consistently sharp and high-quality.

**Note:** To properly use the Face Detect option please ensure the following:

- **Anti-Shake** - Ensure that the Anti-Shake option is set to 'On'. The Anti-Shake option is 'On' by default when you start using your camera and assists you in properly focussing the image.
- **Distance from the camera** – The subject's face must be no further than 8 to 9 feet (3.5 meters) from the camera and the face must cover at least 20% (1 / 5th) of the picture as 'seen' on the LCD screen.

- **Facing the camera** - The face of the subject(s) you are photographing must be facing the camera and must hold the pose for at least 4 to 5 seconds until the green square(s) appears around the subject`s face.

Face Detect will not work with a side shot of the subject`s head.

- 1) Press the **OK** button to open the menus for the current mode.
- 2) Press the **LEFT** or **RIGHT** direction control buttons to scroll and select the chosen menu.
- 3) Press the **UP** or **DOWN** direction control buttons to scroll through the menu options.
- 4) Press the **OK** button to select the desired option.
- 5) A  selected option icon will appear on the selected item.
- 6) Press the **LEFT** or **RIGHT** button to select the next menu item.
- 7) Press the **MODE** button to exit the menu and return to your previous mode.
- 8) An icon reflecting your selection will display on the LCD screen.
- 9) Remember that this setting will be saved by your camera until you manually change the setting or restore the camera`s default factory settings.

## Smile Capture Menu

The Smile Capture feature when set to 'On' allows the camera to automatically take a picture when it detects that a subject in the picture is smiling.

**Note:** To properly use the Smile Capture feature please ensure the following:

- **Anti-Shake** - Ensure that the Anti-Shake option is set to 'On'. The Anti-Shake option is 'On' by default when you start using your camera and assists you in properly focussing the image.
- **Distance from the camera** – The subject`s face must cover a majority of the picture as 'seen' on the LCD screen.
- **Facing the camera** - The face of the subject(s) you are photographing must be facing the camera and must hold the pose for at least 4 to 5 seconds until the green square(s) appears around the subject`s face.

Once a smile is detected the camera will automatically take the picture.

Smile Capture will not work with a side shot of the subject`s head.

- 1) Press the **OK** button to open the menus for the current mode.
- 2) Press the **LEFT** or **RIGHT** direction control buttons to scroll and select the chosen menu.
- 3) Press the **UP** or **DOWN** direction control buttons to scroll through the menu options.
- 4) Press the **OK** button to select the desired option.
- 5) A  selected option icon will appear on the selected item.
- 6) Press the **LEFT** or **RIGHT** button to select the next menu item.
- 7) Press the **MODE** button to exit the menu and return to your previous mode.
- 8) An icon reflecting your selection will display on the LCD screen.
- 9) Remember that this setting will be saved by your camera until you manually change the setting or restore the camera's default factory settings.

## White Balance Menu

The White Balance feature allows your camera to adjust the coloring of the captured images depending on the type of light source in the current environment.

Properly adjusting the White Balance setting to match your current environment will allow the camera to properly balance the colors in the images that are taken with your camera.

- 1) Press the **OK** button to open the menus for the current mode.
- 2) Press the **LEFT** or **RIGHT** direction control buttons to scroll and select the chosen menu.
- 3) Press the **UP** or **DOWN** direction control buttons to scroll through the menu options.
- 4) Press the **OK** button to select the desired option.
- 5) A  selected option icon will appear on the selected item.
- 6) Press the **LEFT** or **RIGHT** button to select the next menu item.
- 7) Press the **MODE** button to exit the menu and return to your previous mode.
- 8) An icon reflecting your selection will display on the LCD screen
- 9) Remember that this setting will be saved by your camera until you manually change the setting or restore the camera's default factory settings.

## Color Effect Menu

You can choose to add a color effect to the images taken with your camera.

- 1) Press the **OK** button to open the menus for the current mode.
- 2) Press the **LEFT** or **RIGHT** direction control buttons to scroll and select the chosen menu.
- 3) Press the **UP** or **DOWN** direction control buttons to scroll through the menu options.
- 4) Press the **OK** button to select the desired option.
- 5) A  selected option icon will appear on the selected item.
- 6) Press the **LEFT** or **RIGHT** button to select the next menu item.
- 7) Press the **MODE** button to exit the menu and return to your previous mode.
- 8) Remember that this setting will be saved by your camera until you manually change the setting or restore the camera's default factory settings.

## Multi SnapShots Menu

When enabled, the Multi SnapShots feature allows you to take five rapid snapshots in a row with a single click of the shutter button.

This feature can be effective when trying to capture a particular moment in a sporting event or other scenes with quick movements.

- 1) Press the **OK** button to open the menus for the current mode.
- 2) Press the **LEFT** or **RIGHT** direction control buttons to scroll and select the chosen menu.
- 3) Press the **UP** or **DOWN** direction control buttons to scroll through the menu options.
- 4) Press the **OK** button to select the desired option.
- 5) A  selected option icon will appear on the selected item.
- 6) Press the **LEFT** or **RIGHT** button to select the next menu item.
- 7) Press the **MODE** button to exit the menu and return to your previous mode.
- 8) An icon reflecting your selection will display on the LCD screen
- 9) Remember that this setting will be saved by your camera until you manually change the setting or restore the camera's default factory settings.

## Image Sharpness Menu

You can set the level of sharpness in the images taken with your camera. The sharpness level dictates if the edges of objects in the image are more or less distinct.

- 1) Press the **OK** button to open the menus for the current mode.
- 2) Press the **LEFT** or **RIGHT** direction control buttons to scroll and select the chosen menu.
- 3) Press the **UP** or **DOWN** direction control buttons to scroll through the menu options.
- 4) Press the **OK** button to select the desired option.
- 5) A  selected option icon will appear on the selected item.
- 6) Press the **LEFT** or **RIGHT** button to select the next menu item.
- 7) Press the **MODE** button to exit the menu and return to your previous mode.
- 8) An icon reflecting your selection will display on the LCD screen
- 9) Remember that this setting will be saved by your camera until you manually change the setting or restore the camera's default factory settings.

## Light Exposure Menu

The Light Exposure setting helps you control the amount of light that enters your camera's lens. This setting should be adjusted when the environment is lighter or darker than normal.

When the environment has more light than is needed, reduce the exposure setting (by using the negative - count) to reduce the amount of light allowed into the lens by your camera.

If the environment has less light (darker) than is needed, increase the exposure setting (by using the positive + count) to increase the amount of light allowed into the lens by your camera.

- 1) Press the **OK** button to open the menus for the current mode.
- 2) Press the **LEFT** or **RIGHT** direction control buttons to scroll and select the chosen menu.
- 3) Press the **UP** or **DOWN** direction control buttons to scroll through the menu options.
- 4) Press the **OK** button to select the desired option.
- 5) A  selected option icon will appear on the selected item.
- 6) Press the **LEFT** or **RIGHT** button to select the next menu item.
- 7) Press the **MODE** button to exit the menu and return to your previous mode.

- 8) An icon reflecting your selection will display on the LCD screen
- 9) Remember that this setting will be saved by your camera until you manually change the setting or restore the camera's default factory settings.

## ISO Menu <sup>ISO</sup>

The ISO menu allows you to set the level of sensitivity that your camera has to light in the surrounding environment. When the ISO level is increased, the image sensor in your camera will be more sensitive to light and allow you to capture images in lower-light situations. The higher sensitivity to light however, may reduce the quality of the images that are taken.

When the ISO is reduced, the image sensor in your camera will be less sensitive to light and will optimize the image quality in environments with bright lighting.

- 1) Press the **OK** button to open the menus for the current mode.
- 2) Press the **LEFT** or **RIGHT** direction control buttons to scroll and select the chosen menu.
- 3) Press the **UP** or **DOWN** direction control buttons to scroll through the menu options.
- 4) Press the **OK** button to select the desired option.
- 5) A  selected option icon will appear on the selected item.
- 6) Press the **LEFT** or **RIGHT** button to select the next menu item.
- 7) Press the **MODE** button to exit the menu and return to your previous mode.
- 8) An icon reflecting your selection will display on the LCD screen
- 9) Remember that this setting will be saved by your camera until you manually change the setting or restore the camera's default factory settings.

## Metering Menu

The Metering setting will affect how your camera focuses when capturing an image. Depending on your selection, the camera will be more sensitive to focusing on particular areas in the display and adjust the image color and lighting accordingly.

**Center** – Averages the light metered from the entire frame, but giving greater weight to the subject in the center

**Multi** – Used in standard conditions the camera divides and adjusts the settings of the image into several zones for light metering such as complex light conditions, position of subject, brightness, background, direct light and scenes

**Spot** – Meters the area within the spot point frame at the center of the LCD to set the exposure on the subject in the center of the monitor.

- 1) Press the **OK** button to open the menus for the current mode.
- 2) Press the **LEFT** or **RIGHT** direction control buttons to scroll and select the chosen menu.
- 3) Press the **UP** or **DOWN** direction control buttons to scroll through the menu options.
- 4) Press the **OK** button to select the desired option.
- 5) A  selected option icon will appear on the selected item.
- 6) Press the **LEFT** or **RIGHT** button to select the next menu item.
- 7) Press the **MODE** button to exit the menu and return to your previous mode.
- 8) An icon reflecting your selection will display on the LCD screen
- 9) Remember that this setting will be saved by your camera until you manually change the setting or restore the camera's default factory settings.

## Language Menu

You can select your camera's language setting by selecting the desired language from the Language menu.

- 1) Press the **OK** button to open the menus for the current mode.
- 2) Press the **LEFT** or **RIGHT** direction control buttons to scroll and select the chosen menu.
- 3) Press the **UP** or **DOWN** direction control buttons to scroll through the menu options.
- 4) Press the **OK** button to select the desired option.
- 5) A  selected option icon will appear on the selected item.
- 6) Press the **LEFT** or **RIGHT** button to select the next menu item.
- 7) Press the **MODE** button to exit the menu and return to your previous mode.
- 8) Remember that this setting will be saved by your camera until you manually change the setting or restore the camera's default factory settings.

## Date/Time Menu

When you capture an image with your camera, the image will include a time stamp with the date and time that the image was taken.

The Date/Time menu allows you to set your camera's date and time as desired. You can also disable the timestamp for future images that will be taken with your camera.

**On** – The timestamp will appear on photos taken

**Off** – The date stamp will not appear on photos taken

### To Enable/Disable the Timestamp:

- 1) Press the **OK** button to open the menus for the current mode.
- 2) Press the **LEFT** or **RIGHT** direction control buttons to scroll and select the chosen menu.
- 3) Press the **UP** or **DOWN** direction control buttons to scroll through the menu options.
- 4) Press the **OK** button to select the desired option.
- 5) A  selected option icon now appears to the right of the option name.
- 6) Press the **LEFT** or **RIGHT** button to select the next menu item.
- 7) Press the **MODE** button to exit the menu and return to your previous mode.
- 8) Remember that this setting will be saved by your camera until you manually change the setting or restore the camera's default factory settings.

### To Set the Date and Time:

- 1) Press the **OK** button to open the menus for the current mode.
- 2) Press the **LEFT** or **RIGHT** direction control buttons to scroll and select the chosen menu.
- 3) Press the **UP** or **DOWN** direction control buttons to scroll through the menu options.
- 4) Highlight the "Date Setup" menu option.
- 5) Press the **OK** button to select the desired option.
- 6) The Date Setup submenu will open.
- 7) Scroll through the window with the **RIGHT** and **LEFT** navigation buttons. For each field in the menu, use the **UP** and **DOWN** navigation buttons to set the time and date.
- 8) Press the **MODE** button to exit the menu and return to your previous screen.



## Silent Mode Menu

You have the option of activating the camera's silent mode to disable all of the sound effects that the camera emits when performing camera functions.

- 1) Press the **OK** button to open the menus for the current mode.
- 2) Press the **LEFT** or **RIGHT** direction control buttons to scroll and select the chosen menu.
- 3) Press the **UP** or **DOWN** direction control buttons to scroll through the menu options.
- 4) Press the **OK** button to select the desired option.
- 5) A  selected option icon will appear on the selected item.
- 6) Press the **LEFT** or **RIGHT** button to select the next menu item.
- 7) Press the **MODE** button to exit the menu and return to your previous mode.
- 8) Remember that this setting will be saved by your camera until you manually change the setting or restore the camera's default factory settings.

## Auto Power Off Menu

You can use the Auto Power Off feature in order to conserve you camera's battery life. The designated time represents when your camera will automatically power off.

When the camera sits idle for the designated period of time, the camera will shut off completely and will need to be powered on again with the power button before the next use.

- 1) Press the **OK** button to open the menus for the current mode.
- 2) Press the **LEFT** or **RIGHT** direction control buttons to scroll and select the chosen menu.
- 3) Press the **UP** or **DOWN** direction control buttons to scroll through the menu options.
- 4) Press the **OK** button to select the desired option.
- 5) A  selected option icon will appear on the selected item.
- 6) Press the **LEFT** or **RIGHT** button to select the next menu item.
- 7) Press the **MODE** button to exit the menu and return to your previous mode.
- 8) Remember that this setting will be saved by your camera until you manually change the setting or restore the camera's default factory settings.

## Frequency Menu <sup>Hz</sup>

The options in the Frequency menu represent the frequency of the electrical current in fluorescent lighting sources in your locale. If your camera is set to a frequency that does not match your country's electric current, you may see waves on the images taken by your camera.

- 1) Press the **OK** button to open the menus for the current mode.
- 2) Press the **LEFT** or **RIGHT** direction control buttons to scroll and select the chosen menu.
- 3) Press the **UP** or **DOWN** direction control buttons to scroll through the menu options.
- 4) Press the **OK** button to select the desired option.
- 5) A  selected option icon will appear on the selected item
- 6) Press the **LEFT** or **RIGHT** button to select the next menu item.
- 7) Press the **MODE** button to exit the menu and return to your previous mode.
- 8) Remember that this setting will be saved by your camera until you manually change the setting or restore the camera's default factory settings.

## Format Memory Card Menu

You can use the Format Memory Card menu to delete all of the content that is currently on your camera's memory card.

**Keep in mind that formatting the memory card will permanently delete all of the content on your camera's memory card.**

This option will delete all of the content at one time. If you would like to delete individual images, use the delete menu in the camera's Playback mode.

- 1) Press the **OK** button to open the menus for the current mode.
- 2) Press the **LEFT** or **RIGHT** direction control buttons to scroll and select the chosen menu.
- 3) Press the **UP** or **DOWN** direction control buttons to highlight the menu options. While scrolling down the selected option will be highlighted.
- 4) If you would like to proceed with the format, select "Yes" and press the **OK** button.

- 5) You will be asked to confirm your wish to format your memory card.
- 6) Select “No” to exit without formatting.
- 7) Select “Yes” and press the **OK** button to begin the format.
- 8) The memory card will be completely formatted.
- 9) A message will appear confirming that your memory card has been formatted clean.

## Firmware Menu

Use this menu to view the Firmware version on your camera or to reset your camera settings to the factory default settings.

- 1) Press the **OK** button to open the menus for the current mode.
- 2) Press the **LEFT** or **RIGHT** direction control buttons to scroll and select the chosen menu.
- 3) The “Default Setting” is selected.
- 4) Press the **OK** button to reset the camera to the factory default settings.
- 5) You will be asked to confirm your wish to restore all of the factory settings.
- 6) Press the **UP** or **DOWN** buttons to select “Yes” and press the **OK** button to begin the format.
- 7) The camera will be reset.
- 8) A message will appear indicating that the settings have been reset successfully.

## Photo Playback Mode

When you first turn on the camera, the camera will be in Video Capture mode by default. Press the **MODE** button twice to open the Playback Mode. The Playback mode will allow you to review and edit photos and videos that you’ve already taken with you camera.

## Viewing Photos on Your Camera

Once in the Playback mode, press the **LEFT** or **RIGHT** direction buttons to scroll through the images on your camera’s memory card. Photos appear with a  icon on the top left of the LCD screen .

## Zooming In/Out on a Photo

Press the **T / Zoom In** button to zoom in on a photo on your camera. Use the **LEFT** and **RIGHT** buttons to navigate around the photo.

Press the **W/Zoom Out** button to zoom out on a photo on your camera.

## Thumbnail View

Easily navigate and select the image you wish to view by using the Thumbnail View.

The images on your camera will be displayed in a 3 X 3 matrix where you can use the direction buttons to scroll and select images normally from the thumbnails.

- 1) Press the **W/Zoom Out** button
- 2) All the images on your camera will appear in the **Thumbnail View**.
- 3) Use the direction buttons to scroll and select the image you wish to view.
- 4) Press the **OK** button to enlarge the selected image to full size.

## Photo Playback Mode Quick Function Buttons

Your digital camera has a four-directional pad that functions as Quick Function buttons.

Button	Action
<b>Left/LED</b>	Displays the PREVIOUS image
<b>T/Up</b>	Zooms In
<b>Right/ViviLink</b>	Displays the NEXT image
<b>W/Down</b>	Displays the Thumbnail view/ Zoom Out on zoomed photos

## Photo Playback Mode Menus

The following are the menus that appear in your camera's Photo Playback Mode:

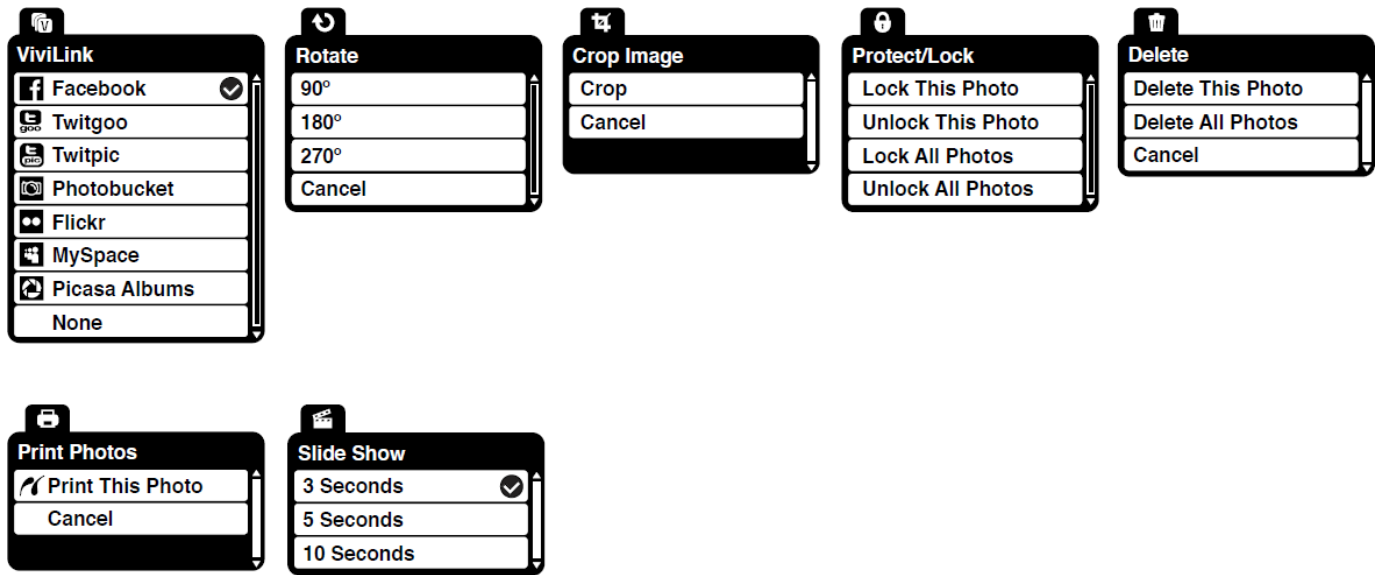

### ViviLink Menu

The ViviLink technology allows you to quickly and easily upload your camera's photos and videos to the social networks of your choice with the accompanying Vivitar Experience Image Manager application.

- 1) Press the **OK** button to open the menus for the current mode.
- 2) Press the **LEFT** or **RIGHT** direction control buttons to scroll and select the chosen menu.
- 3) Press the **UP** or **DOWN** direction control buttons to scroll through the menu options.
- 4) Press the **OK** button to select the desired option.
- 5) A  selected option icon will appear on the selected item.
- 6) An icon will appear on the image with the selected ViviLink destination site when you return to the Playback display.
- 7) Remember that the ViviLink feature is deactivated by default. A ViviLink destination will only be assigned to a photo or video if you manually set it from this menu or from the ViviLink menu in Capture mode (accessible with the Vivilink Quick-Function button in Capture mode).

- 8) Changing the Vivilink destination site will also make the selected site the new default Vivilink option. A new default can be selected at any time through this menu.
- 9) Press the **LEFT** or **RIGHT** button to select the next menu item.
- 10) Press the **MODE** button to exit the menu and return to your previous mode.

## Rotate Menu ↺

Use this menu to rotate the pictures that you've taken with your camera.

- 1) Press the **OK** button to open the menus for the current mode.
- 2) Press the **LEFT** or **RIGHT** direction control buttons to scroll and select the chosen menu.
- 3) Press the **UP** or **DOWN** direction control buttons to scroll through the menu options.
- 4) Press the **OK** button to select the desired option.
- 5) The selected picture will now appear rotated in the Playback mode.
- 6) Press the **LEFT** or **RIGHT** button to select the next menu item.
- 7) Press the **MODE** button to exit the menu and return to your previous mode.

## Crop Image Menu ✂

You can crop any picture on your camera with the Crop feature.

- 1) Press the **OK** button to open the menus for the current mode.
- 2) Press the **LEFT** or **RIGHT** direction control buttons to scroll and select the chosen menu.
- 3) Press the **UP** or **DOWN** to highlight the Crop option.
- 4) Press the **OK** button to open the crop option.
- 5) The crop window will open on the selected picture.
- 6) Use the directional buttons to move the crop box to define the desired crop area.
- 7) Use the **W/T Zoom** buttons on the camera to enlarge or shrink the crop box.
- 8) When you are ready to crop, press the Shutter button.
- 9) When you see the cropped picture appear, press the Shutter button again to save or press the **OK** button to cancel and return to the previous menu.

- 10) If you selected to save, the cropped picture will now be saved as a new picture to your memory card.

## Protect/Lock Menu

Pictures and Videos taken with your camera can be protected or “locked” to prevent any deletion or alteration being made to the files.

- 1) Press the **OK** button to open the menus for the current mode.
- 2) Press the **LEFT** or **RIGHT** direction control buttons to scroll and select the chosen menu.
- 3) Press the **UP** or **DOWN** direction control buttons to scroll through the menu options.
- 4) Press the **OK** button to select the desired option.
- 5) Press the **LEFT** or **RIGHT** button to select the next menu item.
- 6) Press the **MODE** button to exit the menu and return to your previous mode.
- 7) Any image that is locked will display a lock symbol on the LCD screen when viewing that image in the playback mode. Photos that are not locked will not display the lock symbol.
- 8) Remember that you cannot delete or edit photos while they are locked.

## Delete Menu

While in the Playback Mode, you can delete pictures from your camera through the delete menu.

- 1) Use the **LEFT** or **RIGHT** buttons to select the image you would like to delete.
- 2) Press the **OK** button to open the menus.
- 3) Scroll to the Delete Menu.
- 4) Press the **UP** or **DOWN** direction control buttons to scroll through the menu options.
- 5) To delete this one photo, select “Delete This Photo”
- 6) To delete all the images (including all unlocked photos and videos) on your camera’s memory card, select “Delete All Images”.
- 7) Press the **OK** button to select the desired option.
- 8) You will be asked to confirm your selection.
- 9) The photos will be deleted as desired.

## Print Photos Menu

You can use the Print Photos menu to print the photos that are on your camera directly to a Pictbridge compatible printer.

- 1) Scroll through your pictures and find the one you would like to print.
- 2) Press the **OK** button to open the menus for the current mode.
- 3) Press the **LEFT** or **RIGHT** direction control buttons to scroll and select the chosen menu.
- 4) Press the **UP** or **DOWN** direction control buttons to scroll through the menu options.
- 5) Press the **OK** button when highlighting the “Print This Photo” option to print the selected photo.
- 6) You will be asked to connect the camera to the Pictbridge printer.
- 7) Connect the USB cable provided in the package form the camera to the Pictbridge port of the printer.
- 8) Once connected, follow the instructions on the printer to proceed with the printing process.
- 9) Select the “Cancel” option to exit the menu and return to the previous mode.

## Slide Show Menu

You can view a slideshow of all the pictures taken with your camera by pressing the “Up” Quick Function button while in Playback mode.

The Slideshow menu allows you to set the interval length of time that each picture will display during the slideshow.

- 1) Press the **OK** button to open the menus for the current mode.
- 2) Press the **LEFT** or **RIGHT** direction control buttons to scroll and select the chosen menu.
- 3) Press the **UP** or **DOWN** direction control buttons to scroll through the menu options.
- 4) Press the **OK** button to select the desired option.
- 5) A  selected option icon will appear on the selected item.
- 6) Press the **LEFT** or **RIGHT** button to select the next menu item.
- 7) Press the **MODE** button to exit the menu and return to your previous mode.
- 8) While in Playback mode, press the **Photo Shutter** button to initiate the slideshow.
- 9) Press the **MODE** button to exit the slideshow.



## Video Capture Mode

The Video Capture Mode allows you to capture videos with your digital camera. When the camera is first powered ON, the camera will be in Video Capture Mode.

### Taking a Video

- 1) While in Video Capture Mode, use the LCD display to direct the camera at the scene you would like to capture.
- 2)  Click the **T/Zoom In** and **W/Zoom Out** buttons to better set the camera display if desired.

**Note:** The actual shape of these buttons may vary per camera model.

- 3)  Press the **Video Shutter** button to start the video capture.
- 4) You will see a red icon at the top of the LCD indicating that the record is in progress.
- 5) To stop the video record, press the **Video Shutter** button again.
- 6) The video will automatically be saved to the camera's memory or SD card.

### Video Capture Mode Quick Function Buttons

Your digital camera has Quick Function buttons.

Button	Action
Left/LED	Selects the LED Light On/Off
Up/T	Zooms In
Right/ViviLink	Opens the ViviLink for Video Menu
W/Down	Zooms Out

## Video Capture Mode Menus

The following are the menus that appear in your camera's Video Capture Mode:

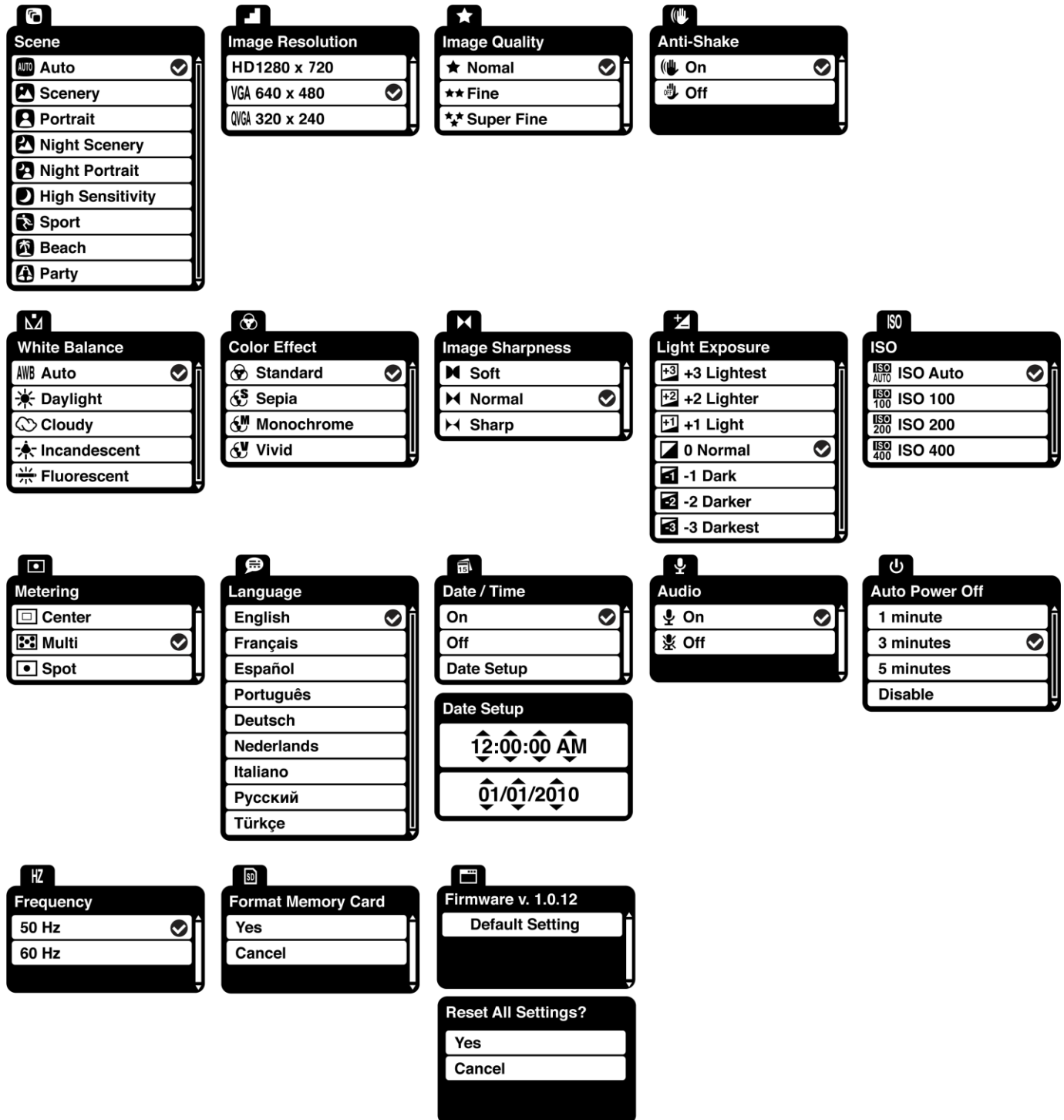

## Scene Menu

The Scene Menu allows you to choose scene settings that allow your camera to adapt properly to your current environment.

- 1) Press the **OK** button to open the menus for the current mode.
- 2) Press the **LEFT** or **RIGHT** direction control buttons to scroll and select the chosen menu.
- 3) Press the **UP** or **DOWN** direction control buttons to scroll through the menu options.
- 4) Press the **OK** button to select the desired option.
- 5) A  selected option icon will appear on the selected item.
- 6) Press the **LEFT** or **RIGHT** button to select the next menu item.
- 7) Press the **MODE** button to exit the menu and return to your previous mode.
- 8) An icon reflecting your selection will display on the LCD screen.
- 9) Remember that this setting will be saved by your camera until you manually change the setting or restore the camera's default factory settings.

## Image Resolution Menu

The Image Resolution menu allows you to choose the desired size of the images taken by your camera. Keep in mind that images with a higher resolution will also take up more of your camera's memory.

- 1) Press the **OK** button to open the menus for the current mode.
- 2) Press the **LEFT** or **RIGHT** direction control buttons to scroll and select the chosen menu.
- 3) Press the **UP** or **DOWN** direction control buttons to scroll through the menu options.
- 4) Press the **OK** button to select the desired option.
- 5) A  selected option icon will appear on the selected item.
- 6) Press the **LEFT** or **RIGHT** button to select the next menu item.
- 7) Press the **MODE** button to exit the menu and return to your previous mode.
- 8) An icon reflecting your selection will display on the LCD screen.
- 9) Remember that this setting will be saved by your camera until you manually change the setting or restore the camera's default factory settings.

## Image Quality Menu ★

The Image Quality menu allows you to select the desired quality level of the images taken by your camera. Keep in mind that images with a higher image quality level will also take up more memory on your camera.

- 1) Press the **OK** button to open the menus for the current mode.
- 2) Press the **LEFT** or **RIGHT** direction control buttons to scroll and select the chosen menu.
- 3) Press the **UP** or **DOWN** direction control buttons to scroll through the menu options.
- 4) Press the **OK** button to select the desired option.
- 5) A  selected option icon will appear on the selected item.
- 6) Press the **LEFT** or **RIGHT** button to select the next menu item.
- 7) Press the **MODE** button to exit the menu and return to your previous mode.
- 8) An icon reflecting your selection will display on the LCD screen.
- 9) Remember that this setting will be saved by your camera until you manually change the setting or restore the camera's default factory settings.

## Anti-Shake Menu

The Anti-Shake feature reduces image corruption that can be caused by movement of the camera while capturing the image.

- 1) Press the **OK** button to open the menus for the current mode.
- 2) Press the **LEFT** or **RIGHT** direction control buttons to scroll and select the chosen menu.
- 3) Press the **UP** or **DOWN** direction control buttons to scroll through the menu options.
- 4) Press the **OK** button to select the desired option.
- 5) A  selected option icon will appear on the selected item.
- 6) Press the **LEFT** or **RIGHT** button to select the next menu item.
- 7) Press the **MODE** button to exit the menu and return to your previous mode.
- 8) An icon reflecting your selection will display on the LCD screen.
- 9) Remember that this setting will be saved by your camera until you manually change the setting or restore the camera's default factory settings.

## White Balance Menu

The White Balance feature allows your camera to adjust the coloring of the captured images depending on the type of light source in the current environment.

Properly adjusting the White Balance setting to match your current environment will allow the camera to properly balance the colors in the images that are taken with your camera.

- 1) Press the **OK** button to open the menus for the current mode.
- 2) Press the **LEFT** or **RIGHT** direction control buttons to scroll and select the chosen menu.
- 3) Press the **UP** or **DOWN** direction control buttons to scroll through the menu options.
- 4) Press the **OK** button to select the desired option.
- 5) A  selected option icon will appear on the selected item.
- 6) Press the **LEFT** or **RIGHT** button to select the next menu item.
- 7) Press the **MODE** button to exit the menu and return to your previous mode.
- 8) An icon reflecting your selection will display on the LCD screen.
- 9) Remember that this setting will be saved by your camera until you manually change the setting or restore the camera's default factory settings.

## Color Effect Menu

You can choose to add a color effect to the images taken with your camera.

- 1) Press the **OK** button to open the menus for the current mode.
- 2) Press the **LEFT** or **RIGHT** direction control buttons to scroll and select the chosen menu.
- 3) Press the **UP** or **DOWN** direction control buttons to scroll through the menu options.
- 4) Press the **OK** button to select the desired option.
- 5) A  selected option icon will appear on the selected item.
- 6) Press the **LEFT** or **RIGHT** button to select the next menu item.
- 7) Press the **MODE** button to exit the menu and return to your previous mode.
- 8) An icon reflecting your selection will display on the LCD screen.
- 9) Remember that this setting will be saved by your camera until you manually change the setting or restore the camera's default factory settings.

## Image Sharpness Menu ◀◀

You can set the level of sharpness in the images taken with your camera. The sharpness level dictates if the edges of objects in the image are more or less distinct.

- 1) Press the **OK** button to open the menus for the current mode.
- 2) Press the **LEFT** or **RIGHT** direction control buttons to scroll and select the chosen menu.
- 3) Press the **UP** or **DOWN** direction control buttons to scroll through the menu options.
- 4) Press the **OK** button to select the desired option.
- 5) A  selected option icon will appear on the selected item.
- 6) Press the **LEFT** or **RIGHT** button to select the next menu item.
- 7) Press the **MODE** button to exit the menu and return to your previous mode.
- 8) An icon reflecting your selection will display on the LCD screen
- 9) Remember that this setting will be saved by your camera until you manually change the setting or restore the camera's default factory settings.

## Light Exposure Menu ⚡

The Light Exposure setting helps you control the amount of light that enters your camera's lens. This setting should be adjusted when the environment is lighter or darker than normal.

When the environment has more light than is needed, reduce the exposure setting (by using the negative - count) to reduce the amount of light allowed into the lens by your camera.

If the environment has less light (darker) than is needed, increase the exposure setting (by using the positive + count) to increase the amount of light allowed into the lens by your camera.

- 1) Press the **OK** button to open the menus for the current mode.
- 2) Press the **LEFT** or **RIGHT** direction control buttons to scroll and select the chosen menu.
- 3) Press the **UP** or **DOWN** direction control buttons to scroll through the menu options.
- 4) Press the **OK** button to select the desired option.

- 5) A  selected option icon will appear on the selected item.
- 6) Press the **LEFT** or **RIGHT** button to select the next menu item.
- 7) Press the **MODE** button to exit the menu and return to your previous mode.
- 8) An icon reflecting your selection will display on the LCD screen.
- 9) Remember that this setting will be saved by your camera until you manually change the setting or restore the camera's default factory settings.

## ISO Menu <sup>ISO</sup>

The ISO menu allows you to set the level of sensitivity that your camera has to light in the surrounding environment. When the ISO level is increased, the image sensor in your camera will be more sensitive to light and allow you to capture images in lower-light situations. The higher sensitivity to light however, may reduce the quality of the images that are taken.

When the ISO is reduced, the image sensor in your camera will be less sensitive to light and will optimize the image quality in environments with bright lighting.

- 1) Press the **OK** button to open the menus for the current mode.
- 2) Press the **LEFT** or **RIGHT** direction control buttons to scroll and select the chosen menu.
- 3) Press the **UP** or **DOWN** direction control buttons to scroll through the menu options.
- 4) Press the **OK** button to select the desired option.
- 5) A  selected option icon will appear on the selected item.
- 6) Press the **LEFT** or **RIGHT** button to select the next menu item.
- 7) Press the **MODE** button to exit the menu and return to your previous mode.
- 8) An icon reflecting your selection will display on the LCD screen.
- 9) Remember that this setting will be saved by your camera until you manually change the setting or restore the camera's default factory settings.

## Metering Menu

The Metering setting will affect how your camera focuses when capturing an image. Depending on your selection, the camera will be more sensitive to focusing on particular areas in the display and adjust the image color and lighting accordingly.

**Center** – Averages the light metered from the entire frame, but giving greater weight to the subject in the center

**Multi** – Used in standard conditions the camera divides and adjusts the settings of the image into several zones for light metering such as complex light conditions, position of subject, brightness, background, direct light and scenes

**Spot** – Meters the area within the spot point frame at the center of the LCD to set the exposure on the subject in the center of the monitor.

- 1) Press the **OK** button to open the menus for the current mode.
- 2) Press the **LEFT** or **RIGHT** direction control buttons to scroll and select the chosen menu.
- 3) Press the **UP** or **DOWN** direction control buttons to scroll through the menu options.
- 4) Press the **OK** button to select the desired option.
- 5) A  selected option icon will appear on the selected item.
- 6) Press the **LEFT** or **RIGHT** button to select the next menu item.
- 7) Press the **MODE** button to exit the menu and return to your previous mode.
- 8) An icon reflecting your selection will display on the LCD screen.
- 9) Remember that this setting will be saved by your camera until you manually change the setting or restore the camera's default factory settings.

## Language Menu

You can select your camera's language setting by selecting the desired language from the Language menu.

- 1) Press the **OK** button to open the menus for the current mode.
- 2) Press the **LEFT** or **RIGHT** direction control buttons to scroll and select the chosen menu.
- 3) Press the **UP** or **DOWN** direction control buttons to scroll through the menu options.



- 4) Press the **OK** button to select the desired option.
- 5) A  selected option icon will appear on the selected item.
- 6) Press the **LEFT** or **RIGHT** button to select the next menu item.
- 7) Press the **MODE** button to exit the menu and return to your previous mode.
- 8) Remember that this setting will be saved by your camera until you manually change the setting or restore the camera's default factory settings.

## Date/Time Menu

When you capture an image with your camera, the image will include a time stamp with the date and time that the image was taken.

The Date/Time menu allows you to set your camera's date and time as desired. You can also disable the timestamp for future images that will be taken with your camera.

**On** – The timestamp will appear on photos taken.

**Off** – The date stamp will not appear on photos taken.

### To Enable/Disable the Timestamp:

- 1) Press the **OK** button to open the menus for the current mode.
- 2) Press the **LEFT** or **RIGHT** direction control buttons to scroll and select the chosen menu.
- 3) Press the **UP** or **DOWN** direction control buttons to scroll through the menu options.
- 4) Press the **OK** button to select the desired option.
- 5) A  selected option icon will appear on the selected item.
- 6) Press the **LEFT** or **RIGHT** button to select the next menu item.
- 7) Press the **MODE** button to exit the menu and return to your previous mode.
- 8) Remember that this setting will be saved by your camera until you manually change the setting or restore the camera's default factory settings.

### To Set the Date and Time:

- 1) Highlight the "Date Setup" menu option.
- 2) Press the **OK** button to select the desired option.

- 3) The “Date Setup” submenu will open.
- 4) Scroll through the window with the right and left navigation buttons. For each field in the menu, use the UP and DOWN navigation buttons to set the time and date.
- 5) Press the **MODE** button to exit the menu and return to your previous screen.

### Audio Menu

The Audio menu allows you to control the camera’s ability to record audio in the video clips recorded with your camera in addition to the video record.

- 1) Press the **OK** button to open the menus for the current mode.
- 2) Press the **LEFT** or **RIGHT** direction control buttons to scroll and select the chosen menu.
- 3) Press the **UP** or **DOWN** direction control buttons to scroll through the menu options.
- 4) Press the **OK** button to select the desired option.
- 5) A  selected option icon will appear on the selected item.
- 6) Press the **LEFT** or **RIGHT** button to select the next menu item.
- 7) Press the **MODE** button to exit the menu and return to your previous mode.
- 8) An icon reflecting your selection will display on the LCD screen.
- 9) Remember that this setting will be saved by your camera until you manually change the setting or restore the camera’s default factory settings.

### Auto Power Off Menu

You can use the Auto Power Off feature in order to conserve you camera’s battery life. The designated time represents when your camera will automatically power off.

When the camera sits idle for the designated period of time, the camera will shut off completely and will need to be turned on again with the power button before the next use.

- 1) Press the **OK** button to open the menus for the current mode.
- 2) Press the **LEFT** or **RIGHT** direction control buttons to scroll and select the chosen menu.
- 3) Press the **UP** or **DOWN** direction control buttons to scroll through the menu options.
- 4) Press the **OK** button to select the desired option.

- 5) A  selected option icon will appear on the selected item.
- 6) Press the **LEFT** or **RIGHT** button to select the next menu item.
- 7) Press the **MODE** button to exit the menu and return to your previous mode.
- 8) Remember that this setting will be saved by your camera until you manually change the setting or restore the camera's default factory settings.

## Frequency Menu

The options in the Frequency menu represent the frequency of the electrical current in fluorescent lighting sources in your locale. If your camera is set to a frequency that does not match your country's electric current, you may see flickering or waves on the images taken by your camera.

**50Hz** – UK, Europe and Australia

**60Hz** – US, Canada and South America

- 1) Press the **OK** button to open the menus for the current mode.
- 2) Press the **LEFT** or **RIGHT** direction control buttons to scroll and select the chosen menu.
- 3) Press the **UP** or **DOWN** direction control buttons to scroll through the menu options.
- 4) Press the **OK** button to select the desired option.
- 5) A  selected option icon will appear on the selected item.
- 6) Press the **LEFT** or **RIGHT** button to select the next menu item.
- 7) Press the **MODE** button to exit the menu and return to your previous mode.
- 8) Remember that this setting will be saved by your camera until you manually change the setting or restore the camera's default factory settings.

## Format Memory Card Menu

You can use the Format Memory Card menu to delete all of the content that is currently on your camera's memory card.

**Keep in mind that formatting the memory card will permanently delete all of the content on your camera's memory card.**

This option can only delete all of the content at one time. If you would like to delete individual images, use the delete menu in the camera's Playback mode.

- 1) Press the **OK** button to open the menus for the current mode.
- 2) Press the **LEFT** or **RIGHT** direction control buttons to scroll and select the chosen menu.
- 3) Press the **UP** or **DOWN** direction control buttons to highlight the menu options. While scrolling down the selected option will be highlighted.
- 4) If you would like to proceed with the format, select "Yes" and press the **OK** button.
- 5) You will be asked to confirm your wish to format your memory card.
- 6) Select "No" to exit without formatting.
- 7) Select "Yes" and press the **OK** button to begin the format.
- 8) The memory card will be completely formatted.
- 9) A message will appear confirming that your memory card has been formatted clean.

## Firmware Menu

Use this menu to view the Firmware version on your camera or to reset your camera settings to the factory default settings.

- 1) Press the **OK** button to open the menus for the current mode.
- 2) Press the **LEFT** or **RIGHT** direction control buttons to scroll and select the chosen menu.
- 3) Select the "Default Setting".
- 4) Press the **OK** button.
- 5) You will be asked to confirm your wish to restore all of the factory settings.
- 6) The settings will be reset.
- 7) A message will appear indicating that the settings have been reset successfully.

## Video Playback Mode

When you first turn on the camera, the camera will be in Video Capture mode by default. Press the **MODE** button twice to open the Playback Mode. The Playback Mode will allow you to review and edit photos and videos that you've already taken with you camera.

### Playing Videos on Your Camera

Once in Playback mode, press the **LEFT** or **RIGHT** direction buttons to scroll through the images on your camera's memory card. Each image will display on the LCD screen.

When you find a video that you would like to play, press the **Video Shutter** button to start playing the video.

Press the **Video Shutter** button again to pause the video and continue playing and pausing as needed.

While the Video is playing all the icons on the top section of the LCD disappear.

To fully stop the video and restore the icons to the LCD, press the **UP** button on the Direction Controls.

### Thumbnail View

Use the **W/Zoom Out** button to display the images on your camera in **Thumbnail View** – the images on your camera will be displayed in a 3 X 3 matrix where you can scroll and select images normally from the thumbnails.

### Video Playback Mode Quick Function Buttons

Your digital camera has a four-directional pad that functions as Quick Function buttons.

Button	Action
Left/LED	Displays the PREVIOUS image
T/Up	Zooms In
Right/ViviLink	Displays the NEXT image
W/Down	Displays the Thumbnail view/ Zoom Out on zoomed photos

## Video Playback Mode Menus

The following are the menus that appear in your camera's Video Playback Mode:

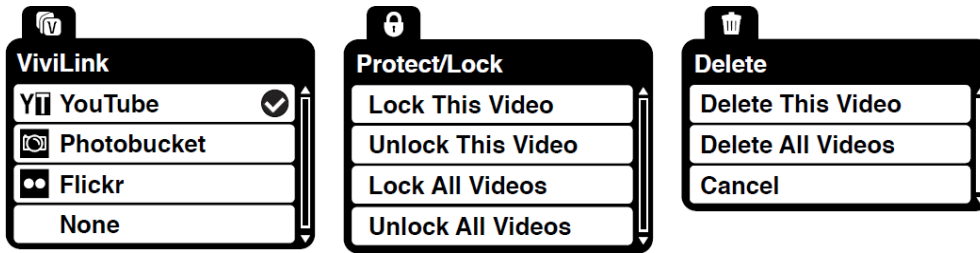

### ViviLink Menu

The ViviLink technology allows you to quickly and easily upload your camera's photos and videos to the social networks of your choice with the accompanying Vivitar Experience Image Manager application.

- 1) Press the **SET** button to open the menus for the current mode.
- 2) Press the **LEFT** or **RIGHT** direction control buttons to scroll and select the chosen menu.
- 3) Press the **UP** or **DOWN** direction control buttons to scroll through the menu options.
- 4) Press the **OK** button to select the desired option.
- 5) A  selected option icon will appear on the selected item
- 6) Press the **MODE** button to exit the menu and return to your previous mode.
- 7) An icon will appear on the image with the selected ViviLink destination site.
- 8) Remember that the ViviLink feature is deactivated by default. A ViviLink destination will only be assigned to a photo or video if you manually set it from this menu or from the ViviLink menu in Capture mode (accessible with the Vivilink Quick-Function button in Capture mode).
- 9) Changing the ViviLink destination site will also make the selected site the new default ViviLink option. A new default can be selected at any time through this menu.

### Protect/Lock Menu

Pictures and Videos taken with your camera can be protected or "locked" to prevent any deletion or alteration being made to the files.

- 1) Press the **OK** button to open the menus for the current mode.
- 2) Press the **LEFT** or **RIGHT** direction control buttons to scroll and select the chosen menu.
- 3) Press the **UP** or **DOWN** direction control buttons to scroll through the menu options.
- 4) Press the **OK** button to select the desired option.
- 5) Press the **MODE** button to exit the menu and return to your previous mode.
- 6) Any image that is locked will display a lock symbol on the LCD screen when viewing that image in the playback mode. Videos that are not locked will not display the lock symbol.
- 7) Remember that you cannot delete locked videos.

### Delete Menu

While in the Playback mode, you can delete videos from your camera through the delete menu.

- 1) View the image you would like to delete.
- 2) Press the **OK** button to open the menus for the current mode.
- 3) Press the **LEFT** or **RIGHT** direction control buttons to scroll and select the chosen menu.
- 4) Press the **UP** or **DOWN** direction control buttons to scroll through the menu options.
- 5) To delete this one video, select “Delete This Video”.
- 6) To delete all the images (including all unlocked photos and videos) on your camera’s memory card, select “Delete All Images”.
- 7) Press the **OK** button to select the desired option.
- 8) You will be asked to confirm your selection.
- 9) The videos will be deleted as desired.

## Connecting the Camera to the TV and HDTV

### Connecting the Camera to the TV

The camera has an AV port to use your larger TV screen in place of the camera’s LCD screen. On plugging the TV-out cable (supplied) to the camera’s AV out jack, the LCD screen turns blank. Use the camera as you would to capture and playback photos and videos. The images will appear on the TV instead of on the LCD screen.

**Note:** The only limitation of using the TV screen is that the camera is now not portable.

- 1) Connect the camera to a TV via the TV-out cable (supplied).
- 2) Turn on the TV and the camera, and then set the TV to “AV” mode.
- 3) You will need to set the TV format on the camera to suit the TV format of your TV set.
- 4) Make sure the camera is set to the correct TV Output setting. On plugging in the TV out cable a message will appear on the LCD screen to select NTSC or PAL for the type of TV you are using.
- 5) Select the option as per the format of the TV set you are using and press the **OK** button.
- 6) When the camera is set to Video or Photo capture mode, you can preview the subjects you want to record on the TV screen and view the recording on the TV.
- 7) When the camera is set to Playback mode, you can review all the stored photos and videos on the TV.
- 8) In Playback Mode, push the **Left** or **Right** button to select the video file to view. Press the **Video** button to Play the selected video file. Press it again to Pause playing. Press the **OK** button to Stop the video.

### **Connecting the Camera to the HDTV**

To view the high resolution quality videos recorded with your camera, connect the camera to an HDTV with the HDMI cable provided.

On plugging the HDMI cable to the camera’s HDMI port, the LCD screen turns blank. Use the camera as you would to capture and playback photos and videos. The images will appear on the HDTV instead of on the LCD screen.

**Note:** The only limitation of using the HDTV screen is that the camera is now not portable.

- 1) Connect the camera to an HDTV with the HDMI cable.
- 2) Turn on the HDTV and switch to HDMI-mode.
- 3) Turn on the camera. When the camera is set to Video or Photo Capture mode, you can preview the subjects you want to record on the TV screen and view the recording on the TV.
- 4) When the camera is set to Playback mode, you can review all the stored photos and videos on the TV.
- 5) In Playback Mode, push the **Left** or **Right** button to select the video file to view.
- 6) Press the **Video** button to Play the selected video file. Press it again to Pause playing.
- 7) Press the **OK** button to Stop the video.



## Installing the Software

You must be connected to the internet to install and run the Vivitar Experience Image Manager software.

- 1) Insert the installation CD into your CD-ROM drive. The installation screen should automatically open.



- 2) On PC: The Vivitar Experience Image Manager Installer window appears. If the window does not appear, open the application's CD/DVD drive and click on "Setup.exe" to launch the installer.
- 3) On Macintosh: Click the icon that appears on the desktop to install the Vivitar Experience Image Manager.
- 4) If you do not have internet access at the time of inserting the CD-ROM, connect to the internet and then click the "Install Vivitar Experience Image Manager" button to begin the installation.



**Note:** If you do not have internet access, you can still download media from the camera. Click the “How to transfer photos and videos from my camera to my computer” button for instructions.

- 5) If you have internet access, the “Choose your language” window opens, choose your language and click “Next” to open the next window.
- 6) Select your camera model from the list and click “Next” to open the next window.
- 7) Click “Next” to confirm your camera model selection and to install the application.
- 8) Please wait while the application is being installed on your computer.
- 9) Please review the license terms.

On PC and Macintosh: Click the “I accept the terms of this license agreement” and then click “Next” to continue.

- 10) On PC only: Let the “Vivitar Experience Image Manager” installer create the folder to where the program will be installed, and then click “Install”.
- 11) Please wait while the application continues the installation process on your computer.
- 12) On PC: Click the “Close” button when the installation is complete.  
Click the “Launch Vivitar Experience Image Manager” to open the application.
- 13) On Macintosh: Click the “Quit” button when the installation is complete.  
Click the “Launch Vivitar Experience Image Manager” to open the application.
- 14) If you close the application you can run the Vivitar Experience Image Manager from the Programs (PC) or Applications (Mac) menu on your computer.



## Connecting the Camera to the Computer

- 1) Use the USB cable that came with your camera to connect your camera to your computer.
- 2) Power the camera ON.
- 3) The first time you connect the device to the computer you will have to wait a few seconds until the computer recognizes the device.

## Getting Photos and Videos from your Camera to Your Computer

An SD card needs to be inserted. Do not disconnect the cable during transfer. Doing so will cancel the transfer of any files on their way to your computer.

- 1) Select the “Get Images” button from the Main menu.



- 2) The “Get Images from device” window opens.
- 3) You can select to download photos, videos or both.
- 4) Select your camera (removable disk) from the device window. If your camera is the only USB device connected then it will be selected automatically.
- 5) Select a location on the computer where to place the new photo and video files.
- 6) Add the new photo and video files to albums if desired.
- 7) Select to remove the media files from the selected device (removable disk) after the import.
- 8) Click the “Get Images” button to transfer the photos and videos from your camera to your computer.
- 9) A media download progress bar appears on the bottom left showing the number of media files downloading to your computer. A message appears when the download is complete.
- 10) The photo and video files that you selected are now downloaded to your computer to the selected folder and albums ready for your use.

## Get started!

Using the Vivitar Experience Image Manager, you can:

- Upload and manage photos and videos to and from the most popular photo sharing and social networking sites - Facebook, Flickr, Picasa, MySpace, Photobucket, Twitpic, Twitgoo and YouTube
- Seamlessly transfer photos and videos from one social network to another
- Organize your images by creating offline and online albums
- Edit images using automatic and manual tools
- Use automatic “Geotagging” with built in Google Maps

**For more details on how to use the Vivitar Experience Image Manager open the Help file or click the “Take the Tour” button on the application`s Home page.**

## Transfer media from my camera to my computer manually (Using Windows)

- 1) Use the USB cable that came with your camera to connect your camera to your computer.
- 2) MSDC appears on the LCD.
- 3) A window appears with a list of options, select “Open folder to view files” and click OK.
- 4) Open the DCIM folder and the folder inside to view the media files.
- 5) Select the media and copy the files from this folder into your computer. Optionally, select the files and choose Copy from the Edit menu. Then select a folder and choose Paste from the Edit menu.
- 6) We recommend that you copy the images into the Pictures/My Pictures folder and the videos into the Videos/My Videos folder.
- 7) Do not disconnect the cable during transfer. Doing so will cancel the transfer of any files on their way to your computer.

## Transfer media from my camera to my computer manually (Using Macintosh)

- 1) Use the USB cable that came with your camera to connect your camera to your computer.
- 2) MSDC appears on the LCD.
- 3) The camera's device icon appears on the desktop.
- 4) Click on the device icon and open the DCIM folder and the folder inside to view the media files.
- 5) Select the files and drag them into your computer. Optionally, select the files and choose Copy from the Finder's Edit menu. Then select a folder and choose Paste from the Edit menu.
- 6) We recommend that you copy the images into the Pictures folder and the videos into the Movies folder.
- 7) Do not disconnect the cable during transfer. Doing so will cancel the transfer of any files on their way to your computer.

## Camera Maintenance

The digital camera is a delicate device. Please handle your camera with care to avoid damaging it.

Do not expose your camera to heat sources.

Do not use you camera in wet or moist conditions.

## Sakar Warranty Card

This warranty covers for the original consumer purchaser only and is not transferable. Products that fail to function properly **UNDER NORMAL USAGE**, due to defects in material or workmanship will be repaired at no charge for parts or labor for a period of one year from the time of purchase.

### What Is Not Covered By Warranty:

Damages or malfunctions not resulting from defects in material or workmanship and damages or malfunctions from other than normal use, including but limited to, repair by unauthorized parties, tampering, modification or accident.

### What To Do When Service Is Required:

When returning your defective product (postage pre-paid) for service, your package should include:

- 1) Copy of **original** bill of sale
- 2) A detailed written description of the problem.
- 3) Your return address and telephone number (Daytime)

MAIL TO ADDRESS BELOW:

<u>Sakar US</u>	<u>Sakar UK/Europe</u>	<u>Sakar Australia</u>
Sakar International Attention: Service Department 195 Carter Drive Edison, NJ 08817	Attention: Service Department 2D, Siskin Parkway East 4020 Middlemarch Business Park Coventry, CV3 4PE	Return faulty camera to the Refund Counter at the store where purchased

## Technical Support

For technical support issues please visit our website at **www.vivitar.com**. You can find manuals, software and FAQ's at the website. Can't find what you are looking for? E-mail us at **support@vivitar.com** and one of our technical support team members will answer your questions. For phone support in the US please call 1-800-592-9541, in the UK call 0800 917 4831, in Australia call 1800-006-614. If you would like to call from anywhere else, please visit **www.vivitar.com** for your local toll free number.

## Troubleshooting

**Q: I have taken photos and selected the "Get Images" button. I get a message that the images were successfully transferred but the photos do not appear on my computer.**

**What do I do?**

First ensure that you have in fact taken photos. Press the Shutter button to take some sample photos and then try downloading them again.

With test photos if the camera powers off before you upload them to the computer the photos are not stored in the camera's memory. These photos should be uploaded quickly before the camera powers off. If the photos are saved to the SD memory card then all the photos should appear.

**Q: How do I make sure I don't lose important pictures?**

This camera requires an SD card for normal use. If the camera powers off nothing will happen to the images stored on the SD memory card. We recommend always downloading your photos to your computer as soon as possible to prevent unintentional data loss.

**Q: I deleted images using the Vivitar Experience Image Manager. The images were also deleted from my computer. How do I recover images that I accidentally deleted?**

All images deleted using the Vivitar Experience Image Manager are sent to your computer's Recycle or Trash Bin and can be retrieved from there.

## Free Manuals Download Website

<http://myh66.com>

<http://usermanuals.us>

<http://www.somanuals.com>

<http://www.4manuals.cc>

<http://www.manual-lib.com>

<http://www.404manual.com>

<http://www.luxmanual.com>

<http://aubethermostatmanual.com>

Golf course search by state

<http://golfingnear.com>

Email search by domain

<http://emailbydomain.com>

Auto manuals search

<http://auto.somanuals.com>

TV manuals search

<http://tv.somanuals.com>