

www.vivitekcorp.com

View of the Digital World

51" Micro Display Projection TV USER GUIDE

View of the Digital World





DEAR CUSTOMER

Thank you for your purchase of this Rear Projection Television. To ensure safety and many years of trouble-free operation of your product, please read the Important Safety Instructions carefully before using this product.

IMPORTANT INFORMATION

WARNING: TO REDUCE THE RISK OF FIRE OR ELECTRIC SHOCK, DO NOT EXPOSE THIS PRODUCT TO RAIN OR MOISTURE.

	CAUTION RISK OF ELECTRIC SHOCK DO NOT OPEN	
CAUTION: TO REDUCE THE RISK OF ELECTRIC SHOCK, DO NOT REMOVE COVER. NO USER-SERVICEABLE PARTS EXCEPT LAMP UNIT. REFER SERVICING TO QUALIFIED SERVICE PERSONNEL.		



The lightning flash with arrow-head symbol, within an equilateral triangle, is intended to alert the user to the presence of uninsulated "dangerous voltage" within the product's enclosure that may be of sufficient magnitude to constitute a risk of electric shock to persons.



The exclamation point within a triangle is intended to alert the user to the presence of important operating and maintenance (servicing) instructions in the literature accompanying the product.

WARNING: FCC Regulations state that any unauthorized changes or modifications to this equipment not expressly approved by the manufacturer could void the users authority to operate this equipment.

CAUTION:

This product satisfies FCC regulations when shielded cables and connectors are used to connect the unit to other equipment. To prevent electromagnetic interference with electric appliances such as radios and televisions, use shielded cables and connectors for connections.

DECLARATION OF CONFORMITY

REAR PROJECTION TV, MODEL RP51

This device complies with Part 15 of the FCC Rules. Operation is subject to the following two conditions:

(1) This device may not cause harmful interference, and (2) this device must accept any interference received, including interference that may cause undesired operation.

RESPONSIBLE PARTY:

Vivitek Corp.

48017 Fremont Blvd.

Fremont, CA 94538

Service phone number : 1-877-603-3582

For Business Customers : URL <http://www.vivitekc corp.com>

INFORMATION:

This equipment has been tested and found to comply with the limits for a Class B digital device, pursuant to Part 15 of the FCC Rules. These limits are designed to provide reasonable protection against harmful interference in a residential installation. This equipment generates, uses and can radiate radio frequency energy and, if not installed and used in accordance with the instructions, may cause harmful interference to radio communications. However, there is no guarantee that interference will not occur in a particular installation. If this equipment does cause harmful interference to radio or television reception, which can be determined by turning the equipment off and on, the user is encouraged to try to correct the interference by one or more of the following measures:

- Reorient or relocate the receiving antenna.
- Increase the separation between the equipment and receiver.
- Connect the equipment into an outlet on a circuit different from that to which the receiver is connected.
- Consult the dealer or an experienced radio/TV technician for help.

"Note to CATV system installer: This reminder is provided to call the CATV system installers attention to Article 820-40 of the National Electrical Code that provides guidelines for proper grounding and, in particular, specifies that the cable ground shall be connected to the grounding system of the building, as close to the point of cable entry as practical."

This product utilizes tin-lead solder, and fluorescent lamp containing a small amount of mercury. Disposal of these materials may be regulated due to environmental considerations. For disposal or recycling information, please contact your local authorities or the Electronic Industries Alliance : www.eia.org

TRADEMARKS

- Manufactured under license from Dolby Laboratories. "Dolby" and the double-D symbol are trademarks of Dolby Laboratories.

- Manufactured under license from BBE Sound, Inc.
Licensed by BBE Sound, Inc. under USP, 5510752 and 5736897. BBE and BBE sysbol are registered trademarks of BBE Sound, Inc.

- HDMI, the HDMI logo and High-Definition Multimedia Interface are trademarks or registered trademarks of HDMI Licensing LLC.

- DCDi [®]by Faroudja is a registered trademark of Genesis Microchip Inc.

- DLP [™](Digital Light Processing) and DMD [™](Digital Micromirror Device) are trademarks of Texas Instruments, Inc.
- Some IC chip in this product includes confidential and/or trade secret property belonging to Texas Instruments.
Therefore you may not copy, translate, distribute, reverse engineer, reverse assemble or discompile the contents thereof.

IMPORTANT SAFETY INSTRUCTIONS

CAUTION : Please read all of these instructions before you operate this product and save these instruction for later use.

Electricity is used to perform many useful functions, but it can also cause personal injuries and property damage if improperly handled. This product has been engineered and manufactured with the highest priority on safety. However, improper use can result in electric shock and/or fire. In order to prevent potential danger, please observe the following instructions when installing, operating and cleaning the product. To ensure your safety and prolong the service life of your Rear Projection Television, please read the following precautions carefully before using the product.

- 1) Read these instructions.
- 2) Keep these instructions.
- 3) Heed all warnings.
- 4) Follow all instructions.
- 5) Do not use this apparatus near water.
- 6) Clean only with dry cloth.
- 7) Do not block any ventilation openings. Install in accordance with the manufacturer's instructions.
- 8) Do not install near any heat sources such as radiators, heat registers, stoves, or other apparatus (including amplifiers) that produce heat.
- 9) Do not defeat the safety purpose of the polarized or grounding-type plug. A polarized plug has two blades with one wider than the other. A grounding type plug has two blades and a third grounding prong. The wide blade or the third prong are provided for your safety. If the provided plug does not fit into your outlet, consult an electrician for replacement of the obsolete outlet.
- 10) Protect the power cord from being walked on or pinched particularly at plugs, convenience receptacles, and the point where they exit from the apparatus.
- 11) Only use attachments/accessories specified by the manufacturer
- 12) Use only with the cart, stand, tripod, bracket, or table specified by the manufacturer, or sold with the apparatus. When a cart is used, use caution when moving the cart/apparatus combination to avoid injury from tip-over.
- 13) Unplug this apparatus during lightning storms or when unused for long periods of time.
- 14) Refer all servicing to qualified service personnel. Servicing is required when the apparatus has been damaged in any way, such as power-supply cord or plug is damaged, liquid has been spilled or objects have fallen into the apparatus, the apparatus has been exposed to rain or moisture, does not operate normally, or has been dropped.
- 15) Power Sources - This product should be operated only from the type of power source indicated on the marking label. If you are not sure of the type of power supply to your home, consult your product dealer or local power company. For products intended to operate from battery power, or other sources, refer to the operating instructions.
- 16) Overloading - Do not overload wall outlets, extension cords, or integral convenience receptacles as this can result in a risk of fire or electric shock.
- 17) Object and Liquid Entry - Never push objects of any kind into this product through openings as they may touch dangerous voltage points or short-out parts that could result in a fire or electric shock. Never spill liquid of any kind on the product.
- 18) Damage Requiring Service - Unplug this product from the wall outlet and refer servicing to qualified service personnel under the following conditions:
 - a) When the AC cord or plug is damaged,
 - b) If liquid has been spilled, or objects have fallen into the product,
 - c) If the product has been exposed to rain or water,
 - d) If the product does not operate normally by following the operating instructions.
Adjust only those controls that are covered by the operating instructions as an improper adjustment of other controls may result in damage and will often require extensive work by a qualified technician to restore the product to its normal operation,
 - e) If the product has been dropped or damaged in any way, and
 - f) When the product exhibits a distinct change in performance - this indicates a need for service.
- 19) Replacement Parts - When replacement parts are required, be sure the service technician has used replacement parts specified by the manufacturer or have the same characteristics as the original part. Unauthorized substitutions may result in fire, electric shock, or other hazards.
- 20) Safety Check - Upon completion of any service or repairs to this product, ask the service technician to perform safety checks to determine that the product is in proper operating condition.



IMPORTANT SAFETY INSTRUCTIONS

- Water and Moisture - Do not use this product near water-for example, near a bath tub, wash bowl, kitchen sink, or laundry tub; in a wet basement; or near a swimming pool; and the like.

- Selecting the location - Select a place with no direct sunlight and good ventilation.

- Ventilation - The vents and other openings in the cabinet are designed for ventilation. Do not cover or block these vents and openings since insufficient ventilation can cause overheating and/or shorten the life of the product. Do not place the product on a bed, sofa, rug or other similar surface, since they can block ventilation openings. This product is not designed for built-in installation; do not place the product in an enclosed place such as a bookcase or rack, unless proper ventilation is provided or the manufacturer's instructions are followed.

- Heat - The product should be situated away from heat sources such as radiators, heat registers, stoves, or other products (including amplifiers) that produce heat.

- Lightning - For added protection for this television equipment during a lightning storm, or when it is left unattended and unused for long periods of time, unplug it from the wall outlet and disconnect the antenna. This will prevent damage to the equipment due to lightning and power-line surges.

- Power Line - An outside antenna system should not be located in the vicinity of overhead power lines or other electric light or power circuits, or where it can fall into such power lines or circuits. When installing an outside antenna system, extreme care should be taken to keep from touching such power lines or circuits as contact with them might be fatal.

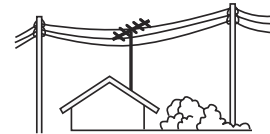

- Outdoor Antenna Grounding - If an outside antenna is connected to the television equipment, be sure the antenna system is grounded so as to provide some protection against voltage surges and built-up static charges. Article 810 of the National Electrical Code, ANSI/NFPA 70, provides information with regard to proper grounding of the mast and supporting structure, grounding of the lead-in wire to an antenna discharge unit, size of grounding conductors, location of antenna-discharge unit, connection to grounding electrodes, and requirements for the grounding electrode.

EXAMPLE OF ANTENNA GROUNDING AS PER NATIONAL ELECTRICAL CODE, ANSI/NFPA 70

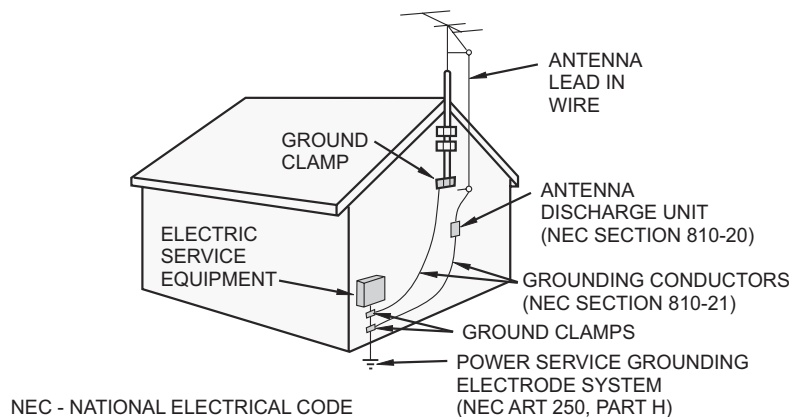

- To prevent fire or shock hazard, do not expose this product to dripping or splashing. No objects filled with liquids, such as vases, should be placed on the product.

- To prevent fire or shock hazard, do not place the AC power cord under the TV set or other heavy items.

Contents

DEAR CUSTOMER	ii
IMPORTANT INFORMATION	ii
TRADEMARKS	iv
IMPORTANT SAFETY INSTRUCTIONS	v
Contents	1
Main Features	2
Supplied Accessories	3
Before Operating Your Rear Projection Television	3
Cleaning & Maintenance	5
Antenna Connections	6
Television Antenna Connection Protection	6
Using The Video and Audio Input Terminals	8
Connecting your Digital Video Equipment (HDMI & DVI)	9
Connecting your DVD Player	10
Connecting your GAME CONSOLE or CAMCORDER	12
Connecting Your Computer	13
Computer Compatibility Chart	14
Using the Center Channel Input	15
Using the Audio Output	16
Side Control Section	17
Status LED	18
Remote Control Key Functions	19
Remote Control Operation	22
Menu Functions	24
Getting Started	24
Using the On Screen Display (OSD)	25
Setting a Password for Parental Control	29
Using Wide Modes: View Mode	30
Replacing the Lamp	31
Status LEDs	32
Troubleshooting Guide	33
Specifications	35
Dimension	36
Input / Output Terminals and Connectable Equipment	37
APPENDIX: Remote Control IR Set Up Codes	38~49
Index	50~51

Main Features



Please enjoy your Rear Projection Television (RPTV) that features:

- Texas Instruments® latest DLP™ (Digital Light Processing) third generation HD4 Digital Micromirror Device (DMD) which features Smooth Picture™ technology for the very best image quality.
- Built in ATSC and NTSC tuners for enjoying digital and analog "off air" broadcast signals.
- View high definition signals by using an external HDTV Set Top Box (Satellite or Cable) and RGB, HDMI, DVI or component video outputs from the STB into the RPTV.
- An HDMI terminal for Digital video equipment that supports HDCP (High-bandwidth Digital Content Protection).
- Two high-definition capable component video inputs that automatically synchronize with your RPTV to match the incoming source.
- Three sets of A/V inputs for conventional video equipment such as DVD players, VCRs etc.
- PC signal input: RGB D-SUB
- Supported signals:
 - 480i, 480p, 720p and 1080i
 - Automatically converts all signals to 720p display format.
 - HDMI Video Mode: 480p, 720p, 1080i.
 - HDMI PC Mode: VGA
 - Computer Input : 1024x768 XGA
- Bright, Flicker-free image with outstanding image detail and clarity.
- Film Mode 3:2 pull down for automatic detection and conversion of film based content for accurate display with minimal motion artifacts and video noise.
- High contrast ratio that delivers accurate color processing and deep black levels.
- Picture-in-Picture (PIP) modes that let you watch multiple programs or video sources simultaneously
- A Digital Zoom mode that eliminates "back bars" around the display image.
- An integrated audio system featuring BBE™ sound processing for maximized sound quality.
- Center Channel Input terminal that is convenient for Home Theater set up.
- Light up Universal Remote control

Other benefits include:

- No possible convergence errors.
- No screen aging, image retention or burn in effects.
- User-friendly replaceable lamp for hours of enjoyment.

Supplied Accessories

	
Multi-function Remote Control	Size AA Dry Batteries (2pcs.)

Before Operating Your Rear Projection Television

Location

- For normal operation, your RPTV should be set up in the room where cool, adequate ventilation is provided. Do not position the back of the RPTV in a place where free airflow is restricted.
- Any magnetic force may disturb the color picture. Make sure that magnets, speakers, electric clocks, toys using magnets or any other magnetic equipment, such as an iron are kept well away from this RPTV.

Power

Your RPTV operates on AC 120 Volts, 60 Hertz (normal household current in the USA) and has a polarized plug. If you are unable to insert the plug fully into the outlet, try reversing the plug. If it does not fit, contact an electrician. Do not defeat the safety feature of the polarized plug.

- If the RPTV is not used for a long period, unplug the RPTV from the wall outlet to economize power. (If the RPTV is plugged in, slight current still flows, even with the POWER button in the OFF position.)
- When a FM tuner or radio is located near the RPTV Lines and other noise may appear in TV broadcast images when radio and TV broadcasts are received at the same time. If video noise more appears, turn off either the RPTV or the radio.
- If you are listening to AM broadcasts, turn the RPTV off. Some AM broadcast signals may not be received due to interference from the RPTV.

Viewing

Your TV is best viewed by sitting directly in front of it about 10 to 18 feet from the screen. The brightness decreases as the viewer moves to the left or to the right of the set.

During the daytime, reflections from light outside may appear on the screen. Drapes or screens can be used to reduce the reflection or the RPTV can be placed in a different location of the room.

If the RPTV's audio output is connected to a Hi-Fi system's external speakers, the best audio performance will be obtained by placing the speakers on each side of the set at an equal distance as well as on a height which is equal to that of the screen center. For best stereo separation, first place the external speakers at least four feet from each side of the RPTV, then place the surround speakers to the side or behind the viewing area. Due to the differences in room sizes and acoustic environments some experimentation regarding speaker placement for best performance will be required.

Remote Control

To use the remote control, insert batteries first.

1. Open the battery cover.
Pull up the lid in the direction of the arrow.

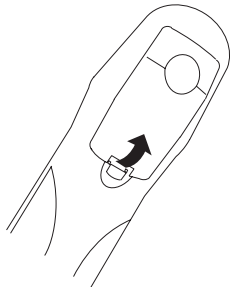

2. Load the batteries. Insert two "AA" size batteries supplied so that the battery poles are positioned as indicated.

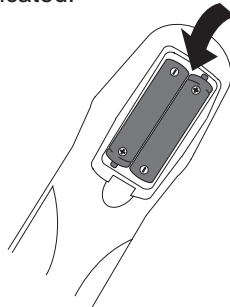

3. Close the battery cover.
Lower the lid in the direction of the arrow.

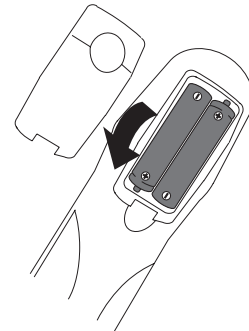

Cleaning & Maintenance

Cleaning the Screen

The screen of the RPTV has been specially treated. To clean users should wipe the surface gently using only a cleaning or a soft, lint-free cloth. If the surface is particularly dirty, use a little water on the cloth (never directly on the screen), then wipe the screen with it.

Reminders:

- Do not use substances such as glass cleaners, solvents and/or thinners.
- Do not scratch or hit the surface of the screen with fingers or any hard objects.

The screen of the RPTV is made of specially coated plastic and can be scratched or damaged by abrasive or ammonia-based window cleaners. Scratches on the bezel or screen are not covered by the warranty.

Cleaning the Exterior

The RPTV is cooled by air circulated through the vents in the case so for optimized performance, keep the vents clear of dust. To clean, turn off and unplug the RPTV, then brush the dust away from the vents with a damp cloth. Be careful not to drip any water into the vents.

Reminders:

- Do not attempt to clean dust from the inside of the RPTV.
- Do not use abrasives or solvent cleaners because they can damage the finish on the components.
- Do not allow any excessive water or moisture to come into contact with the surface of the DLP TV. If water or moisture gets inside the RPTV, operating problems and electrical hazards may result.
- Do not scratch or hit the surface of the screen with fingers or any hard objects.
- Do not place articles made of rubber or PVC near the cabinet for any extended periods of time.

Antenna Connections

- To fully utilize the various features provided, such as the 2-Tuners Picture In Picture System, UNIVERSAL PLUS, and some connectors for high-quality VCR/DVD playback, set up this unit properly by following the procedures below.

Remote Control

- The Remote Control is compatible with various VCR/DVD players and other manufacturer's AV equipment by setting the correct control code. (Page 38-49)

Antennas

- The antenna required for good color RPTV reception are more important than those for black & white television reception. For this reason, a good quality outdoor antenna is strongly recommended.

Type of connector	
<p>1. The 75 ohm system generally uses a round cable with an F-type connector that can easily be attached to a terminal without tools (not supplied) The F-type connector should be finger tightened only.</p> <p>2. The 300 ohm system uses a flat "twin-lead" cable that can be attached to a 75 ohm terminal through a 300-75 ohm ADAPTOR (not supplied)</p>	<p>F-type connector</p> <p>75-ohm coaxial cable (round)</p> <p>300-ohm twin-lead cable (flat)</p>

- A good color picture depends on a strong TV signal. Ask your dealer for advice on how to install your external antenna to receive the best possible signal.
- If you subscribe to Cable or Satellite TV or have a central antenna in your building, you may not need an external Antenna.

Television Antenna Connection Protection

External Television Antenna Grounding

If an outside antenna or cable system is to be connected to the RPTV, make sure that the antenna or cable system is electrically grounded to provide some protection against voltage surges and static charges. Please refer to the operating or operation manual of your antenna or cable system for further information.

Article 810 of the National Electrical Code, ANSI/NFPA 70, provides information with regard to proper grounding of the mast and supporting structure, grounding of the lead-in wire to an antenna discharge unit, size of grounding conductors, location of antenna discharge unit, connection to grounding electrodes, and requirements for the grounding electrode.

Lightning Protection

For added protection of the RPTV during a lightning storm or when it is left unattended or unused for long periods of time, unplug the RPTV from the wall outlet and disconnect the antenna or cable system.

Power Lines

Do not locate the antenna near overhead light or power circuits, or where it could fall into such power lines or circuits.

Antenna Connections

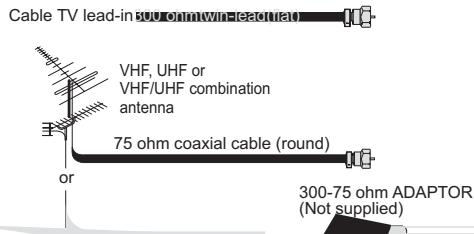

NOTICE:

F-type connector should be finger-tightened only. When connecting the RF cable to the TV set, do not tighten F-type connector with tools. If tools are used, it may cause damage to your TV set. (The breaking of internal circuit, etc.)

CABLE TV (CATV) CONNE

A 75 ohm coaxial cable connector is built into the set for easy hookup. When connecting the 75 ohm coaxial cable to the set, screw the 75 ohm cable to the COAXIAL CABLE CONNECTOR.

Some cable TV companies offer "premium pay channels". Since the signals of these premium pay channels are scrambled, a cable TV converter/descrambler is generally provided to the subscriber by the cable TV company. This converter/descrambler is necessary for normal viewing of the scrambled channels. (Set your TV on channel 3 or 4. Typically one of these channels is used. If channel is unknown, consult your cable TV company.) For more specific instructions on installing cable TV, consult your cable TV company. One possible method of utilizing the converter/descrambler provided by your cable TV company is explained below.

Please note: RF switch equipped with position A/B (not provided) is required.

"A" position on the RF switch (not supplied) : You can view all unscrambled channels using the TV's channel keys.

"B" position on the RF switch (not supplied) : You can view the scrambled channels via the converter/descrambler using the converter's channel keys.



Using The Video and Audio Input Terminals

Using the Video and Audio Input Terminals

Connecting video equipment for video playback.

When the television is connected to video equipment as shown below, the material being played back on the video equipment can be seen on the television screen.

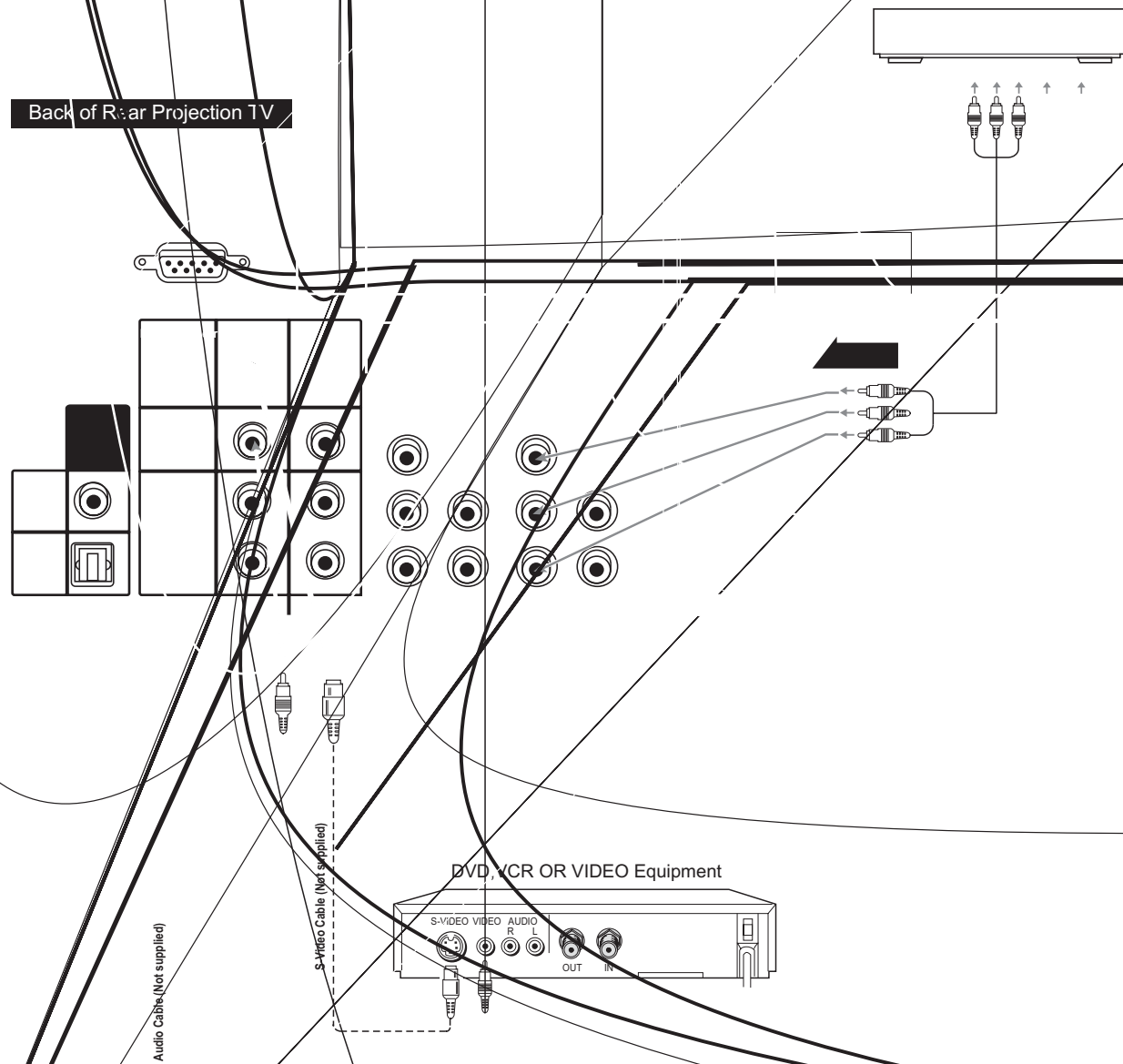

Connecting your Digital Video Equipment (HDMI & DVI)

Using Digital Video

Digital video equipment and other devices that have a digital interface compliant with the HDMI & DVI (Digital Visual Interface) standard should be connected to the HDMI input of the RPTV.

Note:

1. Turn off the power of the RPTV and digital video equipment.
2. Connect a HDMI cable to the output terminal of your digital video equipment and the other end to the HDMI input in the rear of your RPTV.
3. Turn on the power to the RPTV and your digital video equipment.
4. Select HDMI using the INPUT button on the right side of the RPTV or the remote control.
5. If your digital video equipment provides DVI output only, you should connect the DVI output from your Digital video equipment to the HDMI input on the rear of your RPTV. Connect both audio cables.
6. When using the DVI cable to reset OSD menu for "HDMI AUDIO" see page 27.
7. If your digital video equipment provides HDMI output, you should connect the cable from your digital video equipment to the HDMI input on the rear of your RPTV.

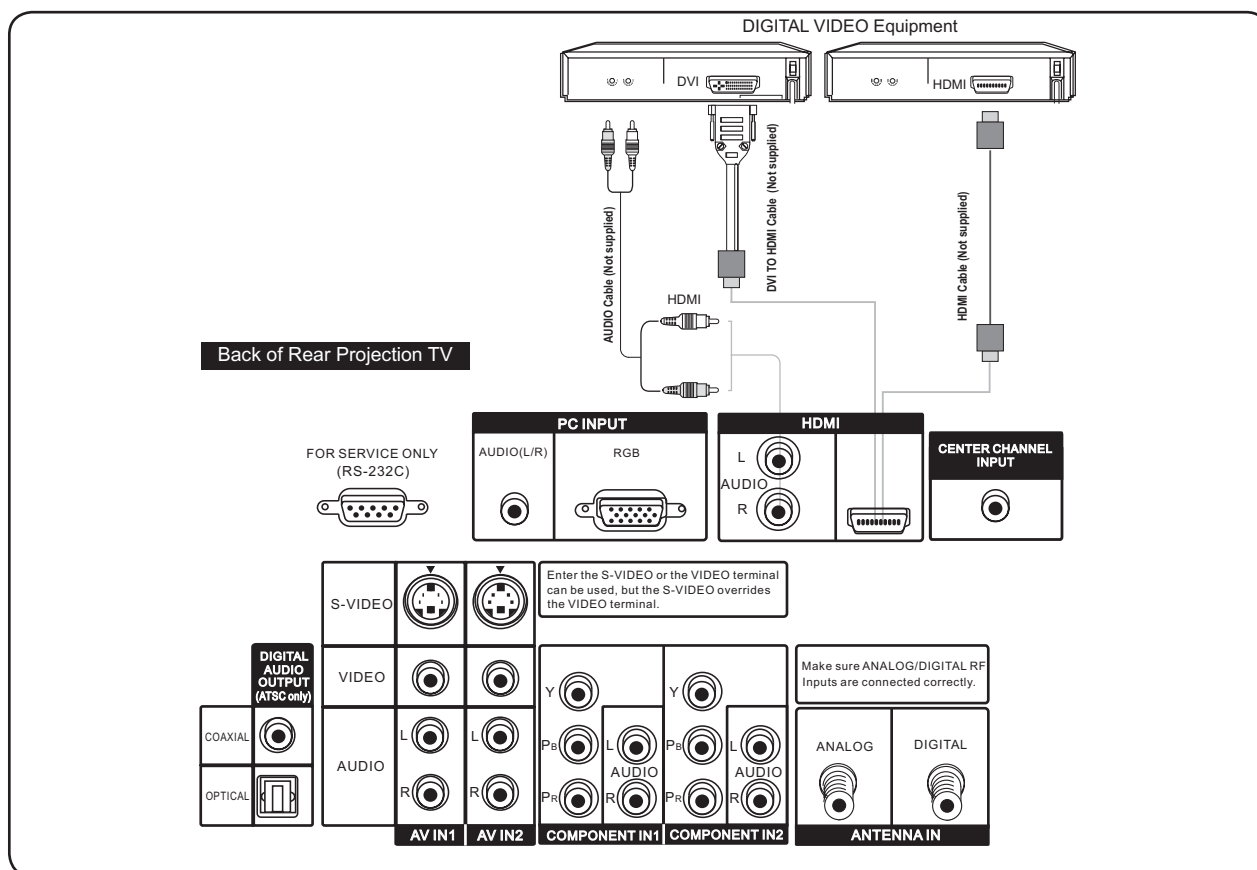

Note:

- a). The High Definition Multimedia Interface (HDMI). This interface is used between any audio/video source, such as a set-top box, DVD player, or A/V receiver, and an audio or video monitor, such as a DTV. HDMI supports standards, enhanced or high-definition video, plus-multi-channel digital audio on a single cable. The format transmits all ATSC HDTV standards and supports eight-channel digital audio (up to 192kHz sampling rate), with bandwidth to spare for future enhancements.
HDMI also uses a more compact and consumer electronics-friendly 15mm, 19-pin connector and will be fully compatible with the former DVI-HDCP standard.
The HDMI input on your RPTV supports High-bandwidth Digital Content Protection (HDCP). HDMI encrypts the transmission between the video source and the digital display for added security and protection.
- b). Refer to your Digital Device's User Manual for more information about the video output requirements of the product.

Connecting your DVD Player

Using S-Video or Composite video

1. Turn off the power of the RPTV and DVD player.
2. Connect the S-Video or video (yellow color) terminal from the rear of your DVD player to the S-Video or video (yellow color) terminal in the AV IN on the rear of your RPTV.
3. Connect the R (red color) and L (white color) audio connectors from the rear of your DVD player to the R (red color) and L (white color) audio input connectors in the AV IN 2 on the rear of your RPTV.
4. Turn on the power of the RPTV and DVD player.
5. Select AV 2 using the INPUT button on the right side of the RPTV or on the remote control.

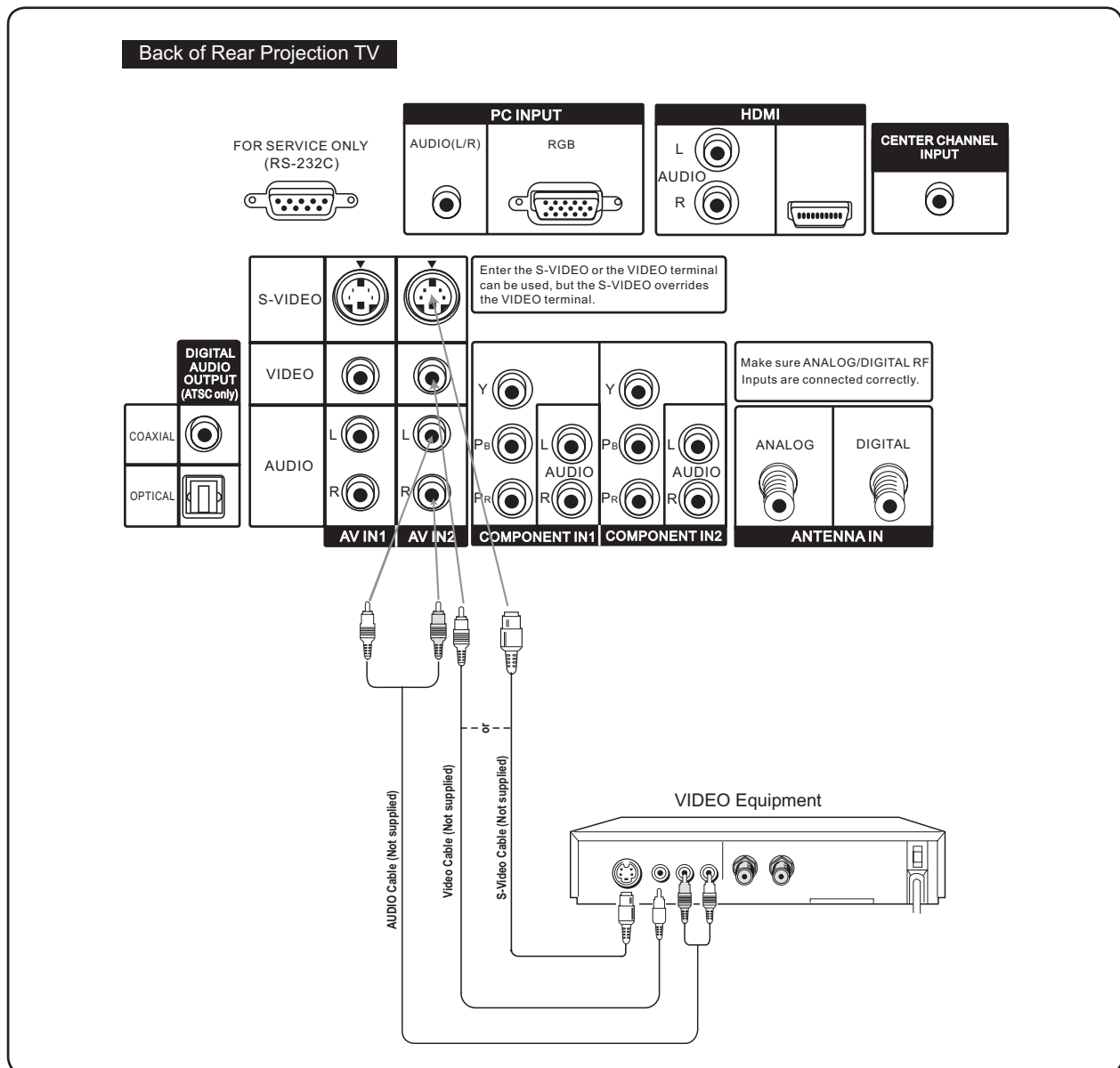

Note:

- a). If you are already using the AV IN 2 input for another component, or you do not want to use the AV IN 2 input for the DVD player, you can connect the DVD player to the AV IN 1 group of connections.
- b). Refer to your DVD player User Manual for more information about the video output requirements of the product.

Connecting your DVD Player

Using Component Video

1. Turn off the power to the RPTV and DVD player.
2. Connect the PR or CR (red color) connector from the rear of your DVD player to the PR/CR (red color) connector in the COMPONENT IN 1 on the rear of your RPTV.
3. Connect the PB or CB (blue color) connector from the rear of your DVD player to the PB/CB (blue color) connector in the COMPONENT IN 1 on the rear of your RPTV.
4. Connect the Y (green color) connector from the rear of your DVD player to the Y (green color) connector in the COMPONENT IN 1 on the rear of your RPTV.
5. Connect the R (red color) and L (white color) audio connectors from the rear of your DVD player to the R (red color) and L (white color) audio input connectors in the COMPONENT IN 1 from the rear of your RPTV.
6. Turn on the power of the RPTV and DVD player.
7. Select COMP 1 using the INPUT button on the right side of the RPTV or on the remote control.

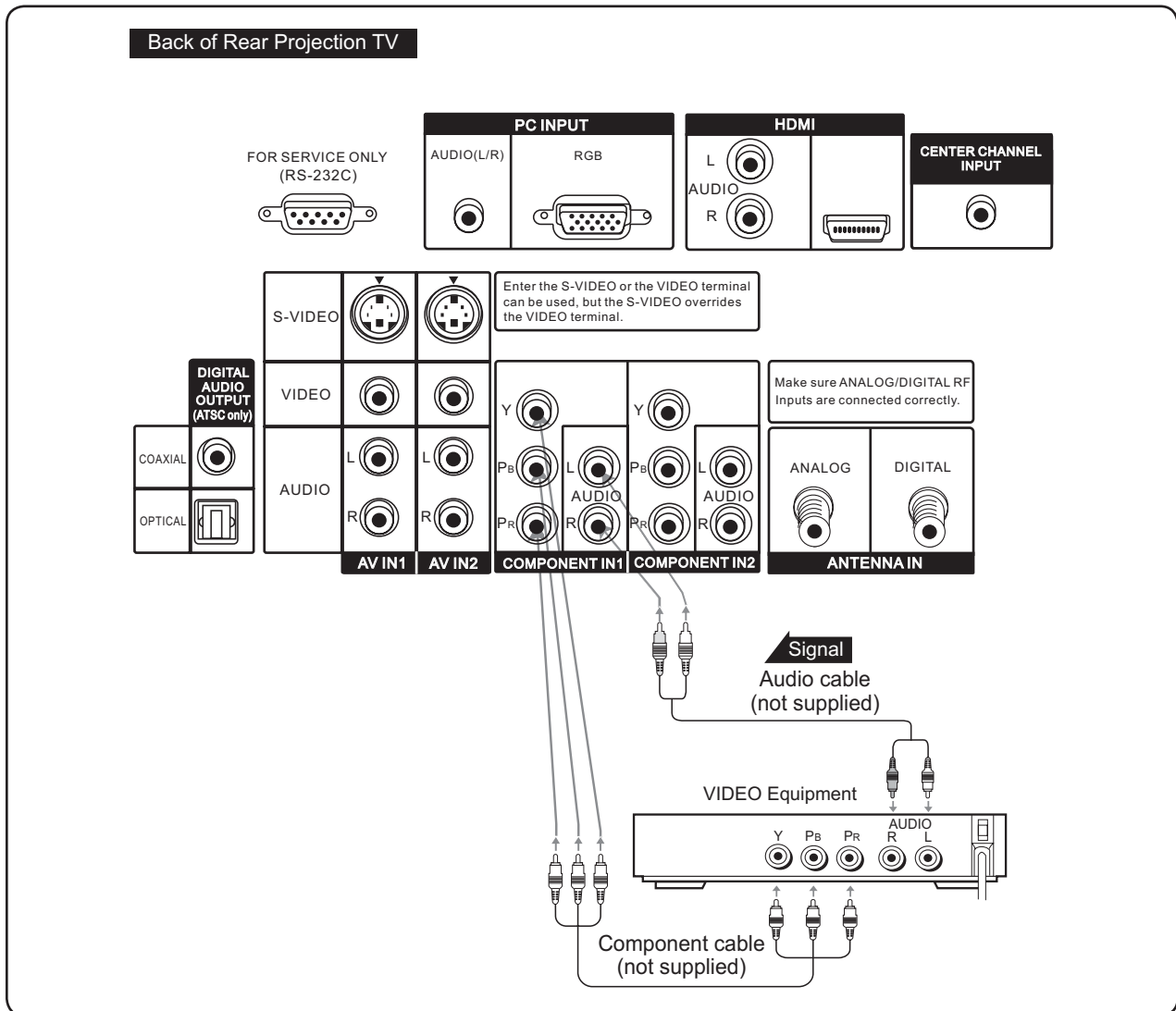

Note:

- a). If you are already using the Component IN1 input for another component, or you do not want to use the Component IN1 input for the DVD Player, you can connect the DVD player to the Component IN2 group of connection.
- b). Refer to your DVD player User Manual for more information about the video output requirements of the product.

Connecting your GAME CONSOLE or CAMCORDER

Using S-Video

1. Turn off the power of the RPTV and GAME CONSOLE or CAMCORDER.
2. Connect the S-Video terminal from your GAME CONSOLE or CAMCORDER to the S-Video terminal in AV IN 3 on the right side of your RPTV.
3. Connect the R (red color) and L (white color) audio connectors from your GAME CONSOLE or CAMCORDER to the R (red color) and L (white color) audio input connectors in AV IN 3 on the right side of your RPTV.
4. Turn on the power to the RPTV and GAME CONSOLE or CAMCORDER.
5. Select AV IN 3 using the INPUT button on the right side of the RPTV or on the remote control.

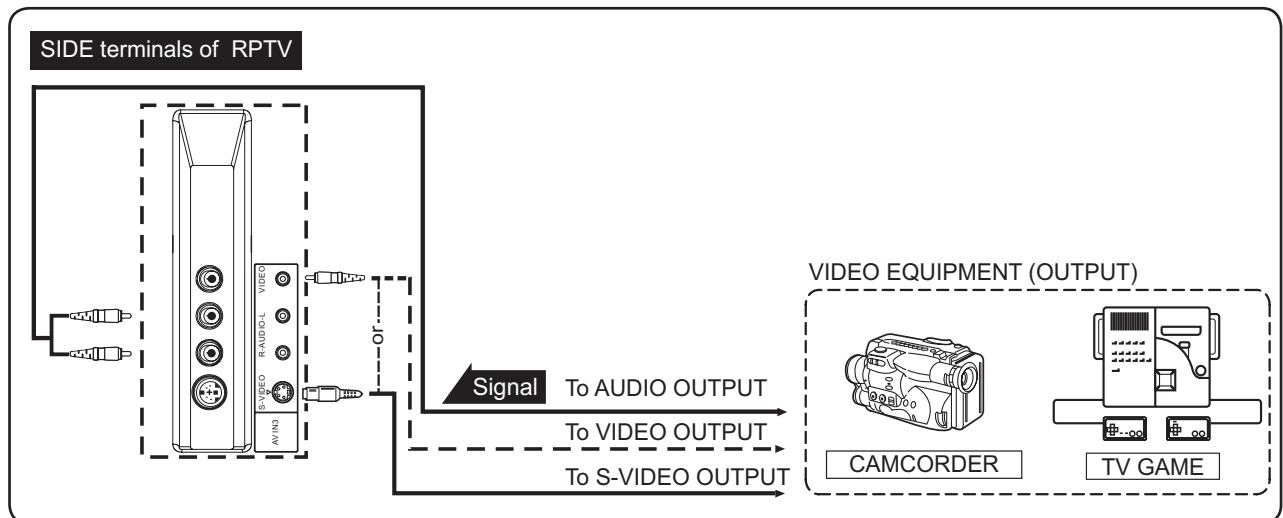
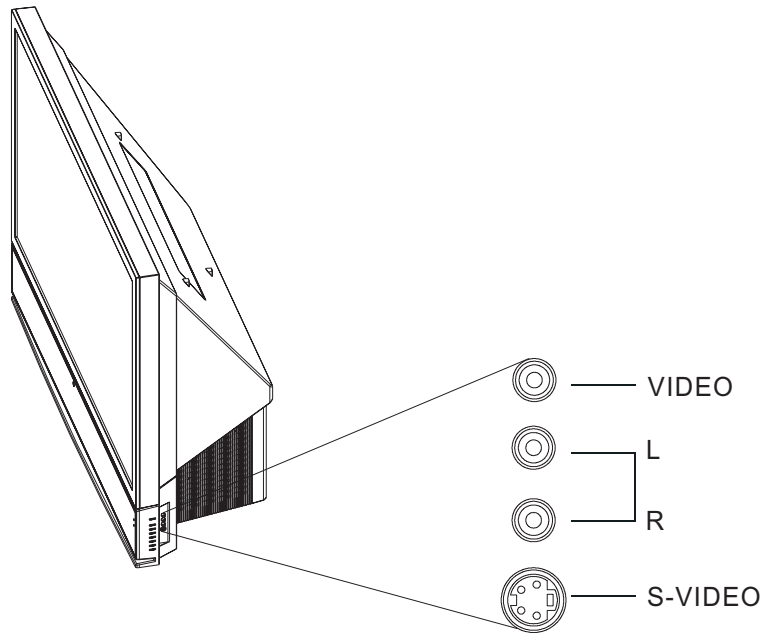

Note:

- The S-VIDEO INPUT terminal offers a higher quality image by accepting the signal separated into color and brightness signals.
- The S-VIDEO INPUT terminal are for video signal only. The audio signals are connected to AV IN3.

Connecting Your Computer

Using PC INPUT

1. Turn off the power of the RPTV and Computer.
2. Connect a VGA cable from the VGA CARD of your computer to the PC input in the rear of your RPTV.
3. Connect the Audio Out mini-jack from your computer to the VGA Audio (L/R) from the rear of your RPTV.
4. Turn on the power of the RPTV and your computer.
5. Select RGB using the INPUT button on the right side of the RPTV or on the remote control.

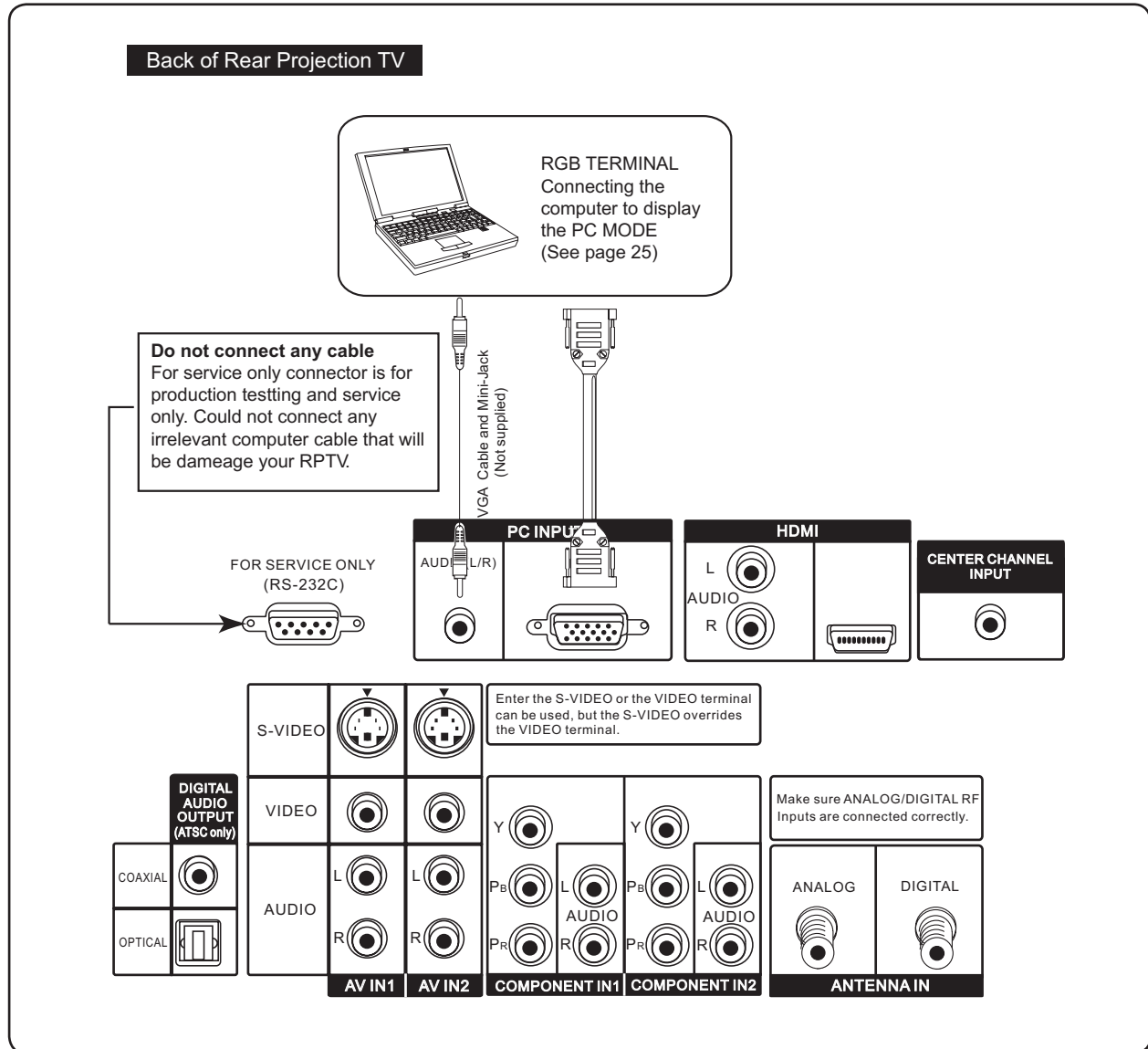

Note:

- a). The PC input on your RPTV supports High-bandwidth Digital Content Protection (HDCP). HDCP encrypts the transmission between the video source and the digital display for added security and protection.
- b). Refer to your computer User Manual for more information about the video output requirements of the product.

Computer Compatibility Chart

Computer

- | | |
|--|--|
| <ul style="list-style-type: none"> Multiple signal support Horizontal Frequency: 15-60 kHz, Vertical Frequency: 45-85 Hz, Pixel Clock: 12-80 MHz Sync signal: Compatible with TTL level | <ul style="list-style-type: none"> Compatible with sync on green signal XGA compatible in intelligent compression Intelligent Compression and Expansion System re sizing technology |
|--|--|

Input mode	Signal Format	STRETCH	NORMAL	ZOOM	DOT BY DOT	Factory Preset	
RGB	640*400	70Hz	O	O	O	O	NORMAL
		85Hz	O	O	O	O	
	720*400	70Hz	O	O	O	O	NORMAL
		85Hz	O	O	O	O	
	720*480	60Hz	O	O	O	O	NORMAL
	640*480	60Hz	O	O	O	O	NORMAL
		72Hz	O	O	O	O	
		75Hz	O	O	O	O	
		85Hz	O	O	O	O	
	800*600	56Hz	O	O	O	O	NORMAL
		60Hz	O	O	O	O	
		70Hz	O	O	O	O	
		72Hz	O	O	O	O	
		75Hz	O	O	O	O	
	1024*768	85Hz	O	O	O	O	NORMAL
		60Hz	O	O	O	O	
		70Hz	O	O	O	O	
	1280*720	75Hz	O	O	O	O	-
60Hz		X	X	X	O		
HDMI	640*480	60Hz	O	O	O	SIDE BAR	
No Signal			O	X	X	X	-

O : Possible







X : Not Possible

Note :

- This RPTV may not be able to display images from notebook computers in simultaneous (CRT/LCD) mode. Should this occur, turn off the LCD display on the notebook computer and output the display data in "CRT only" mode. Details on how to change display modes can be found in your notebook computer's operation manual.
- When signal not supported inputs, the screen will show "UNAVAILABLE" words ; But when the signal supported inputs and shows picture oblique, need to used "AUTOSYNC" function, if "AUTOSYNC" function picture still have oblique , must choose "H-POS/V-POS" to adjust it.
- When RGB source signal input and the timing is 640x400, 720x400, 640x480 and 720x480, you need to use the "setup" menu and adjust the "input signal" to get the better picture display.

Using the Center Channel Input

You can use the RPTV speakers as a center speaker when using 5.1ch surround sound system.

1. Turn off the power of the RPTV and audio equipment which supports 5.1ch surround sound system.
2. Connect the center speaker connector from the rear of your audio equipment to the CENTER CHANNEL INPUT on the rear of your RPTV.
3. Turn on the power of the RPTV and audio equipment.
4. Press MENU button on the remote control and the "MAIN MENU" will be displayed on the screen.
5. Press the  or  button to select "SETUP".
6. Press the OK button and the main menu will change to the "SETUP".
7. Press the  or  button to select "SPEAKERS".
8. Press the OK button.
9. Press the  or  button to select "CENTER-IN".

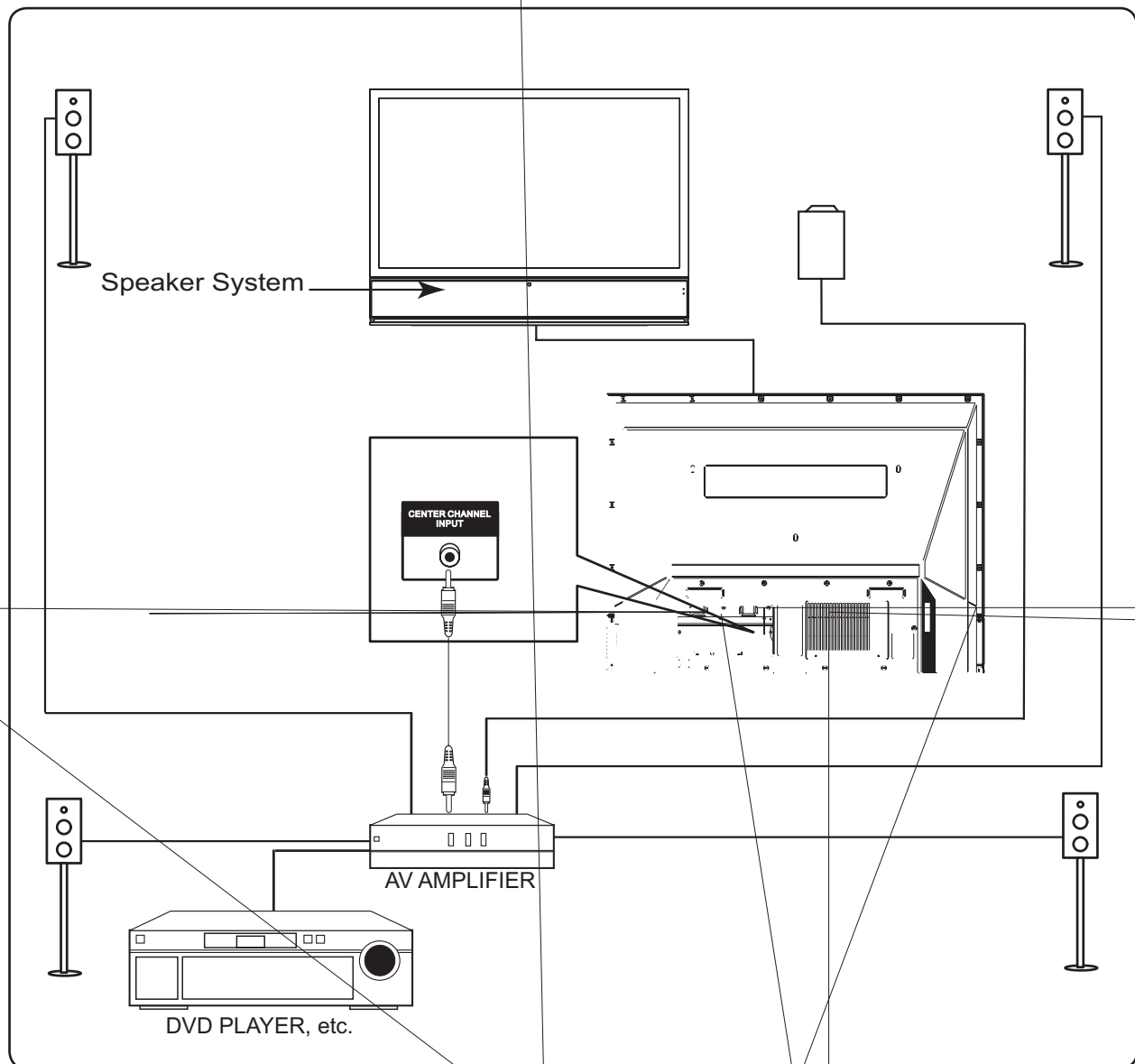

Note:
Refer to your audio equipment operation manual for details.



Side Control Section

POWER

Switch the TV "on" by pressing the POWER button once. To turn "off" the TV press the POWER button twice; the first time the button is pressed a message will appear on the screen warning that the second button press will power-off the TV.

INPUT

Repeated pressing of this button steps through the input sources in a circulatory sequence. Once you have selected all of the inputs you will return to the input you Started.

MENU

Pressing this button activates the On Screen Display (OSD) and shows the Main Menu. Pressing this button again exits (closes) the OSD.

ENTER

Pressing this button activates the OSD and shows the Main Menu.

CHANNEL ▲ / ▼

Step up (▲) or down (▼) through TV channels. While the OSD is active, these function as adjustment buttons to select OSD options.

VOLUME ► / ◀

Increase (►) or decrease (◀) the speaker volume. While the OSD is active, these function as adjustment buttons to adjust the OSD options.

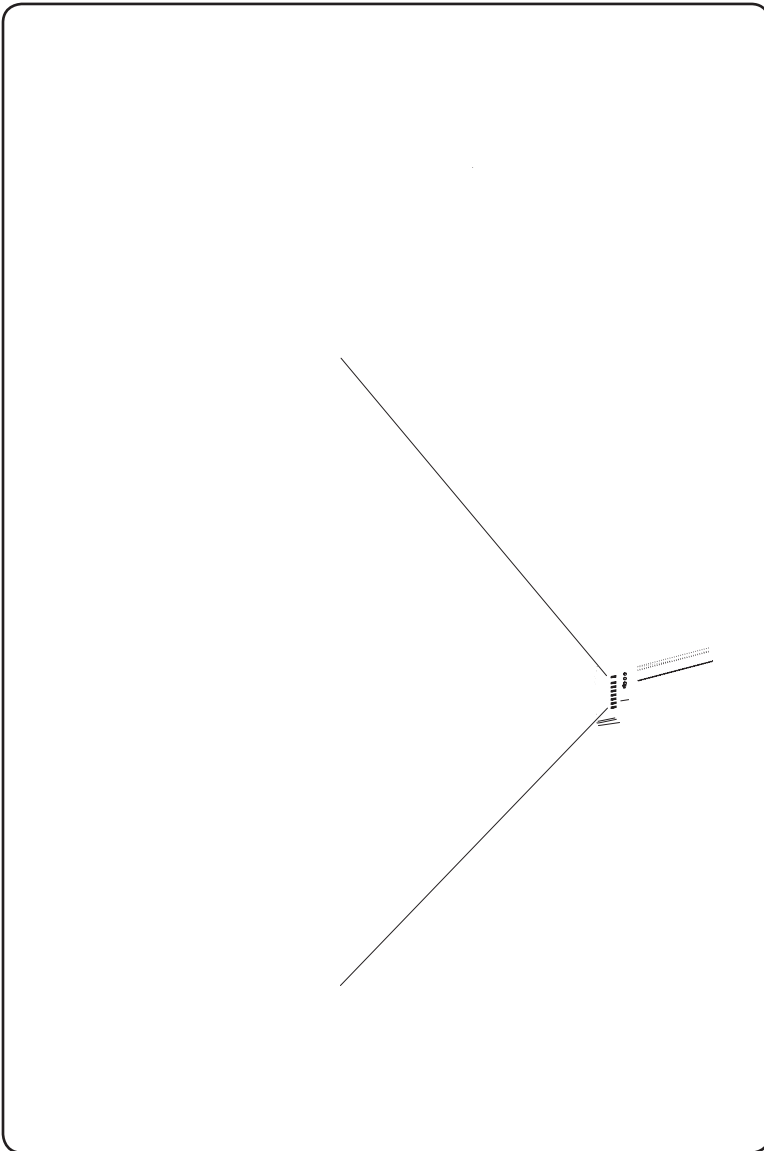

Status LED

Front Panel Indicator

READY LED

Displays the status of the ready of your RPTV

POWER LED

Lights green when powered on.

Remote Control Sensor

Point the Remote Control here as this is the window through which all of the remote signals pass to reach the remote sensor.

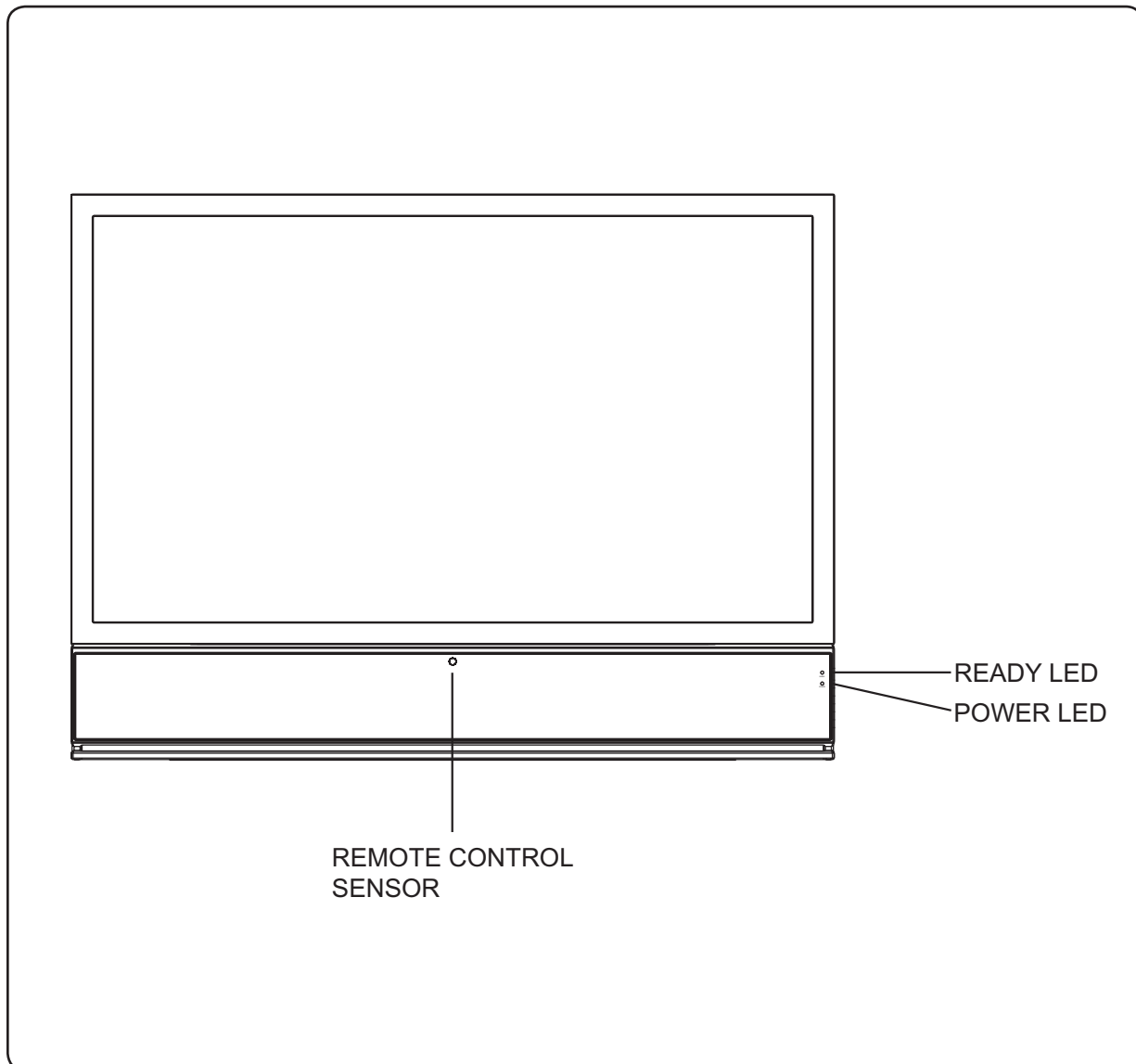

Remote Control Key Functions

The Remote Control is a comprehensive remote that can be used to control up to eight different components. For ease of use with minimal room lighting the Remote Control has a back light that illuminates all of the buttons when any button is pressed. The light will automatically go off a few seconds after the last button is pressed. The Remote Control button functions are explained below.

Remote LED
 Commanded to.

SETUP
 all.

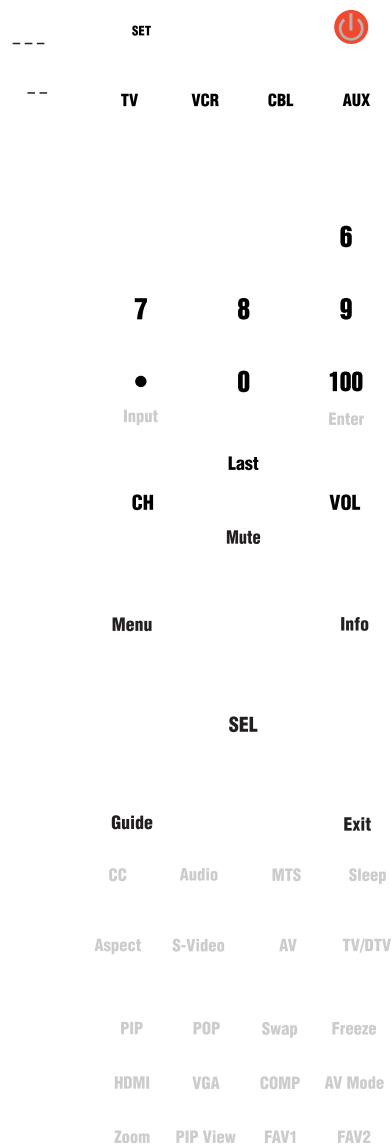

Remote Control Key Functions

VIEW MODE (WITH VIDEO)

STRETCH 16:9
SIDE BAR 4:3
S.STRETCH
ZOOM

VIEW MODE (WITH PC)

NORMAL
STRETCH 16:9
DOT BY DOT
ZOOM

EXIT

Exit the OSD, component or menus.

▲, ▼, ◀, ▶

Use these buttons to navigate the OSD menus.

SEL

Confirm an action on each menu item. and Select the main or sub (PIP) window to activate.

INFO

Display the current status of the video source, audio (and channel number when in TV mode), on the screen of your RPTV.

MENU

Activates the OSD Menu and Exit the OSD directly.



Remote Control Key Functions

PIP

Turn on or off the PIP (Picture In Picture) or POP (Picture Over Picture) mode.

PIP MODE

Select the style of the PIP mode.

AUDIO

Selects audio effect mode.

SWAP

Swap the main picture and sub picture when PIP mode is on.

Change the video source for the PIP or PC mode.

When chosen with one of the Component video inputs, the DVD or
DVD player to pause.

MTS

Selects stereo, sap and mono sound mode.

ZOOM

Switch the zoom size to magnify the picture.

CC

Turns closed captioning "on" and "off".

FREEZE

Freeze the picture. Note that you can only freeze the picture

to change and when the button is pressed again, the picture will not

mode, the picture will not freeze.

TV / DTV

Selects TV as the video source.

COMP

Alternately selects the video input COMP1 or COMP2.

HDMI

Selects HDMI as the video source.

VGA

Selects PC as the video source.

AV

Alternately selects the AV1, AV2 or AV3 inputs.

AV MODE

Reset AV Settings : STANDARD, MOVIE, GAME, USER-TV, DYNAMIC
(USER-DEFINED), DYNAMIC.

PIP VIEW

Switch view mode of sub window to 16:9 or 4:3

FAV1

Selects favorite cable/air channels for TV source.

FAV2

Selects favorite channels for DTV source.



Remote Control Operation

CAUTIONS :

- Do not drop or mishandle the remote control.
- Do not get the remote control wet. If the remote control gets wet, wipe it dry immediately.
- Avoid heat and humidity.
- When not using the remote control for a long period, remove the batteries.
- Do not take apart the batteries, heat them, or throw them into a fire.

Using the PIP Feature on the Remote Control

- Press the PIP button on the Remote Control to activate the PIP (Picture-In-Picture) mode. The PIP (sub screen) window will appear on the screen superimposed on the main screen. When you press this button again it will deactivate the PIP mode and the window will disappear.
- When the PIP window is visible, press the SWAP button and the main picture will switch to the PIP window and the PIP picture will replace it on the main screen, Press the SWAP button again and the pictures will switch back again.
- When the PIP window is visible, press the PIP MODE button and the RPTV will show the main and sub pictures as a split screen with the screen being divided equally between the two pictures but the content will be squeezed into the half width so that people will appear long and thin. Press the PIP MODE button again and will change to POP (Picture-Out-Picture) mode in which both pictures are equal again but this time the height is adjusted to match the width of each picture so that people are in the correct proportions. Press the PIP MODE button again and the format will change to PIP mode, which is where cycle of choices began.
- Press the INPUT (•) button one or more times to select the video input desired.

Note: The RGB MODE, HDMI MODE, DTV MODE cannot be used as a sub picture source.

Programming the Remote Control

The TV Selection button has already been programmed to work with your RPTV (program code 0X1314). You can program the other three Component buttons on the Remote Control to operate other components you have.

1. Turn "on" the component.
2. Choose a Component button you want to program, (for example CBL for a cable box or AUX for a DVD Player), on the Remote Control and press this button.
3. Press and hold the SETUP button until the LED on the Remote Control flashes twice.
4. Refer to the table on page 38 that lists components, and manufacturers and their relevant program codes to, using the number buttons, enter the programming code. if the code is accepted the led will flash twice after the last digit of the programming code is entered.
5. Point the Remote Control at the component and press the POWER button; the component should power off. If the component does not turn off and there is more than one programming code listed for the manufacturer and component, try the next code in the list for that manufacturer until you find the correct one.

Component Program Codes

Use the codes in Appendix page 38 to program the Remote Control to work with your existing audio and video Components.

Searching for Component Codes

If you cannot find the manufacturer in the component list or the program code does not work, you can use the remote control to search for the correct component code.

1. Turn "on" the component.
2. Press the matching COMP button on the Remote Control.
3. Press and hold the SETUP button until the LED flashes twice.
4. Press 9 9 1. After this number sequence has been entered the LED will flash twice.
5. Point the Remote Control at the component and alternate between pressing the POWER button and the COMP button on the remote control until the turns off. If the component still does not respond, clear the COMP button as described in the next three-step process, then repeat the search procedure.

Remote Control Operation

1. Make sure that the component is turned on.
2. Press and hold the SETUP button on the Remote Control until the LED flashes twice.
3. Press 9 9 2, then press the component button on the Remote Control twice.

Checking the Component Codes

If you have set up the Remote Control using the Searching for Component Code procedure, you may need to find out which four-digit code is operating your equipment.

To find out which code is operating your TV :

1. Press the TV button once.
2. Press and hold the SETUP button until the LED blinks twice, then release the SETUP button.
3. Enter 9 9 0. After this number sequence has been entered the LED will flash twice.
4. To view the code for the first digit, press 1 once. Wait 3 seconds, count the LED blinks (i.e., 3 blinks =3) and write down the number.

Note: If a code digit is "0", the LED will not blink.

5. Repeat step # 4 three more times for the remaining digits. Use 2 for the second digit. Use 3 for the third digit, and 4 for the fourth digit.
6. To check the codes for your other components, repeat steps 1 through 5, but substitute the appropriate key (i.e., AUX, CBL, VCR, SAT, CD, AMP, or DVD) for the component you are checking. As before, write down each four-digit code.

Changing Volume Lock

The Remote Control is set to control the volume through your TV while in cable (CBL), DVD, satellite (SAT) and VCR component modes. Use the volume lock if you want to control the volume for all components through a specific component.

Example:

You want to control volume for all components through your tuner.

1. Press and hold the SETUP button until the LED flashes twice.
2. Press 9 9 3. After this number sequence has been entered the LED will flash twice.
3. Press the COMP button once that you want to control the volume (TNR). The LED flashes twice. Volume will now be controlled through the tuner for all components.

Teaching the Remote Control New Functions

The remote control can learn up to 40 additional functions from the component's original remote control.

Example:

Your DVD player remote control has a scan function that you may use frequently. There is not a scan button on the remote control. you can assign a button and use the DVD remote to teach the remote control the scan function.

1. Press and hold the SETUP button on the Remote Control until the LED flashes twice.
2. Press 9 7 5. After this number sequence has been entered the LED will flash twice.
3. Press the COMP button that you want to teach (DVD) once.
4. Press the button to which you want to assign the new function. The LED flashes quickly while it is waiting to receive the signal from the teaching remote.
5. Hold the teaching remote control approximately 1-inch (25mm) from the Remote Control making sure that the infrared ports are lined up, on the teaching remote press the button that you want the Remote Control to learn. The LED flashes twice.
6. Press the SETUP button to exit the learning mode.

Menu Functions

PICTURE ADJUST

You can adjust the settings of the PICTURE(CONTRAST, BRIGHTNESS, COLOR, TINT, SHARPNESS, COLOR TEMP, NOISE REDUCTION, VIEW FORMAT.)

AUDIO ADJUST

You can adjust the AUDIO settings (TREBLE, BASS, BALANCE, EFFECT) for the internal SPEAKERS.

PIP SETUP

You can adjust the PICTURE IN PICTURE function.

SETUP

You can set LANGUAGE, SPEAKERS, CAPTION STYLE , DTV SETUP, HDMI and input source settings.

PARENTAL CONTROLS

PARENT CONTROL

- ACCESS CODE : You must set the password (ACCESS CODE) when using parental control functions.
- Note : This function allows you to restrict viewing of TV programs, to control TV usage based on FCC data and to prevent your children from watching content that may be deemed harmful.

SPECIAL FEATURE

- You can adjust the OSD position of horizontal and vertical and setup Sleep timer.

SYSTEM INFO.

- Displays current system information.
- MODEL NUMBER, MAIN INPUT, WIDE FORMAT, PIP INPUT, LAMP TIME and SOFTWARE VERSION.

Getting Started

Turning your RPTV "on"

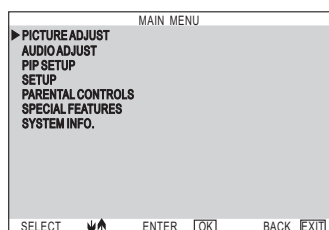

1. Plug the power cord into an AC wall socket. The POWER LED on the front panel will light red.
2. Press the POWER button on the side panel "on" the RPTV or the POWER button on the Remote Control to power.
The READY LED will start flashing while the lamp turned on. Once the lamp is warm enough the indicator will stay lit green and the picture will begin to display on the Screen.
3. When the RPTV is "on", press the POWER button on the side panel or the POWER button on the Remote Control. A message will display on the screen warning you that you will power "off" the RPTV. Once the RPTV has been turned "off" you cannot turn it "on" again until at least 30 seconds later as a protection feature for the lamp. The lamp could be damaged if it is turned "on" too soon after being "off", The READY LED will start flashing until the protection time has passed and then the READY LED will turn off and the will be in the standby mode.

Using the On Screen Display (OSD)

Menu Operations

The OSD consists of a Main Menu of items and each of these items has a Sub Menu associated with it that the OSD will switch to when the item is selected.

1. Press the MENU button on right side of the RPTV or remote control : The Main Menu will be displayed on the screen, as shown below.
2. Press the ADJUST ▲ (CH+) or ADJUST ▼ (CH-) button on right side of the RPTV or the ▲ , ▼ button on the remote control to highlight the feature you wish to select.
3. Press the ENTER button on right side of the RPTV or SEL button on the remote control to select the feature. the Main Menu will now change to the Sub Menu of the feature selected.
4. Press the ADJUST ▲ (CH+) or ADJUST ▼ (CH-) button on right side of the RPTV or the ▲ , ▼ button on the remote control will highlight the option you wish to adjust and press the ENTER button on right side of the RPTV or SEL button on the remote control.
5. Adjust the level or change the setting of the selected option by pressing. ADJUST ◀ (VOL+) or ADJUST ▶ (VOL-) button on the right side of the RPTV or the ◀ , ▶ buttons on remote control.
6. Repeat steps 4 and 5 to adjust additional options.
7. Once the adjustment is complete, press the "EXIT" button to return to the main menu or press the "MENU" button twice on right side of the RPTV or on the remote control MENU button to exit the OSD.

OSD Menus and Options

The OSD menus and options are used to adjust various settings on your RPTV.

Picture Adjust Menu

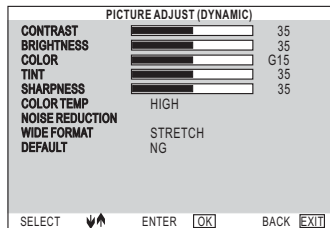

PICTURE ADJUST (DYNAMIC) - TV / DTV Modes

CONTRAST - Adjusts the contrast of the picture.

BRIGHTNESS - Adjusts the brightness of the picture. Users may need to adjust the brightness after the RPTV warms up.

COLOR - Adjusts the color saturation making colors more intense.

TINT - Adjusts the color of flesh tones.

SHARPNESS - Adjust the amount of detail enhancement.

COLOR TEMP - Adjust the color temperature level.

(HIGH, LOW, MID LOW, MID HIGH)

NOISE REDUCTION - Turns noise reduction "on" and "off", This function can not be used in DTV mode.

WIDE FORMAT - Adjusts the screen width to STRETCH, SIDE BAR, S STRETCH, ZOOM, for viewing.

DEFAULT - Return to default value.

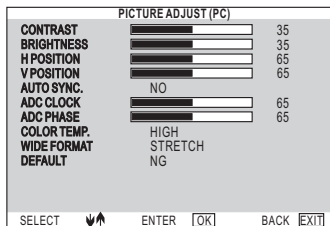

PICTURE ADJUST (PC) - PC Modes (RGB Input)

CONTRAST - Adjusts the contrast of the picture.

BRIGHTNESS - Adjusts the brightness of the picture. Users may need to readjust the brightness after the RPTV warms up.

H POSITION - Adjust the horizontal screen position.

V POSITION - Adjust the vertical screen position.

AUTO SYNC. - Automatically adjust to the best setting.

ADC CLOCK - Removes any vertical distortion and clears or sharpens the displayed characters.

ADC PHASE - Removes any horizontal distortion and clears or sharpens the displayed characters.

COLOR TEMP. - Adjust the color temperature level.

DEFAULT - Return to default value.

Using the On Screen Display (OSD)

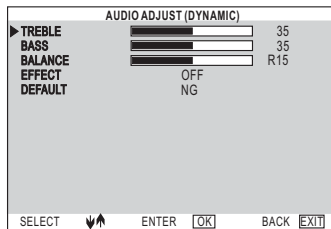

AUDIO ADJUST

TREBLE - Adjusts the treble.

BASS - Adjusts the bass.

BALANCE - Adjusts the balance level for two speakers.

EFFECT - Adds simulated audio effects. Switch for OFF, BBE, SURROUND, SIM.STEREO.

DEFAULT - Return to default value.

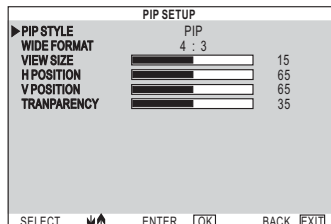

PIP SETUP

PIP STYLE - Turns PIP mode on or off, or choose four of the following pre-set modes: PIP, SPLIT, POP, OFF.

PIP - Start the Picture in Picture and option sub function.

SPLIT - The screen is divided in half. The left side is the main picture and the right side is the sub-picture.

POP - The screen is in the 16:9 mode and divided in half, The left side is the main picture and the right side is the sub-picture.

OFF - Turns "OFF" PIP function.

WIDE FORMAT - Changes the sub-picture size. Choose between 4:3 and 16:9.

VIEW SIZE - Changes the size of the sub-picture.

H POSITION - Moves the sub-picture left or right.

V POSITION - Moves the sub-picture up or down.

TRANSPARENCY - Adjusts the sub-picture transparency.

Note:

The BBE audio effect reproduces the original live performance of the music that is amplified through loudspeakers for a fuller and more "life-like" sound stage.

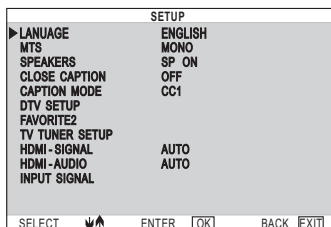

SETUP

LANGUAGE - Allows you to select for ENGLISH, SPANISH and FRENCH from the OSD.

MTS - Changes the sound output for TV programs. Switch for STEREO, SAP or MONO.

SPEAKERS - You can use your RPTV as a center channel Speaker "ON" or "OFF".

SP ON - Audio from built-in speakers.

CENTER-IN - You can use your RPTV as a center channel speaker but cannot adjust volume or mute.

SP OFF - You can select SPEAKER "off" to mute the Audio.

CLOSE CAPTION - Turns closed captioning "on" and "off". (TV / DTV)

CAPTION MODE - Sets the display mode for closed captioning. (For analog channels only)

CLOSED CAPTION (DTV) - Sets the display mode and style for closed captioning.

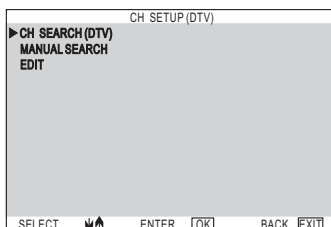
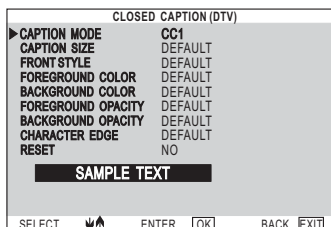

DTV SETUP - For DTV source (DTV) use only.

CH SETUP (DTV)

CH SEARCH (DTV) - Automatically searches for DTV channels.

MANUAL SEARCH - Manually searches for DTV channels parenthesis.

EDIT - Edit channel for parenthesis.

FAVORITE 2 (DTV) - When source is DTV input, use SEL button and ▲ or ▼ to setup the favorite (DTV) channels. 10 Favorite channels are available.

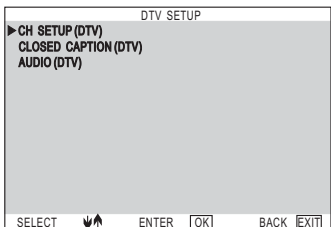

Using the On Screen Display (OSD)

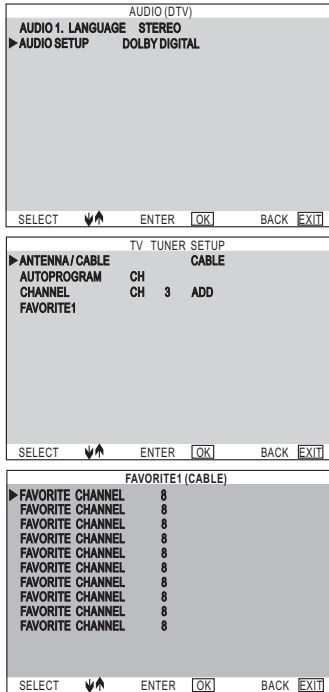

AUDIO (DTV)

AUDIO 1. LANGUAGE STEREO - You can choose any language or any sound effects on this option.

AUDIO SETUP - You can setup your Digital Audio Output. Sound effects to DOLBY DIGITAL or PCM.

FAVORITE 1(CABLE) - For DTV favorite channel memory and setup. User can change to the favorite channel immediately. By Fv1 button 10 Favorite Channels are available.

TV TUNER SETUP - Sets AIR/CABLE antenna option first and you can select channel search by auto or manul.

Also, you can save at most 10 favorite channels.

HDMI SIGNAL - Use for HDMI input for different source input.

HDMI AUDIO - Use for DVI cable without audio function and connect additional audio cable.

INPUT SIGNAL - Use for RGB source timing selection.

- When RGB source signal input and the timing is 640X400, 720X400, 640X480 and 720X480, you need to switch to compatible option.
- When starting in the PIP mode, the DTV function is not available.

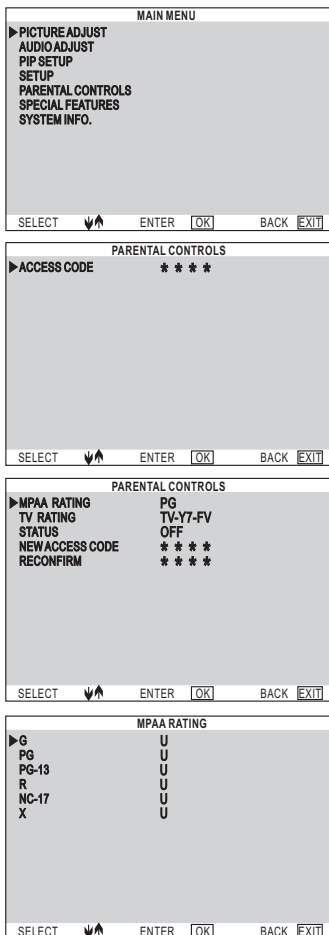

PARENTAL CONTROLS

The Parental Controls feature prevents viewers from watching programs that are not age-appropriate, such as programs containing violence or adult language.

1. Press the TV button on the remote control.
2. Press the MENU button on the Remote Control and the Main Menu will be displayed on the screen, as shown below.
3. Press the ▲ , ▼ button to select "PARENTAL CONTROLS".
4. Press the SEL button and the ACCESS CODE.
5. Press the SEL button to change password.
6. Enter your idea number. If you have not set a new number, use the number button pad to enter 0000. For more information about setting a password, see "Setting a password" on page 29.
7. Press the SEL button to open MPAA Rating.
8. Press the ▲ , ▼ buttons to select which rating you want to block or unblock. You can select from the following. ratings:
 - G (General audience)
 - PG (Parental guidance suggested)
 - PG-13 (Recommended for children 13 years of age and older)
 - R (mature audience)
 - NC-17 (no one under 17 years of age)
 - X (no one under 17 years of age)
9. Press the SEL button to select U (unblocked) or B (blocked).
10. Press the EXIT button to return to "PARENTAL CONTROLS" menu.
11. Press the ▲ or ▼ button to select "TV RATING" menu.

Using the On Screen Display (OSD)

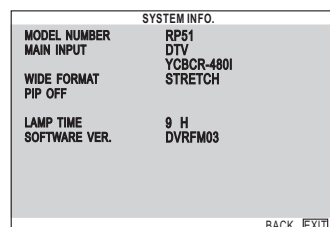
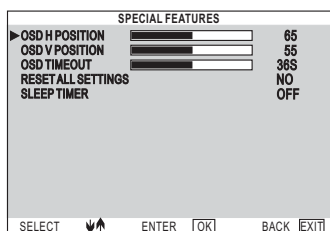
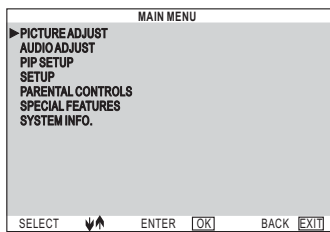
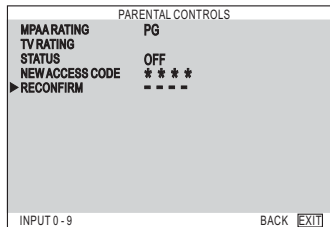
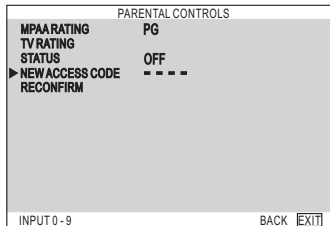
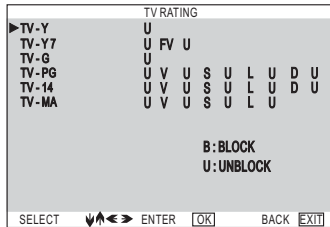
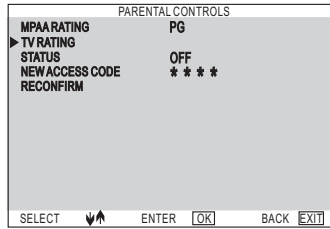

12. Press the SEL button to open the "TV RATING" Menu.
13. Press the ▲, ▼, ◀, ▶ buttons to select which rating you want to block or unblock. You can select from the following ratings :
 - TV-Y (all children)
 - TV-Y7 (older children)
 - TV-G (general audience)
 - TV-PG (guidance suggested)
 - TV-14 (strongly cautioned)
 - TV-MA (mature audience)
 You can customize these ratings for:
 - FV (fantasy violence)
 - V (violence)
 - L (adult language)
 - S (sexual situations)
 - D (sexual dialog)
14. Press the SEL button to select U (unblocked) or B (blocked)
15. Press the EXIT button to return to "PARENTAL CONTROLS" menu.
16. Press the ▲ or ▼ and SEL buttons to select "STATUS".
17. Press ◀, ▶ button to enable (ON) or disable (OFF) this function.
18. Press SEL button to return.
19. Press the ▲ or ▼ buttons to select "NEW ACCESS CODE".
20. Press the SEL button to open "NEW ACCESS CODE" option.
21. Enter your idea number to setup your password.
22. Enter the number again to "RECONFIRM" your password.
23. Press the EXIT button repeatedly to exit the OSD.

SPECIAL FEATURES

- OSD H POSITION** - Adjusts the horizontal position of the OSD within the display image.
- OSD V POSITION** - Adjusts the vertical position of the OSD within the display image.
- OSD TIMEOUT** - Adjusts the time period of OSD Menu which appears on the screen.
- RESET ALL SETTINGS** - Resets all settings, except the parental controls, to the Factory defaults.
- SLEEP TIMER** - Turns sleep timer on and off and selects the number of minutes the RPTV waits before it automatically turns off. You can specify 30, 60, 90, or 120 minutes.

SYSTEM INFO.

Display some information about the display, may also be displayed by pressing the hotkey INFO on the remote control.

- MODEL NUMBER** - Show the display's model number.
- MAIN INPUT** - Display the input signal of current main picture.
- WIDE FORMAT (MAIN)** - Display main picture's aspect ratio.
- PIP INPUT** - Display the input signal of current main picture.
- LAMP TIME** - Display the time the lamp has consumed.
- SOFTWARE VERSION** - Display the display's software version.

Setting a Password for Parental control

You control access to the Parental Control features with a password. The default password is 0000. You can change the password to any four-digit number.

To change the password:

1. Press the TV button on the remote control.
2. Press the MENU button on the Remote Control and the Main Menu will be displayed on the screen, Please refer to Page 27.
3. Press the ▲ or ▼ button to select "PARENTAL CONTROLS".
4. Press the SEL button and the Main Menu will now change to the "PARENTAL CONTROLS" sub menu.
5. Press the SEL button again to select ACCESS CODE.
6. Enter your password. If you have not set a password, use the number button pad to enter 0000.
7. Press the ▲ or ▼ button to select NEW ACCESS CODE.
8. Press the SEL button and enter new secret number
9. Enter the new password again when prompted RECONFIRM.
10. Press the EXIT button repeatedly to exit the OSD.

To reset your password:

1. Press the TV component button.
 2. Press the MUTE button on the Remote Control.
 3. Press the INFO. Button then press the ▲, ▼, ◀, ▶ and SEL Buttons within 4 seconds. SECRET NO. RESET message appears. Your password has been reset to 0000.
- The new password setting please refer to above procedure of to change the password.

Using Wide Modes: View Mode

Wide screen mode allow you to change the aspect ratio on screen. You can press the Aspect button on the REMOTE CONTROL to change the aspect ratio on screen.

Press Aspect

1. The View mode message displays.
2. The menu lists the Aspect options selectable for the type of video signal currently received.
3. Press Aspect button while the Aspect menu is still on the screen.
4. You can sequentially select an Aspect that has its own aspect ratio.

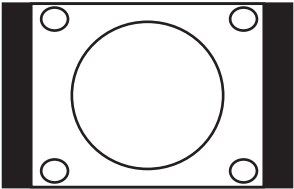
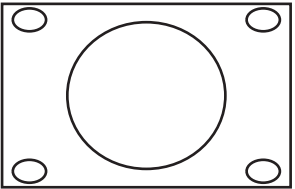
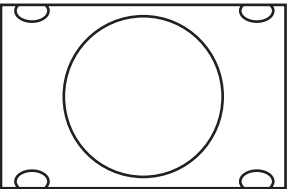
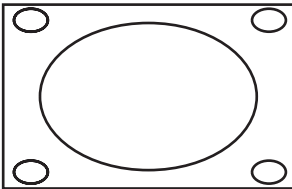

View mode for 4:3 TV / AV :

Side Bar	S.Stretch	Zoom	Stretch
			
Suitable for viewing conventional 4:3 programs in their normal format.	Suitable for stretching 4:3 programs to fill the screen. (SMART-STRETCH)	Suitable for viewing wide-screen 2.35:1 nongraphic DVD in full screen.	This mode is useful for 1.78:1 DVDs. When viewing 1.85:1 DVD, stretch mode will still show very thin black bands at the top and bottom of the screen.

View mode for PC input mode:

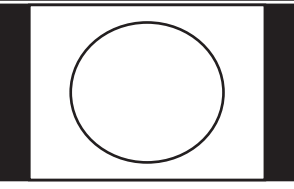
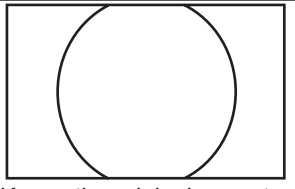
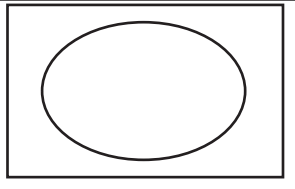
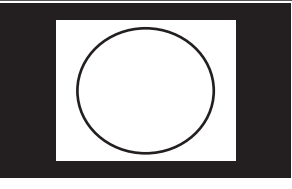
Normal	Zoom	Stretch	Dot by Dot
			
Keeps the original aspect ratio in a full screen display.	Keeps the original aspect ratio in a full screen display. The top and bottom of the image is slightly cropped.	An image fully fills the screen.	Detects the resolution of the signal and displays an image with the same number of pixels on the screen.

Note:

- Aspect is not available when using the POP, SPLIT functions.
- When STRETCH mode is available, You can use 720p and 1080i signal input through HDMI or component terminal.



Replacing the Lamp

- When the "Lamp Replacement" warning appears on screen it is time to replace the lamp. (Lamp LED warning light will appear red).
- Press "OK" to make the warning disappear.
- After replacing the lamp please reset the lamp timer.
- Make sure to reset the lamp timer only when replacing the lamp. If you reset the lamp timer and continue to use the same lamp this may cause the lamp to explode.
- To Reset Lamp Timer please follow these steps:
 - 1.) Press "MENU" and "VOL ADJ ►" buttons on the right hand side of the RPTV for three (3) seconds while the RPTV is on.
 - 2.) "Lamp Timer Reset" should appear on screen.
 - 3.) Press "OK" to reset the lamp timer.

Status LEDs

There are two status LEDs on the front of the RPTV.

State	POWER LED	READY LED	Description
AC off	Not lit	Not lit	AC power is not connected
Standby mode	Red	Not lit	AC power is connected and the RPTV is in standby mode.
Warm-up	Green	Flashing Red	AC power is connected and the power button has just been turned on.
Operation mode	Green	Not lit	AC power is connected, the power button has been pressed and the lamp has been warmed up.
Cool down mode	Red	Flashing Red	AC power is connected and the power button has just been turned off.
Lamp caution	Green	Red	Lamp life has been ended. Please Replace the lamp.

ERROR MESSAGE

Error Code	POWER LED	READY LED	Description
21	Flashes green twice, times then Red once.	Not lit	One of the cooling fans has failed.
32	Flashes green three times, then Red twice.	Flashing Red	Indicates lamp trouble or failure. The RPTV will automatically shut down and restart itself.
52	Flashes green five times, then Red twice.	Not lit	Indicates hardware error. Power off the RPTV, wait one minute, and then restart the RPTV.

Troubleshooting Guide

Use the following information to solve common problems.

Symptom	Possible Solutions
No picture	<p>Make sure that the power cord is plugged into a grounded electrical outlet.</p> <p>Make sure that the Power button is turned on.</p> <p>Look in the left air vent to see if the lamp is on.</p> <p>Make sure that the selected input source is connected to a working component. If the other component is not working, correct the problem with the other component.</p> <p>If the RPTV is connected to a computer in RGB mode check to see if the computer has gone to sleep and if so, press any key on the keyboard to "wake up" the computer.</p>
The picture is distorted or there is an unusual sound.	<p>Check if there is interference from other electrical appliance, car, motorcycle or fluorescent light. Try moving the RPTV or offending appliance to another location.</p>
The color is abnormal.	<p>Check that the input source cable is connected securely and correctly to the back of the RPTV.</p>
There are abnormal patterns on the Picture.	<p>Check that the input source cable is connected securely and correctly to the back of the RPTV.</p> <p>Make sure that the video input source is within the range of the RPTV. Compare the video input source's specifications with the RPTV specifications.</p>
The picture does not fill the whole screen.	<p>If the TV, AV1, AV2 or component is being used with normal 480i input, Aspect button on the remote control to scroll through various screen modes. (page 30)</p>
There is a picture but no sound.	<p>Make sure that the volume is not turned down.</p> <p>Make sure that the sound is not Muted.</p> <p>Make sure that the internal speakers are not turned off.</p> <p>Make sure that the audio input source cables are connected securely and correctly.</p>
The RPTV has pixels that are always dark.	<p>The RPTV is manufactured using an extremely high level of precision technology. However, sometimes pixels may not display. Pixel defect within the industry specifications are inherent to this type of product and do not constitute a defective product.</p>
There is video noise or artifact on the picture.	<p>When the RPTVs digital capabilities exceed a digital broadcast signal, the signal is up-converted (increased) to match the RPTVs display capabilities. This process may cause video noise or artifact on screen.</p>

Symptom	Possible Solutions
Screen brightness is diminished.	Video display components experience degradation of brightness over the life of the component. Normal brightness degradation is not covered by the warranty. <ul style="list-style-type: none"> ● Check brightness setting ● Check lamp timer ● Replace lamp
The LED on the Remote Control does not blink when a button is pressed.	Replace the batteries with two "AA" new alkaline batteries. See "Inserting batteries" on page 4.
The Remote Control LED blinks when a component selection button is pressed, but the component does not respond.	You make sure that there are less than 15 feet (4.5 meters) from the infrared remote sensors on the component. Nothing is blocking the infrared remote sensors on the remote control or the component. You have chosen the correct component selection button. The remote is programmed for that component. See "REMOTE CONTROL OPERATION" on page 22. Check that the component's original remote control will operate the component.
The Remote Control does not control home entertainment components or commands are not working properly.	Try all listed codes for the component brands being set up. (Page 38) Make sure they can be operated with an infrared remote Control.
TV/VCR Combo does not respond to the Remote Control properly.	Use the VCR codes for your brand. Some combo units may require both a TV code and a VCR code for full Operation.(Page 38)
No volume on a 2nd TV.	Follow instructions for "Changing Volume Lock", see page 23.
Changing channels does not work properly with the Universal Remote Control.	If original remote control required change channels does not work properly, press ENTER on the universal remote after entering the channel number.
The Remote Control does not work.	Check the Remote Control batteries and replace them with new AA batteries if necessary. Make sure that nothing is blocking the infrared remote sensors on the remote control or the RPTV.

Specifications

Optical System		Texas Instruments HD4 DLP™ DMD
Screen size		51 inches Diagonally
Channel Coverage	VHF	2-13
	UHF	14-69
	DTV	1-999
	CATV	2-125
	Lamp	UHP AC 120W
Television System		NTSC ATSC
Input & Output		<u>Right Side Input :</u> Audio/Video in: (S-Video, Video, Audio-L/R) x 1 <u>Rear Side Inputs/Outputs :</u> Antenna in: Analog x 1, Digital x 1 Component in: (Y, PB, PR, Audio-L/R) x 2 Audio/Video in: (S-Video, Video, Audio-L/R) x 2 Digital Audio Output (for ATSC only): Coaxial x 1, Optical x 1 Special Audio Input: Center Channel Input x 1 HDMI Input: (HDMI, Audio-L/R) x 1 PC Input: (RGB, Audio-stereo) x 1 Service Control Input: RS232 x 1
HDMI		The HDMI (High Definition Multi-Media Interface) for connection with HDMI enabled SET TOP BOXES. HDMI enables the RPTV to support signals of 480p, 720p and 1080i. Users can also purchase a HDMI to DVI cable to connect with AV equipment that has a DVI connection.
Speakers		8 Ohm 15w x 2 : 30W total
Power Source		AC 120 V, 60Hz
Power Consumption		250W (1W standby with AC 120V)
Dimensions (WxDxH)		47.47" [1205.80mm(W)] x 16.53" [419.80mm(D)] x 35.23" [894.80mm(H)]
Weight		94.8 Lbs (43 Kg)
Supplied Accessories	Remote Control	Multi-function Remote Control
	AA Batteries	x2 for Remote Control
	User Guide	x1
	Warranty card	x1
Optional Accessories		UHP-Replacement Lamp



- As part of policy of continuous improvement, Customer reserves the right to make design and specification changes for product improvement without prior notice. The performance specification figures indicated are nominal values. of production units. There may be some deviations from these values in individual units.

Dimension

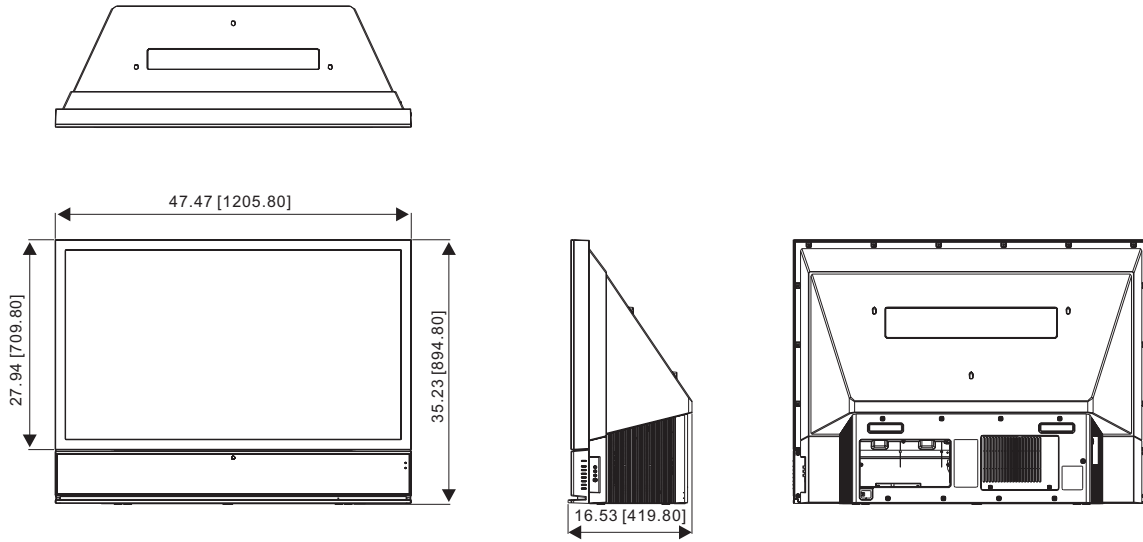
UNIT : inch/[mm]

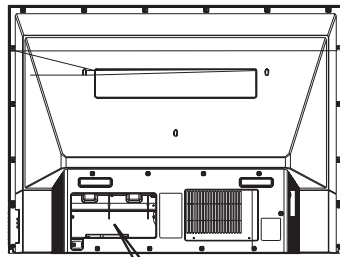

Input / Output Terminals and Connectable Equipment

RGB TERMINAL
Connecting the computer to display the PC MODE
(See page 13)



HDMI TERMINAL
Connecting video equipment with DVI and HDMI input terminal (DVD player, STB etc.).
(See page 9)

CENTER CHANNEL INPUT
(See page 15)

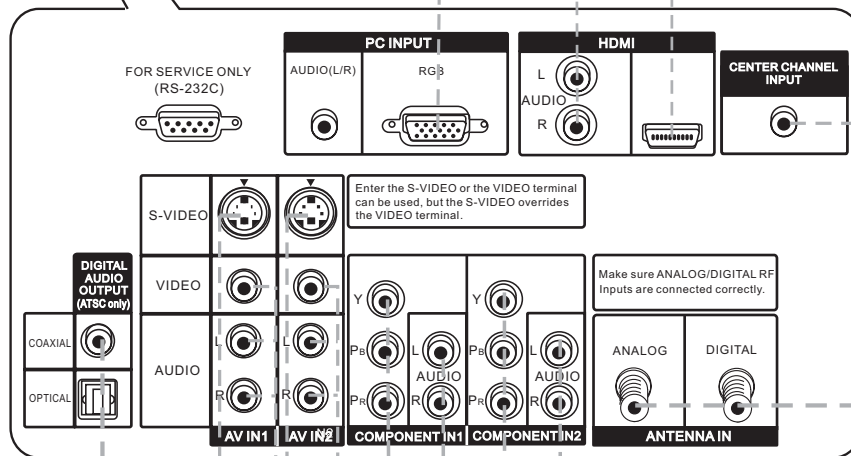
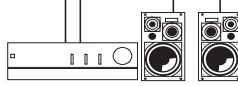

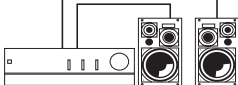
DTV CHANNEL AUDIO OUTPUT
(SEE page 16)

AV IN1, AV IN2 TERMINAL
Connecting video equipment with AV output terminal (DVD player, etc.).
(See page 8)

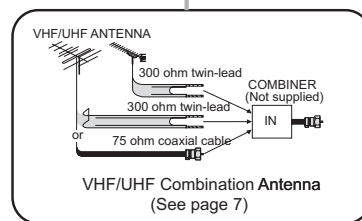
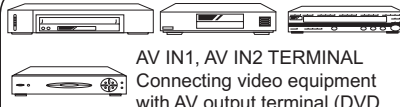

COMPONENT IN1, IN2 TERMINAL
Connecting video equipment with Component output terminal (DVD player, STB etc.).
(See page 11)

APPENDIX:

Remote Control IR Set Up Codes

TELEVISION codes

Manufacturer	Program Code
Addison	10092
Admiral	10093, 10463
Advent	10761, 10842
Aiko	10092
Aiwa	11914
Akai	10812, 10702, 10030, 10672, 11903
Albatron	10700, 10843
America Action	10180
Anam	10250, 10180, 10700
Anam National	10250, 10650
Anhua	10051
AOC	10451, 10093, 10180, 10060, 10030, 10178, 10092
Apex Digital	10748, 10765, 10879, 10767, 11943
Audiovox	10451, 10180, 10875, 10092, 10623
Baile	10661
Beijing	10812, 10661
Bell & Howell	10154
BenQ	11032
Bradford	10180
Broksonic	10236, 10463, 11911, 11938, 11905, 11935, 11929
Cailing	10748
Candle	10030
Carnivale	10030
Carver	10054
Celebrity	10000
Celera	10765
Changcheng	10051, 10661
Changhong	10156, 10765, 11156, 10767
Ching Tai	10092
Chun Yun	10000, 10180, 10700, 10092, 10843
Chung Hsin	10180, 10053
Cinema	10672
Citizen	10060, 10030, 11928, 10092
Clarion	10180
Commercial Solutions	11447, 10047
Conrowa	10156, 10145, 11156
Contec	10180
Craig	10180
Crosley	10054
Crown	10180
Curtis Mathes	10047, 10054, 10154, 10451, 10093, 10060, 10702, 10030, 10145, 10166
CXC	10180
Daewoo	10154, 10451, 10180, 10030, 10178, 10672, 11928, 10092, 10661, 11909, 10623, 10700
Dayu	10661
Dell	11080
Denon	10145
Dumont	10017
Durabrand	10463, 10180, 10178, 10171, 11034
Electroband	10000
Emerson	10154, 10236, 10463, 10180, 10178, 10171, 11944, 11909, 11929, 11905, 11928, 10623, 11911
Envision	10030
Ether	10030
Firstar	10236
Fisher	10154
Fortress	10093

TELEVISION codes

Manufacturer	Program Code
Fujitsu	10809, 10853
Funai	10180, 10171, 11904
Furi	10145
Futuretech	10180
Gateway	11756, 11755
GE	11447, 10047, 11454, 10051, 10451, 10180, 10030, 10178, 11917, 10092, 11907, 11922
Gibraltar	10017, 10030
GoldStar	10154, 10030, 10178, 11926
Grunpy	10180
Haier	11034
Hallmark	10178
Hankook	10180, 10030, 10178
Harley Davidson	11904
Harman/Kardon	10054
Harvard	10180
Havermy	10093
Helios	10865
Hello Kitty	10451
Hisense	10156, 10748, 10145, 11156, 10156, 10030, 10178, 11145, 10145, 10092, 11904, 11156
Hongmei	10093
Huafa	10145
Huari	10145
Huodateji	10051
Imperial Crown	10661
Infinity	10054
Inteq	10017
JBL	10054
JCB	10000
Jean	10156, 10051, 10236, 10092
Jensen	10761
Jiahua	10051
Jinfeng	10051
Jinxing	10054, 10156, 10145
JVC	10053, 11923, 11253
Kangli	10661
KEC	10180
Kenwood	10030
KLH	10765, 10767
Kolin	10180, 10150, 10053
KTV	10180, 10030
Kunlun	10051, 10661
LG	10060, 10030, 10178, 10856, 10700, 10025
Lloyd's	11904
LXI	10047, 10054, 10154, 10156, 10178
Magnasonic	11928, 11913
Magnavox	11454, 10054, 10030, 10706, 11931, 11254, 11913, 11904, 11944
Magnin	11907
Marantz	10054, 10030, 10704
Matsushita	10250, 10650
Maxent	11755
Megapower	10700
Megatron	10178, 10145
Memorex	10154, 10463, 10150, 10178, 11911, 11926, 11924, 11920, 11927
MGA	10150, 10030, 10178, 11907
Midland	10047, 10017, 10051

TELEVISION codes

Manufacturer	Program Code
Mitsubishi	10154, 10250, 10093, 10236, 10180, 11250, 10150, 10030, 10178, 11917, 10836
Monivision	10843, 10700
Motorola	10093
MTC	10060, 10030
Mudan	10051
Multitech	10180
NAD	10156, 10178, 10866
National	10051
NEC	10154, 10156, 10051, 10053, 10030, 10178, 11704
Newave	10093, 10178, 10092
Nikko	10030, 10178, 10092
Norcent	10748, 10824
NTC	10092
Onwa	10180
Optimus	10154, 10250, 10166, 10650, 11927, 11924, 11913
Optonica	10093
Orion	10236, 10463, 11929, 11911, 11905
Panasonic	10054, 10250, 10051, 10650, 11941, 11927, 11924
Panda	10051, 10706
Penney	10047, 10156, 10051, 10060, 10030, 10178, 11926, 11907
Philco	10054, 10180, 10030, 10178
Philips	11454, 10054, 10000, 10051, 10030, 10178, 10092, 10690
Pilot	10030
Pioneer	10166, 10866, 10679
Portland	10092
Prima	10761
Princeton	10700
Prism	10051
Proscan	11447, 10047, 11922
Proton	10030, 10178
Pulsar	10017
Qingdao	10051
Quasar	10250, 10051, 11924, 10650
RadioShack	10047, 10154, 10180, 10030, 10178, 11920, 11904
RCA	11447, 10047, 11454, 10000, 10030, 10178, 11547, 11922, 11917, 10092, 11907, 11948, 10090, 10679
Realistic	10154, 10180, 10030, 10178
Rowa	10748
Runco	10017, 10030
Sampo	10154, 10093, 10030, 10178, 10171, 10700, 10650, 11755, 10092
Samsung	10154, 10156, 10060, 10812, 10702, 10030, 10178, 11060, 10814, 10092, 11903, 10090, 10766
Sansui	10463, 11904, 11935, 11929, 11911
Sanyo	10154, 10156, 10180, 10145, 11907
Sanyuan	10093
Scotch	10178
Scott	10236, 10180, 10178
Sears	10047, 10054, 10154, 10156, 10178, 10171, 11926, 11904
Shaofeng	10145
Sharp	10093, 10030, 10650, 11917
Shen Ying	10092
Shencai	10145
Sheng Chia	10093, 10236
Skygiant	10180
Skyworth	10748
Sony	11100, 10000, 10650, 11925, 11904
Soundesign	10180, 10178

TELEVISION codes

Manufacturer	Program Code
Sowa	10156, 10051, 10060, 10178, 10092
Squareview	10171
SSS	10180
Starlite	10180
Studio Experience	10843
Supreme	10000
SVA	10748, 10865
Sylvania	10054, 10030, 10171, 11944, 11931
Symphonic	10180, 10171, 11913, 11904
Synco	10000, 10451, 10093, 10060, 10178, 10092
Tacico	10178, 10092
Tandy	10093
Tashiko	10092, 10650
Tatung	10054, 10154, 10156, 10051, 10060, 11156, 11756, 11254
Technics	10250, 10051
Techwood	10051
Teco	10051, 10093, 10178, 10092
Teknika	10054, 10180, 10150, 10060, 10092
Telefunken	10702
Tera	10030
Thomas	11904
Tiane	10093
TMK	10178
TNCi	10017
Tobo	10748
Toshiba	10154, 10156, 10060, 10145, 11945, 11704, 11936, 11156, 11935, 10650, 11918
Tuntex	10030, 10092
TVS	10463
V Inc.	11756, 10885, 10864
Vector Research	10030
Victor	10250, 10053, 10650
Vidikron	10054
Vidtech	10178
Viewsonic	11755, 10885, 10864
Wards	10054, 10030, 10178, 10866, 11156
Warumaia	10661
Waycon	10156
White Westinghouse	10463, 11909, 10623
Yamaha	10030
Yapshe	10250
Zenith	10017, 10463, 10178, 11904, 11929, 11911, 11909, 10092

VCR codes

Manufacturer	Program Code
ABS	21972
Admiral	20048, 20209
Aiko	20278
Aiwa	20037, 20479
Alienware	21972
America Action	20278
American High	20035
Amoisonic	20479
Anam	20162, 20037, 20240, 20278
Anam National	20162
Asha	20240
Audiovox	20037, 20278
Beaumarck	20240

VCR codes

Manufacturer	Program Code
Bell & Howell	20104
Broksonic	20184, 20121, 20209, 20002, 20479
Calix	20037
Canon	20035
Carver	20081
CCE	20072, 20278
Changhong	20048, 20081
Citizen	20037, 20278
Colt	20072
Craig	20037, 20047, 20240, 20072
Curtis Mathes	20060, 20035, 20162
Cybernex	20240
CyberPower	21972
Daewoo	20045, 20104, 20278
Dell	21972
Denon	20042
DirecTV	20739
Durabrand	20039, 20038
Electrohome	20037
Electrophonic	20037
Emerex	20032
Emerson	20035, 20037, 20184, 20240, 20045, 20121, 20043, 20249, 20002, 20278, 20479
Fisher	20047, 20104
Fuji	20035, 20033
Fujitsu	20045
Gateway	21972
GE	20060, 20035, 20240
General	20045
Go Video	20432
GoldStar	20037, 20209, 20038, 20225
Haojie	20240
Harman/Kardon	20081, 20038
Harwood	20072
Hewlett Packard	21972
HI-Q	20047
Hitachi	20037, 20042, 20055
Howard Computers	21972
HP	21972
Hughes Network Systems	20042, 20739
iBUYPOWER	21972
JVC	20045, 20067
KEC	20037, 20278
Kenwood	20067, 20038
KLH	20072
Kodak	20035, 20037
Kolin	20043
LG	20037, 20045, 20042, 20209, 20038
Logik	20072
LXI	20037
Magnavox	20035, 20039, 20081
Magnin	20240
Marantz	20035, 20081
Marta	20037
Matsushita	20035, 20162
Media Center PC	21972
MEI	20035

VCR codes

Manufacturer	Program Code
Memorex	20035, 20162, 20037, 20048, 20039, 20047, 20240, 20104, 20209, 20479
MGA	20240, 20043
MGN Technology	20240
Microsoft	21972
Mind	21972
Minolta	20042
Mitsubishi	20067, 20043
Motorola	20035, 20048
MTC	20240
Multitech	20072
NEC	20035, 20037, 20048, 20104, 20067, 20038
Newave	20037
Nikko	20037
Noblex	20240
Northgate	21972
Olympus	20035
Optimus	21062, 20162, 20037, 20048, 20104, 20432
Orion	20184, 20209, 20002, 20479
Panasonic	21062, 20035, 20162, 20616, 20225
Penney	20035, 20037, 20240, 20042, 20038
Pentax	20042
Philco	20035, 20479
Philips	20035, 20081, 20739, 20618
Pilot	20037
Pioneer	20042, 20067
Polk Audio	20081
Profitronic	20240
Proscan	20060
Protec	20072
Pulsar	20039
Qisheng	20060
Quasar	20035, 20162
Radix	20037
Randex	20037
RCA	20060, 20035, 20240, 20042, 20880
Realistic	20035, 20037, 20048, 20047, 20104
ReplayTV	20616
Runco	20039
Sampo	20037, 20048
Samsung	20240, 20045, 20432
Sanky	20048, 20039
Sansui	20067, 20209, 20479
Sanyo	20047, 20240, 20104
Scott	20184, 20045, 20121, 20043
Sears	20035, 20037, 20047, 20042, 20104
Sharp	20048, 20209
Shintom	20072
Shogun	20240
Singer	20072
Sonic Blue	20616
Sony	20035, 20032, 20033, 20636, 21972
STS	20042
Sylvania	20035, 20081, 20043
Systemax	21972
Tagar Systems	21972
Tashiko	20037
Tatung	20045, 20067

VCR codes

Manufacturer	Program Code
Technics	20035, 20162
Teco	20035, 20037, 20048, 20038
Teknika	20035, 20037
Tivo	20636, 20618, 21503, 20739
TMK	20240
Toshiba	20045, 20042, 20067, 20043, 21503, 21008, 21972
Totevision	20037, 20240
Touch	21972
Unitech	20240
Vector	20045
Vector Research	20038
Victor	20067
Video Concepts	20045
Videomagic	20037
Videosonic	20240
Viewsonic	21972
Wards	20060, 20035, 20048, 20047, 20081, 20240, 20042, 20072
White Westinghouse	20209, 20072
XR-1000	20035, 20072
Yamaha	20038
Zenith	20039, 20033, 20209, 20479
ZT Group	21972

DVD codes

Manufacturer	Program Code
Aiwa	20641, 21912
Akai	20770
Allegro	20869
Apex Digital	20672, 20717, 20797, 21061, 20796, 21056, 21937, 20794, 21020, 21915
Blaupunkt	20717
Blue Parade	20571
Broksonic	20695
Changhong	20627, 21061
CineVision	20869
Coby	21086
Curtis Mathes	21087
CyberHome	21024, 21023, 21129, 20816, 21117
Daewoo	20833, 21172, 20869
Denon	20490
DVD2000	20521
Emerson	20591, 20675
Enterprise	20591
Fisher	21919
Funai	20675
Gateway	21158, 21073
GE	20522, 20717
Go Video	20744, 20833, 21099, 20783, 21075, 20869, 21730
Greenhill	20717
Harman/Kardon	20582, 20702
Hitachi	20573, 20664, 21919
Hiteker	20672
Initial	20717
Integra	20627, 21924
JBL	20702
JVC	20558, 20623, 20867
Kenwood	20490, 20534
KLH	20717, 21020, 21149

DVD codes

Manufacturer	Program Code
Koss	20651, 21980
Lasonic	20798
LG	20591, 20869, 20801
Liquid Video	21980
Lite-On	21158, 21058
Loewe	20511
Magnavox	20503, 20539, 21976, 21914, 20675
Marantz	20539
Memorex	20695
Microsoft	20522
Mintek	20717
Mitsubishi	21521, 20521
Nesa	20717
Norcent	21003
Onkyo	20503, 20627, 21924, 20792
Oritron	20651, 21980
Panasonic	20490, 21762, 21990
Philips	20503, 20539, 20646, 21914
Pioneer	20525, 20571
Polaroid	21086, 21061
Polk Audio	20539
Portland	20770
Proscan	20522
Qwestar	20651
RCA	20522, 20571, 20717, 20822
Rio	20869
Rotel	20623
Sampo	20752, 20698
Samsung	20490, 20573, 21932, 21075, 20820
Sansui	20695
Sanyo	20695
Sharp	20630, 20752
Sharper Image	21117
Sherwood	20770
Shinco	20717
Shinsonic	20533
Sonic Blue	20869, 21099
Sony	20533, 20864, 21033, 21904, 21903
SVA	20717
Sylvania	20675
Teac	20717, 21984, 20809
Technics	20490

Cable codes

Manufacturer	Program Code
ABC	00003, 00008, 00014
Americast	00899

Cable codes

Manufacturer	Program Code
ClearMax	00883
Coolmax	00883
Daeryung	01877, 00877, 00477, 00008
Digi	00637
Director	00476
Dumont	00637
Gehua	00476
General Instrument	00476, 00810, 00276, 00003, 00014
GoldStar	00144
Hamlin	00009, 00273
Hitachi	00014
Jerrold	00476, 00810, 00276, 00003, 00012, 00014
KNC	00008
LG	00144
Memorex	00000
Motorola	00476, 00810, 00276, 01254, 01376
MultiVision	00012
Pace	01877, 00237
Panasonic	00000, 00008, 00107
Panther	00637
Paragon	00000
Philips	00317, 01305
Pioneer	01877, 00877, 00144, 00533
Pulsar	00000
Quasar	00000
RadioShack	00883
Regal	00279, 00273
Runco	00000
Samsung	00000, 00144
Scientific Atlanta	01877, 00877, 00477, 00008
Sony	01006
Starcom	00003, 00014
Supercable	00276
Supermax	00883
Tocom	00012
Torx	00003
Toshiba	00000
Trans PX	00276
Tristar	00883
TS	00003
V2	00883
Viewmaster	00883
Vision	00883
Vortex View	00883
Zenith	00000, 00525, 00899

Satellite codes

Manufacturer	Program Code
AlphaStar	00772
Chaparral	00216
Crossdigital	01109
DirecTV	00392, 00566, 00639, 01142, 00247, 00749, 01749, 00724, 00819, 01856, 01076, 01109, 00099, 01392, 01640, 01442, 01414, 01108
Dish Network System	01005, 00775, 01505
Dishpro	01005, 00775, 01505
Echostar	01005, 00775, 01505
Expressvu	00775

Cable codes

Manufacturer	Program Code
GE	00566
General Instrument	00869
GOI	00775
Goodmans	01246
Hisense	01535
Hitachi	00819, 00222, 01250
HTS	00775
Hughes Network Systems	01142, 00749, 01749, 01442
I-Lo	01535
JVC	00775
LG	01414, 01226
Magnavox	00724, 00722
Memorex	00724
Mitsubishi	00749
Motorola	00869
NEC	01270
Next Level	00869
Panasonic	00247, 00701
Paysat	00724
Philips	01142, 00749, 01749, 00724, 01076, 00722, 00099, 01442
Proscan	00392, 00566
Proton	01535
RadioShack	00869
RCA	00392, 00566, 00855, 00143, 01392
Samsung	01276, 01109, 01108
Sanyo	01219
SKY	00856
Sony	00639, 01640
Star Choice	00869
Tivo	01142, 01442
Toshiba	00749, 01749, 00790, 01285
UltimateTV	01640, 01392
Uniden	00724, 00722
US Digital	01535
USDTV	01535
Voom	00869
Zenith	00856, 01856

Amplifiers codes

Manufacturer	Program Code
Bose	30674
GE	30078
JVC	30331
Marantz	30321
Nakamichi	30321
NEC	30264
Optimus	30395
Realistic	30395
Sansui	30321
Shure	30264
Sony	30689
Soundesign	30078
Victor	30331
Wards	30078
Yamaha	30354, 30133

CD Players codes

Manufacturer	Program Code
Aiwa	30157
Burmester	30420
California Audio Labs	30029
Carver	30157, 30179
Denon	30873
DKK	30000
DMX Electronics	30157
Dynamic Bass	30179
Fisher	30179
Garrard	30420
Genexxa	30032
Harman/Kardon	30157, 30173
Hitachi	30032
Integra	30101
JVC	30072
Kenwood	30826, 30626, 30028, 30037, 30036, 30190
Krell	30157
Linn	30157
Magnavox	30157
Marantz	30626, 30029, 30157
MCS	30029
Miro	30000
Mission	30157
MTC	30420
NSM	30157
Onkyo	30868, 30101
Optimus	31063, 30000, 30032, 30037, 30420, 30179, 31075, 30145
Panasonic	30029
Parasound	30420
Philips	30626, 30157
Pioneer	31063, 30162, 30032
Polk Audio	30157
Proton	30157
QED	30157
Quad	30157
Quasar	30029
RadioShack	31075
RCA	31062, 30032, 30420, 30179, 30053
Realistic	30420, 30179
Rotel	30157, 30420
SAE	30157
Sansui	30157
Sanyo	30179
SAST	30157
Sharp	30861, 30037
Silsonic	30888, 30036
Sonic Frontiers	30157
Sony	30490, 30000, 30100
Soundesign	30145
TAG McLaren	30157
Tascam	30420
Teac	30420
Technics	30029
Victor	30072
Wards	30157, 30053
Yamaha	30888, 30036
Zonda	30157

Receivers codes

Manufacturer	Program Code
ADC	30531
Aiwa	31405, 31243, 30121
Anam	31609, 31074
Audiotronic	31189
Bose	31229
Capetronic	30531
Carver	31189
Coby	31263
Denon	31360, 31142, 30904
Fonmix	31360
Glory Horse	31263
Harman/Kardon	30110
Hitachi	31273
Inkel	30027
Integra	30135
JBL	30110
JVC	30074, 31263
Kenwood	31313, 31570, 30027
KLH	31428
Magnavox	31189, 31269, 30531
Marantz	31189, 31269, 30039
MCS	30039
Onkyo	30842, 30135
Optimus	31023, 30670, 30531, 31074
Panasonic	31518, 30039
Philips	31189, 31269
Pioneer	31023, 31050, 30014, 30630, 30531
Proscan	31254
Qisheng	31609
Quasar	30039
RadioShack	31263
RCA	31023, 31609, 31254, 30531, 31074
Sharper Image	31263
Silsonic	30176
Sony	31058, 31441, 31258, 31759
Soundesign	30670
Stereophonics	31023
Sunfire	31313
Teac	31074, 31267
Technics	31308, 31518, 30039
Thorens	31189
Victor	30074
Wards	30014
Yamaha	30176, 31276, 31176

Index

A

AMP button(Remote Control) -----	18
AUDIO -----	24, 26
AUDIO (DTV) -----	26
AUDIO ADJUST -----	26
Audio Cable -----	10, 26
Audio input terminal -----	7
Audio Output -----	15
AUDIO SETUP -----	26
Auto Sync adjustment -----	25
AUTOSYNC -----	13
AUX button (Remote Control) -----	18
AV button (Remote Control) -----	20
AV MODE button (Remote Control) -----	20

B

BALANCE -----	26
BASS -----	26
Battery -----	4
BRIGHTNESS -----	25

C

CAPTION STYLE -----	26
CBL button (Remote Control) -----	18
CD button (Remote Control) -----	18
Center Channel Input -----	14
CENTER-IN -----	26
CH button (Remote Control) -----	18
CH SEARCH (DTV) -----	26
CH SETUP (DTV) -----	26
Change Password -----	29
Changing Volume Lock -----	21
Channel ▲/▼& Adjust button (Side Control Section) -----	16
Channel ▲/▼ Button -----	16, 18
Checking Component Codes -----	21
Cleaning the Exterior -----	32
Cleaning the Screen -----	32
Clock (PC mode only) -----	25
CLOSED CAPTION -----	26
CLOSED CAPTION (DTV) -----	26
Coaxial cable -----	6
COLOR -----	25
COLOR TEMP -----	25
COMP button (Remote Control) -----	20
Component Cable -----	7, 10
Component Codes -----	27
Component Program Codes -----	21, 26
Composite Cable -----	9
CONTRAST -----	25

D

Digital Audio Output -----	15
Digital Video -----	8
DISP. button (Remote Control) -----	19
Dot by Dot -----	31, 39
DTV SETUP -----	26
DVD button (Remote Control) -----	18
DVI cable -----	8

E

EDIT -----	26
EFFECT -----	26
ENTER button (Remote Control) -----	18
ERROR MESSAGE -----	34
EXIT button (Remote Control) -----	19

F

FREEZE button (Remote Control) -----	20
Front Panel Indicator -----	17
F-type connector -----	6

G

Game console connecting -----	11
Getting Standard -----	24

H

H POS -----	25, 26
HDCP -----	12
HDMI -----	8
HDMI AUDIO -----	26
HDMI SIGNAL -----	26
HDMI Terminal -----	8
HDMI/PC button (Remote Control) -----	20

I

IN AV3 Button -----	11
Input / Output Terminals -----	40
INPUT button (Remote Control) -----	16, 18
INPUT button(Side Control Section) -----	16
INPUT SIGNAL -----	26

L

LAMP LED -----	17
Last button (Remote Control) -----	18
LANGUAGE -----	26
Lightning Protection -----	30

M

MANUAL SEARCH -----	26
MENU button (Side Control Section) -----	16
MPEAA Rating -----	27
MTS -----	26

Index

MUTE button (Remote Control) -----	19	SIZE -----	26
NEW SECRET NO . -----	27	SLEEP button (Remote Control) -----	18
NOISE REDUCTION -----	25	SLEEP TIMER -----	28
Normal -----	31	SP OFF -----	26
Number Pad button (Remote Control) -----	18	SP ON -----	26
O		SPEAKER -----	26
OFF -----	26	SPLIT -----	25, 26
OK button (Remote Control) -----	19	STATUS -----	28
OK button (Side Control Section) -----	16	Status LEDs -----	34
On Screen Display (OSD) -----	25	Stretch -----	31
Optical Terminal -----	15	S-VIDEO Cable -----	7,9
OPTION -----	24, 28	SWAP button (Remote Control) -----	20
P		SYSTEM INFO -----	28
PARENTAL CONTROL -----	24	T	
PC Compatibility -----	13	TINT -----	25
PC INPUT -----	12	TRANSPARENCY -----	25, 26
PHASE (PC mode only) -----	25	TREBLE -----	26
PICTURE -----	24, 25	TV button (Remote Control) -----	18
PIP -----	25, 26	TV GUIDELINES -----	27
PIP button (Remote Control) -----	20	TV/DTV button (Remote Control) -----	20
PIP MODE button (Remote Control) -----	20	V	
PIP SETUP -----	21, 24	V POS -----	25, 26
PIP VIEW button -----	25	VCR button (Remote Control) -----	18
PIP VIEW button (Remote Control) -----	20	VIEW MODE -----	25, 31
POP -----	26	VIEW MODE button (Remote Control) -----	19
POWER button (Remote Control) -----	18	VOL button (Remote Control) -----	18
POWER button (Side Control Section) -----	16	VOLUME ▲/▼& ADJUST button-----	16
POWER LED -----	17	W	
R		Wide Modes -----	31
RECONFIRM -----	28	Z	
Remote Control -----	14	Zoom -----	31
Remote Control Sensor -----	17	ZOOM button (Remote Control) -----	20
Remote LED -----	18		
Replacing the Lamp -----	33		
RESET -----	25, 26		
RESET ALL SETTINGS -----	28		
Reset Password -----	29		
Resetting the lamp timer -----	34		
S			
S.Stretch -----	31		
SAT button (Remote Control) -----	18		
Searching for Component Codes -----	21		
SELECT button (Remote Control) -----	20		
Setting Password -----	29		
SETUP -----	24, 26		
SETUP button (Remote Control) -----	18		
SHARPNESS -----	25		
Side Bar -----	31		



www.vivitekc corp.com

Vivitek Corp.

48017 Fremont Blvd.

Fremont, CA 94538

Tel: (510) 651-0881

Efax: (510) 226-4163



© 2005 Vivitek Copyrights

Free Manuals Download Website

<http://myh66.com>

<http://usermanuals.us>

<http://www.somanuals.com>

<http://www.4manuals.cc>

<http://www.manual-lib.com>

<http://www.404manual.com>

<http://www.luxmanual.com>

<http://aubethermostatmanual.com>

Golf course search by state

<http://golfingnear.com>

Email search by domain

<http://emailbydomain.com>

Auto manuals search

<http://auto.somanuals.com>

TV manuals search

<http://tv.somanuals.com>