

[www.vivitek.us](http://www.vivitek.us)

View of the Digital World

# 56" Micro Chip Display Projection TV USER GUIDE



## FCC Warning

This product has undergone tests in pursuance of Part 15 of the FCC Regulations and has been found to meet the regulations for Class B devices, which are provided for reasonable protections while keeping the product from hazardous interference when installed and used. This product may emit radioactive energy while in use. Failure to install and use this product in accordance with the guidelines set out in the User s Manual may lead to hazardous interference generated by radio communications.

- To increase the distance between this product and the radio telecommunications product.
- To adjust or re-orient the location of the antenna of the radio telecommunications product.
- To connect this product to a different electrical outlet than one used for a radio telecommunications product.
- To contact local dealer for technical assistance.

In order to meet the FCC requirements , please use the grounded power cord provided and shielded ferrite core video adapter. All modifications conducted by the user without consent of local authorities shall void the operation of this product.

## Accessories Check

Please make sure you have these standard accessories with your device.

- Remote Control x 1pcs
- AA Batteries x 2pcs
- This User's Guide x 1pcs
- Power Cord x 1pcs
- Warranty Card \*1pcs



# Maintenance

## Clear methods

For the reason of safety, please make sure to unplug the power cord before start to do the cleaning.

### *Cleaning for the case*

- To mop the outside of the case with soft and clean cloth. Follow the instruction if use any cloth containing certain chemical materials.
- Do not use alcohol or other material inflammable, which will result in the decay of the case or paint fading.
- Do not use robber or other clue-related material to interface with the case. It possibly will leave scar on the case.

### *Cleaning for the monitor*

- Please clean up the dust on the surface of the monitor with soft cloth or other similar material and then clean the monitor with dry and soft cloth again.
- It's prone to get scratch on the surface of the monitor so do not rub or knock the surface with hard material. Also, do not use any diluted detergent to scrape or clean the monitor.

## Maintenance for filter

Please do not leave the machine without filter installed or the have a dirty filter owing to lack of periodically cleanup. It's because the filter is to prevent the dust or other objects from going into the internal of the machine. And keep the machine in a good ventilation condition. It will result in the rise of temperature in the machine and even cause a fire or damage if the filter with dust does not be replaced for a long period of time. The filters are supplies and please contact the resellers for details if you need to replace the filter.

Please contact the reseller for information about replacement or cleanup of the filter within 1 year. The outgoing or incoming vent hole should be cleaned periodically.

### *Method to replace the filter*

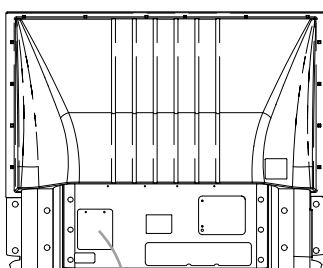

Filter

Step 1 : Loose this tow Screw on the filter cover



Step 2 : Take out the used filter and put new filters on 4 slots

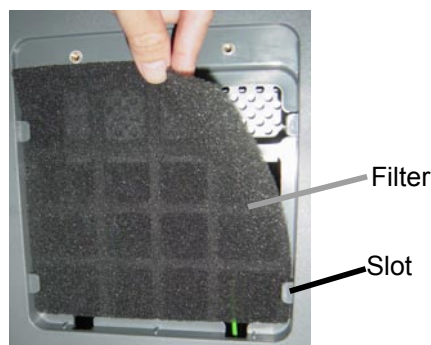

Filter

Slot

Step 3. Put the filter cover back and Screw the filter on the back of the machine

# Replacement method of projection lamp

Projection lamps are supplies and have life span. Please contact the resellers when the image turns dark or color gets deteriorated. When this happens, please replace it with a new projection lamp. If the projection lamp could not light up and have noise, the possible reasons are:

- 1.The life span for the projection lamp are ended or
- 2.Shutting down the TV right after the turn-on of power. At the moment, the temperature of projection lamp is too high and does not cool down to certain degree. Turn it on after a few minutes and it will work properly. or
- 3.The projection lamp does not connect correctly with the lamp cradle.

## Replacement Procedure



Beware of the high temperature when replace the projection lamp.

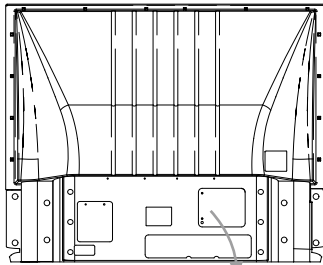

Lamp

### Warning:

Eye damage may result from Directly viewing the light produced by the lamp used in this apparatus. Always turn off lamp before opening this cover.



1.Loose the screw on lamp cover

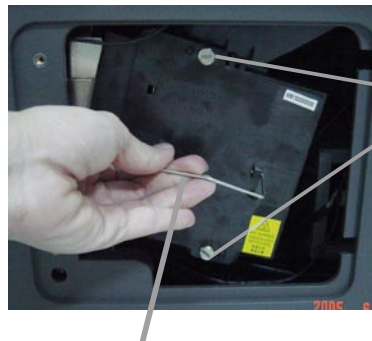

2.Then loose the screw on lamp

3.Pull out the lamp directly

4.Then put the new lamp into this unit. (Follow the reverse the way you took it out.)

Caution: After taking the projection lamp out, do not place any metal substance into the lamp cradle. Do not touch the lamp cradle or it's easy to get burned or cause fire.

Caution: Do not touch the glass surface of the new projection lamp because it possibly will affect the quality of resolution and decrease the life span of the projection lamp.

Caution: Make sure to screw the screws firmly in order to prevent the shaking of the lamp, which will result in poor connection.

Caution: Put the discarded used projection lamp in the packaging box of the new projection lamp and handle it with case and compliant to local regulation. Please do not have kids to access the discarded lamps to prevent any danger.

# Index

<b>1.Important Statement</b>	<b>1</b>
<i>FCC Warning</i>	1
<i>Accessories Check</i>	1
<i>Maintenance</i>	2
<i>Method to replace the filter</i>	2
<i>Replacement method of projection lamp</i>	3
<b>2.Before Use</b>	<b>6</b>
<i>Correct viewing</i>	6
<i>Remote Control</i>	6
<i>Handling</i>	7
<i>Moisture Condensation</i>	7
<b>3.Safety Instructions - Warning and Caution</b>	<b>8</b>
<b>4.Connection with Antenna Cable</b>	<b>12</b>
<b>5.System Connection</b>	<b>13</b>
<i>Front Connector</i>	13
<i>Rear Connector</i>	14
<b>6.Introduction the Control Panel and Remote Control</b>	<b>16</b>
<b>7.Power ON / OFF</b>	<b>18</b>
<b>8.How to use OSD</b>	<b>19</b>
<i>Before use OSD, You must know</i>	19
<i>OSD explanation</i>	20
<i>Picture Adjust</i>	20
<i>PIP SETUP</i>	23
<i>INPUT SETUP</i>	24
<i>TV TUNER SETUP</i>	24
<i>AUDIO ADJUST</i>	26
<i>PARENTAL CONTROL</i>	27
<i>PECIAL FEATURE</i>	28

<b>9.Programming the universal remote control</b>	<b>29</b>
<i>To program the remote to control other devices:</i>	29
<i>Device program codes</i>	29
<i>Searching for device codes</i>	36
<i>Reassigning device buttons</i>	36
<i>Teaching the remote control new functions</i>	37
<i>Using the universal remote control</i>	37
<i>Using picture-in-picture (PIP) mode</i>	38
<i>Setting the sleep timer</i>	38
<i>Troubleshooting</i>	39
<b>10.Display Modes</b>	<b>40</b>
<i>Video Input Format</i>	40
<i>Default PC Input Mode</i>	40
<i>Miscellaneous</i>	40
<b>11.Specifications</b>	<b>41</b>
<b>12.Troubleshooting</b>	<b>42</b>
<b>13.LED Status</b>	<b>43</b>
<b>14.Service Information and Announcement</b>	<b>44</b>
<i>Service Information</i>	44
<i>Announcement</i>	44



## Correct viewing

### Distance

The most appropriate viewing distance varies between 5~7 times the height of the screen.

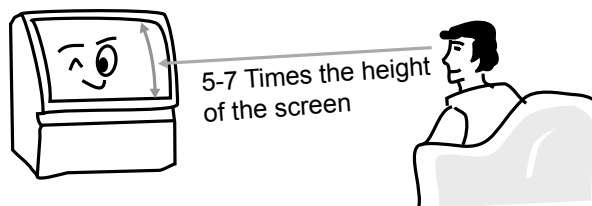

### Viewing Angle and Height

Suitable viewing angle and height will avoid fatigue.

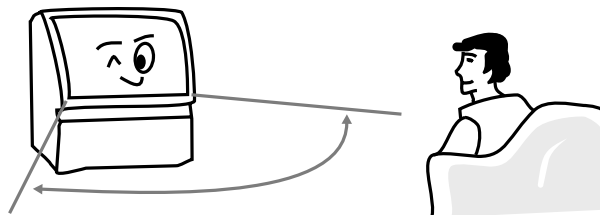

### Volume

As a courtesy to others, be sure to keep the volume down (especially in the evening).

### Brightness of your viewing location

Direct sunshine onto the screen, too bright or dark a room lighting, dark surrounding or reflected light may cause fatigue to your eyes. Be sure to keep out direct sunshine from the screen while maintaining soft lighting in the room. Reading light is recommended.

### Prolonged Viewing

This device uses DLPTM technology that will not flash or emit radiation. However, we would suggest you to take rest after viewing it for some time.

## Remote Control

The effective range of the IR sensor of the remote control is given as follows. Be sure to keep the IR sensor clear and avoid placing the sensor in bright light which might cause detriment to the receiving sensitivity.

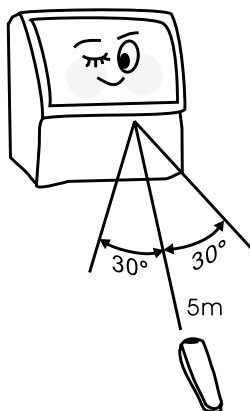

#### Remarks on the battery of the remote controller

The service life of the battery is about 1 year (depending on your use). When the operation range of the remote controller shortens or its sensitivity lowers, be sure to replace both batteries inside the remote control.

Note: Make sure to avoid replacing a new battery with an old one. This may cause eventually damage the remote control.

When you will not use the remote control for a long period of time, be sure to remove the batteries that could possibly leak. In the event of leakage, be sure to wipe off the liquid on the inside of the compartment before loading new batteries.

## Handling

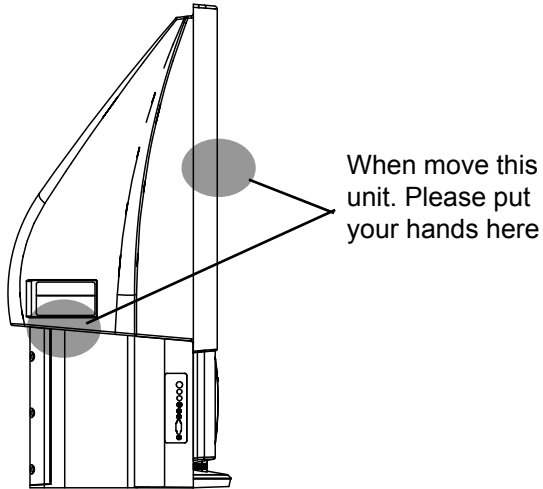

Find the indicated hand positions before lighting the device. To ensure balance and avoid accidental damage, be sure to have at least two people carry the product.

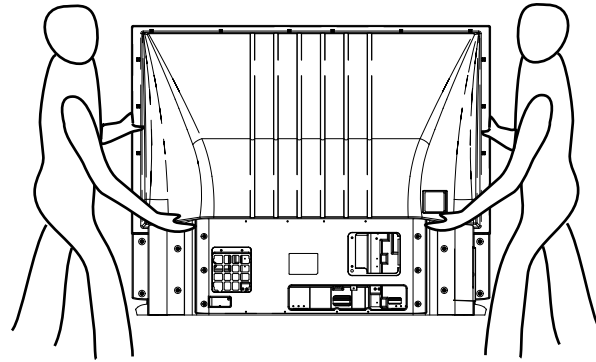

Be careful not to bump or scratch the product on other objects when you are handling it.

## Moisture Condensation

When this device is suddenly moved to a warm site from a cold one, or in case of abrupt change of the environmental temperature, moisture condensation may cause a foggy screen or incorrect display output. It is because moisture congeals inside. Please wait until the moisture is evaporated, then the screen will restore normal display.





### Smoking emitting from device

In the case of smoke emitting from the product, be sure to turn off the power switch and remove the power plug immediately. Using the product while it is smoking may cause a fire or electric shock. Contact the dealer immediately.

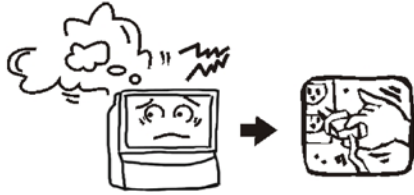

### Keep power plug dust free

Keep dust free of the power cord. Dust can cause the insulation to be damaged and cause a fire.



### No image or sound

In this case, be sure to turn off the power switch and remove the power plug. In case of sudden loss of image or sound, stop using the device and contact the dealer immediately.

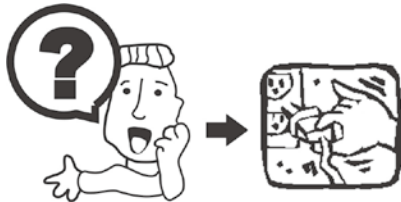

### Do not service, modify or disassemble this device

This device contains high voltage and fragile objects inside that may cause electric shock, fire or damage of the parts. Read the warranty booklet and contact the dealer for more information.



### Dropped or broken case

In this case, be sure to turn off the power switch and remove the power plug. Please contact the dealer for service. Do not use the device as it may cause fire or electric shock.

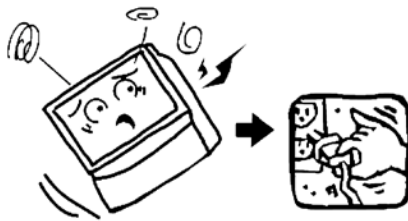

### Keep foreign objects off the device

Objects on the device can cause fire or electric shock. When there is a foreign object inside the device, turn off the power supply and remove the power plug before contacting the dealer. Be sure not to allow children to insert foreign objects inside the device.



### Use only 110V or 220V AC outlets

Use only 110V or 220V AC power outlets, otherwise fire or electric shock may result.

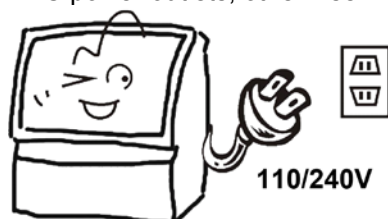

Do not place flower vases, glasses, cosmetics, chemical solutions, liquids or small metal objects on this device

Liquid or small objects inside the device may cause fire or electric shock. In this case, turn off the power supply and remove the power plug before contacting the dealer.

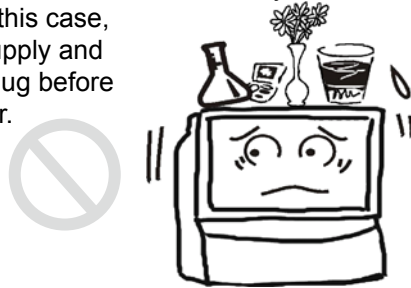

Do not touch the antenna or the power cord during thunder or lightning

In case of thunder or lightning, we would suggest you remove the power plug from the outlet and do not touch the antenna lead, as it may cause electric shock.



Keep this device from high temperature or direct sunshine

High temperature may cause overheating and fire.

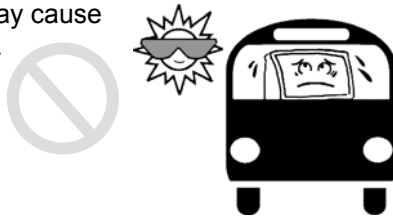

Keep this device away from kitchen smoke, steam, heater, dusty places and heat source

\*These conditions may cause fire or electric shock to occur.  
\*Both the case and the power cord may deform or melt with heat, causing fire



Keep the device from contacting rubber or plastic products for long period of time

This may cause the case to be deformed or the paint to strip off.

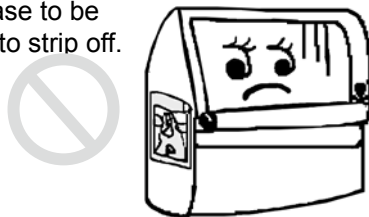

We strongly suggest you avoid plugging this into an outlet where other electrical appliances are being used

Plugging this device into a power strip or extension cord where other high-voltage appliances are already being used, may cause fire and overload the electrical circuit. Make sure if you use an extension cord or power strip that they are correctly rated for the proper voltage and current of this device.

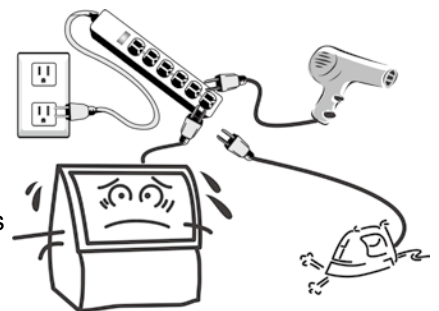

Do not touch the device and power cord while wet.

Do not touch the electrical cord or remove the power plug with wet hands which may cause electric shock.

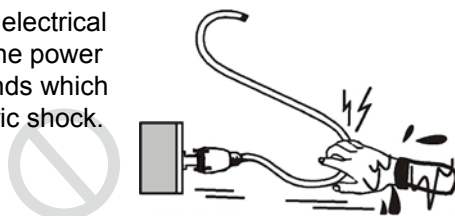



### Keep the ventilation grill free

- \*Do not let the screen face up, to the side or up side down.
  - \*Do not keep this device in a closet or bookshelf with poor ventilation.
  - \*Do not place this device on a rug or flammable objects.
  - \*Do not cover this device with curtains or tablecloths.
- Doing any above may cause a fire.

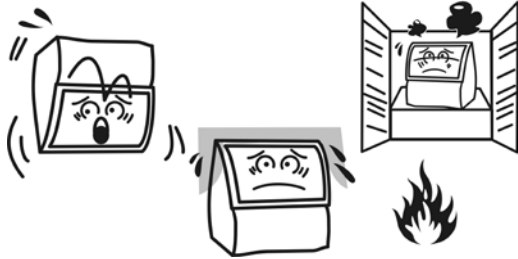

### Install this device in a flat and solid place

Be sure to allow for proper ventilation around the device.

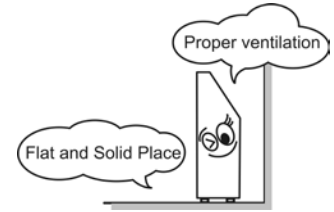

### Do not stand or sit on this device

Be sure to keep children from climbing on top of the television set, since it may fall over, break or result in damage.



### Keep heavy objects off this device

The device may turn over and fall causing damage to the unit.

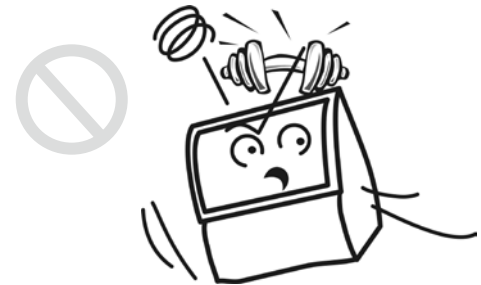

### Be sure to remove the power plug before cleaning or servicing

Otherwise electric shock may result. To clean the screen, use a piece of soft cloth that does not scratch the surface.



### Keep the device from incline and vibration surfaces

Or it may fall or turn over to cause damage or injuries.

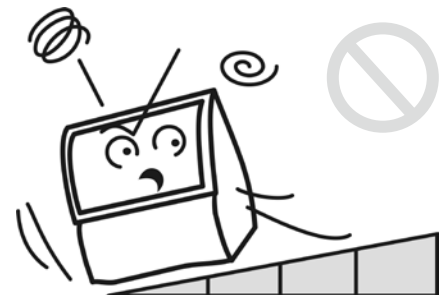

Do not remove back cover, case front panel or any other cover

The high-voltage components inside the unit may cause electrical shock if mishandled. For all adjustments and servicing to interior circuitry please contact the dealer.

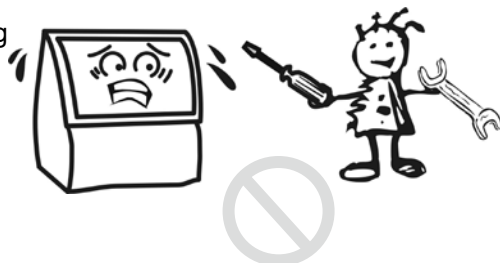

When you will not use this device for a long period of time, be sure to remove the power plug

When you are away for long periods of time be sure to unplug the device to avoid any fire due to electrical storms or power surges.



Be sure to remove the plug by holding the power cord plug

Remove the power cord at the receptacle by pulling on the plug, not on the cord. Or it may cause fire or electric shock.

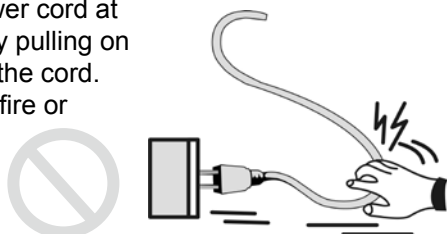

Do not cut, twist, perforate, modify or bend the connector or force the power cord or place heavy objects on it

Doing so may cause fire or electric shock. In case of broken power cord, please contact the dealer.

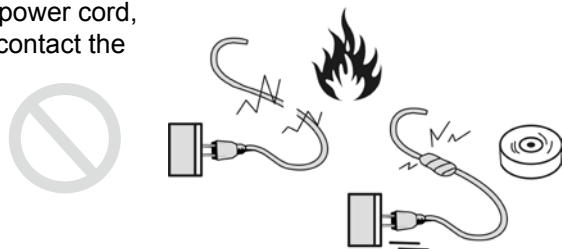



## Connection with Antenna Cable

1. Cable without a CATV Converter
2. VHF/UHF Combination Antenna

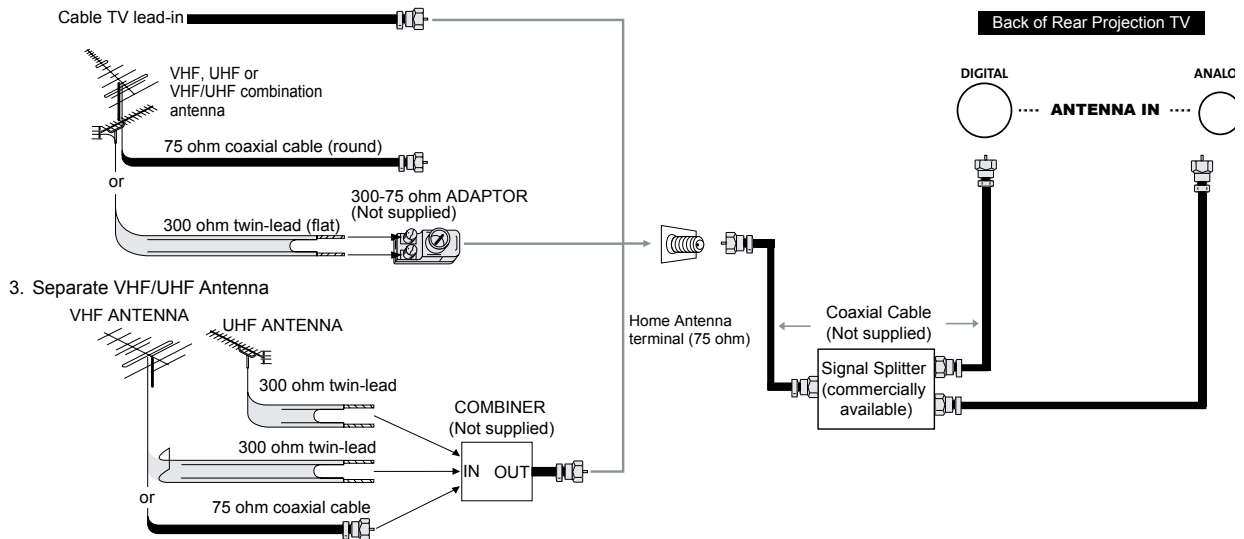

### Notice

*F-type connector should be finger-tightened only.*

When connecting the RF cable to the TV set, do not tighten F-type connector with tools. If tools are used, it may cause damage to your TV set. (The breaking of internal circuit, etc.)

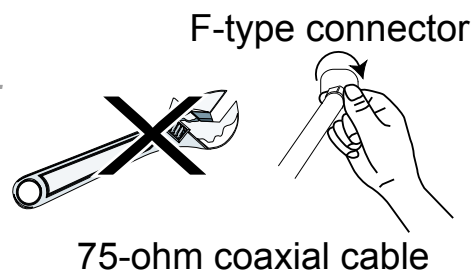

75-ohm coaxial cable

## CABLE TV (CATV) CONNECTION

- A 75 ohm coaxial cable connector is built into the set for easy hookup. When connecting the 75 ohm coaxial cable to the set, screw the 75 ohm cable to the COAXIAL CABLE CONNECTOR.
- Some cable TV companies offer "premium pay channels". Since the signals of these premium pay channels are scrambled, a cable TV converter/descrambler is generally provided to the subscriber by the cable TV company. This converter/descrambler is necessary for normal viewing of the scrambled channels. (Set your TV on channel 3 or 4. Typically one of these channels is used. If channel is unknown, consult your cable TV company.) For more specific instructions on installing cable TV, consult your cable TV company. One possible method of utilizing the converter/descrambler provided by your cable TV company is explained below.

Please note: RF switch equipped with position A/B (not provided) is required.

"A" position on the RF switch (not supplied) : You can view all unscrambled channels using the TV's channel keys.

"B" position on the RF switch (not supplied) : You can view the scrambled channels via the converter/descrambler using the converter's channel keys.

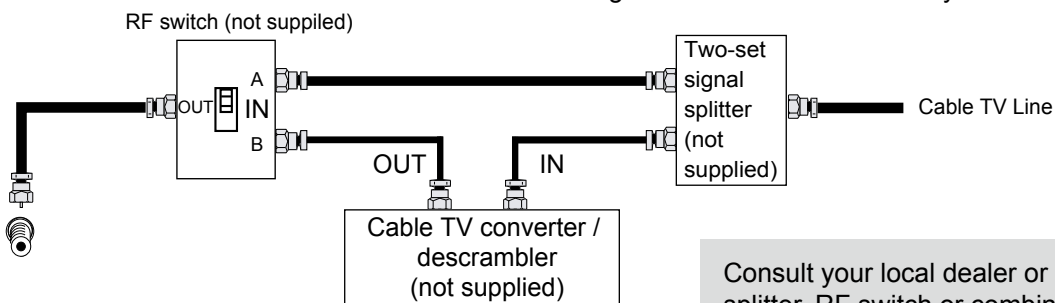

Consult your local dealer or Service center for the type of splitter, RF switch or combiner that might be required.

Please unplug the power cord of the machine and other devices attached before start to connect the device on the side of the machine.

## Front Connector

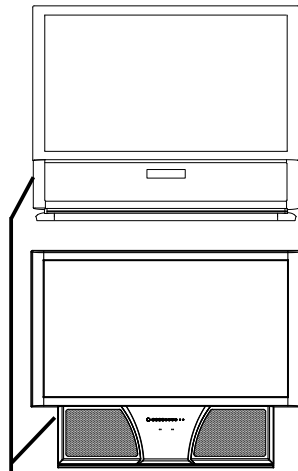

Find the front connector here

Use the Remote control or Machine front "Input" key to select the Input source to **Front AV**



Only digital camera with Video channel output function can be connected directly to the machine. There're still few digital cameras that require PCs in order to function properly.

V8, Game, Digital Camera...etc.

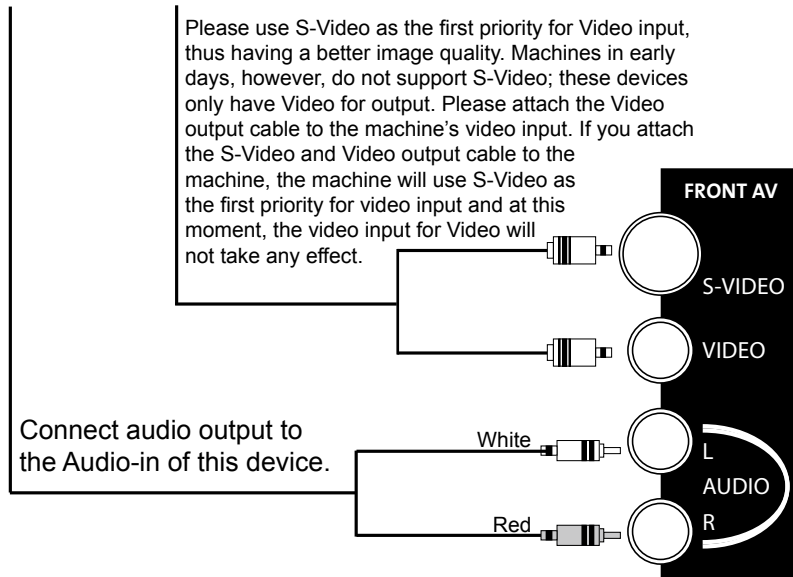

Connect to Headset or earphone

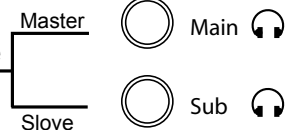

PC

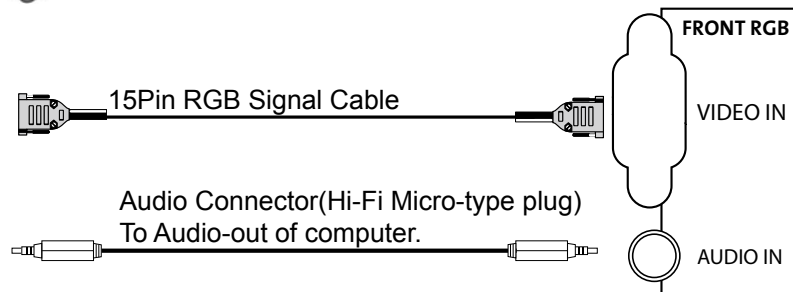

Use the Remote control or Machine front "Input" key to select the Input source to **Front RGB**



## Rear Connector - 1

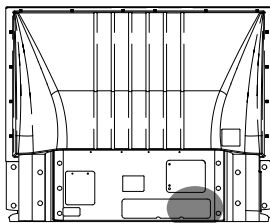

Use the Remote control or Machine front "Input" key to select the Input source to **AV1 IN** or **AV2 IN**

### VCR, Stereo, VCD, DVD Player

Video : Please use S-Video as the first priority for Video input, thus having a better image quality. Machines in early days, however, do not support S-Video; these devices only have Video for output. Please attach the Video output cable to the machine's video input. If you attach the S-Video and Video output cable to the machine, the machine will use S-Video as the first priority for video input and at this moment, the video input for Video will not take any effect.

Audio: To left audio input (White)  
To right audio input (Red)

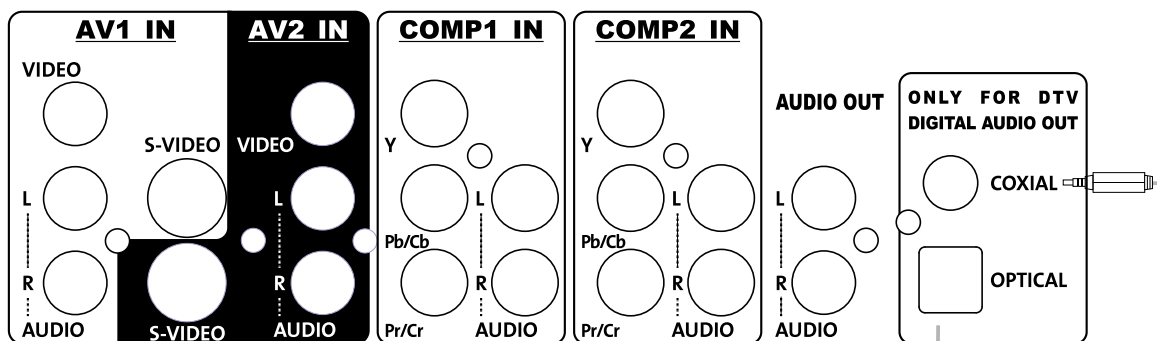
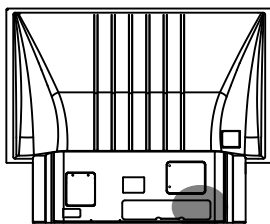

### DVD, Satellite, Cable etc.

Input video and Audio signal to the monitor.

Video: To machine Y image input (Green)  
To machine Pb/Cb image input (Blue)  
To machine Pr/Cr image input (Red)

Audio: To left audio input (White)  
To right audio input (Red)

Use the Remote control or Machine front "Input" key to select the Input source to **COMP1 IN** or **COMP2 IN**

If you are already using the COMP1 IN input for another component, or you do not want to use the COMP1 IN input for the DVD player, you can connect the DVD player to the COMP2 IN group of connections.

Refer to your DVD player user manual for more information about the video output requirements of the product.



### Stereo amplifier

These terminals are used for connecting a stereo amplifier for Digital TV Audio Signals only. They relay (pass-through) the audio signals of all DTV programs displayed on the RPTV screen.

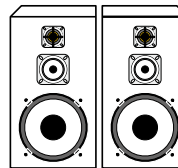

### Speaker System



# Rear Connector -2

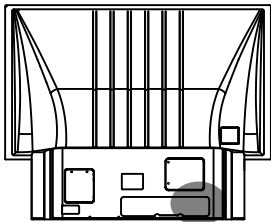
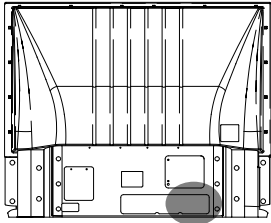

Use the Remote control or Machine front "Input" key to select the Input source to **DVI/HDCP IN**

The DVI port supports High-bandwidth Digital Content Protection (HDCP).

HDCP encrypts the transmission between the video source and the digital Display for added security and protection.

**New generation for home entertainment**

Digital video equipment and other devices that have a digital interface compliant with the HDCP(High-bandwidth Digital Content Protection) & DVI (Digital Visual Interface) standard should be connected to the DVI/HDCP IN input of the RPTV.

Video: DVI / HDCP

Audio: To left audio input (White)

To right audio input (Red)

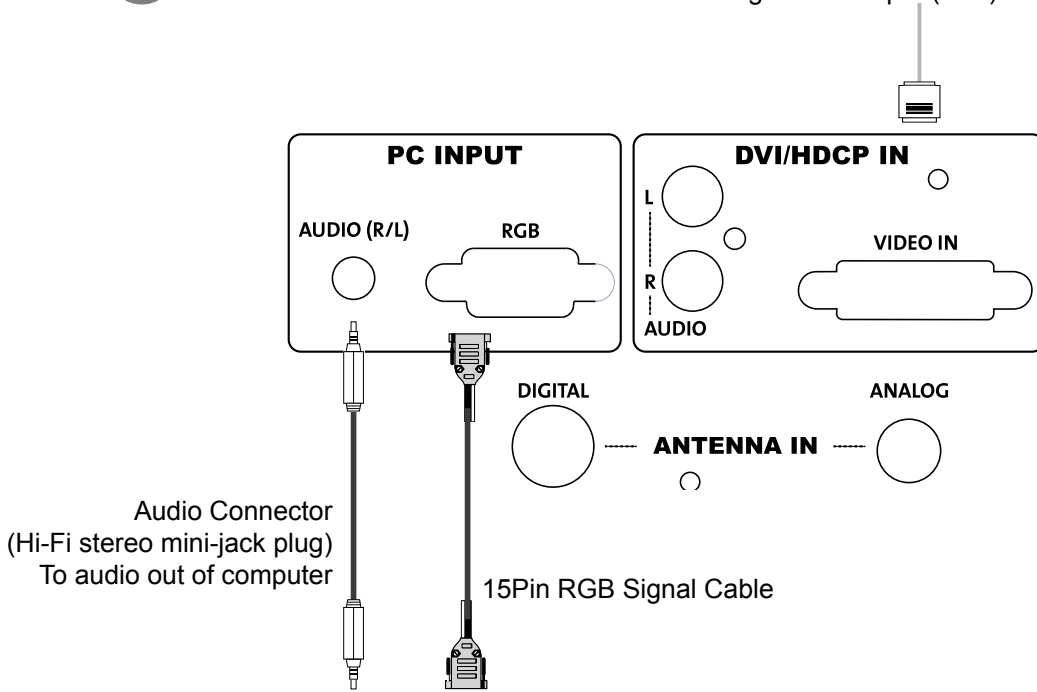

Audio Connector  
(Hi-Fi stereo mini-jack plug)  
To audio out of computer

15Pin RGB Signal Cable



Use the Remote control or Machine front "Input" key to select the Input source to **PC INPUT**



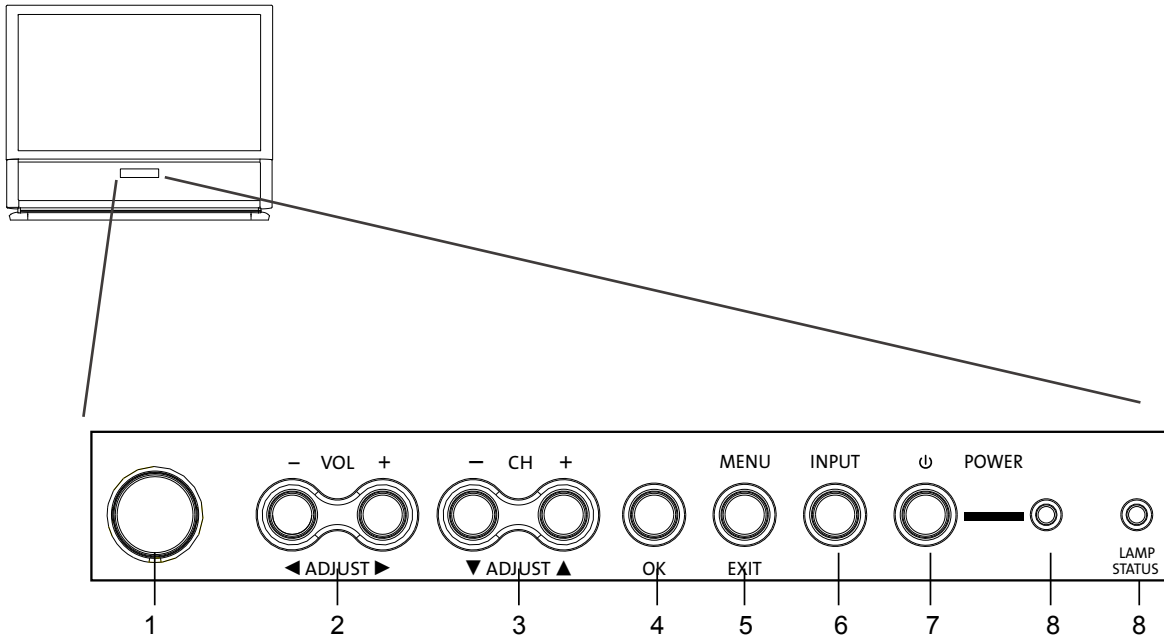

#### 1. IR Sensor

This is a window which receives infrared signal from the remote controller

#### 2. VOL

When OSD disappear. These buttons is used for adjust volume

◀ Volume decreases ▶ Volume increases

When OSD display. These are used for OSD menu ◀▶ item select

#### 3. CH

If the source of image is TV. These buttons are for selecting channels.

If OSD display. These are used for OSD menu ▲▼ item select

#### 4. OK

Come with OSD menu. When choice one item, then press this button to adjust it's value.

#### 5. Menu

Press this button to show or disappear OSD menu.

#### 6. INPUT

Press this button to select correct image signal source. Such as TV, Video, PC.....etc.

#### 7. Power

As long as the power cable on the back of the unit is plugged in the socket. This button can activate or deactivate the power at any time.

#### 8. LAMP / POWER STATUS

LED indicators of Power and Lamp. See page 43 for detail information.

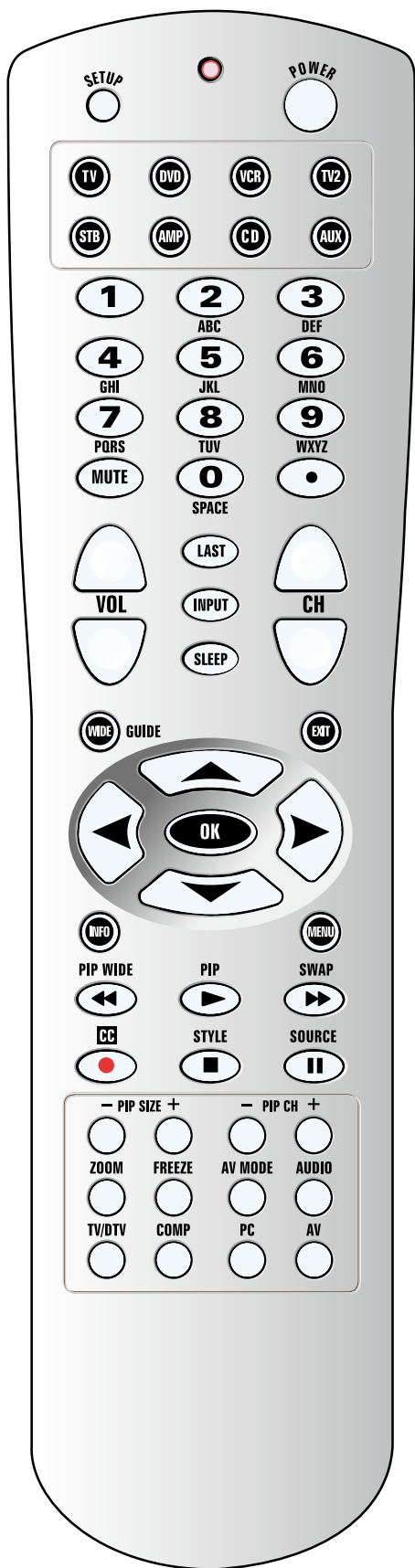

Note: If remote control can not work. Please press **TV** button firstly and try again.

## Button name Function

Setup	Starts all programming sequences.
Remote LED	Blinks when the remote is being programmed or is sending a signal to your RP TV
Power	Turns your RP TV or other selected device on and off.
Programs the remote control to recognize a device. For programming instructions, see "Programming the universal remote control" on page 29 "	
TV	Selects a programmed TV. Pre-programmed for your 56-inch RP TV
DVD	Selects a programmed DVD player
VCR	Selects a programmed VCR
TV2	Selects a second programmed TV
CBL/SAT	Selects a programmed cable TV set-top box or selects a programmed satellite TV set-top box
AMP	Selects a programmed amplifier
CD	Selects a programmed CD player
AUX	Selects a programmed device
1, 2, 3...0, *	Number(OSD) Channel select(TV)
Mute	Turn on/off the sound
VOL	Lower / Louder volume
CH	Increment/Decrement TV Channel
LAST ***	Switch to last Chosen Channel / Input
SLEEP	Setup sleep timer (P28)
INPUT	Scroll through available inputs (P24)
WIDE/GUIDE	Change Scaling Mode
EXIT	Hide the OSD
▲▼◀▶	Navigate Up/Down/Left/Right in the OSD
OK	Accept the select item in the OSD
INFO	Bring up display information
MENU	Bring up the OSD
PIP	Turn the PIP Mode On/Off
SWAP	Swap the Main and PIP Windows
CC	Close Caption Toggle On/Off (P24.25)
STYLE	Change the style of the PIP Window (P23, same as PIP INPUT function)
SOURCE	Change the PIP Input (P24)
PIP SIZE	Decrease/Increase the PIP Window (P23)
PIP CH	Decrease/Increase the PIP Channel
ZOOM ***	Zoom Taggle (see fig1)
FREEZE***	Freeze Taggle
AV MODE ***	Standard, Movie, Dynamic
AUDIO	Audio style eg:BBE/SRS/VIVA/HD3D/Surround/SIM.STEREO (P26)
SCAN	PIP Auto/Main Scan
TV / DTV	Direct access of TV or DTV (P24)
COMP	Toggle between 2 Device Inputs
PC	Toggle between 3PC Inputs
AV	Toggle between 3AV Inputs

\*\*\* This mark means the event only for remote control , you can't adjust it via OSD menu.

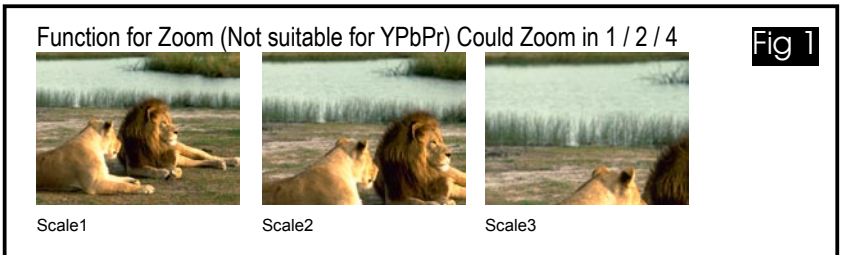

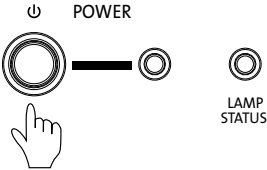

Fig 1



## Power on

Operation status	Machine status	Lamp LED	POWER LED
1. Connect the power cord into 110V~240V Plug 		Not display	Not display
2. Push the power button on the front panel 	Lamp is active	Orange light flash	Green
3. Successfully power on	Display status	Not display	Green

## Power off

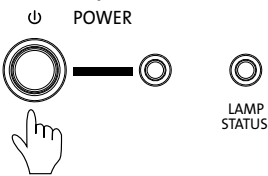
Operation status	Machine status	Lamp LED	POWER LED
1. Push the power button on the front panel 	Warm up	Orange light flash	Not display
2. Press the power button again to make sure you want to power off this RPTV.	Warm up	Orange light flash	Not display
3. Successfully power off		Not display	Orange

### Note:

In order to protect the lamp, when you press the **POWER** key two times to turn off the machine, please wait at least 30 seconds for cooling down the lamp, then could press the **POWER** key again to turn on the RPTV again.

# Before use OSD, You must know:

## Recommended ways to learn about operations

Before starting, please follow the suggested steps to understand the fundamentals of operating the display, and then you will be able to learn the operations in a short time:

1. Please first learn to power on and power off the display. Refer to page 18 for the descriptions of the operations.
2. Please learn how to operate the OSD.
3. Understand what each OSD menu is. Refer to page 20~28 for an explanation of the OSD contents.

## Example how to select correct input signal source.

After power on the display, first step: you need to select the correct input signal source. The screen will be blank without any images with incorrect input signal source. Follow the steps to set up:

1. Use OSD to select the correct input source, press the **MENU** key and bring up the OSD menu.
2. Use **▲▼** keys to select the "INPUT SETUP" option, press **OK** to enter the submenu.

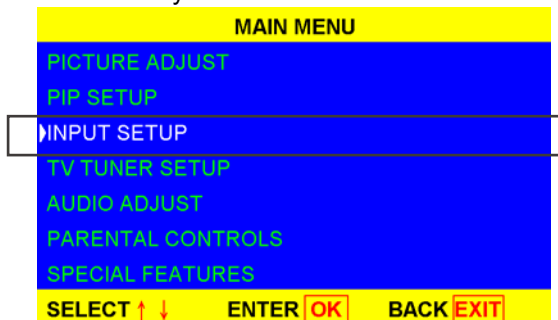

Press **OK** to enter the Submenu

3. Then the OSD will show the Submenu as below:



Follow the OSD's indicate to operate the OSD.  
For example:

1. Use **▲▼** key to select the item "Main Input", "PIP INPUT" or "INPUT SIGNAL"

2. then use **OK** to enter the item that you select.  
eg: use **▲▼** to select MAIN INPUT, press **ok** then use **◀▶** to select input source TV, DTV...

4. Press **OK**, then press **◀▶** to change the main input source, last press **OK** again to exit this main input setup.



3. If you want to exit the submenu, press **EXIT** on remote control to main menu or **Menu** key to exit OSD.

5. Now you understand:

Just to press the **MENU** key to show the OSD

And follow the OSD bottom line's information to operate the OSD. So you only need **MENU, EXIT, OK, ▲▼, ◀▶, ENTER** these keys to control the whole OSD.

If you still have any question, please call our service center to help you.

### Quick Input Source select way

For Main Input

Press the **INPUT** key in the front control panel or remote control repeatedly, the input signal mode will appear on the top left corner, please select correct input signal mode. (Refer to Input relative page 13~15,24)

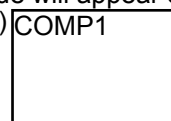

For PIP Input

Please refer to page 24.



# OSD explanation

## Picture Adjust

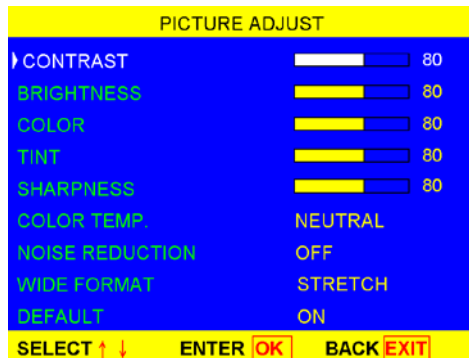

For other input source (Except Front RGB, RGB, DVI)

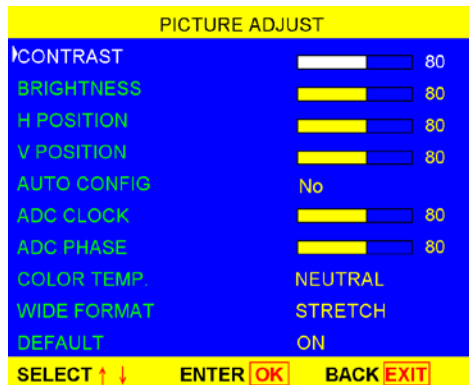

Only for Input source Mode: Front RGB, RGB, DVI

Original image



### 1. CONTRAST

Adjust the contrast of the screen image

◀ Reduce contrast    ▶ Increase contrast



### 2. BRIGHTNESS

Adjust the brightness of the screen image

◀ Reduce brightness    ▶ Increase brightness



### 3. COLOR

Adjust the color saturation of the screen image

◀ Reduce saturation    ▶ Increase saturation



### 4. TINT

Adjust the tone of the screen image

◀ Increase red tone    ▶ Increase green tone



### 5. SHARPNESS

◀ Reduce sharpness    ▶ Increase sharpness

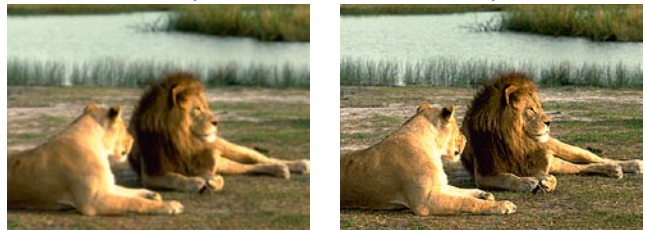



## 6. COLOR TEMPERATURE

Use ◀ ▶ to adjust the color temperature

- ◆ NEUTRAL General neutral setting
- ◆ WARM To increase the red tone of the display, obtain the white and more vivid red colors among warm ones.
- ◆ COOL To increase the blue tone of screen images, obtain the white color among soft colors. Generally suitable for offices with fluorescent lamps.

## 7. NOISE REDUCTION

Use ◀ ▶ to change on / off

- ◆ ON To reduce the Noise, regular do this action could help you to get the clear image.
- ◆ OFF Not reduce the source image. Keep original image situation.

eg: If the source image have the Noise interference, you could use ON to reduce the noise.



## 8. WIDE FORMAT =remote control key "WIDE"

Use ◀ ▶ to select items.

For TV, AV, COMP input source mode

- ◆ Stretch This mode is useful for 1.78:1 DVDs. When viewing 1.85:1 DVD, Stretch mode will still show very thin black bands at the top and bottom of the screen.

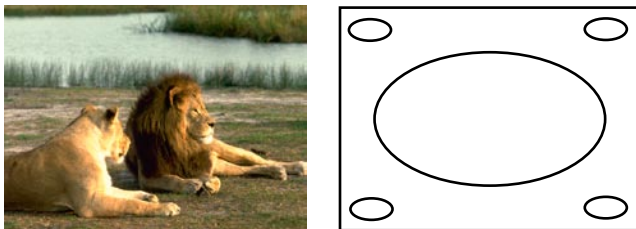

### ◆ Side Bar

Suitable for viewing conventional 4:3 programs in their normal format.

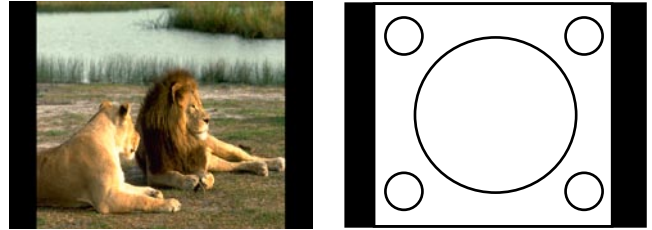

### ◆ S.Stretch

Suitable for stretching 4:3 programs to fill the screen (Smart - Stretch )

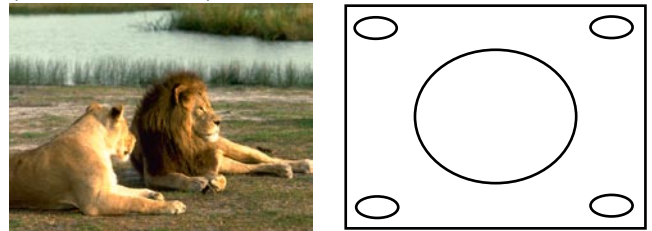

### ◆ Zoom

Suitable for viewing wide-screen 2.35:1 nongraphic DVD in full screen.

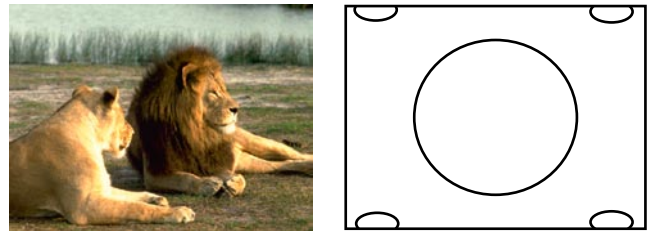

For RGB, DVI input source mode

- ◆ Normal Keeps the original aspect ratio in a full screen display.

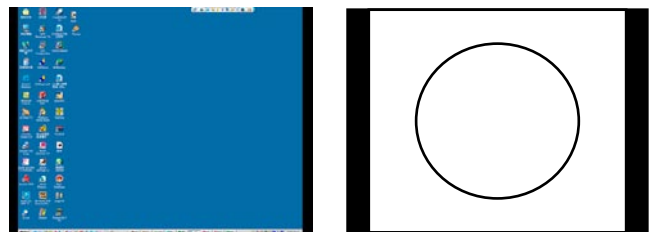

- ◆ Zoom Keeps the original aspect ratio in a full screen display. The top and bottom of the image is slightly cropped.

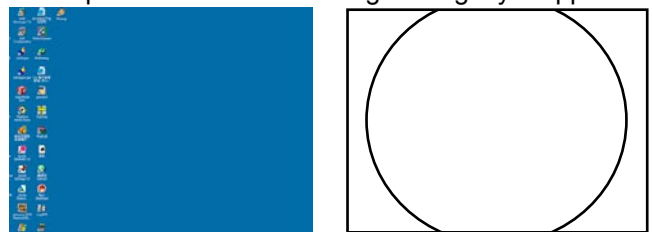



#### ◆ Stretch

An image fully fills the screen.

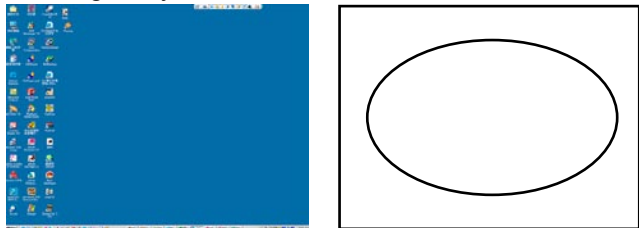

#### ◆ Dot by Dot

Detects the resolution of the signal and displays an image with the same number of pixels on the screen.

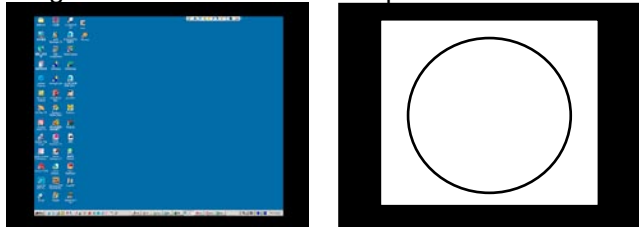

Notes:

- \* Wide Format is not available when using the POP, SPLIT functions.
- \* When you use 720p or 1080i signal input source. The screen will always keep STRETCH mode.

### 9. DEFAULT

Use ◀ ▶ to select ON or OFF.

▶ DEFAULT OFF

- ON Mean call the factory default setting for Picture Adjust.
- OFF Keep your picture adjust setting.

### 10.H POSITION

Use ◀ ▶ to change image Horizontal position.

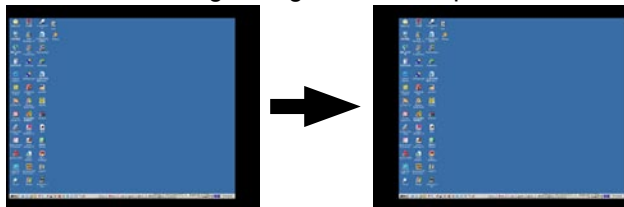

### 11.V POSITION

Use ◀ ▶ to change image Vertical position.



### 12.AUTO CONFIG

Press *ok* to auto get the input signal again.

### 13.ADC CLOCK

Use ◀ ▶ to change the clock value

Adjusting the image interference. When the screen shows interference caused by disturbing wave, please adjust the clock.

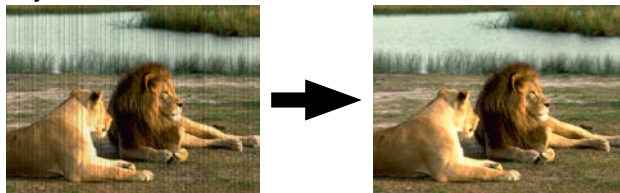

### 14.ADC PHASE

Adjusting Phase distortion of image in PC mode. When the screen shows flashing, ghost image or undulation, please adjust the phase.

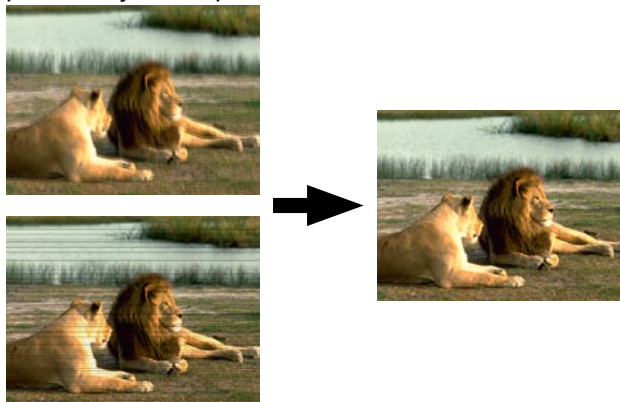

# PIP SETUP

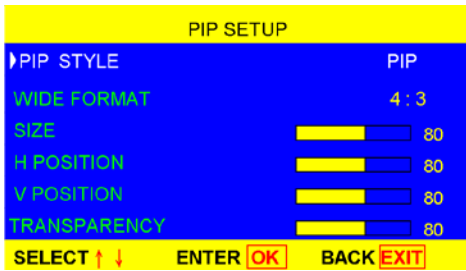

WIDE FORMAT, SIZE, H POSITION, V POSITION, TRANSPARENCY these function are only available for PIP STYLE. POP, SPLIT mode can't use.

## 1. PIP STYLE =remote control key "STYLE"

Use ◀ ▶ to select OFF, PIP, SPLIT, POP

◆ OFF

only display main picture, not display sub-picture.



◆ PIP

Display the sub-picture on the screen.

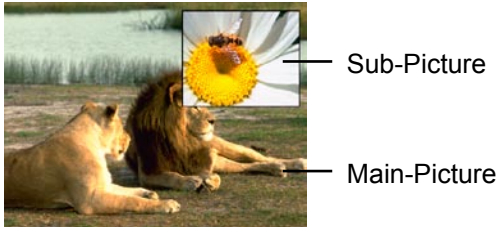

◆ SPLIT

The screen is divided in half.

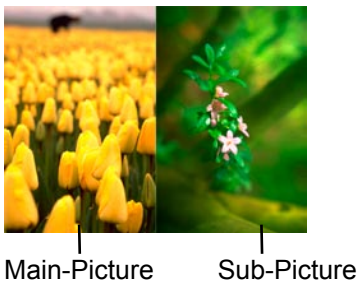

◆ POP

The screen is in the 16:9 mode and divided in half.

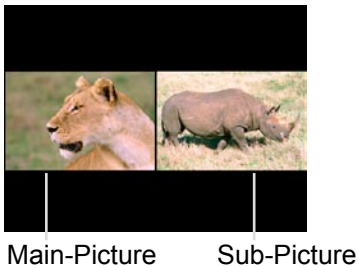

## 2. WIDE FORMAT (PIP, POP only) =remote control key "PIP WIDE"

Use ◀ ▶ to change sub-picture scale 4:3 or 16:9



PIP 4:3



PIP 16:9

## 3. SIZE (PIP only) =remote control key "- PIP SIZE +"

Use ◀ ▶ to change sub-picture size



## 4. H POSITION (PIP only) =remote control key "◀▶"

Use ◀ ▶ to adjust sub-picture horizontal position.



## 5. V POSITION (PIP only) =remote control key "▲▼"

Use ◀ ▶ to adjust sub-picture vertical position.



## 6. TRANSPARENCY

Use ◀ ▶ to change sub-picture transparency.







## INPUT SETUP



### 1.MAIN INPUT =remote control key "INPUT"

Press **OK** first, then use ◀ ▶ to change the Main picture input source signal. such as TV, FRONT RGB, RGB, DVI, AV1, AV2, FRONT AV, COMP1, COMP2

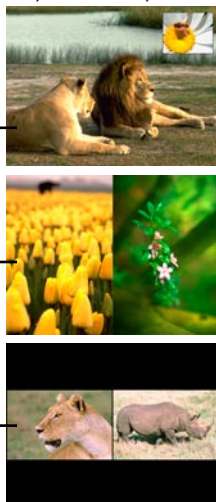

Change main picture's input signal source

### 2.PIP INPUT =remote control key "SOURCE"

Press **OK** first, then use ◀ ▶ to change the Main picture input source signal.

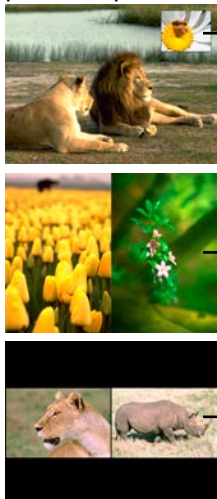

Change sub-picture's input signal source

### 3.INPUT SIGNAL

Press **OK** first, then use ◀ ▶ to change. When input source is 640\*480, you can use this function change it to 720\*480. (Only suitable for DVI , FRONT RGB, RGB mode)

## TV TUNER SETUP



### 1.CLOSE CAPTION

Use ◀ ▶ to ON or OFF the Cloase caption function. If your local TV system station not provide this service. This function will not work.

### 2.ANALOG TV SETUP



#### ◆ ANTENA / CABLE

Use ◀ ▶ to select the TV input source is from Antena or cable

#### ◆ CH SEARCH

Press **ok** to auto search the all channel. Sometimes the TV signal not stable, you need to use this function to reset the whole channel again.

#### ◆ CH MEMORY

To skip or add the channel that you designate. When you run the CH SEARCH 1~100%, then the TV will auto seach the whole channel to display. But some channel are blank , you could use this function to skip those blank channel or some channel you don't like. Then when you press the channel key It will skip those channel that you already define skiped.



eg: Use ◀ ▶ to add or skip channel no. 2.



and use ▲ ▼ to select which channel want to skip.

## 3.DIGITAL TV SETUP

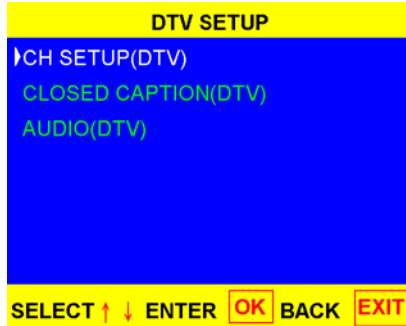

### ◆ CHANNEL SETUP(DTV)

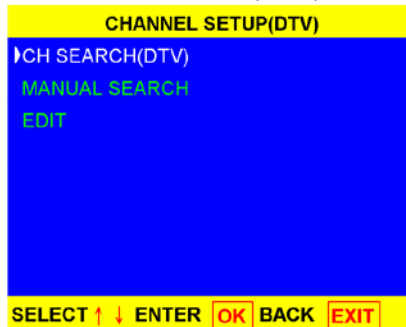

#### ●AUTO SEARCH(DTV)

Press **OK** to let machine auto search the whole channels.

#### ●MANUAL SEARCH

You could also search the channel by yourself. Just keyin the channel's no. then press **OK** to add that channel.

#### ●EDIT

Edit channel for parenthesis. Use this function to easy control the channel by menu.

### ◆ CLOSED CAPTION(DTV)

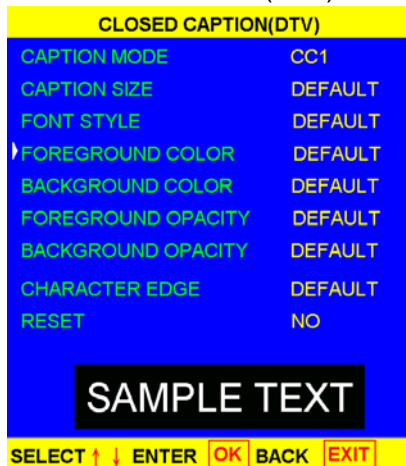

#### ●CAPTION SERVICE

Depend on the input signal are supported which services, like CC1, CC2, CC3, CC4, CS1, CS2, CS3, CS4, CS5, CS6.

#### ●CAPTION SIZE

Adjust caption size. Such as, Default, small, standard, larger.

#### ●FONT STYLE

Change font to different style. e.g.:

**SAMPLE TEXT**    **SAMPLE TEXT**

#### ●FOREGROUND COLOR

Change foreground color. e.g.:

**SAMPLE TEXT**    **SAMPLE TEXT**

#### ●FOREGROUND OPACITY

Change foreground opacity.

#### ●BACKGROUND COLOR

Change background color. e.g.:

**SAMPLE TEXT**    **SAMPLE TEXT**

#### ●BACKGROUND OPACITY

Change background opacity.

#### ●CHANGE EDGE

Change font's edge style. Such as, Default, None, Raised, Depressed, Uniform, LTshadow, RT shadow. e.g.:

**SAMPLE TEXT**    **SAMPLE TEXT**

#### ●RESET

Return to factory default setting value.

### ◆ AUDIO(DTV)

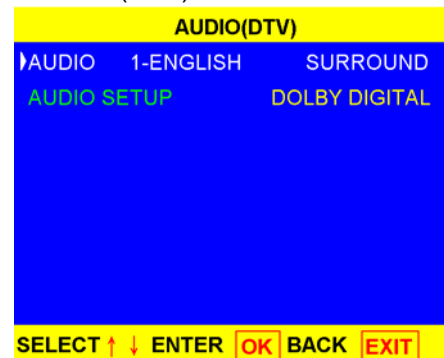

#### ●AUDIO

Use ◀▶ to select audio language ENGLISH, FRENCH, SPANISH.(depend on source)  
Use ▲▼ to change audio effect SURROUND, STEREO, MONO.

#### ●AUDIO SETUP

Press **OK**, then use ◀▶ to change audio output type DOLBY DIGITAL, PCM. You must setup another Sound expanding device to reveal this function.



## AUDIO ADJUST

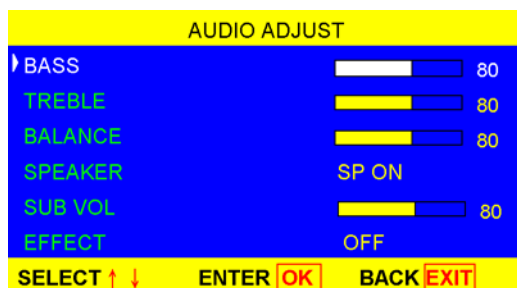

### 1. BASS

Use ◀▶ to adjust the ratio of Bass

### 2. TREBLE

Use ◀▶ to adjust the high-pitched sound

### 3. BALANCE

Use ◀▶ to adjust the balance level between left and right speakers.

### 4. SPEAKER

Use ◀▶ to select speaker on or off

SP ON: Audio from built-in speakers.

SP OFF: You can select speaker off to mute the audio.

When use another amplifier device, you may need to setup the speaker off.

### 5. SUB VOL

Use ◀▶ to adjust sub-picture's volume.

The RPTV audio will always sound main-picture's voice. You need to use Headphone or earphone to listen the sub-picture's voice and use this function to adjust the volume louder or lower.

### 6. EFFECT =remote control key "AUDIO"

Use ◀▶ to select audio effect mode.

#### ◆SRS = Sound Retrieval System

Based on the human hearing system; use the HRTF characteristics to compensate difference between traditional recordings. Extract the hidden environment sounds from the recording, and then process and recreate the original stereo sound. The display adapts the SRS technology, as well as the SRS Focus sound effect; this delivers displays with stereo that's broad and with vertical sound field.

#### ◆BBE

High Definition Sound

#### ◆VIVA HD3D

Replace traditional live sound stereo with more natural and clearer sound.

##### *Features:*

- Increase the horizontal sound field, depth, and vertical sound field while maintaining clear sense of directions.
- Highly stable central sound track
- Compatible with news channels, theatrical performances, movies, music, sports, and games. No audio mode switching is needed every time when you change programs

#### ◆SURROUND

#### ◆SIM STEREO

Dual channel simulated.

## PARENTAL CONTROL



The parental controls feature prevents viewers from watching programs that are not age-appropriate, such as programs containing violence or adult language. The factory default access code is 0000. Just use remote control key in the number to enter the parental controls sub-menu.

When enter the parental controls sub-menu. It will display the OSD as below:

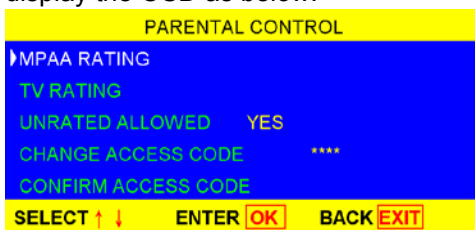

### 1.MPAA RATING

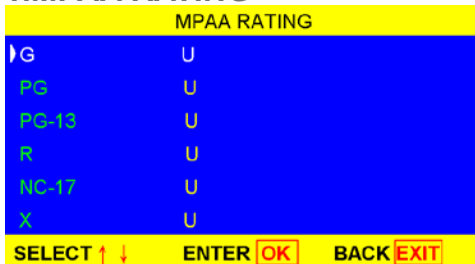

U -> Unblock , B -> Block

Use ▲ ▼ to select which rating you want to block or unblock, then press **ENTER** to block or unblock the current rating level.

- ◆ G → General audience
- ◆ PG → Parental guidance suggested
- ◆ PG-13 → Recommended for children 13 years of age and later
- ◆ R → Mature audience
- ◆ NC-17 → No one under 17 years of age
- ◆ X → No one under 17 years of age.

### 2.TV RATING

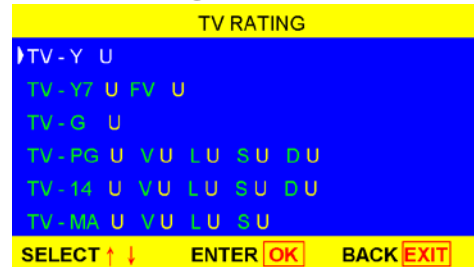

U -> Unblock , B -> Block

- ◆TV-Y → For all children.
- ◆TV-Y7 → For children of age 7 and above. FV means the program may include mild violence.
- ◆TV-G → For general audience. But most parents do not approve it for small children. program contains material that parents may find unsuitable for younger children.
- ◆TV-PG → Guodamce siggested.
- ◆TV-14 → Unsuitable for children under 14 year of age.
- ◆TV-MA → Mature Audience Only, unsuitable for children under 17.

TV-PG / TV-14 / TV-MA are further rated based on categories:

- V → Some violent scenes
- S → Some sex scenes
- L → Some obscene, adult language
- D → Some luring sexual dialogues

### 3.UNRATED ALLOWED

Decide if block the signal from the channel that does not contain rating information.

- YES → No, view the program
- NO → Block the channel

### 4.CHANGE ACCESS CODE

Change and set up new Parental Control password. Enter the 4 new digits and the set up will automatically proceed to the next line - CONFIRM ACCESS CODE

### 5.CONFIRM ACCESS CODE

Enter the 4 digits typed during CHANGE ACCESS CODE, press OK to confirm and the change is completed.



## SPECIAL FEATURE

SPECIAL FEATURE	
OSD H POSITION	80
OSD V POSITION	80
OSD TIMEOUT	80
LANGUAGE	ENGLISH
SYSTEM INFO	
RESET ALL SETTING	NO
RESET LAMP TIMER	NO
SLEEP TIMER	OFF
SELECT <b>↑ ↓</b> ENTER <b>[OK]</b> BACK <b>[EXIT]</b>	

### 1. OSD H POSITION

Use ◀▶ to move OSD horizontal position.

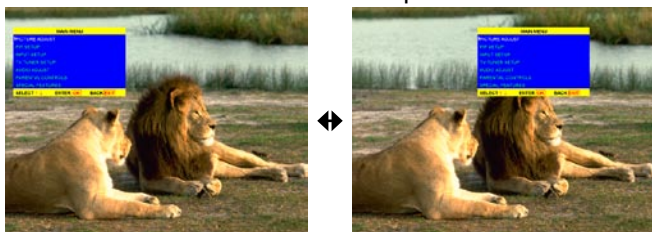

### 2. OSD V POSITION

Use ◀▶ to move OSD vertical position.

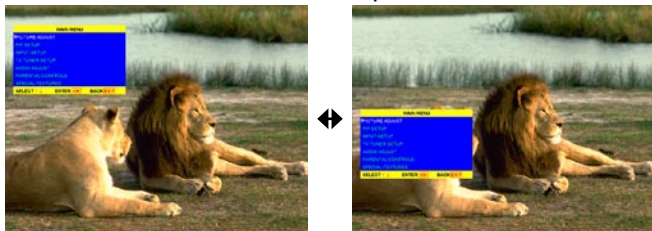

### 3. OSD TIMEOUT

Use ◀▶ to set up OSD display time, the value range is 15 seconds to 49 seconds.



After press the MENU key, the OSD will appear.



If the OSD TIMEOUT is set to 30 seconds, OSD screen will automatically disappear in 30 seconds if not any key is pressed.

### 4. LANGUAGE

Set OSD display language, there are three language options:

ENGLISH  
FRANÇAIS  
ESPAÑOL

### 5. SYSTEM INFO

Display some information about the display, may also be displayed by pressing the hotkey INFO on the remote control.

SYSTEM INFO	
MODEL NUMBER	XXXXXXXX
MAIN INPUT	TV
	CABLE CH 13
WIDE FORMAT	STRETCH
PIP INPUT	AV1
	CABLE CH 2
LAMP TIME	22 H
SOFTWARE VER.	XXX
BACK <b>[EXIT]</b>	

#### ◆ MODEL NUMBER

Show the display's model number

#### ◆ MAIN INPUT

Display the input signal of current main picture

#### ◆ WIDE FORMAT (MAIN)

Display main picture's aspect ratio (Refer to page 25)

#### ◆ PIP INPUT

Display the input signal of current main picture

#### ◆ LAMP TIME

Display the time the lamp has consumed.

#### ◆ SOFTWARE VERSION

Display the display's software version

### 6. RESET ALL SETTING

Select YES to return all OSD settings to the default values, the LAMP timer and OSD display language will not be affected. Select NO to stay unchanged.

### 7. RESET LAMP TIMER

Select YES to set the time lamp consumed to zero. Select NO to stay unchanged.

When installing a new lamp, be sure to set the LAMP TIMER to zero. This ensures correct display of the time consumed by the lamp.

### 8. SLEEP TIMER =remote control key "SLEEP"

Set up the time to turn off the display, works the same as the hotkey SLEEP on the remote control. The sleep timer will be reset to zero every time when the display restarts. If it is set to 30 minutes, this means in 30 minutes from the timer is set, the display will be turned off automatically. If the timer is set to OFF, the function will be disabled.

The TV device button has been preset to work with your RPTV TV (program code 0080). You can program the remote control to work with as many as seven other devices.

## To program the remote to control other devices:

- 1 Turn on the device.
- 2 Press the matching device button on the remote control.
- 3 Press and hold the **SETUP** button until the LED flashes twice.
- 4 Enter the programming code for the device and manufacturer. For a list of device programming codes, see "Device program codes" below. If the code is accepted, the LED flashes twice after the last digit is entered.

If the LED does not flash twice, repeat Steps 2 through 4 with the next code listed for the device and manufacturer.

### Important

If there more than one code listed for the device and manufacturer, make sure that you try all the codes listed to find the one that works for the device.

- 5 Point the remote control at the device and press the **POWER** button. The device should turn off.

### Tips & Tricks

If you cannot find your manufacturer in the device list or the program code does not work, you can use the remote control to search for the correct component code. See "Searching for device codes" on page 36.

## Device program codes

Use the codes in the following tables to program the remote control to work with your existing audio and video devices.

### Amplifier and tuner codes

Manufacturer	Program Code
Bose	0674
GE	0078
Harman/Kardon	0892
JVC	0331
Marantz	0892
Optimus	0395
Philips	0892

Manufacturer	Program Code
Polk Audio	0892
Realistic	0395
Sony	0689
Soundesign	0078
Victor	0331
Wards	0078
Yamaha	0354

### Cable set-top box codes

Manufacturer	Program Code
ABC	0003, 0017
Americast	0899
Bell South	0899
General Instrument	0276, 0476, 0810
Goldstar	0144
Hamlin	0009, 0273
Jerrold	0003, 0276, 0476, 0810
Memorex	0000
Motorola	1106
Pace	0237
Panasonic	0107, 0000
Paragon	0000

Manufacturer	Program Code
Philips	0305, 0317
Pioneer	0144, 0533, 0877
Pulsar	0000
Quasar	0000
Regal	0273, 0279
Runco	0000
Samsung	0144
Scientific Atlanta	0017, 0477, 0877
Starcom	0003
Toshiba	0000
Zenith	0000, 0525, 0899





## CD Player codes

Manufacturer	Program Code
Aiwa	0157
Burmester	0420
California Audio Labs	0029
Carver	0157, 0179
DKK	0000
Denon	0003, 0873
Emerson	0305
Fisher	0179
Garrard	0420
Genexxa	0032, 0305
Harman/Kardon	0157, 0173
Hitachi	0032
JVC	0072
Kenwood	0028, 0190, 0826, 0037, 0626, 0681
Krell	0157
LXI	0305
Linn	0157
MCS	0029
MTC	0420
Magnavox	0157, 0305
Marantz	0157, 0626, 0029
Mission	0157
NSM	0157
Onkyo	0101, 0868
Optimus	0032, 0468, 0420 0179, 0305, 1063, 0000, 0037, 0145

Manufacturer	Program Code
Parasound	0420
Philips	0157, 0626
Pioneer	0032, 0468, 0305, 1062, 1063
Polk Audio	0157
Proton	0157
QED	0157
Quasar	0029
RCA	0053, 0032, 1062, 0468, 0305, 0179
Realistic	0179, 0420
Rotel	0157, 0420
SAE	0157
Sansui	0157, 0305
Sanyo	0179
Scott	0305
Sears	0305
Sharp	0037, 0861
Sherwood	1067
Sonic Frontiers	0157
Sony	0000, 0490
Soundesign	0145
Tascam	0420
Teac	0420
Technics	0029
Victor	0072
Wards	0053, 0157
Panasonic	0029
Yamaha	0036, 0888

## Computer and Home automation codes

Manufacturer	Program Code
Gateway	1272
GE	0240
One For All	0167
Radio Shack	0240

Manufacturer	Program Code
Security System	0167
Universal X10	0167
X10	0167

## DVD Player codes

Manufacturer	Program Code
Apex	0672
Denon	0490
Fisher	0670
Gateway	0081
GE	0522
Gradiente	0651
Hitachi	0573, 0664
Hiteker	0672
JVC	0623, 0558
Kenwood	0682, 0534
Konka	0719, 0711, 0720, 0721
Magnavox	0503, 0675
Marantz	0539
Mitsubishi	0521
Onkyo	0503

Manufacturer	Program Code
Optimus	0571
Oritron	0651
Panasonic	0490, 0677, 0632
Philips	0539, 0503
Pioneer	0571, 0525, 0632
Proscan	0522
RCA	0522, 0571
Samsung	0573
Sharp	0630
Sony	0533
Technics	0490
Theta Digital	0571
Toshiba	0503
Yamaha	0490, 0545
Zenith	0591, 0503

## Receiver codes

Manufacturer	Program Code
ADC	0531
Aiwa	0121, 1405, 1089
Bose	0238, 0639, 1229 1253, 1355, 1356 1357
Capetronic	0531
Carver	1089, 1189
Denon	1160, 1104
Harman/Kardon	0110
JBL	0110
JVC	0074
Kenwood	1027, 0186, 1313 1569, 1570
MCS	0039
Magnavox	1089, 0531, 1189
Marantz	1189, 1089, 0039
Onkyo	0135
Optimus	1023, 0186, 0531, 0670

Manufacturer	Program Code
Panasonic	039, 1518
Philips	1089, 1189, 1269
Pioneer	0150, 0531, 0630 1023
Proscan	1254
Quasar	0039
RCA	1254, 0531, 1023
Sansui	1089
Sharp	0186
Sony	1158, 1058, 1258
Soundesign	0670
Sunfire	1313
Technics	0039, 1308, 1518, 1309
Thorens	1189
Victor	0074
Yamaha	0176, 0186, 1176





## Satellite set-top box codes

Manufacturer	Program Code
AlphaStar	0772
Chaparral	0216
Echostar	0775, 1005
Expressvu	0775
GE	0566
General Instrument	0869
HTS	0775
Hitachi	0819
Hughes Network Systems	0749, 1142, 1749
JVC	0775
Magnavox	0722, 0724
Memorex	0724
Mitsubishi	0749

Manufacturer	Program Code
Next Level	0869
Panasonic	0247, 0701
Philips	1076, 1142, 0722 0724, 0749
Proscan	0392
RCA	0566, 0392, 0143, 0855
Radio Shack	0869
Samsung	1109
Sony	0639
Star Choice	0869
Toshiba	0749, 0790
Uniden	0724, 0722
Zenith	0856

## TV codes

Manufacturer	Program Code
AOC	0019, 0030
Admiral	0093, 0463
Aiko	0092
Aiwa	0701
Akai	0030
Alaron	0179
America Action	0180
Anam	0180
Audiovox	0092, 0180, 0451, 0623
Baysonic	0180
Belcor	0019
Bell & Howell	0016, 0154
Bradford	0180
Brockwood	0019
Broksonic	0236, 0463
CXC	0180
Candle	0030, 0056
Carnivale	0030
Carver	0054
Celebrity	0000
Cineral	0451, 0092
Citizen	0056, 0030, 0060, 0092
Concerto	0056
Contec	0180
Craig	0180
Crosley	0180

Manufacturer	Program Code
Memorex	0179, 0463, 0178 0016, 0056, 0150 0154, 0250
Midland	0017, 0047, 0051
Mitsubishi	0150, 0178, 0019, 0093
Motorola	0093
Multitech	0180
NAD	0156, 0166, 0178
NEC	0030, 0019, 0056
NTC	0092
Nikko	0178, 0030, 0092
Onwa	0180
Optimus	0250, 0166, 0154
Optonica	0093
Orion	0463, 0179, 0236
Panasonic	0051, 0250
Penney	0047, 1347, 0060 0030, 0178, 0051 0019, 0056, 0156
Philco	0145, 0019, 0030 0054, 0463
Philips	0054
Pilot	0019, 0030
Pioneer	0166, 0679
Portland	0019, 0092
Princeton	0717
Prism	0051
Proscan	0047
Proton	0178
Pulsar	0017, 0019
Quasar	0051, 0250

Manufacturer	Program Code
Crown	0180
Curtis Mathes	0060, 0030, 0016, 0047 0051, 0054, 0056, 0093 0145, 0154, 0166, 0451 1147, 1347
Daewoo	0092, 0623, 0019 0624, 0451
Daytron	0019
Denon	0145
Dumont	0017, 0019
Electroband	0000
Emerson	0236, 0180, 0178 0179, 0463, 0624 0623, 0019, 0154
Envision	0030
Fisher	0154
Fujitsu	0179, 0683
Funai	0180, 0171, 0179
Futuretech	0180
Gateway	0072, 0080
GE	0047, 1347, 0051, 0093 0178, 0451, 1147
Gibraltar	0017, 0019, 0030
GoldStar	0178, 0019, 0030, 0056
Gradiente	0056, 0053
Grunpy	0179, 0180
Hallmark	0178
Harley Davidson	0179
Harman/Kardon	0054
Harvard	0180
Hitachi	0145, 0056, 0016
Infinity	0054
Inteq	0017
JBL	0054
JCB	0000
JVC	0053
KEC	0180
KTV	0180, 0030
Kenwood	0030, 0019
Konka	0707, 0632, 0628 0638, 0703
LG	0056
LXI	0154, 0047, 0054 0156, 0178
Lofik	0016

Manufacturer	Program Code
RCA	0047, 1347, 1147, 1047 0679, 1247, 0019, 1447 0051, 0090, 0093
Radio Shack	0180, 0030, 0178 0154, 0019, 0047 0056
Realistic	0180, 0154, 0030 0178, 0019, 0056
Runco	0017, 0030
SSS	0019, 0180
Sampo	0030
Samsung	0060, 0019, 0178 0030, 0056
Sansei	0451
Sansui	0463
Sanyo	0154
Scimitsu	0019
Scotch	0178
Scott	0236, 0019, 0178 0179, 0180
Sears	0154, 0056, 0156, 0047 0047, 0054, 0171, 0179
Semivox	0180
Semp	0156
Sharp	0093, 0688
Shogun	0019
Signature	0016
Sony	0000
Soundesign	0178, 0179, 0180
Squareview	0171
Starlite	0180
Supreme	0000
Sylvania	0054, 0030
Symphonic	0171, 0180
TMK	0056, 0178
TNCi	0017
Tandy	0093
Technics	0051, 0250
Technol Ace	0179
Techwood	0051, 0056
Teknika	0016, 0054, 0179 0180, 0019, 0092 0056, 0060, 0150
Telefunken	0056
Toshiba	0156, 0060, 0154, 1256
Vector Research	0030



Manufacturer	Program Code
Luxman	0056
MGA	0150, 0019, 0030, 0178
MTC	0060, 0030, 0019 0056
Magnavox	0054, 0030, 0179 1254
Majestic	0016
Marantz	0054, 0030
Matsushita	0250
Megatron	0145, 0178

Manufacturer	Program Code
Victor	0053
Vidikron	0054
Vidtech	0019, 0178
Wards	0054, 0178, 0016 0019, 0030, 0056 0179
Whit Westinghouse	0624, 0623, 0463
Yamaha	0019, 0030
Zenith	0017, 0624, 0016 0092, 0463

## VCR codes

Manufacturer	Program Code
Admiral	0048, 0209
Adventura	0000
Aiko	0278
Aiwa	0000, 0037
America Action	0278
American High	0035
Asha	0240
Audiovox	0037
Beaumarck	0240
Bell & Howell	0104
Broksonic	0121, 0184, 0002 0209, 0479
CCE	0072, 0278
Calix	0037
Canon	0035
Carver	0081
Cineral	0278
Citizen	0278, 0037
Colt	0072
Craig	0037, 0072, 0047, 0240
Curtis Mathes	0035, 0060, 0162
Cybernex	0240
Daewoo	0278, 0045
Denon	0042
Dynatech	0000
Electrohome	0037
Electrophonic	0037
Emerex	0032

Manufacturer	Program Code
Mitsubishi	0043, 0048, 0067
Motorola	0035, 0048
Multitech	0000, 0072
NEC	0038, 0067, 0104
Nikko	0037
Noblex	0240
Olympus	0035
Optimus	0162, 1062, 1162 0048, 1262, 0037 1048, 0104, 0432
Orion	0479, 0002, 0184, 0209
Panasonic	0035, 0162, 1162 1262, 1362, 0616 1062
Penney	0035, 0240, 0037 0042, 0038
Pentax	0042
Philco	0035, 0209, 0479
Philips	0081, 0035, 0618 1081, 1181
Pilot	0037
Pioneer	0067
Polk Audio	0081
Profitronic	0240
Proscan	0060
Protec	0072
Pulsar	0039
Quasar	0035, 0162, 1162
RCA	0060, 0149, 0042 0035, 0048, 0240
Radio Shack	0000, 1037
Radix	0037
Randex	0037
Realistic	0000, 0104, 0047 0048, 0037, 0035

Manufacturer	Program Code
Emerson	0184, 0002, 0209 0278, 0121, 0479 0000, 0037, 0043
Fisher	0047, 0104
Funai	0000
GE	0035, 0060, 0048, 0240
Garrard	0000
Go Video	0432
GoldStar	0037, 0038
Gradiente	0000
HI-Q	0047
Harley Davidson	0000
Harman/Kardon	0038, 0081
Harwood	0072
Hitachi	0042, 0000
Hughes Network Systems	0042
JVC	0067
KEC	0037, 0278
KLH	0072
Kenwood	0067, 0038
Kodak	0035, 0037
LXI	0037
Lloyd's	0000
Logik	0072
MEI	0035
MGA	0043, 0240
MGN Technology	0240
MTC	0000, 0240
Magnasonic	0278
Magnavox	0035, 0081, 0563 0000, 0039, 0149
Magnin	0240
Marantz	0081, 0035
Marta	0037
Matsushita	0035, 0162
Memorex	0104, 0047, 0479 0000, 0037, 0048 0035, 0240, 1037 0039, 0162, 0209 1162, 1262
Minolta	0042

Manufacturer	Program Code
Replay TV	0614, 0616
Runco	0039
Samsung	0045, 0240
Sanky	0039, 0048
Sansui	0479, 0000, 0067, 0209
Sanyo	0047, 0104, 0240
Scott	0184, 0121, 0043, 0045
Sears	0037, 0042, 0000 0035, 0047, 0104
Semp	0045
Sharp	0048
Shintom	0072
Shogun	0240
Singer	0072
Sony	0033, 0032, 0000 0035, 0636, 1032
Sylvania	0035, 0081, 0000, 0043
Symphonic	0000
TMK	0240
Teac	0000
Technics	0035, 0162
Teknika	0000, 0035, 0037
Thomas	0000
Tivo	0618, 0636
Toshiba	0045, 0043
Totevision	0037, 0240
Unitech	0240
Vector	0045
Vector Research	0038
Video Concepts	0045
Videosonic	0240
Wards	0035, 0060, 0000 0047, 0240, 0042 0048, 0072, 0081 0149
White Westinghouse	0072, 0278, 0209
XR-1000	0072, 0000, 0035
Yamaha	0038
Zenith	0039, 0000, 0033 0209, 0479



## Searching for device codes

If you cannot find your manufacturer in the device list or the program code does not work, you can use the remote control to search for the correct device code.

### To search for a device code:

- 1 Turn on the device.
- 2 Press the matching device button on the remote control.
- 3 Press and hold the **SETUP** button until the LED flashes twice.
- 4 Press **991**. The LED flashes twice.
- 5 Point the remote control at the device and alternate between pressing the **POWER** button and the device button on the remote control until the device turns off.

If the device still does not respond, clear the device button, then repeat the search procedure.

To clear the device button:

- 1 Make sure that the device is turned on.
- 2 Press and hold the **SETUP** button on the remote control until the LED flashes twice.
- 3 Press **992**, then press the device button on the remote control twice.

## Reassigning device buttons

You can reassign the device buttons on the remote control if you have more than one of the same type of device.

### *Example:*

If you are using the remote to control the cable (CBL), CD, DVD, TV, and two VCRs, you can reassign the satellite (STB) button as a second VCR(STB)button.

### To reassign device buttons:

- 1 Press and hold the **SETUP** button until the LED flashes twice.
- 2 Press **992**. The LED flashes twice.
- 3 Press the device button that you want (VCR) once, then press the device button that you are reassigning (STB) once. The (STB)button is now reassigned and can be programmed as a VCR device button. See “Programming the universal remote control” on page 29.

## Teaching the remote control new functions

The remote control can learn up to 25 additional functions from the device's original remote control.

### Example:

Your DVD player remote control has a scan function that you may use frequently. There is not a scan button on the remote control. You can assign a button and use the DVD remote to teach the remote control the scan function.

### Important

Make sure that you have already programmed the remote control for the device. See "Programming the universal remote control" on page 29.

Make sure that area lighting is not too bright or it will interfere with the learning process.

### To teach the remote control a new function:

- 1 Press and hold the SETUP button on the remote control until the LED flashes twice.
- 2 Press 975. The LED flashes twice.
- 3 Press the device button that you want (DVD) once.
- 4 Press the button that you are assigning the new function to. The LED flashes quickly while it is waiting to receive the signal from the teaching remote.
- 5 Hold the teaching remote control approximately 1-inch (2.54cm) from the remote control making sure that the infrared ports are lined up, then press the button on the teaching remote that you want the remote to learn. The LED flashes twice.
- 6 Press the SETUP button to exit learning mode.

## Using the universal remote control

Your RP TV features an on-screen display (OSD) that lets you adjust and save contrast, brightness, and other settings. The TV saves changes you make to the settings, even if you turn off the TV. See the documentation that came with your RP TV for more information about the OSD.

### To access the OSD with the universal remote control:

- 1 Press the **TV** device button.
- 2 Press the **MENU** button on the universal remote control. The MAIN MENU opens.

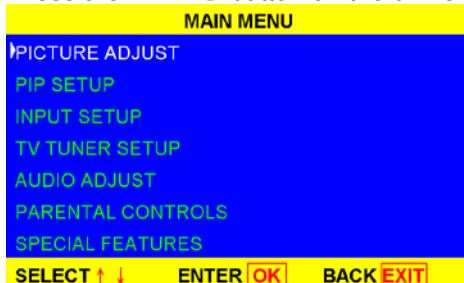

- 3 Press the ▲ and ▼ buttons to select the menu you want.
- 4 Press the ▲ and ▼ buttons to select the menu option you want.
- 5 Press the **OK** button to open the menu.
- 6 Press the ◀ and ▶ buttons to adjust the option settings.
- 7 Press the **EXIT** button to return to the MAIN MENU.
- 8 Press the **EXIT** button again. The MAIN MENU closes.



## Using picture-in-picture (PIP) mode

When the picture-in-picture (PIP) mode is active, one picture is displayed on the full screen (main picture) and the other picture is displayed in a small window (sub-picture).

### To control PIP mode using the universal remote control:

- 1 Press the **TV** device button.
- 2 Press the **PIP** button on the remote control once to turn on PIP mode. A small window appears in one corner of the screen. The picture on the full screen is the main picture. The picture in the window is the sub-picture.  
Press the **STYLE** button to select one of the other preset PIP modes. See the user guide that came with your RP TV for additional information.
- 3 Press the **POSITION** button one or more times to move the window to a different area of the screen.
- 4 Press the **SWAP** button to swap the main picture and the sub-picture.
- 5 Press any one of the direct input buttons (TV1, AV1, AV2, etc.) on the remote control to change the video input source for the main picture.
- 6 Press the **SOURCE** button on the remote control one or more times to change the video input source for the sub-picture.

Go to “Universal remote control buttons” on page 17 for information about the other buttons on the universal remote.

## Setting the sleep timer

The sleep timer lets you set a time when you want your RP TV to turn off automatically. One minute before the timer turns off your RP TV, the timer appears and shows the seconds remaining before your RP TV turns off.

You can set the sleep timer using the remote control or the OSD.

### To set the sleep timer using the universal remote control:

- 1 Press the **TV** device button.
- 2 Press the **SLEEP** button on the remote control. The sleep timer appears in the upper-left corner of your screen.
- 3 Press the **SLEEP** button one or more times to cycle through all the preset times.

### To turn off the sleep timer using the universal remote control:

Press the **SLEEP** button repeatedly until SLEEP: OFF appears.

# Troubleshooting

Use the following information to solve common problems.

## The LED doesn't blink when a button is pressed.

Replace the batteries.

Insert two AA batteries into the remote control. Make sure that you match the + and – on the batteries with the + and – symbols inside the battery compartment.



## The LED blinks when a device mode is pressed, but the device does not respond.

Make sure that you are less than 15 feet (4.57 meters) from the infrared remote sensors on the device.

Make sure that nothing is blocking the infrared remote sensors on the remote control or the device.

Make sure that you have selected the correct device mode.

Make sure that the remote is programmed for that device. See “Programming the universal remote control” on page 29.

## The remote control will not accept the device program code.

Make sure that you followed all the steps in the programming procedure. See “Programming the universal remote control” on page 29.

Make sure that you tried all the program codes listed for the device manufacturer. See “Device program codes” on page 29.

Search for the device code. See “Searching for device codes” on page 36.





## Video Input Format

Input Format	Aspect Ratio	Pixel Clock(MHz)	Horizontal Frequency(kHz)	Vertical Frequency(Hz)
480i 4:3	700x480	13.5MHz	15.734/1.001	30.0/1.001
480p 4:3 / SMPTE 293M	700x480	27.000	31.469/1.001	60/1.001
720p / SMPTE 296M	1280x720	74.25/1.001	45.0/1.001	60.0/1.001
1080i / SMPTE 274M	1290x1080i	74.25/1.001	33.750/1.001	30.0/1.001

## Default PC Input Mode

*The display automatically detects:*

1) Horizontal sync signal frequency between 30.0 ~ 60.0 kHz

2) Vertical sync signal frequency between 50 ~ 85 Hz.

But 60 Hz vertical sync input signal is recommended, for it will take the display longer to display the screen when other input signals are used.

The display supports resolution up to 1024 \* 768, the higher mapping ratio entered will be automatically changed to 1024\*768.

The display supports the general industry factory default modes as follows:

Resolution	Pixel Clock(MHz)	Horizontal		Vertical	
		Frequency +/- 0.5kHz	Sync Polarity	Frequency +/- 0.1 Hz	Sync Polarity
640x350 @70Hz	25.180	31.48	P		N
640x350 @85Hz	31.500	37.861	P	85.080	N
720x400 @70Hz	28.322	31.469	N	70.087	P
720x400 @85Hz	35.500	37.927	N	85.039	P
640x480 @60Hz	25.175	31.469	N	59.940	N
640x480 @72Hz	31.500	37.861	N	72.809	N
640x480 @75Hz	31.500	37.500	N	75.000	N
640x480 @85Hz	36.000	43.269	N	85.008	N
800x600 @56Hz	36.000	35.156	P	56.250	P
800x600 @60Hz	40.000	37.879	P	60.317	P
800x600 @72Hz	50.000	48.077	P	72.188	P
800x600 @75Hz	49.500	46.875	P	75.000	P
800x600 @85Hz	56.250	53.674	P	85.061	P
1024x768 @60Hz	65.000	48.363	N	60.004	N
1024x768 @70Hz	75.000	56.476	N	70.069	N
1024x768 @75Hz	78.750	60.023	P	75.029	P
1280x768 @60Hz	74.125	45.000	IV	59.940	IV

## Miscellaneous

When the range of the input signal frequency is beyond what the display accepts, the "OUT OF RANGE" message will appear. Please adjust the input signal frequency to an acceptable value.

### Plug & Play

The display confirms to VESA DDC1 and DDC2B standards

When connected to a DDC1 system, the display will sync with V.CLK based on VESA standards and output EDID to data routes.

When connected to a DDC2B system, the display will automatically switch to various communications.

Product Name	Multimedia digital projector display / TV		
	Main system		Remote Control
Power	AC 110V/220V 50 Hz / 60 Hz		3V (two AA batteries)
Power Consumption	220W		-----
Weight	40Kg		155.5g (including batteries)
Viewable Area	853 mm - Length	640 mm - Hight	1066 mm - Diagonal
Physical Dimensions	1381 mm - Length	482 mm - Hight	1113.5 mm - Diagonal
Speaker	2 circular ones, 120 mm		
Audio Output	Maximum output 10W + 10W (Total audio output 20W)		
Simulated RGB input	Video signal: D-SUB            15 pin RGB video signal connector Simulation:     0.7V (p-p)    75 Ohm Maximum dpi:   XGA (1024*768) Horizontal Sync: Positive / Negative TTL Frequency: 30KHz-70K HzVertical Sync: Positive / Negative TTL Frequency: 50Hz-85Hz		
	Audio Signal: 150mV (rms) over 47 thousand Ohms (AV Terminal)		
Number T. M. D. S	Video signal: Standard T.M.D.S DVI-D 24 Pin input Audio signal: 150mV (rms) over 47 thousand Ohm (AV Terminal)		
Headphone	3.5 mm diameter stereo connector Resistance larger than 20 Ohm		
TV System	Standard NTSC 181 CH or PAL system		
Received Channels	Regular TV (VHF: 2-13 UHF:14-69) Cable TV (2-125)		
Image output / input terminals(video, audio)	S-Video: Y output / input : 1V (p-p)        75 Ohm Negative Sync C output / input : 0.286V (p-p)   75 Ohm Color Sync		
	Video:            1V (p-p)        75 Ohm Negative Sync (AV Terminal)		
	Audio:            150 mV (rms) over 47 thousand Ohms (AV Terminal)		
Component Input	Image: Y input : 1V (p-p)        Negative Sync (AV Terminal) Pb / Cb, Pr / Cr input: 0.35V (p-p) (AV Terminal)		
	Audio: 150 mV (rms) over 47 thousand Ohms (AV Terminal)		

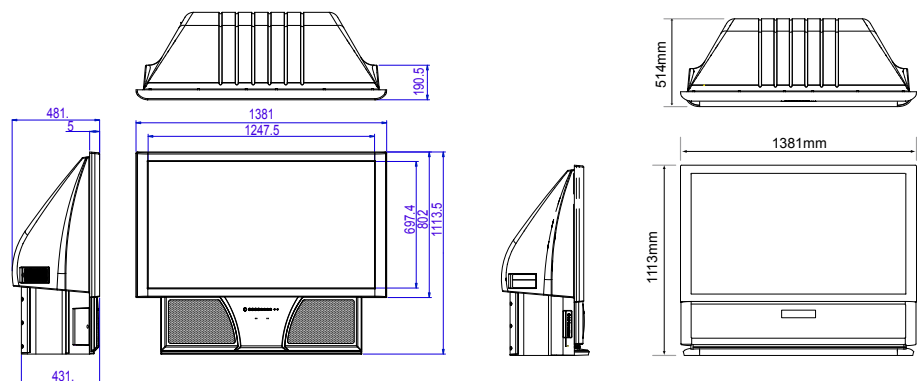

The product outlook and dimensions

For the graphic design and technical specifications, in order to improve the products, our company reserves the right of modifications and no further notice on this will be issued.

The display's model number does not represent the screen dimension but the approximate diagonal size of the display area.

Use with a lightning protector when using the display is recommended.



Sometime the set up problems or other reasons will result in the false impression of display malfunctions. Please check before sent for repair:

## If following situations

## Please check the following items

Power LED does not light



- \* If the power plug was disconnected or loose?
- \* If the fuse or electricity outlet are not working?

No image

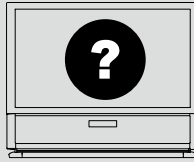

- \* Make the antenna is in place or it is loose?
- \* The power is on?
- \* To check the image input signal source settings is correct or not? (see page 13-15, 24)
- \* Check the TV analog/digital setup mode is correct or not? (see page 24~25)
- \* If the TV station or cable TV system is not in service?
- \* If the PC connected to the display is powered on?
- \* Try pressing the keyboard or mouse of the connected computer?
- \* Check if the video cable is connected correctly (If some PC needs to use external adapter?)?
- \* Check if the connected computer 's video adapter is completely plugged into correct expansion slot?
- \* Check if the frequency range of the input signal is beyond the display's acceptable rage (If over the range, "Out of Range" will appear)
- \* The display supports plug and play, but if for some reason the PC couldn't find the display's driver, please change the PC's display settings manually and set the screen display to XGA 1024\*768 or Super VGA 800\*600.

The remote does not work



- \* If the batteries are dead?
- \* If the batteries are placed upside down?
- \* If too far from the reception area, if the angle is too big, if there is strong light blinking in reception area (please remove the strong light) or if there is obstacles in between?

Delays for video and audio outputs



- \* If the monitor is warming up (The POWER led on display's control panel will be orange and blinking)?
- \* To protect the lamp, after turn off the power, you should wait to turn on the display again after 60 seconds.

Dim image



- \* If the color and color tone settings are inappropriate?
- \* If the projector lamp is dead, please change the lamp.

Blurry image



- \* When using the system, there might be water condensing inside the display when the environment changes from cold to warm, or from dry to wet. Please power off the system and restart after the water vapors.
- \* Please adjust the display's video phase or clock.

Overlapped image



- \* It might come from the electrical interference caused by buildings, airplanes, and hills, please adjust the antenna position
- \* It might be the interference by bad signal cable, try another cable.

Strips on the screen



- \* It might come from the electrical interference caused by the composite electrical signal created by computer, other TVs, TV video game system, VCR, radio station. Please adjust the positions of those objects or the anetnna.

Snowflake on the screen or noise interference

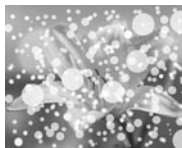

- \* If the antenna has changed direction, loose or damaged?

Spots on the screen



- \* This may caused by the electronic interference from automobiles or motorcycles, hair dryer, high voltage power lines or neon light.

Clear image but no sound



- \* Please press the "Mute" key on the remote control.
- \* Check if the audio cable is installed correctly
- \* Check if the Internal Speakers is set to Off, refer to page 26.

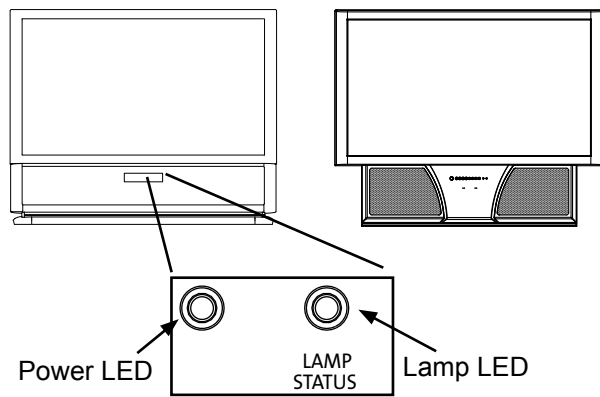

There are two status LEDs on the front of your Micro Chip Display Projection RP TV. You may obtain the display's related status through the LED in the front panel. Their meanings are explained as follows:

## Normal Operation

States	Power LED	Lamp LED	Status Description
AC off	Not lit	Not lit	AC power not connected
Standby mode	Orange	Not lit	AC power is connected and your RPTV is in standby mode.
Warm-up/Cool down	Blue	Flashing	AC power is connected and the power button has just been turned on or off.
Operation mode	Blue	Not lit	AC power is connected, the power button has been pressed, and the lamp has warmed up

## Error Codes

States	Power LED	Lamp LED	Status Description
21	Flashes blue twice, then orange once	Not lit	One of the cooling fans has failed. Call Service Center to help you solve the question.
32	Flashes blue three times, then orange twice.	Flashing	Lamp trouble or failure. Your RPTV automatically shut down and restart itself. If this does not solve the problem, Call Service Center to help you solve the question.
52	Flashes blue five times, then orange twice.	Flashing	Hardware error. Shut off your RPTV, wait one minute, then restart your RPTV. If this does not solve the problem, Call Service Center to help you solve the question.



## Service Information

If troubleshooting information does not resolve your problem or if you have other questions relating to your Micro Chip Display Projection, visit [www.vivitek.us](http://www.vivitek.us). You can also call our **Service Center**.

## Announcement

All Rights Reserved.  
Vivitek Corp  
48017 Fremont Blvd.  
Fremont, CA 94538

All Rights Reserved

This publication is protected by copyright and all rights are reserved. No part of it may be reproduced or transmitted by any means or in any form, without prior consent in writing from Vivitek.

The information in this manual has been carefully checked and is believed to be accurate. However, changes are made periodically. These changes are incorporated in newer publication editions. Vivitek may improve and/or change products described in this publication at any time. Due to continuing system improvements, Vivitek is not responsible for inaccurate information which may appear in this manual. For the latest product updates, consult the Vivitek Web site at [www.vivitek.us](http://www.vivitek.us). In no event will Vivitek be liable for direct, indirect, special, exemplary, incidental, or consequential damages resulting from any defect or omission in this manual, even if advised of the possibility of such damages.

In the interest of continued product development, Vivitek reserves the right to make improvements in this manual and the products it describes at any time, without notices or obligation.





[www.vivitek.us](http://www.vivitek.us)

Vivitek Corp.

48017 Fremont Blvd.

Fremont, CA 94538

Tel: (510) 651-0881

Efax: (510) 226-4163



© 2005 Vivitek Copyrights

## Free Manuals Download Website

<http://myh66.com>

<http://usermanuals.us>

<http://www.somanuals.com>

<http://www.4manuals.cc>

<http://www.manual-lib.com>

<http://www.404manual.com>

<http://www.luxmanual.com>

<http://aubethermostatmanual.com>

Golf course search by state

<http://golfingnear.com>

Email search by domain

<http://emailbydomain.com>

Auto manuals search

<http://auto.somanuals.com>

TV manuals search

<http://tv.somanuals.com>