

Vandal-proof · Tamper Detection · PoE
NETWORK CAMERA

Quick Installation Guide

English | 繁體中文 | 簡體中文 | 日本語 | Français | Español | Deutsch | Português | Italiano | Türkçe | Polski | Русский | Češky | Svenska | العربية



FD7130

This guide describes the basic functions of FD7130
All detailed information is described in the user's manual.



Warning Before Installation

- Power off the Network Camera as soon as smoke or unusual odors are detected.



Contact your distributor in the event of occurrence.

- Keep the Network Camera away from water. If the Network Camera becomes wet, power off immediately.



Contact your distributor in the event of occurrence.

- Do not place the Network Camera around heat sources, such as a television or oven.

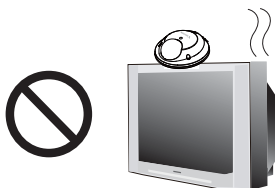

- Refer to your user's manual for the operating temperature.

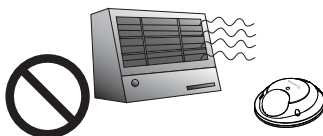

- Keep the Network Camera away from direct sunlight.

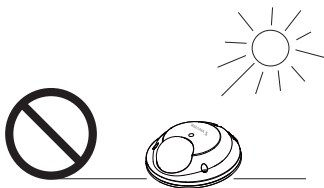

- Do not place the Network Camera in high humidity environments.

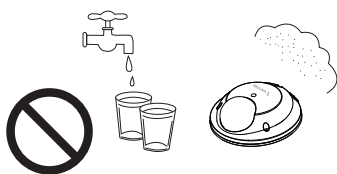

● Do not place the Network Camera on unsteady surfaces.



● Do not touch the Network Camera during a lightning storm.

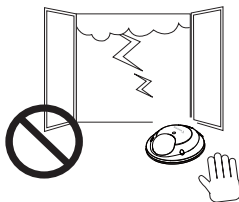

● Do not disassemble the Network Camera.

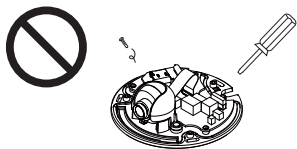

● Do not drop the Network Camera.

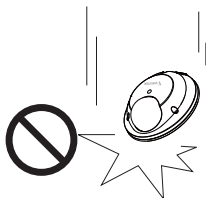

● Do not insert sharp or tiny objects into the Network Camera.

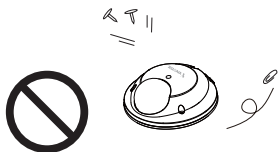

1 Package Contents

- FD7130 with an RJ45 or M12 Cable

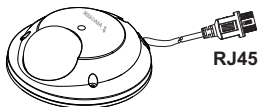

- Liquid Tight Connectors for RJ45 or M12 Cable

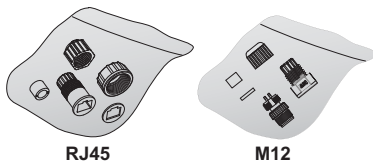

- Software CD



- Alignment Sticker

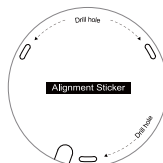

- Quick Installation Guide / Warranty Card



- Ground Wire / Screws

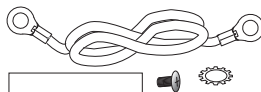

- Screwdriver

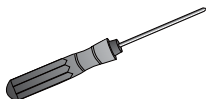

- Silica Gel



2 Physical Description

Inner View

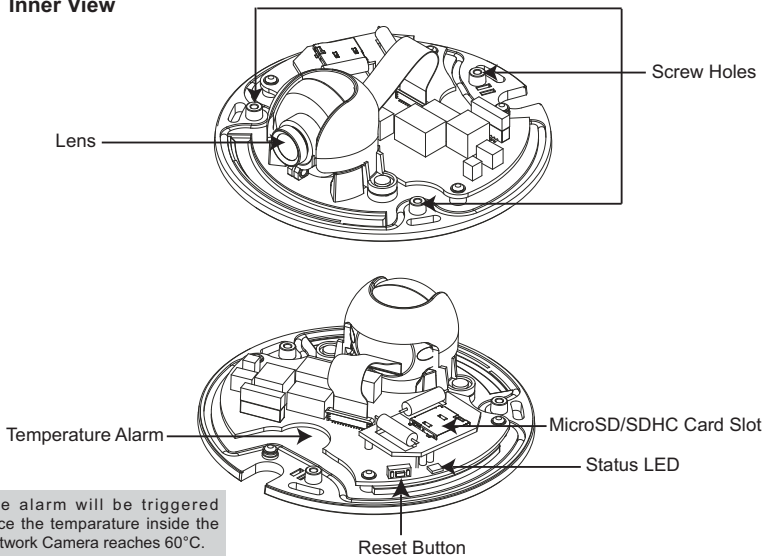

Outer View

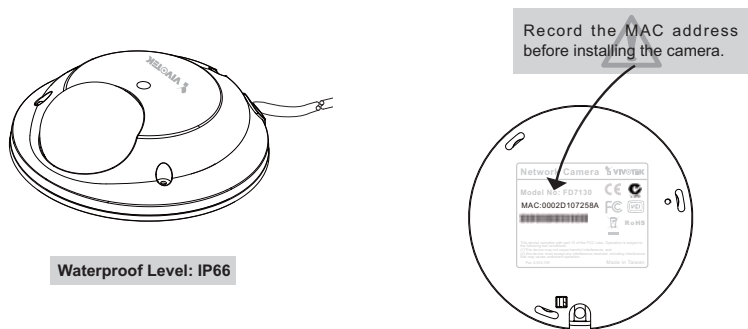

3

Cabling Assembly

RJ45 Cable Connector

● RJ45 Cable Dimension (unit: mm)

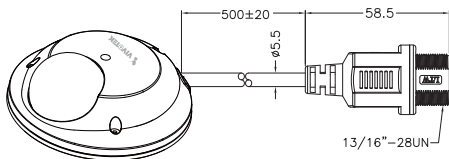

● Components of the Waterproof Connector

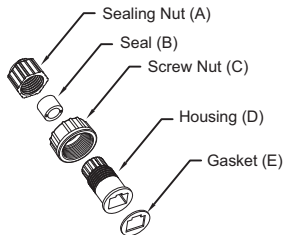

● Assembling Steps

- 1** Prepare an Ethernet cable and strip part of the sheath.

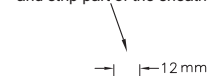

Recommended cable gauge: 24AWG (0.51 mm)

- 2** Insert the housing into the screw nut.

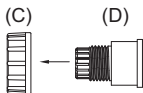

- 3** Insert the seal into the housing.

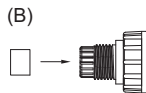

- 4** Insert the stripped Ethernet cable through the sealing nut and the housing.

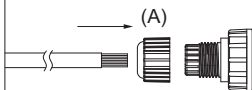

- 5** Clamp the cable with an RJ45 plug.

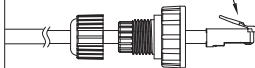

- 6** Push the RJ45 plug into the housing, then secure the sealing nut tightly.

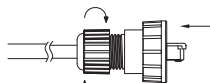

- 7** Attach the gasket to the front of the housing.

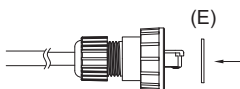

- 8** Connect the Ethernet cable to the RJ45 cable and secure the connectors tightly.

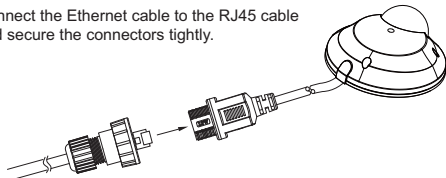

M12 Cable Connector

M12 Cable Dimension (unit: mm)

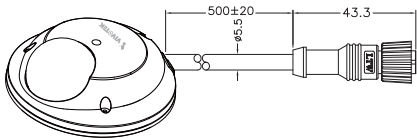

Components of the Waterproof Connector

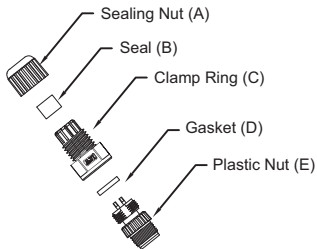

Assembling Steps

- 1** Prepare an Ethernet cable and strip part of the sheath.

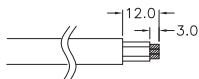

- 2** Insert the seal into the clamp ring.

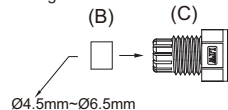

- 3** Insert the gasket into the clamp ring.

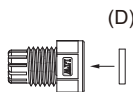

- 4** Insert the stripped Ethernet cable through the sealing nut and the clamp ring.

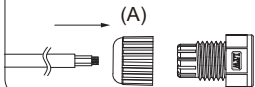

- 5** Follow the pin definition in the below table to solder the stripped Ethernet cable to the plastic nut.

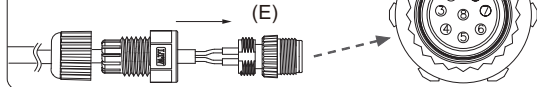

- 6** Secure the sealing nut to the clamp ring tightly.

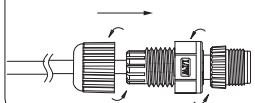

- 7** Follow the pin definition in the below table to connect the Ethernet cable to the M12 cable and secure them tightly.

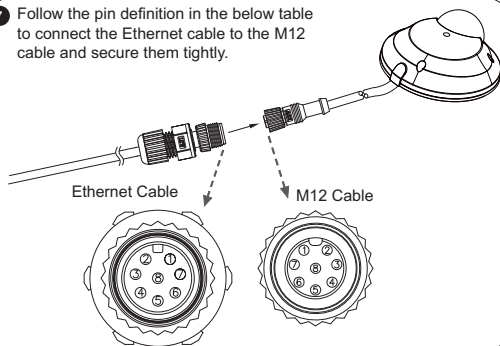

Ethernet Cable / M12 Cable	Wire Color
1	Orange/White
2	Orange
3	Green/White
4	Blue
5	Blue/White
6	Brown/White
7	Brown
8	Green

4 Hardware Installation

First, use the supplied screwdriver to detach the dome cover from the camera base. Insert your MicroSD/SDHC Card if necessary.

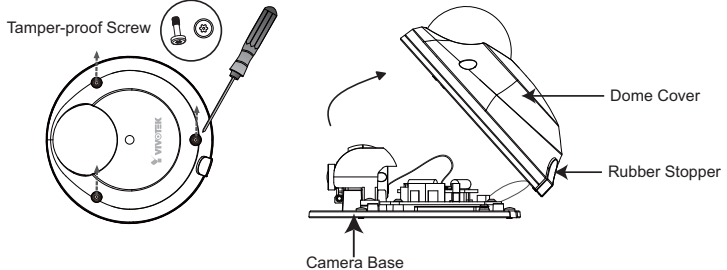

Then, follow the steps below to install the camera to either the ceiling or the wall:

1. Attach the supplied alignment sticker to the ceiling/wall.
2. Using the 3 screw circles on the sticker, drill 3 pilot holes into the ceiling/wall. Then hammer the plastic anchors into the holes.
3. This Network Camera can be mounted with the cable routed through the camera base or from the side of the dome cover. If you want to feed the cable through the ceiling/wall, please also cut or drill a hole (A) for the cable. If the cable goes through the side of the dome cover, please remove the rubber stopper (B).
4. Through the 3 holes on the camera base, insert the screws to corresponding holes and secure the camera base with a screwdriver.

Ceiling Mount

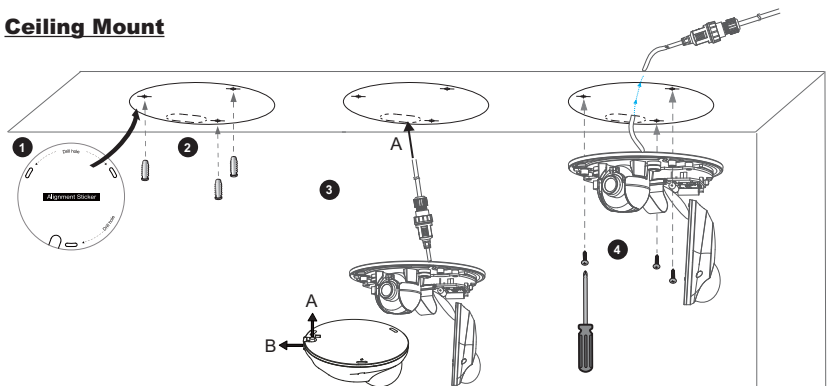

Wall Mount

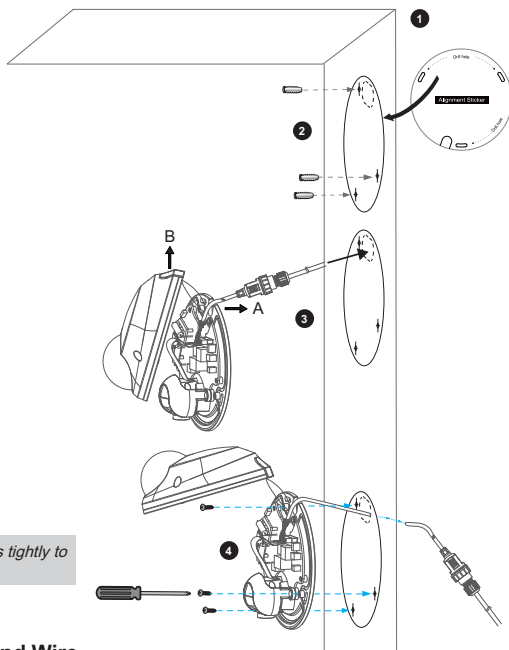

Please secure the screws tightly to avoid moisture. 

Installing the Ground Wire

As shown in the following figure, please secure one side of the supplied ground wire to the screw hole, then route the other side of the ground wire to the ground.

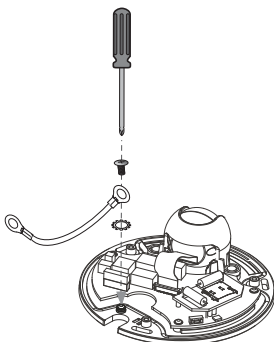

5 Network Deployment

Power over Ethernet (PoE)

● When using a PoE-enabled switch

This Network Camera is PoE-compliant, allowing transmission of power and data via a single Ethernet cable. Follow the below illustration to connect the camera to a PoE-enabled switch via Ethernet cable.

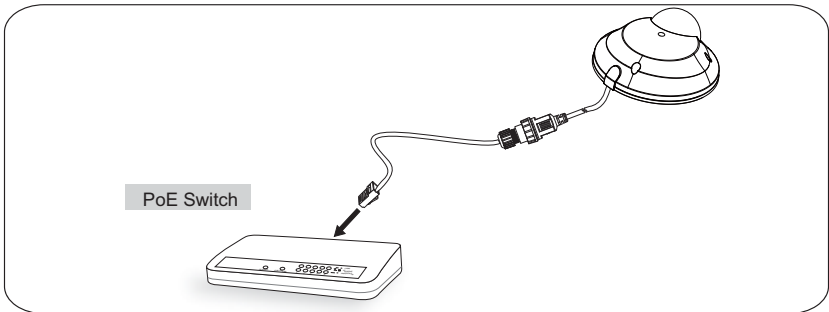

● When using a non-PoE switch

Use a PoE power injector (optional) to connect between the Network Camera and a non-PoE switch.

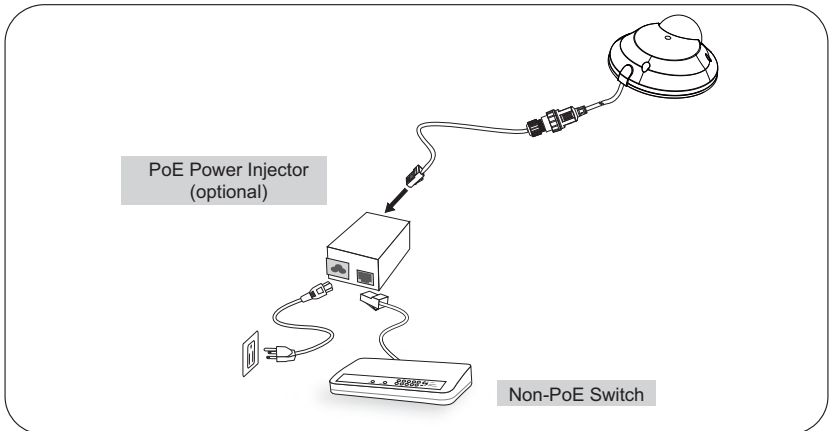

6 Assigning an IP Address

1. Install "Installation Wizard 2" from the Software Utility directory on the software CD.
2. The program will conduct an analysis of your network environment. After your network is analyzed, please click on the "Next" button to continue the program.



3. The program will search for VIVOTEK Video Receivers, Video Servers, and Network Cameras on the same LAN.
4. After searching, the main installer window will pop up. Click on the MAC that matches the one labeled on the bottom of your device to connect to the Network Camera via Internet Explorer.

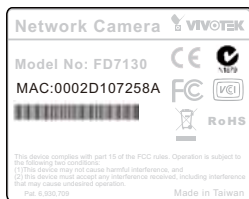

7 Ready to Use

1. Access the Network Camera on the LAN.
2. Retrieve live video through a web browser or recording software.

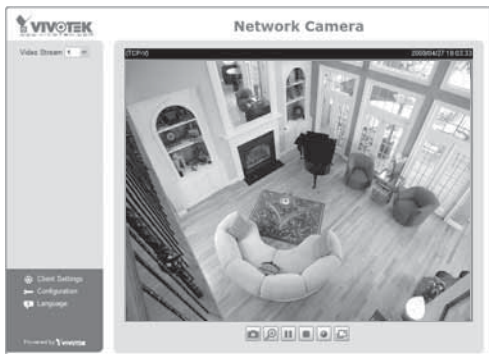

For further setup, please refer to the user's manual on the software CD.

8 Adjusting the Lens

To adjust the viewing angle

Adjust the lens to a desired viewing angle as the diagram shown below.

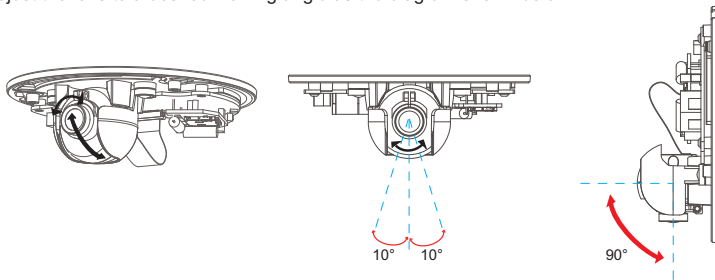

DO NOT over rotate the lens. Doing so will damage the camera lens module.

Fine-tune the Camera Focus

The focus of this network camera is set from 1.0m to infinity by factory default. If you want to focus on objects closer than 1.0m or the lens has lost focus, please fine tune it in the following way.

1. Loosen the lens lock screw.
2. Manually rotate the lens to fine-tune the focus until the live image is clear.
3. Tighten the lens lock screw.

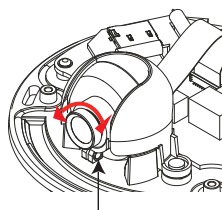

Tighten the lens lock screw.

9

Completion

Tear down the aluminum foil vacuum bag and take out the silica gel. Attach the supplied silica gel to the inner side of the Network Camera. (Please replace the silica gel with a new one if you open the back cover after installation.)

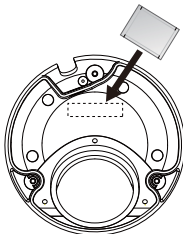

Attach the dome cover to camera. Secure the dome screws with the supplied screwdriver. Finally, make sure all parts of the camera are securely installed.

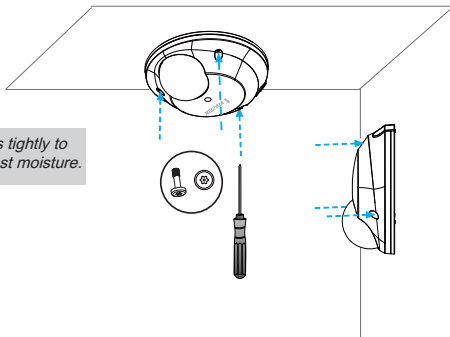

Please secure the screws tightly to prevent the cabling against moisture.



P/N: 625008801G Ver.1.1

Copyright © 2009 VIVOTEK INC. All right reserved.

Download from www.Somanuals.com. All Manuals Search And Download.

6F, No.192, Lien-Cheng Rd., Chung-Ho, Taipei County, Taiwan | T: +886 2 82455282 | F: +886 2 82455532 | E: sales@vivotek.com

Free Manuals Download Website

<http://myh66.com>

<http://usermanuals.us>

<http://www.somanuals.com>

<http://www.4manuals.cc>

<http://www.manual-lib.com>

<http://www.404manual.com>

<http://www.luxmanual.com>

<http://aubethermostatmanual.com>

Golf course search by state

<http://golfingnear.com>

Email search by domain

<http://emailbydomain.com>

Auto manuals search

<http://auto.somanuals.com>

TV manuals search

<http://tv.somanuals.com>