



INTERCOM SYSTEM

CPU-55

Functions and Operating Instructions



TOA ELECTRIC CO, LTD.
KOBE, JAPAN

Part names and functions on the station keyboard

Volume switch
Adjusts the volume of the station speaker.

In-use Lamp
Lights up when the station is on line with another station.

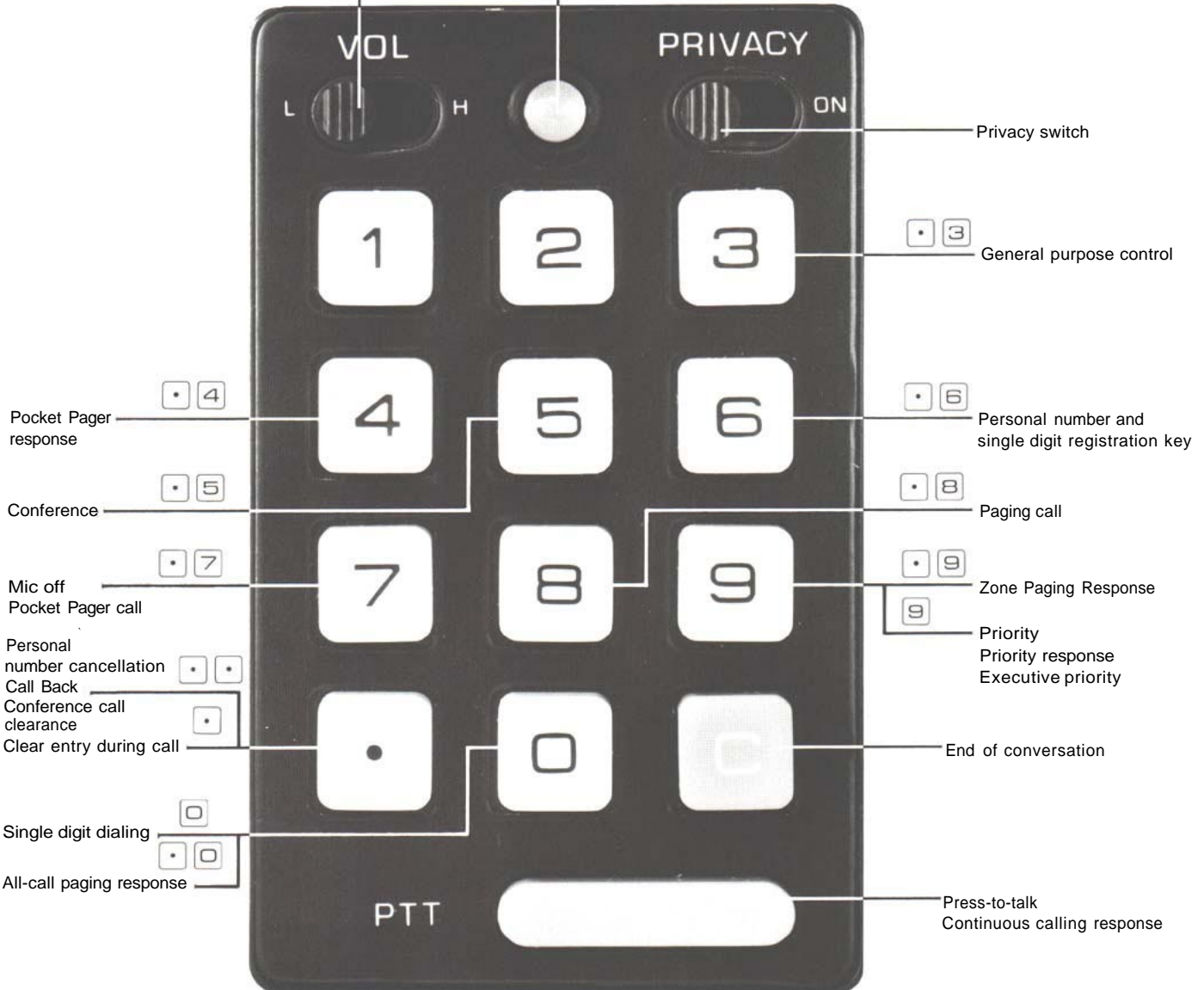

*The station number consists of from 200~ or 20~.

Function of the EXES-5000 CPU-55













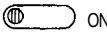
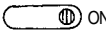
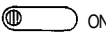







No.	Function	Fixed Function	Selective Function *1	Programmed function at No.200 *2	Optional Function (Required units)	Page No.		
1	Automatic line release	<input type="radio"/>				6		
2	Camp-on-busy	<input type="radio"/>				6		
3	Privacy	<input type="radio"/>				6		
4	Camp-on-privacy	<input type="radio"/>				7		
5	Press-to-talk (PTT)	<input type="radio"/>				7		
6	Mic off	<input type="radio"/>				7		
7	Personal number call	<input type="radio"/>				8		
8	Single digit dialing	<input type="radio"/>				9		
9	Master Sub relationship			<input type="radio"/>		10		
10	Secretary transfer			<input type="radio"/>		11		
11	Call transfer		<input type="radio"/>			12		
12	Priority		<input type="radio"/>			13		
13	Executive priority		<input type="radio"/>	<input type="radio"/>		13		
14	Continuous calling tone		<input type="radio"/>	<input type="radio"/>		14		
15	Talk back				Talk back unit TKU-11	14		
16	Conference		<input type="radio"/>		Conference unit CLU-52	15		
17	Selectable calling tone duration		<input type="radio"/>			16		
18	Selectable paging pre-announcement tone duration		<input type="radio"/>			16		
19	External PA paging		<input type="radio"/>		Paging interface unit PIU-52A	16		
20	Station paging		<input type="radio"/>			16		
21	All-call plus 7 individual zone paging and response		<input type="radio"/>	<input type="radio"/>		19		
22	All-call plus 15 individual zone paging and response		<input type="radio"/>	<input type="radio"/>		19		
23	10-combination zone paging and response		<input type="radio"/>	<input type="radio"/>		20		
24	Emergency all-call paging		<input type="radio"/>			21		
25	Paging priority		<input type="radio"/>	<input type="radio"/>		22		
26	2-digit dialing		<input type="radio"/>			23		
27	Programmable station numbering		<input type="radio"/>	<input type="radio"/>		24		
28	Group blocking		<input type="radio"/>	<input type="radio"/>		25		
29	Programmable restricted access for stations	All-call paging		<input type="radio"/>	<input type="radio"/>	PIU-52A	26	
		Conference		<input type="radio"/>	<input type="radio"/>	CLU-52		
		General purpose control	One-shot make output (mode 1)		<input type="radio"/>	<input type="radio"/>		Data Transmitting Unit DT-E11
			Make/break output (mode 2)			<input type="radio"/>		
			8 selectable output and/or decimal output (mode 3)			<input type="radio"/>		
4 Decimal digits output (mode 4)			<input type="radio"/>					
			<input type="radio"/>	Data Receiving Unit DR-B61				
30	Data transmitting/receiving units (Display board and interface)	In/out annunciation				27		
31		Calling party Indication				27		
32		Pocket pager call and response		<input type="radio"/>		28		
33		General purpose control		<input type="radio"/>		29		

Note:

*1 Selective functions may be selected by means of function switches on CPU-55 unit.

*2 Programmed functions may be programmed at master station No.200.

Summary of Dial Operations

Classification	Function	Dial operation	Number	Description
Call	Press-to-talk	PTT 		Conversation is simplex when PTT bar is used.
	Continuous calling tone	PTT 		Called party so programmed touches PTT bar, then Hands-free conversation may begin.
	Privacy	PRIVACY  ON Privacy off  ON		When a party does not wish to accept incoming calls, set the Privacy Switch in the ON position.
	Secretary transfer	PRIVACY  ON Secretary transfer off  ON		This function allows for automatic transfer of calls to a secretary when desired.
	Single digit registration	 (PTT) Registration dials (maximum 4 digits)		This function allows for single digit registration of up to 4 digits among the numbers 0 through 9 and the  key.
	Single digit dialing			Registered dial code may be automatically dialed.
	Personal number registration	 Confirmation tone	1 X X X : 1000 ~ 1499	Personal members may be registered at any master station which the person to whom the number is assigned expects to be. When anyone having a personal number leaves the office, he merely cancels the programming of his personal number.
	Personal number cancellation	 Confirmation tone		
	Personal number call			
	Confernce	 Calling  Calling	X X X : station no., personal no., single digit number	A conference call may be made with up to 4 persons. Participants must be called individually.
	Conference clear			If a person called into a conference is absent, the conference may be returned to the original condition.
	Mic off			This function is used to temporarily hold a conversation, causing a holding tone to sound at both stations. The line is thus kept open until the party who operates the mic off switch re-dials and the call is continued.
	Priority/priority response	 Busy tone  ⇒ Station called 	X X X : station no., personal no., single digit number	When the called party is busy, this function signals to request priority. The party requesting can talk after the called party responds.
	Executive priority	 Busy tone 		
	Call transfer	 Call conversation ⇌  Transfer ⇌  Conversation with original station	X X X : station no., personal no., single digit number	The called party can transfer the call to a selected other station (by station number, personal number or single digit number).
Camp-on-busy Camp-on-privacy	Not necessary to re-dial even if station call is busy.			When the party called is on the line or when his station is in the privacy mode, the call is held and is automatically put through as soon as the line is open.

Classification	Function	Dial operation	Number	Description
Paging	All-call plus 7-zone paging	• 8 X	X : 0 (All-call) 1 ~ 7 (Zone)	Any station can be used to initiate PA or station paging. A person paged can respond from the nearest master station.
	All-call plus 15-zone paging	• 8 X X	X : 00 (All-call), 01 ~ 15 (Zone)	
	Combination paging	• 8 9 X	X : 0 ~ 9 (Combination)	Several zones may be paged simultaneously.
	All-call response	• 0		Response to all-call
	Zone paging response	• 9		Response to zone paging or combination paging.
	Paging transfer	Conversation • 8 X Paging C Transfer Conversation after response → • • Conversation with original station	X : 0 ~ 7 (00-15) 90 ~ 99	This function allows a called parts to transfer the call to a third party who responds to paging
Data Transmitting and Receiving Unit	In/Out annunciation	Personal number registration/cancellation operation — lamp on/off		The in/out annunciation can be controlled from any master station.
	One-shot make output	• 3 X X X	X X X : 000 ~ 499	One-shot make output of relay may control other equipments such as ITV camera, VTR control, dectating systems, etc.
	Make/break output	• 3 5 X X X (Make) • 3 6 X X X (Break)	X X X : 000 ~ 511	Make/break output of relay may control other equipments.
	8-selectable output (Decimal output)	• 3 7 X Y Unit no. Condition no. • 3 8 X X Y Unit no. Condition no.	X : 1 ~ 9 Y : 0 ~ 7 (0~9) X : 01~64 Y : 0 ~ 7 (01~99) (0~9)	8 selectable outputs or a decimal output is available (indicating room status and destination).
	4 decimal digits output	• 3 9 X Y Y Y Y Unit no. 4-digits	X : 1 ~ 9 Y Y Y Y : 0000-9999	4 decimal digits output is indicated.
	Make output for Pager control	• 7 X X X	X X X : 000~239	Control the pocket pager by make output of relays.
	Pocket Pager response	• 4 X X X		
Clearing calling party indication	C C		This is used to cancel the calling party indication without conversation.	

Classification of Functions

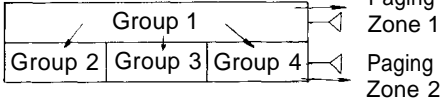
Classification	Function	Content	Explanation
1. Restriction of calls and functions	Group Blocking	Station numbers (sequential station numbers): max. of 8 groups The following system are available: (1) Group \square is composed of station No. $\square\square\square\sim\square\square\square$ (2) Group \square can call group \square (3) Group \square can make zone No. \square paging call 	[1] A system can be divided so that a group of stations (up to 8 groups maximum) cannot call each other. [2] Some or all of the stations in the group can both call and receive calls from all stations. [3] One or all (all-call, individual zone, combination) paging modes can be used by stations in the group.
	Programmable Restricted Access for Stations.	Restricted function: (1) Conference (2) All-call paging (3) General purpose controls: * One-shot make output * Make/break output * 8 selectable output (or Decimal output) * 4 decimal digits output	Any station can be allowed to access to all Call, Conference, General Purpose Control and Executive priority.
2. Priority of functions	Different types of paging are ranked by priority.	(1) Emergency all-call paging (2) All-call paging (3) Zone paging (4) Combination paging	[1] Paging call with the higher priority interrupts paging of lower priority. The lower priority paging is put through afterwards. Priority is in the following order: (1) >(2)» (3) = (4) [2] For paging messages with equivalent priority, priority is given to the one initiated first and those initiated after are put on camp-on-busy.
	Priority of station paging over calls:	(1) Usual call > Station paging (All-call, Zone (Combination paging)) (2) When Paging priority is used Station paging > Usual call (All-call, Zone, (Combination paging))	[1] Station paging is not heard at a station when a call is already in progress. [2] When a station is paged while a call is in progress, the call is interrupted. A holding tone is heard on the outside until the paging message is finished.
3. Time	Length of calling tone	* Long: 1.3 sec. * Short: 0.7 sec.	User selects preferred length.
	Length of paging tone	* Long: 2 sec. * Short: 1 sec.	
	Automatic line release	(1) During dialing: 5 sec. (2) During privacy mode: 10 sec.	This function has been adopted to speed up traffic processing and to improve the availability of speech paths.

Automatic Line Release

When, in dialing, all of the numbers are not dialed within 5 seconds, the station is automatically disconnected from the speech path and dialing cannot be completed. In this instance, the dialing process will have to be repeated from the beginning.

This function has been adopted to speed up traffic processing and to improve the availability of speech paths.

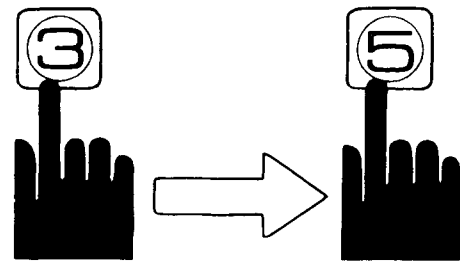

Within 5 sec

Camp-On-Busy

When the party you are calling is on another line, by simply waiting you automatically "Camp-On" the line. (Busy tone sounds continuously.) As soon as the line is freed, you will be automatically connected.

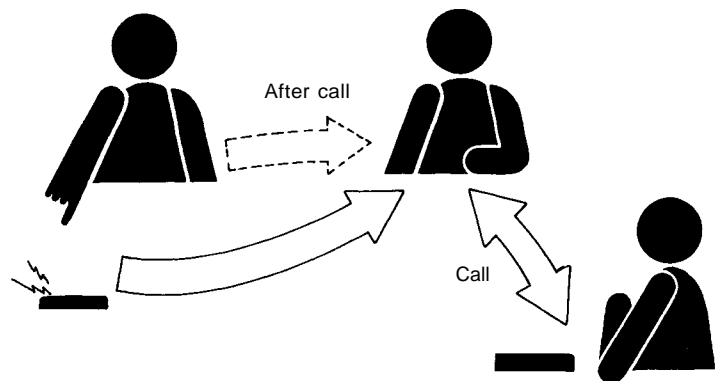

Privacy

Shift Privacy Switch to ON.



When a party does not wish to accept incoming calls, this function may be employed to refuse them. With the Privacy switch in the ON position, a continuous privacy tone will be sounded in the station making the call, and at the same time, a brief Privacy tone will sound in the station called, indicating a call attempt is being made.

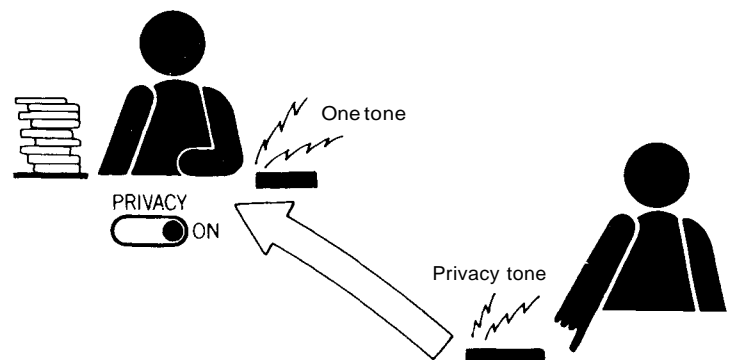

Shift Privacy Switch back to the left.



To restore a station in the "Privacy" mode to a normal condition, and thus ready to receive or make calls.

- Note: 1. A call received while the station is in the Privacy mode may be accepted if the Privacy function is immediately cancelled. (see Camp-On Privacy)
2. With a station that incorporates the Secretary Transfer function, the Privacy switch is used to activate the Secretary Transfer function. (see Secretary Transfer)
3. During the above "Privacy" mode, while the calling station has the PTT bar depressed, the privacy tone stops and the caller can transmit a one way message. When the PTT bar is released, the normal "Privacy" mode to be resumed.

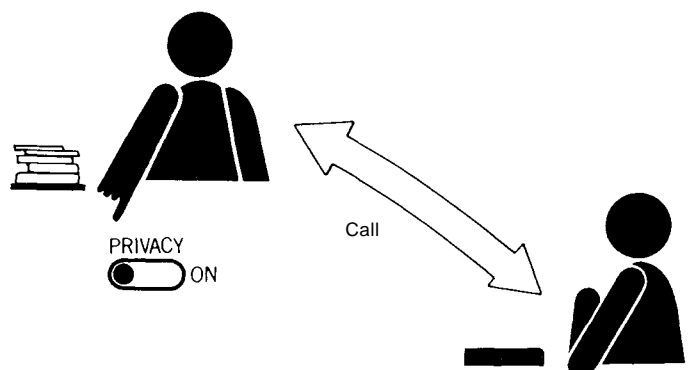

Camp-On Privacy

When the party you are calling has his station on Privacy mode, by simply waiting you will automatically "Camp-On" the line. (Busy tone sounds continuously.) As soon as the Privacy mode is released, you will be automatically connected.

This function is cancelled automatically if the station in the privacy mode may not accept the call within 10 seconds.

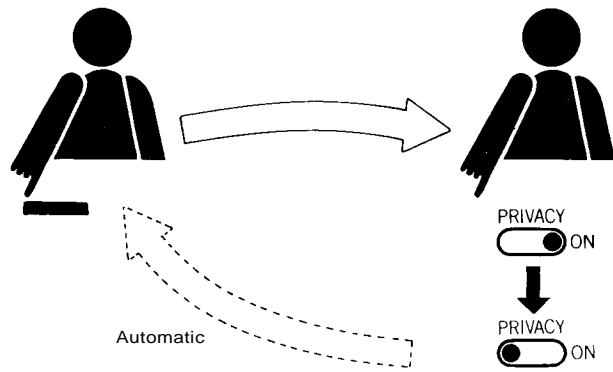

Press-To-Talk

This function is activated when the

PTT  (Press-To-Talk Bar)

is continuously depressed after dial tone confirmation or during conversation. This allows one-way conversation from the party depressing the function key. When the key is released, one-way conversation is reversed.

Employed when a person in a high noise level area is called by a person in a quiet area, or when no particular response is required, or when simple announcements are made. In such cases, one-way conversation flow can be used.

One-way conversation is activated while the Press-To-Talk bar is continuously depressed.

As long as the Press-To-Talk bar is depressed by either party, the voice of the party using this function has dominance. When the key is released, the other party has dominance.

One-way conversation is reversed when the Press-To-Talk bar is released.

If both parties depress the Press-To-Talk bar, the voice of the party who depresses the bar last will have dominance.

Depress the



To return to ordinary hands-free 2-way conversation

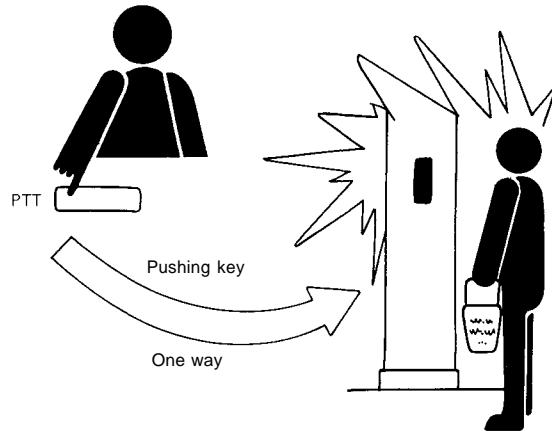

Mic Off

Touch dialing of



during a conversation turns off that station's microphone, and a holding tone is heard at both stations involved.

This function is used when for one reason or another it is desirable to stop a conversation temporarily. With this function in use, a holding tone is transmitted to both the calling and the called station while the conversation is interrupted.

Touch dialing



again cancels the Mic-Off function, and the conversation can be resumed.

When it is desirable to resume the conversation interrupted with the Mic-Off function, the function may be cancelled by the Party who operate the Mic-Off.

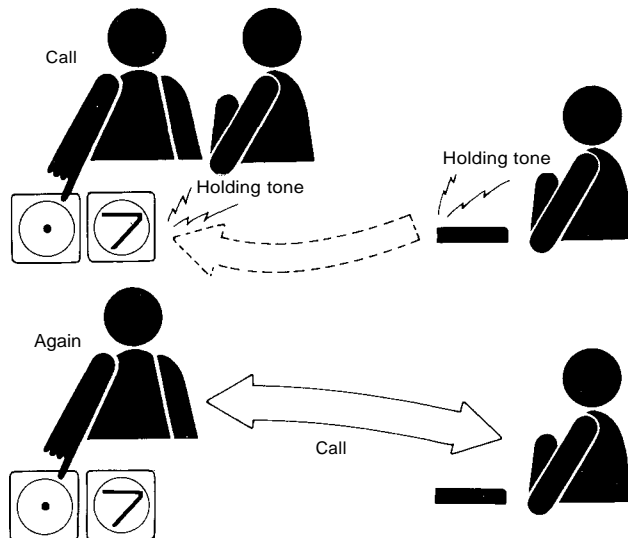

Personal Number Call

A personal number may be registered at any master station which the person to whom the number is assigned expects to be. A party wishing to receive personal number calls at a specific station may register his number at that station by touch dialing

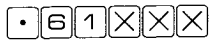

Personal Number.

Those who are frequently away from their assigned station, as well as those who share a single station may be assigned a "Personal" 4-digit number which may be programmed to any master station in the system. This personal number, which is completely independent of station numbers, may be programmed at any master station, and any previous programming of that same number at any other station is automatically cancelled. When the party calling has dialed the number to which he wishes to speak, the call is then routed to the station at which the Personal Number was last registered. The numbers which may be assigned in this group are 1000 through 1499.

Personal number program cancellation can be done at any station be merely dialing:

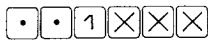

Personal Number

When anyone having a personal number leaves the office, he merely cancels the programming of his personal number. With the personal number cancelled, any incoming calls to that number will be answered by a dial tone, indicating that he is not available.

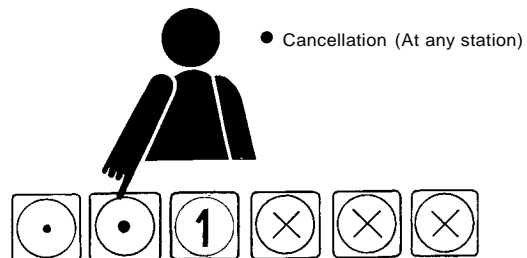
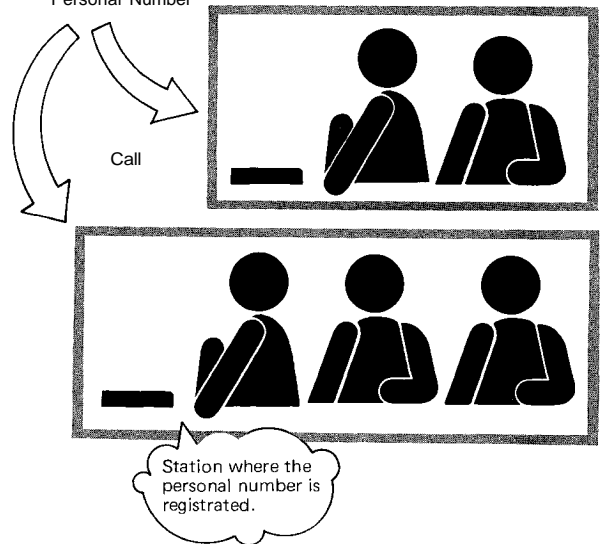
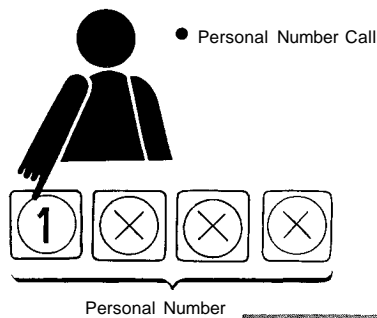
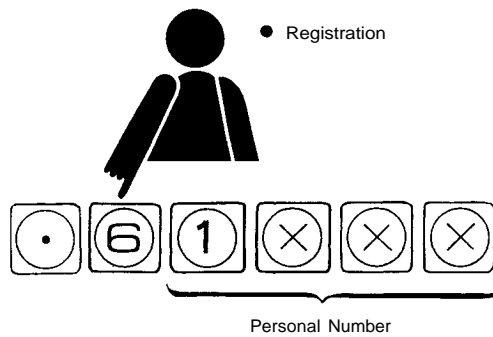

Single Digit Dialing

Single digit registration

Register in advance as follows:

• 6 0 X X X Confirmation tone	Single digits of station number
Station number (2 digits for 2-digit dial)	
• 6 0 1 X X X Confirmation tone	Single digit of personal number
Personal number	
• 6 0 • 8 (X) X Confirmation tone	Single digit of paging call
Paging zone	
• 6 0 • X Confirmation tone	Single digit of paging response
0 or 9 (0: All call response 9: Zone paging response)	
• 6 0 X X X X Confirmation tone	
Any four digits	
• 6 0 X X X (PTT) Confirmation tone	
Any three digits	
• 6 0 X X (PTT) Confirmation tone	
Any two digits	

Single digit dialing

When required, dial



and the registered number will be called automatically.

Note: 1. Any function dialing with long operation may be shortened by Single Digit Dialing.

Example: Single digit Combination paging Dial

0 1, and • 8 9 1 is called automatically.

• 8 9 1 Combination paging

|| Single digit



2. One-shot make output may be operated even in the event every link is not free. But is may not be operated in single digit dialing if all links are busy.
3. Single digit registration is not available from any substation programmed by No.200 programming, even if its line is connected with master station.

Master Sub Relationship

Master/Substation associations are set up by using station #200 as the programming station. Once these relationships have been established, substations can then contact their designated master stations by simply touch dialing



With respect to this function, the stations in the system are divided into two categories; master stations and substations. Any master station can be connected to any other station in the system. However, substations can initiate calls only to specific master stations. This is done by single touch dialing, and will only connect the substation to one specific master.

Several substations can be programmed under this station to connect with a signal specified master station.

To register single digit dialing, touch dial



substation number

Single digit dialing from that master to a specific substation is then accomplished by touch dialing



Programming a master station for Single Digit Dialing of a substation number under this function is programmed in the same manner as other single digit dialing, and results in one touch dialing from master to substation.

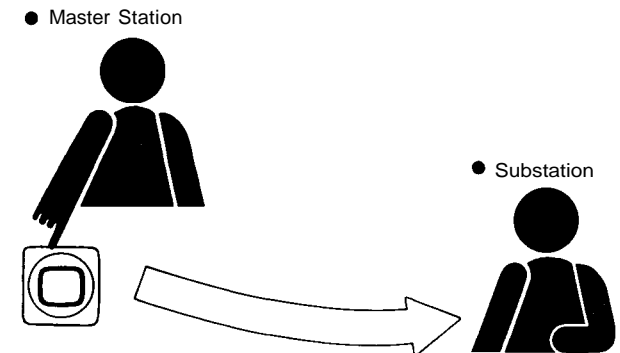
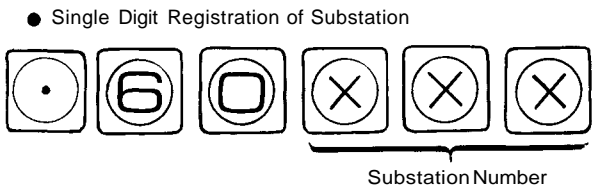
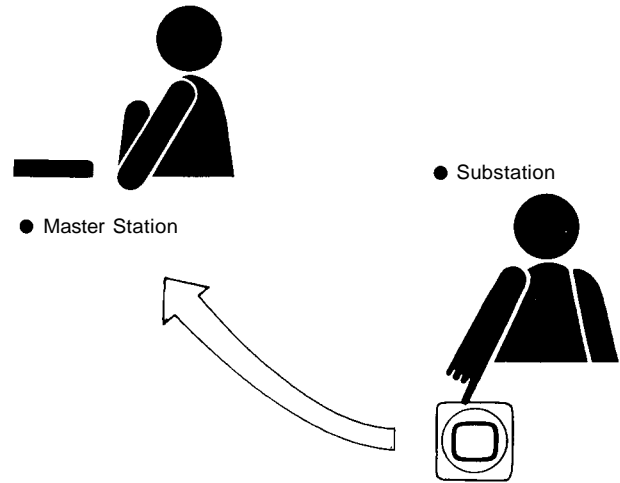

Secretary Transfer

This function is only available when a specified station is programmed for this purpose with use of Station #200 in the programming mode. Automatic transfer of incoming calls by an executive to his secretary is accomplished by placing the Privacy Switch on his station in the ON position.



This function allows a secretary to accept all incoming calls placed to an executive.

For the executive to accept calls directed to his station once the automatic secretary function has been programmed by station #200, he simply moves the privacy switch to the left, or OFF position.



It is also possible for the executive to accept calls at his station.

There is no limit to the number of Executive/Secretary pairings except by the number of available number combinations within a given system.

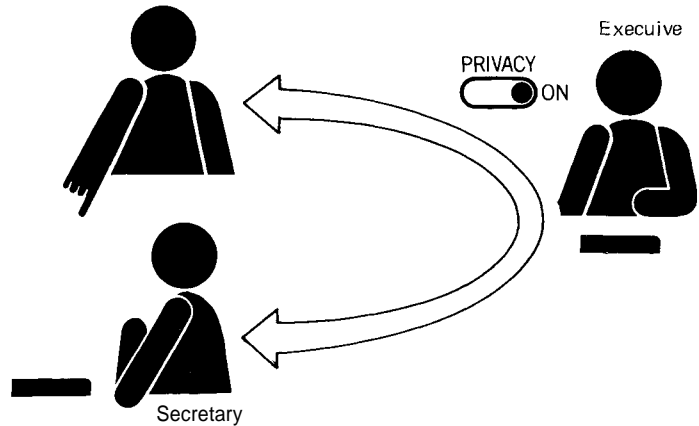

Adoption of the selective function "Transfer" allow re-routing of the call transferred to the secretary back to the executive's station.

When the secretary answering a call touch dials



executive's station number

the privacy tone sounds continuously at both ends of the line, while the call is held. The call holding tone is transmitted to the calling station. If the executive shifts the privacy switch to the left position, he can talk with the secretary. If the call held is to then be transferred back to the executive's station, the secretary is to touch dial [C] and the original calling station will be connect to the executive's station.

Touch dial



Executive's station number

at the secretary's station in advance. When the call transferred to the secretary has to be transferred back to the executive, the secretary simply touch dials



at her station. This sets the privacy tone sounding continuously at both ends of the line while the call is held. If the call is to be transferred back to the executive's station, the secretary touch dials



The calling station will then be connected to the executive's station.

Adoption of the selective functions "Transfer" and "Single Digit Dialing" allows simple retransfer of the call transferred to the secretary back to the executive's station.

Reply from the executive, the secretary touch dials



This will then return the secretary to the original call.

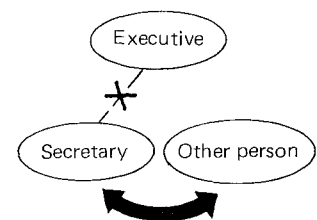
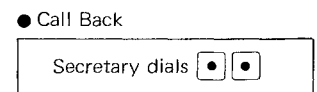
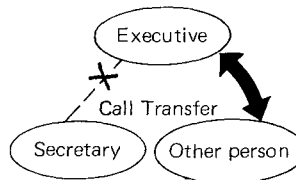
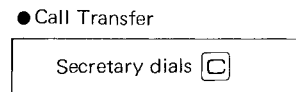
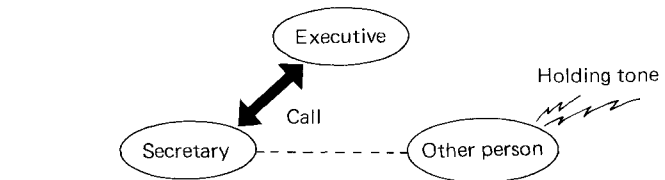
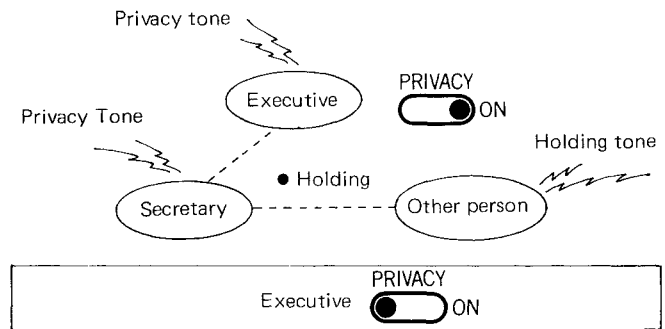
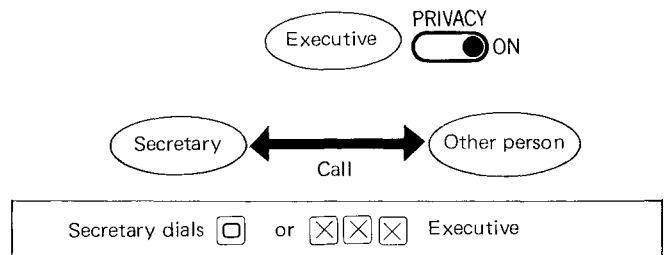

Call Transfer

Call Transfer from Called Station

During the conversation, first dial



(the Station Number of the person the call is to be transferred to).

The original call is then held and the holding tone is transmitted to the other party, while the third party is called and asked whether he will accept the call. If he agrees to accept the call, dial



and the transfer will be completed.

This function allows called party to transfer that call to another station. The party to whom the call is to be transferred, may be called using either the Station Number, the Personal Number or through Single Digit Dialing.

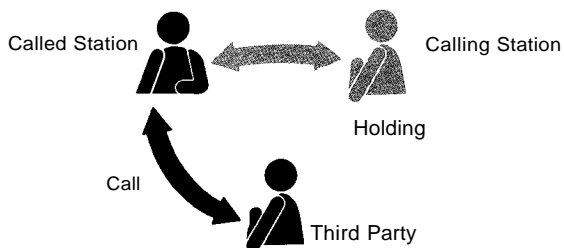
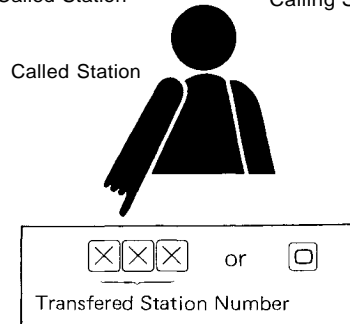
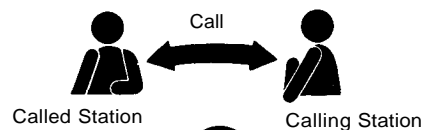

Call Hold and Call Back from Calling or Called Station

During the conversation, first dial



the Station Number of the third party.

The other party is then placed on hold as the third party is called. The conversation with the third party over, dial



and the original conversation may be resumed.

The Transfer function is combined with the Call Holding function.

When two parties are talking, either one can be temporarily placed on hold to permit the calling of another station. The conversation with the third party over, the original conversation can be resumed.

The third party can be called using either the Station Number, his Personal Number or through Single Digit Dialing.

● Transfer

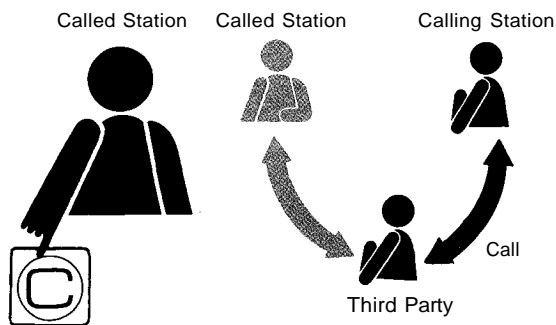

● Call Back

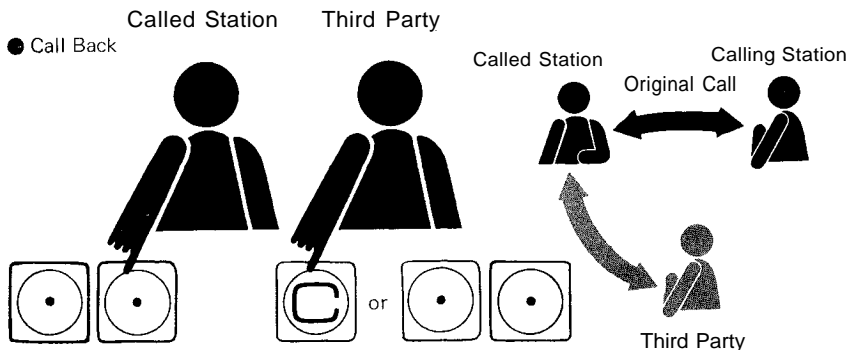

Priority

When the party called is on the line, as indicated by the busy tone, dialing



transmits a priority tone to the called party. The same tone is audible at the calling station. The call is connected if the called party also responds by dialing



In this event, the original conversation partner of the party called is temporarily placed on hold and the holding tone is transmitted to his station.

Upon completion of the priority conversation, the party who placed the priority conversation dials



at his station. This allows the interrupted conversation to resume.

When the called party is already on the line, the party calling, if he deems it necessary, can send a Priority signal to the called party. After a response from the party called, the urgent call is allowed to take priority and go through.

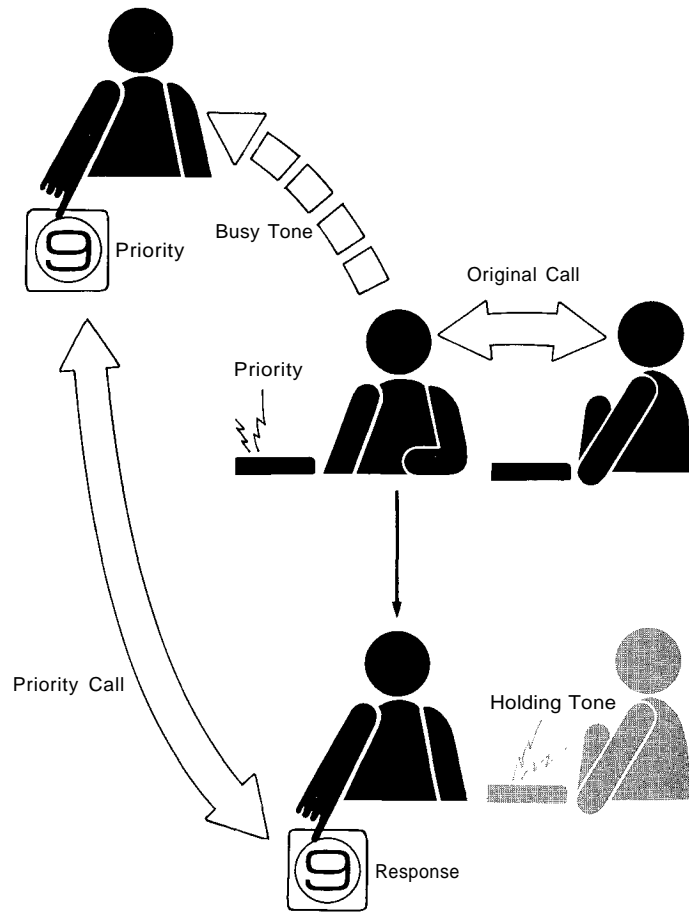

Executive Priority

This function is available only for those stations specifically programmed for this function, with programmed station #200. When the station called is busy or in the Privacy mode, as indicated by the busy or privacy tone, dialing



sends a priority tone. This priority tone is transmitted for a few seconds and then the call is put through.

In this event, the original conversation partner of the party called is put on hold and a holding tone is transmitted to his station.

Upon completion of the priority conversation, the party placing the priority call dials



at his station to allow the original conversation to resume.

When the called station is busy or in the "Privacy" mode, this function allows forced interruption for priority conversation.

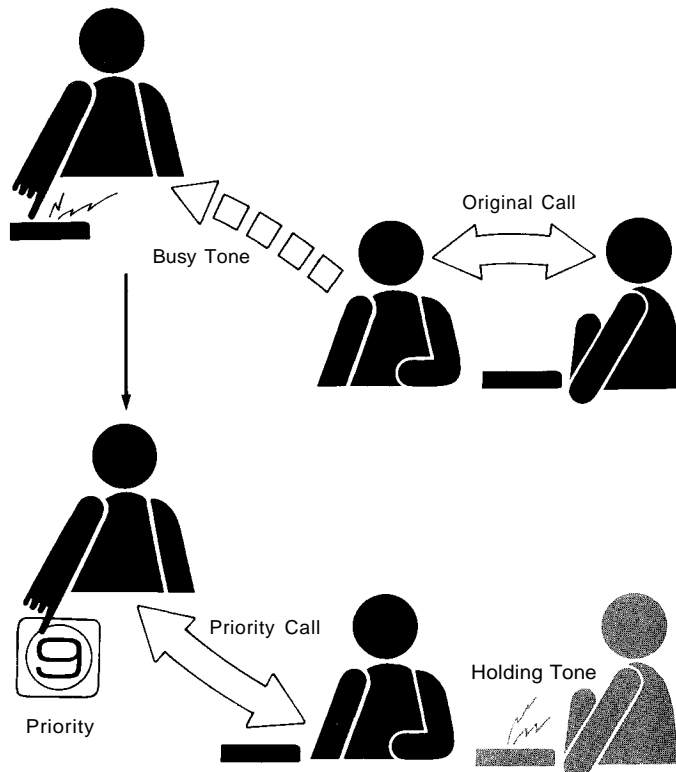

Continuous Calling Tone

When a specified station receives a call, the calling tone continues until PTT bar is depressed by this party.

1. When calls cannot be answered immediately or when it is difficult to hear a normal calling tone due to high background noise, the station should be provided with the continuous calling tone function. There is no limit to the number of stations that may be equipped with this function, but a No.200 registration must be completed (refer to Installation Instructions for EXES-5000 CPU-55.)
2. Stations with handset (such as the HFM-500) may activate the PTT function when the handset is lifted.
3. When the caller depresses the PTT bar while the continuous calling tone sounds, he can talk to the person called by one-way. When the PTT bar is released, the continuous calling tone returns.
4. During two-way conversation, each party presses the PTT bar to talk and releases the PTT key to receive the other party. (Press to Talk)

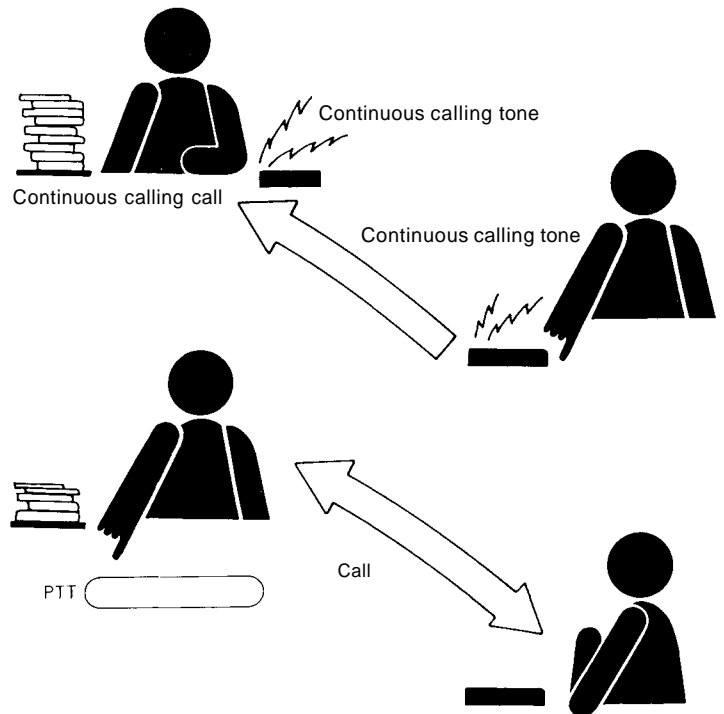

Talk Back

First, call the "Talk-Back" station as in a normal call.



("Talk-Back" station)

The Calling tone will sound and the message is transmitted.



In this case, while the calling station has the Press-To-Talk bar depressed, the caller can transmit a one-way message.



When this bar is released, the "Talk-Back" station can give a one-way message to the caller.

This function is convenient for stations that normally only receive calls and do not have to call other stations.

Calling "Talk-Back" Station

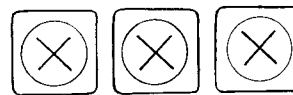

("Talk-Back" Station)

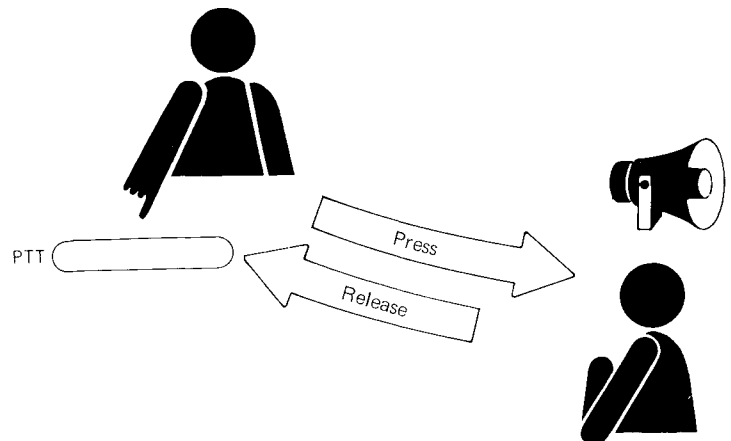

Conference

A "Hands-Free" conference call can be made with up to 4 persons. For a conference under this function the other participants may be called either through their station number, personal number or by Single Digit Dialing. Addition of stations or personal numbers (total of only 4) may be added by anyone already connected.

The person who proposes the conference may dial

• 5 XXXX

(Station Number of the 1st of the participants)

After receiving 2nd person's consent, he may then dial

XXXX

(2nd participant)

After receiving 3rd person's consent, he may now dial

XXXX

(the last participant)

At this point, the 4-man conference may begin. It is also possible for any of the 4 participants to call up any of the other participants.

A person wishing to drop out of the conference should dial

C

at his station.

Any of the participants who wish to drop out during the conference may do so as long as it's not the party who originated the conference.

The function is cancelled and the normal mode is restored when the person who arranged the conference dials

••

In the event that the calls made by the person arranging the conference are not answered or that there has been a dialing error, the function can be cancelled for restoration to the normal mode.

The conference is terminated when the party who arranged the conference dials

C

When the conference has been terminated by the party who originated it, the other participants cannot continue the conference.

Either of the parties in conversation is to dial

• 5 XXXX

(the Station Number of the third party).

It is possible for persons in normal conversation to change to the Conference mode without interruption.

- A "Hands-Free" conference call can be made with up to 4 persons.

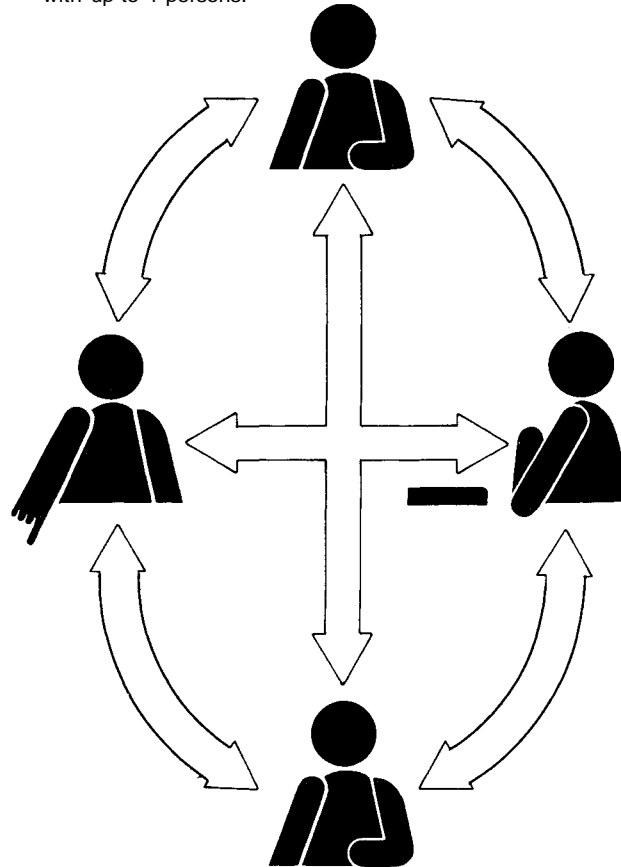

- Dialing of conference member.

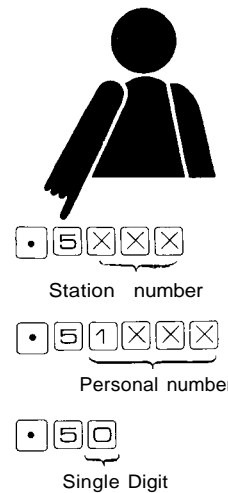

Selectable Calling-Tone Duration

The duration of the calling tone can be set for either a "long" (1.3-second) or a "short" (0.7 second).

Selectable Paging Pre-Announcement Tone Duration

The duration of the all-call and zone paging tones can be set for either a "long" (2-second) or a "short" (1-second).

Paging

A variety of paging modes allows paging over a wide area from any master station. The paged party may respond from the nearest master station.

Paging modes include external PA systems and/or Station paging and Zone paging is for calling a limited area, and All-call paging is for calling over the entire area.

A. External PA paging

1. Paging through external speakers is possible from any master station, with the paged party able to respond from the nearest master station.
2. External PA paging zones and all-call paging are possible up to a maximum number of 7 zones (zone 1 through 7) or 15 zones (zone 1 through 15).

B. Station paging

1. Paging from any master station to all stations within a certain area is possible through the station speakers. A normal call can be placed during the page by any master station in the area, but the page will not be heard at stations in use in the area.
2. Station zone paging and all-call paging are possible only within zone 1 through 7.

Note: Zone paging and All-call paging

1. Zone paging (Individual zone paging).
Paging and Paging response are possible through Zone paging. To page a specific zone, press and the zone number. To respond to a zone page, press . The External PA zone paging (1 ~ 15) overlaps the station paging zones (1 ~ 7) allowing simultaneous external PA and station paging of zones 1 ~ 7.
2. All-call paging
Paging and Paging response for External PA or station paging is possible through All-call paging. To make an all-call page, press (maximum of 7 zones) or (maximum of 15 zones). To respond, press . This does not necessarily mean that All-call station paging must reach all the stations.

Other Paging Modes

1. Combination paging

Combination paging is used when several zones must be paged simultaneously through External PA or Station paging. A special paging area can be created wherever the paging ranges overlap by combining several zones. A maximum of 10 combinations can be created in this way from a maximum of 15 individual zones.

2. Emergency all-call paging

Emergency external PA or station all-call paging can be made either from the specified station (No.247) or by an external input signal connected to line No.247. All normal calls and pages are interrupted for the duration of the emergency All-call page, returning to normal when the page is terminated.

3. Paging priority

In normal station paging, the page is not heard at any station already in use. By using the paging priority function, the call can be interrupted to allow the page to go through. A holding tone sounds at the other party's station, and the call is restored when the page is terminated.

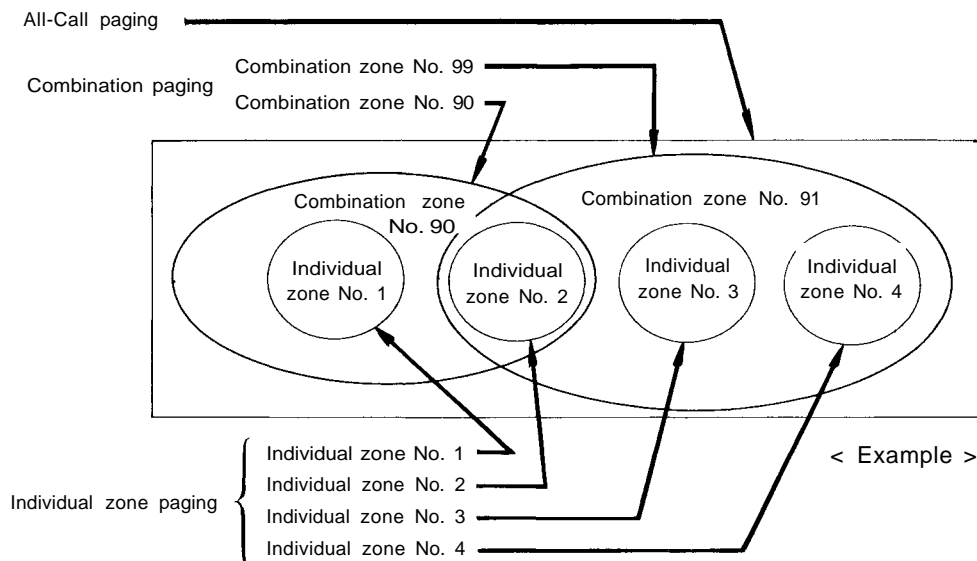

Note: Priority of Paging

Emergency all-call paging > All-call paging > Combination paging = (Individual) zone paging

1. The higher priority page overrides the lower priority one. The lower priority page will be restored when the higher priority page is terminated.
2. Individual zone pages made while a Combination paging is in progress will result in Camp-On-Busy.

How to select the paging area and make the paging call.

Paging functions may include both external PA and stations, depending on the zone being used. The paging area is limited to individual zone, Combination paging and All-call paging depending on the call range.

Paging area	No.	Paging		Dialing operation		
		External PA paging	Station paging	Paging		Response
				All-call and maximum of 7-zone paging.	All-call and maximum of 15-zone paging.	
All-call paging	0	All-call and maximum of 7 zones paging	All-call and maximum of 15 zones paging.			
Calling Maximum of 15 zones	1 ↓ 7	Combination zone	Individual zone paging			
	8 ↓ 15	Available	Not available			
Combination paging of up to 10 zones	90 ↓ 99	Available, provided the combination zone is within the zone of 1 through 15.	Available, provided the combination zone is within the zone of 1 through 7.			

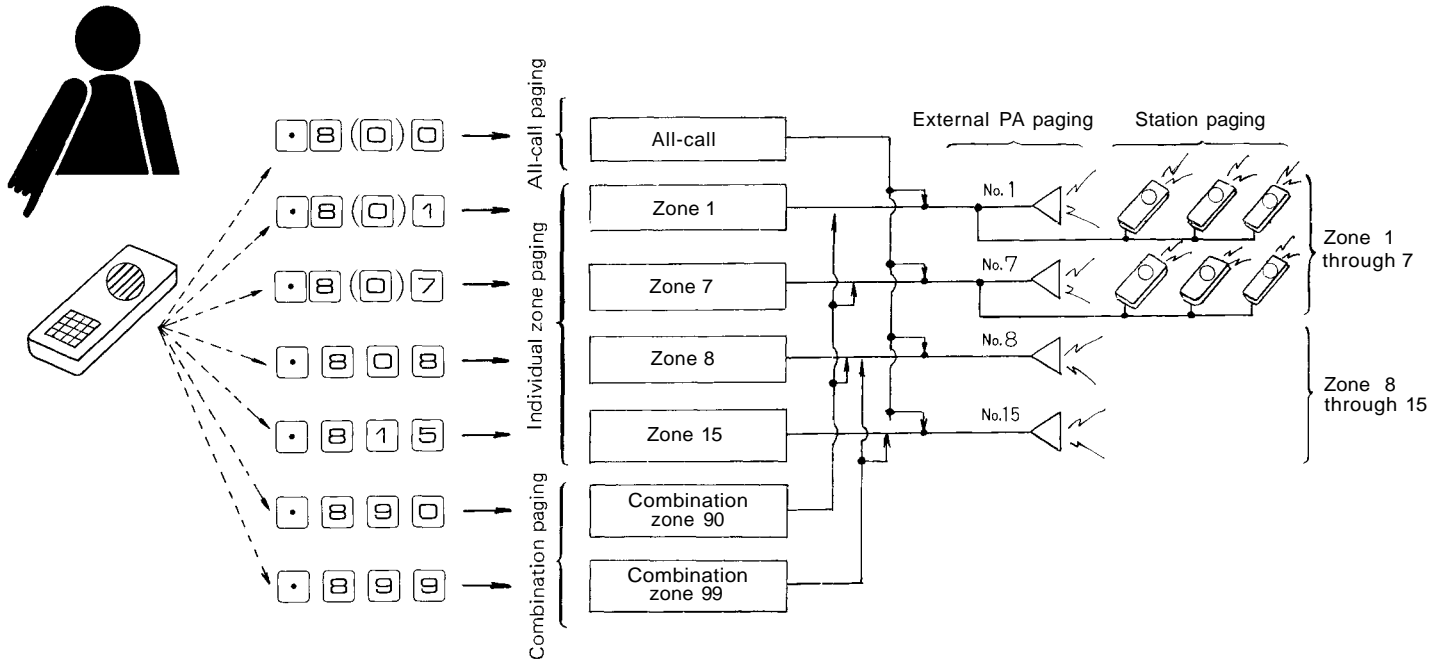

< Example >

All-Call Paging and Individual Zone Paging

External PA paging to a specific zone is possible from any master station by pressing



and the desired zone number ('0' = all-call). It is possible to wait for a response in this mode, but anything said will be broadcast over the entire zone. It is best to end the paging call by pressing



and waiting for a response.

All-call paging of zones 1 through 7 can be done in both the External PA paging mode, through An external amplifiers and speakers, and the station paging mode, through the station speakers. All-call paging of zones 8 through 15 can be done only in the external paging mode.

To respond to a paging call, go to the nearest master station and press either (Zone paging response) or (All-call paging response).

Paging transfer

An external PA paging call can be made by a called party of an existing call to a third party, the third party's response accepted while the original call is on hold, and the original call resumed when the response call has ended. Press



and the desired zone number. This puts the original call on hold and makes the External PA and or Station paging call. Then, press to restore the original call, and wait for the response to the paging call. When the response is received, press , and the original goes back on hold allowing the second call to be taken. When the second call is completed, press and the original call can be resumed.

Note 1: When all-call paging is initiated during zone paging, the Zone paging is interrupted and restored after the all-call paging is finished.

Note 2: To respond to Zone paging by pressing , No.200 registration of the stations (consecutive station numbers) within each zone must be made. Such registration is required for both external and station paging. For further details, please refer to Installation Hand Book for EXES-5000 CPU-55.

Table of stations used for individual zone paging. (Example)

Zone numbers	First station number	Last station number
1	2 0 1	2 0 3
2	2 0 5	2 0 7
3	2 1 0	2 1 9
4		
5		
6		
7		
8		
9		
1 0		
1 1		
1 2		
1 3		
1 4		
1 5		

Required for station paging

Required for external PA paging response

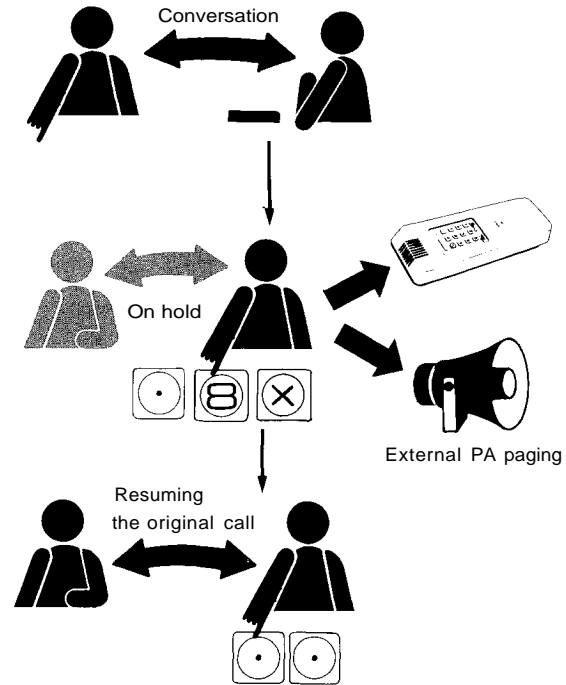
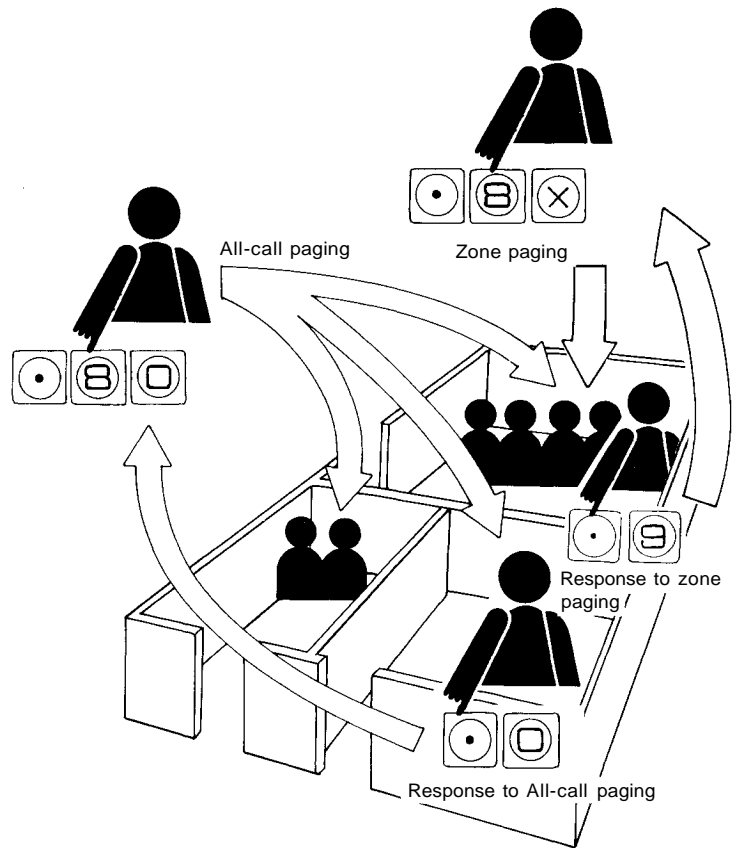

Combination Paging

Several zones can be called simultaneously using external PA paging and station paging. This is combination paging and is initiated by pressing



Paging will be broadcast to predetermined zones. It is possible to wait for a response in this mode, but it is usually preferable to terminate the paging call and wait for a response. The paged party can respond by pressing



at the nearest station.

Priority of paging

All call paging > combination paging = individual zone paging

1. When some stations are already receiving another combination paging, the second paging call will be put on camp-on-busy.
2. When some stations are receiving individual zone paging, a combination paging call will be put on camp-on-busy.

Likewise, when a combination paging call is being received, individual zone paging calls will be put on camp-on-busy.

Responding to combination paging and zone paging

To respond to zone paging or combination paging, press



When the same zone is called via both zone paging and combination paging, responses will be put through to the station calling last.

< Example 1 >

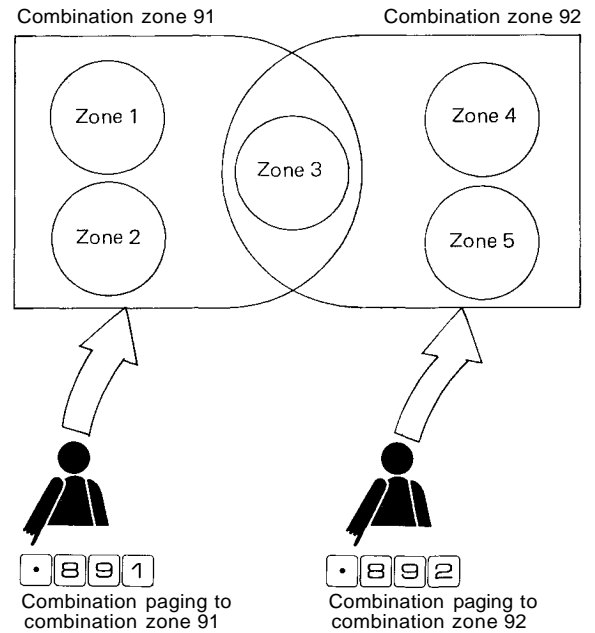

< Example 2 >

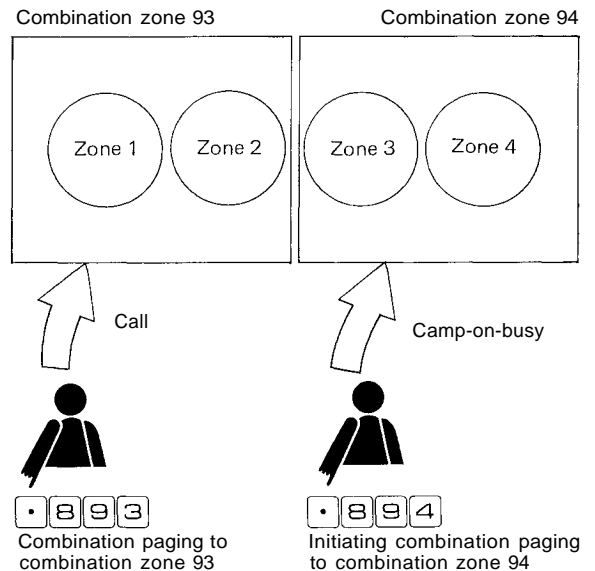

< Example 3 >

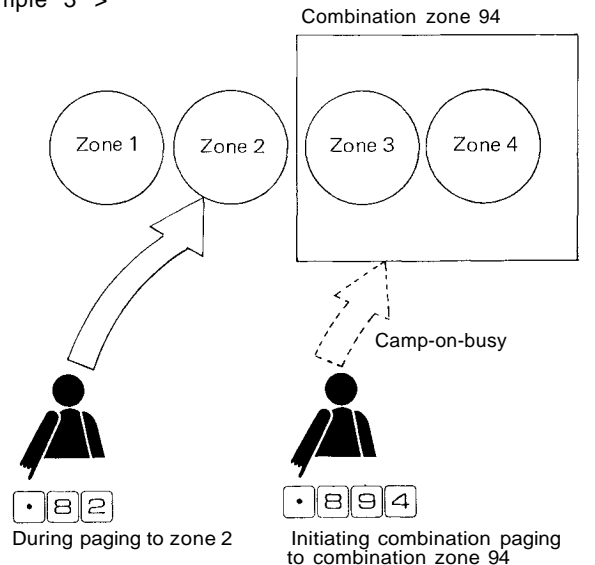

< Example 4 >

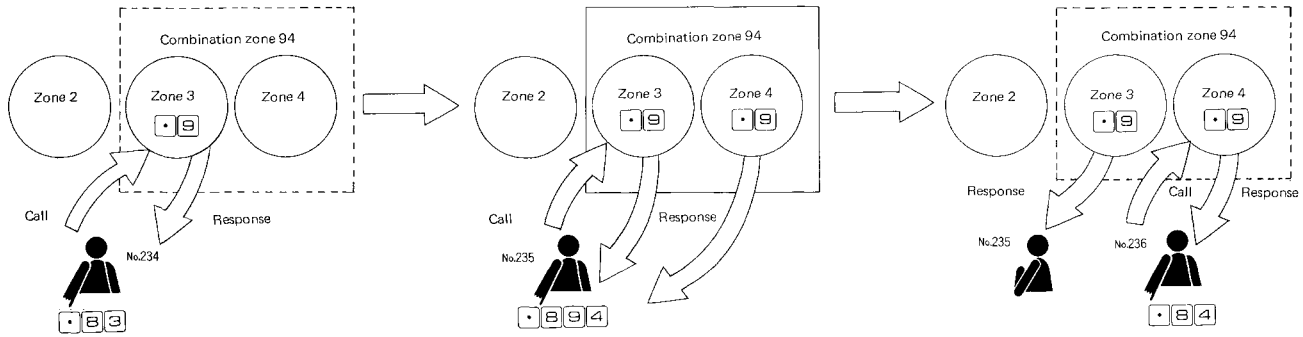

To operate combination paging, No. 200 registration indicating the individual zones to be included in the combination zone-must be made.

For further details, refer to Installation Hand Book for EXES-5000 CPU-55.

Table of zones included in combination zones (Example)

Combination zone	Dialing	Individual zone														
		1	2	3	4	5	6	7	8	9	10	11	12	13	14	15
90	• 8 9 0															
91	• 8 9 1	○	○	○												
92	• 8 9 2			○	○	○										
93	• 8 9 3	○	○													
94	• 8 9 4															
95	• 8 9 5			○	○											
96	• 8 9 6															
97	• 8 9 7															
98	• 8 9 8															
99	• 8 9 9															

Emergency All-Call Paging

The emergency all-call station, No. 247, should normally be kept with the privacy switch



To broadcast emergency all-call paging, move the privacy switch to



The highest priority all-call paging can be broadcast to all zones without pre-announcement of paging. During emergency all-call paging, all other paging calls and normal calls are interrupted until the emergency message is finished.

1. This function may be used to announce emergency instructions from the specified station No.247 . It may also be used to provide the signal tones such as chime or alarm signals when the signal sources are fed to No.247 circuit.

Paging Priority

When using the standard paging functions, paging is not heard while other calls are in progress.

Using paging priority:

1. Dial



(zones: 1—7, all-call: 0),



(zones: 01—15, all-call: 00), or



(combination zones: 90—99).

When the station being paged is already on the line, the call is interrupted. And the calling party is put on hold while the paging message is delivered.

2. The calling party will be restored after the paging message is finished and his original conversation may be resumed.

3. If the person paged wishes to respond immediately, he should dial



to terminate his original conversation and then dial



(zone paging or combination paging response) or



(all-call response).

< Example >

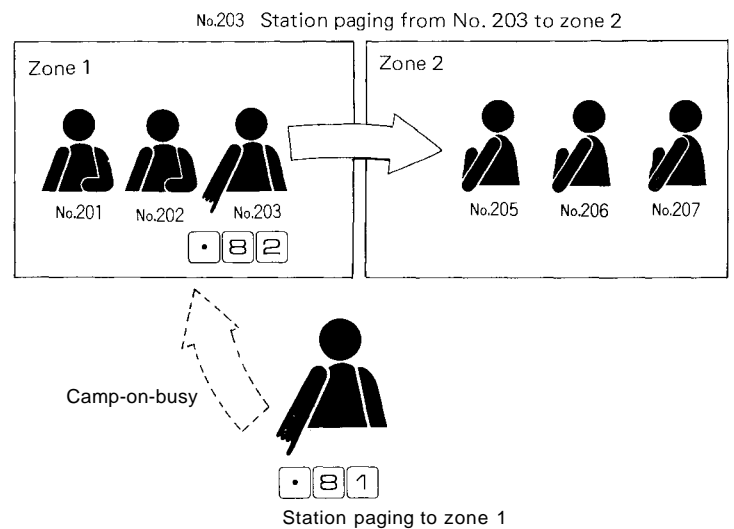
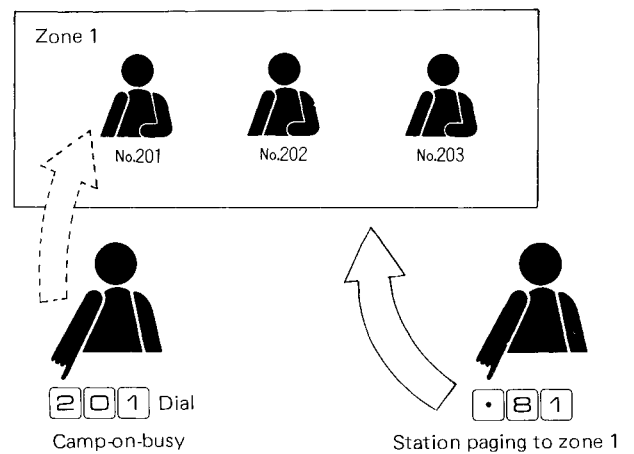
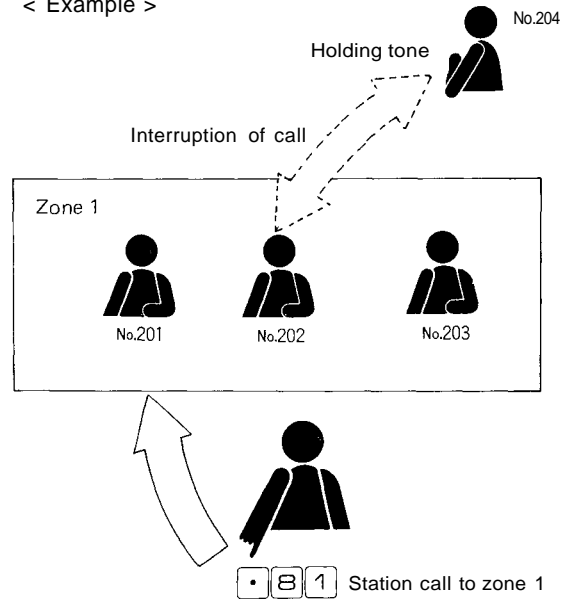

- Note 1: If the station called is in the process of dialing when station paging is initiative, paging will not be heard at that station and the call can be completed without interference.
- Note 2: If a station being paged with station paging is called by a third party, camp-on-busy will result.
- Note 3: If any station in a given zone (zone 1, for example) pages another zone (zone 2, for example), station paging to stations in zone 1 results in camp-on-busy.
- Note 4: If station paging priority is used, the station numbers within the zone area must be programmed at station No. 200. This registration is also required when station paging priority is unnecessary. For further details, see Installation Hand Book for EXES-5000 CPU-55.
- Note 5: Use of both station paging priority and external paging: Station paging priority interrupts calls in stations of zones 1 through 7 for both station and external paging. If station paging and external paging are used simultaneously, allocate station paging to zones 1 through 7 and external paging to zones 8 through 15.
- Note 6: Use of both priority station paging and external paging within 7 zones: When responses are required for priority station paging but not for external PA paging, No.200 registration of the station allocation tables for the paging zones should be done only for station paging. Calls are not interrupted during external paging, in this case.

Station allocation table for paging zones (Example)

Zone number	First station number	Last station number
1	201	203
2	205	207
3		
4		
5		
6		
7		
8		
9		
10		
11		
12		
13		
14		
15		

Required for priority Station Paging

Required for External PA Paging response

2-Digit Dialing

Standard numbering for stations is from 200 through 327. However, station numbers 20 through 99 are available for systems with less than 80 stations.

1. Operation procedures using 2-digit dialing are the same as those using 3-digit dialing.
2. Number programming table

Exchange	Paging	Station number	3-digit dialing	2-digit dialing
64-station system (EX-510)	Not available	64	No.200~263	No.20~83
	All-call plus 7 zones (1 Paging Interface Unit)	56	No.200~255	No.20~75
	All-call plus 15 zones (2 Paging Interface Units)	48	No.200~247	No.20~67
128-station system (EX-520)	Not available	128	No.200~327	No.20~99 (Maximum 80 stations)
	All-call plus 7 zones (1 Paging Interface Unit)	120	No.200~319	
	All-call plus 15 zones (2 Paging Interface Units)	112	No.200~311	

Note: PIU: Paging Interface Unit

Programmable Station Numbering

This function allows the system to have "Programmable station numbers", other than the "Hardwired station numbers" by programming.

The unprogrammed stations (unit station numbers) are used as original hardwired station numbers.

	Hardwired station number	Programmable station number
3-digit dialing	No.200~32 7	No.200~99 9
2-digit dialing	No.20~9 9	No.20~9 9

1. Numbering schedules can be changed easily by programming in stead of rewiring.
2. Numbering schedule (such as 200's (20's), 300's (30's), 900's (90's)) is available for convenient office differentiation. (architectual numbering).

< Example >

Hardwired station number	Programmable station number	
2 0 1	2 0 1	} Department 1
2 0 2	2 0 2	
2 0 3		
2 0 4	3 0 1	} Department 2
2 0 5	3 0 2	

3. Normally, station numbers which are included in a station paging zone must be sequential, but programmable station numbers can be randomly included in a station paging zone.

Hardwired station number	Programmable station number	
2 0 1	2 0 1	} Station paging zone
2 0 2	2 3 1	
2 0 3	2 4 1	

4. This function is programmed at station No.200. Please see Installation Instructions for EXES-5000 CPU-55.

Hardwired station number	Programmable station number
2 0 0	→
2 0 1	2 0 3
2 0 2	→
2 0 3	2 0 1
3 2 6	→
3 2 7	→

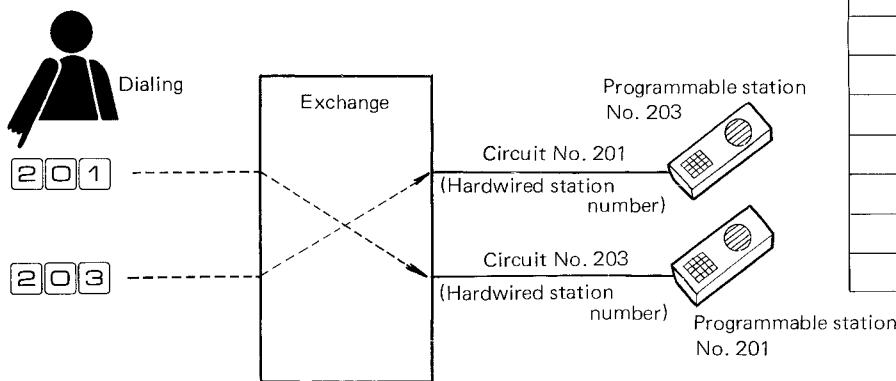

5. People operating the intercom stations need not be aware of the Hardwired station numbers. However, care must be taken when programming using station No. 200 in the exchange, as hardwired station numbers must be used for that purpose.

Group Blocking

Function (A) . . The system can be grouped or divided into a maximum of 8 groups of stations with sequential station numbers. Stations in the group cannot call another.

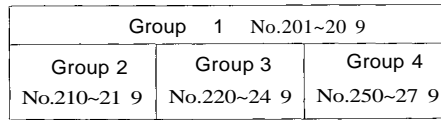

< Example >

Function (B) . . The group can call and/or be called by any other group(s) by programming.

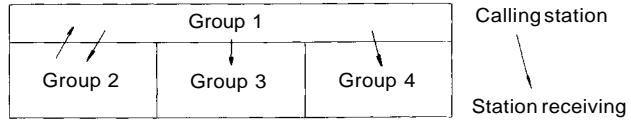

Function (C) . . The paging zone number (all-call, individual zone and combination) which each group can call is programmable. (No distinction is made between external and station paging.)

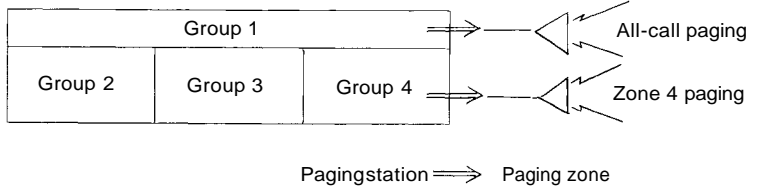

To use this function, station No. 200 programming of the allocated station number, group, paging zone, etc., must be set up in the exchange. For further details, please refer to Installation Hand Book for EXES-5000 CPU-55.

Function registration (A)

Function registration (B)

Function registration (C)

Station for each group		Group No. of calling station	Group No. of station receiving call	Paging zone of station receiving call																																				
				All-call		Zone No.															Combination zone No.																			
First station number	Last station number		1	2	3	4	5	6	7	8	×	00	01	02	03	04	05	06	07	08	09	10	11	12	13	14	15	90	91	92	93	94	95	96	97	98	99			
2 0 1	2 0 9	1	⊙	⊙	⊙	⊙					⊙	⊙																												
2 1 0	2 1 9	2	⊙	⊙							⊙																													
2 2 0	2 4 9	3			⊙						⊙																													
2 5 0	2 7 9	4				⊙					⊙					⊙																								
		5					⊙				⊙																													
		6						⊙			⊙																													
		7							⊙		⊙																													
		8								⊙	⊙																													
Station not in group		×	⊙	⊙	⊙	⊙	⊙	⊙	⊙	⊙	⊙	⊙	⊙	⊙	⊙	⊙	⊙	⊙	⊙	⊙	⊙	⊙	⊙	⊙	⊙	⊙	⊙	⊙	⊙	⊙	⊙	⊙	⊙	⊙	⊙	⊙	⊙	⊙		

This chart shows the possibilities for one sample set of conditions.

< Example >

- ⊙ indicates that registration is not necessary.
- ×

Programmable Restricted Access for Stations

Stations which can use the following functions must be programmed, so as to restrict access to those functions by those stations not programmed.

1. All-call paging

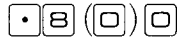

2. Conference



Station number

3. General purpose control
Model (One-shot make output)



000~499

4. General purpose control
Mode 2 (Make/break output)

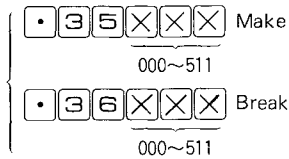

5. General purpose control
Mode 3 (8 selectable output or decimal output)

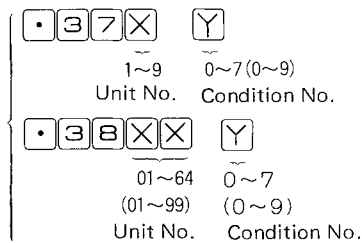

6. General purpose control
Mode 4 (4 decimal digits output)

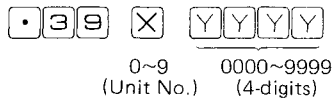

1. For a conference call, only those stations allowed to use the conference link can dial. The other members of the conference need not be allowed conference access.
2. No. 200 programming of the specified station must be made in the exchange. For further details, please refer to Installation Hand Book for EXES-5000 CPU-55.

In/Out Annunciation

The in/out annunciation indicators can be turned on or off from any master station by using the personal number registering procedure.

When a personal number registration is made at a station, by dialing

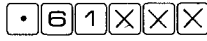

1000~1499(personal number)

the personal number is registered at that station and the personal number lamp on the in/out indication panel is turned on.

Personal number call

By dialing

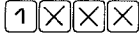

1000~1499 (personal number)

from any station, the call is put through to the station registered with the personal number.

Cancelling personal number and turning off in/out annunciation.

By dialing



1000~1499(personal number)

from any station, the personal number is cancelled and the personal number lamp on the in/out indication panel is turned off.

1. The maximum number of in/out annunciation windows is 500.
2. The in/out indication panel must be used with the Data Transmitting and Receiving Units (DT-E11 and DR-B61).
3. For further details, please refer to Installation Hand Book for EXES-5000 CPU-55 and Instructions for the Data Transmitting and Receiving Units.

In/out indication panel

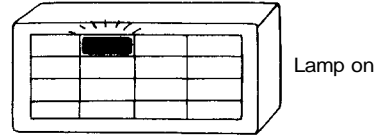

Lamp on

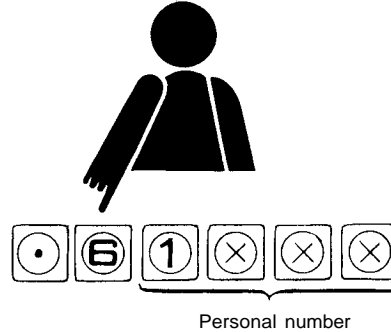

Personal number

In/out indication panel

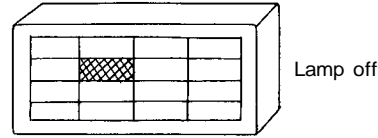

Lamp off

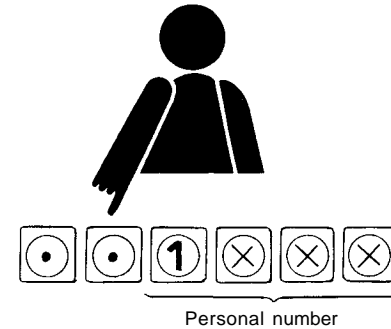

Personal number

Calling Party Indication (Lamp Type)

A one station/one lamp type calling party indication panel can be provided for certain specified stations (eight stations from No.232 to No.239).

1. The lamp at the station receiving the call turns on when a call is made and turns off when the conversation is completed.
2. When a call (camp-on-busy) is made to the busy or the privacy station (with the privacy switch on), the lamp of calling station turns on. The lamp will not turn off even if the original call is cancelled.
3. The lamp turns off after the conversation is cancelled.
4. Dialing



without placing a call causes all lights to be turned off.

Note 1: The maximum number of calling stations is set at 128.

Note 2: The indication panel must be used with the Data Transmitting and Receiving Units. For further details, please refer to Installation Hand Book for CPU-55 and Instructions for the Data Transmitting and Receiving Units.

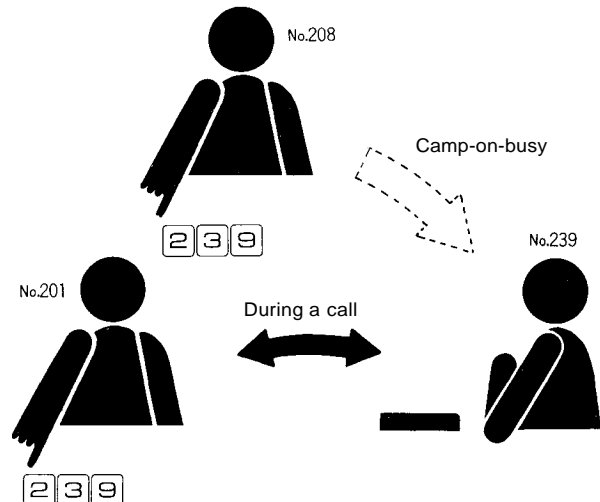
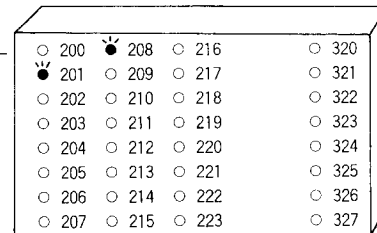

Calling Party Indication (7-SEG Display Type)

A numerical type calling party indication panel can be provided for certain specified stations (32 stations from No. 200 to No. 231).

1. The party receiving the call is indicated in the area for the calling station number with 7 segment display.
2. When a call is made to the busy or the privacy station (with the privacy switch on), the number of the calling party is indicated in the area for the waiting station and as a 1 in the number of waiting stations area. If there are other stations waiting, the station numbers are stored but not indicated. A maximum of 8 waiting stations can be indicated. Even if a call is cancelled by a waiting station, the indication is not cancelled.
3. When a call is placed to a station in the waiting station mode, the next stored waiting station is indicated.
4. If a call is cancelled at the completion of a call, the indication is turned off.
5. To cancel a waiting station number without calling, dial



to have the next station number indicated.

Note 1: If the number of waiting stations exceeds 8, the indication for the station that has been waiting for the longest period of time is cancelled and the next station moves into that place.

Note 2: When 2-digit dialing is specified, the station number is also indicated as a 2-digit number.

Note 3: The indication panel must be used with the Data Transmitting and Receiving Units. For further details, please refer to the Installation Hand Book for CPU-55 and Instructions for the Data Transmitting and Receiving Units.

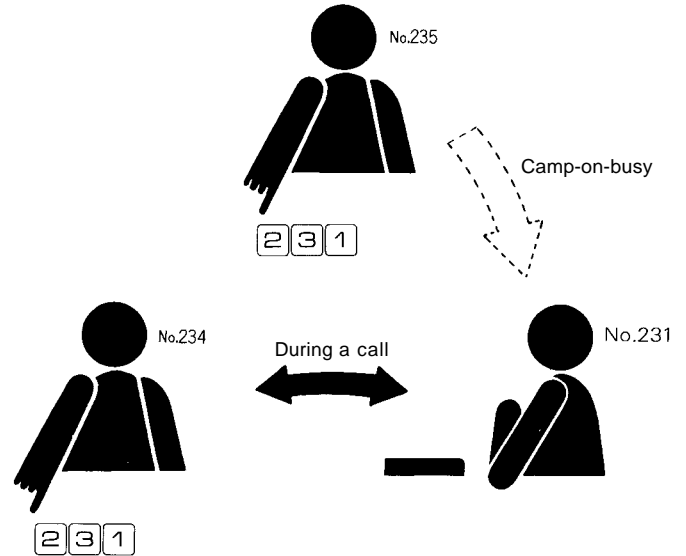
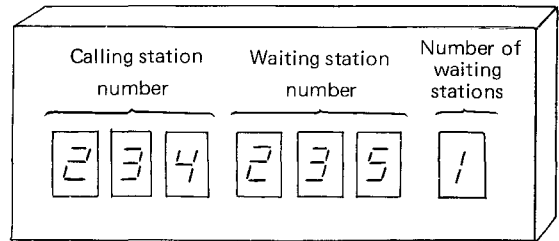

Pocket Pager

The system can be connected with usual type Pocket pager using the interface with Make/break relay output.

1. Dial



(000~239, terminal No.)

and the pager is called.

2. When



000~239(personal terminal No.)

is dialed by the party called from the nearest master station, it is possible to respond a call to the station.

Note 1: Once a receiver is called from one station and a response is waited for, camp-on-busy will result for other callers. But, if a response to the call is not received within 2 minutes, the terminal can be called from a new calling station.

Note 2: For further details, please refer to the Installation Hand Book for CPU-55 and Instructions for the Data Transmitting and Receiving Units.

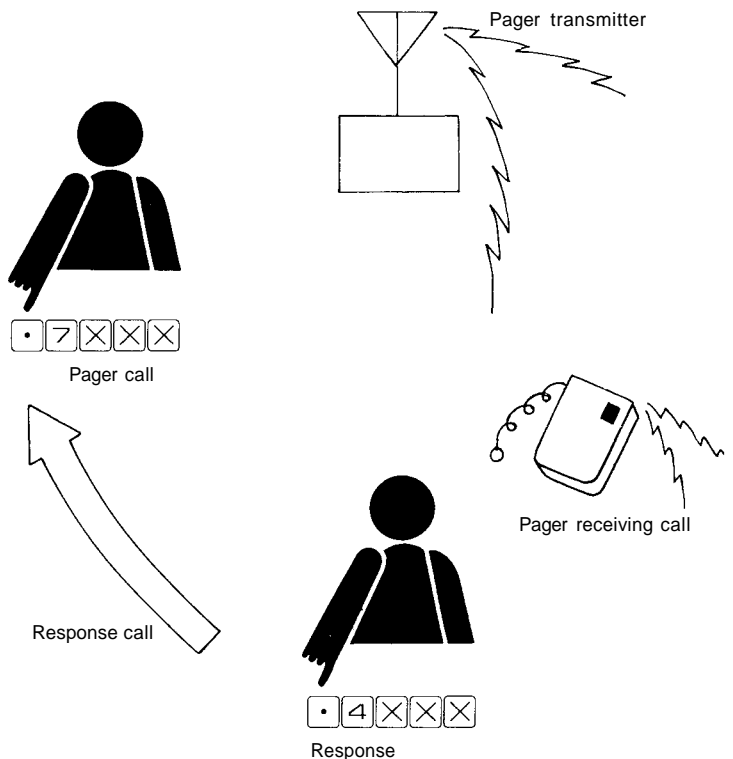

General Purpose Control

Station may be restricted from access to this function. This function can control other equipments by employing the Data Transmitting and Receiving Units.

Select the required type of output.

(Mode 1) One-shot make output

Dial



(000 ~ 499, max. of 500 contacts)

and the relay output is made for 1 to 2 seconds.

Example: Door remote and VTR control

Note: Operation performed even when all link circuits are occupied.

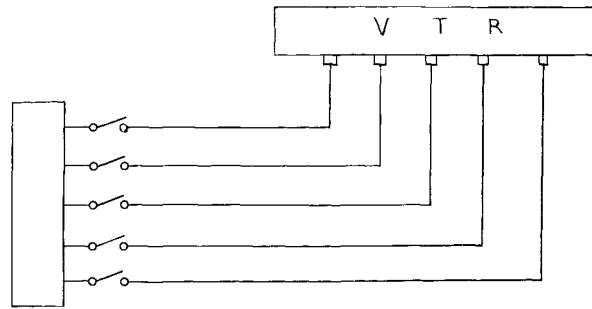

Control with one-shot make output

(Mode 2) Make/break output

Dial



(000 ~ 511, max. of 512 contacts)

and the make output is sent out.

Dial



(000-511, max. of 512 contacts)

and the break output is sent out.

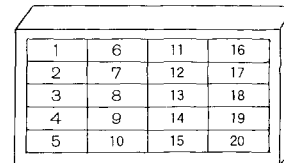

Lamp on/off indication panel

(Mode 3) 8 selectable make output and/or decimal output

(A) Unit block number (max. 9)

Dial



(X_1 is unit No., Y_1 is condition No.)

and one of the 8 relay outputs is made, and the condition is indicated numerically. Select the required output type.

(B) Unit block number (max. of 64 (99))

Dial

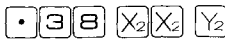

(X_2 and X_2 are unit No., Y_2 is condition No.)

and one of the 8 relay outputs is made, and the condition is indicated numerically. Select the required output type.

Example: Destination indication, room condition indication, ITV control

Dialing	037X ₁ Y ₂		038X ₂ X ₂ Y ₂	
	Unit No.	Condition No.	Unit No.	Condition No.
Output No.	X ₁	Y ₁	X ₂ X ₂	Y ₂
8 selectable output	1 ~ 9	0 ~ 7	01 ~ 64	0 ~ 7
Decimal output	1 ~ 9	0 ~ 9	01 ~ 99	0 ~ 9

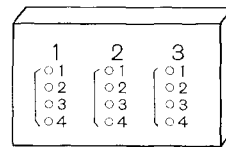

8 selectable output type indication panel

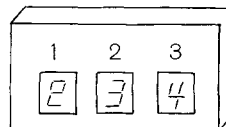

Decimal output type indication panel

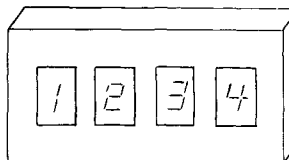

4 decimal digits

(Mode 4) 4 decimal digits output

Dial

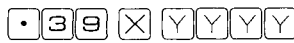

(X is unit No. (1~9),
YYYY is 4 decimal
digits (0000~9999))

and 4 decimal digits are indicated.

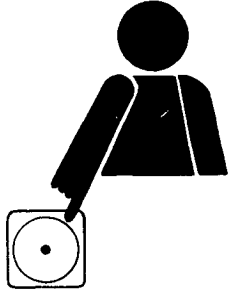

Note 1: In the event that an error has been made when dialing for Transfer or Conference, at the start of or during the conversation, dial



This will restore the condition before the error was made, allowing the caller to make a correction without interrupting the call.

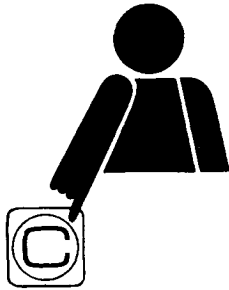

Note 2: To terminate conversation, dial





TOA ELECTRIC CO., LTD.
KOBE, JAPAN

Free Manuals Download Website

<http://myh66.com>

<http://usermanuals.us>

<http://www.somanuals.com>

<http://www.4manuals.cc>

<http://www.manual-lib.com>

<http://www.404manual.com>

<http://www.luxmanual.com>

<http://aubethermostatmanual.com>

Golf course search by state

<http://golfingnear.com>

Email search by domain

<http://emailbydomain.com>

Auto manuals search

<http://auto.somanuals.com>

TV manuals search

<http://tv.somanuals.com>