



QUICK MANUAL

**DIGITAL VIDEO
RECORDER**

**C-DR091 CU Series
C-DR161 CU Series**

Thank you for purchasing TOA Digital Video Recorder. Please carefully follow the instructions in this manual to ensure long, trouble-free use of your equipment.

TOA Corporation

TABLE OF CONTENTS

1. SAFETY PRECAUTIONS	3
2. NOMENCLATURE AND FUNCTIONS	
[Front]	6
[Rear]	7
3. CONNECTIONS	8
4. EXTERNAL TERMINAL CONNECTIONS	
4.1. Alarm Input Terminal Connections	9
4.2. Control I/O Terminal Connections	10
4.3. 10BASE-T/100BASE-TX Terminal Connections	10
5. DIGITAL VIDEO RECORDER ACTIVATION AND TERMINATION	11
5.1. Recorder's Activation	11
5.2. Recorder's Power Off and Disconnect	11
6. MAIN MENU SETTING	
6.1. About the Main Menu Settings	11
6.2. Setting Item List	12
7. INITIAL SETTINGS	
7.1. Setting the DVR-ID	14
7.2. Clock Settings	14
7.3. Hard Disk Initialization	15
7.4. Auto-Recording Settings	16
8. MONITOR DISPLAY	
8.1. Full- Screen Display	18
8.2. Multi-Segment Split- Screen Display	18
8.3. Sequence Display	19
8.4. Zoom Display	19
9. RECORDING	
9.1. Priority Recording	20
9.2. Auto Recording (Alarm Event Recording and Normal Recording)	20
10. PLAYBACK	
10.1. Playback	21
10.2. Reverse playback	21
10.3. Playback stop	21
10.4. Earliest image display	21
10.5. Latest image reverse playback	21
10.6. Fast forward/reverse playback	21
10.7. Pause	22
10.8. Frame advance/reverse playback	22
10.9. Instance event access	22
11. SEARCH	
11.1. Date/Time Search	23
12. ARCHIVE	
12.1. Archiving by Entering the Date and Time	24
13. SPECIFICATIONS	25

1. SAFETY PRECAUTIONS

- Before installation or use, be sure to carefully read all the instructions in this section for correct and safe operation.
- Make sure to observe the instructions in this manual as the conventions of safety symbols and messages regarded as very important precautions are included.
- We also recommend you keep this instruction manual handy for future reference.

Safety Symbol and Message Conventions

Safety symbols and messages described below are used in this manual to prevent bodily injury and property damage which could result from mishandling. Before operating your product, read this manual first and understand the safety symbols and messages so you are thoroughly aware of the potential safety hazards.



WARNING

Do not expose the unit to rain or an environment where it may be splashed by water or other liquids, as doing so may result in fire or electric shock.



WARNING

Indicates a potentially hazardous situation which, if mishandled, could result in death or serious personal injury.

When Installing the Unit

- This is a class A product. In a domestic environment this product may cause radio interference in which case the user may be required to take adequate measures.
- Use the unit only with the voltage specified on the unit. Using a voltage higher than that which is specified may result in fire or electric shock.
- Do not cut, kink, otherwise damage nor modify the power supply cord. In addition, avoid using the power cord in close proximity to heaters, and never place heavy objects -- including the unit itself -- on the power cord, as doing so may result in fire or electric shock.
- Avoid installing or mounting the unit in unstable locations, such as on a rickety table or a slanted surface. Doing so may result in the unit falling down and causing personal injury and/or property damage.

When the Unit is in Use

- If any of the following irregularities occurs, immediately switch off the power, disconnect the power supply plug from the AC outlet and inform the shop from where the unit was purchased. Further using the unit may result in fire or electric shock.
 - If you detect smoke or a strange smell coming from the unit
 - If water or any metallic object gets into the unit
 - If the unit falls, or the unit case breaks
 - If the power supply cord is damaged (exposure of the core, disconnection, etc.)
 - If no image appears
- To prevent a fire or electric shock, never open the unit case nor modify the unit as there are high voltage components inside the unit. Refer all servicing to your nearest TOA dealer.
- Do not place cups, bowls, or other containers of liquid or metallic objects on top of the unit. If they accidentally spill into the unit, this may cause a fire or electric shock.
- Do not insert nor drop metallic objects or flammable materials in the ventilation slots of the unit's cover, as this may result in fire or electric shock.
- Do not touch the power supply plug or control line during thunder and lightning, as this may result in electric shock.
- The socket-outlet shall be installed near the equipment and the plug (disconnecting device) shall be easily accessible.



CAUTION

Indicates a potentially hazardous situation which, if mishandled, could result in moderate or minor personal injury, and/or property damage.

When Installing the Unit

- Never plug in nor remove the power supply plug with wet hands, as doing so may cause electric shock.
- When unplugging the power supply cord, be sure to grasp the power supply plug; never pull on the cord itself. Operating the unit with a damaged power supply cord may cause a fire or electric shock. When removing the power cord, be sure to hold its plug to pull.
- When moving the unit, be sure to remove its power supply cord from the wall outlet. Moving the unit with the power supply cord connected to the outlet may cause damage to the power supply cord, resulting in fire or electric shock.
- Do not block the ventilation slots in the unit's cover. Doing so may cause heat to build up inside the unit and result in fire.
- Avoid installing the unit in humid or dusty locations, in locations exposed to the direct sunlight, near the heaters, or in locations generating sooty smoke or steam as doing otherwise may result in fire or electric shock.
- Do not connect a network terminal exposed to excessive voltage to the 100BASE-TX terminal, Disk array connection terminal or Remote control I/O terminal A, as doing so may result in fire or electric shock.

When the Unit is in Use

- Do not place heavy objects on the unit as this may cause it to fall or break which may result in personal injury and/or property damage. In addition, the object itself may fall off and cause injury and/or damage.
- Clean the unit periodically. Contact your TOA dealer regarding the cleaning. If dust is allowed to accumulate in the unit over a long period of time, a fire may result.
- If dust accumulates on the power supply plug or in the wall AC outlet, a fire may result. Clean it periodically. In addition, insert the plug in the wall outlet securely.
- Switch off the power, and disconnect the power supply plug from the AC outlet when cleaning or leaving the unit unused for long periods of time. Doing otherwise may cause a fire or electric shock.
- An all-pole mains switch with a contact separation of at least 3 mm in each pole shall be incorporated in the electrical installation of the building.

The equipment must be connected to an earthed mains socket-outlet.

-Finland

"Laitte on liitettävä suojamaadoituskoskettimilla varustettuun pistorasiaan"

-Norway

"Apparatet må tilkoples jordet stikkontakt"

-Sweden

"Apparaten skall anslutas till jordat uttag"

CU version complies with Part 15 of the FCC Rules.

Note

This equipment has been tested and found to comply with the limits for a Class A digital device, pursuant to Part 15 of the FCC Rules. These limits are designed to provide reasonable protection against harmful interference when the equipment is operated in a commercial environment. This equipment generates, uses, and can radiate radio frequency energy and, if not installed and used in accordance with the instruction manual, may cause harmful interference to radio communications. Operation of this equipment in a residential area is likely to cause harmful interference in which case the user will be required to correct the interference at his own expense.

Modifications

Any modifications made to this device that are not approved by TOA Corporation may void the authority granted to the user by the FCC to operate this equipment.

This equipment is classified as a LASER CLASS 1 PRODUCT. The following classification label is located on the drive.

CLASS 1 LASER PRODUCT
CAUTION:
INVISIBLE LASER RADIATION WHEN OPEN.
AVOID EXPOSURE TO BEAM.

2. NOMENCLATURE AND FUNCTIONS

[C-DR161 Series Front]

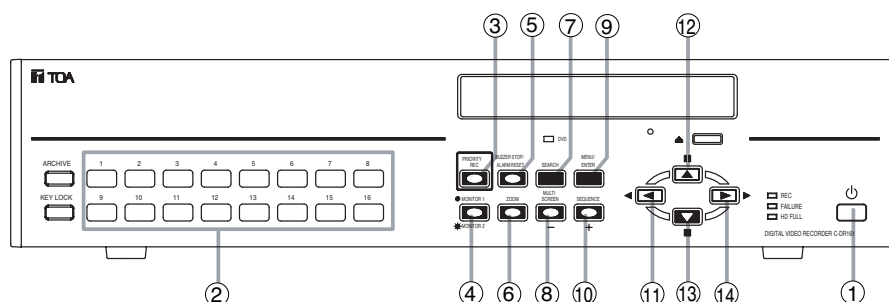

- (1) **Power key** []
Pressing the Power key changes the Digital Video Recorder's mode from standby to operation mode. To switch from operation mode to standby mode, hold down the Power key for 2 seconds or more.
- (2) **Camera selector key**
Pressing the Camera selector key displays the corresponding camera image on the full screen.
- (3) **Priority recording key**
Used to start priority recording. To stop priority recording, hold down the Priority recording key for 2 seconds or more. The Priority recording key flashes red during priority recording.
- (4) **Monitor key**
Use this key when switching operation between Monitor 1 and Monitor 2 outputs. Monitor 1 output is enabled when the key is unlit, and Monitor 2 output is enabled when the key is lit.
- (5) **Buzzer stop key (Alarm reset key)**
Use this key to reset alarm event recording. This key is also used to stop a buzzer tone.
- (6) **Zoom key**
Use the Zoom key to zoom in on the live and playback screens (2x zoom).
- (7) **Search key**
Use this key to search for recorded images.
- (8) **Multi-Screen / [-] Key**
 - Display on the multi-segment split screen.
 - Pressing this key while setting values are selected on the menu screen varies setting values in the reverse direction.
- (9) **Menu key**
 - Holding down the Menu key for 2 seconds or more when in live mode displays the menu screen on Monitor 1 screen.
 - Use this key when confirming selected setting items on the menu screen.
 - Holding down the Menu key for 2 seconds or more when the Security setting is activated displays the Password entry screen.
- (10) **Sequence/ [+] Key**
 - Pressing the Sequence key in live mode causes the camera outputs to be displayed in preprogrammed sequential order.
 - Pressing the setting value on the Menu screen during selection changes the setting value in forward direction.
- (11) **Reverse playback** [] key
 - Images are played back in reverse if the Reverse playback key is pressed.
 - Use this key to move the cursor to the left on the menu screen.
- (12) **Pause** [,] key
 - Use this key to temporarily stop the playback display. Operation can be performed for the archive menu display, frame advance/reverse playback, and instant event access playback while the display is temporarily stopped.
 - Used this key to move the cursor upward on the Menu screen.
- (13) **Stop** [,] key
 - Use this key to stop playback or reverse playback.
 - Use this key to move the cursor downward on the Menu screen.
- (14) **Playback** [] key
 - Pressing the Playback key plays back recorded images.
 - Use this key to move the cursor to the right on the Menu screen.

[C-DR161 series Rear]

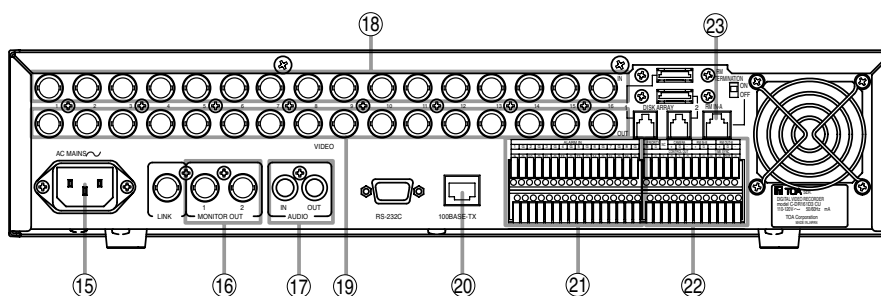

(15) AC inlet

Connect the supplied power cord to this socket.

(16) Monitor output terminal

- **Monitor 1 output terminal**
Outputs the Monitor 1's camera images.
- **Monitor 2 output terminal**
Outputs the Monitor 2's camera images.

(17) Audio input/output terminal

- **Audio input terminal**
This terminal is used for audio recording.
- **Audio output terminal**
Outputs audio input terminal signals during live screen display, and outputs the recorded audio during playback display.

(18) Video input terminal

Connect the camera to this terminal. Connecting the camera automatically terminates the Digital Video Recorder at 75 Ω .

(19) Video output terminal

A loop through output for the Video input terminal. Connecting the BNC plug to the Video output terminal automatically cancels the 75 Ω termination.

(20) 10BASE-T/100BASE-TX terminal

Use this terminal to remotely monitor or control cameras connected to the Digital Video Recorder or search or play back their recorded images through the network using the web browser from a PC.

(21) Alarm input terminal

Use this terminal to make Alarm event recording. Connect no-voltage contact signals of sensors, etc. to this terminal.

(22) Control input/output terminal

- **Control output terminal**
Outputs a signal during equipment failure occurs.
- **Priority recording input terminal**
Use this terminal to begin Priority recording using signals from connected external equipment.
- **Time sync input & output terminal**
Use this terminal to synchronize the clocks of multiple Digital Video Recorders used in the system.
- **Remote Control Input/Output Terminal B**
Use this terminal for connection of the C-RM1000 Remote Controller.
- **Camera control terminal**
Use this terminal to control the Combination Camera.

Note

The C-RM1000 Remote Controller must be connected to the Digital Video Recorder in order to control the Combination Camera.

(23) Remote controller input/output terminal A (Power can be supplied.)

Use this terminal to connect the C-RM1000 Remote Controller.

3. CONNECTIONS

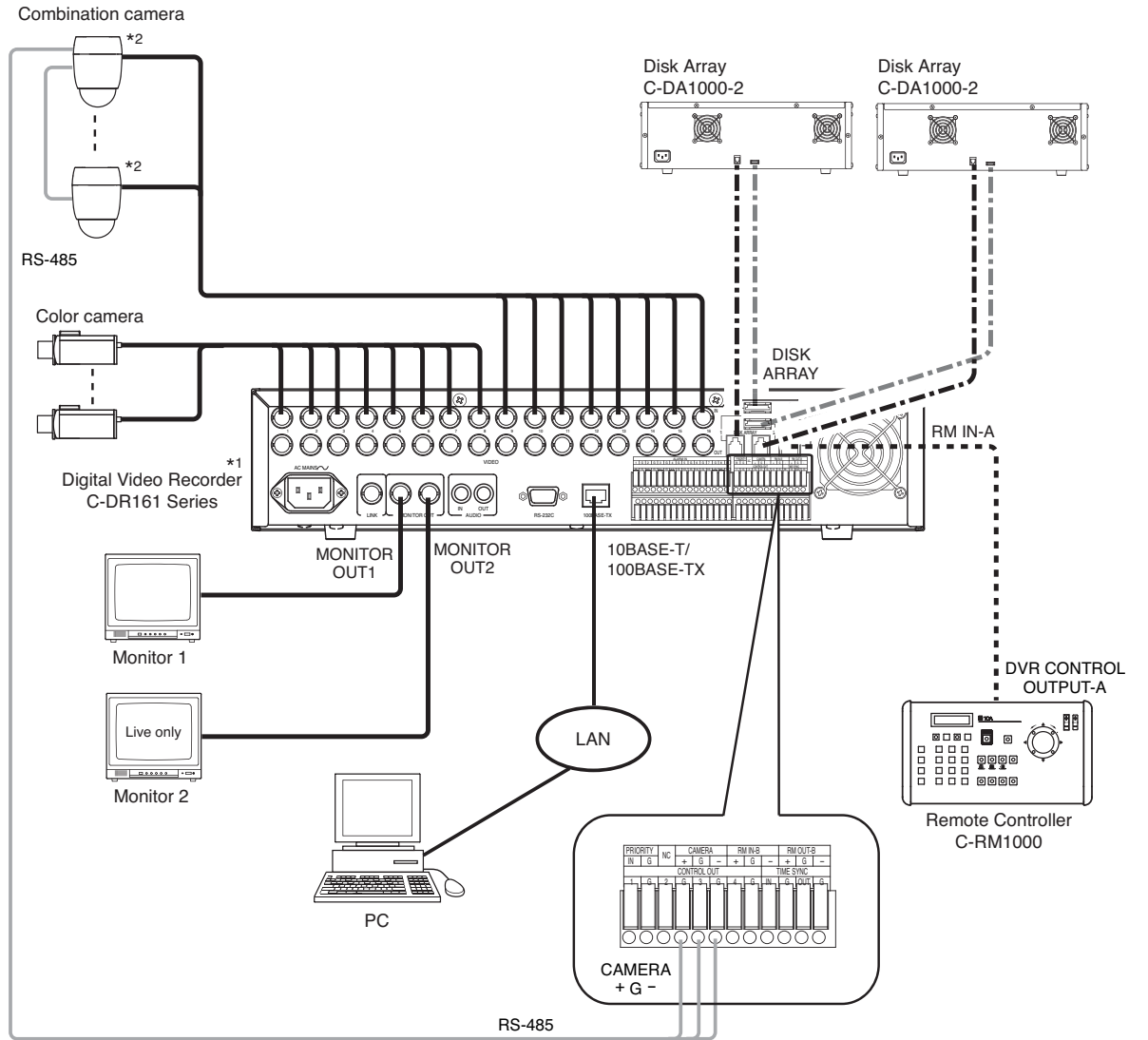

*1 C-DR091 and C-DR161 Series
 C-DR091: 9 I/O Terminals
 C-DR161: 16 I/O Terminals

*2 Match the Combination Camera's address to the Digital Video Recorder's video input number.

- : Coaxial cable (Video signal)
- — — : CPEV-S 0.65 (RS-485 Control line)
Twisted pair with shield 22AWG or larger
- · · · · : Modular cable, 3 m (9.8 ft).
(supplied with the C-RM1000)
- - - - - : Modular cable, 1 m (3.3 ft)
(supplied with Disk Array)
- · - · - : eSATA cable, 1 m (3.3 ft)
(supplied with Disk Array)

4. EXTERNAL TERMINAL CONNECTIONS

4.1. Alarm Input Terminal Connections

The number of terminals available differs depending on whether the Digital Video Recorder is a 9-channel or a 16-channel version. Refer to the table below when making alarm input terminal connections.

For 16 channel

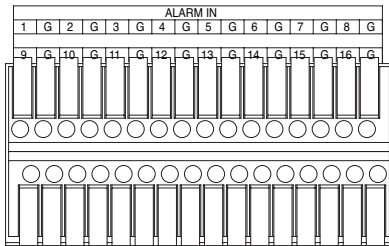

For 9 channel

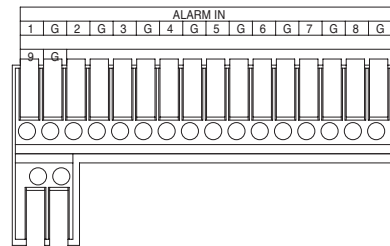

Terminal name	Symbol	Name	Terminal name	Symbol	Name
1	ALARM 1	Alarm input 1	9	ALARM 9	Alarm input 9
G	GND	Signal ground	G	GND	Signal ground
2	ALARM 2	Alarm input 2	10	ALARM 10	Alarm input 10
G	GND	Signal ground	G	GND	Signal ground
3	ALARM 3	Alarm input 3	11	ALARM 11	Alarm input 11
G	GND	Signal ground	G	GND	Signal ground
4	ALARM 4	Alarm input 4	12	ALARM 12	Alarm input 12
G	GND	Signal ground	G	GND	Signal ground
5	ALARM 5	Alarm input 5	13	ALARM 13	Alarm input 13
G	GND	Signal ground	G	GND	Signal ground
6	ALARM 6	Alarm input 6	14	ALARM 14	Alarm input 14
G	GND	Signal ground	G	GND	Signal ground
7	ALARM 7	Alarm input 7	15	ALARM 15	Alarm input 15
G	GND	Signal ground	G	GND	Signal ground
8	ALARM 8	Alarm input 8	16	ALARM 16	Alarm input 16
G	GND	Signal ground	G	GND	Signal ground

4.1.1. Terminal connection

The terminal connector is unlocked by pressing down on its release button. To connect the cable, press down on the release button first, insert the cable, then push the release button up again to lock the cable in place. However, for solid cables with diameters from 0.8 mm (AWG20) to 1.2 mm (AWG16), there is no need to press down on the release button. Cable can be connected simply by inserting it in place until it will not go any further.

Note

Ensure that the cable is securely locked into the terminal after connection.

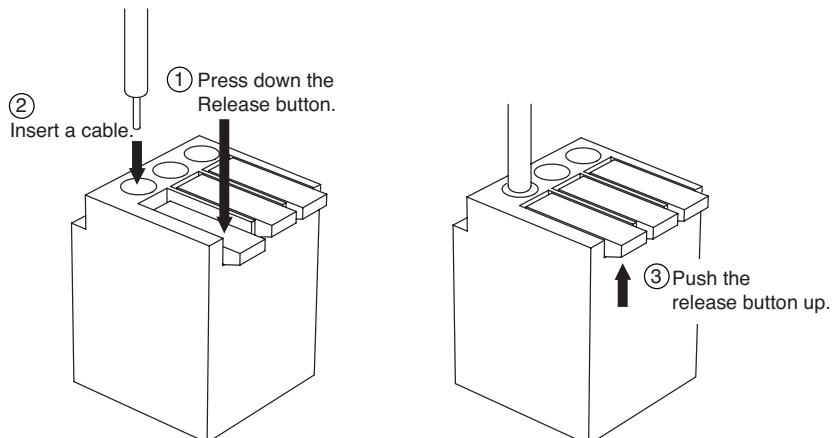

Applicable cable

- Solid conductor
AWG26 (ø 0.4 mm) –
AWG16 (ø 1.2 mm)
- Stranded conductor
AWG24 (0.2 mm²) –
AWG20 (0.75 mm²)

4.2. Control I/O Terminal Connections

The control input and output terminals include: priority recording terminal, camera control terminal, remote controller input/output terminals, control output terminal, and time synchronization input/output terminals.

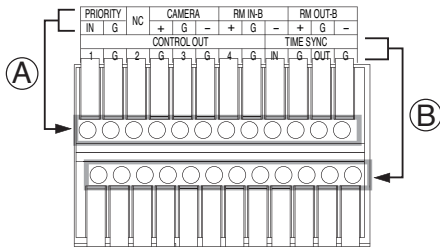

Terminal name (A)	Name	Terminal name (B)	Name
PRIORITY IN	Priority Recording Input	CONTROL OUT 1	Control Output 1
PRIORITY G	Priority Recording Ground	CONTROL OUT G	Control Output Ground
NC	Not connected	CONTROL OUT 2	Control Output 2
CAMERA +	Camera Control (RS-485) +	CONTROL OUT G	Control Output Ground
CAMERA G	Camera Control (RS-485) Ground	CONTROL OUT 3	Control Output 3
CAMERA -	Camera Control (RS-485) -	CONTROL OUT G	Control Output Ground
RM IN-B +	Remote Control Input B + (RS-485)	CONTROL OUT 4	Control Output 4
RM IN-B G	Remote Control Input B Ground	CONTROL OUT G	Control Output Ground
RM IN-B -	Remote Control Input B - (RS-485)	TIME SYNC IN	Date/Time Adjustment Input
RM OUT-B +	Remote Control Output B + (RS-485)	TIME SYNC G	Date/Time Adjustment Input Ground
RM OUT-B G	Remote Control Output B Ground	TIME SYNC OUT	Date/Time Adjustment Output
RM OUT-B -	Remote Control Output B - (RS-485)	TIME SYNC G	Date/Time Adjustment Output Ground

Notes

- Ensure that the cable is securely locked into the terminal after connection.
- Use the CPEV-S cable (twisted pair shielded cable) with diameter larger than 0.65 mm for the Control Input/Output terminal connections. Also be sure to connect the shielded cable to the GND terminal.
- The maximum cable length of the control cable from the Digital Video Recorder to the camera of which termination is set to ON is 1.2 km. Also the maximum cable length of the control cable from the Remote Controller to the Digital Video Recorder of which termination switch is set to ON is 1.2 km.

4.2.1. Time synchronization input/output terminal connections

Two different methods are available to synchronize the time, one using both master and slave units, the other using NTP.

Note

When using a single-channel Digital Video Recorder, set the synchronization interval to "5 seconds."



To synchronize the times of slave units with the time of the master unit, connect the slave units to the master unit in a series via their input and output terminals. In other words, connect the input of slave number one to the master unit's output and the input of slave number two to slave number one's output, and so on.

4.3. 10BASE-T/100BASE-TX Terminal Connections

Use this terminal to remotely monitor or control cameras connected to the Digital Video Recorder, or search or play back their recorded images on a PC web browser. When connecting a PC directly to the Digital Video Recorder, use a network crossover cable. Use the straight-through cable for connection between them via a switching hub.

5. DIGITAL VIDEO RECORDER ACTIVATION AND TERMINATION





5.1. Recorder's Activation

1. Insert the power supply plug.

The Recorder is placed in standby mode. The power key flashes at about 5-second intervals while in standby mode.

Note

Do not pull out the power supply plug while the Power key is light green. Ensure that the Recorder is in the standby mode when pulling out the power supply plug. Logged data could be damaged or lost if the power supply plug is pulled out during initialization (while accessing the hard disk).

Power key	LED indicator	Mode
	Distinguishes	Main power OFF
	Flashes (5sec)	Standby mode
	Flashes (1sec)	During a system check (during activation)
	Lights	Power ON (during operation)

2. Press the Power key while the Recorder is in standby mode.

The Power key flashes green during a system check. The Power key changes from flashing to steady ON after system check completion, allowing camera images to be displayed.

5.2. Recorder's Power Off and Disconnect

Hold down the Power key for 2 seconds or more. All operations stop, placing the Recorder in standby mode. When moving the Recorder, be sure to place it in standby mode, then remove the power supply plug from the wall outlet.

6. MAIN MENU SETTING

6.1. About the Main Menu Settings



To perform each setting, display the Menu screen when in live mode.

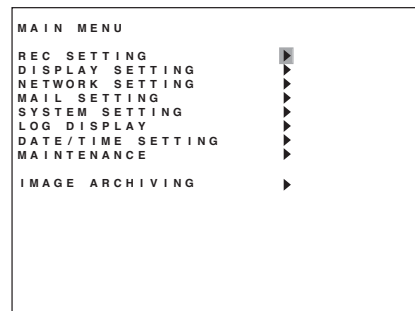

1. Holding down the Menu key for 2 seconds or more.
Displays the Menu screen.

Notes

- Menu screen is not displayed while the Monitor Output 2 is selected. (while the Monitor key is lit).
- Display the Menu screen after returning to the live mode when in playback mode.
- Menu screen is not displayed while in zoom mode and during zoom display (while zoom key is lit)



2. To move the cursor, use the [] and [] keys.

The [] and [] keys can be used to move the cursor only when there are setting parameters.

3. To select or change parameters, use the [+] and [-] keys.

4. Press the Menu key at the ► mark at the desired setting item.

If no change has been made to the current parameter:

The screen moves to the next screen.

If changes have been made:

Save setting confirmation message is displayed. (Refer to the next page.)

5. To exit the setting and return to the previous screen, press the [] key at the leftmost parameter position of the screen.

A Save Setting confirmation dialog is displayed if changes have been made. If set value has not been changed, the screen moves to the previous screen, Exits the Menu screen when the Main Menu screen is displayed.

6.2. Setting Item List

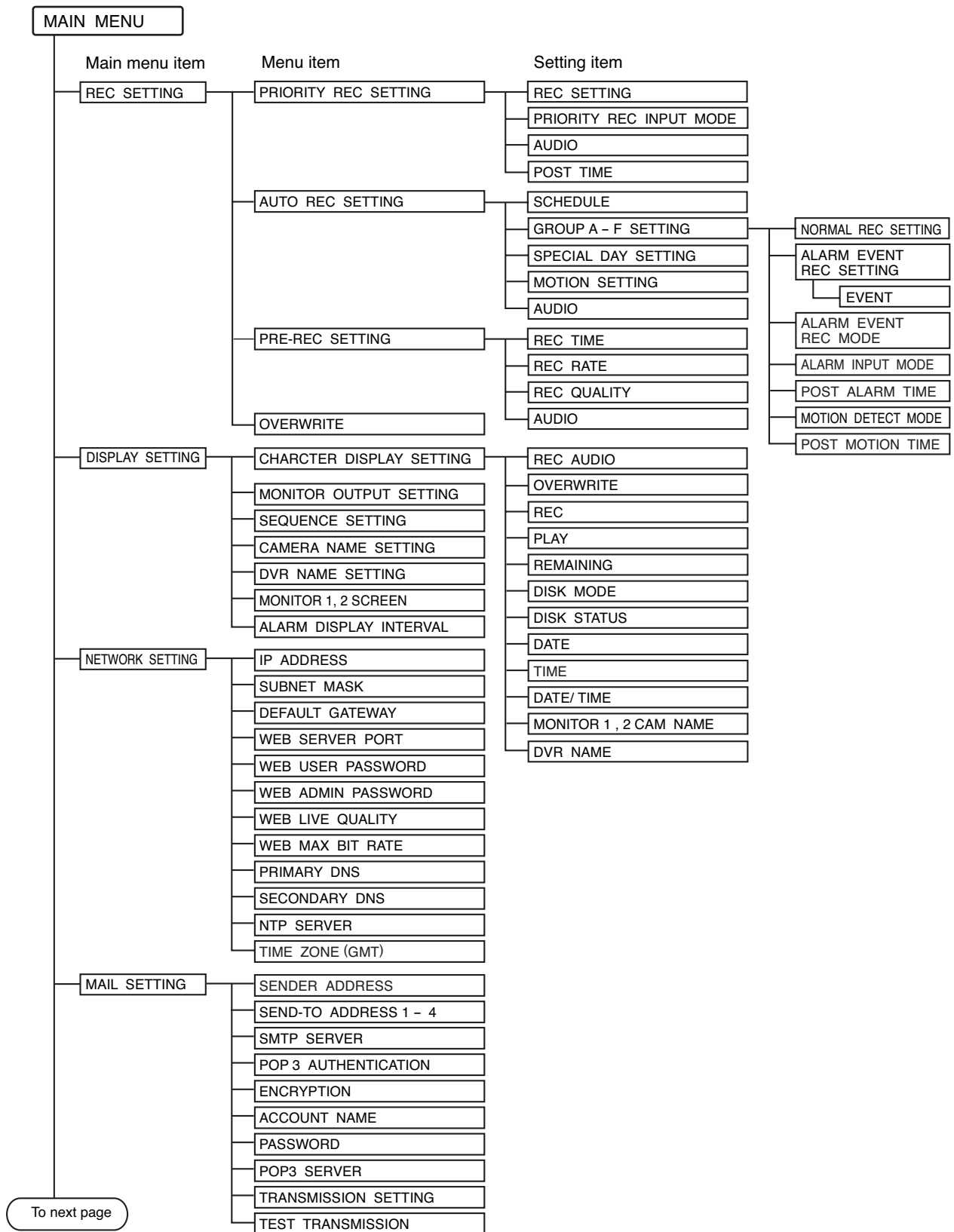

To previous page

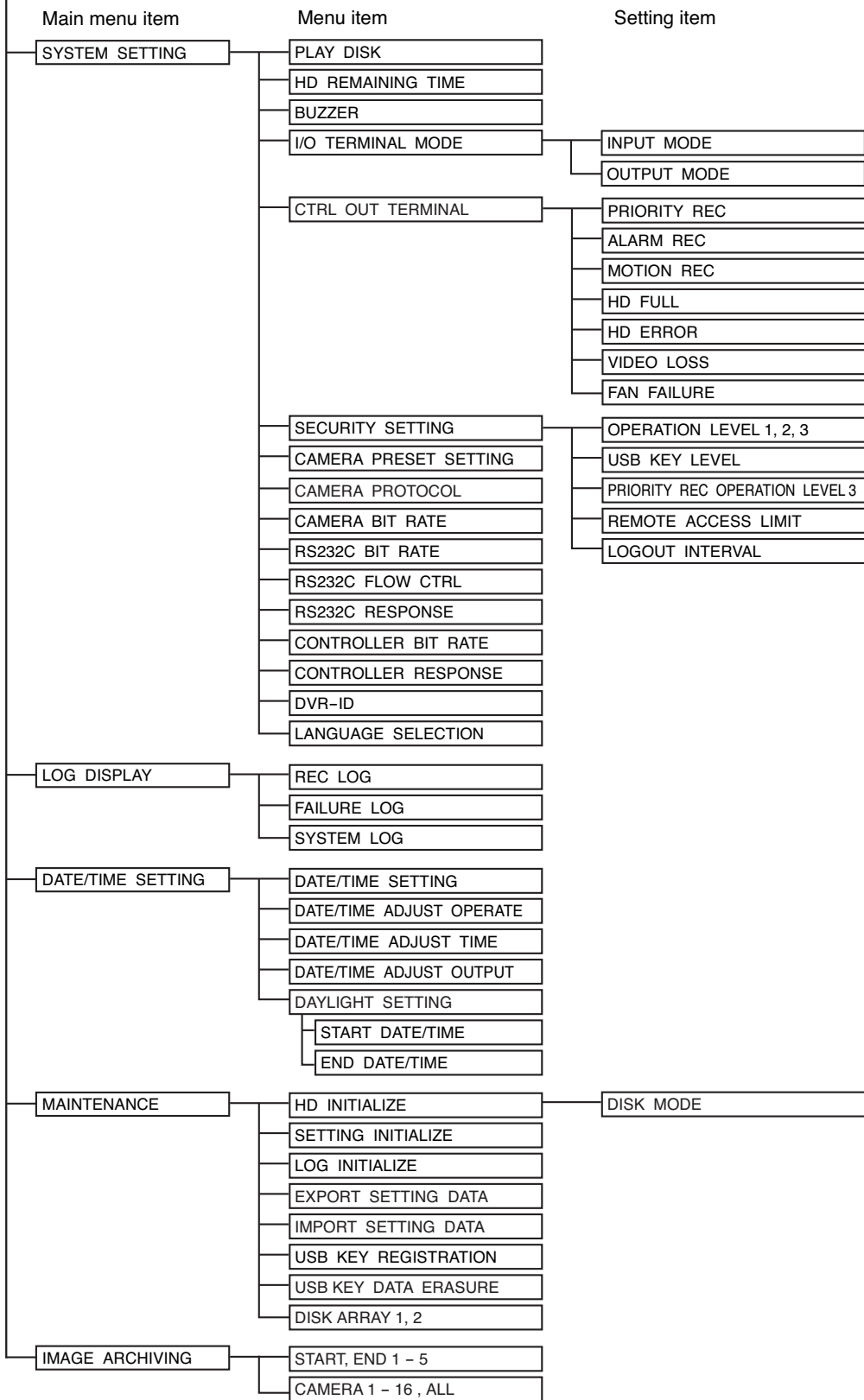

7. INITIAL SETTINGS

Be sure to perform the following settings before using the Digital Video Recorder. Failure to do so may lead to incorrect operation of each function.

- DVR-ID setting (When cascade-connecting)
Note: When cascade-connecting the Digital Video Recorders, set the DVR-ID first. Otherwise, the Menu screen is not displayed.
- Clock settings
- Hard disk initialization
- Auto-Recording settings

7.1. Setting the DVR-ID

When cascade-connecting the Digital Video Recorders, set different DVR-ID for all individual Digital Video Recorders. DVR-ID are all factory-preset to "1." Follow the procedure below to set DVR number.

1. Press the Digital Video Recorder's Power key while holding down the Sequence key in standby mode. Camera Selection keys 1 – 8 flashes for about 1minute.
2. Press the desired DVR-ID to set.
The selected number flashes three times, then the number is programmed as DVR-ID.

Note: It is impossible to operate the Digital Video Recorder when the main power is set to OFF. Operate the Digital Video Recorder after placing it in standby mode.

7.2. Clock Settings

Perform clock settings of the Digital Video Recorder. Adjust the date and time in Clock Settings on the menu screen.

Notes

- If the clock setting is not performed, video recordings are not made according to the schedule set in the auto-recording setting.
- In some cases, changing the current time may make it impossible to play back the recorded images correctly when duplicated time data exists in the recording data.

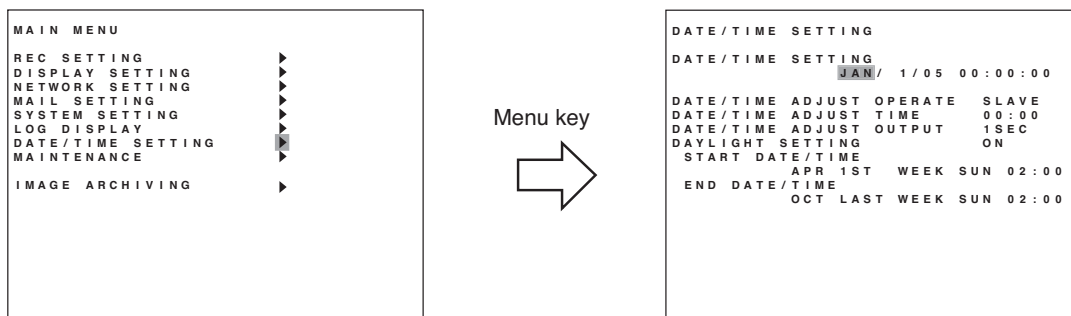

1. Hold down the Menu key for 2 seconds or more.
The main menu screen is displayed.
2. Move the cursor with the [▲] and [▼] keys to select "DATE/TIME SETTING," then press the Menu key.
The clock setting screen is displayed.
3. Move the cursor with the [◀] and [▶] keys and perform clock settings using the [+] and [-] keys.
Set year, month, date, hour, minute, and second.
4. Press the [◀] key while the cursor is set to the leftmost selection item on the screen.
The indication will appear to ask whether or not to save the setting.

- Move the cursor with the [◀] and [▶] keys, select "YES," then press the Menu key.
The message requesting a reboot is displayed.

Note

There is no need to reboot the DVR if not synchronizing using the NTP server, though the message requesting a reboot is displayed after the clock setting has been saved. (The changed setting is reflected in the device without rebooting the DVR.)

- Move the cursor with the [◀] and [▶] keys to select "NO," then press the Menu key.
The display reverts to the main menu screen.

7.3. Hard Disk Initialization

Set disk mode (normal mode and mirror mode) used for recording to the hard disk to initialize the hard disk.

Notes

- Since initializing the hard disk erases all recorded images, be sure to copy the necessary data to DVD-R disk or USB memory before initialization.
- Disk mode is factory-preset to "NORMAL." Leave the disk mode as it is when using the Digital Video Recorder in normal mode. However, it is recommended that the hard disk be initialized since recording starts automatically when the Digital Video Recorder's power is switched on.

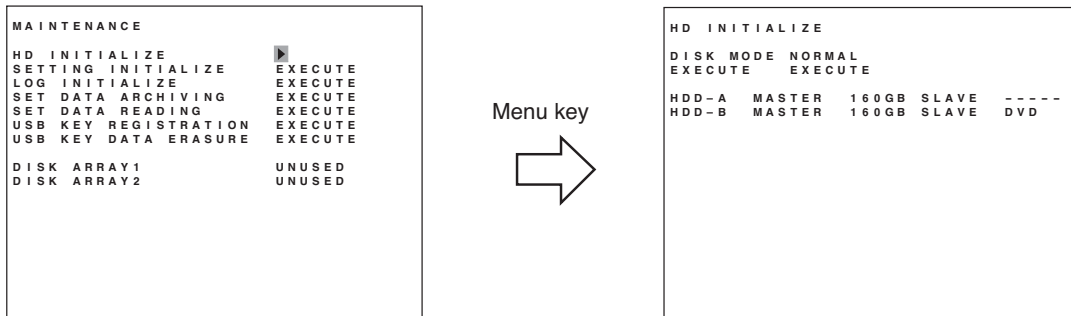

- Hold down the Menu key for 2 seconds or more.
The main menu screen is displayed.
- Move the cursor with the [▲] and [▼] keys to select "MAINTENANCE," then press the Menu key.
The Equipment Maintenance screen is displayed.
- Select "HD INITIALIZE," then press the Menu key.
The Hard Disk Initialization screen is displayed.
- Select the disk mode using the [+] and [-] keys.
Select "NORMAL," or "MIRROR."
- Move the cursor with the [▲] and [▼] keys to select "EXECUTE," then press the Menu key.
"YES" and "CANCEL" are displayed.
- Move the cursor with the [◀] and [▶] keys to select "YES," then press the Menu key.
Confirmation message is displayed after executing the hard disk initialization.
- Select "OK," then press the Menu key.
The display returns to the hard disk initialization screen.

7.4. Auto-Recording Settings

Recordings are normally performed according to the preprogrammed schedule. Therefore, perform schedule or group settings when making auto-recording.

7.4.1. Schedule setting

Set the schedule (Day, Start time, and End time) for each group to operate.

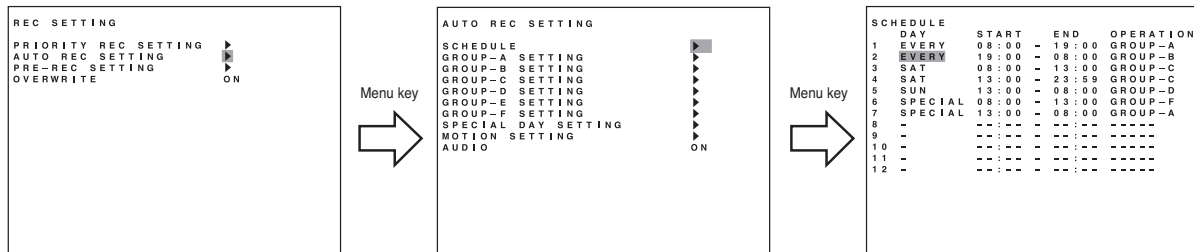





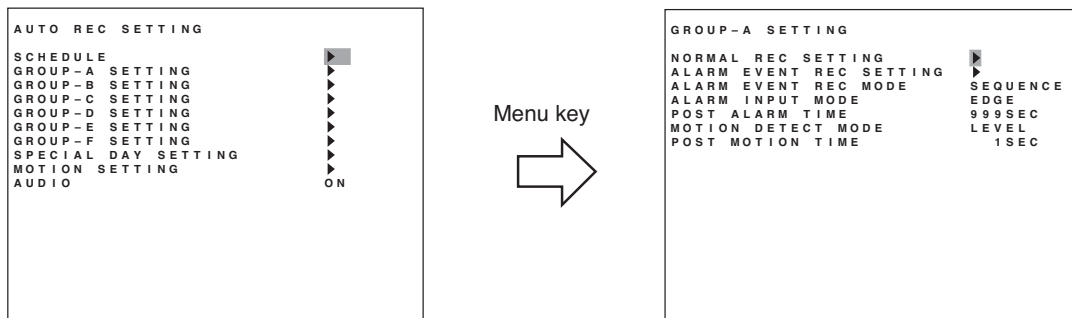

1. Hold down the Menu key for 2 seconds or more.
The main menu screen is displayed.
2. Select "REC SETTING," then press the Menu key. The Recording setting screen is displayed.
3. Move the cursor with the [▲] and [▼] keys to select "AUTO REC SETTING," then press the Menu key.
The Auto-recording setting screen is displayed.
4. Select "SCHEDULE," then press the Menu key.
5. Move the cursor with the [▲], [▼], [◀], and [▶] keys and perform schedule setting using the [+] and [-] keys.
Set a day of the week, Start time, End time and manner of operation (group setting).
6. Press the [◀] key while the cursor is set to the leftmost selection item on the screen.
The indication will appear to ask whether or not to save the setting.
7. Move the cursor with the [◀] and [▶] keys to select "YES," then press the Menu key.
The display reverts to the auto-recording setting screen.

7.4.2. Setting the group

Perform individual settings such as Normal recording and Alarm Event recording for Group A - F.



1. Choose "Group A-F" from the Auto-recording Settings and press the Menu key.
The Group setting screen is displayed.
2. Move the cursor with the [, [, [, and [] keys and perform Group setting using the [+]
and [-] keys.
3. Press the [] key while the cursor is set to the leftmost selection item on the screen.
The indication will appear to ask whether or not to save the setting.
4. Move the cursor with the [] and [] keys to select "YES," then press the Menu key.
The display reverts to the auto-recording setting screen.

7.4.3. Other settings

In Auto-Recording Settings, "special day," "motion detection," and "audio (ON/OFF)" settings can be performed in addition to both schedule and group settings.

8. MONITOR DISPLAY

8.1. Full-Screen Display

Pressing the Camera Selector key while in live or playback mode displays the selected camera output on the full screen.

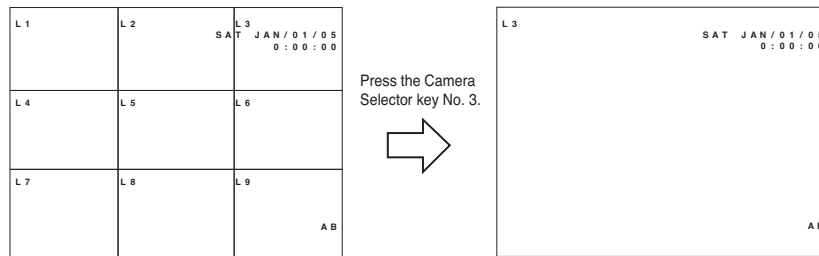

8.2. Multi-Segment Split-Screen Display

When the live or playback screen is displayed, the multi-segment split-screen display changes as shown below each time the Multi-Screen key is pressed. Multi-Screen key lights continuously during multi-Segment Split-Screen display.

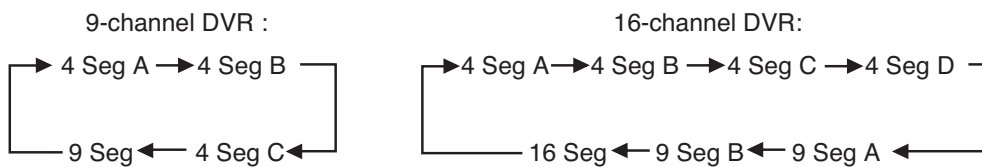

(Example) Screen display in live mode (9-channel DVR)

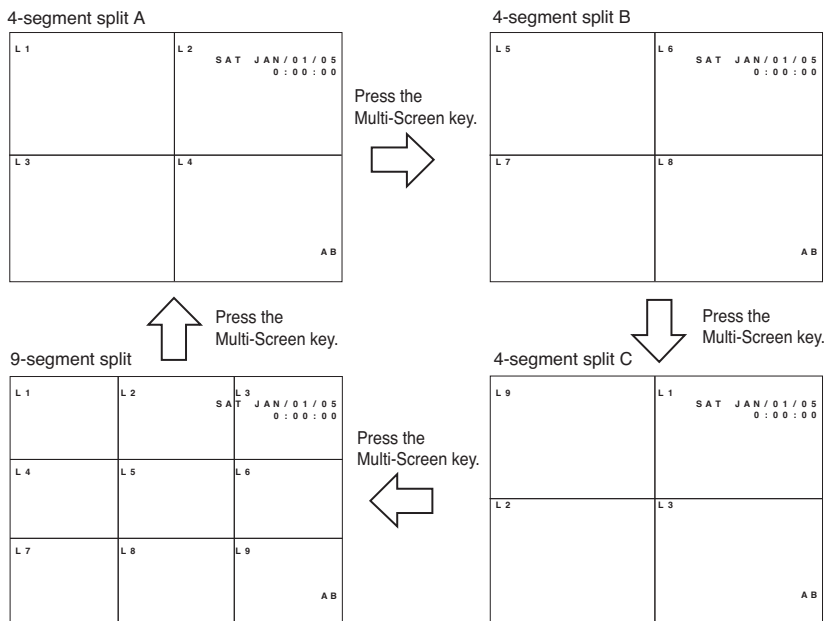

8.3. Sequence Display

Camera live images are displayed in sequential order when the Sequence key is pressed while in live mode. Viewing intervals and cameras to be displayed can be set on the menu screen. Sequence key lights continuously during Sequence display.

(Setting Example)

- Step 1 : Camera 1 3 seconds
- Step 2 : Camera 2 3 seconds
- Step 3 : Camera 3 3 seconds
- Step 4 : 4-split A 3 seconds

Note

That when the screen is switched, the picture may be distorted momentarily.

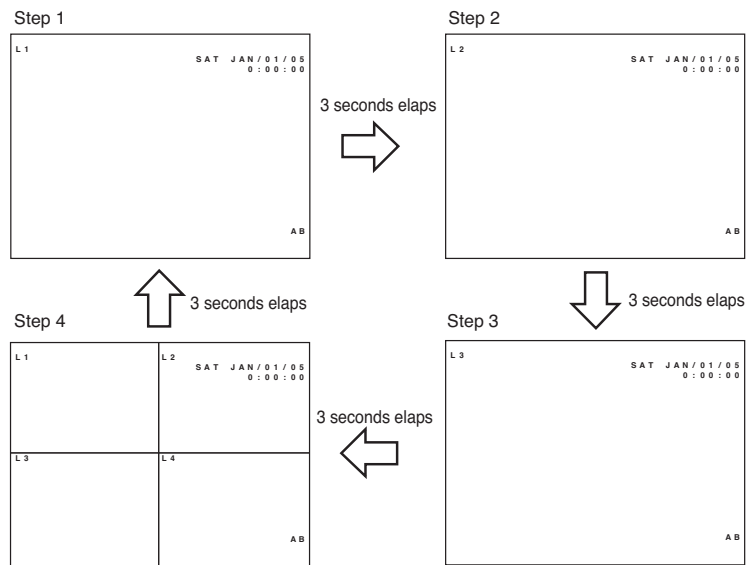

8.4. Zoom Display

Live or recorded full-screen images can be viewed in 2 x zoom display. Zoom key lights continuously while the Zoom selection screen or Zoom screen is displayed.

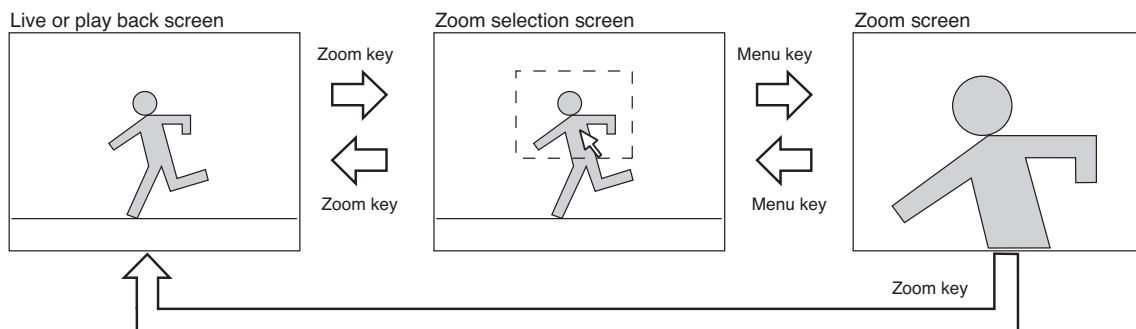

1. Press the zoom key
The zoom selection screen is displayed. The pointer is displayed on the screen.
2. Move the central point of the subject to be zoomed using the [▲], [▼], [◀], and [▶] keys, then press the Menu key.
The subject can be zoomed with the designated point at the center. Zoomed areas can be moved using the [▲], [▼], [◀], and [▶] keys even while zoomed.
3. Press the Menu key when the zoom screen is displayed.
The display reverts to the zoom selection screen. Pressing the Zoom key again when the zoom screen is displayed resets the zoom display.

Note

When channels are changed, multi-segment split-screen display is selected, or a search function is operated during zoom display, the zoom mode is reset.

9. RECORDING

9.1. Priority Recording

Priority recording is given higher priority over Auto recording. Use this recording mode to check recording details when, for example, a suspicious person intrudes or when making recording outside the scheduled time period. In the Priority Recording settings, the following settings can be made for individual cameras: recording ON/OFF, recording rate, picture quality and audio ON/OFF.

9.1.1. How to perform priority recording

1. Press the Priority Recording key to start the priority recording. To stop a buzzer sound, press the Buzzer Stop key.
2. Hold down the Priority Recording key for 2 seconds or more to terminate the priority recording.

9.2. Auto Recording (Alarm Event Recording and Normal Recording)

With auto-recording, recordings are made according to a preset schedule, which can include up to twelve different programs. If one or more programs have duplicate execution times, the program with a largest number takes precedence. Settable items for each program include: Day of the Week; Start/End Times; and Operation. Up to six settings groups, named A through F, can be made for "Operation," and recording settings for Normal and Alarm recording can also be registered. Further, up to sixty "special day" operational settings can also be made, with operation controlled by different programs, motion detection areas for individual cameras, and audio recording during auto- recording.

9.2.1. Alarm event recording

Alarm Event recording includes both "Alarm Input" and "Motion Detection" recording. For Alarm Event recording, settable items for each individual camera include: Recording ON/OFF; Recording Rate; and Picture Quality. It is also possible to set, for each recording mode, the type of events that will cause recording to begin.

For Alarm Event recording mode, it is possible to set the type of recording operation to be performed when multiple events have occurred simultaneously. Setting the mode to "Sequence" allows two or more events to be set for individual cameras. For Alarm Input recording time, set both alarm input mode and post alarm time intervals. For Motion Detection, set both motion detection mode and post-motion alarm time.

When an alarm event occurs, the corresponding camera's image is switched to full-screen display until the preset alarm time interval has elapsed, after which the display reverts to the original screen display.

Alarm input recording: Alarm Input recording begins when signals are received at the alarm input terminal on the rear panel. Use event settings to set cameras to be recorded. If "Sequence" is selected, up to four alarm input terminals can be set optionally per camera. If "Last" is selected, the "Alarm ON/OFF" can be set only for the alarm input terminal with a number corresponding to that of the camera.

motion detected recording: Motion Detection recording begins when motion is detected in a camera image. Use Motion Settings to set the motion detection area, sensitivity, and activation. Use event settings to set cameras to be recorded. If "Sequence" is selected as the alarm event recording mode, then up to four alarm input terminals can be set optionally per camera. If "Last" is selected, the "Alarm ON/OFF" can be set only for the alarm input terminal with a number corresponding to that of the camera.

9.2.2. Normal recording

This function automatically records camera images set by schedule. For Normal recording, settable items for each individual camera include: Recording ON/OFF; Recording Rate; and Picture Quality. (Refer to p. 81; Normal Recording setting.) Recordings can be made on scheduled patterns like "day and night," and "weekdays and holidays" by combining two or more programs.

10. PLAYBACK

10.1. Playback

Press the Play [▶] key.

Recorded images are played back. The Playback key lights green, displaying the playback screen. When playback is performed again, playback begins from the time at which it last stopped.

10.2. Reverse playback

Press the Reverse Play [◀] key.

Plays back recorded images in reverse chronological order. The Reverse Play key lights green, displaying the reverse playback screen.

When reverse playback is performed again, it begins from the time at which it last stopped.

10.3. Playback stop

Press the Stop [⏏] (■) key

Stops pictures being played back. Stopping the playback switches the display to the live mode.

10.4. Earliest image display

Press the Play [▶] key while holding down the Playback Stop [⏏] (■) key.

Playback begins from the time at which the earliest image was recorded.

10.5. Latest image reverse playback

Press the Reverse Play [◀] key while holding down the Playback Stop [⏏] (■) key.

Reverse playback begins from the time at which the latest image was recorded.

10.6. Fast forward/reverse playback

Press the Play [▶] key (Reverse Play [◀] key when in reverse playback mode) during playback.



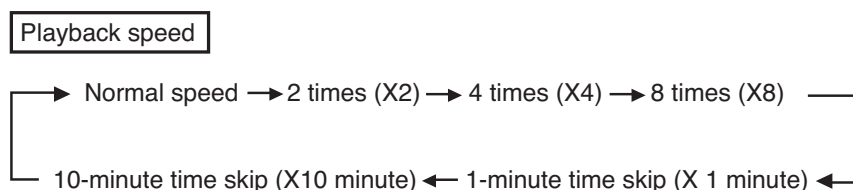

Fast forward playback (fast reverse playback when in reverse playback mode) is initiated. Playback speed cycles through 2X, 4X and 8X whenever the key is pressed. The speed can be increased using the 1-minute or 10-minute time skip function.







Notes

- The 1-minute/10-minute skip function may not operate correctly if recordings are made with the clock turned back.
- Recorded images may not be played back at the indicated speed depending on the hard disk access time, etc.
- For the pre-recorded recording data, it cannot playback skips forward in 1-minute/10-minute segments.

10.7. Pause

1. Press the Pause [] () key during forward or reverse playback.
Playback is temporarily stopped and the key lights green.
2. To perform playback again, press the Play [] key or Reverse Play [] key.
Pause mode is cancelled and forward or reverse playback begins again.

10.8. Frame advance/reverse playback

Press the Play [] key or Reverse Play [] key with the Pause [] () key pressed, while recording is temporarily stopped ,
Frame advance or reverse playback is performed per screen whenever the key is pressed.

10.9. Instance event access

Recording moves to the event start time (Priority recording, Alarm Event recording or Normal recording) and temporarily stops. Playback images can be moved from event to event and required images can be quickly searched

[Instant access to the next event]

Hold down the Play [] key for 2 seconds or more while playback is temporarily stopped.
Playback advances to the beginning of the next event and temporarily stops.

[Instant access to the previous event]

Hold down the Reverse Play [] key for 2 seconds or more while playback is temporarily stopped.
Playback advances to the beginning of the current event and temporarily stops.

11. SEARCH

11.1. Date/Time Search

Entering the date and time to perform a search displays all camera images recorded closest to the designated time in freeze-frame on the 16-segment (or 9-segment) split screen display. If no recording is made on the designated date and time, the date and time closest after the designated date and time is displayed. The oldest and newest times for recorded data are displayed, so please enter dates and times occurring between these.

1. Press the Search key.
The Search screen is displayed.
2. Select "DATE/TIME SEARCH," press the Menu key.
Date/Time search screen is displayed.
3. Move the cursor with the [◀] and [▶] keys and perform clock settings using the [+] and [-] keys. Set year, month, date, hour, minute, and second.
4. Move the cursor to "EXECUTE" and press the Menu key.
Images recorded at the time closest to the designated time are displayed.

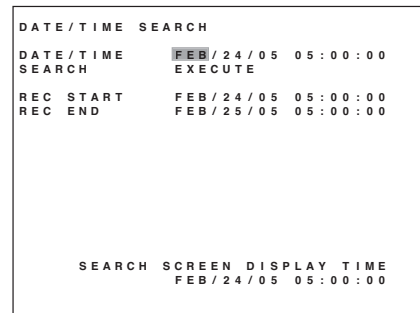

An error message is displayed at upper right of the screen if images does not exist after the designated time. Pressing the Menu key moves the cursor to the previous position.



12. ARCHIVE

The Digital Video Recorder is equipped with an archive function that transfers image data recorded on the hard disk to DVD-R disk (available only to models with DVD drives) or USB memory. Camera image data designated between start position and end position can be archived. Since dedicated viewer software is also downloaded at the same time, archived images can be easily played back on a PC.

Note

Archive operation can be performed only at the operation level 1. When the security has been set, perform archive operation after login to the Operation Level 1.

12.1. Archiving by Entering the Date and Time

Use this method for archiving when the date and time are known. Insert the DVD to be archived into the Digital Video Recorder or connect the USB flash memory to the Digital Video Recorder;

1. Hold down the Menu key for 2 seconds or more.
Menu screen is displayed.
2. Move the cursor with the [▲] and [▼] keys, select "IMAGE ARCHIVING," and press the Menu key.
Image archive screen is displayed.
3. Using the [+] and [-] keys, enter the time and date for Start 1 and End 1.
4. To continue to archive other data, repeat Step 3.
Up to 5 start and end "dates and times" can be set.

```
IMAGE ARCHIVING
START POS1  FEB/07/05 12:01:00
END POS1    FEB/07/05 13:02:00
START POS2  FEB/07/05 12:03:00
END POS2    FEB/07/05 13:04:00
START POS3  FEB/07/05 12:05:00
END POS3    FEB/07/05 13:06:00
START POS4  FEB/07/05 12:07:00
END POS4    FEB/07/05 13:08:00
START POS5  FEB/07/05 12:09:00
END POS5    FEB/07/05 13:10:00
CAMERA      CAMERA3
TRANSFER    EXECUTE
REC START   FEB/01/05 8:00:00
REC END     FEB/20/05 17:30:00
```

Note

A separate folder is created at the destination to be archived each time archiving starts and ends. Perform archiving by shifting time even when archiving for consecutive time. Dividing folders results in fewer files in each folder, thereby making search and display faster.

5. Move the cursor with the [▲] and [▼] keys and perform camera setting using the [+] and [-] keys.
Select the camera to be archived from "CAMERA 1-9" and "ALL." (For 16 channels, up to camera 16 can be selected.)
6. Move the cursor using the [▲] and [▼] keys, select "EXECUTE," and then press the Menu key.
A message box for selection of either USB or DVD is displayed at the upper right of the screen. (model with DVD drive only)
For the model without DVD drive, Selection message "Yes" or "Cancel" is displayed.
7. Move the cursor using the [◀] and [▶] keys, select "USB" or "DVD," and then press the Menu key.
For the model without DVD drive, select "YES," then press the Menu key.

```
EXECUTE?
USB DVD CANCEL
```

USB: Archive to the USB memory
DVD: Archive to the DVD-R
Cancel: Reverts to the previous cursor position without executing.

13. SPECIFICATIONS

* 0 dB = 1V

Model	C-DR091-08	C-DR091-1	C-DR091-3	C-DR091-6
Power Source	110 – 120 V AC 50/60 Hz			
Power Consumption	400 mA	410 mA	480 mA	530 mA
Image Compression	Motion-JPEG			
Video Format	NTSC			
Recording Medium	E-IDE Hard Disk 80 GB (80 GB x 1)	E-IDE Hard Disk 160 GB (160 GB x 1)	E-IDE Hard Disk 320 GB (160 GB x 2)	E-IDE Hard Disk 600 GB (300 GB x 2)
Video Input	9 channels, VBS1.0 V(p-p), 75 Ω, BNC			
Video Output	9 channels, VBS1.0V(p-p), 75 Ω, BNC, loop-through			
Monitor Output	2 channels, VBS1.0V(p-p), 75 Ω, BNC, 1 channel is dedicated to real-time image (Full-screen and 4-segment split screen display only. Nothing is displayed other than camera names and camera numbers.)			
Link Input	1 channel, VBS1.0V(p-p), 75 Ω, BNC, Connect the monitor output of other digital video recorder (C-DR091/161 series) to this terminal. Multiple digital video recorders can be operated and monitored with a single monitor by using the C-RM1000 Remote Controller (option).			
Audio Recording System	8 bits, Linear PCM, sampling frequency: 16 kHz			
Audio Input	1 channel, -10 dB*, 10 kΩ, unbalanced, RCA pin jack			
Audio Output	1 channel, -10 dB*, 600 Ω, unbalanced, RCA pin jack			
Screen Display	1-, 4-, 9-, segment screen sequence, electronic 2 x zoom			
Picture Quality	Changeable in 5 steps, (File size: 16 - 64KB) 64 KB (Quality 1), 40 KB (Quality 2), 32 KB (Quality 3), 24 KB (Quality 4), 16 KB (Quality 5)			
Pixels	720 x 240 pixels			
Recording Rate	Total recording rate 120 IPS (each camera can be individually set for the following rate) 120, 60, 30, 15, 8, 4, 2, 1, 1/2, 1/3, 1/5, 1/10, 1/20, 1/30, 1/60 IPS			
Pre-Recording	Max. 5 min (0 - 300 s)			
Post Alarm Recording	Max. 999 s (0 - 999 s), non-limit			
Date/Time	Year/ month/ date/ hour/ minute/ second, 24-hours format display, monthly deviation of within ±30 s (25°C (77°F)), can be operated until the year 2099			
Motion Detect	5 Sensitivity levels, can be turned on/off for individual areas			
Search Function	Date/Time search, Event search (Priority recording, Alarm-input recording, Normal recording, Motion detect recording, all)			
Alarm Input	9 channels (EDGE, LEVEL), no-voltage make contact input, open voltage: 2 V DC, short-circuit current: 1.5 mA, minimum short-circuit time: over 100 ms, loop resistance: under 100 Ω, screwless connector			
Control Output	4 channels (can be set for Priority recording, Alarm-input recording, Motion detect recording, Video loss, HD Full, Fan Failure, and HD Error) open collector output, withstand voltage: 30 V DC, control current : 20 mA, screwless connector			
Priority Recording Input	1 channel, no-voltage make contact input, open voltage: 2 V DC, short-circuit current: 1.5 mA, minimum short-circuit time: over 100 ms, loop resistance: under 100 Ω, screwless connector			
Time Synchronization Input	1 channel, no-voltage make contact input, open voltage: 2 V DC, short-circuit current: 1.5 mA, minimum short-circuit time: over 100 ms, loop resistance: under 100 Ω, screwless connector			
Time Synchronization Output	1 channel, open collector output, withstand voltage: 30 V DC, control current: 20 mA, screwless connector			
Camera Control	1 channel, RS-485, screwless connector			
Remote Control	1 channels, RS-485, screwless connector or RJ11			
Disk Array	2 channels, eSATA (and dedicated control signal), eSATA connector and modular connector			
Communication Function	RS-232C : D-sub connector (9 pin, male), 10 BASE-T/100 BASE-TX ethernet : RJ45			
Other Function	mail transmission capability, USB terminals (ARCHIVE, KEY LOCK), Web function (Real-time image, play-back, remote, menu), Language choice (English/ French/ Japanese)			
Altitude	Under 3,000 m (9,843 ft) (relative to sea level)			
Operating Temperature	+5°C to +40°C (41°F to 104°F) (+5°C to +35°C (41°F to 95°F) when mounted on a rack)			
Operating Humidity	Under 80% RH (no condensation)			
Finish	Panel: Surface-treated steel plate, black, paint, 30% gloss Case: Pre-coated steel plate, black			
Dimensions	420 (W) x 93.9 (H) x 332.8 (D) mm (16.5 (W) x 3.7 (H) x 13.1 (D) inch)			
Weight	5.7 kg (12.6 lb)	5.7 kg (12.6 lb)	6.5 kg (14.3 lb)	6.5 kg (14.3 lb)
Accessory	Power supply cord (2 m (6.6 ft)) ... 1			
Option	Rack mounting bracket: MB-23B			

Note: The design and specifications are subject to change without notice for improvement.

Model	C-DR161-08	C-DR161-1	C-DR161-3	C-DR161-6
Power Source	110 – 120 V AC 50/60 Hz			
Power Consumption	430 mA	440 mA	540 mA	560 mA
Image Compression	Motion-JPEG			
Video Format	NTSC			
Recording Medium	E-IDE Hard Disk 80 GB (80 GB x 1)	E-IDE Hard Disk 160 GB (160 GB x 1)	E-IDE Hard Disk 320 GB (160 GB x 2)	E-IDE Hard Disk 600 GB (300 GB x 2)
Video Input	16 channels, VBS1.0 V(p-p), 75 Ω, BNC			
Video Output	16 channels, VBS1.0V(p-p), 75 Ω, BNC, loop-through			
Monitor Output	2 channels, VBS1.0V(p-p), 75 Ω, BNC, 1 channel is dedicated to real-time image (Full-screen and 4-segment split screen display only. Nothing is displayed other than camera names and camera numbers.)			
Link Input	1 channel, VBS1.0V(p-p), 75Ω, BNC, Connect the monitor output of other digital video recorder (C-DR091/161 series) to this terminal. Multiple digital video recorders can be operated and monitored with a single monitor by using the C-RM1000 Remote Controller (option).			
Audio Recording System	8 bits, Linear PCM, sampling frequency: 16 kHz			
Audio Input	1 channel, -10 dB*, 10 kΩ, unbalanced, RCA pin jack			
Audio Output	1 channel, -10 dB*, 600 Ω, unbalanced, RCA pin jack			
Screen Display	1-, 4-, 9-, 16-, segment screen sequence, electronic 2 x zoom			
Picture Quality	Changeable in 5 steps, (File size: 16 - 64KB) 64 KB (Quality 1), 40 KB (Quality 2), 32 KB (Quality 3), 24 KB (Quality 4), 16 KB (Quality 5)			
Pixels	720 x 240 pixels			
Recording Rate	Total recording rate 120 IPS (each camera can be individually set for the following rate) 120, 60, 30, 15, 8, 4, 2, 1, 1/2, 1/3, 1/5, 1/10, 1/20, 1/30, 1/60 IPS			
Pre-Recording	Max. 5 min (0 - 300 s)			
Post Alarm Recording	Max. 999 s (0 - 999 s), non-limit			
Date/Time	Year/ month/ date/ hour/ minute/ second, 24-hours format display, monthly deviation of within ±30 s (25°C (77°F)), can be operated until the year 2099			
Motion Detect	5 Sensitivity levels, can be turned on/off for individual areas			
Search Function	Date/Time search, Event search (Priority recording, Alarm-input recording, Normal recording, Motion detect recording, all)			
Alarm Input	16 channels (EDGE, LEVEL), no-voltage make contact input, open voltage: 2 V DC, short-circuit current: 1.5 mA, minimum short-circuit time: over 100 ms, loop resistance: under 100 Ω, screwless connector			
Control Output	4 channels (can be set for Priority recording, Alarm-input recording, Motion detect recording Video loss, HD Full, Fan Failure, and HD Error) open collector output, withstand voltage: 30 V DC, control current : 20 mA, screwless connector			
Priority Recording Input	1 channel, no-voltage make contact input, open voltage: 2 V DC, short-circuit current: 1.5 mA, minimum short-circuit time: over 100 ms, loop resistance: under 100 Ω, screwless connector			
Time Synchronization Input	1 channel, no-voltage make contact input, open voltage: 2 V DC, short-circuit current: 1.5 mA, minimum short-circuit time: over 100 ms, loop resistance: under 100 Ω, screwless connector			
Time Synchronization Output	1 channel, open collector output, withstand voltage: 30 V DC, control current: 20 mA, screwless connector			
Camera Control	1 channel, RS-485, screwless connector			
Remote Control	1 channels, RS-485, screwless connector or RJ11			
Disk Array	2 channels, eSATA (and dedicated control signal), eSATA connector and modular connector			
Communication Function	RS-232C : D-sub connector (9 pin, male), 10 BASE-T/100 BASE-TX ethernet : RJ45			
Other Function	mail transmission capability, USB terminals (ARCHIVE, KEY LOCK), Web function (Real-time image, play-back, remote, menu), Language choice (English/ French/ Japanese)			
Altitude	Under 3,000 m (9,843 ft) (relative to sea level)			
Operating Temperature	+5°C to +40°C (41°F to 104°F) (+5°C to +35°C (41°F to 95°F) when mounted on a rack)			
Operating Humidity	Under 80% RH (no condensation)			
Finish	Panel: Surface-treated steel plate, black, paint, 30% gloss Case: Pre-coated steel plate, black			
Dimensions	420 (W) x 93.9 (H) x 332.8 (D) mm (16.5 (W) x 3.7 (H) x 13.1 (D) inch)			
Weight	5.8 kg (12.8 lb)	5.8 kg (12.8 lb)	6.6 kg (14.6 lb)	6.6 kg (14.6 lb)
Accessory	Power supply cord (2 m (6.6 ft)) ... 1			
Option	Rack mounting bracket: MB-23B			

Note: The design and specifications are subject to change without notice for improvement.

Model	C-DR091D08	C-DR091D1	C-DR091D3	C-DR091D6
Power Source	110 – 120 V AC 50/60 Hz			
Power Consumption	490 mA	500 mA	570 mA	590 mA
Image Compression	Motion-JPEG			
Video Format	NTSC			
Recording Medium	E-IDE Hard Disk 80 GB (80 GB x 1)	E-IDE Hard Disk 160 GB (160 GB x 1)	E-IDE Hard Disk 320 GB (160 GB x 2)	E-IDE Hard Disk 600 GB (300 GB x 2)
Video Input	9 channels, VBS1.0 V(p-p), 75 Ω, BNC			
Video Output	9 channels, VBS1.0V(p-p), 75 Ω, BNC, loop-through			
Monitor Output	2 channels, VBS1.0V(p-p), 75 Ω, BNC, 1 channel is dedicated to real-time image (Full-screen and 4-segment split screen display only. Nothing is displayed other than camera names and camera numbers.)			
Link Input	1 channel, VBS1.0V(p-p), 75 Ω, BNC, Connect the monitor output of other digital video recorder (C-DR091/161 series) to this terminal. Multiple digital video recorders can be operated and monitored with a single monitor by using the C-RM1000 Remote Controller (option).			
Audio Recording System	8 bits, Linear PCM, sampling frequency: 16 kHz			
Audio Input	1 channel, -10 dB*, 10 kΩ, unbalanced, RCA pin jack			
Audio Output	1 channel, -10 dB*, 600 Ω, unbalanced, RCA pin jack			
Screen Display	1-, 4-, 9-, segment screen sequence, electronic 2 x zoom			
Picture Quality	Changeable in 5 steps, (File size: 16 - 64KB) 64 KB (Quality 1), 40 KB (Quality 2), 32 KB (Quality 3), 24 KB (Quality 4), 16 KB (Quality 5)			
Pixels	720 x 240 pixels			
Recording Rate	Total recording rate 120 IPS (each camera can be individually set for the following rate) 120, 60, 30, 15, 8, 4, 2, 1, 1/2, 1/3, 1/5, 1/10, 1/20, 1/30, 1/60 IPS			
Pre-Recording	Max. 5 min (0 - 300 s)			
Post Alarm Recording	Max. 999 s (0 - 999 s), non-limit			
Date/Time	Year/ month/ date/ hour/ minute/ second, 24-hours format display, monthly deviation of within ±30 s (25°C (77°F)), can be operated until the year 2099			
Motion Detect	5 Sensitivity levels, can be turned on/off for individual areas			
Search Function	Date/Time search, Event search (Priority recording, Alarm-input recording, Normal recording, Motion detect recording, all)			
Alarm Input	9 channels (EDGE, LEVEL), no-voltage make contact input, open voltage: 2 V DC, short-circuit current: 1.5 mA, minimum short-circuit time: over 100 ms, loop resistance: under 100 Ω, screwless connector			
Control Output	4 channels (can be set for Priority recording, Alarm-input recording, Motion detect recording, Video loss, HD Full, Fan Failure, and HD Error) open collector output, withstand voltage: 30 V DC, control current : 20 mA, screwless connector			
Priority Recording Input	1 channel, no-voltage make contact input, open voltage: 2 V DC, short-circuit current: 1.5 mA, minimum short-circuit time: over 100 ms, loop resistance: under 100 Ω, screwless connector			
Time Synchronization Input	1 channel, no-voltage make contact input, open voltage: 2 V DC, short-circuit current: 1.5 mA, minimum short-circuit time: over 100 ms, loop resistance: under 100 Ω, screwless connector			
Time Synchronization Output	1 channel, open collector output, withstand voltage: 30 V DC, control current: 20 mA, screwless connector			
Camera Control	1 channel, RS-485, screwless connector			
Remote Control	1 channels, RS-485, screwless connector or RJ11			
Disk Array	2 channels, eSATA (and dedicated control signal), eSATA connector and modular connector			
Communication Function	RS-232C : D-sub connector (9 pin, male), 10 BASE-T/100 BASE-TX ethernet : RJ45			
Other Function	mail transmission capability, USB terminals (ARCHIVE, KEY LOCK), Web function (Real- time image, play-back, remote, menu) ,Language choice (English/ French/ Japanese)			
Applicable DVD Medium	DVD-R			
Altitude	Under 3,000 m (9,843 ft) (relative to sea level)			
Operating Temperature	+5°C to +40°C (41°F to 104°F) (+5°C to +35°C (41°F to 95°F) when mounted on a rack)			
Operating Humidity	Under 80% RH (no condensation)			
Finish	Panel: Surface-treated steel plate, black, paint, 30% gloss Case: Pre-coated steel plate, black			
Dimensions	420 (W) x 93.9 (H) x 332.8 (D) mm (16.5 (W) x 3.7 (H) x 13.1 (D) inch)			
Weight	6.8 kg (15.0 lb)	6.8 kg (15.0 lb)	7.6 kg (16.8 lb)	7.6 kg (16.8 lb)
Accessory	Power supply cord (2 m (6.6 ft)) ... 1			
Option	Rack mounting bracket: MB-23B			

Note: The design and specifications are subject to change without notice for improvement.

Model	C-DR161D08	C-DR161D1	C-DR161D3	C-DR161D6
Power Source	110 – 120 V AC 50/60 Hz			
Power Consumption	530 mA	530 mA	610 mA	630 mA
Image Compression	Motion-JPEG			
Video Format	NTSC			
Recording Medium	E-IDE Hard Disk 80 GB (80 GB x 1)	E-IDE Hard Disk 160 GB (160 GB x 1)	E-IDE Hard Disk 320 GB (160 GB x 2)	E-IDE Hard Disk 600 GB (300 GB x 2)
Video Input	16 channels, VBS1.0 V(p-p), 75 Ω, BNC			
Video Output	16 channels, VBS1.0V(p-p), 75 Ω, BNC, loop-through			
Monitor Output	2 channels, VBS1.0V(p-p), 75 Ω, BNC, 1 channel is dedicated to real-time image (Full-screen and 4-segment split screen display only. Nothing is displayed other than camera names and camera numbers.)			
Link Input	1 channel, VBS1.0V(p-p), 75 Ω, BNC, Connect the monitor output of other digital video recorder (C-DR091/161 series) to this terminal. Multiple digital video recorders can be operated and monitored with a single monitor by using the C-RM1000 Remote Controller (option).			
Audio Recording System	8 bits, Linear PCM, sampling frequency: 16 kHz			
Audio Input	1 channel, -10 dB*, 10 kΩ, unbalanced, RCA pin jack			
Audio Output	1 channel, -10 dB*, 600 Ω, unbalanced, RCA pin jack			
Screen Display	1-, 4-, 9-, 16-, segment screen sequence, electronic 2 x zoom			
Picture Quality	Changeable in 5 steps, (File size: 16 - 64KB) 64 KB (Quality 1), 40 KB (Quality 2), 32 KB (Quality 3), 24 KB (Quality 4), 16 KB (Quality 5)			
Pixels	720 x 240 pixels			
Recording Rate	Total recording rate 120 IPS (each camera can be individually set for the following rate) 120, 60, 30, 15, 8, 4, 2, 1, 1/2, 1/3, 1/5, 1/10, 1/20, 1/30, 1/60 IPS			
Pre-Recording	Max. 5 min (0 - 300 s)			
Post Alarm Recording	Max. 999 s (0 - 999 s), non-limit			
Date/Time	Year/ month/ date/ hour/ minute/ second, 24-hours format display, monthly deviation of within ±30 s (25°C (77°F)), can be operated until the year 2099			
Motion Detect	5 Sensitivity levels, can be turned on/off for individual areas			
Search Function	Date/Time search, Event search (Priority recording, Alarm-input recording, Normal recording, Motion detect recording, all)			
Alarm Input	16 channels (EDGE, LEVEL), no-voltage make contact input, open voltage: 2 V DC, short-circuit current: 1.5 mA, minimum short-circuit time: over 100 ms, loop resistance: under 100 Ω, screwless connector			
Control Output	4 channels (can be set for Priority recording, Alarm-input recording, Motion detect recording, Video loss, HD Full, Fan Failure, and HD Error) open collector output, withstand voltage: 30 V DC, control current : 20 mA, screwless connector			
Priority Recording Input	1 channel, no-voltage make contact input, open voltage: 2 V DC, short-circuit current: 1.5 mA, minimum short-circuit time: over 100 ms, loop resistance: under 100 Ω, screwless connector			
Time Synchronization Input	1 channel, no-voltage make contact input, open voltage: 2 V DC, short-circuit current: 1.5 mA, minimum short-circuit time: over 100 ms, loop resistance: under 100 Ω, screwless connector			
Time Synchronization Output	1 channel, open collector output, withstand voltage: 30 V DC, control current: 20 mA, screwless connector			
Camera Control	1 channel, RS-485, screwless connector			
Remote Control	1 channels, RS-485, screwless connector or RJ11			
Disk Array	2 channels, eSATA (and dedicated control signal), eSATA connector and modular connector			
Communication Function	RS-232C : D-sub connector (9 pin, male), 10 BASE-T/100 BASE-TX ethernet : RJ45			
Other Function	mail transmission capability, USB terminals (ARCHIVE, KEY LOCK), Web function (Real-time image, play-back, remote, menu), Language choice (English/ French/ Japanese)			
Applicable DVD Medium	DVD-R			
Altitude	Under 3,000 m (9,843 ft) (relative to sea level)			
Operating Temperature	+5°C to +40°C (41°F to 104°F) (+5°C to +35°C (41°F to 95°F) when mounted on a rack)			
Operating Humidity	Under 80% RH (no condensation)			
Finish	Panel: Surface-treated steel plate, black, paint, 30% gloss Case: Pre-coated steel plate, black			
Dimensions	420 (W) x 93.9 (H) x 332.8 (D) mm (16.5 (W) x 3.7 (H) x 13.1 (D) inch)			
Weight	6.9 kg (15.2 lb)	6.9 kg (15.2 lb)	7.7 kg (17.0 lb)	7.7 kg (17.0 lb)
Accessory	Power supply cord (2 m (6.6 ft)) ... 1			
Option	Rack mounting bracket: MB-23B			

Note: The design and specifications are subject to change without notice for improvement.

Free Manuals Download Website

<http://myh66.com>

<http://usermanuals.us>

<http://www.somanuals.com>

<http://www.4manuals.cc>

<http://www.manual-lib.com>

<http://www.404manual.com>

<http://www.luxmanual.com>

<http://aubethermostatmanual.com>

Golf course search by state

<http://golfingnear.com>

Email search by domain

<http://emailbydomain.com>

Auto manuals search

<http://auto.somanuals.com>

TV manuals search

<http://tv.somanuals.com>