

VIZIO



USER MANUAL

Model: E420-B1



This product qualifies for ENERGY STAR in the "factory default" setting and this is the setting in which power savings will be achieved. Changing the factory default picture settings or enabling other features will increase power consumption that could exceed the limits necessary to qualify for ENERGY STAR rating.



For DTS patents, see

<http://patents.dts.com>.

Manufactured under license from DTS Licensing Limited. DTS, the Symbol, & DTS and the Symbol together are registered trademarks, and DTS Studio Sound is a trademark of DTS, Inc. © DTS, Inc. All Rights Reserved.



Manufactured under license from Dolby Laboratories. Dolby and the double-D symbol are trademarks of Dolby Laboratories.



HDMI, the HDMI logo and High-Definition Multimedia Interface are trademarks or registered trademarks of HDMI Licensing LLC.

THANK YOU FOR CHOOSING VIZIO

And congratulations on your new VIZIO HDTV.

To get the most out of your new VIZIO product, read these instructions before using your product and retain them for future reference. Be sure to inspect the package contents to ensure there are no missing or damaged parts.

PRODUCT REGISTRATION

To purchase or inquire about accessories and installation services for your VIZIO product, visit our website at www.VIZIO.com or call toll free at (877) 878-4946.

We recommend that you either:

- Register your VIZIO product at www.VIZIO.com
- Complete and mail the enclosed registration card

Extended Warranties

For peace of mind, and to protect your investment beyond the standard warranty, VIZIO offers on-site extended warranty service plans. These plans provide additional coverage during the standard warranty period. To purchase an extended warranty service plan, visit www.VIZIO.com.

WHEN READING THIS MANUAL



When you see this symbol, please read the accompanying important warning or notice. It is intended to alert you to the presence of important operating instructions.



When you see this symbol, please read the accompanying helpful tip.

IMPORTANT SAFETY INSTRUCTIONS

Your TV is designed and manufactured to operate within defined design limits. Misuse may result in electric shock or fire. To prevent your TV from being damaged, the following instructions should be observed for the installation, use, and maintenance of your TV. Read the following safety instructions before operating your TV. Keep these instructions in a safe place for future reference.

- To reduce the risk of electric shock or component damage, switch off the power before connecting other components to your TV.
- Read these instructions.
- Keep these instructions.
- Heed all warnings.
- Follow all instructions.
- Do not use this apparatus near water.
- Clean only with a dry cloth.
- Do not block any ventilation openings. Install in accordance with the manufacturer's instructions.
- Do not install near any heat sources such as radiators, heat registers, stoves, or other apparatus (including amplifiers) that produce heat.
- Do not defeat the safety purpose of the polarized or grounding-type plug. A polarized plug has two blades and a third grounding prong. The wide blade or the third prong are provided for your safety. If the provided plug does not fit into your outlet, consult an electrician for replacement of the obsolete outlet.
- Protect the power cord from being walked on or pinched, particularly at plugs, convenience receptacles, and the point where they exit from the apparatus.
- Only use attachments/accessories specified by the manufacturer.

- Use only with the cart, stand, tripod, bracket, or table specified by the manufacturer, or sold with the apparatus. When a cart is used, use caution when moving the cart/apparatus combination to avoid injury from tip-over.
- Unplug this apparatus during lightning storms or when unused for long periods of time.
- Refer all servicing to qualified service personnel. Servicing is required when the apparatus has been damaged in any way, such as when the power-supply cord or plug is damaged, liquid has been spilled or objects have fallen into the apparatus, the apparatus has been exposed to rain or moisture, does not operate normally or has been dropped.
- Unplug the power cord before cleaning your TV.
- When moving your TV from an area of low temperature to an area of high temperature, condensation may form in the housing. Wait before turning on your TV to avoid causing fire, electric shock, or component damage.
- A distance of at least three feet should be maintained between your TV and any heat source, such as a radiator, heater, oven, amplifier etc. Do not install your TV close to smoke. Operating your TV close to smoke or moisture may cause fire or electric shock.
- Slots and openings in the back and bottom of the cabinet are provided for ventilation. To ensure reliable operation of your TV and to protect it from overheating, be sure these openings are not blocked or covered. Do not place your TV in a bookcase or cabinet unless proper ventilation is provided.
- Never push any object into the slots and openings on your TV cabinet. Do not place any objects on the top of your TV. Doing so could short circuit parts causing a fire or electric shock. Never spill liquids on your TV.
- Your TV should be operated only from the type of power source indicated on the label. If you are not sure of the type of power supplied to your home, consult your dealer



- or local power company.
- Do not apply pressure or throw objects at your TV. This may compromise the integrity of the display. The manufacturer's warranty does not cover user abuse or improper installations.
- The power cord must be replaced when using different voltage than the voltage specified. For more information, contact your dealer.
- When connected to a power outlet, power is always flowing into your TV. To totally disconnect power, unplug the power cord.
- The lightning flash with arrowhead symbol within an equilateral triangle is intended to alert the user to the presence of un-isolated, dangerous voltage within the inside of your TV that may be of sufficient magnitude to constitute a risk of electric shock to persons.
- Do not overload power strips and extension cords. Overloading can result in fire or electric shock.
- The wall socket should be installed near your TV and easily accessible.
- Only power of the marked voltage can be used for your TV. Any other voltage than the specified voltage may cause fire or electric shock.
- Do not touch the power cord during lightning. To avoid electric shock, avoid handling the power cord during electrical storms.
- Unplug your TV during a lightning storm or when it will not be used for long period of time. This will protect your TV from damage due to power surges.
- Do not attempt to repair or service your TV yourself. Opening or removing the back cover may expose you to high voltages, electric shock, and other hazards. If repair is required, contact your dealer and refer all servicing to qualified service personnel.
- **WARNING:** Keep your TV away from moisture. Do not expose your TV to rain or moisture. If water penetrates into

your TV, unplug the power cord and contact your dealer. Continuous use in this case may result in fire or electric shock.

- Do not use your TV if any abnormality occurs. If any smoke or odor becomes apparent, unplug the power cord and contact your dealer immediately. Do not try to repair your TV yourself.
- Avoid using dropped or damaged appliances. If your TV is dropped and the housing is damaged, the internal components may function abnormally. Unplug the power cord immediately and contact your dealer for repair. Continued use of your TV may cause fire or electric shock.
- Do not install your TV in an area with heavy dust or high humidity. Operating your TV in environments with heavy dust or high humidity may cause fire or electric shock.
- Follow instructions for moving your TV. Ensure that the power cord and any other cables are unplugged before moving your TV.
- When unplugging your TV, hold the AC/DC power adapter, not the cord. Pulling on the power cord may damage the wires inside the cord and cause fire or electric shock. When your TV will not be used for an extended period of time, unplug the power cord.
- To reduce risk of electric shock, do not touch the connector with wet hands.
- Insert batteries in accordance with instructions. Incorrect polarities may cause the batteries to leak which can damage the remote control or injure the operator. Do not expose batteries to excessive heat such as sunshine, fire or the like.
- If any of the following occurs, contact the dealer:
 - The power cord fails or frays.
 - Liquid sprays or any object drops into your TV.
 - Your TV is exposed to rain or other moisture.
 - Your TV is dropped or damaged in any way.
 - The performance of your TV changes substantially.

- This apparatus shall not be exposed to dripping or splashing and no objects filled with liquids, such as vases, shall be placed on the apparatus.
- The mains plug or appliance coupler is used as the disconnect device, the disconnect device shall remain readily operable.
- CAUTION - These servicing instructions are for use by qualified service personnel only. To reduce the risk of electric shock, do not perform any servicing other than that contained in the operating instructions unless you are qualified to do so.



The lightning flash with arrowhead symbol within an equilateral triangle is intended to alert the user to the presence of uninsulated DANGEROUS VOLTAGE within the product's enclosure that may be of sufficient magnitude to constitute a risk of electrical shock to persons.

TELEVISION ANTENNA CONNECTION PROTECTION

If an outside antenna/satellite dish or cable system is to be connected to the TV, make sure that the antenna or cable system is electrically grounded to provide some protection against voltage surges and static charges.

Article 810 of the National Electrical Code, ANSI/NFPA 70, provides information with regard to proper grounding of the mast and supporting structure, grounding of the lead-in wire to an antenna discharge unit, size of the grounding conductors, location of antenna discharge unit, connection to grounding electrodes, and requirements of the grounding electrode.

Lightning Protection

For added protection of the TV during a lightning storm or when it is left unattended or unused for long periods of time, unplug the TV from the wall outlet and disconnect the antenna or cable system.

Power Lines

Do not locate the antenna near overhead light or power circuits, or where it could fall into such power lines or circuits. Remember, the screen of the coaxial cable is intended to be connected to earth in the building installation.

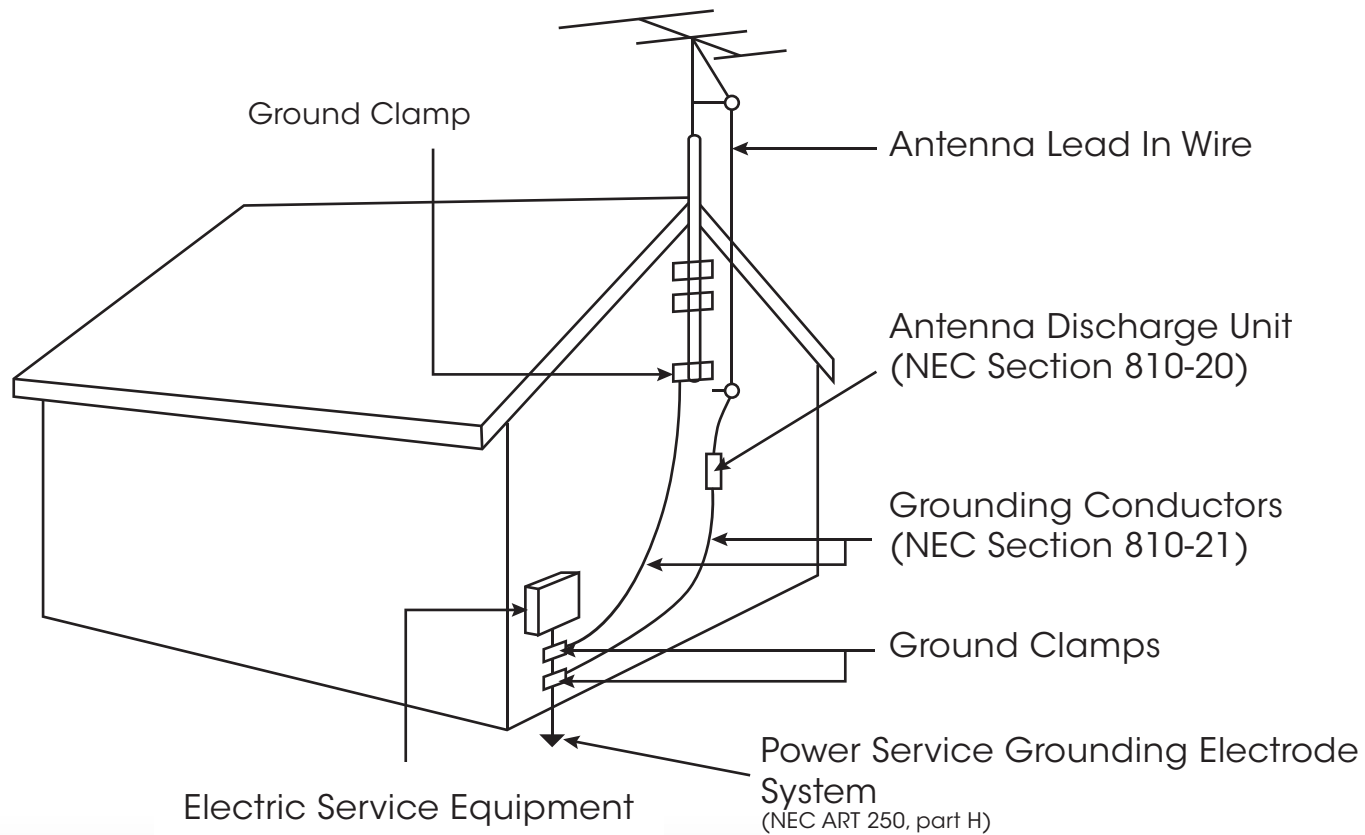

Table of Contents

Installing the TV	3	Resetting the Color Temperature Settings	23
Inspecting the Package Contents	3	Resetting the Picture Settings	24
Installing the TV.....	4	Adjusting the Audio Settings.....	25
Installing the TV Stand	4	Changing the Equalizer Settings.....	26
Installing the TV on a Wall.....	6	Resetting the Audio Settings.....	26
Controls and Connections	7	Setting Timers.....	27
Rear Panel	7	Setting the Sleep Timer	27
Side Panel	8	Setting the Auto Power Off Feature.....	27
Front Panel.....	9	Setting Up the Tuner.....	28
Remote Control	10	Selecting a Tuner Input	28
Replacing the Batteries	11	Scanning for Channels.....	28
Connecting Your Devices.....	12	Adding New Channels	29
Connecting A Device	12	Skipping Channels.....	30
Connecting a Device - Audio and Video Cable Types ...	13	Listening to Alternate Audio	31
Connecting an Audio Device	15	Changing the Analog Audio Language	31
Connecting an Audio Device - Audio Cable Types.....	16	Changing the Digital Audio Language.....	31
Connecting an Audio Device - ARC.....	17	Setting Up Closed Captioning	32
Without HDMI ARC.....	17	Changing the Appearance of Digital Closed Captions .	32
With HDMI ARC	17	Renaming Devices on the Input Menu	34
Completing the First-Time Setup.....	18	Changing the TV Settings.....	35
Using the On-Screen Menu	19	Viewing System Information	35
Navigating the On-Screen Menu	19	Changing the On-Screen Menu Language	36
Changing the Input Source	20	Setting the Time Zone	36
Changing the Screen Aspect Ratio	20	Using the Parental Controls	37
Adjusting the Picture Settings	21	Accessing the Parental Controls Menu	37
Adjusting the Advanced Picture Settings.....	22	Enabling or Disabling Program Ratings.....	37
Adjusting the Color Temperature	23	Locking and Unlocking Channels	37
		Blocking and Unblocking Content by Rating.....	38
		Changing the Parental Control Passcode	38

Resetting the Content Locks.....	38
Adjusting the CEC Settings.....	39
Turning the Power Indicator On or Off.....	39
Using the Reset & Admin Menu.....	40
Restoring the TV to Factory Default Settings.....	40
Using the Guided Setup Menu.....	40
Using Guided Setup.....	40
Using the Info Window.....	41
Using the USB Media Player.....	42
Using the USB Media Player.....	42
Preparing Your USB Drive to Play USB Media.....	42
Playing USB Media.....	42
Removing the USB Drive from the TV.....	42
Troubleshooting & Technical Support.....	44
Specifications.....	47
Limited Warranty.....	49
Parts and Labor.....	49
Type of Service.....	49
Limitations and Exclusions.....	49
Personal Data.....	49
Zero Bright Pixel Defect Guarantee.....	49
Legal & Compliance.....	50
FCC Class B Radio Interference Statement.....	50
Notice.....	50
FCC warning.....	50

INSPECTING THE PACKAGE CONTENTS

Before installing your new TV, take a moment to inspect the package contents. Use the images below to ensure nothing is missing or damaged.



VIZIO LED HDTV



Remote Control
with Batteries



Quick Start Guide



Power Cord



3 x M4 12mm
Phillips Screws



2 x M6 12mm
Phillips Screws

PACKAGE CONTENTS

INSTALLING THE TV

After removing the TV from the box and inspecting the package contents you can begin installing the TV. Your TV can be installed in two ways:

- On a flat surface, using the included stand
- On a wall, using a VESA-standard wall mount (not included)

Installing the TV Stand

Your TV includes a stand designed to support the weight of the TV and keep it from falling over. However, the TV can still fall over if:

- It is placed on an uneven, unstable, or non-level surface
- It is pushed, pulled, or otherwise improperly moved
- If an earthquake occurs and the TV is not properly secured

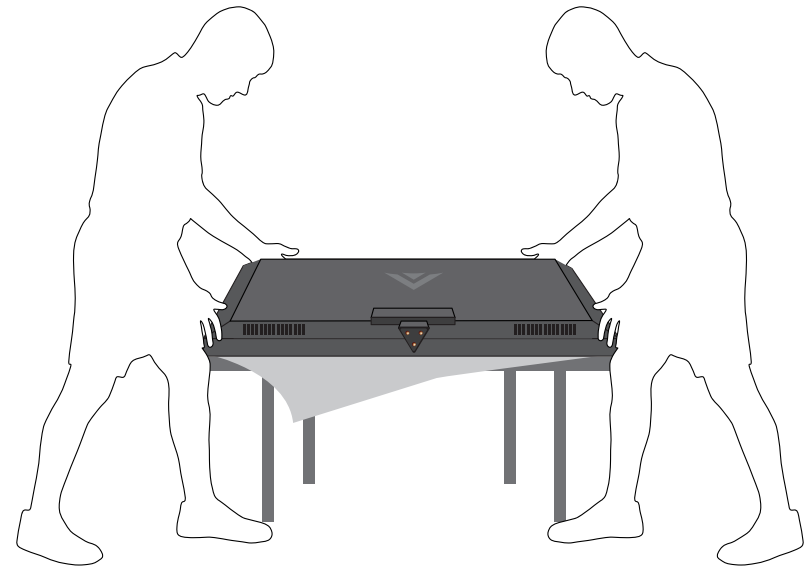

TV ON STAND

It is recommended that two people take part in the base installation.

Place the TV screen-down on a clean, flat surface. To prevent scratches or damage to the screen, place the TV on a soft surface such as a blanket.

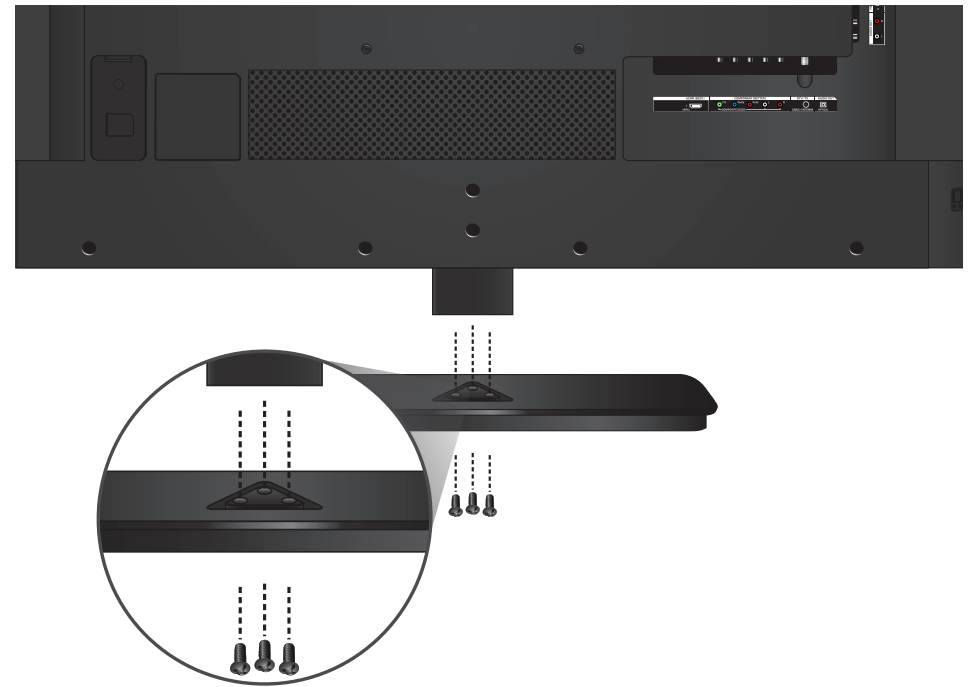
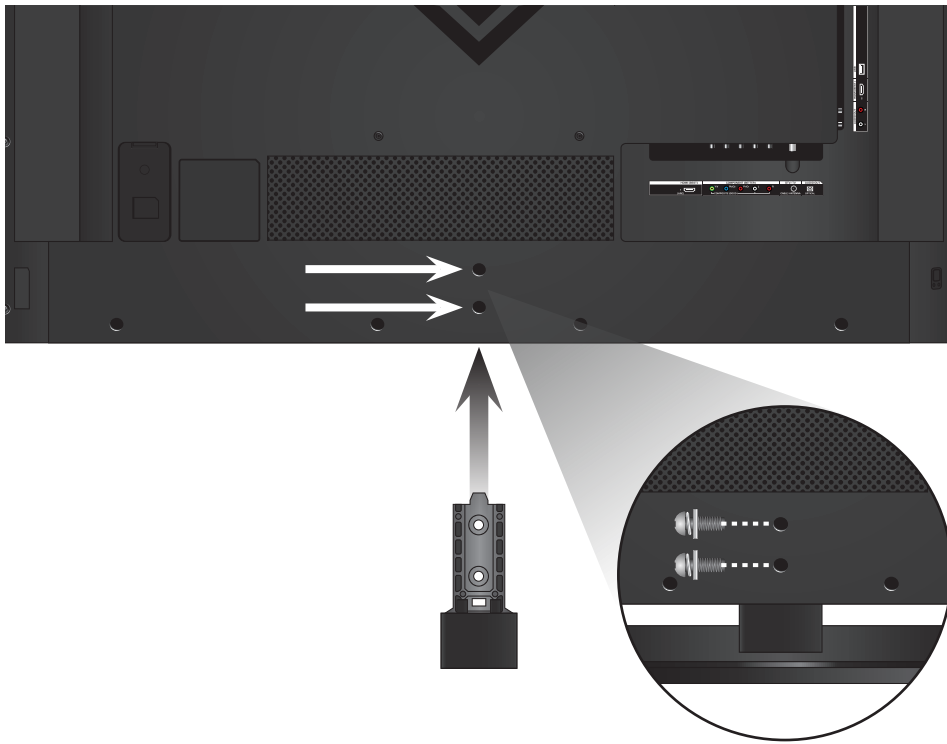

To install the base:

1. Align the neck piece with the bottom of the TV and slide the flange into the body of the TV as shown.
2. Using a Phillips screwdriver, tighten two (2) M6 12mm screws into the holes as shown to secure the neck piece to the TV.
3. Align the base with the neck and tighten three (3) M4 12mm screws.
4. When you are finished, place the TV on a stable, level surface.

Installing the TV on a Wall

To mount your TV on a wall, you will need a wall mount. Consult the information below to find the appropriate mount for your TV model:



Installing a TV on a wall requires lifting. To prevent injury or damage to the TV, ask someone to help you.

E420-B1	
Screw Size:	M6
Hole Pattern:	200mm (V) x 200mm (H)
Weight w/o Stand:	22.05 lbs

Be sure the mount you choose is capable of supporting the weight of the TV. After you have determined that you have the correct mount for your TV, you can begin the installation.

To install your TV on a wall:

1. Disconnect any cables connected to your TV.
2. Place the TV face-down on a clean, flat, stable surface. Be sure the surface is clear of debris that can scratch or damage the TV.
3. Remove the base by loosening and removing the screws.
4. Attach your TV and wall mount to the wall, carefully following the instructions that came with your mount.

Use only with a UL-listed wall mount bracket rated for the weight/load of this TV.



WALL MOUNT SCREW LOCATIONS



USB - Connect a USB thumb drive to display photos.

HDMI - Connect an HDMI device.

Stereo Audio Out - Connect an RCA audio device, such as sound bar.

HDMI - Connect an HDMI device.

Coaxial - Connect coaxial cable from cable, satellite, or antenna.

Optical Audio Out - Connect an optical/SPDIF audio device, such as a home audio receiver.

Component/Composite - Connect a component or composite device.

REAR PANEL

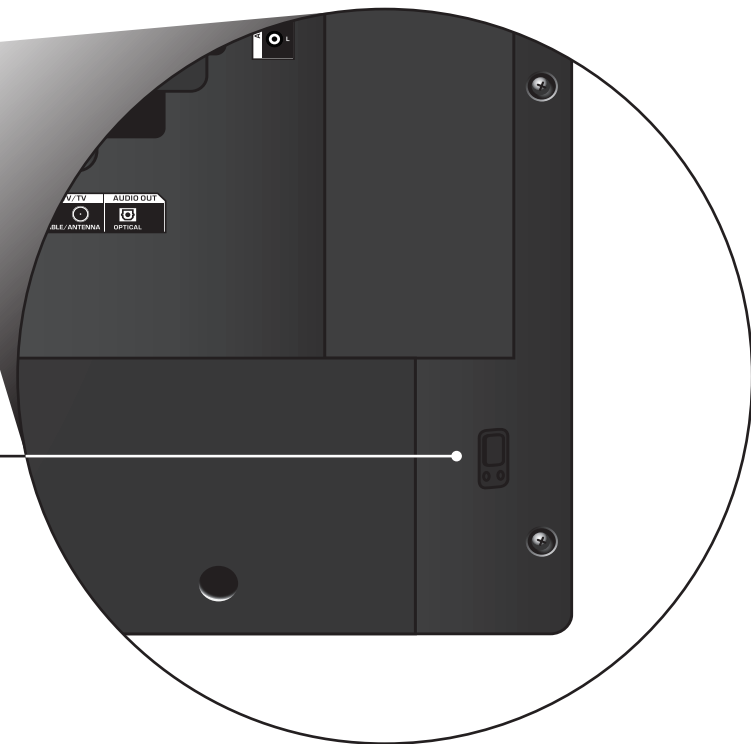

Power/Input - Press once to turn on the TV.

Press once to access the Input menu.

Press and hold to turn off the TV.

SIDE PANEL

**REMOTE SENSOR & POWER INDICATOR**

When using the remote, aim it directly at this sensor.

The power indicator flashes on when the TV turns on, then goes out after several seconds. To keep the power indicator on as long as the TV is on, see *Turning the Power Indicator On or Off* on page 39.

FRONT PANEL

INPUT
Change the currently-displayed input.

A/V CONTROLS
Control USB media player.

CLOSED CAPTIONS
Open the closed caption menu.

EXIT
Close the on-screen menu.

OK
Select the highlighted menu option.

BACK
Go to the previous on-screen menu.

VOLUME UP/DOWN
Increase or decrease loudness of the audio.

MUTE
Turn the audio off or on.

NUMBER PAD
Manually enter a channel.

WIDE
Switch the display mode.



POWER
Turn the TV on or off.

INFO
Display the info window.

MENU
Display the on-screen menu.

ARROW
Navigate the on-screen menu.

GUIDE
Display the info window.

V BUTTON
Open the USB media player.

CHANNEL UP/DOWN
Change the channel.

LAST
Return to the channel last viewed.

DASH
Use with number pad to manually enter a digital sub-channel. (For example, 18-4 or 18-5.)

Replacing the Batteries



1. Remove the battery cover.
2. Insert two batteries into the remote control. Make sure that the (+) and (-) symbols on the batteries match the (+) and (-) symbols inside the battery compartment.
3. Replace the battery cover.

CONNECTING A DEVICE

Your TV can be used to display output from most devices.

1. Verify that your device has a video port that matches an available port on the TV (HDMI, Component, etc.).
2. Turn the TV and your device off.
3. Connect the appropriate cable (not included) to the TV and the device.
4. Turn the TV and your device on. Set the TV's input to match the connection you used (HDMI, Component, etc.).



Cable/Satellite Box



DVD/Blu-ray Player



Game Console

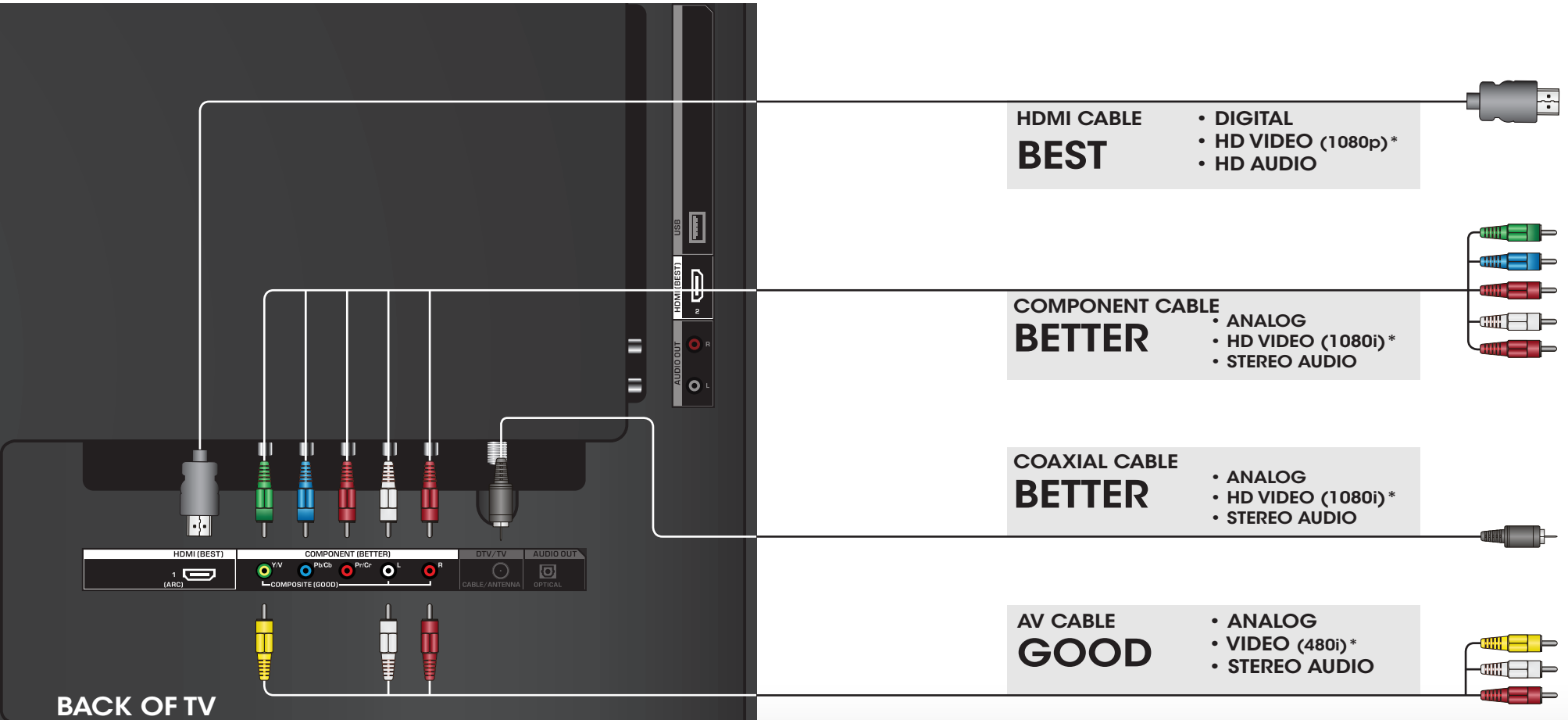

CONNECTING A DEVICE - AUDIO AND VIDEO CABLE TYPES

AV CABLE

AV cables (or Composite cables) are the traditional way of connecting your devices to your TV. Video signals are sent over the yellow connector while audio is sent over the red and white connectors.

- Video Resolutions up to 480i
- Analog Connection
- Audio and Video Signals

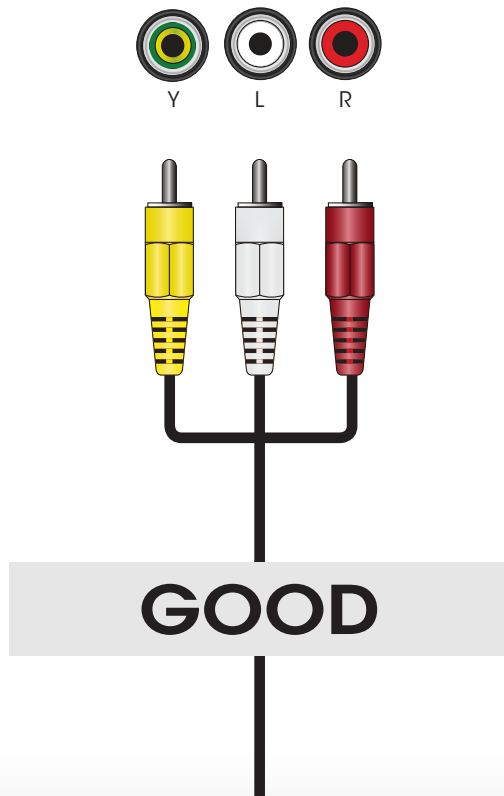

COAXIAL CABLE

Coaxial cables are the traditional way of connecting antennas and cable television signals to your TV. Coaxial cables carry both audio and video signals through a single connector.

- HD Video Resolutions up to 1080i
- Analog Connection
- Audio and Video Signals

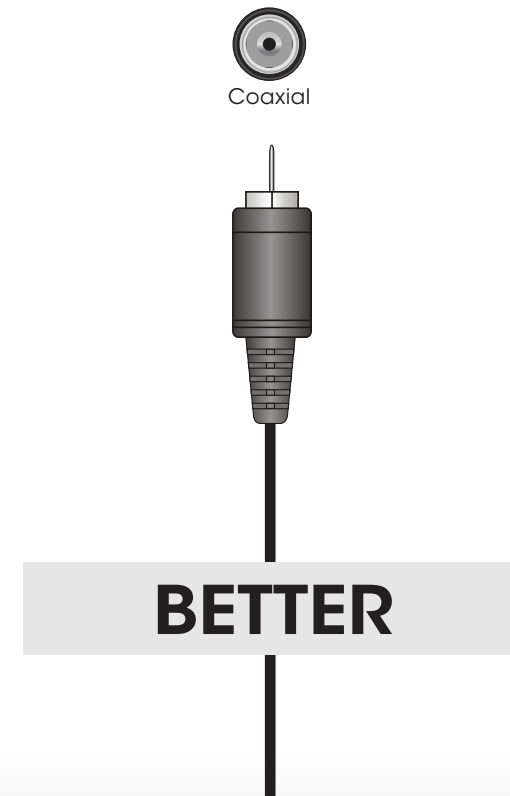

COMPONENT CABLE

Component cables are designed to carry high definition video signals along with additional audio connections. Colors are delivered with color information split up three different ways over three connectors for video (separated into Red, Blue and Green signals) and the left and right audio connectors (Red and White).

- **HD Video Resolutions up to 1080i**
- **Analog Connection**
- **Audio and Video Signals**

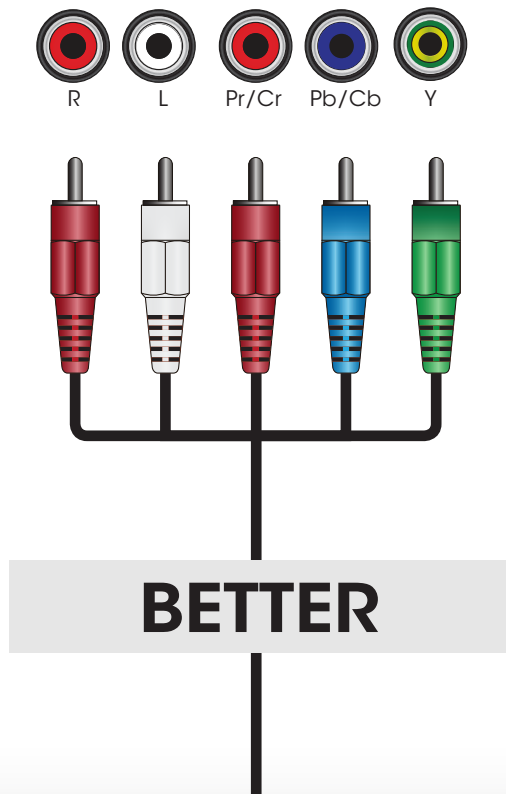

HDMI CABLE

HDMI is the intelligent, all-digital interface that delivers both dazzling quality and unmatched ease of use. HDMI technology transmits crystal-clear digital video along with multi-channel surround audio. HDMI-connected devices have the ability to automatically adjust themselves for optimal viewing.

- **HD Video Resolutions up to 1080p**
- **HD Audio**
- **Digital Connection**
- **Audio and Video Signals**



CONNECTING AN AUDIO DEVICE

Your TV can output sound to an audio device, such as a receiver or sound bar.

1. Verify that your device has an audio port that matches an available port on the TV (HDMI, RCA, etc.).
2. Turn the TV and your audio device off.
3. Connect the appropriate cable (not included) to the TV and the device.
4. Turn the TV and your device on.

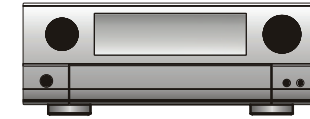

Home Audio Receiver



VIZIO Sound Bar

HDMI CABLE BEST

- CEC 2-WAY COMMUNICATION
- 2.0-5.1 DIGITAL AUDIO
- PCM, DTS, DOLBY DIGITAL



RCA CABLE GOOD

- ANALOG STEREO CONNECTION
- 2.0 CHANNEL

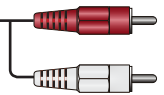

OPTICAL/SPDIF CABLE BETTER

- PCM STREAM
- DOLBY DIGITAL 5.1 CHANNEL
- DTS 5.1 CHANNEL

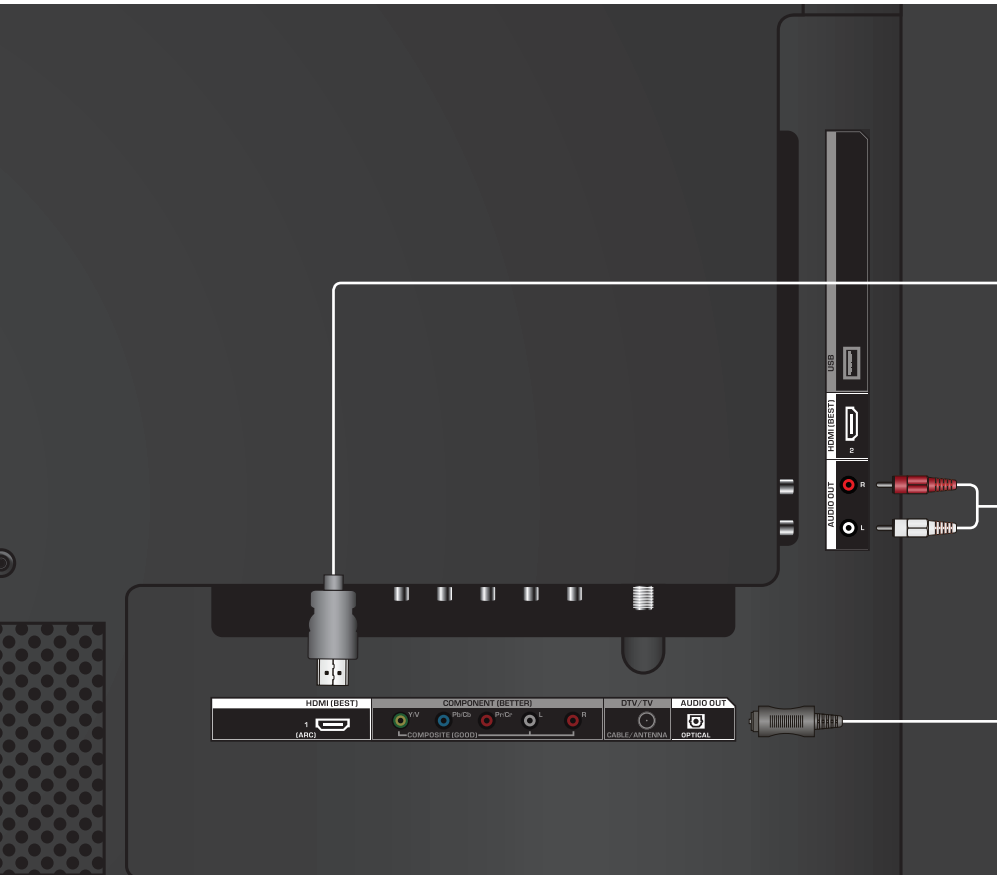

CONNECTING AN AUDIO DEVICE - AUDIO CABLE TYPES

RCA CABLE

AV cables (or Composite cables) are the traditional way of connecting your devices to your audio device. Audio signals are sent over the red and white connectors.

- **Quality Stereo Connection**
- **2.0 Channel**
- **Analog Connection**
- **Audio Signal Only**

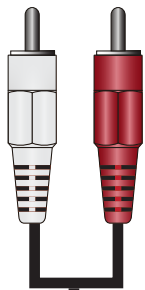

GOOD

OPTICAL/SPDIF CABLE

Optical/SPDIF cables transmit audio signals as pulses of light through a cable made of plastic fibers. Audio signals are digitally transmitted between devices.

- **PCM Stream (Lossless)**
- **Dolby Digital 5.1 Channel**
- **DTS 5.1 Channel**
- **Digital Connection**
- **Audio Signal Only**



Optical/SPDIF



BETTER

HDMI CABLE

HDMI technology transmits crystal-clear digital multi-channel surround audio through a single HDMI cable. Audio Return Channel-enabled (ARC) TVs allow audio to be sent over an already connected HDMI cable, eliminating the need for a separate audio cable. See *Connecting an Audio Device - ARC* on page 17.

- **CEC 2-way Communication (Auto setup)**
- **PCM, DTS, Dolby Digital**
- **2.0-5.1 Scalable Lossless Digital Audio Connection**
- **Audio and Video Signals**



HDMI



BEST

CONNECTING AN AUDIO DEVICE - ARC

Without HDMI ARC

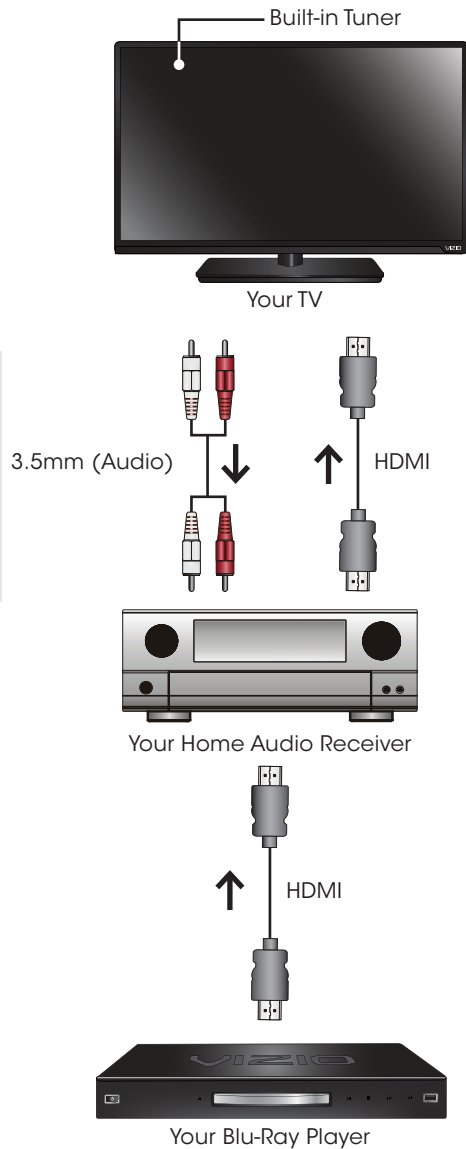

Without an HDMI ARC setup, your TV will transmit audio signals from the built-in tuner to your home audio receiver through a separate audio connection.

With HDMI ARC

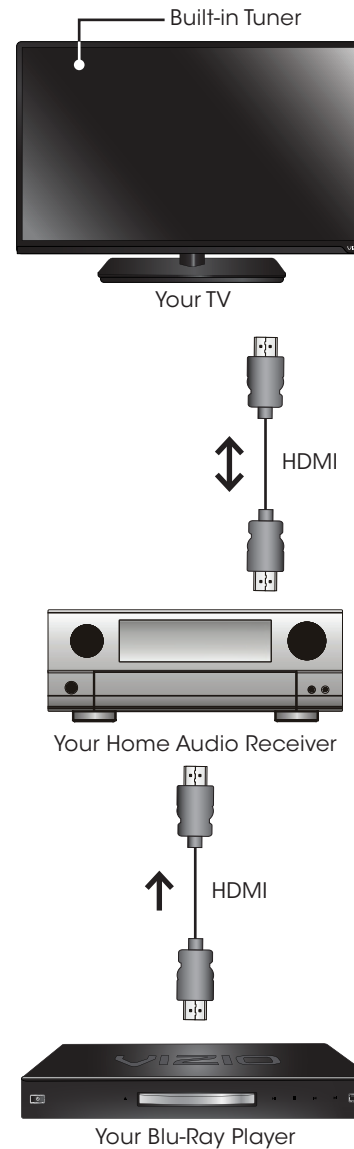

With an HDMI ARC setup, the audio connection between your TV and home audio receiver can be removed. The HDMI cable will transmit audio signals to and from your TV with an all-digital audio/video connection.

The first time you turn on the TV, the Setup App will guide you through each of the steps necessary to get your TV ready for use.

Before you begin the first-time setup:

- Your TV should be installed and the power cord should be connected to an electrical outlet.
- Your devices should be connected.

To complete the first-time setup:

1. Press the **Power/Standby** button on the remote. The TV powers on and the Setup App starts.



2. Use the **Arrow** buttons on the remote to highlight **Home Use** and press **OK**.

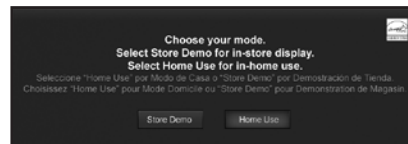

3. Use the **Arrow** and **OK** buttons on the remote to select your preferred language and your country.

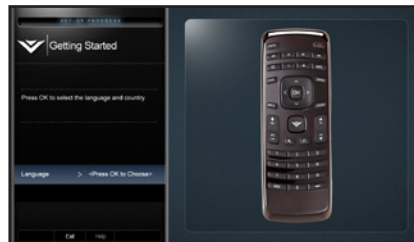

4. Use the **OK** and **Arrow** buttons on the remote to highlight your time zone and press **OK**.
5. Use the **OK** and **Arrow** buttons on the remote to set whether daylight saving time applies in your locale.

When you are finished, highlight **Next** and press **OK**.

6. Use the **OK** and **Arrow Up/Down** Buttons on the remote to select your TV connection.
7. Follow the steps for choosing a device and an input, if they appear.
8. Press **OK** to have the TV begin finding channels, if the option appears.
9. Highlight **Name This Input** and press **OK** to rename the input, if desired.
10. When you have finished setting up your connection and scanning for channels, highlight **Exit to Live TV** and press **OK**.

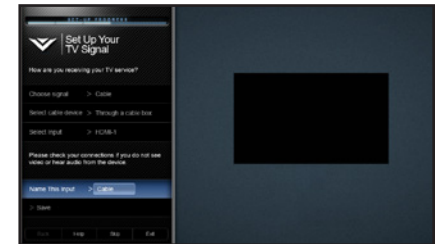

The First-Time Setup is complete.

Your TV features an easy-to-use on-screen menu.

To open the on-screen menu, press the **MENU** button on the remote.

From this menu, you can:

- Adjust the Picture settings
- Adjust the Audio settings
- Activate the Sleep Timer
- Adjust the Tuner settings
- Set up Closed Captioning
- Name the TV Inputs
- Adjust TV Settings
- Access the Guided Setup

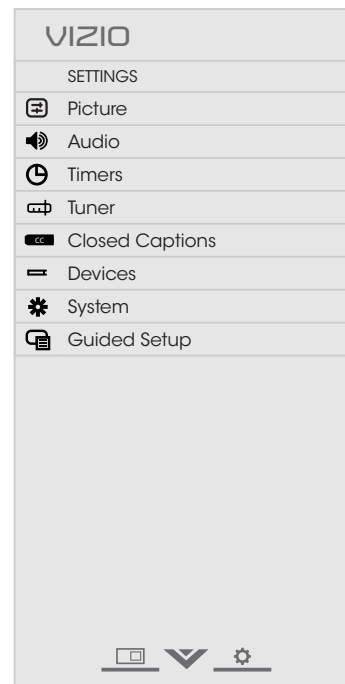

NAVIGATING THE ON-SCREEN MENU

To open the on-screen menu, press the **MENU** button on the remote.

Use the **Arrow** buttons to highlight a menu option, and press the **OK** button to select that option.

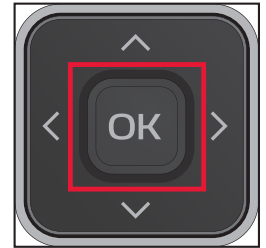

While navigating the on-screen menu, you can press the **BACK** button at any time to return to the previous menu screen. The **EXIT** button will close the on-screen menu.

CHANGING THE INPUT SOURCE

External devices such as DVD players, Blu-ray Players, and video game consoles can be connected to your TV. To use one of these devices with your TV, you must first change the input source in the on-screen menu.

To change the input device:

1. Press the **INPUT** button on the remote. The input menu is displayed.
2. Use the **Up/Down Arrow** buttons or the **INPUT** button on the remote to highlight the input you wish to view and press **OK**. The selected input is displayed.



Note: Inputs may vary by TV.



You can change the input names that appear on the Input menu to make your devices easy to recognize. See *Renaming Devices on the Input Menu* on page 34 for more information.

CHANGING THE SCREEN ASPECT RATIO

The TV can display images in five different modes: Normal, Stretch, Panoramic, Wide, and Zoom. Each mode displays the picture differently.

To change the screen aspect ratio:

1. Press the **WIDE** button on the remote.
2. Use the **Arrow** buttons to highlight the aspect ratio you wish to view and press **OK**.

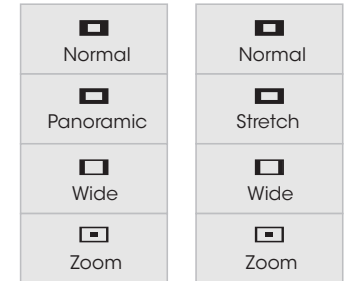

Note: Aspect ratio settings may vary by Input source.

- **Normal** preserves the content's original aspect ratio. Since the 4:3 aspect ratio is not large enough to fill the TV's screen, black bars are added to the left and right of the display image.
- **Stretch** expands the display image to fill the screen. Images may appear wider than intended. If you are watching widescreen (1.85:1 or 2.35:1) content, black bars will still appear on the top and bottom of the display image. **This option is only available when the TV is displaying a 720p/1080i source.**
- **Panoramic** expands the display image to fill the screen. Images may appear wider than intended. If you are watching widescreen (1.85:1 or 2.35:1) content, black bars will still appear on the top and bottom of the display image. **This option is only available when the TV is displaying a 480i/480p source.**
- **Wide** stretches a 4:3 aspect ratio picture to the edges of the screen. Since the picture is being stretched, the display image may appear distorted. If the program is already formatted for widescreen viewing (1.85:1 or 2.35:1), then black bars will appear on the top and bottom of the display image.
- **Zoom** expands images with black bars to fit the screen.

ADJUSTING THE PICTURE SETTINGS

Your TV display can be adjusted to suit your preferences and viewing conditions.

To adjust the picture settings:

1. Press the **MENU** button on the remote. The on-screen menu is displayed.
2. Use the **Arrow** buttons on the remote to highlight **Picture** and press **OK**. The PICTURE menu is displayed.
3. Use the **Arrow** buttons on the remote to highlight **Picture Mode**, then use the **Left/Right Arrow** buttons to change the picture mode:

- **Standard mode** sets the various picture settings to values that meet ENERGY STAR® requirements.
- **Calibrated mode** sets the picture settings to values perfect for watching TV in a brightly-lit room.
- **Calibrated Dark mode** sets the picture settings to values perfect for watching TV in a dark room.
- **Vivid mode** sets the picture settings to values that produce a brighter, more vivid picture.
- **Game mode** reduces throughput delays and optimizes the picture settings for displaying game console output.
- **Computer mode** optimizes the picture settings for displaying computer output.

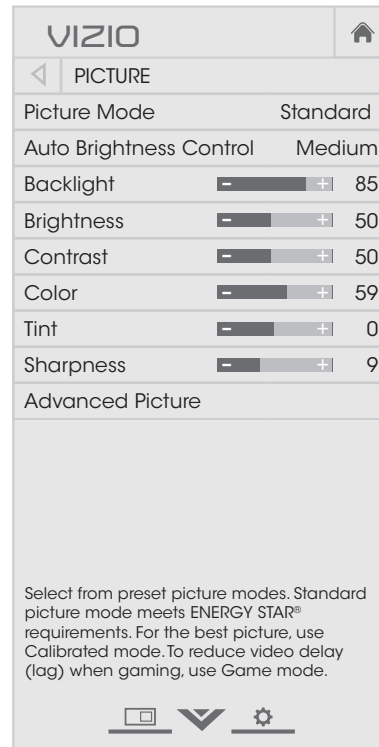

4. To manually change each of the picture settings, use the **Up/Down Arrow** buttons on the remote to highlight that picture setting, then use the **Left/Right Arrow** buttons to adjust the setting:
 - **Auto Brightness Control** - Detects the light levels in the room and automatically adjusts the backlight for the best picture. Select **Off, Low, Medium, or High**.
 - **Backlight** - Adjusts the LED brightness to affect the overall brilliance of the picture. Backlight cannot be adjusted when starting from some picture modes.
 - **Brightness** - Adjusts the black level of the picture. When this setting is too low, the picture may be too dark to distinguish details. When this setting is too high, the picture may appear faded or washed out.
 - **Contrast** - Adjusts the white level of the picture. When this setting is too low, the picture may appear dark. When this setting is too high, the picture may appear faded or washed out. If the setting is too high or too low, detail may be difficult to distinguish in dark or bright areas of the picture.
 - **Color** - Adjusts the intensity of the picture colors.
 - **Tint** - Adjusts the hue of the picture. This setting is useful in adjusting the flesh tones in the picture. If flesh appears too orange, reduce the level of color before adjusting tint.
 - **Sharpness** - Adjusts the edge sharpness of picture elements. It can be used to sharpen non-HD (high definition) content; however, it will not produce detail that does not otherwise exist.
5. When you have finished adjusting the picture settings, press the **EXIT** button on the remote.

Adjusting the Advanced Picture Settings

To adjust the advanced picture settings:

1. From the PICTURE menu, use the **Arrow** buttons on the remote to highlight **Advanced Picture**, then press **OK**. The ADVANCED PICTURE menu is displayed.

2. Use the **Arrow** buttons to highlight the setting you wish to adjust, then press **Left/Right Arrow** buttons to change the setting:

- **Color Temperature** - See *Adjusting the Color Temperature* on page 23.
- **Black Detail** - Adjusts the average brightness of the picture to compensate for large areas of brightness. Select **Off**, **Low**, **Medium**, or **High**.
- **Backlight Control** - Dynamically improves the contrast ratio of the picture by adjusting the backlight. The adjustment is controlled by the content on the screen. Select **On** or **Off**.
- **Reduce Signal Noise** - Diminishes artifacts in the image caused by the digitizing of image motion content. Select **Off**, **Low**, **Medium**, or **High**.
- **Reduce Block Noise** - Reduces pixelation and distortion for mpeg files. Select **Off**, **Low**, **Medium**, or **High**.
- **Picture Position** - Adjust the vertical and horizontal positions of the picture to ensure the image is centered and completely fills the screen. Use the **Left/Right Arrow**

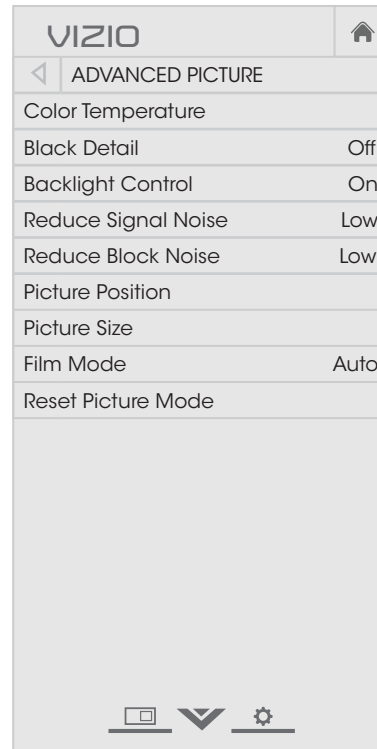

buttons to adjust the horizontal position of the displayed picture. Use the **Up/Down Arrow** buttons to adjust the vertical position of the displayed picture. Press the **OK** button when you are finished.

- **Picture Size** - Increase or decrease the vertical and horizontal size of the displayed picture. Use the **Left/Right Arrow** buttons to adjust the horizontal size of the displayed picture. Use the **Up/Down Arrow** buttons to adjust the vertical size of the displayed picture. Press the **OK** button when you are finished.
 - **Film Mode** - Optimizes the picture for watching film. Select **Auto** or **Off**.
 - **Reset Picture Mode** - See *Resetting the Picture Settings* on page 24.
3. When you have finished adjusting the Advanced Picture Settings, press the **EXIT** button on the remote.

Adjusting the Color Temperature

Adjusting the color temperature will change the white balance of the picture.

To adjust the color temperature:

- From the Picture Menu, use the **Arrow** buttons to highlight **More**, and then press **OK**.
- Use the **Arrow** buttons on the remote to highlight **Color Temperature**, then press **OK**. The Color Temperature menu is displayed.
- Use the **Arrow** buttons on the remote to highlight **Color Temperature**, then use the **Left/Right Arrow** buttons to change the color temperature preset:
 - Cool** produces a blue-hued picture.
 - Computer** optimizes the picture for use as a PC monitor.
 - Normal** is optimized for television viewing.
 - Custom** is intended for technicians to manually calibrate the TV by changing each of the color temperature settings. Calibration requires an input with precisely set colors and a specialized light meter.

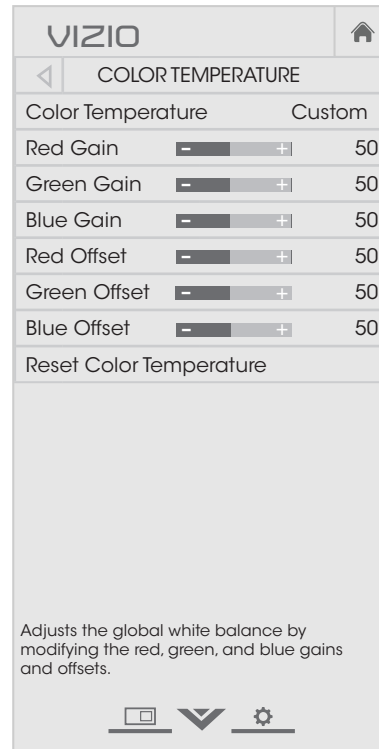

Red/Green/Blue Gain - Adjusts the degree of contrast of each color in the display.

Red/Green/Blue Offset - Adjusts the brightness of each color in the display.

- When you have finished adjusting the color temperature, press the **EXIT** button on the remote.

Resetting the Color Temperature Settings

To reset the Color Temperature settings:

- From the COLOR TEMPERATURE menu, use the **Arrow** buttons to highlight **Reset Color Temperature**, and then press **OK**.
- The TV displays, "Select Reset to restore factory default color temperature settings." Highlight **Reset** and press **OK**.
- Press the **EXIT** button on the remote.

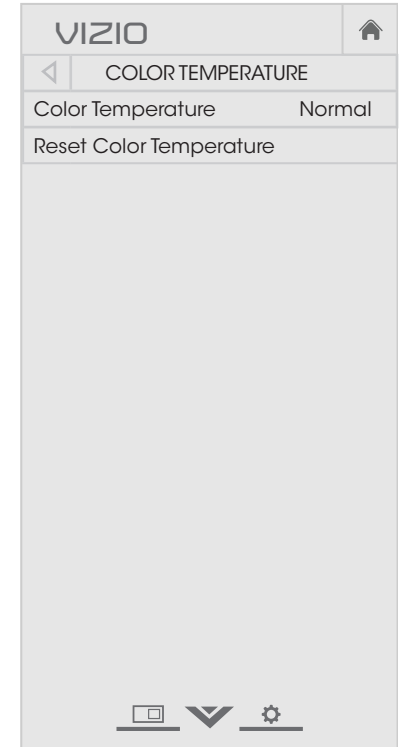

Resetting the Picture Settings

To reset the picture settings to the factory default settings:



Resetting the picture mode only affects the settings for the currently-selected input, such as antenna or HDMI-1.

1. From the ADVANCED PICTURE menu, use the **Arrow** buttons to highlight **Reset Picture Mode**, then press **OK**.
2. The TV displays, "Select Reset to restore factory default picture settings." Highlight **Reset** and press **OK**.
3. Press the **EXIT** button on the remote.

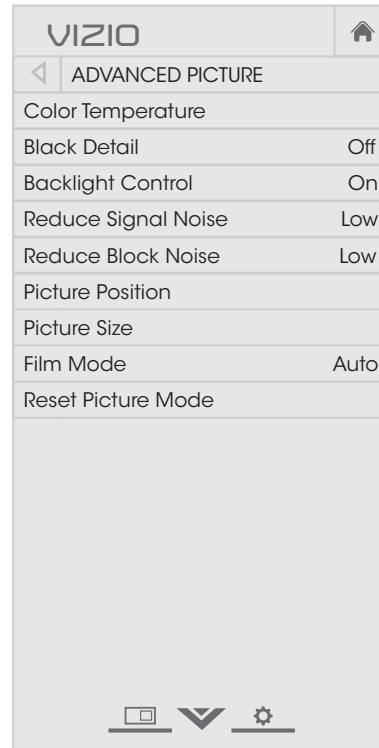

Changing the Equalizer Settings

The graphic equalizer has several pre-set modes and allows you to create one custom mode.

To select a pre-set audio mode:

1. Press the **MENU** button on the remote. The on-screen menu is displayed.
2. Use the **Arrow** buttons on the remote to highlight **Audio** and press **OK**. The AUDIO menu is displayed.
3. Use the **Arrow** buttons to highlight **Equalizer Settings** and press **OK**. The Audio Mode and equalizer settings screen appears.
4. Use the **Left** and **Right Arrow** buttons to select an audio mode. The equalizer bars change to reflect the mode.
5. Press the **EXIT** button on the remote.

To create, modify, or replace the single custom equalizer setting:

1. Press the **MENU** button on the remote. The on-screen menu is displayed.
2. Use the **Arrow** buttons on the remote to highlight **Audio** and press **OK**. The AUDIO menu is displayed.
3. Use the **Arrow** buttons to highlight **Equalizer Settings** and press **OK**. The Audio Mode and equalizer settings screen appears.
4. Use the **Left** and **Right Arrow** buttons to select any audio mode as a starting point.
5. Use the **Arrow** buttons to highlight a frequency and then press **OK**.
6. Use the **Up** and **Down Arrow** buttons to adjust the boost (up) and attenuation (down) for the frequency.
7. Use the **Left** and **Right Arrow** buttons to select another frequency, if desired, and adjust it.
8. Press the **EXIT** button on the remote.

Resetting the Audio Settings

To reset the audio settings to the factory default settings:

1. Press the **MENU** button on the remote. The on-screen menu is displayed.
2. Use the **Arrow** buttons on the remote to highlight **Audio** and press **OK**. The AUDIO menu is displayed.
3. Use the **Arrow** buttons to highlight **Reset Audio Mode** and press **OK**. The TV displays, "Select Reset to restore factory default audio settings."
4. Highlight **Reset** and press **OK**.
5. Press the **EXIT** button on the remote.

SETTING TIMERS

This TV has several timers to save energy and to turn off when you go to sleep.

Setting the Sleep Timer

When activated, the TV's sleep timer will turn the TV off after a set period of time.

1. Press the **MENU** button on the remote. The on-screen menu is displayed.
2. Use the **Arrow** buttons on the remote to highlight **Timers** and press **OK**. The TIMERS menu is displayed.
3. Use the **Left/Right Arrow** buttons on the remote to highlight the period of time after which you want the TV to go to sleep: **30, 60, 90, 120,** or **180 minutes**. If you don't want the sleep timer to activate, change the setting to **Off**.
4. When you have finished setting the sleep timer, press the **EXIT** button on the remote.

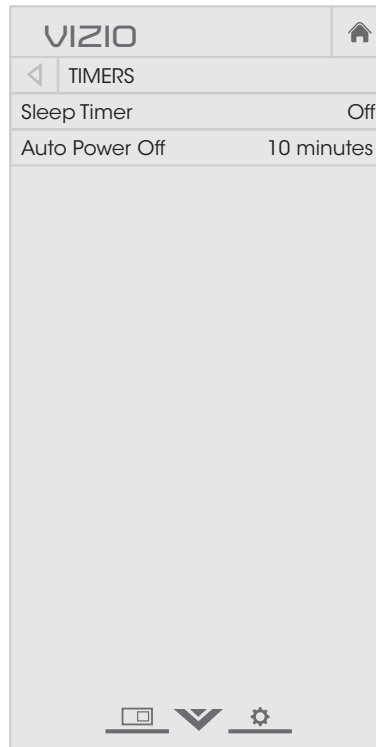

Setting the Auto Power Off Feature

To help save energy, your TV is set by default to turn off after 10 minutes without a video or audio signal. This feature can be deactivated.

To set the Auto Power Off feature:

1. From the TIMERS menu, use the **Up/Down Arrow** buttons on the remote to highlight **Auto Power Off**.
2. Use the **Left/Right Arrow** buttons on the remote to change whether the TV will turn off. If you don't want the TV to turn off when there is no signal, change the setting to **Off**. Otherwise, select **10 minutes**.
3. When you have finished setting the auto power off time, press the **EXIT** button on the remote.

SETTING UP THE TUNER

You can use the TV's Tuner menu to:

- Select a Tuner Input
- Perform an Auto Channel Scan
- Perform a Partial Channel Scan
- Manually Add Channels
- Select Channels to Skip
- Select Analog MTS Modes
- Select Digital Languages

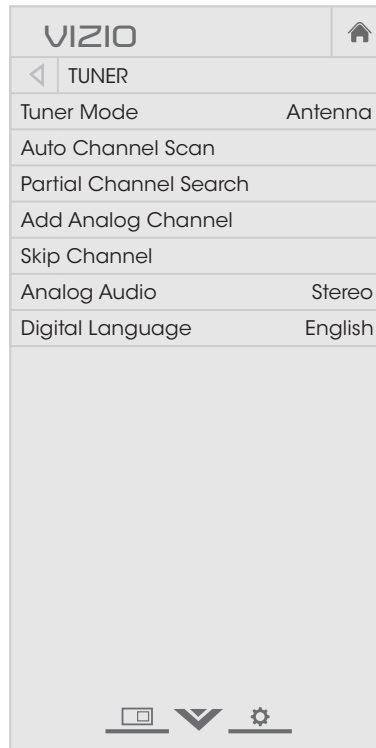

Selecting a Tuner Input

Select the type of tuner input you will be using. You can select either Antenna (Over-the-air) or Cable (Out-of-the-wall) connections.

1. From the TUNER menu, highlight **Tuner Mode** and press **OK**. The TUNER MODE menu displays.
2. Highlight **Antenna** or **Cable** and press **OK**. Press **EXIT**.

Scanning for Channels

Before the TV can detect and display channels and their associated information, you must scan for channels. A channel scan may also be necessary when the TV has been moved to an area where different free-to-air broadcast television channels are available.

To perform an Auto Channel Scan:

1. From the TUNER menu, highlight **Auto Channel Scan**, and press **OK**. The CHANNEL SCAN begins.
2. Wait until the channel scan is 100% complete. Highlight **Done** and press **OK**.
3. Press the **EXIT** button on the remote.

If the channel scan is cancelled, the channels that were already discovered are retained. A new channel scan will clear all channels.

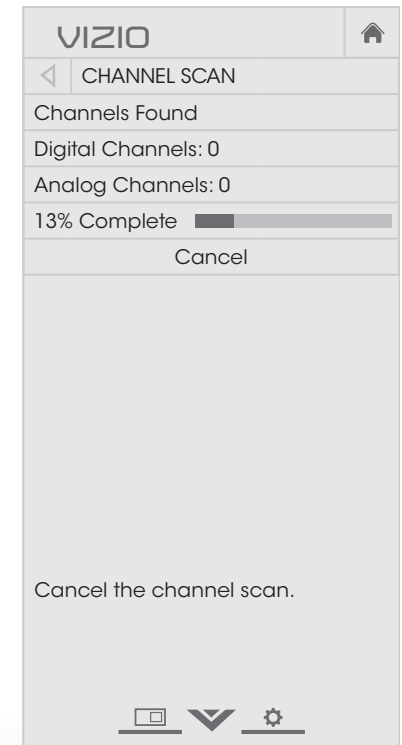

Adding New Channels

Occasionally, you may need to add a new range of channels or add a new analog channel. You can do this by using the Partial Channel Search and Add Analog Channel options.

To add a range of new channels:

1. From the TUNER menu, highlight **Partial Channel Search**, and press **OK**. The PARTIAL CHANNEL SEARCH menu is displayed.
2. Highlight **Scan Mode** and select the type of channel you are adding: **Analog**, **Digital**, or **Analog/Digital**.
3. Highlight **From Channel** and enter the channel where you want to begin the scan. (Use the **Left Arrow** button to backspace. Use the **Number Pad** on the remote to enter the channel.)
4. Highlight **To Channel** and enter the channel where you want to end the scan. (Use the **Left Arrow** button to backspace. Use the **Number Pad** on the remote to enter the channel.)
5. Highlight **Start** and press **OK**. The partial channel search begins.
6. Wait until the partial channel search is 100% complete. Highlight **Done** and press **OK**.
7. Press the **EXIT** button on the remote.

To add a single new analog channel:

1. From the TUNER menu, highlight **Add Analog Channel** and press **OK**. The ADD ANALOG CHANNEL menu is displayed.
2. Highlight **Enter Channel #** and use the **Number Pad** on the remote to enter the number of the channel you are adding.
3. Highlight **Add Channel** and press **OK**. The TV scans for the channel.
4. When the TV is done scanning for the channel, press the **EXIT** button on the remote.

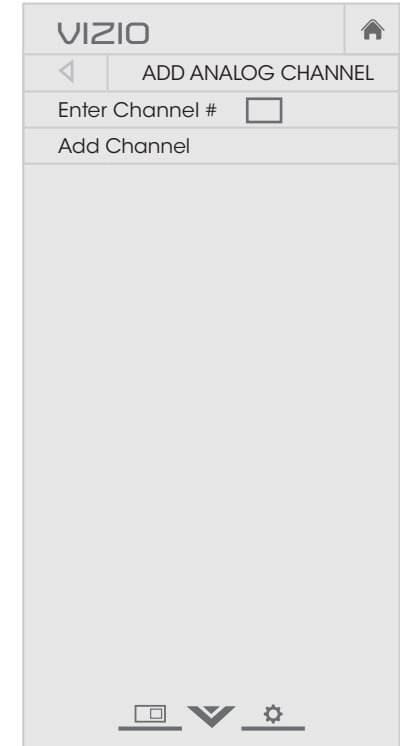

Skipping Channels

After a channel scan is completed, you may find that some channels are too weak to watch comfortably. There may also be some channels you do not want to view. You can remove these channels from the TV's memory with the Skip Channel feature.



Channels that have been removed with the Skip Channel feature can still be viewed if the channel is entered using the Number Pad. If you wish to completely block a channel from being viewed, use the parental controls. See *Locking and Unlocking Channels* on page 37.

To remove a channel:

1. From the TUNER menu, highlight **Skip Channel**, and press **OK**. The SKIP CHANNEL menu is displayed.
2. For each channel you wish to remove, use the **Up/Down Arrow** buttons on the remote to highlight the channel and press **OK**. A ✓ appears to the right of each channel you select.
3. When you have selected all of the channels you wish to remove, press the **EXIT** button on the remote.

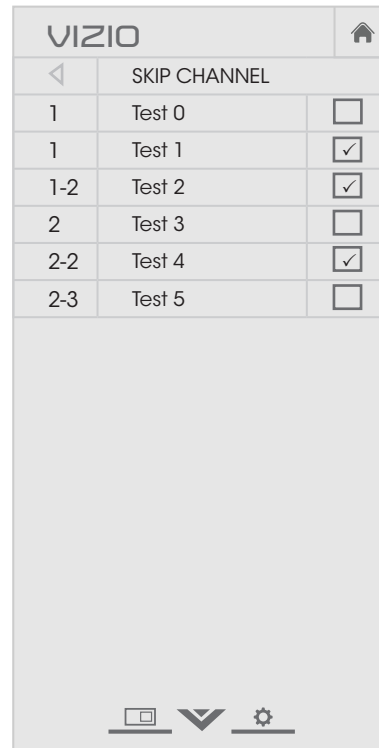

LISTENING TO ALTERNATE AUDIO

Changing the Analog Audio Language

Some analog over-the-air (free) and cable channels broadcast programs in more than one language. The TV's Analog Audio feature allows you to listen to audio in an alternate language using Secondary Audio Programming (SAP).



Not all programs are broadcast in SAP. The Analog Audio Language feature only works when the program being viewed is being broadcast with Secondary Audio Programming.

To use the Analog Audio feature:

1. From the Tuner menu, highlight **Analog Audio** and press **OK**. The Analog Audio menu is displayed.
2. Select **Stereo**, **SAP** (secondary audio programming), or **Mono**. Press **OK**.
3. Press the **EXIT** button on the remote.

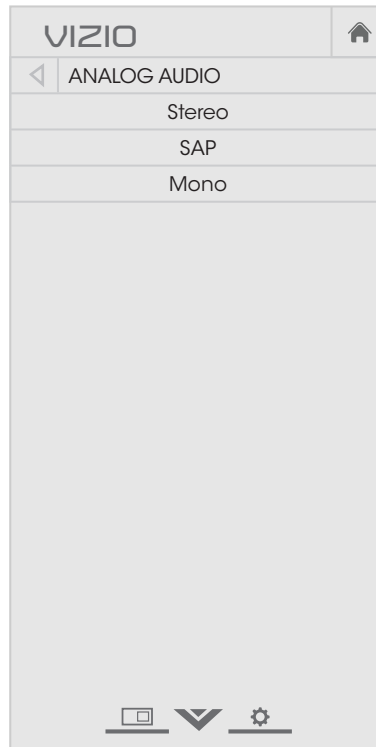

Changing the Digital Audio Language

Some digital over-the-air (free), cable, and satellite channels broadcast programs in more than one language. The TV's Digital Audio feature allows you to listen to audio in alternate languages.



Not all programs are broadcast in alternate languages. The Digital Audio Language feature only works when the program being viewed is being broadcast in the language you select.

1. From the Tuner menu, highlight **Digital Language** and press **OK**. The Digital Language menu is displayed.
2. Select your preferred language: **English**, **Français**, or **Español**. Press **OK**.
3. Press the **EXIT** button on the remote.

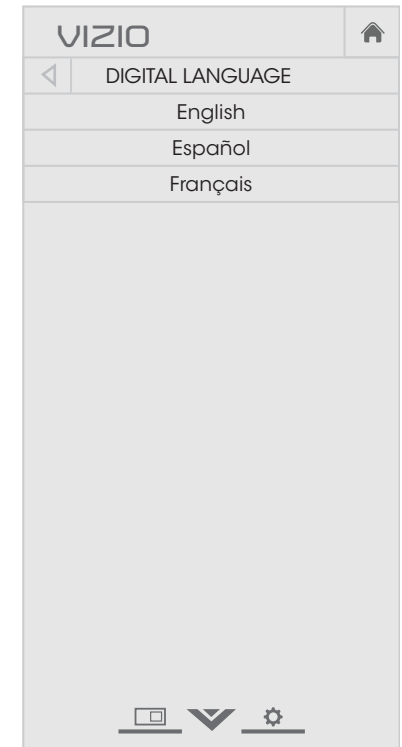

SETTING UP CLOSED CAPTIONING

Your TV can display closed captions for programs that include them. Closed captions display a transcription of a program's dialogue.



If the program you are viewing is not being broadcast with closed captions, the TV will not display them.

The Closed Captioning menu only appears when the input is an antenna for Over-the-Air signals, cable TV directly from the wall (no cable box), or a device with a composite video connection.

To activate or deactivate closed captions:

1. Press the **MENU** button on the remote. The on-screen menu is displayed.
2. Use the **Arrow** buttons on the remote to highlight **Closed Captions** and press **OK**. The CLOSED CAPTIONS menu is displayed.
3. Use the **Arrow** buttons on the remote to highlight the type of closed captions you wish to see:
 - **Analog Closed Captions** for analog (NTSC) TV channels.
 - **Digital Closed Captions** for digital (ATSC) TV channels.
4. After highlighting the type of closed captions you wish to see, use the **Left/Right Arrow** buttons on the remote to select the caption channel you wish to display, then press **EXIT**.

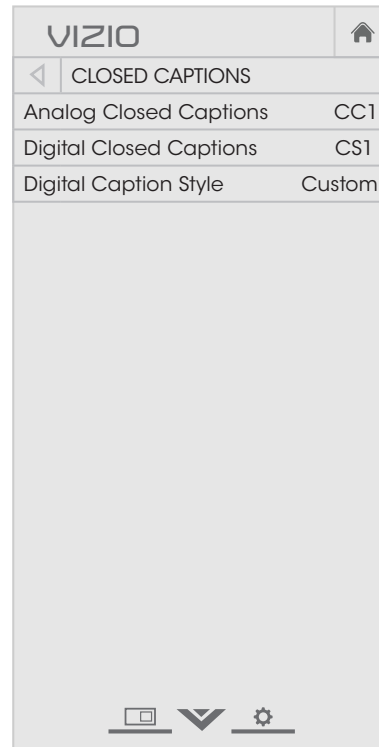

Changing the Appearance of Digital Closed Captions

Digital closed captions can be displayed according to your preference. See the diagram on the next page for an explanation of the parts of the closed caption area.

To change the appearance of digital closed captions:

1. From the CLOSED CAPTIONS menu, use the **Arrow** buttons to highlight **Digital Closed Captions Style** and press **OK**.
2. Use the **Left/Right Arrow** buttons on the remote to select **Custom**. The DIGITAL CLOSED CAPTIONS STYLE menu appears as shown.
3. Use the **Up/Down Arrow** buttons on the remote to highlight the setting you wish to change, then use the **Left/Right Arrow** buttons to change the setting:
 - **Caption Style** - Choose **As Broadcast** to keep default settings or **Custom** to manually change each setting.
 - **Text Style** - Change the font used for the closed captioning text.
 - **Text Size** - Make the text larger or smaller.
 - **Text Color** - Change the color of the text.
 - **Text Opacity** - Change the transparency of the text.
 - **Text Edges** - Change the effects at the edges of the text, such as raising the edges or adding drop shadows.
 - **Text Edges Color** - Change the color of the text edge effects.

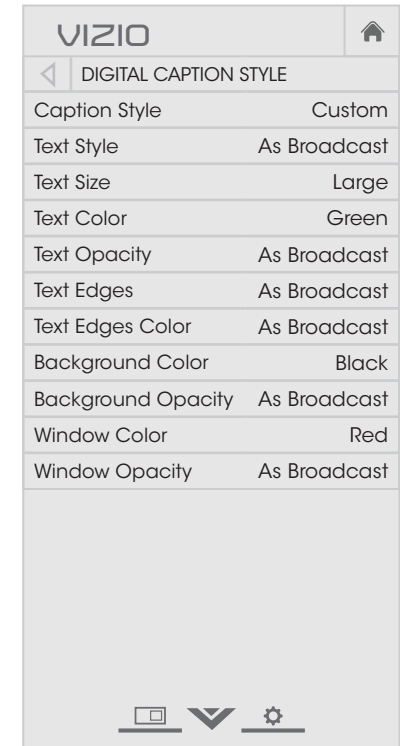

- **Background Color** - Change the color of the background directly behind the text.
 - **Background Opacity** - Change the transparency of the background directly behind the text.
 - **Window Color** - Change the color of the closed captioning box.
 - **Window Opacity** - Change the opacity of the closed captioning box
4. When you are satisfied with the appearance of the closed captions, press the **EXIT** button on the remote.

Typical choices include:

- Opaque background, transparent window—Only a strip of background appears behind the text, expanding as the text appears. This is the typical "As Broadcast" mode.
- Opaque background and window in the same color—When text appears, the entire line fills with color at once.

In the example below, the closed caption text is green, the background is black, and the window is red.

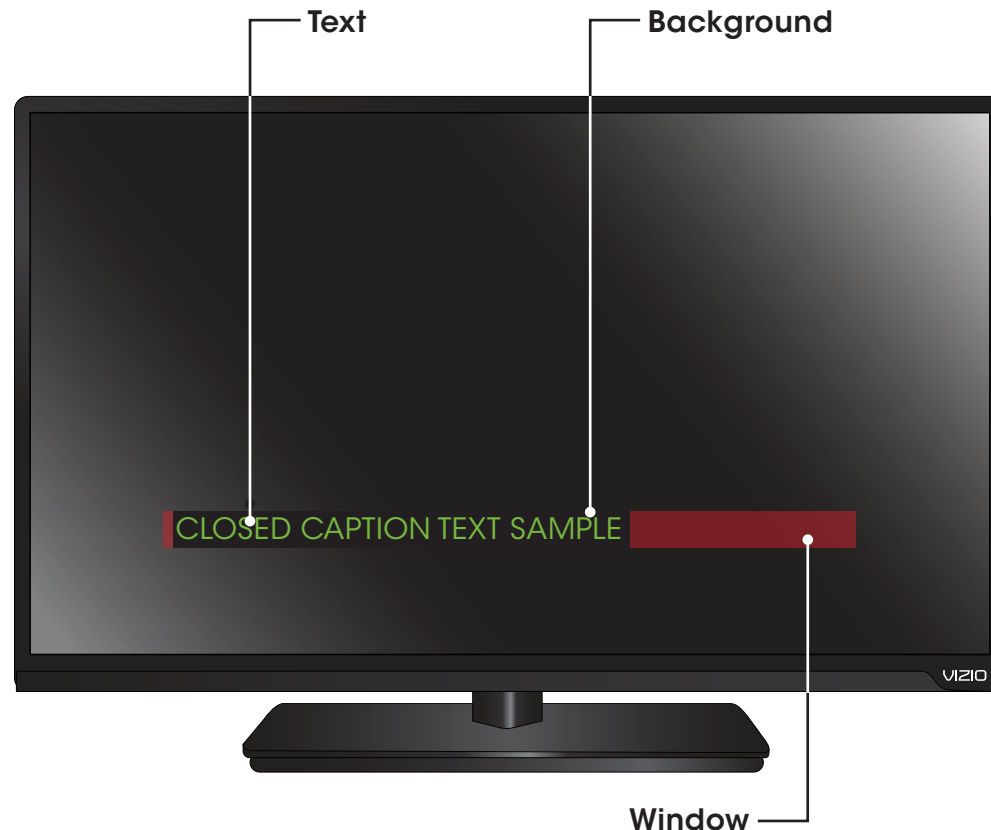

CLOSED CAPTIONS SCREEN LAYOUT

RENAMING DEVICES ON THE INPUT MENU

Inputs can be renamed to make them easier to recognize on the Input menu (see *Changing the Input Source* on page 20). For example, if you have a DVD player connected to the Component input, you can rename that input to display "DVD Player."

To change the name of an input:

1. Press the **MENU** button on the remote. The on-screen menu is displayed.
2. Use the **Arrow** buttons on the remote to highlight **Devices** and press **OK**. The DEVICES menu is displayed.
3. Highlight the input device that you want to rename and press **OK**.
4. To use a preset input name:
 - a. Highlight the **Input Port** row and press **OK**.
 - b. Highlight the input name you want to use and press **OK**.

To enter a custom name:

- a. Enter your custom name using the on-screen keyboard.
 - b. Highlight **OK** and press **OK**.
 - c. The Input Name changes to show the custom name that you created.
5. When you have finished naming your input, press the **EXIT** button on the remote.



CHANGING THE TV SETTINGS

Using the system menu, you can:

- View system information
- Change the on-screen menu language
- Set the time zone and local settings
- Set up parental controls
- Adjust the CEC settings
- Adjust when the power indicator is illuminated
- Reset the TV settings & set up administrative controls

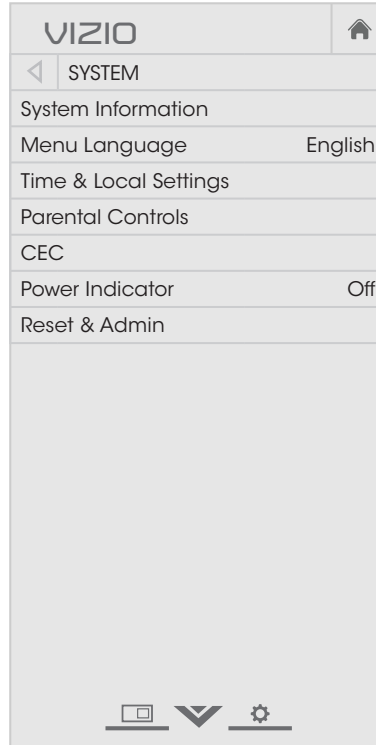

Viewing System Information

To view a summary of the TV settings:

1. Press the **MENU** button on the remote. The on-screen menu is displayed.
2. Use the **Arrow** buttons on the remote to highlight **System** and press **OK**. The SYSTEM menu is displayed.
3. Highlight **System Information** and press **OK**.
4. Use the **Up/Down Arrow** buttons to scroll through the system information.
5. When you are finished reviewing the system information, press the **EXIT** button on the remote.

Changing the On-Screen Menu Language

Your TV can display the on-screen menu in different languages.

To change the on-screen menu language:

1. Press the **MENU** button on the remote. The on-screen menu is displayed.
2. Use the **Arrow** buttons on the remote to highlight **System** and press **OK**. The SYSTEM menu is displayed.
3. Use the **Arrow** buttons on the remote to highlight **Menu Language** and press **OK**. The MENU LANGUAGE menu is displayed.
4. Highlight your preferred language (**English**, **Español**, or **Français**) and press **OK**.
5. Press the **EXIT** button on the remote.

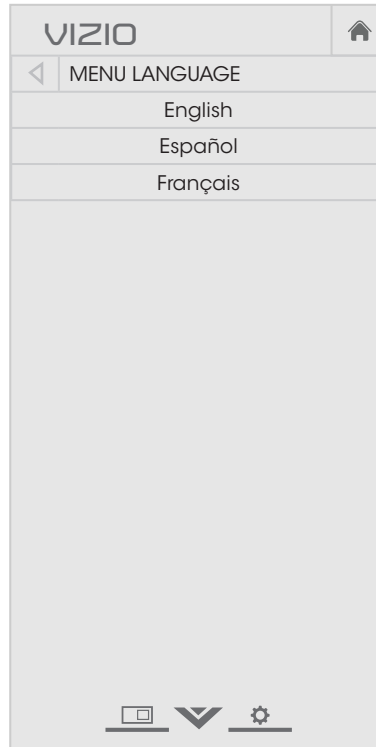

Setting the Time Zone

To ensure the correct time is displayed when you press the **GUIDE** button, set the TV's time zone:

1. Press the **MENU** button on the remote. The on-screen menu is displayed.
2. Use the **Arrow** buttons on the remote to highlight **System** and press **OK**. The SYSTEM menu is displayed.
3. Use the **Arrow** buttons on the remote to highlight **Time & Local Settings** and press **OK**. The TIME & LOCAL SETTINGS menu is displayed.
4. Highlight **Time Zone** and press **OK**. The TIME ZONE menu is displayed.
5. Highlight your time zone and press **OK**.
6. Highlight **Daylight Saving** and press **OK**. The DAYLIGHT SAVING menu is displayed. Choose **On** if your locale observes daylight savings time, or **Off** if it does not.
7. Press the **EXIT** button on the remote.

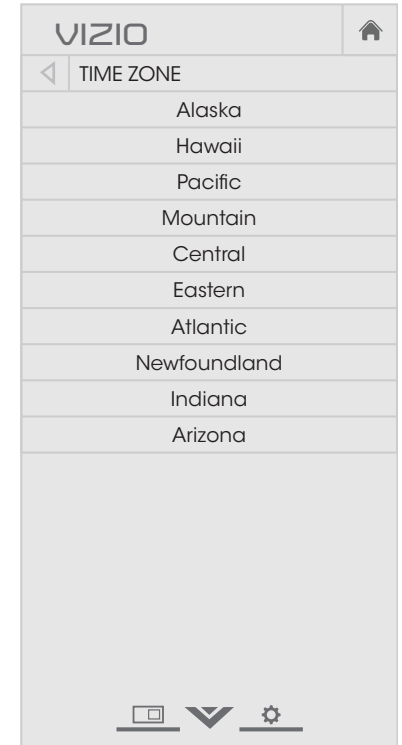

Using the Parental Controls

The TV's parental controls allow you to prevent the TV from displaying certain channels or programs without a password.

The Parental Controls menu only appears when:

- You are using an the tuner receive your TV signals, such as when you are using an antenna for Over-the-Air signals or when connected to cable TV directly from the wall (no cable box).
- You have a device connected using a composite video cable or a coaxial cable, such as a VCR, satellite or cable box, or DVR.

Accessing the Parental Controls Menu

To access the Parental Controls menu:

1. Press the **MENU** button on the remote. The on-screen menu is displayed.
2. Use the **Arrow** buttons on the remote to highlight **System** and press **OK**. The SYSTEM menu is displayed.
3. Use the **Arrow** buttons on the remote to highlight **Parental Controls** and press **OK**.
4. Enter your parental passcode. If you have not set a passcode, enter the default, **0000**. The PARENTAL CONTROLS menu is displayed.



To set a custom parental passcode, see *Changing the Parental Control Passcode* on page 38.

Enabling or Disabling Program Ratings

To manage program content according to its rating, you must enable the Program Rating feature.

To enable or disable the Program Rating feature:

1. From the PARENTAL CONTROLS menu, highlight **Locks** and press **OK**. The LOCKS menu is displayed.
2. Select **On** or **Off** and press **OK**.

Locking and Unlocking Channels

When a channel is locked, it will be inaccessible. Locking a channel is a good way to prevent children from viewing inappropriate material.

To lock or unlock a channel:

1. From the PARENTAL CONTROLS menu, highlight **Channel Locks** and press **OK**. The CHANNEL LOCKS menu is displayed.
2. Highlight the channel you want to lock or unlock and press **OK**.
3. When a channel is **locked**, the **Lock** icon appears **locked**. The channel is not accessible unless the parental passcode is entered.
4. When a channel is **unlocked**, the **Lock** icon appears **unlocked**. The channel is accessible.

Blocking and Unblocking Content by Rating

A channel may sometimes broadcast programs that are meant for children, and at other times broadcast programs that are meant for mature audiences. You may not want to block the channel completely using a channel lock, but you may wish to block certain programs from being viewed.

When this is the case, you can use the TV's Rating Block feature to block content based on its rating.



For a list of content ratings and their definitions, visit www.tvguidelines.org.

To block or unblock content by its rating:

- From the PARENTAL CONTROLS menu, highlight the content type you want to adjust and press **OK**:
 - USA TV** - USA television program broadcasts.
 - USA Movie** - USA movie broadcasts.
 - CAN - English** - Canadian English television program broadcasts.
 - CAN - French** - Canadian French television program broadcasts.
- For each rating type you want to block or unblock, use the **Up/Down** and **Left/Right Arrow** buttons on the remote to highlight the rating type and press **OK**.
- When the rating type is **blocked**, the **Lock** icon appears **locked**. Content with this rating and all higher ratings cannot be viewed.
- When the rating type is **unblocked**, the **Lock** icon appears **unlocked**. Content with this rating and all lower ratings can be viewed.

If you want to block all unrated content, highlight **Block Unrated Shows** and use the **Arrow** buttons on the remote to select **On**.
- When you are finished adjusting the rating level blocks, press the **EXIT** button on the remote.

Changing the Parental Control Passcode

If you use the parental controls, you should change the passcode to prevent children from accessing inappropriate material.

To change the parental control passcode:

- From the PARENTAL CONTROLS menu, highlight **Change PIN** and press **OK**. The CHANGE PIN menu is displayed.
- In the **New PIN** field, use the **Number Pad** on the remote to enter your new 4-digit parental control passcode.
- In the **Confirm PIN** field, use the **Number Pad** on the remote to re-enter your new 4-digit parental control passcode.
- Write down your new parental control passcode and save it in a secure location.
- Press the **EXIT** button on the remote.

Resetting the Content Locks

To reset the content locks to the factory-default settings:

- From the PARENTAL CONTROLS menu, highlight **RESET LOCKS** and press **OK**. The TV displays, "Are you sure you want to RESET ALL LOCKS SETTINGS to the factory defaults?"
- Highlight **Yes** and press **OK**.

Adjusting the CEC Settings

The CEC function on your TV enables you to control HDMI-connected devices with the included remote without any additional programming.



Not all HDMI devices support CEC. See your device's user manual for details.

To enable, disable, or adjust CEC settings:

1. Press the **MENU** button on the remote. The on-screen menu is displayed.
2. Use the **Arrow** buttons on the remote to highlight **System** and press **OK**. The SYSTEM menu is displayed.
3. Use the **Arrow** buttons on the remote to highlight **CEC** and press **OK**. The CEC menu is displayed.
4. Use the **Arrow** and **OK** buttons to adjust each setting:
 - **CEC** - To use CEC, you must select **On**.
 - **System Audio Control** - When system audio control is on, you can control your device's audio using the TV's remote control.
 - **Device Discovery** - Use this function to determine if your device is connected and supports CEC.
5. Press the **EXIT** button on the remote.

Turning the Power Indicator On or Off

The Power Indicator on the front of your TV normally does not glow when the TV is on. You can change this setting if you prefer the light to be on.

To turn the Power Indicator Light on or off:

1. Press the **MENU** button on the remote. The on-screen menu is displayed.
2. Use the **Arrow** buttons on the remote to highlight **System** and press **OK**. The SYSTEM menu is displayed.
3. Highlight **Power Indicator** and press **OK**. The POWER INDICATOR menu is displayed.
4. Use the **Up/Down Arrow** buttons to select **On** or **Off**, then press **OK**.

USING THE RESET & ADMIN MENU

You can use the TV's Reset & Admin menu to restore the TV to its factory default settings.

Restoring the TV to Factory Default Settings

All of the on-screen menu settings can be reset to the factory defaults.



If you restore the TV to the factory default settings, all changes you have made to the settings will be lost!

To restore the TV to its factory default settings:

1. Press the **MENU** button on the remote. The on-screen menu is displayed.
2. Use the **Arrow** buttons on the remote to highlight **System** and press **OK**. The SYSTEM menu is displayed.
3. Highlight **Reset & Admin** and press **OK**. The RESET & ADMIN menu is displayed.
4. Highlight **Reset TV to Factory Defaults** and press **OK**.
5. If you have changed the default parental control passcode, enter it now.

The TV displays, "Select Reset to restore all TV settings to factory defaults."

6. Highlight **Reset** and press **OK**.
7. Wait for the TV to turn off. The TV will turn back on shortly afterward and the Setup App will begin.

USING THE GUIDED SETUP MENU

Using Guided Setup

The TV's Setup App can be used to easily set up the TV tuner.

To use guided setup:

1. Press the **MENU** button on the remote. The on-screen menu is displayed.
2. Highlight **Guided Setup** and press **OK**. The GUIDED SETUP menu is displayed.
3. Highlight **Tuner Setup** and press **OK**.
4. Follow the on-screen instructions. When finished, press the **EXIT** button on the remote.

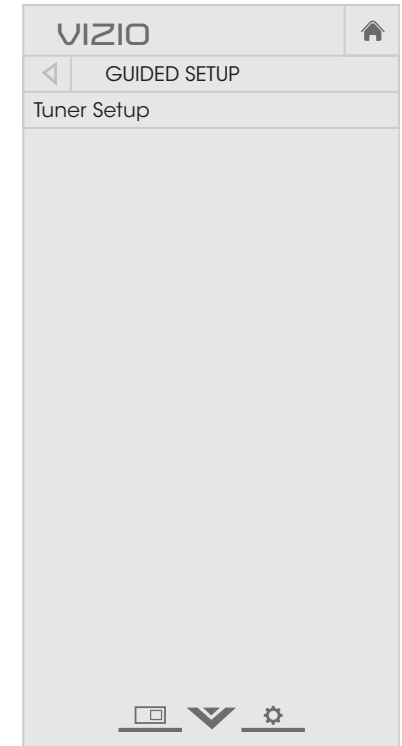

USING THE INFO WINDOW

The Info Window can be displayed by pressing the **GUIDE** button on the remote:

- Press the **GUIDE** button one time to display channel, input, and display information.
- Press the **GUIDE** button two times to display the program title, program rating, audio information, and the start and end times of the program.

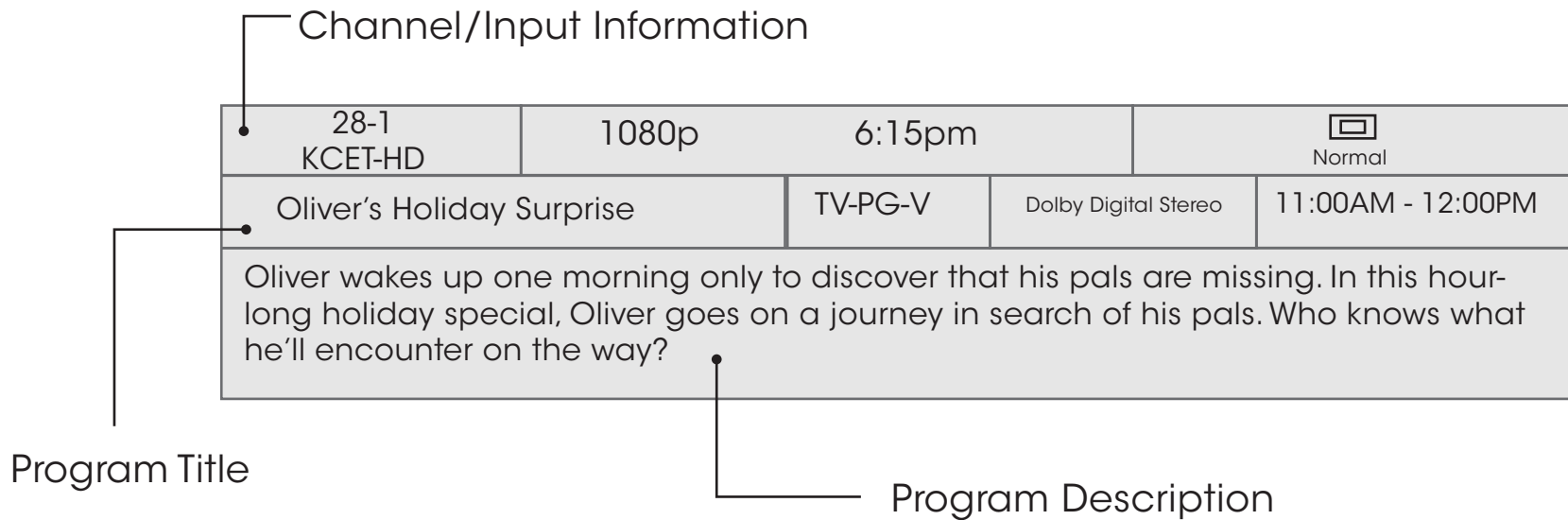

DIGITAL EPISODE GUIDE WINDOW

USING THE USB MEDIA PLAYER

The USB Media Player allows you to connect a USB thumb drive to your TV and view photos.

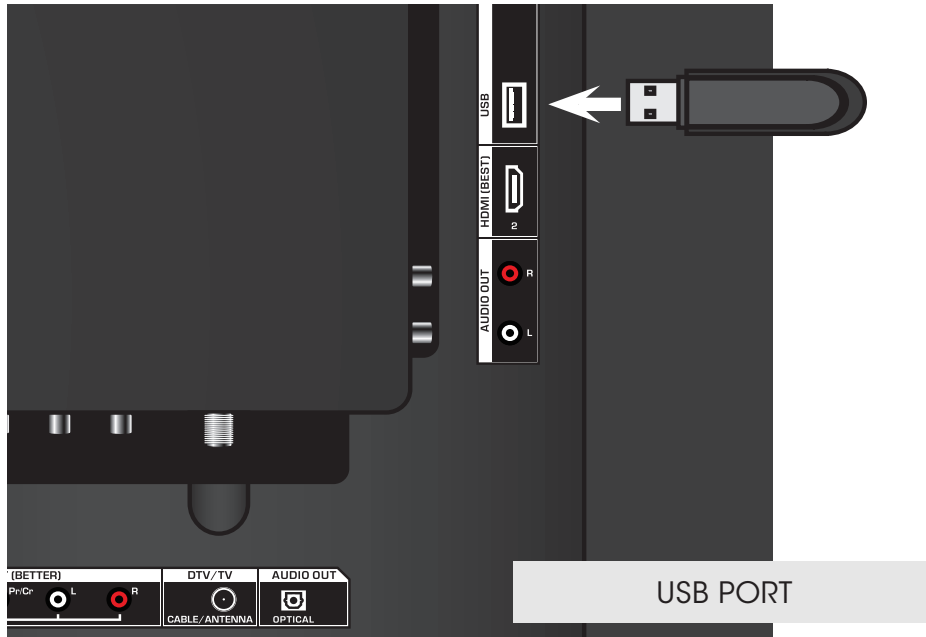

Preparing Your USB Drive to Play USB Media

To play USB media, you must first save your photos onto a USB thumb drive:

- The USB thumb drive must be formatted as FAT32.
- Files on the USB thumb drive must end in a supported file extension (.jpg or .jpeg.).
- The player is not designed to play media from external hard drives, MP3 players, cameras, or smartphones.

Playing USB Media

To play your USB media:

1. Connect your USB thumb drive to the USB port on the side of the TV.
2. Use the **Arrow** buttons to highlight **Yes** and press the **OK**.



If the dialog box disappears, press the **V button** on the remote to go the next step.

3. Use the **Arrow** buttons to highlight your USB device in the list and press **OK**.
4. Use the **Arrow** buttons to highlight **Photo** and press **OK**.
5. Use the **Arrow** buttons to highlight the photo you want to display. Press **OK**. The photo displays.



You can display your photos in fullscreen. Select the photo, press **OK**, then highlight **Fullscreen** and press **OK**.

Removing the USB Drive from the TV



Do not remove the USB thumb drive while the TV is on. Doing so may damage the drive.

To safely remove your USB drive from the TV:

1. Turn off the TV.
2. Disconnect your USB thumb drive from the USB port on the side of the TV.

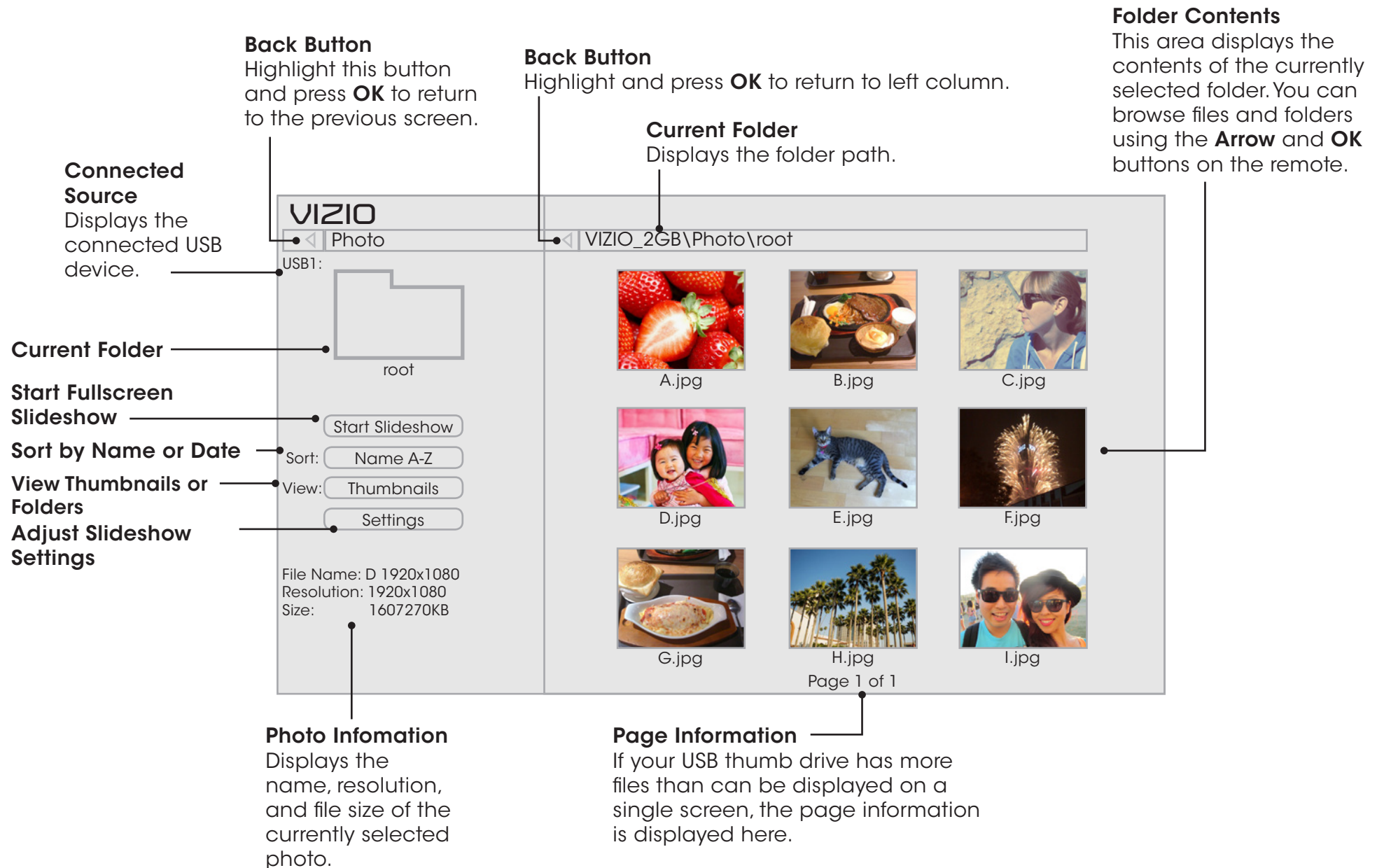

DO YOU HAVE QUESTIONS?

LET US HELP!

YOUR PRODUCT INCLUDES FREE LIFETIME TECH SUPPORT

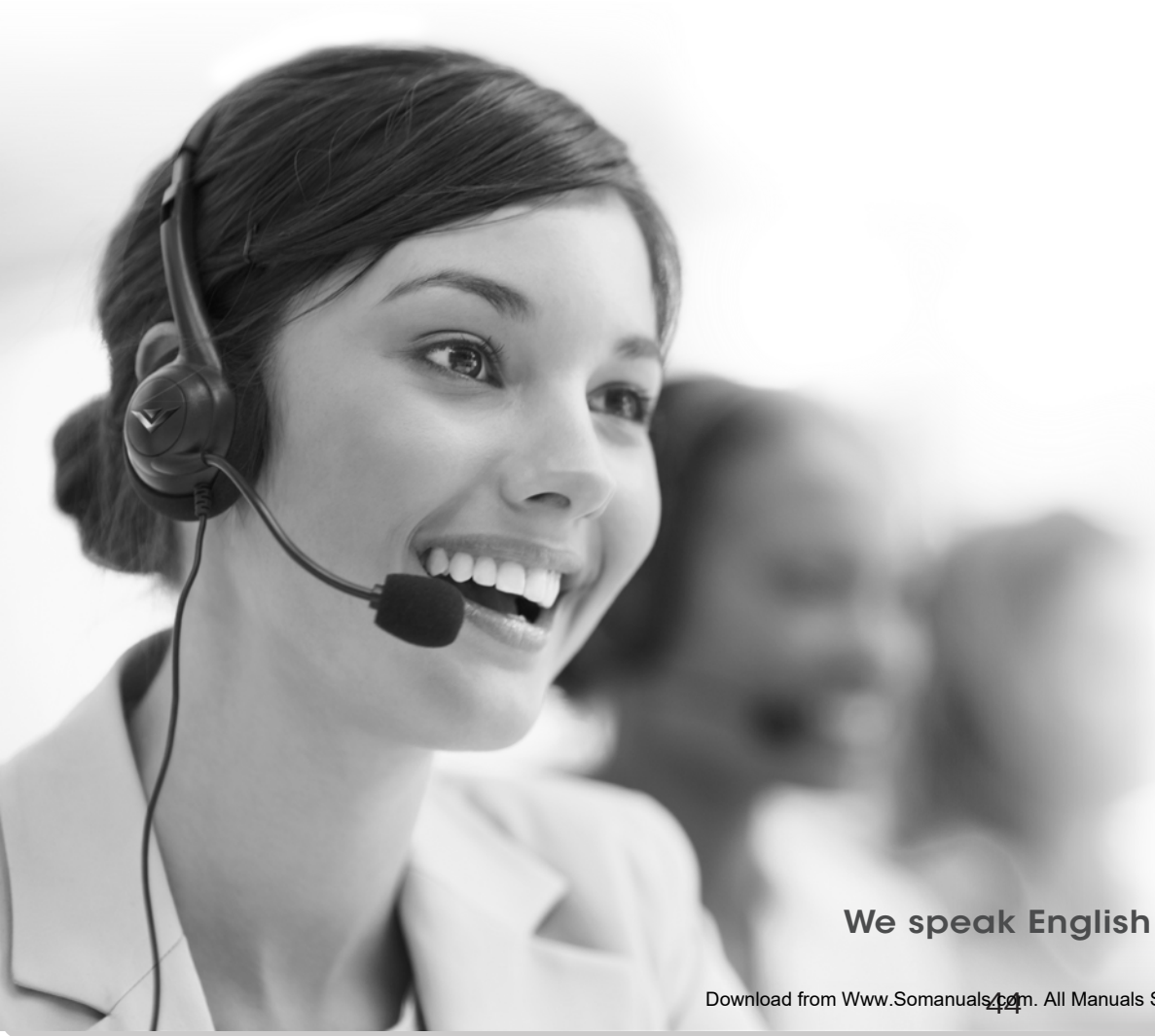

The VIZIO support team is highly trained and is based in the United States.

We can help with:

- New Product Setup
- Connecting Your Devices
- Technical Problems
- And More

Phone: (877) 878-4946 (TOLL-FREE)

Email: techsupport@VIZIO.com

Web: www.VIZIO.com/support

Hours of operation:

Monday - Friday: 5 AM TO 8 PM (PST)

Saturday - Sunday: 7 AM TO 4 PM (PST)

We speak English • Se habla Español • Nous parlons Français

The TV displays “No Signal.”

- Press the **INPUT** button on the remote control to select a different input source.
- If you are using cable TV, satellite, or an antenna connected directly to the TV, scan for channels. See *Scanning for Channels* on page 28.

There is no power.

- Ensure the TV is plugged into a working electrical outlet.
- Ensure the power cable is securely attached to the TV.
- Press the **Power/Standby** button on the remote or on the side of the TV to turn the TV on.

The power is on, but there is no image on the screen.

- Ensure all cables are securely attached to the TV.
- Ensure all devices are connected correctly. Devices differ; see your device’s user manual for details.
- Adjust Brightness, Contrast, or Backlight. See *Adjusting the Picture Settings* on page 21.
- Press the **INPUT** button on the remote to select a different input source.

There is no sound.

- Press **Volume Up** on the remote control.
- Press the **MUTE** button on the remote to ensure mute is off.
- Check the audio settings. See *Adjusting the Audio Settings* on page 25. Ensure that the speakers are set to On.
- Ensure no headphones are connected to the TV.
- Check the audio connections of external devices (Blu-ray player, game console, cable/satellite box) that are connected to the TV.
- If you are using an antenna, the signal strength of the channel may be low. Ensure your antenna is connected securely to the TV and move the antenna around the room or close to a window for the best signal.

The colors on the TV don’t look right.

- Adjust the Color and Tint settings in the Picture menu. See *Adjusting the Picture Settings* on page 21.
- Check all cables to ensure they are securely attached.
- Reset the picture settings. See *Resetting the Picture Settings* on page 24.

The buttons on the remote aren’t working.

- Ensure you are only pressing one button at a time.
- Point the remote directly at the TV when pressing a button.
- Replace the remote batteries with new ones. See *Replacing the Batteries* on page 11.

The image quality is not good.

- For the best image quality, view high-definition programs using digital sources. Connect your devices with HDMI cables.
- If you are using an antenna, the signal strength of the channel may be low. Ensure your antenna is connected securely to the TV and move the antenna around the room or close to a window for the best signal.

The picture is distorted.

- Nearby electrical devices may be interfering with the TV. Separate the TV from electrical appliances, cars, or fluorescent lights.
- Ensure all cables are securely attached.

The display image does not cover the entire screen.

- If you are using TV, AV, or Component with 480i input, press the **WIDE** button on the remote to change the screen mode.

The TV has pixels (dots) that are always dark or always lit.

- Your HDTV is precision-manufactured using an extremely high level of technology. However, sometimes pixels may not display correctly. These types of occurrences are inherent to this type of product and do not constitute a defective product.

I see "noise" or static on the screen.

- When your TV's digital capabilities exceed a digital broadcast signal, the signal is up-converted (improved) to match your TV's display capabilities. This up-converting can sometimes cause irregularities in the image.
- If you are using an antenna, the signal strength of the channel may be low. Ensure your antenna is connected securely to the TV and move the antenna around the room or close to a window for the best signal.

When I change input source, the volume changes.

- The TV remembers the volume level on each input source. If the volume level on the new input source is higher or lower than the level on the source you switch from, the difference may be noticeable.
- Use the **Volume Up/Down** buttons on the remote to adjust the volume.

When I change input source, the display image changes size.

- The TV remembers the viewing mode on each input source. If the viewing mode on the new input source differs from the one on the input source you switch from, the difference may be noticeable.
- See *Changing the Screen Aspect Ratio* on page 20.

E420-B1

Screen Size:	42" Class
Viewable Area:	42.02"
Dimensions w/ Stand:	37.71" x 23.80" x 7.66"
w/o Stand:	37.71" x 22.15" x 2.48"
Weight w/ Stand:	24.25 lbs
w/o Stand:	22.05 lbs
TV Type:	D-LED
Refresh Rate:	60 Hz
Maximum Resolution:	1920 x 1080 (1080p)
Pixel Pitch:	.4845 mm (H) x .4845 mm (V)
Response Time:	6.5 ms
Brightness:	300 nits
Viewing Angle:	178° (H) / 178° (V)
HDMI Inputs:	2
Component Video Inputs:	1
Composite Inputs:	1 (Shared with Component)
RF Antenna Input:	1
USB 2.0 Ports:	1
Audio Outputs:	RCA Analog Stereo Output, Optical Digital
OSD Languages:	English, Spanish, French

E420-B1**Remote Control Model:**

XRT010

Certifications:UL, FCC Class B,
HDMI (CEC, ARC), Dolby Digital**Compliance:**

Energy Star 6.0

Voltage Range:

120V @ 60 Hz

Power Consumption:

54.4W

Standby Power:

<1W

ON PARTS AND LABOR

Covers units purchased as new in United States and Puerto Rico Only. VIZIO provides a warranty to the original purchaser of a new Product against defects in materials and workmanship for a period of one (1) year of non-commercial usage and ninety (90) days of commercial use. If a Product covered by this warranty is determined to be defective within the warranty period, VIZIO will either repair or replace the Product at its sole option and discretion.

To obtain warranty service, contact VIZIO Technical Support via e-mail: TechSupport@VIZIO.com or via phone at 877 MY VIZIO (877.698.4946) from 5:00AM to 9:00PM Monday through Friday and 8:00AM to 4:00PM Saturday and Sunday, Pacific Time, or visit www.VIZIO.com. PRE-AUTHORIZATION MUST BE OBTAINED BEFORE SENDING ANY PRODUCT TO A VIZIO SERVICE CENTER. Proof of purchase in the form of a purchase receipt or copy thereof is required to show that a Product is within the warranty period.

Parts and Labor

There will be no charge for parts or labor during the warranty period. Replacement parts and Products may be new or recertified at VIZIO's option and sole discretion. Replacement parts and Products are warranted for the remaining portion of the original warranty or for ninety (90) days from warranty service or replacement, whichever is greater.

Type of Service

Defective Products must be sent to a VIZIO service center to obtain warranty service. VIZIO is not responsible for transportation costs to the service center, but VIZIO will cover return shipping to the customer. PRE-AUTHORIZATION IS REQUIRED BEFORE SENDING ANY PRODUCT TO A VIZIO SERVICE CENTER FOR WARRANTY SERVICE.

Product returns to VIZIO's service centers must utilize either the original carton box and shipping material or packaging that affords an equal degree of protection. VIZIO Technical Support will provide instructions for packing and shipping the covered Product to the VIZIO service center.

Limitations and Exclusions

VIZIO's one-year limited warranty only covers defects in materials and workmanship. This warranty does not cover, for example: cosmetic damage, normal wear and tear, improper operation, improper voltage supply or power surges, signal issues, damages from shipping, acts of God, any type of customer misuse, modifications or adjustments, as well as installation and set-up issues or any repairs attempted by anyone

other than by a VIZIO authorized service center. Products with unreadable or removed serial numbers, or requiring routine maintenance are not covered. This one year limited warranty does not cover Products sold "AS IS", "FACTORY RECERTIFIED", or by a non-authorized reseller.

THERE ARE NO EXPRESS WARRANTIES OTHER THAN THOSE LISTED OR DESCRIBED ABOVE. ANY IMPLIED WARRANTIES, INCLUDING ANY IMPLIED WARRANTY OF MERCHANTABILITY AND FITNESS FOR A PARTICULAR PURPOSE, SHALL BE LIMITED IN DURATION TO THE PERIOD OF TIME SET FORTH ABOVE. VIZIO'S TOTAL LIABILITY FOR ANY AND ALL LOSSES AND DAMAGES RESULTING FROM ANY CAUSE WHATSOEVER INCLUDING VIZIO'S NEGLIGENCE, ALLEGED DAMAGE, OR DEFECTIVE GOODS, WHETHER SUCH DEFECTS ARE DISCOVERABLE OR LATENT, SHALL IN NO EVENT EXCEED THE PURCHASE PRICE OF THE PRODUCT. VIZIO SHALL NOT BE RESPONSIBLE FOR LOSS OF USE, LOSS OF INFORMATION OR DATA, COMMERCIAL LOSS, LOST REVENUE OR LOST PROFITS, OR OTHER INCIDENTAL OR CONSEQUENTIAL DAMAGES. SOME STATES DO NOT ALLOW LIMITATIONS ON HOW LONG AN IMPLIED WARRANTY LASTS OR THE EXCLUSION OF INCIDENTAL OR CONSEQUENTIAL DAMAGES, SO THE ABOVE LIMITATIONS OR EXCLUSIONS MAY NOT APPLY TO YOU. THIS WARRANTY GIVES YOU SPECIFIC LEGAL RIGHTS, AND YOU MAY ALSO HAVE OTHER RIGHTS, WHICH VARY FROM STATE TO STATE. THIS WARRANTY IS SUBJECT TO CHANGE WITHOUT NOTICE.

CHECK WWW.VIZIO.COM FOR THE MOST CURRENT VERSION.

Personal Data

If your VIZIO product is capable of storing personal data and other information, ALL CONTENTS AND INFORMATION WILL BE DELETED IN THE COURSE OF SOME IN-HOME AND ALL SHIP-IN WARRANTY SERVICE. If this occurs, your product will be restored to you configured as originally purchased. You will be responsible for restoring all applicable data and passwords. Recovery and reinstallation of user data is not covered under this Limited Warranty. In order to protect your personal information, VIZIO recommends that you always clear all personal information from the unit before it is serviced, regardless of the servicer.

Zero Bright Pixel Defect Guarantee

This policy covers "zero bright pixel" defects for the duration of the limited "ONE YEAR WARRANTY" on select new product purchases. To determine if this guarantee applies to your product, refer to the "DETAILS" tab of the model's product information page (www.VIZIO.com) or look for the "zero bright pixel" guarantee on the box.

FCC Class B Radio Interference Statement

NOTE: This equipment has been tested and found to comply with the limits for a Class B digital device, pursuant to Part 15 of the FCC Rules. These limits are designed to provide reasonable protection against harmful interference in a residential installation. This equipment generates, uses and can radiate radio frequency energy, and if not installed and used in accordance with the instructions, may cause harmful interference to radio communications. However, there is no guarantee that interference will not occur in a particular installation. If this equipment does cause harmful interference to radio or television reception, which can be determined by turning the equipment off and on, the user is encouraged to try to correct the interference by one or more of the following measures:

1. Reorient or relocate the receiving antenna.
2. Increase the separation between the equipment and receiver.
3. Connect the equipment into an outlet on a circuit different from that to which the receiver is connected.
4. Consult the dealer or an experienced radio/TV technician for help.

This device complies with Part 15 of the FCC Rules. Operation is subject to the following two conditions: (1) this device may not cause harmful interference, and (2) this device must accept any interference received, including interference that may cause undesired operation.

Notice

1. The changes or modifications not expressly approved by the party responsible for compliance could void the user's authority to operate the equipment.
2. Shielded interface cables and AC power cord, if any, must be used in order to comply with the emission limits.
3. The manufacturer is not responsible for any radio or TV interference caused by unauthorized modification to this equipment. It is the responsibilities of the user to correct such interference.

FCC warning

Changes or modifications not expressly approved by the party responsible for compliance with the FCC Rules could void the user's authority to operate this equipment.

Other

Image(s) used under license from Shutterstock.com

Free Manuals Download Website

<http://myh66.com>

<http://usermanuals.us>

<http://www.somanuals.com>

<http://www.4manuals.cc>

<http://www.manual-lib.com>

<http://www.404manual.com>

<http://www.luxmanual.com>

<http://aubethermostatmanual.com>

Golf course search by state

<http://golfingnear.com>

Email search by domain

<http://emailbydomain.com>

Auto manuals search

<http://auto.somanuals.com>

TV manuals search

<http://tv.somanuals.com>