

DESIGNER SERIES
BUILT-IN ELECTRIC OVENS WARRANTY

ONE YEAR FULL WARRANTY

Built-in electric ovens and all of their component parts and accessories, except as detailed below*, are warranted to be free from defective materials or workmanship in normal household use for a period of twelve (12) months from the date of original retail purchase. Viking Range Corporation, warrantor, agrees to repair or replace, at its option, any part which fails or is found to be defective during the warranty period.

*Glass (including light bulbs), painted and decorative items are warranted to be free from defective materials or workmanship for a period of ninety (90) days from the date of original retail purchase. ANY DEFECTS MUST BE REPORTED TO THE SELLING DEALER WITHIN NINETY (90) DAYS FROM DATE OF ORIGINAL RETAIL PURCHASE.

Viking Range Corporation uses the most up-to-date processes and best materials available to produce all color finishes. However, slight color variation may be noticed because of the inherent differences in painted parts and porcelain parts as well as differences in kitchen lighting, product locations, and other factors.

FIVE YEAR LIMITED WARRANTY

Any bake element, broil element, or convection cook element which fails due to defective materials or workmanship in normal household use during the second through fifth year from the date of original retail purchase will be repaired or replaced, free of charge for the part itself, with the owner paying all other costs, including labor.

TEN YEAR LIMITED WARRANTY

Any porcelain oven or porcelain inner door panel which rusts through due to defective materials or workmanship in normal household use during the second through the tenth year from the date of original retail purchase will be repaired or replaced, free of charge for the part itself, with the owner paying all other costs, including labor.

This warranty extends to the original purchaser of the product warranted hereunder and to each transferee owner of the product during the term of the warranty.

This warranty shall apply to products purchased and located in the United States and Canada. Products must be purchased in the country where service is requested. Warranty labor shall be performed by an authorized Viking Range Corporation service agency or representative. Warranty shall not apply to damage resulting from abuse, accident, natural disaster, loss of electrical power to the product for any reason, alteration, outdoor use, improper installation, improper operation, or repair or service of the product by anyone other than an authorized Viking Range Corporation service agency or representative. This warranty does not apply to commercial usage. Warrantor is not responsible for consequential or incidental damage whether arising out of breach of warranty, breach of contract, or otherwise. Some jurisdictions do not allow the exclusion or limitation of incidental or consequential damages, so the above limitation or exclusion may not apply to you.

Owner shall be responsible for proper installation, providing normal care and maintenance, providing proof of purchase upon request, and making the appliance reasonably accessible for service. If the product or one of its component parts contains a defect or malfunction during the warranty period, after a reasonable number of attempts by the warrantor to remedy the defects or malfunctions, the owner is entitled to either a refund or replacement of the product or its component part or parts. Warrantor's liability on any claim of any kind, with respect to the goods or services covered hereunder, shall in no case exceed the price of the goods or service or part thereof which gives rise to the claim.

WARRANTY SERVICE: Under the terms of this warranty, service must be performed by a factory authorized Viking Range Corporation service agent or representative. Service will be provided during normal business hours, and labor performed at overtime or premium rates shall not be covered by this warranty. To obtain warranty service, contact the dealer from whom the product was purchased, an authorized Viking Range Corporation service agent, or Viking Range Corporation. Provide model and serial number and date of original purchase. For the name of your nearest authorized Viking Range Corporation service agency, call the dealer from whom the product was purchased or Viking Range Corporation. **IMPORTANT:** Retain proof of original purchase to establish warranty period.

The return of the Owner Registration Card is not a condition of warranty coverage. You should, however, return the Owner Registration Card so that Viking Range Corporation can contact you should any question of safety arise which could affect you.

Any implied warranties of merchantability and fitness applicable to the above described bake element, broil element, convection cook element, porcelain oven, or porcelain inner door panel are limited in duration to the period of coverage of the applicable express written limited warranties set forth above. Some jurisdictions do not allow limitations on how long an implied warranty lasts, so the above limitation may not apply to you. This warranty gives you specific legal rights, and you may also have other rights which may vary from jurisdiction to jurisdiction.

VIKING RANGE CORPORATION
III FRONT STREET
GREENWOOD, MISSISSIPPI (MS) 38930 USA • (662) 455-1200

DESIGNER SERIES
BUILT-IN ELECTRIC WALL OVENS
Use and Care Manual

VIKING RANGE CORPORATION

Specifications subject to change without notice
For more product information, call 1-888-VIKING1 (845-4641), or visit the
Viking web site at <http://www.vikingrange.com>

F20024B

(M0703VR

CONGRATULATIONS . . .

Your purchase of this product attests to the importance you place upon the quality and performance of the major appliances you use. With minimal care, as outlined in this guide, this product is designed to provide you with years of dependable service. Please take the few minutes necessary to learn the proper and efficient use and care of this quality product.

We appreciate your choosing a Viking Range Corporation product, and hope that you will again select our products for your other major appliance needs.

Table of Contents

Warnings	2
Important Safety Instructions	3
Basic Functions of Your Oven	6
Using Your Oven	8
Electronic Timing Center (Digital Display)	8
Electronic Timing Center (Analog Clock w/Digital Display)	12
Two Element Baking/Convection Baking/Convection Cooking	18
Conventional Broiling	31
Convection Broiling	31
Convection Dehydrate	34
Convection Defrost	34
Cleaning and Maintenance	34
Self-Clean Cycle	36
Replacing Interior Lights	37
Power Failure	38
Service Information	39
Warranty	Rear Cover

WARNING

If the information in this manual is not followed exactly, a fire or explosion may result causing property damage, personal injury or death.

IMPORTANT SAFETY INSTRUCTIONS

Read before operating your oven

1. Use this appliance only for its intended use as described in this manual. Never use your appliance for warming or heating the room. This is based on safety considerations.
2. Your unit should be installed by a qualified technician. The appliance must be installed and electrically grounded according to local codes.
3. Do not attempt to repair or replace any part of this appliance unless specifically recommended in this manual. All servicing should be referred to a qualified technician. Warranty service must be performed by an authorized service agency.
4. Children should not be left alone in the kitchen while the oven is in use. CAUTION: Do not store items of interest to children over the unit. Children climbing to reach items could be seriously injured.
5. GREASE - Grease is flammable and should be handled carefully. Do not use water on grease fires. Flaming grease outside of utensil can be extinguished with baking soda or, if available, a multipurpose dry chemical or foam type extinguisher. Let fat cool before attempting to handle it. Do not allow grease to collect around the oven or in vents. Wipe up spillovers immediately.
6. Loose-fitting or hanging garments should never be worn while using the appliance. Do not drape towels or materials on oven door handles. These items could ignite and cause burns.
7. Use only dry potholders. Moist or damp pot holders on hot surfaces may result in burns from steam. Do not let pot holder touch hot surface areas. Do not use a towel or other bulky cloth.
8. Keep area clean and free from combustible material, gasoline, and other flammable liquids. Never use your oven as a storage space. Combustible items (paper, plastic, etc.) may ignite and metallic items may become hot and cause burns.

9. Do not heat unopened food containers; buildup of pressure may cause the container to explode and result in injury.
10. Always position oven racks in desired location while oven is cool. If rack must be moved while oven is hot, do not let potholder contact hot heating element in oven.
11. Use care when opening oven door. Let hot air or steam escape before removing or replacing food. Hot air or steam can cause burns to hands, face and/or eyes.
12. Keep oven vents unobstructed. The oven vent is located at the front of the oven and vents into the room.
13. Do not clean door gasket. It is essential for a good tight seal. Care should be taken not to rub, damage, or move the gasket.
14. No commercial oven cleaner or oven liner protective coating such as aluminum foil should be used in or around any part of the oven. Improper oven liners may result in a risk of electric shock or fire. Keep oven free from grease buildup.
15. Before self-cleaning the oven, remove broiler pan, broiler grid, oven racks, rack supports, and other utensils. Do not use your oven to clean other parts. A fan noise should be heard during the cleaning cycle. If not, call service before self-cleaning again.
16. **DO NOT TOUCH HEATING ELEMENTS OR INTERIOR SURFACES OF OVEN.** Heating elements may be hot even though they are dark in color. Interior surfaces of an oven become hot enough to cause burns. During and after use, do not touch, or let clothing or other flammable materials contact heating elements or interior surfaces of oven until they have had sufficient time to cool. Other surfaces of the oven may become hot enough to cause burns, such as the oven vent opening, the surface near the vent opening, and the oven door window.

BUILT-IN ELECTRIC OVEN FEATURES

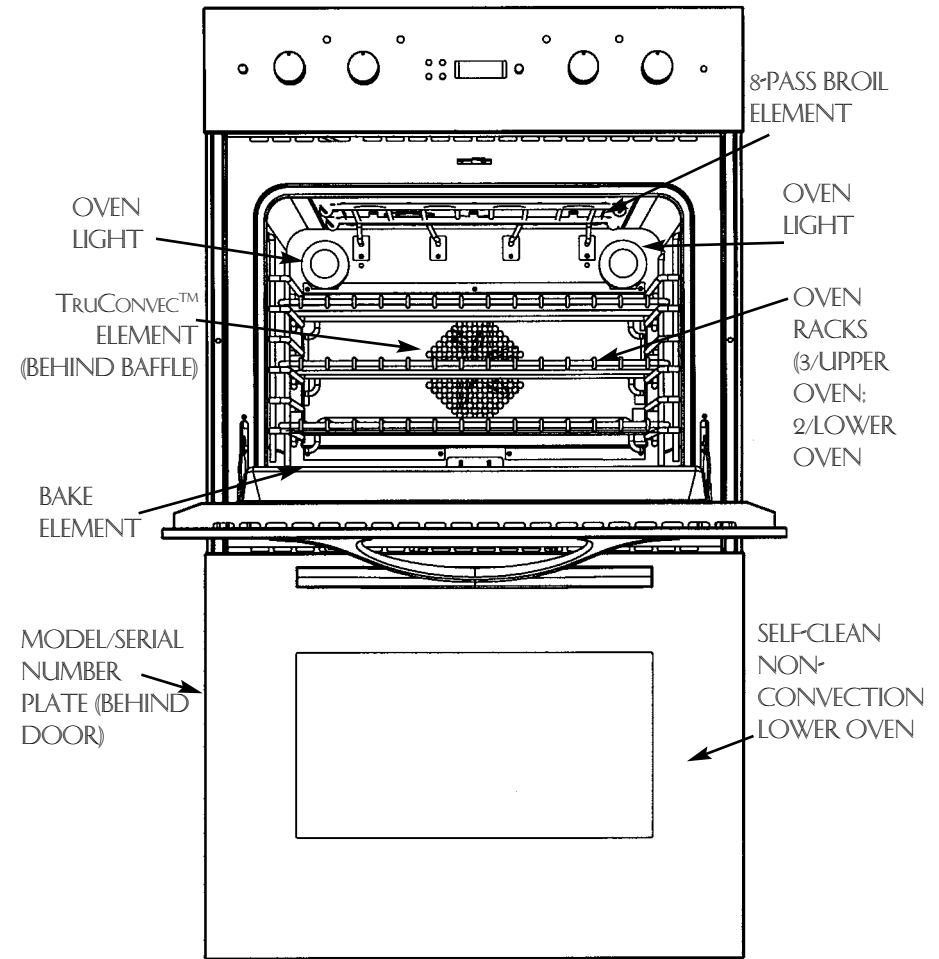

-SAVE THESE INSTRUCTIONS-

BASIC FUNCTIONS OF YOUR OVEN

Two-Element Bake

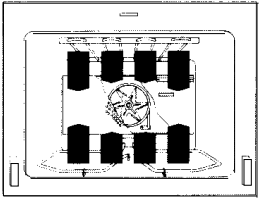

Full power heat is radiated from the bake element in the bottom of the oven cavity, and supplemental heat is radiated from the broil element. This function is recommended for single rack baking and roasting.

Convection Bake (upper oven only)

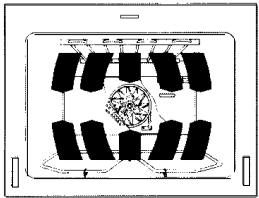

Exactly the same as regular baking with the additional benefit of air circulation. The heated air is circulated by the motorized fan in the rear of the oven. It provides more even heat distribution throughout the oven cavity for all uses. Multiple rack use is possible for the largest baking jobs. When roasting, cool air is quickly replaced-searing meats on the outside and retaining more juices and natural flavor on the inside with less shrinkage.

TruConvect™ (upper oven only)

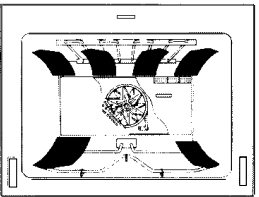

The rear element only operates at full power. There is no direct heat from the bottom or top elements. Air in the oven cavity is circulated by the fan for even heating. Use this setting for foods which require gentle cooking such as pastries, souffles, yeast breads, quick breads and cakes. Use this function for single rack baking, multiple rack baking, roasting, and preparation of complete meals.

Broil

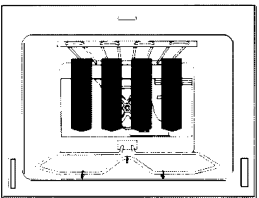

In Maxi-Broil heat is radiated from both broil elements, located in the top of the oven cavity, at full power. Broiling speed is determined by the distance between the foods and the broil elements. For "fast" broiling, food may be as close as 2 inches to the broil element or on the top rack. "Fast" broiling is best for meats where "rare to medium" doneness is desired. The Mini-Broil setting is designed for "slow" broiling. Only the center broil element operates for partial power.

Convection Broil (upper oven only)

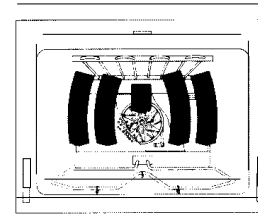

For "slow" broiling, allow about 4 inches between the top surface of the food and the broil element. "Slow" broiling is best for chicken and ham in order to broil food without over-browning it.

Convection Dehydrate (upper oven only)

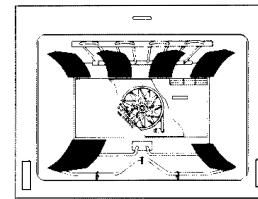

Exactly the same as regular broiling with additional benefit of air circulation by the motorized fan in the rear of the oven. The cool air is quickly replaced-improving the already high performance of the broil element. Especially useful for broiling thick cuts of meat.

With the selector set to convection cook and the temperature control on 150 F, warm air is circulated by a motorized fan in the rear of the oven. Over a period of time, the water is removed from the food by evaporation. Removal of water inhibits growth of microorganisms and retards the activity of enzymes. It is important to remember that dehydration does not improve the quality, so only fresh, top-quality foods should be used.

Convection Defrost (upper oven only)

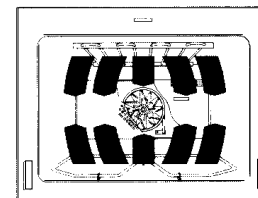

With the selector set to convection cook and the temperature control off, air is circulated by a motorized fan in the rear of the oven. The fan accelerates natural defrosting of the food without heat. To avoid sickness and food waste, do not allow defrosted food to remain in the oven for more than two hours.

Self-Clean

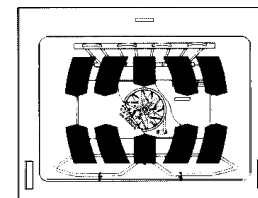

This oven features a pyrolytic self-cleaning cycle. During this cycle, the oven reaches elevated temperatures in order to burn off soils and deposits. An integral smoke eliminator reduces odors associated with the soil burn-off. A powder ash residue is left in the bottom of the oven after completion of the self-clean cycle. When the oven has cooled, remove any ash from oven surfaces with a damp sponge or cloth.

USING YOUR OVEN

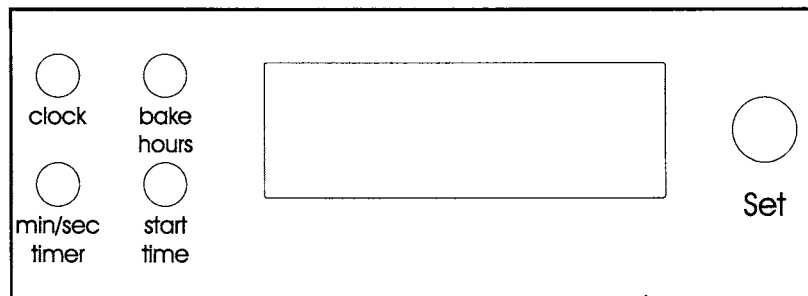

Electronic Timing Center (Digital Display)

The Electronic Timing Center is used to program and control all timing functions. Depending on the model, your unit will have a digital display or an analog clock with digital display. If your unit has an analog clock, refer to pages 13-16.

It has five display and programming modes that are activated by the four push buttons and the Set Knob. Both the Bake Hours mode and the MIN/SEC Timer mode can be used to time cooking periods. These features can even be used at the same time when both ovens are in use. However, only Bake Hours and Self-Cleaning modes shut the oven off automatically when the timed program is over. For example, you can time bake a casserole in the upper oven using the Bake Hours mode, while broiling in the lower oven using the MIN/SEC Timer. One oven can also be cleaned while timing foods in the other oven using the MIN/SEC Timer.

SETTING THE TIME-OF-DAY

The time-of-day must be set before any other program can be used. When your oven is first connected to the power in your home, the timer display will show --:--. To program the time-of-day:

1. Press the CLOCK button. 12:00 will be displayed with the word set in the upper right corner.
2. Turn the Set Knob until the correct time-of-day is displayed. AM and PM are not indicated.
3. Press the CLOCK button again. The word set will disappear and the correct time is now set into the timer.

The time-of-day can be changed by following steps 1 through 3. It cannot be changed while there is a Bake Hours or Start Time cycle programmed into the timer.

SETTING THE MIN/SEC TIMER

The MIN/SEC Timer is designed for accurate timing and is ideal for baking delicate items such as biscuits, cookies, and popovers, and for precise broiling. The MIN/SEC timer can be used at the same time the Bake Hours or Start Time functions are in use. It can be used for timing up to 24 hours. When setting the Timer, the time displayed will increase in 1 minute increments. When the Timer counts down to 1 minute, the timer alarm will give two short beeps and the display changes from hours:minutes to seconds only.

TO PROGRAM THE MIN/SEC TIMER

1. Press the MIN/SEC Timer button. The timer will display :00 and the word timer will be displayed in the lower right corner.
2. Turn the Set Knob until the desired duration time is displayed.

The Timer is now programmed. The alarm will sound at the end of the countdown. The program can be canceled anytime by setting the remaining time to :00. To change back to the time-of-day, press the CLOCK button. Notice that a small clock will be displayed in the upper right corner to indicate that a program is in progress. The display will return automatically to the MIN/SEC Timer after a few seconds.

TIMER ALARM

At the end of a MIN/SEC Timer program or Bake Hours program, the alarm will consist of three beeps followed by two beeps every 10 seconds until the MIN/SEC Timer button is pressed. Whenever a valid function key is pressed or when a control function starts automatically, one beep will be sounded. When an invalid function key is pressed, two beeps will be sounded.

SETTING THE BAKE HOURS PROGRAM

The Bake Hours program is used for controlled timing of baked or roasted foods. At the end of the timed cycle, the oven automatically turns off. Times in the Bake Hours mode are displayed in hours and minutes, with a setting from 1 minute to 11 hours 50 minutes, increasing in 1 minute increments.

TO SET THE BAKE HOURS PROGRAM

1. Turn the MANUAL/TIMED knob to TIMED, UPPER TIMED OR LOWER TIMED position, depending upon the oven mode and oven being used.
2. Set the Oven Function Selector to the BAKE, CONVECTION BAKE, or TruConvec™ position, depending upon the type of baking being used.
3. Set the temperature Control knob to the desired temperature and allow for preheating.
4. Press the Bake Hours button. The Timer will display :00 with the words set and cook in the upper right corner.
5. Turn the Set Knob until the desired baking time is displayed in hours and minutes. The word cook will remain in the display indicating that the Bake Hours program has been set.

The Timer will automatically compute a stop time and enter it into the timer memory. The alarm will sound three beeps followed by two beeps every 10 seconds until the Bake Hours button is pressed. The duration time can be changed anytime during the cooking program by following steps 4 and 5. Setting the remaining duration time to :00 cancels the Bake Hours program. To return the Timer to the present time-of-day, press the CLOCK button. A small clock will appear in the upper right corner indicating a Bake Hours program has been set. The Timer will go back to the Bake Hours automatically after a few seconds.

SETTING THE AUTOMATIC START TIME BAKE PROGRAM

The Bake Hours and Start Time modes of the Timer can be used to automatically turn the oven on and off at a preselected time. The Automatic Time Bake Program is ideal for foods with no danger of spoilage during the time the oven is left off.

TO SET THE AUTOMATIC TIME BAKE PROGRAM

1. Turn the MANUAL/TIMED knob to TIMED, UPPER TIMED OR LOWER TIMED position, depending upon the oven mode and oven being used.
2. Set the Oven Function Selector to the BAKE, CONVECTION BAKE, or TruConvec™ position, depending upon the type of baking being used.
3. Program the Start Time by pressing the Start Time button and turning the Set Knob until the desired Start Time is displayed. This is the time-of-day you want the food to begin cooking.
4. Program the required baking time by pressing the Bake Hours button. The words set and cook in the upper right corner. Turn the Set Knob until the desired baking time is displayed in hours and minutes. The word set will disappear and the word delay will remain in the display indicating that the Bake Hours program has been set.
5. Set the Temperature Control Knob to the desired temperature.

When the specified start time is reached, the oven will automatically turn on. The oven then bakes for the length of time programmed into the Bake Hours mode, turn the oven off, and sounds the alarm. Setting the remaining duration time to :00 cancels the automatic bake program.

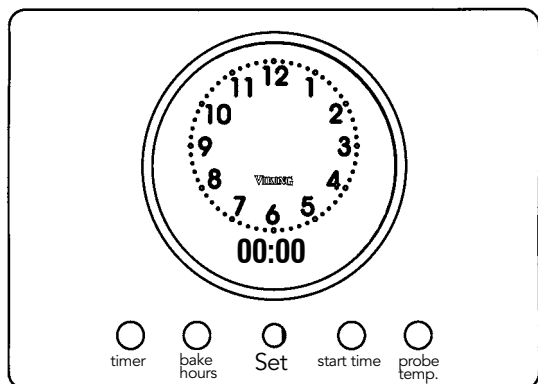

Electronic Timing Center (Analog Clock w/Digital Display)

SYNCHRONIZING THE ANALOG AND DIGITAL CLOCKS

Synchronizing the analog and digital clocks

1. Press the "timer" and "start time" buttons simultaneously.
2. Turn the set knob to move the hands on the analog clock to any time setting.
3. After five seconds the display will go blank. Press the timer button and using the set knob, set the digital time to the exact time on the analog clock.

This will synchronize the two clocks. You can now set the time of day.

SETTING THE TIME-OF-DAY

The time-of-day must be set before any other program can be used. When your oven is first connected to the power in your home, the digital display will show 00:00. To program the time-of-day:

1. Push and hold the "timer" and "bake hours" button at the same time.
2. Turn the "Set" knob until correct time is displayed on the digital clock.
3. Release "timer" and "bake hours" button

The analog clock will automatically set after the digital time is set.

SETTING THE MIN/SEC TIMER

The MIN/SEC Timer is designed for accurate timing and is ideal for baking delicate items such as biscuits, cookies, and popovers, and for precise broiling. The MIN/SEC timer can be used at the same time the Bake Hours or Start Time functions are in use. It can be used for timing up to 24 hours.

TO PROGRAM THE MIN/SEC TIMER

1. Push and release the "timer" button.
2. Rotate "Set" knob until desired duration of time is displayed. Timer starts seconds after "Set" knobs stops rotating. A tone indicates the timer has started.

When the timer has one minute remaining, the timer will sound twice and begin to countdown by seconds. A tone will sound three times indicating the time is complete and twice every ten seconds after completion until timer function is cleared.

NOTE: Press any function button to clear a completed cycle or function.

SETTING THE BAKE HOURS PROGRAM

The Bake Hours program is used for controlled timing of baked or roasted foods. At the end of the timed cycle, the oven automatically turns off.

TO SET THE BAKE HOURS PROGRAM

1. Turn the MANUAL/TIMED knob to TIMED, UPPER TIMED OR LOWER TIMED position, depending upon the oven mode and oven being used.
2. Set the Oven Function Selector to the BAKE, CONVECTION BAKE, or TruConvec™ position, depending upon the type of baking being used.
3. Set the temperature Control knob to the desired temperature and allow for preheating.
4. Press and release the Bake Hours button. The Timer will display :00 with the words set and cook in the upper right corner of the digital display.
5. Turn the Set Knob until the desired baking time is displayed in hours and minutes. The cook time/remaining time and "Cook" will be displayed.

"Cook" will flash and the tone will sound three times when the time is completed; oven will turn off. The tone will sound twice every ten seconds after completion until timer function is cleared.

SETTING THE AUTOMATIC START TIME BAKE PROGRAM

The "bake hours" and "start time" modes of the Timer can be used to automatically turn the oven on and off at a preselected time. The Automatic Time Bake Program is ideal for foods with no danger of spoilage during the time the oven is left off.

TO SET THE AUTOMATIC TIME BAKE PROGRAM

1. Turn the MANUAL/TIMED knob to TIMED, UPPER TIMED OR LOWER TIMED position, depending upon the oven mode and oven being used.
2. Set the Oven Function Selector to the BAKE, CONVECTION BAKE, or TruConvec™ position, depending upon the type of baking being used.
3. Press and release "start time". Turn the "Set" knob to desired start time.
4. Press and release "bake hours" button. Turn the "Set" knob until desired duration of cooking time is reached. "Delay" will be displayed in the upper left corner of the digital display during the delay cycle. Once the bake cycle begins, the cook time/remaining time and "Cook" will be displayed.

When the specified start time is reached, the oven will automatically turn on. The oven then bakes for the length of time programmed into the Bake Hours mode, turn the oven off, and sounds the alarm. "Cook" will flash and the tone will sound three times when the time is completed; oven will turn off. The tone will sound twice every ten seconds after completion until timer function is cleared.

NOTE: If the "bake hours" button is not pressed within ten seconds of setting the "start time", the user will automatically be prompted to enter the "bake hours". A tone will sound twice every five seconds until the "bake hours" is entered.

PROBE FUNCTION

The meat probe takes the guesswork out of roasting by cooking foods to the ideal internal temperature. The "probe temp." setting is used to automatically turn the oven off when the internal temperature of the meat being roasted is reached.

TO SET THE AUTOMATIC PROBE FUNCTION

1. Insert the probe into the meat and slide into oven.
2. Plug the probe into the outlet located on left interior wall of the oven and close the oven door.
3. Press and release the "probe temp." button.
4. Turn the "Set" knob to the desired internal temperature. "Probe" and the desired internal temperature will be displayed to the lower right of the analog clock. **NOTE:** It is recommended to set the internal temperature about 10 degrees lower than actual desired internal temperature. The meat will continue to cook when removed from the oven and will reach desired internal temperature while "standing".

"Probe" flashes, tone sounds three times, and oven shuts off when desired temperature is reached. The tone will sound twice every ten seconds after completion until probe function is closed.

WARNING: To avoid sickness and food waste when using automatic time baking:

- Do not use foods that will spoil while waiting for cooking to start, such as dishes with milk or eggs, cream soups, custards, fish, pork, poultry, or foods with stuffing.
- Any food that has to wait for cooking to start should be very cold or frozen before it is placed in the oven.
- Do not use foods containing baking powder or yeast when automatic time baking. They will not rise properly.
- Do not allow food to remain in the oven for more than two hours after the end of the cooking cycle.

OVEN FUNCTION SELECTOR

Each oven has a separate oven function selector. There are seven settings on each selector.

•BAKE:

The bottom element operates at full power, and the top broil element operates at supplemental power. Use this setting for baking, roasting, and casseroles.

•CONVECTION BAKE (upper oven only)

The bottom element operates at full power, and the top broil element operates at supplemental power. Air in the oven cavity is circulated by the fan for even heating. Use this setting for baking and roasting.

•TruConvec™ (upper oven only)

The rear element only operates at full power whenever heating. There is no direct heat from the top or bottom elements. Air in the oven cavity is circulated by the fan for even heating. Use this setting for foods which require gentle cooking such as pastries or soufflés, and for baking yeast breads and cakes. This setting is also recommended when baking large quantities of baked goods at one time.

•MAXI-BROIL

The top element operates at full power. Use this setting for broiling small and average cuts of meats.

•MINI-BROIL

Only the center broil element operates for partial power. This setting is designed for small amounts of food and "slow" broiling.

•CONVECTION BROIL (upper oven only)

The top element operates at full power. Air in the oven cavity is circulated by the fan for even heating. Use this setting for broiling thick cuts of meats.

•SELF-CLEAN

The self-clean cycle is designed to eliminate the need for scrubbing and scouring food baked onto the oven interior. The self-clean cycle heats these soils to a high temperature in which the baked on food is burned off.

TEMPERATURE CONTROL

Each oven has a separate temperature control dial. The controls can be set at any temperature from 150° F to 550° F. There are separate settings for broiling and self-cleaning. Always be sure the controls are in the OFF position when the ovens are not in use.

INTERIOR OVEN LIGHT CONTROL

The upper and lower ovens have interior oven lights that are controlled by separate switches on the control panel. Push the switch to turn the interior oven lights on and off.

TWO ELEMENT BAKING/ CONVECTION BAKING / CONVECTION COOKING

PREHEATING

Preheating the oven is not necessary when using temperatures below 250 F. For best results, it is extremely important that you preheat the oven when baking cakes and other items that have critical baking temperatures. After the temperature control has been set, the Oven Indicator light goes out when the oven reaches that temperature. Preheating takes no longer than 10 -15 minutes. Preheat times will be greater in those areas in which the electrical supply is less than 240 volts.

TWO ELEMENT BAKING

Conventional baking/roasting is particularly suitable for dishes which require a high temperature. Many cookbooks contain recipes to be cooked in the conventional manner. This bake setting is only recommended for single rack baking.

CONVECTION BAKING (UPPER OVEN ONLY)

Convection baking is the process of cooking food with a flow of heated air circulating throughout the oven cavity. The even circulation of this air equalizes the temperature throughout the oven cavity and eliminates the hot and cold spots found in conventional ovens. This feature can make a significant difference in foods prepared in the oven. A major benefit of convection baking is the ability to prepare food in quantity. The uniform air circulation makes this possible . . . a feature not possible in a standard oven. With this heating system, the air is distributed evenly throughout the oven by the convection fan. The heat therefore reaches the food to be baked or roasted more quickly. With this heating method, foods can be baked and roasted at the same time with minimal taste transfer, even when different dishes are involved, such as cakes, fish or meat. The hot air system is especially economical when thawing frozen food.

TruConvEC™ (UPPER OVEN ONLY)

In TruConvEC™ cooking, the rear element only operates at full power. There is no direct heat from the bottom or top elements. The heated air is circulated by the motorized fan in the rear of the oven. Breads, cookies, and other baked goods come out evenly textured with golden crusts. No special bakeware is required.

RACK POSITIONS

Each oven is equipped with three tilt-proof racks. All ovens have six rack positions. Position 6 is the farthest from the oven bottom. Position 1 is the closest to the oven bottom. The racks can be easily removed and arranged at various levels. For best results with conventional baking, do not use more than one rack at a time. It is also recommended, when using two racks, to bake with the racks on positions 2 and 4 or positions 3 and 5.

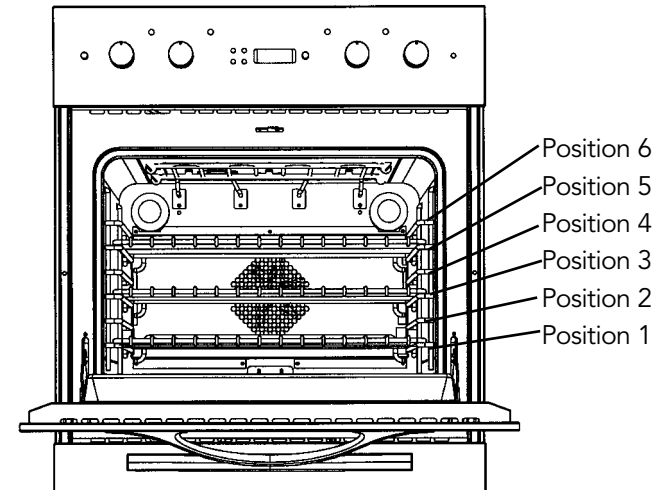

TO BAKE:

1. Arrange the oven racks in the desired positions BEFORE heating the oven. If cooking on two racks at the same time, use rack positions 2 and 4 or positions 3 and 5.
2. Turn the Oven Function selector to desired function. Cooking starts immediately and stops when the Oven Function selector is turned to OFF.
3. Set the Temperature Control to the desired temperature.
4. Place the food in the oven after the Oven Indicator light goes out.

PAN PLACEMENT TIPS

- When using large (15" x 13") flat pans or trays that cover most of the rack, rack positions 2 or 3 produce the best results.
- When baking on more than one rack, it is recommended to use one of the convection modes and the 2nd and 4th position or the 3rd and 5th position for more even baking. When baking on three racks, use any combination of positions 2,3, 4, and 5 for more consistent results.
- Stagger pans in opposite directions when two racks and several pans are used in conventional bake. If possible, no pan should be directly above another.
- Allow 1½ to 2 inches of air space around all sides of each pan for even air circulation.

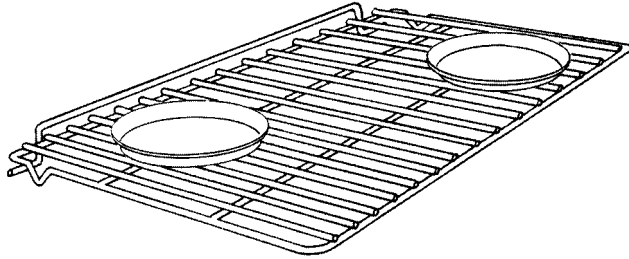

BAKING TIPS

Because of variations in food density, surface texture and consistency, some foods may be prepared more successfully using the conventional bake setting. For this reason, conventional baking is recommended when preparing baked goods such as custard. The user may find other foods that are also prepared more consistently in conventional bake. This is perfectly normal.

1. As a general rule, to convert conventional recipes to convection recipes, reduce the temperature by 25 F and the cooking time by approximately 10 to 15%.
2. Some recipes, especially those that are homemade, may require adjustment and testing when converting from standard to convection modes. If unsure how to convert a recipe, begin by preparing the recipe in conventional bake. After achieving acceptable results, follow the convection guidelines listed for the similar food type. If the food is not prepared to your satisfaction during this first convection trial, adjust only one recipe variable at a time (cooking time, rack position, or temperature) and repeat the convection test. Continue adjusting one recipe variable at a time until satisfactory results are achieved.
3. Make sure the oven racks are in the desired position before you turn the oven on.

4. Do not open the door frequently during baking. Look through the door window to check doneness whenever possible. If you must open the door, the best time is during the last quarter of the baking time.
5. Bake to the shortest time suggested and check for doneness before adding more time. For baked goods, a stainless steel knife placed in the center of the product should come clean when done.
6. Use the pan size and type recommended by the recipe to ensure best results. Cakes, quick breads, muffins, and cookies should be baked in shiny, reflective pans for light, golden crusts. Avoid the use of old, darkened pans. Warped, dented, stainless steel and tin-coated pans heat unevenly and will not give uniform baking results.

MULTIPLE RACK BAKING

A major benefit of convection cooking is the ability to prepare foods in quantity. The uniform air circulation makes this possible. Foods that can be prepared on two or three racks at the same time include: pizza, cakes, cookies, biscuits, muffins, rolls, and frozen convenience foods.

For 3 rack baking, use any combination of rack positions 2, 3, 4, and 5. Remember that the racks are numbered from bottom to top. For 2 rack baking, use rack positions 2 and 4 or positions 3 and 5.

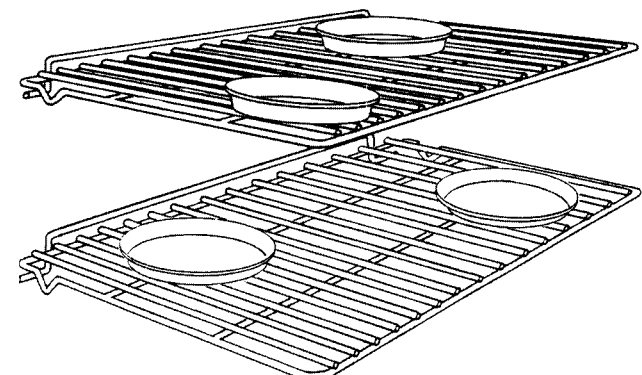

CONVENTIONAL BAKING CHART

FOOD	PAN SIZE	SINGLE RACK POS.	TEMP(°F)	TIME (MIN)
BREADS				
Biscuits	Cookie Sheet	3 or 4	400	8 - 10
Yeast Loaf	Loaf Pan	3 or 4	375	30 - 35
Yeast Rolls	Cookie Sheet	3 or 4	400	12 - 15
Nut Bread	Loaf Pan	3 or 4	375	30 - 35
Cornbread	8" x 8"	3 or 4	400	20 - 25
Gingerbread	8" x 8"	3 or 4	350	35 - 40
Muffins	Muffin Tin	3 or 4	375	15 - 20
Corn Muffins	Muffin Tin	3 or 4	375	15 - 20
CAKES				
Angel food	Tube pan	3 or 4	375	35 - 45
Bundt	Tube pan	3 or 4	350	45 - 55
Cupcakes	Muffin pan	3 or 4	350	16 - 20
Layer, Sheet	13" x 9"	3 or 4	350	40 - 50
Layer, Two	9" round	3 or 4	350	30 - 35
Pound	Loaf pan	3 or 4	350	60 - 65
COOKIES				
Brownies	13" x 9"	3 or 4	350	25 - 30
Choc. Chip	Cookie Sheet	3 or 4	375	12 - 15
Sugar	Cookie Sheet	3 or 4	350	10 - 12
PASTRY				
Cream Puffs	Cookie Sheet	3 or 4	400	30 - 35
PIES				
Crust, Unfilled	9" Round	3 or 4	425	10 - 12
Crust, Filled	9" Round	3 or 4	375	55 - 60
Lemon Meringue	9" Round	3 or 4	350	12 - 15
Pumpkin	9" Round	3 or 4	350	40 - 45
Custard	6 - 4oz cups	3 or 4	350	35 - 40

CONVECTION BAKING CHART

FOOD	PAN SIZE	MULTI-RACK POS.	TEMP(°F)	TIME (MIN)
BREADS				
Biscuits	Cookie Sheet	2 & 4	375	7 - 9
Yeast Loaf	Loaf Pan	2 & 4	350	20 - 25
Yeast Rolls	Cookie Sheet	2 & 4	375	11 - 13
Nut Bread	Loaf Pan	2 & 4	350	20 - 25
Cornbread	8" x 8"	2 & 4	375	15 - 20
Gingerbread	8" x 8"	2 & 4	325	30 - 35
Muffins	Muffin Tin	2 & 4	350	12 - 15
Corn Muffins	Muffin Tin	2 & 4	350	10 - 12
CAKES				
Angel food	Tube pan	3 or 4	325	30 - 35
Bundt	Tube pan	3 or 4	325	35 - 40
Cupcakes	Muffin pan	2 & 4	325	15 - 17
Layer, Sheet	13" x 9"	2 & 4	325	30 - 32
Layer, Two	9" round	2 & 4	325	25 - 30
Pound	Loaf pan	2 & 4	325	45 - 50
COOKIES				
Brownies	13" x 9"	2 & 4	325	20 - 25
Choc. Chip	Cookie Sheet	2,3,& 4	350	7 - 10
Sugar	Cookie Sheet	2,3,& 4	325	9 - 10
PASTRY				
Cream Puffs	Cookie Sheet	2 & 4	375	24 - 27
PIES				
Crust, Unfilled	9" Round	2 & 4	400	7 - 9
Crust, Filled	9" Round	2 & 4	350	50 - 55
Lemon Meringue	9" Round	2 & 4	325	4 - 5
Pumpkin	9" Round	2 & 4	325	35 - 45
Custard	6 - 4oz cups	2 & 4	325	30 - 35

CONVENTIONAL BAKING CHART

FOOD	PAN SIZE	SINGLE RACK POS.	TEMP(°F)	TIME (MIN)
ENTREES				
Egg Rolls	Cookie Sheet	3 or 4	400	12 - 15
Fish Sticks	Cookie Sheet	3 or 4	425	18 - 21
Lasagna, frz	Cookie Sheet	3 or 4	375	65 - 70
Pot Pie	Cookie Sheet	3 or 4	400	35 - 40
Gr. Peppers Stuffed	13" x 9"	3 or 4	375	65 - 70
Quiche 9"	Round	3 or 4	400	25 - 30
Pizza, 12"	Cookie Sheet	3 or 4	400	15 - 20
VEGETABLES				
Macaroni & Cheese, frz	Cookie Sheet	3 or 4	375	60 - 65
Baked Potatoes	On Rack	3 or 4	375	60 - 65
Spinach Souffle	1 qt. Casserole	3 or 4	350	45 - 50
Squash	Cookie Sheet	3 or 4	375	50 - 55
French Fries	Cookie Sheet	3 or 4	425	15 - 20

CONVECTION BAKING CHART

FOOD	PAN SIZE	SINGLE RACK POS.	TEMP(°F)	TIME (MIN)
ENTREES				
Egg Rolls	Cookie Sheet	2 & 4	375	8 - 10
Fish Sticks	Cookie Sheet	2 & 4	400	13 - 16
Lasagna, frz	Cookie Sheet	2 & 4	350	60 - 65
Pot Pie	Cookie Sheet	2 & 4	375	10 - 12
Gr. Peppers Stuffed	13" x 9"	2 & 4	350	45 - 50
Quiche 9"	Round	2 & 4	375	20 - 25
Pizza, 12"	Cookie Sheet	2 & 4	375	10 - 12
VEGETABLES				
Macaroni & Cheese, frz	Cookie Sheet	2 & 4	350	45 - 50
Baked Potatoes	On Rack	2 & 4	350	45 - 50
Spinach Souffle	1 qt. Casserole	2 & 4	325	35 - 40
Squash	Cookie Sheet	2 & 4	350	40 - 45
French Fries	Cookie Sheet	2 & 4	400	10 - 15

SOLVING BAKING PROBLEMS

Baking problems can occur for many reasons. Check the Baking Problem chart for the causes and recommended remedies for the most common problems. It is important to remember that the temperature setting and cooking times you are accustomed to using with your previous oven may vary slightly from those required with this oven. If you find this to be true, it is necessary for you to adjust your recipes and cooking times accordingly.

COMMON BAKING PROBLEM / REMEDIES		
<u>PROBLEM</u>	<u>CAUSE</u>	<u>REMEDY</u>
Cakes burn on the sides or not done in center	1. Oven was too hot 2. Wrong pan size 3. Too many pans	1. Reduce temperature 2. Use recom. pan size 3. Reduce no. of pans
Cakes crack on top	1. Batter too thick 2. Oven too hot 3. Wrong pan size	1. Follow recipe Add liquid 2. Reduce temperature 3. Use recom. pan size
Cakes are not level	1. Batter uneven 2. Oven or rack not level 3. Pan was warped	1. Distribute batter even 2. Level oven or rack 3. Use proper pan
Food too brown on bottom	1. Oven door opened too often. 2. Dark pans being used 3. Incorrect rack pos. 4. Wrong bake setting 5. Pan too large	1. Use door window to check food. 2. Use shiny pans. 3. Use recom. rack pos. 4. Adjust to conventional or convection setting as needed. 5. Use proper pan
Food too brown on top	1. Rack position too high 2. Oven not preheated 3. Sides of pan too high	1. Use recom. rack pos. 2. Allow oven to preheat 3. Use proper pans
Cookies too flat	1. Hot cookie sheet	1. Allow sheet to cool between batches
Pies burn around edges	1. Oven too hot 2. Too many pans used 3. Oven not preheated	1. Reduce temperature 2. Reduce no. of pans 3. Allow oven to preheat
Pies too light on top	1. Oven not hot enough 2. Too many pans used 3. Oven not preheated	1. Increase temperature 2. Reduce no. of pans 3. Allow oven to preheat

CONVENTIONAL / CONVECTION ROASTING TIPS

Always use the broiler pan and grid supplied with each oven. The hot air must be allowed to circulate around the item being roasted. Do not cover what is being roasted. Convection roasting seals in juices quickly for a moist, tender product. Poultry will have a light, crispy skin and meats will be browned, not dry or burned. Cook meats and poultry directly from the refrigerator. There is no need for meat or poultry to stand at room temperature.

1. As a general rule, to convert conventional recipes to convection recipes, reduce the temperature by 25 F and the cooking time by approximately 10 to 15%.
2. Always roast meats fat side up in a shallow pan using a roasting rack. No basting is required when the fat side is up. Do not add water to the pan as this will cause a steamed effect. Roasting is a dry heat process.
3. Poultry should be placed breast side up on a rack in a shallow pan. Brush poultry with melted butter, margarine, or oil before and during roasting.
4. For convection roasting, do not use pans with tall sides as this will interfere with the circulation of heated air over the food.
5. When using a meat thermometer, insert the probe halfway into the center of the thickest portion of the meat. (For poultry insert the thermometer probe between the body and leg into the thickest part of the inner thigh.) The tip of the probe should not touch bone, fat, or gristle to ensure an accurate reading. Check the meat temperature halfway through the recommended roasting time. After reading the thermometer once, insert it ½ inch further into the meat, then take a second reading. If the second temperature registers below the first, continue cooking the meat.
6. Roasting times always vary according to the size, shape and quality of meats and poultry. Less tender cuts of meat are best prepared in the conventional bake setting and may require moist cooking techniques. Remove roasted meats from the oven when the thermometer registers 5 to 10 F lower than the desired doneness. The meat will continue to cook after removal from the oven. Allow roasts to stand 15 to 20 minutes after roasting in order to make carving easier.
7. If using a cooking bag, foil tent, or other cover, use the conventional bake setting rather than either convection setting.

USING THE MEAT PROBE (ANALOG CLOCK MODEL)

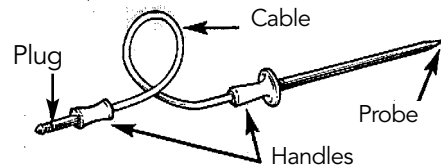

For many foods, especially roasts and poultry, internal food temperature is the best test for doneness. The meat probe takes the guesswork out of roasting by cooking foods to the exact doneness you want. **NOTE:** Double oven models have a probe in the upper oven only. Double oven models have a probe in the upper oven only.

Use of probes other than the one provided with this product may result in damage to the probe. Use the handles of the probe and plug when inserting and removing them from the meat and outlet.

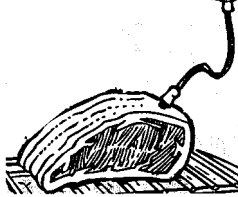

- To avoid damaging your probe, do not use tongs to pull on the cable when removing.
- To avoid breaking the probe, make sure food is completely defrosted before inserting.
- To prevent possible burns, do not unplug the probe from the outlet until the oven has cooled.
- Never leave the probe inside the oven during a self-cleaning cycle.
- Do not store the probe in the oven.

After preparing the meat and placing on broiler pan, follow these steps for proper probe placement.

1. Lay the probe on the outside of the meat along the top or side and mark with your finger where the edge of the meat comes to on the probe. The point should rest in the center of the thickest meaty part of the roast. 
2. Insert the probe completely into the meat. It should not touch the bone fat or gristle. For roasts with no bone, insert the probe into the meatiest part of the roast. For bone-in ham or lamb, insert the probe into the center of the lowest large muscle or joint. Insert the probe into the meatiest part of the inner thigh from below and parallel to the leg of a whole turkey. 
3. When setting the probe temperature, it is recommended to set the temperature about 10 degrees lower than desired internal temperature. The meat will continue to cook when removed from the oven and will reach the desired while "standing".

CONVENTIONAL ROASTING CHART

FOOD	PAN SIZE	OVEN TEMP(°F)	TIME (min/lb)	INTERNAL TEMP(°F)
BEEF				
Rib Roast	4 - 6	325		
•Rare			25	140
•Medium			30	155
•Well done			40	170
Rump Roast	4 - 6	325		
•Medium			25	155
•Well done			30	170
Tip Roast	3 - 4	325		
•Medium			35	155
•Well done			40	170
LAMB				
Lamb Leg	3 - 5	325	30	180
PORK				
Pork Loin	3 - 5	325	35	180
Pork Chops 1" thick	1 - 1¼	350	55 - 60 Total Time	N/A
Ham, fully Cooked	5	325	18	130
POULTRY				
Chicken, Whole	3-4	375	30	180
Turkey, Unstuffed	12 - 16	325	16 - 20	180
Turkey, Stuffed	20 - 24	325	16 - 20	180
Turkey, Stuffed	12 - 16	325	17 - 21	180
Turkey, Stuffed	20 - 24	325	17 - 21	180
Turkey Breast	4 - 6	325	20	180

CONVECTION ROASTING CHART

FOOD	PAN SIZE	OVEN TEMP(°F)	TIME (min/lb)	INTERNAL TEMP(°F)
BEEF				
Rib Roast	4 - 6	325		
•Rare			20	140
•Medium			24	155
•Well done			30	170
Rump Roast	4 - 6	325		
•Medium			20	155
•Well done			24	170
Tip Roast	3 - 4	325		
•Medium			30	155
•Well done			35	170
LAMB				
Lamb Leg	3 - 5	325	30	180
PORK				
Pork Loin	3 - 5	325	30	180
Pork Chops 1" thick	1 - 1¼	325	45 - 50 Total Time	N/A
Ham, fully Cooked		325	15	130
POULTRY				
Chicken, Whole	3-4	350	25	180
Turkey, Unstuffed	12 - 16	325	11	180
Turkey, Unstuffed	20 - 24	325	11	180
Turkey, Stuffed	12 - 16	325	9 - 10	180
Turkey, Stuffed	20 - 24	325	9 - 10	180
Turkey Breast	4 - 6	325	20	

CONVENTIONAL BROILING

Broiling is a dry-heat cooking method using direct or radiant heat. It is used for small individualized cuts such as steaks, chops, and patties. Broiling is most successful for cuts of meat 1-2 inches thick. Conventional broiling is also more suitable for flat pieces of meat. Your oven contains a top broil element to provide additional flexibility for broiling foods such as "stuffed lobster" and for top browning casseroles, meringues, etc. Broiling speed is determined by the distance between the food and the broil element. On regular conventional broiling, heat is radiated from both broil elements at full power. For "fast" broiling, food may be as close as 2 inches to the broil element. "Fast" broiling is best for meats where "rare to medium" doneness is desired. The mini-broil setting is designed for "slow" broiling. Only the center broil element operates for partial power. For "slow" broiling, allow about 4 inches between the top surface of the food and the broil element. "Slow" broiling is best for chicken and ham in order to broil food without over browning it.

CONVECTION BROILING (UPPER OVEN ONLY)

Convection broiling has the advantage of broiling food slightly quicker than conventional. Convection broiling of meats produces better results especially for thick cuts. The meat sears on the outside and retains more juices and natural flavor inside with less shrinkage.

TO USE MAXI-BROIL:

1. Arrange the oven rack in the desired position before turning broiler on.
2. Center the food on cold broiler pan and grid supplied with your oven. Place broiler pan in oven.
3. Set the Oven Function Selector to Maxi-Broil and the Temperature Control knob to Broil.
4. Close the door. With open door broiling the broil element does not cycle on and off. With closed door broiling the broil element might cycle on and off if an extended broiling time is required. A built-in smoke "eliminator" in the top of the oven helps reduce smoke and odors.

TO USE MINI-BROIL:

Follow same steps as listed above except set the Oven Function Selector to Mini-Broil.

BROILING TIPS

- Always use a broiler pan and grid for broiling. They are designed to provide drainage of excess liquid and fat away from the cooking surface to help prevent splatter, smoke, and fire.
- To keep meat from curling, slit fatty edge.
- Brush chicken and fish with butter several times as they broil to prevent drying out. To prevent sticking, lightly grease broiler tray.
- Broil on first side for slightly more than half the recommended time, season, and turn. Season second side just before removing.
- Always pull rack out to stop position before turning or removing food.
- Use tongs or a spatula to turn meats. Never pierce meat with a fork, as this allows the juices to escape.
- Remove the broiler pan from the oven when you remove the food. Drippings will bake onto the pan if it is left in the heated oven after broiling. While pan is hot, place damp paper towel over grid. Drizzle with liquid dishwashing detergent and pour water over grid. This will make cleaning of the pan easier, or the broiler pan can be lined with aluminum foil to make cleaning easier. Be sure the foil extends up the side of the pan. Although it is not recommended, the grid can also be covered with foil. Be sure to slit openings to conform with the openings in the grid so melted fat can drain through to prevent spattering, smoking, or the possibility of grease fire.

BROILING CHART

Type and Cut of Meat	Weight	Setting	Rack	Time(mins.)
BEEF				
Sirloin, 1"	12 oz	Conventional Broil	5	
•Rare				7
•Medium				9
•Well done				11
T-Bone, ¾"	10 oz.	Conventional Broil	5	
•Rare				5
•Medium				7
•Well done				9
Hamburger, ½"	¼ lb.	Convection Broil	5	
•Rare				4
•Medium				7
•Well done				9
CHICKEN				
Bnls Breast	1 lb.	Convection Broil	4	18
Bone-in Breast	2 - 2½ lb.	Conventional Broil	4	20
Chicken pieces	2 - 2½ lb.	Convection Broil	4	18 (min/lb)
HAM				
Ham slice, 1"	1 lb.	Conventional Broil	4	22
LAMB				
Rib Chops, 1"	12 oz.	Convection Broil	5	7
Shoulder	1 lb.	Convection Broil	5	6
PORK				
Loin Chops, ¾"	1 lb.	Convection Broil	4	14
Bacon		Conventional Broil	4	6
FISH				
Salmon Steak	1 lb.	Convection Broil	5	7
Fillets	1 lb.	Convection Broil	5	6

CONVECTION DEHYDRATE (UPPER OVEN ONLY)

This oven is designed not only to cook, but also to dehydrate fruits and vegetables.

- Prepare the food as recommended
- Arrange the food on drying racks. (Not included with the oven; Contact a local store handling speciality cooking utensils.)
- Set the appropriate "low" temperature and turn the convection fan on.

CONVECTION DEFROST (UPPER OVEN ONLY)

- Place the frozen food on a baking sheet.
- Set the temperature control "OFF".*
- Turn the convection fan on.
- IMPORTANT** - Do not turn the temperature control on. Turning the convection fan on will accelerate the natural defrosting of the food without the heat.

WARNING:

To avoid sickness and food waste, do not allow defrosted food to remain in the oven for more than two hours.

CLEANING AND MAINTENANCE

Any piece of equipment works better and lasts longer when maintained properly and kept clean. Cooking equipment is no exception. Your oven must be kept clean and maintained properly.

CONTROL KNOBS

MAKE SURE ALL THE CONTROL KNOBS POINT TO THE OFF POSITION BEFORE REMOVING. Pull the knobs straight off. Wash in detergent and warm water. Dry completely and replace by pushing firmly onto stem.

BROILER PAN AND GRID

Clean with detergent and hot water. For stubborn spots, use a soap-filled steel wool pad.

OVEN RACKS

Clean with detergent and hot water. Stubborn spots can be scoured with a soap-filled steel wool pad. DO NOT CLEAN THE OVEN RACKS OR RACK SUPPORT USING THE SELF-CLEAN CYCLE. They could sustain damage due to the extreme heat of the Self-Clean cycle.

OVEN SURFACES

Several different finishes have been used in your electric oven. Cleaning instructions for each surface are given below. Your oven features a Self-Clean cycle for the oven interior. See pages 33 through 35 for complete instructions.

NEVER USE AMMONIA, STEEL WOOL PADS OR ABRASIVE CLOTHS, CLEANSERS, OVEN CLEANERS, OR ABRASIVE POWDERS. THEY CAN PERMANENTLY DAMAGE YOUR OVEN.

MEAT PROBE

The meat probe may be cleaned with soap and water or a soap-filled scouring pad. Cool the probe before cleaning. Scour stubborn spots with a soap-filled scouring pad, rinse and dry.

- Do not immerse the meat probe in water.
- Do not store the probe in the oven.

STAINLESS STEEL PARTS

All stainless steel body parts should be wiped regularly with hot soapy water at the end of each cooling period and with a liquid cleaner designed for that material when soapy water will not do the job. Do not use steel wool, abrasive cloths, cleansers, or powders. If necessary to scrape stainless steel to remove encrusted materials, soak the area with hot towels to loosen the material, then use a wooden or nylon spatula or scraper. Do not use a metal knife, spatula, or any other metal tool to scrape stainless steel. Do not permit citrus or tomato juice to remain on stainless steel surface, as citric acid will permanently discolor stainless steel. Wipe up any spills immediately.

BRASS PARTS

CAUTION: All special ordered brass parts are coated with an epoxy coating. DO NOT USE BRASS CLEANERS OR ABRASIVE CLEANERS ON ANY BRASS PARTS. All brass body parts should be wiped regularly with hot soapy water. When hot soapy water will not do the job, use every day household cleaners that are not abrasive.

CAUTION:

Do not touch the exterior portions of the oven after self-cleaning cycle has begun, since some parts become extremely hot to the touch! During the first few times the self-cleaning feature is used, there may be some odor and smoking from the "curing" of the binder in the high-density insulation used in the oven. When the insulation is thoroughly cured, this odor will disappear. During subsequent self-cleaning cycles, you may sense an odor characteristic of high temperatures. Keep the kitchen well-vented during the self-cleaning cycle.

SELF-CLEAN CYCLE

This oven features an automatic pyrolytic self-cleaning cycle. During this cycle, the oven reaches elevated temperatures in order to burn off soil and deposits. An integral smoke eliminator helps reduce odors associated with the soil burn-off. A powder ash residue is left in the bottom of the oven after completion of the Self-Clean cycle. The door latch is automatically activated after selecting the Self-Clean setting. The latch ensures that the door cannot be opened while the oven interior is at clean temperatures.

WARNING: Do not use commercial oven cleaners inside the oven. Use of these cleaners can produce hazardous fumes or can damage the porcelain finishes. Do not line the oven with aluminum foil or other materials. These items can melt or burn during a self-clean cycle, causing permanent damage to the oven.

WARNING

Burn or Electrical Shock Hazard

Make sure all controls are OFF and oven is COOL before cleaning.
Failure to do so can result in burns or electrical shock.

BEFORE STARTING THE SELF-CLEAN CYCLE:

1. Remove the oven racks, rack supports, and any other items/utensils from the oven. The high heat generated during the cleaning cycle can discolor, warp, and damage these items. Do not use foil or liners in the oven. During the Self-Clean cycle foil can burn or melt and damage the oven surface.
2. Wipe off any large spills from the oven bottom and sides. Never use oven cleaners inside a self-cleaning oven or on raised portions of the door.
3. Some areas of the oven must be cleaned by hand before the cycle begins. Soils in these areas will be baked on and very difficult to clean if not removed first. Clean the door up to the gasket, the door frame, and up to 2 inches inside the frame with detergent and hot water. Rinse thoroughly and dry.

TO START THE SELF-CLEAN CYCLE:

1. Close the door completely.
2. Turn the oven selector knob clockwise to the self-clean mode.
3. Turn the temperature control knob past the clean setting until the knob stops. At this time, the clean indicator light will come on. Within 30 seconds the automatic door latch engages and the oven indicator light comes on. The oven indicator light will remain on until the oven reaches the self-clean temperature and will then cycle on and off during the self-clean cycle. When the oven reaches the elevated temperature needed for self-clean, the door lock indicator light comes on.
4. The door lock indicator light will remain on until the self-clean is completed or interrupted and the oven temperature drops to a safe temperature. A complete cycle is approximately 3 1/2 hours with an additional 30 minutes needed for the oven to cool down enough for the door latch to disengage.
5. When the cycle is completed, turn both the oven selector and temperature control knob to the off position. When the oven has completely cooled, open door and remove any ash from the oven surfaces with a damp cloth.

TO STOP THE SELF-CLEAN CYCLE:

To cancel or interrupt the self-cleaning cycle, turn both the temperature control knob and the oven function selector knob to "OFF". When the oven temperature drops to a safe temperature, the automatic door latch will release and the oven door can be opened. When the oven has completely cooled, remove any ash from the oven surfaces with a damp sponge or cloth.

REPLACING INTERIOR OVEN LIGHTS

CAUTION: DISCONNECT THE ELECTRIC POWER AT THE MAIN FUSE OR CIRCUIT BREAKER BEFORE REPLACING BULB.

1. Unscrew glass light cover.
2. Use an oven mitt during bulb removal to protect your hand in case the bulb breaks.
3. Replace the bulb with a 120 volt, 40 watt appliance bulb.
4. Replace the light cover.
5. Reconnect power at the main fuse or circuit breaker

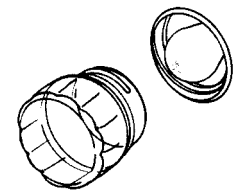

REPLACING INTERIOR HALOGEN LIGHTS (ANALOG MODELS)

Do not touch bulb with bare hands. Clean any signs of oil off of the bulb and handle with a soft cloth.

1. Unsnap glass light cover at opposite end from metal hinge.
2. Firmly grasp light bulb and pull out.
3. Replace with a 64405, 12V-5W bulb.
4. Replace the light cover by first sliding into metal hinge and then snapping close on opposite end.
5. Reconnect power at the main fuse or circuit breaker.

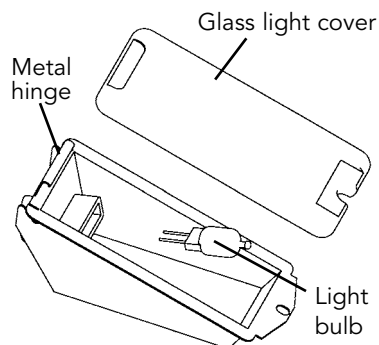

POWER FAILURE

Do not attempt to use during a power failure. Unit will not function.

TROUBLE SHOOTING GUIDE

PROBLEM

POSSIBLE CAUSE AND/OR REMEDY

- | | |
|---|---|
| 1. Oven will not function | Oven is not connected to electrical power. Have electrician check power circuit breaker, wiring and fuses. |
| 2. Oven does not operate in self-clean | Door is not shut tight enough for automatic door latch to lock. |
| 3. Oven is not clean after self-clean cycle | Temperature control knob not rotated all the way past clean until it stops. |
| 4. Broil does not work | Temperature control knob is rotated too far past broil position. |
| 5. Door will not open | Oven is still in self-clean mode. If oven is hot, door latch will release when a safe temperature is reached. |
| 6. Oven light will not work | Light bulb is burned out
Oven is not connected to power. |

SERVICE INFORMATION

If your oven should fail to operate:

1. Is the electrical cord securely inserted into the electrical outlet?
2. Is the circuit breaker open, or is fuse blown?

If service is required:

1. Call your dealer or authorized service agency. The name of the authorized service agency can be obtained from the dealer or distributor in your area.
2. Have the following information readily available:
 - a. Model number
 - b. Serial number
 - c. Date of purchase
 - d. Name of dealer from whom purchased
3. Clearly describe the problem that you are having.

If you are unable to obtain the name of an authorized service agency, or if you continue to have service problems, contact Viking Range Corporation at (662) 451-4133 or write to:

VIKING RANGE CORPORATION PREFERRED SERVICE

111 Front Street
Greenwood, Mississippi (MS) 38930 USA

Record the following information indicated below. You will need it if service is ever required. The serial number and model number for your oven is located on the identification plate mounted on the bottom left side of the oven door opening.

Model Number _____ Serial Number _____

Date of Purchase _____ Date Installed _____

Dealer's Name _____

Address _____

If service requires installation of parts, use only authorized parts to ensure protection under the warranty.

This manual should remain with the oven for future reference.

Free Manuals Download Website

<http://myh66.com>

<http://usermanuals.us>

<http://www.somanuals.com>

<http://www.4manuals.cc>

<http://www.manual-lib.com>

<http://www.404manual.com>

<http://www.luxmanual.com>

<http://aubethermostatmanual.com>

Golf course search by state

<http://golfingnear.com>

Email search by domain

<http://emailbydomain.com>

Auto manuals search

<http://auto.somanuals.com>

TV manuals search

<http://tv.somanuals.com>