

1 9 8 5 VOLVO 740 GL, GLE, Turbo

Contents

A comprehensive index is located at the back of this manual.

[Presentation](#)

[Instruments and controls](#)

[Body and interior](#)

[Starting and driving](#)

[Wheels and tires](#)

[In case of emergency](#)

[Car care](#)

[Service and routine
maintenance](#)

[Specifications](#)

[Index](#)

All information, illustrations and specifications contained in this manual are based on the latest product information available at the time of publication. Volvo reserves the right to make model changes at any time, or to change specifications or design, without notice and without incurring obligation.

pg. 2 Presentation



This Owner's manual provides information on driving and maintaining your Volvo

It should be noted that there are certain differences between model versions and market requirements so that you may find features described in this manual that do not appear on your car. Should you require more detailed information with regard to adjustments or repairs please contact your Volvo dealer.

Do not export your Volvo to another country before investigating that country's applicable safety and exhaust emission requirements. In some cases it may be difficult or impossible to comply with these requirements. Modifications to the emission control system(s) may render your Volvo not certifiable for legal operation in the U.S., Canada, and other countries.

pg. 3 Keys

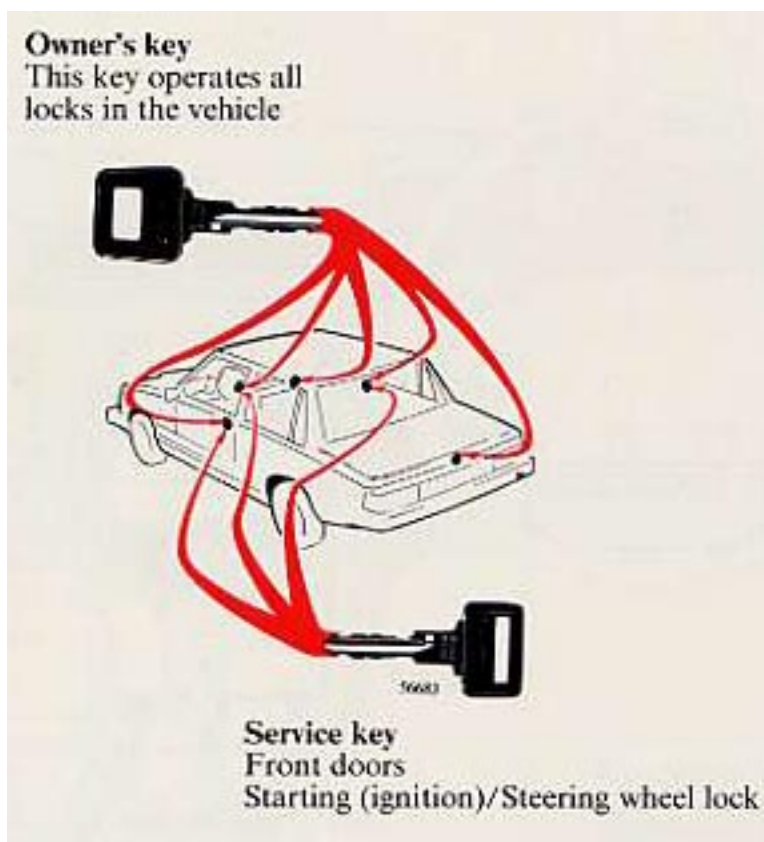

Write the key numbers on the inside of the front cover of this manual as well as your pocket diary. These number codes are stamped on a separate tag supplied with the keys. This tag should be separated from the key ring and kept in a safe place (the back of the tag is coated with adhesive tape). In the event the original keys are lost, duplicates may be ordered from your Volvo dealer. The central locking system is described in detail in section "Door and locks".



[Top of Page](#)

1985 VOLVO 740 GL, GLE, Turbo

Instruments and controls

pg. 4 Instruments, Switches and controls

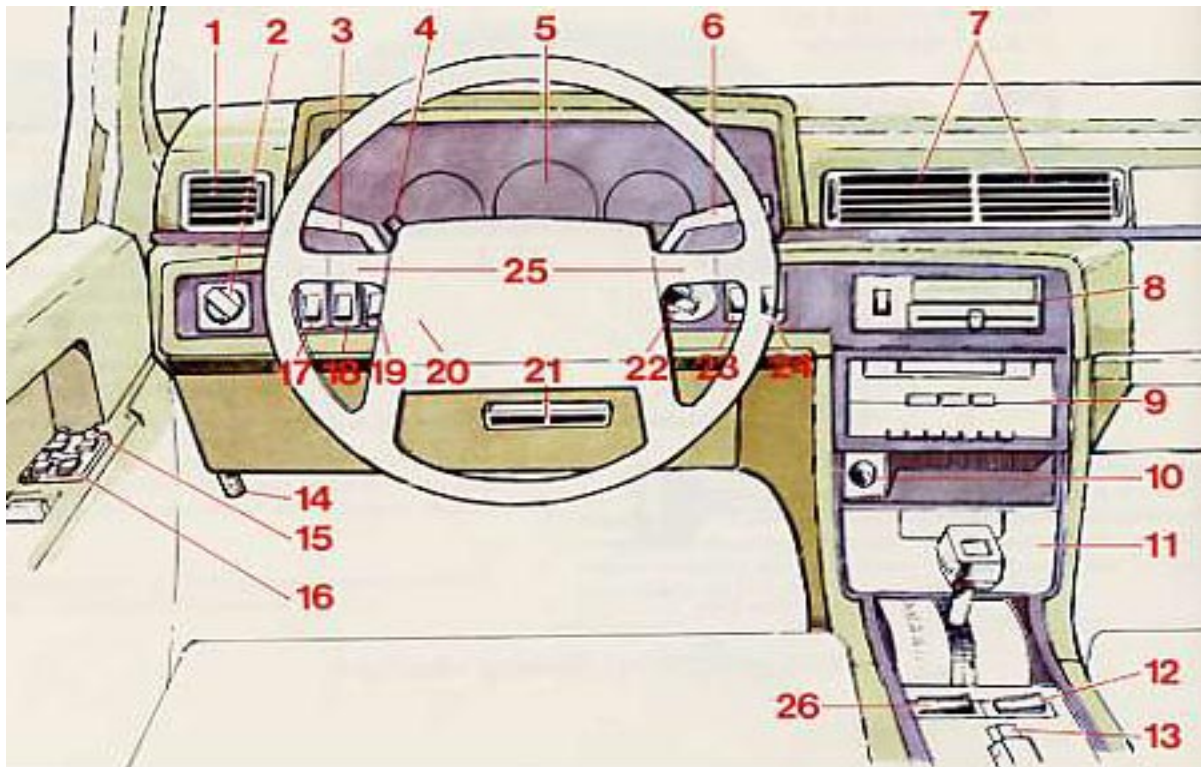

pg. 5 Instruments, Switches and controls

1 Air louver	20
2 Headlights, parking lights	15
3 Turn signals, Cruise Control	12,13
4 Hazard warning flashers	12
5 Instruments	6
6 Wiper/washer	14
7 Air louvers	20

8 Heating and ventilation	20
9 Radio receptacle	24
10 Cigarette lighter	18
11 Ash tray	18
12 Electrically-heated passenger seat	17
13 Parking brake	18
14 Hood release handle	35
15 Control for electrically operated side mirrors	26
16 Electrically operated windows	19
17 Rear fog lamps	16
18 Fog light	16
19 Space for additional equipment	-
20 Space for additional equipment	-
21 Air louver	20
22 Starting (ignition) switch/steering wheel lock	11
23 Space for additional equipment	-
24 Rear window demister	17
25 Horn	-
26 Electrically-heated driver's seat	17

The pages in this section provide a detailed description of the vehicle's instruments and controls. Note that vehicles may be equipped differently, depending on special legal requirements, etc.

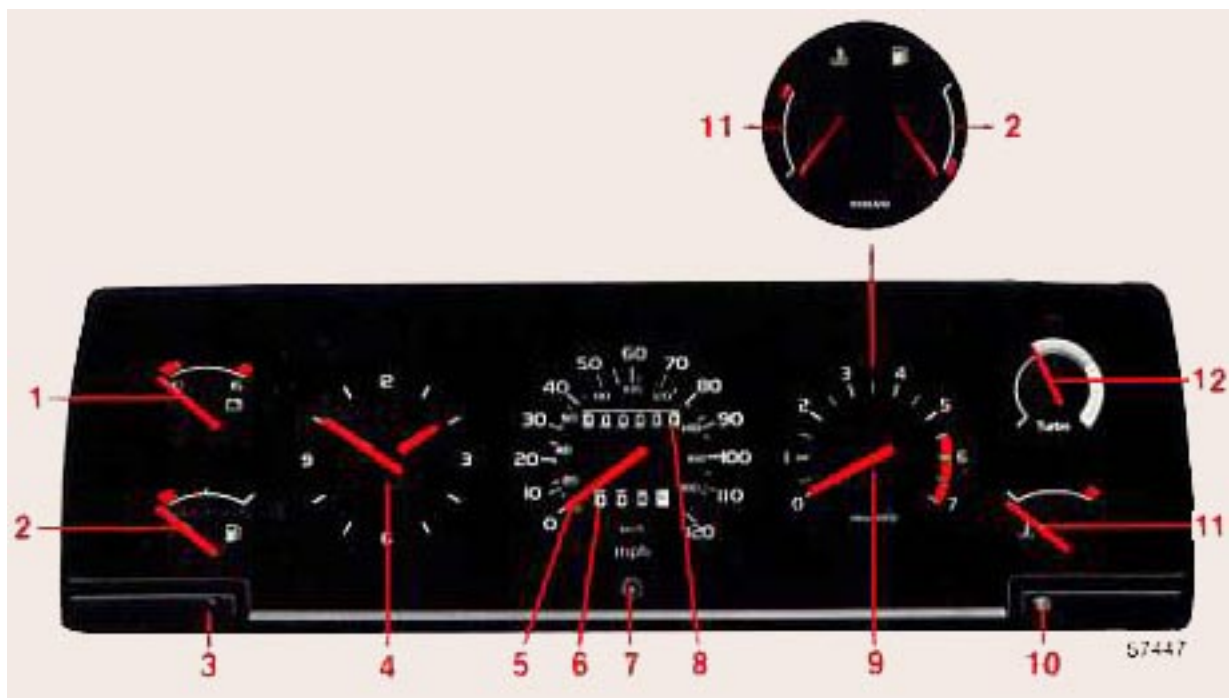

NOTE: Canadian model speedometers/odometers indicate kilometers only.

- 1 Voltmeter (Turbo models)
- 2 Fuel gauge
- 3 Clock reset knob
- 4 Quartz crystal clock
- 5 Speedometer
- 6 Trip odometer
- 7 Trip odometer reset knob
- 8 Odometer
- 9 Tachometer
- 10 Instrument panel lamps rheostat
- 11 Temperature gauge
- 12 Boost gauge (Turbo models)

pg. 7 Instruments

Quartz crystal clock

To reset the hands, push in the reset knob and turn.

Note: A slight ticking sound emitted by the clock is considered normal.

Tachometer

Reads thousands of engine rpm. Red striped range for momentary use, during acceleration. Engine should not be operated in red range.

Maximum continuous rpm is 6000.

The turbo engine is equipped with an rpm-limiter system; at engine speeds above approx. 6200 rpm, excessive misfiring will occur.

Trip odometer

Used for measuring shorter distances. (last figure represents 1/10 mile or 1/10 km)

Trip odometer reset knob

Push in to reset.

Temperature gauge

The pointer should be approximately midway on the gauge face when driving. If the pointer approaches the red range repeatedly, check coolant level and fan belt tension. (See "Coolant" and "Drive belts")

WARNING!

Allow engine to cool before adding coolant.

Fuel gauge

The fuel tank capacity is approx. 15.8 US gals (60 liters).

The red range represents approx. 2.1 US gals (8 liters).

Instrument panel lamps rheostat

Clockwise = brighter.

Counterclockwise = dimmer.

Voltmeter

(turbo-engine cars only)

The voltmeter indicates the voltage in the electrical system and thereby also the state of the battery.

While the car is being driven the pointer should be within the black field.

Should the pointer point to the upper or lower red field when driving, this may indicate some fault in the electrical system.

Boost pressure gauge

(turbo-engine cars only)

The boost pressure gauge is divided into sections.

Black section: The engine acts as a normally-aspirated engine. Best fuel economy is achieved while driving in this range.

Yellow section: The turbo is engaged.

Red section: The pressure in the intake manifold is too high. Drive the car carefully to a Volvo dealer

for inspection.

The warning light for boost pressure illuminates when the gauge pointer moves into the red section.

pg. 8 Indicator and warning lights



- 1 (Not connected)
- 2 (Not connected)
- 3 (Not connected)
- 4 (Not connected)
- 5 (Not connected)
- 6 Low engine oil pressure
- 7 Alternator not charging
- 8 Overdrive engaged (manual transmission)
- 9 High beams
- 10 Brake failure
- 11 Parking brake applied
- 12 Bulb failure
- 13 Low washer fluid level.
If the lamp glows continuously when the engine is running, there is only about 1/2 - 1 US qts. remaining in the washer fluid reservoir.
- 14 Shift indicator light (manual transmission models)
- 4th gear disengaged (740 Turbo only) (see Automatic transmission)
- 15 Fasten seat belts
- 16 (Not connected)
- 17 Turn signal, left
- 18 Turn signal, right

pg. 9 Warning lights

The warning lights described on this page should never stay on when driving

When the ignition key is turned on, and before the engine starts, all of the warning lights should be on to test the function of the bulbs. Should a light not go off after the engine has started, the system indicated should be inspected. (However, the parking brake reminder light will not go off until the parking brake is fully released.)

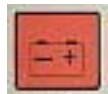
**Alternator warning light**

If the light comes on while the engine is running, check the tension of the alternator drive belt as soon as possible.

NOTE: This warning light is illuminated if the alternator is not charging. However, **parking brake, brake failure and bulb failure warning lights will be illuminated at the same time due to the design of the system.**

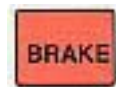
**Brake failure warning light**

If the light comes on while driving and the brake pedal can be depressed further than normal, it is an indication that one of the brake circuits is not functioning.

Stop immediately, open hood and check brake fluid level (see section "Brake fluid, power steering".)

Fluid level below MIN mark: Do **NOT** drive. Tow car to shop for check/repair of brake system.

Fluid level between MIN and MAX mark: proceed immediately and with **caution** to a Volvo dealer for an inspection of the brake system.

**Oil pressure warning light**

If the light comes on during driving, the oil pressure is too low. Stop the car and then stop the engine **immediately** and check the engine oil level. See section titled "Engine oil".

After hard driving, the light will come on occasionally when the engine is idling. This is normal, provided it goes off when the engine speed is increased.

**Parking brake reminder light**

This light will be on when the parking brake (hand brake) is applied. The parking brake lever is situated between the front seats.



Bulb failure warning light

The light will come on if any of the following bulbs are defective:

one of the low beam headlights

one of the tail lights

one of the brake lights (when the brake pedal is depressed).

Check the fuse and bulb.

See sections titled "Replacing bulbs" and "Fuses". Should the warning light come on after a defective outside bulb has been replaced, the corresponding bulb on the other side of the car should also be replaced.

pg. 10 Starting indicator light



Shift indicator light (Manual transmission cars only)

The Volvo shift indicator light (S.I.L.) is a device designed to help you get even better gas mileage from your Volvo car. Studies have shown that the best fuel economy is obtained by shifting gears at low engine rpm and high relative engine load. The Volvo S.I.L. is calibrated to show you when to shift for improved mileage *without sacrificing smooth acceleration*.

Use of the S.I.L. is simple. Shift to the next higher gear as soon as the light comes on. You may find after using the S.I.L. for some time that your natural shifting rhythm will adapt to the S.I.L.'s suggestion. Some driver's may even shift before the light comes on.

Obviously, there will be times when you need to shift later than the light would indicate (for example, when climbing hills or trailer towing). Using the light regularly, however, should result in a mileage improvement of six percent or more, depending on how you normally drive.

Programming instructions for shift indicator

If the current supply to the control unit is cut (battery disconnected), the control unit will have to be re-programmed as the control unit memory will be erased.

Drive the car in each gear (first gear not necessary) for approximately 8 seconds.

The gear change indicator light will flicker once (0.5 seconds), as each gear is programmed.

Note: Remove the foot completely from the clutch pedal after each gear change when programming the

control unit.

pg. 11 Starting (ignition) switch



Starting (ignition) switch/steering wheel lock

The steering wheel lock might be under tension when the car is parked. Turn the steering wheel slightly to free the ignition key.

A chime will sound if the starting key is left in the ignition lock and front door on the driver's side is opened.



pg. 12 Turn signals, Hazard warning flasher



Turn signals

1 Lane change position.

In maneuvers such as lane changing, the driver can flash the turn signals by moving the turn signal lever to the first stop and holding it there. The lever will return to the neutral position when released.

2 Signal lever engaged for normal turns.

Defective turn signal bulb will cause turn signal indicator and remaining signal lights to flash more

rapidly than normal.



3 High beam/low beam switch (headlights on).

Move the lever towards the steering wheel and release it.

3 Headlight flasher (headlights off).

Move the lever towards the steering wheel. The headlight high beam will be on until the lever is released.



Hazard warning flasher

Four-way flashing is used to indicate that the vehicle has become a traffic hazard (either during daylight or at night).

NOTE: Regulations regarding the use of the hazard warning flasher may vary from state to state.

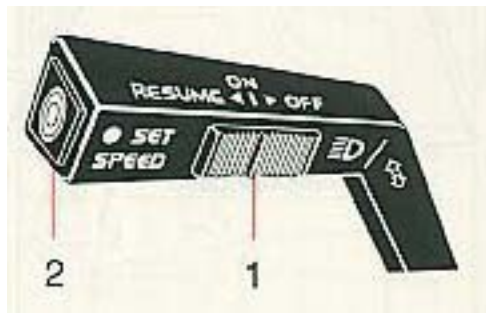

Cruise control (optional)

The cruise control switches are located on the turn signal switch lever.

To engage and set desired speed:

1. Set switch (1) to ON.
2. Accelerate to desired cruise speed.

NOTE: The cruise control cannot be engaged at speeds below 22 mph (35 km).

3. Depress SET SPEED switch (2).

Operating brake pedal or clutch pedal

Will automatically disengage the cruise control. Previously selected cruise speed is retained in the memory. It can be re-introduced by momentarily setting the switch to RESUME position.

NOTE: The vehicle will accelerate very quickly should there be a substantial speed differential when the switch is reset to RESUME. It is therefore recommended that the vehicle be accelerated manually and the switch reset to RESUME when the speed differential is reduced.

Acceleration

Momentary acceleration, such as for passing, does not interrupt cruise control operation. The previously selected speed will be maintained without having to set switch to RESUME.

Disengage the cruise control system

- set switch (1) to position OFF
- depress brake pedal
- depress clutch pedal (where applicable).

Switching off the starting (ignition) switch will automatically disengage the cruise control system.

WARNING!

The cruise control should not be used in heavy traffic or when driving on wet or slippery roads. In case the gear shift is moved unintentionally to Neutral during driving with the cruise control engaged:

- depress the brake pedal momentarily, or set the cruise control switch (1) to OFF.

This will disengage the cruise control and prevent overrevving the engine.

pg. 14 Windshield wipers



Wiper/washer

1 Intermittent wiper.

With switch in this position, the wipers will sweep approximately every seventh second.

2 "Single sweep" position.

Switch returns automatically when released.

3 Wipers, low speed.

4 Wipers, high speed.



5 Windshield wiper/washer.

The wiper will make 2-3 complete sweeps after the lever is released.



Adjusting washer nozzles

The washer jets should spray the windshield as shown. Use the edge of a small screwdriver to adjust the nozzles.

Washer fluid reservoir

The washer fluid reservoir is located in the engine compartment and holds approx. 3.2 US qts. (3.0 liters). See illustration on back cover.

During cold weather, the reservoir should be filled with windshield washer solvent as specified in "Cold weather precautions" section.



Headlights and position lights

- ▣ All lights off
- ☞ Parking lights on
- ☞ Headlights and parking lights are on if starting (ignition) switch is in position I or II.

If the headlight switch is in position ☞ all lights will go out when starting (ignition) switch is switched off.

With the headlight switch in position ☞ the parking lights will stay on.

Switch from high to low beams, and vice versa, by moving the turn signal switch lever on the left side of the steering column towards the steering wheel.

pg. 16 Rear fog lights, Front fog lights



Rear fog lights

The rear fog lights are considerably brighter than the normal tail lights and should be used only when atmospheric conditions, such as fog, rain, snow, smoke or dust reduce the daytime or nighttime visibility of other vehicles to less than 500 ft. (152 meters). (The headlights must be switched on.)

Note that local regulations governing the use of these lights may vary.



Auxiliary front fog lights (optional on certain models)

Auxiliary front fog lights can be switched on **only** with the **low-beam** headlights on.

pg. 17 Rear window demister, Heated front seats



Rear window demister

To operate, depress the switch. The indicator lamp in the switch will come on. The system will be switched off automatically after 10-15 minutes or when the starting (ignition) key is switched off.

CAUTION: Do not place items that may damage the printed circuit against the inner surface of the rear window. Do not scrape the inner surface of the rear window glass with a hard object or use an abrasive window cleaner, otherwise damage to the printed circuit will occur.



Heated front seats (certain models)

The driver's seat is equipped with electrically-heated backrests and seat cushions. The heating is thermostatically-controlled and switches on automatically when the seat temperature drops below 50°F (10°C) and switches off at about 95°F (+35°C). Use the switches to disengage the seat heating manually.

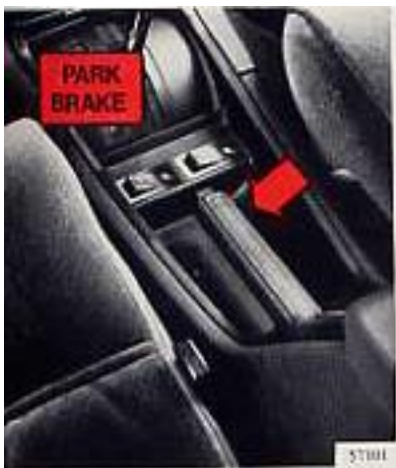

Parking brake (hand brake)

The lever is situated between the front seats.

The brake is applied to the rear wheels.

Always use the parking brake (hand brake) when parking. On hills, also turn the front wheels toward the curb.

In order to obtain the best possible performance of the parking brake, the brake linings should be broken in. See section titled "Brake system".



Cigarette lighter

To operate, depress the knob fully. When the knob automatically releases, the cigarette lighter is ready for use.

The starting (ignition) switch must be switched on (to position I or II) for the cigarette lighter to function.



Rear seat ash tray

Ash trays

To remove the ash trays depress the center spring and remove.

pg. 19 Electrically operated windows



Electrically-operated windows (GLE and Turbo models)

The electrically-operated windows are controlled by switches set in the door armrests. All of the windows can be controlled from the driver's armrest as shown in the above illustration.

The starting (ignition) switch must be ON (position II) for the electrically operated windows to function. The window is lowered if the rear part of the switch is pressed and raised if the front part of the switch is pressed.



Cut-out switch for electrically-operated rear-door windows

If the car is equipped with rear door power windows, this function can be disabled by a switch located on the driver's door armrest. This switch is positioned 90° in relation to the other switches.

- The rear door windows can be raised or lowered with the respective door switch as well as the switch on the driver's door.
- The rear door windows **cannot** be raised or lowered with the respective door switch but instead **only** with the corresponding switch on the driver's door.

pg. 20 Heating and ventilation

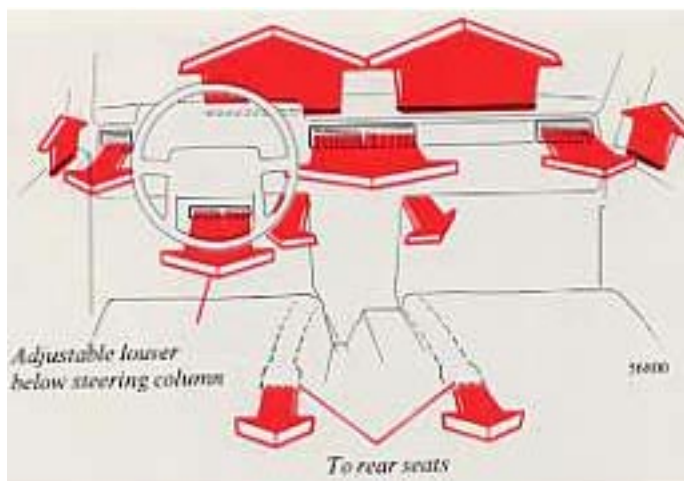

Heating and ventilation

Your Volvo is equipped with:

- Heating system
- or
- Heating system combined with air conditioning.

Depending on which function you select, warm or cool/cold air is distributed to the different parts of the passenger compartment. An additional driver's air louver is located beneath the steering column and can be adjusted upwards, downwards, or closed as desired.

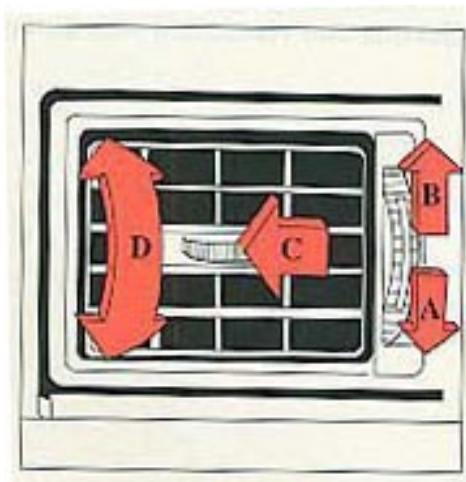

Air louvers (dash)

- A Open
- B Closed
- C Directing air flow horizontally
- D Directing air flow vertically



pg. 21 Heating and ventilation

Heating and ventilation system without air conditioning

Air distribution

 Recirculation interior air enters through panel vents. Very little air is drawn from outside. Use this position to avoid circulating dense exhaust gases (as when driving through a tunnel). Do not use this position for more than 10-15 minutes as very little fresh air will be supplied.

 Air from panel louvers.

  On the system without air conditioning these two symbols represent identical functions. (With air conditioning the upper sign position emits cooled air).

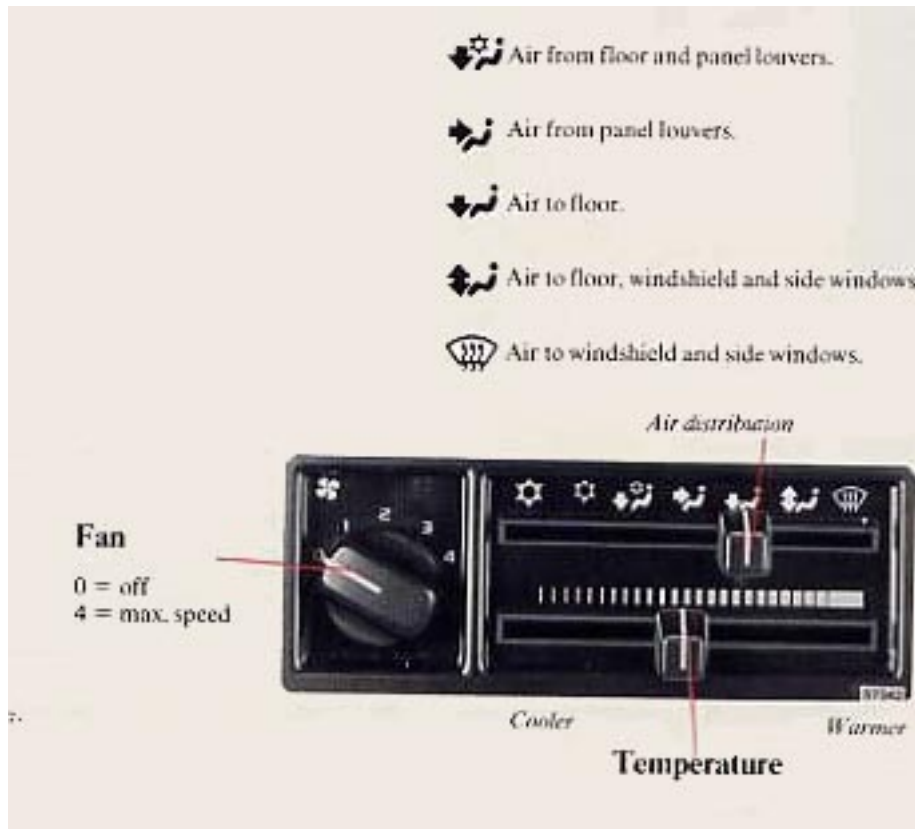

NOTE:
A certain amount of air will always enter through the dash air louvers as long as they are open, independent of the position of the air distribution control.

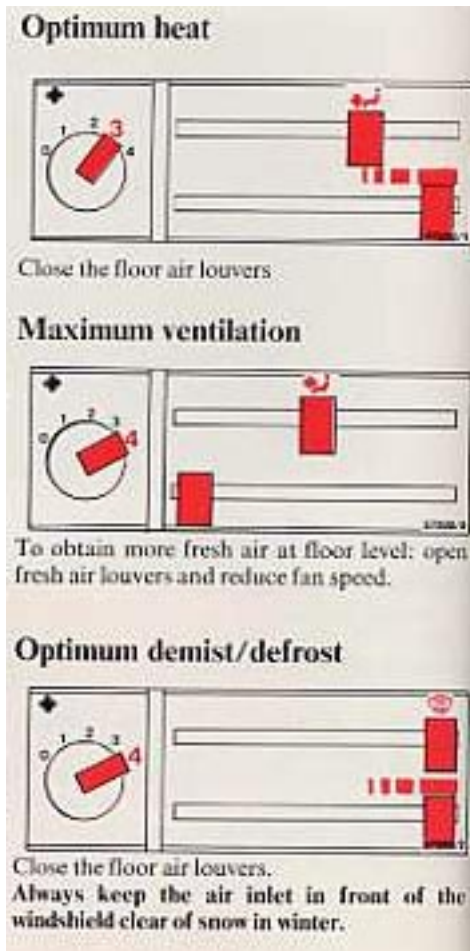

pg. 22 Heating and ventilation

Heating and ventilation system with air conditioning

Air distribution

<p>Air conditioning engaged.</p> <ul style="list-style-type: none"> Select for quickest cooling. The temperature control lever must be at left. Cooled air enters passenger compartment through panel vents. Select in conditions of very high temperature and humidity. Return lever to or when desired temperature is reached. 	<ul style="list-style-type: none"> Normal cooling. Cooled air from panel louvers. Normal cooling. Cooled air from floor and panel louvers. Defrost. Air to windshield and side windows. 	<p>Air conditioning unit not engaged.</p> <ul style="list-style-type: none"> Air through panel louvers. Air to floor. Air to floor, windshield and side windows.
--	---	---

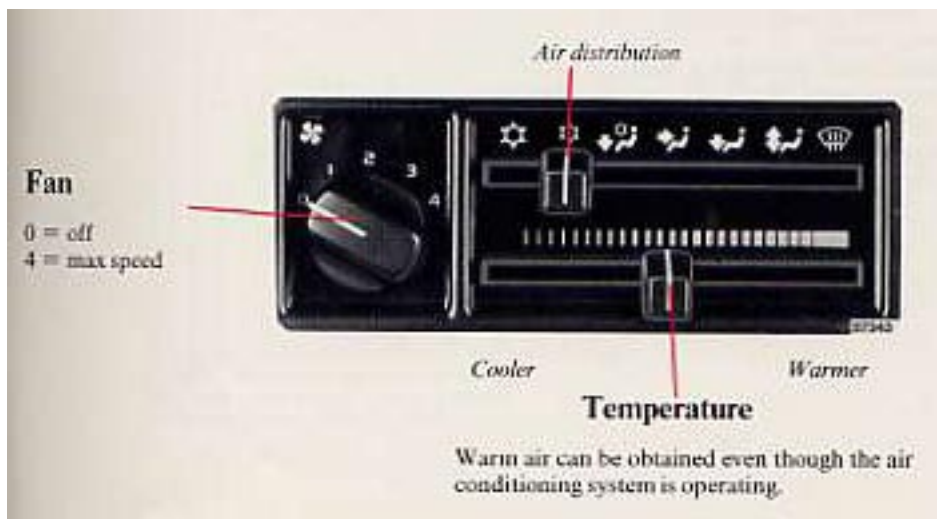

NOTE:
A certain amount of air will always enter through the dash air louvers as long as they are open; independent of the position of the air distribution control.
Close the dash air louvers to obtain maximum air flow to floor or windshield.
Open the two outer air louvers if the side windows become misted.

pg. 23 Heating and ventilation

Optimum heat

Maximum ventilation

Move the selector lever to or when the desired temperature is reached.

Optimum demist/defrost

Always keep the air inlet grill in front of the windshield clear of snow in winter.

Additional information and tips

- The air conditioning compressor is engaged only if the temperature is above 46°F (+8°C).
- In all three air conditioning positions the fan runs at speed 1 if the switch is at "0". This is a safety measure to prevent formation of ice in the system.

- **When the outside air isn't fresh**

When the outside air is contaminated with exhaust gases, smoke, etc. (as when driving through a tunnel), move the lever to  for a few minutes. In this position very little air is drawn in to the passenger compartment from outside. Do not, however, leave the lever in this position for more than 10-15 minutes, since hardly any fresh air is being supplied.

Regulate the temperature with the temperature control lever.

pg. 24 Radios, AM-FM-FM-Stereo-/Tape players



Operation instructions

Operating instructions are contained in a separate manual. This manual is placed in the car when the equipment is installed.

Your Volvo dealer will be able to assist you with any questions regarding the operation of this equipment.

Radio antenna

NOTE: Always lower the antenna when entering automatic car wash.

The following information may help to explain differences between car radio reception and radio reception in the home.

Signal sending

FM waves do not follow the earth surface and do not "bounce" against the atmosphere.

Cross modulation

When listening to a weak station and in the vicinity of another strong signal, both stations may be received.

Weak reception (fading)

Because of the limited range of FM signals and the way FM waves are spread, this problem can occur with FM reception.

Mountains or similar obstacles can sometimes cause disturbances.



[Contents](#) | [Top of Page](#)

1985 VOLVO 740 GL, GLE, Turbo

Body and interior

pg. 25 Body and interior

The seats, seat belts, doors, etc. are described on the following pages.

Rear-view/side-view mirrors	26
Interior light, sun roof	27
Front seats	28
Child safety	29
Seat belts	30
Doors and locks	32
Trunk, long load storage	33
Hood	35
Passenger compartment, storage spaces	36

pg. 26 Rear/side-view mirrors



Rear-view mirror

A Normal position

B Night position, reduces glare from following headlights



Manually operated side view mirrors

Use the lever to adjust.

Never use ice scrapers made of metal as they can easily scratch the mirror surface.

The mirrors should always be adjusted before driving.

pg. 27 Interior light, Sun roof



Interior light

1. Light always on.
2. Light always off.
3. Light is on when either of the front or rear doors are opened.

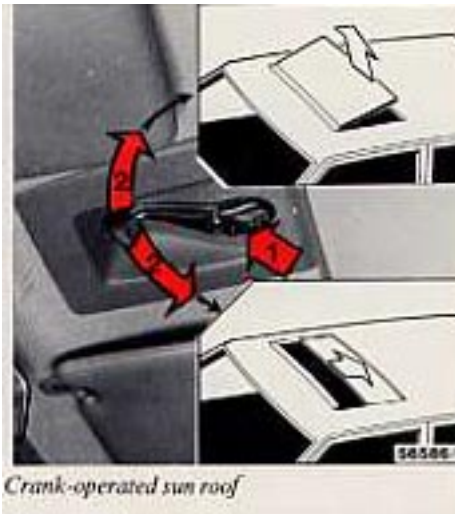

The sun roof can be used in two ways: as a conventional sliding roof, or the rear edge can be raised or lowered to provide various ventilation positions.

Sun roof

Depress the button prior to cranking.

Counter-clockwise: sliding roof

Clockwise: ventilation positions

NOTE:

For added safety, always have the crank folded during driving!

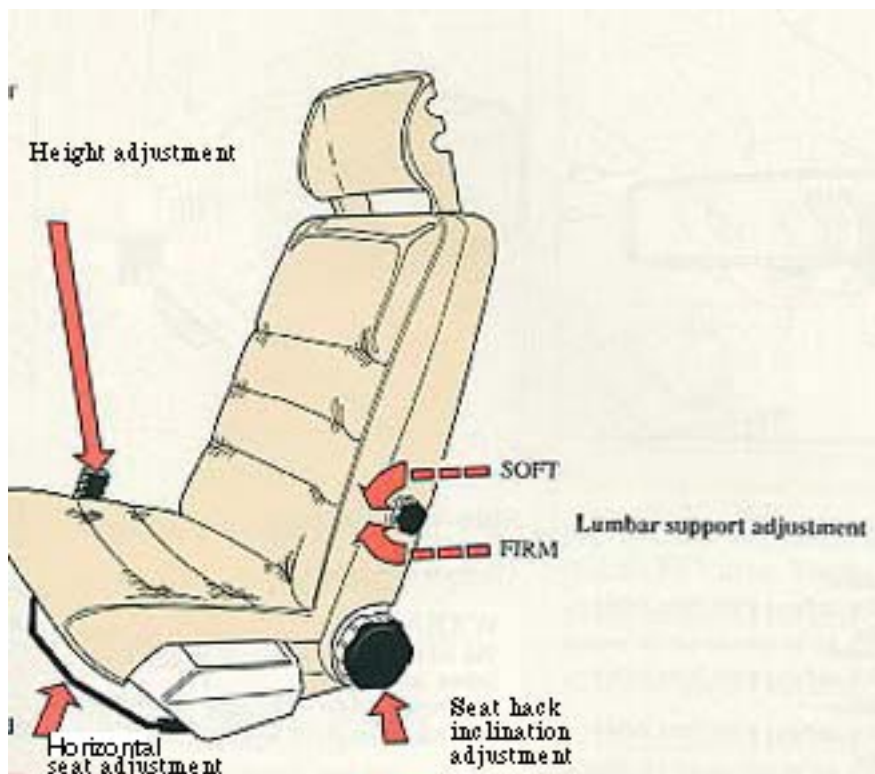

Height adjustment

The front section of the driver's seat can be adjusted to three height positions and the rear section to four.

Lever forward = front height adjustment

Lever rearward = rear height adjustment

Do not adjust the seat while driving.

The passenger's seat is rigidly attached to the floor. Tools are required to adjust the height. Both the front and the rear of the passenger's seat have two height adjustments.

Horizontal seat adjustment

Pull control upward, then slide seat forward or rearward to desired position.

Make sure that the seat is properly secure when you release the control.

Note: For your safety, never adjust the seat while driving.

Seat back inclination adjustment

Rotate control clockwise to tilt seat back rearward.

Rotate counterclockwise to tilt seat-back forward.

Note that body weight must be shifted to allow seat back to move forward or rearward.

Electrically-heated seats

The front seats are electrically heated and thermostatically controlled. Automatic engagement begins at 50°F (+10°C) and ends at 95°F (+35°C). Use the console-mounted switches to deactivate the heating, if desired.

Child safety

Volvo recommends the proper use of restraint systems for all occupants including children. Remember that, regardless of age and size, a child should always be properly restrained in a car.

Holding a child in your arms is NOT a suitable substitute for a child restraint system. In an accident, a child held in a person's arms can be crushed between the vehicle's interior and an unrestrained person. The child could also be injured by striking the interior, or by being ejected from the vehicle during a sudden maneuver or impact. The same can also happen if the infant or child rides unrestrained on the seat. Other occupants should also be properly restrained to help reduce the chance of injuring or increasing the injury of a child.

In many states and provinces have legislation governing how and where children should be carried in a car. Find out the regulations existing in your state or province.

A child restraint system can help protect a child in a vehicle. Here's what to look for when selecting a child restraint system:

- It should have a label certifying that it meets applicable Federal Motor Vehicle Safety Standards (FMVSS 213-80) - or in Canada, CMVSS 213.
- Make sure the child restraint system is approved for the child's height, weight and development - the label required by the standard or regulation, or instructions for infant restraints, typically provide this information.
- **In using any child restraint system, we urge you to look carefully over the instructions that are provided with the restraint. Be sure you understand them and can use the device properly and safely in this vehicle.**
- If your child restraint requires a top tether strap, consult your authorized Volvo dealer for top tether anchorage and installation information (sedan models only).

When a child has outgrown the child safety seat (approximately age 4-5 years, depending on size) you should use the rear seat with the standard seat belt fastened. The best way to protect the child here is to place the child on a cushion so that the seat/lap belt is properly located on the hips.

A specially designed and tested safety cushion for this purpose can be obtained from your Volvo dealer.

Seat Belts



Always fasten the seat belts before you drive or ride.

Two lights will be illuminated for 4-8 seconds after the starting (ignition) key is turned to the driving position. One light is located in the instrument panel and one in the console between the front seats. A chime will sound at the same time if the driver has not fastened his seat belt. The rear outboard seats are provided with self-retracting inertia-reel belts. The front seats are provided with twin roller belts.



To buckle:

Pull the belt out from both retractors far enough to insert the latch plate into the receptacle (buckle for rear seats), until a distinct snapping sound is heard.

The seat belt retractors are normally "unlocked" and you can move freely, provided that the shoulder belt is not pulled out too far. The retractors will lock up as follows:

- if belt is pulled out rapidly
- during braking and acceleration
- if the vehicle is leaning excessively
- when driving in turns.

Adjusting shoulder belt



Lap portion of the belt should sit low

In order for the seat belt to provide maximum protection in the event of an accident, it must be worn correctly. When wearing remember:

- the belt should not be twisted or turned

- the lap belt must be positioned low (not pressing against the abdomen). Make sure that the shoulder belt is rolled up into its retractor and that the shoulder and lap belts are taut.
- To unfasten, depress red pushbutton in receptacle (buckle) and let the belts rewind into their retractors.

pg. 31 Seat belts

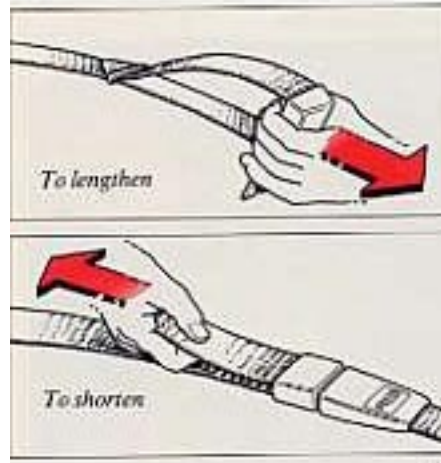

Center-rear belt adjustment

The center-rear seat belt is manually adjustable. It should always be adjusted to the correct length.

Maintenance

Check periodically that the anchor bolts are secure and that the belts are in good condition.

Use water and a mild detergent for cleaning. Check seat belt mechanism function as follows:

1. Attach the seat belt. Pull rapidly on the strap.

2. **CAUTION: Check other traffic before performing the following check.**

Brake firmly from approximately 30 mph (50 km/h) or turn in a tight circle while pulling on the belt.

In both of the over checks you should not be able to pull to belt out.

WARNING!

Volvo recommends that all occupants wear their seat belts.

Never use a seat belt for more than one occupant.

Never wear the shoulder portion of the belt under the arm or otherwise out of position. Such use could cause injury in event of accident.

As the seat belts lose much of their strength when exposed to violent stretching, they should be replaced after any collision, even though they may appear to be undamaged.

Never repair the belt on your own, but have this done by an authorized Volvo dealer only



During pregnancy

Pregnant women should always wear seat belts. Remember that the belt should always be positioned in such a way as to avoid any possible pressure on the abdomen. The lap portion of the belt should be located low, as shown in the above illustration.

NOTE: Legislation in your state or province may mandate seat belt usage.

pg. 32 Doors and locks



Door locks

The vehicle is equipped with a central door-locking system. This means the lock on the driver's door controls the locks on the other doors (including the trunk) automatically.

If the driver's door is locked or unlocked from the outside using the key, the other doors will be locked or unlocked automatically.

To lock/unlock the car by using the lock button on the inside of the driver's door, push/pull to lock/unlock all the doors. Check the action of the buttons on the other doors to verify their correct function (lock/unlock).

The driver's door can be locked only by using the key when outside the vehicle.

CAUTION!

The lock buttons should not be in the down position during driving. In case of an accident, this may hinder rapid access to the occupants of the vehicle. (Also see information on "child safety locks" on next page.)

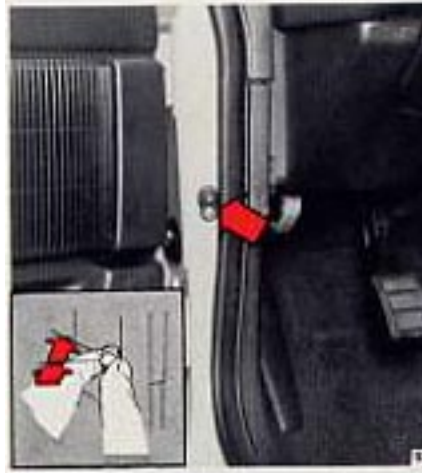

To avoid battery drain

The interior light and the warning lights in the rear of the doors come on when a door is opened. To avoid battery drain when the doors are opened for prolonged periods, these lights can be switched off by pushing in and turning the **driver's door** light switch slightly clockwise. When the door is closed the switch will return to its normal position.

pg. 33 Trunk lid



Child safety Locks

The buttons are located on the rear door jambs.

A The door lock functions normally.

B The door cannot be opened from the inside. Normal operation from outside.

Remember, in the event of an accident, the rear seat passengers cannot open the doors from the inside with the levers in position B.



Trunk Lid

The trunk lock is incorporated in the central locking system. This means that you can either lock or unlock the trunk by means of the driver's door lock.

You can also operate the trunk lock directly with the owner's key even if the vehicle is centrally locked.



pg. 34 Trunk, Long load storage



Long load storage

In the panel behind the rear seat is a door which makes it possible to carry long loads such as skis. etc.

Trunk light

A Light always off.

B Light is on when trunk lid is opened.

WARNING!

When braking rapidly the load could be displaced and cause injury to occupants. Sharp edges on the load should be covered for protection. It is essential that the load be secured safely. Use belts locked around the folded down armrest (see illustration).



Protective covers (for skis) should also be used to avoid soiling or tearing the upholstery. Please note that the flap in the rear seat is only intended for light loads such as skis, wood etc.

Max. length of load 6 1/2 ft = 2 m.

Max. weight of load 33 lbs = 15 kg.

WARNING!

Take care when loading/unloading the vehicle. Always turn off the engine and apply the parking brake. Place automatic transmission gear shift selector in P (PARK). This will prevent accidental movement of the gear shift selector to position D (Drive).

pg. 35 Hood, Engine compartment light

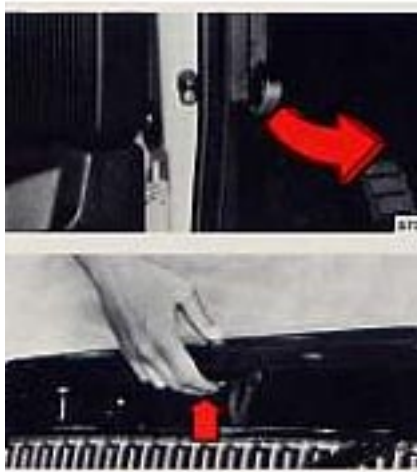

To open the hood

Pull the release handle (located under the left side of the dash).

Lift the hood slightly, insert a hand under the center line of the hood and depress the safety-catch handle.

Open the hood.

Check that the hood locks properly when closed.



The normal opening angle for the hood is approximately 55°. By turning the catches or the hinges as illustrated, the hood can be opened to the vertical position. The catches will return to their normal positions when the hood is closed.

Take care in low-roof garages!



Engine compartment light

A the light is always off

B the light comes on when the hood is opened.

pg. 36 Storage spaces

CAUTION!
Packages on the rear window shelf can obscure vision and may become dangerous projectiles in the event of a sudden stop or an accident.

Pocket on rear of front seats

Storage area alongside seat

Button, make-up mirror

Between front seats

Compartment in front doors

Glove compartment

CAUTION!

Packages on the rear window shelf can obscure vision and may become dangerous projectiles in the event of a sudden stop or an accident.



[Contents](#) | [Top of Page](#)

1 9 8 5 VOLVO 740 GL, GLE, Turbo

Starting and driving

pg. 37 Starting and driving. Break-in period

This section on starting and driving contains items such as starting the engine, operating gear selector, towing, trailers.

Break-in period	37
Fuel requirements, Refueling	38
Economical driving	39
Starting the engine	40
Transmission	41
Points to remember	46
Emergency towing	48
Starting with an auxiliary battery	50
Catalytic Converter	51
Brakes	52
Towing a trailer	53
Winter driving	54
Before a long distance trip	55
Vehicle storage	56

A new car should be broken-in!

Refrain from utilizing your car's full acceleration during the first 1,200 miles (2,000 km).

Automatic transmission

Do not use "kick-down" during the first 1200 miles (2000 km).

Manual transmission

Do not exceed following speeds:*

Gear	First 600 miles(1,000 km)		600-1,200 miles(1,000-2,000 km)	
	mph	km/h	mph	km/h
first	18	30	25	40
second	30	50	45	70
third	50	80	60	100
fourth	70	110	80	130
overdrive	80	130	90	150

*These are the maximum speeds recommended by the factory. Note that legislation in different countries and states can stipulate maximum speeds other than those given here.

pg. 38 Fuel requirements, Refueling

Unleaded Fuel

Each Volvo has a catalytic converter and must use only unleaded gasoline (as specified on the instrument panel and by a label near the filler inlet). US and Canadian regulations require that pumps delivering unleaded gasoline be labeled "UNLEADED". Only these pumps have nozzles which fit your car's filler inlet. It is unlawful to dispense leaded fuel into a vehicle labeled "unleaded gasoline only". Leaded gasoline damages the catalytic converter and the oxygen sensor system. Repeated use of leaded gasoline will lessen the effectiveness of the emission control system and could result in loss of emission warranty coverage. State and local vehicle inspection programs will make detection of misfueling easier, possibly resulting in emission test failure for misfueled vehicles.

Octane Rating

Volvo engines require unleaded gasoline with an (R+M)/2 octane rating (also called the Anti-Knock Index, or AKI) of 87 or higher. This is generally equivalent to a Research Octane Number (RON) of 91 or higher. For turbocharged engines, Volvo recommends the use of premium unleaded gasoline, with an (R+M)/2 of 91 or higher, for improved performance and driveability at high altitudes and in hot climates.

Gasoline Containing Alcohol

Some fuel suppliers sell gasoline containing alcohol without advertising the presence of alcohol. If you are not sure whether there is alcohol in the gasoline you buy, check with the service station operator. Blends of unleaded gasoline and ethanol (ethyl alcohol, grain alcohol), sometimes called "gasohol", are available in some areas. Gasohol, if used, must contain no more than 10 percent ethanol and must have an (R+M)/2 rating of 87 or higher. If you experience problems with starting, driveability, or fuel

economy with gasohol, you should discontinue its use.

Take care not to spill gasoline during refueling. Gasolines containing alcohol can cause damage to painted surfaces, which may not be covered under the New Vehicle Warranty.

Do not use gasolines containing methanol (methyl alcohol, wood alcohol). This practice can result in vehicle performance deterioration and can damage critical parts in the fuel system. Such damage may not be covered under the NEW VEHICLE LIMITED WARRANTY.



Refueling

The fuel tank filler cap is located behind the door on the left rear fender. **Open cap slowly during hot weather conditions.**

When filling, position the cap in the special bracket on the door.

After filling the tank, install the cap and turn until a "click" is heard.

Tank capacity: 15.8 US gallons. (60 liters).

pg. 39 Driving economy

Economical driving does not necessarily mean driving slow

Better driving economy may be obtained by thinking ahead, avoiding rapid starts and stops and adjusting the speed of your vehicle to changing traffic conditions. Observe the following rules:

- Bring the engine to normal operating temperature as soon as possible by driving with a light foot on the accelerator pedal for the first few minutes of operation. A cold engine uses more fuel and is subject to increased wear.
- Whenever possible avoid using the car for driving short distances. This does not allow the engine to reach normal operating temperature.
- Drive carefully and avoid rapid acceleration and hard braking.
- Do not exceed speed limit.
- Avoid carrying unnecessary items (extra load) in the car.
- Check tire pressure regularly (check when tires are cold)
- Remove snow tires when threat of snow or ice has ended.
- Note that roof racks, ski racks, etc., increase air resistance and thereby fuel consumption.
- Turbo: try to keep the boost pressure gauge in the black range.
- Utilize overdrive at speeds above approx. 45 mph (70 km/h)
- Avoid using automatic transmission where applicable kick-down feature unless necessary.

- On cars with manual transmission, utilize the shift indicator light (S.I.L.). See "Instruments".

Other factors which decrease gas mileage are:

- Worn or dirty spark plugs
- Incorrect spark plug gap
- Dirty air filter
- Incorrect valve clearance
- Dirty engine oil and clogged oil filter
- Dragging brakes
- Incorrect front end alignment
- Low tire pressure

Some of the above mentioned items and others are checked at the standard 7,500 Mile (12,500 km) Maintenance Service intervals.

pg. 40 Starting the engine, Turbo caution

To start the engine:

1 Enter the car and fasten seat belt.

2 Apply the parking brake, if not already set.

3 Place the gear selector lever in neutral/park (position N or P on cars with automatic transmission).

4 Without touching the accelerator pedal turn the ignition key to starting position. Release the key as soon as the engine starts.

If the engine does not start at once, depress the throttle pedal half way and keep it there until the engine starts.

Avoid repeated short attempts to start (fuel is injected every time the starter is engaged when engine is cold). Allow the starter to operate for a longer time (but not more than 15 - 20 seconds).

Do not race a cold engine immediately after starting. Oil flow may not reach some lubricating points fast enough to prevent engine damage.

WARNING!

Always open the garage doors fully before starting the engine inside a garage to ensure adequate ventilation. The exhaust gases contain carbon monoxide, which is invisible and odorless but very poisonous.

Engine warm-up - initial driving procedure

Experience shows that engines in vehicles driven short distances are subject to abnormally-rapid wear because the engine never reaches normal operating temperature, It is therefore beneficial to reach normal

operating temperature as soon as possible. This is best achieved by driving with a light foot on the accelerator pedal for a few minutes after starting, rather than prolonged idling.

Turbo caution

Never race the engine **immediately after starting**. Oil flow may not reach some lubricating points fast enough to prevent engine damage.

Before switching off the engine, let it operate at idle for a short time to allow the spinning of the turbo-compressor's turbine vanes to slow. After hard driving, this idle time should last a couple of minutes, during which the vanes will slow and the compressor will cool down while still receiving lubrication. If the turbine vanes are spinning at high speeds when the engine is switched off, there is a great risk of heat damage and/or turbine seizure due to lack of lubrication.

Do not race the engine just prior to switching off!

pg. 41 Manual transmission + overdrive



Gear lever

Depress the clutch fully when shifting gears, and when engaging/disengaging overdrive (5th gear). Remove foot from the clutch pedal after shifting.

Overdrive (5th gear)

The overdrive can be engaged in 4th gear only. Depress the clutch fully when engaging/disengaging. The overdrive is engaged/disengaged by depressing the switch on top of the gear shift lever.



The overdrive is automatically disengaged when downshifting from 4th gear, but you should **always** disengage the overdrive **manually** before downshifting.

To improve mileage it is recommended to use the overdrive as much as possible at speeds above 45 mph (70 km/h).

The green control light "5" on the dashboard lights when the overdrive is engaged.

See "Shift indicator light" section for more information on economical use of the manual transmission.

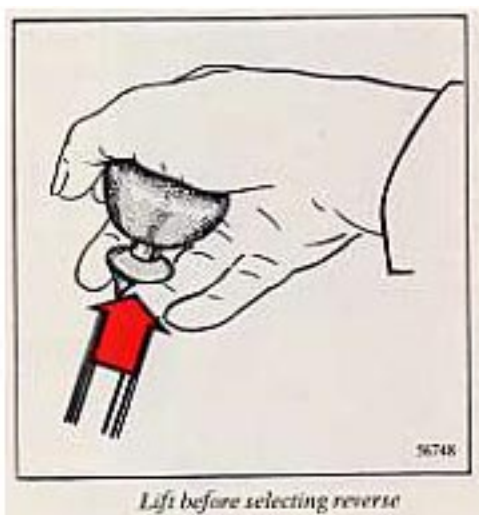

Reverse gear

The detent collar on the gear lever must be lifted prior to engaging reverse gear. This prevents unintentional selection of the gear.



AW71 transmission (Turbo models)
ZF transmission (GL, GLE models)

Gear selector positions

P park
R reverse
N neutral
D drive
3
2 intermediate
1 and low

P (Park)

Use this position when parked with the engine running or stopped.

Never use P while car is in motion.

The transmission is mechanically-locked when in position P. Also, apply the parking brake when parking on grades.

Never leave the car when the engine is running. If, by mistake, the gear selector is moved from P, the car may start moving.

R (Reverse)

Never engage R while car is moving forward.

N (Neutral)

Neutral position = no gear is engaged.

Use parking brake.

Driving gears

D (Drive)

D is the normal driving position. Upshifts and downshifts of the forward gears occur automatically and are governed by accelerator pedal position and vehicle speed.

Lock-up

(GL, GLE models; ZF transmission)

With the gear selector in position D (Drive) the lockup device disengages the torque converter at speeds above approx. 53 mph (85 km/h). It provides lowered engine speeds and improved mileage.

The lockup engagement may be noticed as an extra upshift when accelerating.

The lockup device engages only after the transmission has reached a temperature of approx. 68°F (20°C)

3 (upper position)

(GL, GLE models; ZF transmission)

Upshifts and downshifts between 1st, 2nd, and 3rd gears occur automatically.

Upshift to D does not occur.

Position 3 can be used ...

- for passing
- when towing a trailer
- for stop and go city driving

83 mph (135 km/h)* is maximum permitted speed in position 3

***Always observe posted speed limits!**

pg. 43 Automatic transmission

2 (intermediate position)

Upshifts and downshifts of first two gears (low and intermediate) occur automatically.

No upshift to 3rd or 4th gear occurs. Position 2 may be used to obtain forced downshift to 2nd gear for increased engine braking effect.

1 (low position)

If position 1 is selected when driving at high speeds, 2 is engaged first and 1 when the speed has dropped approx. 30 mph (50 km/h).

NOTE: No upshift can occur once 1 is engaged.

Use position 1 to select low gear when no upshift is desired. (For instance, when entering and descending steep grades.)

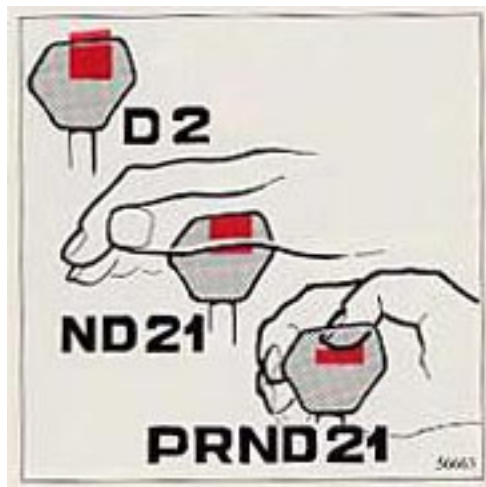

Shift gate: AW71 transmission (Turbo models)

The gear selector can be moved freely between D and 2. Selections of other positions are obtained by depressing the selector knob prior to moving the selector.

Slightly depressing the selector knob allows selection of positions N, D, 2 and 1.

Fully depressing the selector knob allows selection of positions R and P. This is also necessary when initially bringing the selector out of position P.

Fully depressing the selector knob thus permits shifting freely between all positions.

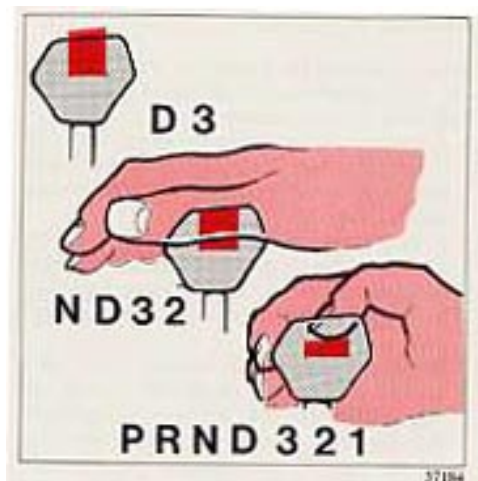

Shift gate: ZF Transmission (GL, GLE models)

The gear selector can be moved freely between D and 3. Selections of other positions are obtained by depressing the selector knob prior to moving the selector.



Slightly depressing the selector knob allows selection of positions N, D, 3 and 2.

Fully depressing the selector knob allows selection of positions R, P and 1. This is also necessary when initially bringing the selector out of position P.

Fully depressing the selector knob thus permits shifting freely between all positions.



4th gear disengagement: AW71 transmission(Turbo models)

The 4th gear is engaged automatically after the transmission has shifted through 1st, 2nd and 3rd gears at certain speeds and loads. By pressing in the button on the side of the selector lever, the 4th gear can be disengaged, thus providing a three-speed transmission. As a reminder the  light on the dashboard glows. By pressing in the button again, the transmission reverts to four-speed operation and the  light shuts off.

Disengage the 4th gear when:

- towing a trailer
- driving in mountainous regions.

Since using the 4th gear improves fuel economy, it should be used as often as possible in conditions other than those stated above.

Kick-down

Automatic shift to a lower gear is achieved by depressing the throttle pedal fully and briskly. An up-shift will be achieved when approaching the top speed for a particular gear or by releasing the throttle pedal slightly.

Kick-down can be used for maximum acceleration or when passing at highway speeds below a certain limit.

NOTE:

- Never select P or R while the car is in motion.
- When initially selecting positions D, 3, 2, 1, or R the car should be standing still with the engine idling.
- The gear selector should not be downshifted to 2 or 1 at speeds above 75 mph (125 km/h).*

*Always observe local speed limits!

Starting and stopping a car equipped with automatic transmission

1. Fasten the seat belts.
2. Apply the parking brake and press the brake pedal firmly to hold the car (to prevent it from moving when the gear selector is moved).
3. Select position **P** or **N**. (Engine cannot be started in any other position.)
4. Start the engine by turning the starting (ignition) key.
5. Select desired gear. The gear engages with a slight delay, especially noticed in R.

Engine should be idling; never accelerate until after you feel the gear is engaged!

Too rapid acceleration immediately after selecting gears will provide harsh engagement and premature transmission wear.

6. Release the brakes and accelerate.

To stop the car, release the accelerator pedal and apply the brakes.

Selecting position N when standing still with engine running for prolonged periods of time will avoid overheating transmission fluid.

The following "Special Tips" apply to cars with automatic transmission

- For steep hills and when driving for prolonged periods at low speeds position 1 should be selected. Avoid, however, repeated changes since this can cause overheating of the transmission oil. For driving on mountain roads with long persistent uphill gradients, select position 2.
- When negotiating long, steep downhill slopes, position 1 should be selected and position 2 for less severe inclines, in order to obtain the best possible engine braking effect.
- Do not hold the car stationary on an incline by using the accelerator pedal; instead, engage the parking brake. This prevents unnecessary heating of the transmission oil.
- When towing, prepare as follows:

AW71 Transmission (Turbo models):

Disengage the 4th gear (the indicator light on the instrument panel goes on).

ZF Transmission (GL, GLE models):

Disengage position D by selecting gear position 3. This prevents upshifts to Drive and helps ensure lower transmission oil temperatures.

WARNING!

Always place gear selector securely in Park, and apply parking brake before leaving vehicle. Never leave car unattended with engine running.

Cooling system

The risk for overheating is greatest, especially in hot weather, when:

- towing a trailer up steep inclines for prolonged periods at full throttle and low engine rpm.
- idling for prolonged periods while the air conditioning system is in operation.
- stopping the engine suddenly after high speed driving (so-called "after-boiling" can occur).

To avoid overheating, the following rules should be followed:

- Reduce speed and downshift when towing a trailer up long, steep inclines. The risk of overheating can be reduced by switching off the air conditioning system for a short time.
- Do not let the engine idle unnecessarily for prolonged periods.
- Do not stop the engine immediately after high-speed driving, but instead, allow the engine to idle for 1/2-1 minute before switching off.

When the risk of overheating is imminent, or in the event of overheating, (the temperature gauge goes repeatedly into, or stays continually in, the red section) the following precautions should be taken:

- Switch off the air conditioning system.
- Stop the car and put the gear lever into neutral (position N). **Do not stop the engine!**
- Increase the engine speed to approx. 2000 rpm (twice idling speed).
- Check the level of coolant in the expansion tank. Top-up, if necessary.

This car is equipped with an alternator

When replacing the battery or when carrying out work involving the electrical system, the following should be observed:

- A battery connection to the wrong terminal will damage the diodes. Before connections are made, check the polarity of the battery with a voltmeter.
- If booster batteries are used for starting, they must be properly connected to minimize the risk of the diodes being damaged. For correct connection, see "Jump starting" section.
- Never disconnect the battery circuit (for example, to replace the battery) while the engine is running, as this will immediately ruin the alternator. Always make sure that all the battery connections are properly tightened.
- If any electrical-welding work is performed on the vehicle, the ground lead and all the connecting cables of the alternator must be disconnected and the welder cables placed as near the welding point as possible.

WARNING! Do not drive with trunk lid or tailgate open!

Poisonous exhaust gases may enter via the open trunk lid or tailgate. If the trunk lid/tailgate must be kept open for any reason, proceed as follows:

- Close the windows.
- Set the ventilation system control to  and fan control to its highest setting.

Driving through standing water

CAUTION: Drive slowly and carefully if going through standing water (i.e. flooded roadways, etc.). Damage to engine could result if excess water is ingested through the air intake system. **Never drive the vehicle in water deeper than 1 foot (300 mm).**

pg. 47 Points to remember

Weight distribution affects handling

At the specified curb weight your car has a tendency to understeer, which means that the steering wheel has to be turned more than might seem appropriate for the curvature of a bend. This ensures good stability and reduces the risk of rear wheel skid. Remember that these properties can alter with the vehicle load. The heavier the load in the trunk, the less the tendency to understeer.

Handling, roadholding

Vehicle load, tire design, and inflation pressure, all affect vehicle handling. Therefore, check that the tires are inflated to the recommended pressure according to the vehicle load. See "Tire pressure" section.

CAUTION!

It is recommended that tires of the same make and dimensions be used on all four wheels. Do not use bias ply tires as this will adversely alter vehicle handling characteristics.

Roof racks (removable and permanent)

Roof racks are available as Volvo accessories.

Observe the following points when in use:

- Avoid single-point loads. Distribute the load evenly.

- Place heavier cargo at the bottom of load.
- Observe that center of gravity and handling are influenced by load weight.
- Increasing load size increases wind resistance and, thus, adversely affects fuel economy.
- Anchor the cargo correctly with a cord.
- Drive carefully. Avoid rapid starts, fast cornering and hard braking.
- Max. roof load is 220 lbs (100 kg).

pg. 48 Emergency towing (pulling of vehicle)

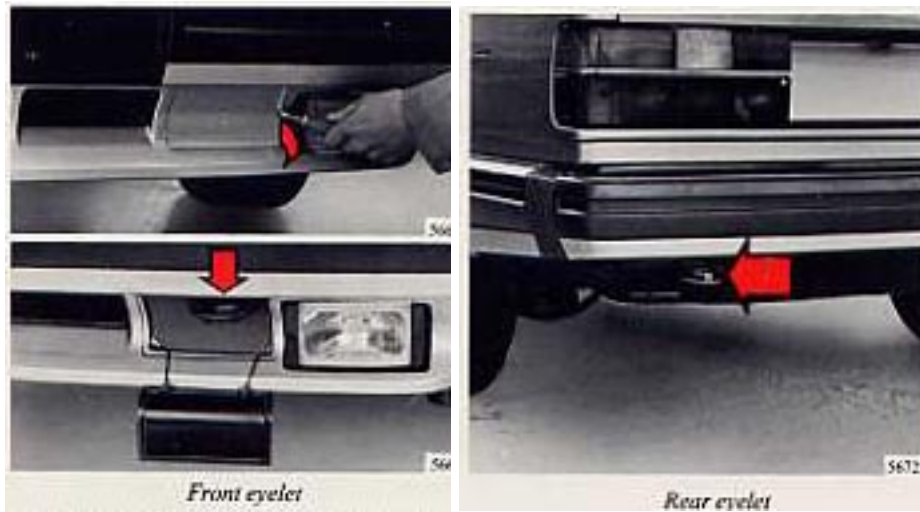

Precautionary steps to observe when car is in tow:

- Steering must be unlocked.
- **Please check with state and local authorities before attempting this type of towing, as vehicles being towed are subject to regulations regarding maximum towing speed, length and type of towing device, lighting, etc.**
- Remember that power brake and power steering assists will not be available when engine is inoperative. Brake pedal pressure required is 3-4 times above normal and greater steering effort must be exerted.
- Gear selector in position N. Check transmission oil level (see section titled "Transmission oil")
- Maximum speed: 20 mph (30 km/h).
- Maximum distance with rear wheels on ground: 20 miles (30 km).

Cars equipped with automatic transmission cannot be started by pushing or pulling the car.

NOTE:

The towing eyelets must not be used for pulling another vehicle out of a ditch or any similar purpose involving severe strain.

pg. 49 Vehicle towing information

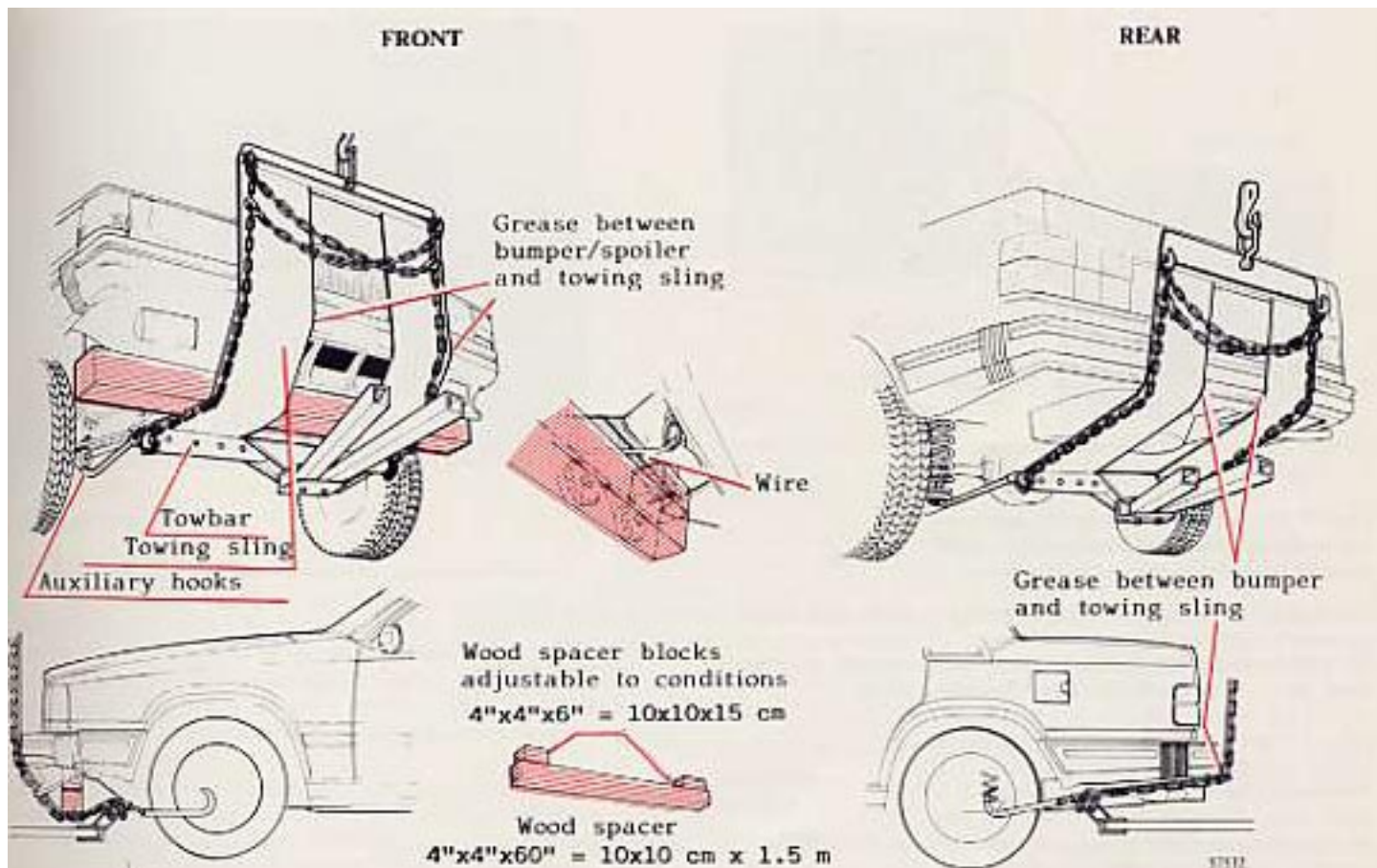

pg. 50 Jump starting

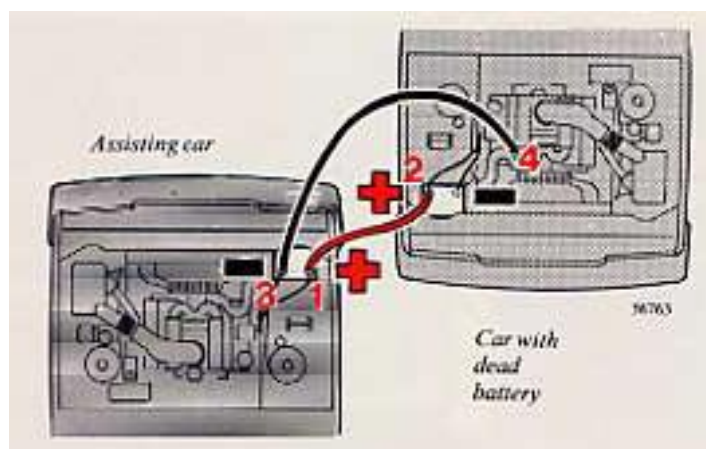

CAUTION:

Improper hook-up of jumper cables or use of other than 12-volt batteries could result in damage to equipment and/or battery.

Check that cars are not touching to prevent premature completion of negative circuit.

Note position of the battery terminals and using jumper cables, first connect booster battery positive (+) terminal (1) to car battery positive (+) terminal (2).

Then connect booster battery negative (-) terminal (3) to a stationary solid metal part on the engine at a point away from the battery (4).

Do not connect booster cable to any part of fuel system or any moving parts. Avoid touching hot manifolds.

After engine has started, remove first the negative (-) terminal jumper cable. Then remove the positive (+) terminal jumper cable.

WARNING!

To reduce the possibility of explosion, never expose battery to open flame or electric spark. Do not smoke near battery. Batteries generate hydrogen gas which is flammable and explosive.

Battery fluid contains sulfuric acid. Do not allow battery fluid to contact eyes, skin, fabrics or painted surfaces. If contact occurs, flush affected area immediately with water.

Obtain medical attention immediately if eyes are affected.

pg. 51 Catalytic Converter

Catalytic Converter Cautions

- Keep your engine properly tuned. Certain engine malfunctions, particularly involving the electrical, fuel or ignition systems, may cause unusually high converter temperature. **Do not continue to operate your vehicle if you detect engine misfire, noticeable loss of power or other unusual operating conditions**, such as engine overheating or backfires. A properly tuned engine will help avoid malfunctions that could damage the catalytic converter.
- Remember that tampering or unauthorized modifications to the engine or the vehicle may be illegal and can cause catalyst or exhaust system overheating. This includes:
Altering fuel injection settings or components. Adjusting ignition timing beyond specified limits.
Altering emission system components or location or removing components.
Repeated use of leaded fuel.

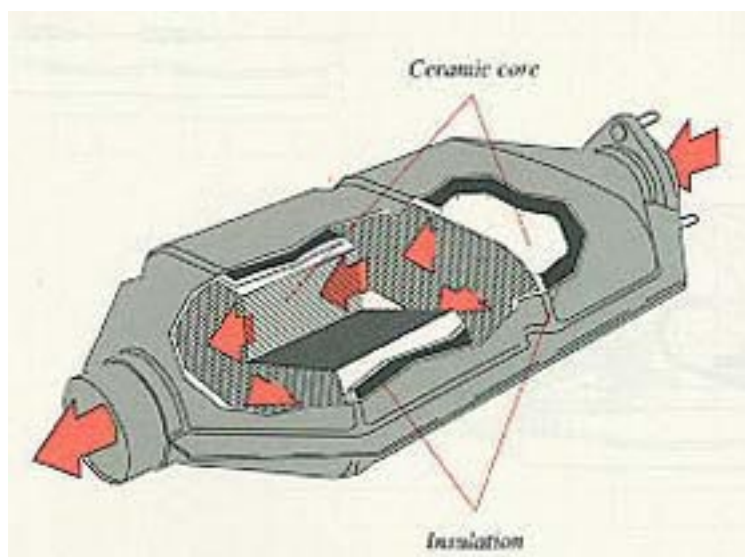

- Do not park your car over combustible materials, such as grass or leaves, which can come into contact with the hot exhaust system and cause such materials to ignite under certain wind and weather conditions.
- Excessive starter cranking, in excess of one minute, with an intermittently-firing or flooded engine, can cause catalyst or exhaust system overheating. This also applies to lengthy pushing or towing of vehicle to start (manual transmission only).

NOTE: Unleaded fuel is required for cars with catalytic converter. A label on the instrument panel and inside fuel tank filler door will remind owners and filling station attendants of this requirement.

Important! It is unlawful to dispense leaded fuel into any vehicle labeled "unleaded gasoline only".

pg. 52 Brake system

If one of the brake circuits should malfunction, the red warning light will come on
(see page 8)

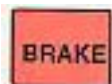

The pedal stroke increases slightly and the pedal feels softer but the pedal pressure required does not increase noticeably.

If the red warning light comes on: stop **immediately**, open the hood and check brake fluid level (see "Brake fluid, power steering" section).

- Fluid level below MIN mark: do **not** drive. Tow car to shop for check/repair of brake system.
- Fluid level between MIN and MAX mark: proceed with extreme **caution** to a Volvo dealer for an inspection of the brake system.

If the brake power-assist does not function

The power assist to the brakes functions only when the engine is running. When the car is moving

without the engine running the brake pedal pressure required to stop the car is increased by 3-4 times.
The brake pedal feels stiff and hard.

Moisture on brake discs and brake pads affects braking.

Driving in rain and slush or passing through an automatic car wash can cause water to collect on the brake discs and pads. This will cause a delay in braking effect when the pedal is depressed. To avoid such a delay when the brakes are needed, depress the pedal occasionally when driving through rain, slush, etc. This will remove the water from the brakes. Check that brake application feels normal! This should also be done after washing or starting in very damp weather.

Severe strain on the brake system

The brakes will be subject to severe strain when driving in **mountains** or hilly areas. The speed is usually low which means that the cooling of the brakes is less efficient than when driving on level roads. To reduce the strain on the brakes it is advisable not to use the brakes excessively.

Instead, shift into a lower gear and let the engine help with the braking. A good rule is to use the same gear downhill as would be used ascending the same grade. For vehicles with automatic transmission use position 2 or, in some cases, 1.

Do not forget that, if you are towing a trailer, the brakes will be subjected to greater load than is normal.

Breaking-in parking brake (hand brake)

To obtain best parking brake performance, the brake linings should be broken-in.

Stop 5-7 times from 30 mph (50 km/h), transmission in neutral, applying the parking brake with the release button pressed in during the stop.

The force must not lock the rear wheels. If this happens, release the brake enough to let the wheels rotate. Drive a mile between each stop to cool the brakes. Check for proper parking brake operation.

NOTE:

The brake lights are not illuminated when applying the parking brake. To warn traffic from behind it is therefore advisable to depress the brake pedal slightly to illuminate the brake lights.

pg. 53 Trailer hauling

When preparing for trailer hauling, observe the following:

- Use a trailer hitch which meets Federal Safety Standards for rear end collisions (FMVSS 301-75). For trailer weights exceeding 2,000 lbs (908 kgs) use only a trailer hitch offered as Genuine Volvo Accessory.

An **automatic transmission oil cooler** must also be installed, since the automatic transmission is subject to increased load and temperature (certain vehicles are equipped with this extra oil cooler as standard equipment). Consult your Volvo dealer for further information.

- Maximum trailer weight recommended by Volvo is 3,300 lbs (1,500 kgs). Observe legal requirements of the state in which the vehicles are registered.

All Volvo models are equipped with energy-absorbing shock-mounted bumpers. Trailer hitch installation should not interfere with the proper operation of this bumper system.

WARNING!

Bumper-attached trailer hitches must not be used on Volvos, nor should safety chains be attached to the bumper.

Trailer hitches attaching to the vehicle rear axle must also not be used.

NOTE: Never connect a trailer's hydraulic brake system directly to the vehicle brake system, nor a trailer's lighting system directly to the vehicle lighting system. Consult your nearest authorized Volvo dealer for correct installation.

Trailer towing does not normally present any particular problems, but take into consideration:

- Recommended hitch tongue load is 110 lbs (50 kgs) for trailer weights below 2,650 lbs (1,200 kgs) and 143-154 lbs (65-70 kgs) for trailer weights above 2,650 lbs (1,200 kgs).

However, the hitch tongue load should not exceed 200 lbs (90 kgs).

- For trailer weights of 2,650-3,300 lbs (1,200-1,500 kgs) a top speed of 50 mph (80 km/h) should never be exceeded.
- Engine and transmission are subject to increased loads. Therefore, engine coolant temperature should be closely watched when driving in hot climates or hilly terrain. Use lower gear and turn off air conditioner if temperature gauge pointer enters the red range.
- Disengage the overdrive ("O/D" light goes on) on models with automatic transmission.
- Avoid overload and other abusive operation.
- Hauling a trailer affects handling, durability and economy. A trailer air dam (Volvo accessory) will often improve mileage.
- It is necessary to balance trailer brakes with the towing vehicle brakes to provide a safe stop (check and observe State/Local regulations).
- More frequent vehicle maintenance is required.
- Remove the ball and drawbar assembly when the hitch is not being used.

Note: Refer to section entitled "Automatic transmission" for additional trailer hauling tips.

pg. 54 Winter driving

Cold weather precautions

If you wish to check your car before the approach of cold weather, the following advice is worth noting:

- Make sure that the **engine coolant** contains at least 50 percent antifreeze: that is, 5.0 qts. (4.25 liters) Volvo type C blue-green glycol additive. This gives protection against freezing down to -31°F(-35°C). See section "Coolant".

- Try to keep the **fuel tank** well filled-this prevents the formation of condensation in the tank. In addition to extremely cold weather conditions it is worthwhile to add fuel line de-icer before refueling.
- Use the correct grade of **engine oil** to avoid difficulties when starting. See section "Engine oil".
- The load placed on **the battery** is greater during the winter since the heater, windshield wipers, lighting etc. are used more often. Moreover, the capacity of the battery decreases as the temperature drops. In very cold weather, a poorly charged battery can freeze and be damaged. It is therefore advisable to check the state of charge more frequently and spray an anti-rust oil on the battery posts.
- To prevent the **washer reservoir** from freezing, add washer solvents containing antifreeze. This is important since dirt is often splashed on the windshield during winter driving, thus requiring frequent use of the washers and wipers.

The Volvo washer solvent should be diluted as follows:

Down to 14°F (-10°C): 1 part anti-freeze and 4 parts water

Down to 5°F (-15°C): 1 part anti-freeze and 3 parts water

Down to 0°F (-18°C): 1 part anti-freeze and 2 parts water

Down to -18°F (-28°C): 1 part anti-freeze and 1 part water

- Lubricate all **locks** with an anti-freeze type lock oil to ensure trouble-free operations.



pg. 55 Long distance trip

Before a long distance trip

It is always worthwhile to have your car checked at a Volvo dealer before driving long distances. Your Dealer will also be able to supply you with bulbs, fuses, spark plugs and wiper blades for your use in the event that problems occur.

A list of all authorized Volvo dealers in the U.S. and Canada is available.



If you prefer to check the car yourself, please note the following:

- Check that engine runs smoothly and that fuel consumption is normal.
- Check engine oil, coolant levels, and for possible fuel leakage.
- Check transmission oil level and rear axle for leakage.
- Check condition of drive belts.
- Check state of charge of battery.
- Examine tires carefully (the spare tire as well), and replace those that are worn. Check tire pressures.
- The brakes, front wheel alignment, and steering gear should be checked by your Volvo dealer only.
- Check all lights, including high beams.
- Reflective warning triangles are a legal requirement in some countries.
- Have a word with your Volvo dealer concerning engine adjustments if you intend to drive in countries where it may be difficult to obtain correct fuel.

City driving

City driving can be a severe driving condition. Low operating speeds, long periods of idling combined with high operating temperatures, air conditioning usage, etc. will make necessary more frequent servicing (at least every third month).

pg. 56 Vehicle storage

If you do not intend to use your car for a long time

The following points may be of use if you do not intend to use your car for a long time (e.g. because of a long holiday, winter, etc.)

- Fill fuel tank to prevent water from condensing inside the tank.
- Wash the car carefully and wax it to protect the paint - don't forget the chromed parts.
- The vehicle should be left in a dry, well ventilated garage.
- Do not apply the hand brake. Block the wheels instead.
- Make sure that no electrical devices are switched on (e.g. lights, radio, engine compartment light, trunk light, interior lighting, etc.) The clock uses very little current - but, if you wish, you can remove

fuse number 5 to disconnect it. See "Fuses" section.

- Lift the wiper arms away from the windshield.
- Increase tire pressure to maximum allowed, i.e. 36 psi.
- Open one of the windows slightly for ventilation.
- Ensure that the coolant contains sufficient anti-freeze to provide protection down to -22°F (-30°C). Volvo anti-freeze also provides resistance against corrosion.
- Remove all valuables and lock the car.
- Check the battery voltage at least every 6 weeks.



[Contents](#) | [Top of Page](#)

1 9 8 5 VOLVO 740 GL, GLE, Turbo

Wheels and tires

pg. 57 Wheels and tires

The handling and riding comfort of the vehicle is dependent on the inflation pressure and the type of tires fitted. Read the following pages carefully.

General	57
Tread wear indicators	58
Tire wear	59
Inflation pressures	59

General information

Your vehicle is equipped with 6 x 15" or 14" wheel rims and 185/70 R14 (GL, GLE) or 195/60R15 (Turbo) tires.

In other words the width of the wheel rim is 6 inches and its diameter 15 inches.

The tire designation is coded as follows:

185 or 195 = tire width in mm.

70 or 60 = tire profile. This is the relationship in percent between the section height and width of the tire.

R = radial tires.

14 or 15 = suitable intended rim size.

The tires have good road holding characteristics and offer very safe handling on dry or wet surfaces - even at high speeds. It should be noted however that the tires have been developed to this performance on snow-free surfaces. For optimum road holding on icy or snow covered roads = we recommend suitable winter tires.

When replacing tires, be sure that the new tires are the same size (designation), type (radial) and preferably from the same manufacturer, on all four wheels. Otherwise there is a risk of altering the car's road-holding and handling characteristics.

pg. 58 Wheels and tires

Wear indicator

The tires have a so-called "wear indicator" in the form of a number of narrow strips running across or parallel to the tread. When approx. 1/16" (1.5 mm) is left on the tread, these strips show up and indicate that the tire should be replaced.

Tires with less than 1/16" (1.5 mm) tread have a very poor grip in rain or snow.

When replacing worn tires, it is recommended that the tire be identical in type (radial) and size as the one being replaced. Using a tire of the same make (manufacturer) will prevent alteration of the driving characteristics of the vehicle.

To improve tire economy:

- Maintain correct tire pressure.
- Drive smoothly: avoid fast starts, hard braking and tire screeching.
- Tire wear increases with speed.
- Do not change wheel location unless necessary.
- Correct front wheel alignment is very important.
- Unbalanced wheels impair tire economy and driving comfort.
- Hitting curbs can damage the tires and/or wheels permanently.

Flat spots

All tires become warm during use. After cooling, when the vehicle is parked, the tires have a tendency to distort slightly forming flat spots. These flat spots can cause vibrations similar to the vibrations caused by imbalanced wheels.

They do, however disappear when the tire warms up. The degree to which flat spots form depends on the type of cord used in the tire.

Remember that in cold weather, it takes longer for the tire to warm up and consequently longer for the flat spot to disappear.

Snow tires, studded tires, snow chains

Tires for winter use:

Use snow tires fitted to the standard 14" or 15" wheel rims or, alternatively, steel wheel rims designed for the 740. Suitable tire sizes: 185/70R14 (GL, GLE; on all four wheels) or 195/60R15 (Turbo; on all four wheels). No rims from other Volvo models can be used on the 740.

Do not mix tires of different design, as this could negatively affect overall tire road grip especially during slippery road conditions!

Studded tires should be run-in 300-600 miles (500-1000 km) during which the car should be driven as smoothly as possible to give the studs the opportunity to seat properly in the tires. The car tires should have the same rotational direction throughout their entire lifetime. In other words, if you wish to rotate the wheels, make sure that the same wheels are always on the same side of the car.

Tire **chains** can only be used on the rear wheels if the chains do not project too far from the tire and

chafe against the brake caliper or other components.

Strap-on emergency chains must not be used since the clearance between the brake caliper and the wheel rim is inadequate.

WARNING!

Special wheel rims for air dams

Only special wheel rims, tested and approved by Volvo, are suitable for use with the air dam installed on the 740.

pg. 59 Wheels and tires

Checking and correcting tire pressure

Check the tire pressure when refueling.

The tire pressure should be corrected only when the tires are cold. With warm tires, correct only when the pressure is too low. The tire temperature rises after driving just a few miles.

Vehicle Loading

The tires on your Volvo will perform to specifications at all normal loads when inflated as recommended on the tire information label located on the rear facing side on the right front door. This label lists both tire and vehicle design limits.

Do not load your car beyond the load limits indicated.

Tire Pressure Label

VEHICLE CAPACITY		OCCUPANTS			COLD TIRE PRESSURE	
WEIGHT		FRONT	REAR	TOTAL	FRONT	REAR
MAX. LOAD	1000	2	3	5	36	36
RECOMMENDED FOR FUEL ECONOMY						
OPTIONAL PRESSURE						
TIRE SIZE	185/70R14	2	1	3	28	28
IF THIS CAR MET FIVE STAR AND FIVE (5) STAR FUEL ECONOMY CRITERIA						
155 R 14		MAX. TIRE		MAXIMUM		40
						PSI
SEE OWNER'S MANUAL FOR ADDITIONAL INFORMATION						
VOLVO						





[Contents](#) | [Top of Page](#)

1 9 8 5 VOLVO 740 GL, GLE, Turbo

In case of emergency

pg. 60 In case of emergency

Even if you maintain your car in good running condition, there is always the possibility that something might go wrong and prevent you from driving, such as a punctured tire, blown fuse or bulb....

Special spare tire	61
Changing a wheel	62
Replacing bulbs	64
Replacing fuses	69
Replacing wiper blades	72
Troubleshooting	73

pg. 61 Spare tire



WARNING!

Current legislation prohibits the use of the "Special Spare" tire other than as a temporary replacement for a punctured tire. In other words, it must be replaced as soon as possible by a standard tire. Roadholding, etc., may be affected with the "Special Spare" in use. Do not, therefore, exceed 50 mph (80 km/h).

Special Spare

The spare tire of your car is what is called a "Special Spare". This is embossed on the tire. See illustration.

GL, GLE models have 14" wheels and Special Spare tire pressure 40 psi (280 kPa).

Turbo models have 15" wheels and Special Spare tire pressure 50 psi (350 kPa).

These pressures should be maintained irrespective of which position on the car the Special Spare tire is used on.

In the event of damage to this tire a new one can be purchased from your Volvo dealer.

pg. 62 Wheel changing



Changing a wheel

The spare wheel is located in the trunk, beneath the carpet.

Before using the jack, make sure the car is standing on firm, level ground. Apply the parking brake. On models with automatic transmission, place the transmission selector lever in position P. On models with manual transmission, place the gear-shift lever in 1st gear or reverse. Block the wheels standing on the ground with wooden blocks or large stones.

- Remove the wheel cap, using the screwdriver in the tool kit.
- With the car still on the ground, use the box wrench from the tool kit to loosen the wheel nuts 1/2 - 1 turn. Turn the nuts counterclockwise to loosen.

NOTE:

To avoid excessive wear and the necessity of rebalancing, mark and reinstall wheels in same location as before removal.

To lessen the chance of imbalance, each wheel hub is equipped with a guide stud to ensure that a removed wheel can be reinstalled in its original position (as when changing over to winter tires/wheels).

pg. 63 Wheel changing



There is a jack attachment adjacent to each wheel location. Hang the jack from the attachment as shown in the illustration and crank while simultaneously guiding the base to the ground. **Before raising the car check that the jack is still correctly positioned in the attachment.**

Now raise the vehicle until the wheel is free from the ground. Unscrew the wheel nuts completely and carefully remove the wheel so as not to damage the thread of the studs.

WARNING!

- Be sure the jack is on firm and level ground.
- Never allow any part of your body to be extended under a car supported by a jack.
- Use the jack intended for the car when replacing a wheel. For any other job, use stands to support the end of the car being worked on.
- Apply the parking brake, select position P (automatic transmission), or 1st gear or reverse (manual transmission).
- Block the wheels standing on the ground. Use rigid wooded blocks or large stones.
- The jack should be kept well-greased.

Installing the wheel

Clean the contact surfaces on the wheel and hub. Lift the wheel and place it on the hub. Make sure that you align the wheel with the guide stud on the wheel hub prior to installation. Install the wheel nuts

clockwise and tighten lightly. The bevelled side of the nuts should face the wheel. Lower the vehicle to the ground and alternately tighten the nuts to 63 ft. lbs. (85 Nm). Install the wheel cap. Some models have a hub cap that extends to the wheel rim. The valve symbol on the inside of the hub cap should be installed toward the valve.

pg. 64 Replacing bulbs

NOTE:
The method for replacement of bulbs in the various lighting units is shown on the following pages. Make sure when installing bulbs, that the guide pin on the socket fits into its corresponding recess. When installing Halogen bulbs, do not touch the glass with your fingers. The reason for this is that grease, oil or any other impurities can be carbonized onto the bulb and damage the reflector. Use bulbs of correct type and voltage. Failure to do so could cause the bulb failure warning light to activate.



Illust. 1



Illust. 2



Illust. 3



Illust. 4

Replacing sealed beam headlamp units

1. Squeeze the clip and pull it upwards.
2. Lift up the rim slightly and remove it forwards.
3. Remove Phillips screws and rim. Lift out the headlamp unit.
4. Disconnect the socket contact.

Installation is done by reversing the procedure.

Check headlight alignment.

pg. 65 Replacing bulbs



Replacing bulbs, front

Access to the bulbs is obtained from the engine compartment.

- 1 Switch off the lights and starting (ignition) key.
- 2 Do not remove the connector from the bulb holder. Turn the bulb holder slightly counterclockwise and withdraw the bulb holder and bulb.
- 3 Remove the bulb from the holder by pressing in and turning slightly counterclockwise.
- 4 Insert a new bulb and install the bulb holder.

NOTE! One of the tabs on the bulb holder is slightly wider than the other two.

- 5 Turn the bulb holder clockwise to secure it.

Check the bulb function.

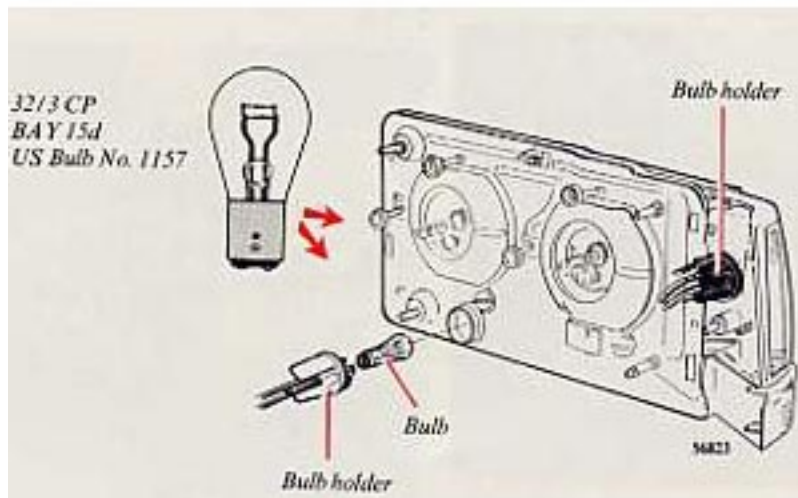

pg. 66 Replacing bulbs

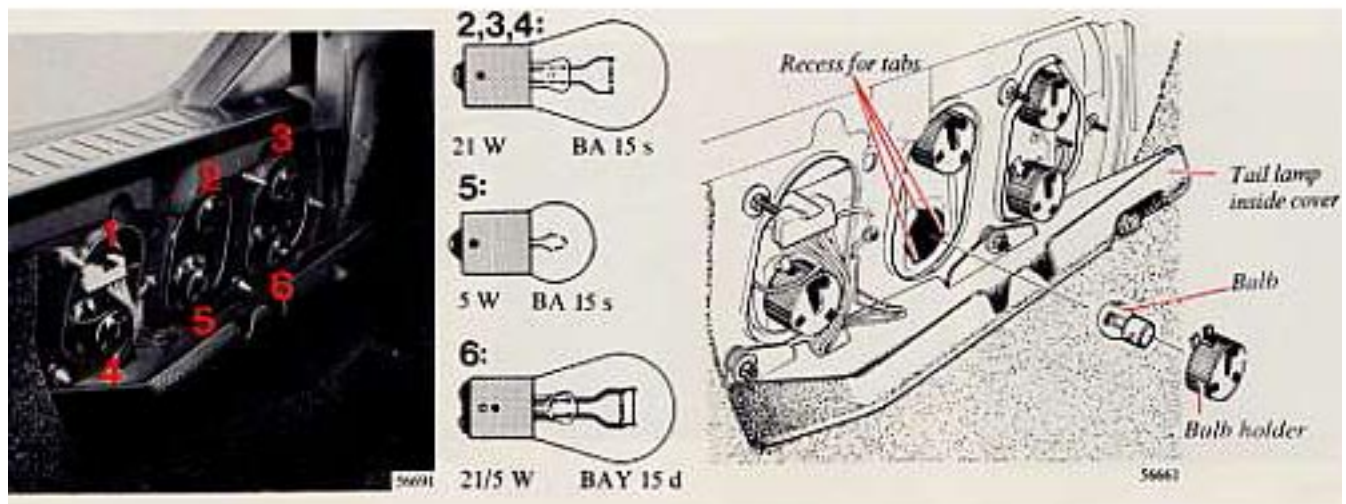

Replacing tail lamp bulbs

All tail lamp bulbs are replaced from inside of trunk.

1. Unscrew and remove tail lamp inside cover. Note that inside cover is hooked at the lower edge.
2. Turn bulb holder approx. 3/8" (1 cm) counterclockwise and remove it.
3. Depress bulb in bulb holder, turn it slightly counterclockwise, and remove it.
4. Install a new bulb. Install bulb holder in tail lamp. NOTE: One of the bulb holder tabs is wider and fits in corresponding recess only.
5. Turn bulb holder clockwise. Check that bulb lights. Replace tail lamp inside cover.

Bulbs	Power CP(W)	Socket	US Bulb No
-------	-------------	--------	------------

1 Reflector	-		
-------------	---	--	--

2 Back up light	32 (21)	BA 15s	1073
3 Rear turn signal	32 (21)	BA 15s	1073
4 Rear foglamp	32 (21)	BA 15s	1073
5 Tail light	4 (5)	BA 15s	67
6 Tail light/brake light	32/3 (21/5)	BAY 15d	1157

pg. 67 Replacing bulbs



License plate light

Slide the bulb housing backwards until it is released from the front edge. Pull out the lamp housing and replace the bulb. Insert the front edge of the lamp housing and press up the rear edge by hand.

Bulbs	Power	Socket
License plate light	5 W	W2.1 x 9.5d

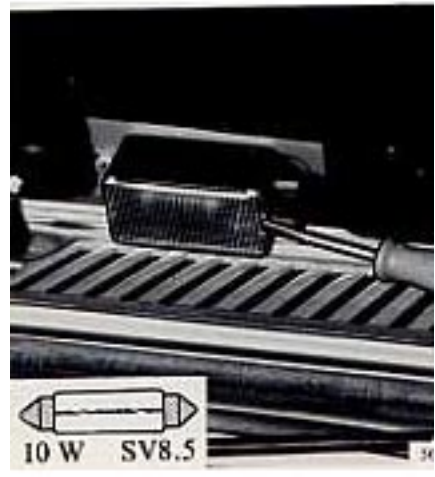

Engine compartment light

Insert a screwdriver and pry off the light assembly. Lift it out to remove.

Replace the bulb.

Bulbs

Engine compartment
light

Power Socket

10 W SV8.5



Trunk light

Depress the catch with a screwdriver and remove the light assembly. Lift it out to remove.

Replace the bulb.

Bulbs

Trunk
light

Power Socket

10 W SV8.5

pg. 68 Replacing bulbs



Interior light and reading lights

Take hold of the front section of the light as shown and pull straight down.
Replace the blown bulb and check operation before installing the bulb housing.

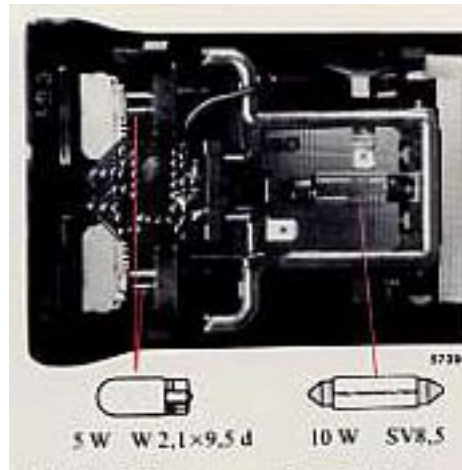

Bulbs	Power	Socket
Interior light	10 W	SV8.5
Reading light	5 W	W2.1x9.5d

pg. 69 Fog lights, Fuses

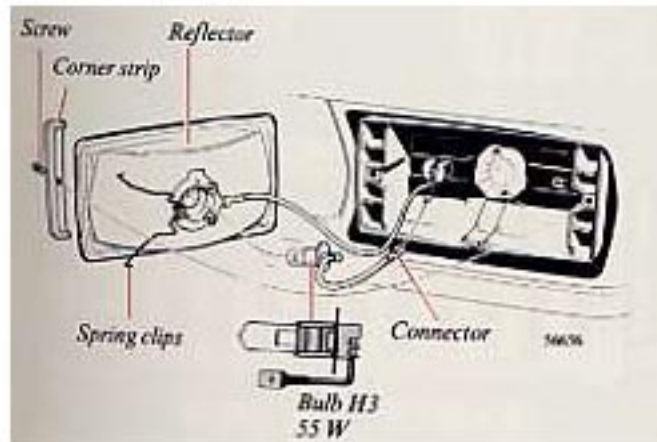

Fog lights (certain models)

Remove the Phillips screws securing the corner strips and pull out the reflector.
Remove the spring clips holding the bulb. Withdraw the connector and install a new bulb. Replace parts in the reverse order. Observe "TOP" on the lens.

NOTE: Do not touch bulb glass with fingers. Grease or oil can damage reflector when heated.

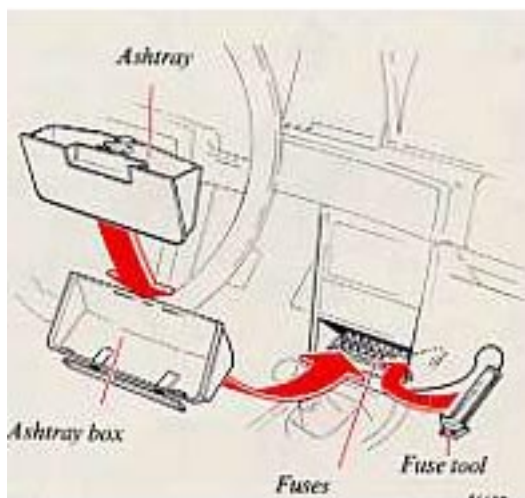

Fuse replacement

A blown fuse is indicated by the failure of all the units protected by it, and it is caused by overloading the circuits. The fuses (and relays) are located in the central electrical unit behind the ashtray in the center console.

To obtain access to the central electrical unit:

- Remove the ashtray. Pull out and depress the tongue.
- Press up the section marked "electrical fuses-press " and remove the unit.

There are 26 fuses in two rows. See [page 71](#) for fuse designations/locations.

pg. 70 Fuses

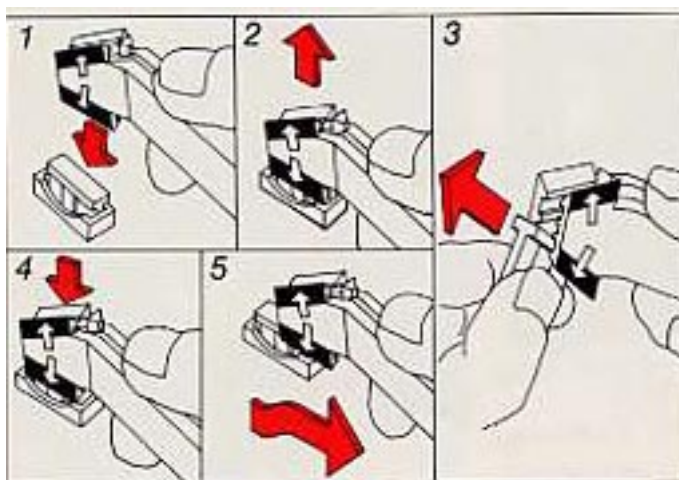

Fuse replacement (cont.)

It is necessary to remove the fuses to see if they are blown, see next page for information on fuses and related circuits.

If you find it difficult to obtain access to the fuses, unclip the fuse tool on the right-hand side of the fuse compartment and use it to remove the fuse, see illustration.

- 1 Press the tool onto the fuse.
- 2 Pull the tool and fuse straight up.
- 3 Pull out the fuse from the tool and push in a new fuse in the same way.
- 4 Push in the fuse in the fusebox with the tool.
5. Slide the tool out.

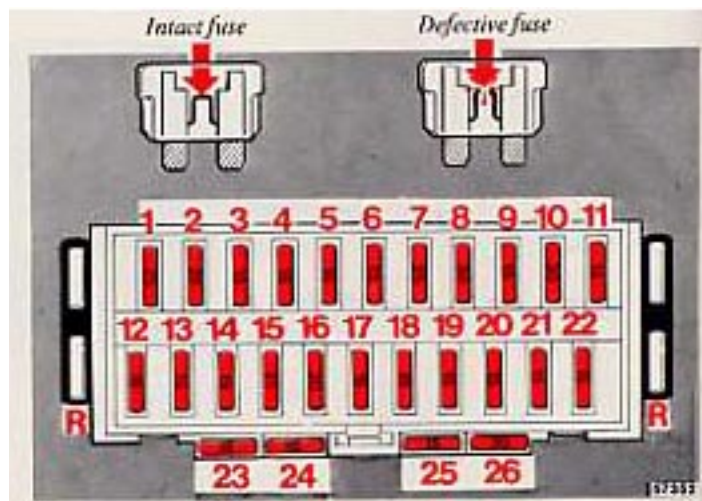

The fuses are removed by pulling them straight out. If they are defective, the metal wire is broken. When fitting a new fuse, be certain to use one with **the same amperage and color** as the one removed (see top of fuse)! Spare fuses are located on each side of the fusebox (1x15A, 1x25A, 1x30A).

If fuses burnout repeatedly, have the electrical system tested by a Volvo dealer.

pg. 71 Fuses

Location	Amperage
1 Fuel pump, Fuel injection system	25
2 Central locking, Hazard warning flashers, Headlight flashers	25
3 Fog lights	15
4 Brake lights, Shift indicator light	15
5 Glove compartment light, Clock, Radio, Engine compartment light, Interior light, Trunk light, antenna, Door warning	15
6 Heated front seats	15
7 Electric cooling fan	25
8 Electrically operated windows	30

9 Warning light, Seat belt, Turn signals, Air conditioning, Heated front seats, Electric cooling fan, Electrically-operated windows	15
10 Heated rear window	30
11 Tank pump	15
12 Back-up lights, Cruise control, Overdrive(manual transmission), Disengagement of 4th gear on automatic transmission AW71	15
13 (Spare)	15
14 Electrically-operated side view mirrors, Cigarette lighter, Radio	15
15 Horn, Windshield wash/wipe	25
16 Heater blower, Air conditioning	30
17 High beam (left)	15
18 High beam (right), Extra lights	15
19 Low beam (left)	15
20 Low beam (right)	15
21 LH parking lights (front and rear), License plate light, Lighting for: ash tray, heater, control panel, switch for heated rear window	15
22 Seat belt light, RH parking lights (front and rear), Storage compartment behind parking brake, Fog lights	15
23 (Spare)	15
24 (Spare)	
25 Rear fog lights	15
26 (Spare)	30

For more detailed information concerning function and location of relays, fuses, etc., refer to the Volvo Service Manuals. These can be purchased directly using the Service Literature Brochure/Order Form or through your Volvo dealer.

pg. 72 Replacing wiper blades

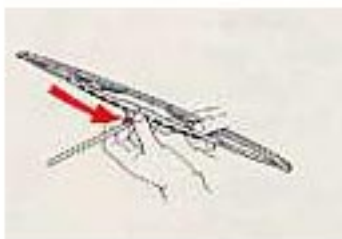

Replacing wiper blades

Lift the wiper arm off the windshield and hold blade at right angles to arm. Pinch the end of the plastic clip located at the back of the arm.

Slide the wiper blade along the arm to release it from the hook.



Install new blade (installation is the reverse of removal) and make sure that it is properly attached to the wiper arm.

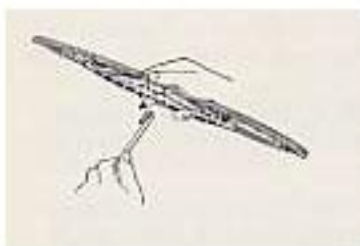

For reasons of safety, you should change the windshield wiper blades as soon as they start to leave marks on the windshield or fail to wipe efficiently and cleanly.

The wiper blades can be cleaned by using a stiff-bristle brush and warm, soapy water.

pg. 73 Service diagnosis

The diagnoses outlined below are intended to serve only as guides to locate and temporarily correct minor faults. Causes of unsatisfactory performance should be investigated and corrected by your Volvo dealer only.

NOTE: The items indicated by an asterisk(*) should be checked by your Volvo dealer only.

Condition: Starter fails to operate (or operates very slowly)

Possible cause

Correction

Weak battery or dead cell.

Loose or corroded battery cable terminals.

Open circuit between starting (ignition) switch and starting (ignition) switch terminal on starter.

Starter motor defective.

With the starting (ignition) switch in the "Driving" or "On" position, check to see if the warning lights on the dashboard come on and if they stay on when the starter is engaged.

If the lights do not come on or if they go off when the starter is engaged, the battery is discharged, or see below.

Check the battery terminals and clamps. Clean or replace if necessary. Check that the starter cable is secure at its terminals.

The ground strap, which connects the body to the rear of the engine, should also be checked for corrosion or looseness.

The circuit is closed if a clicking sound is heard from the starter when it is engaged. If no clicking sound is heard, check that the blue wire at the starter is secure. If still no clicking sound is heard, the starting (ignition) switch or the wire is defective.

If the above checks have been performed, and no fault is evident, the starter may be defective.

NOTE: In this case the headlight intensity will not decrease when the starter is engaged.

pg. 74 Service diagnosis

Condition: Starter motor operates but engine does not start

Possible cause

Intake system leaking.

No fuel reaching engine.

No spark

Spark plugs, high tension leads or distributor cap wet or defective.

Correction

Check vacuum hose connections at manifold and auxiliary air valve.

Check for fuel in the tank.

Check fuses No 1 and 11.

If there is no spark, check that the high tension lead from the coil to the distributor cap is connected and that the wires to the distributor and coil are connected.

Clean the parts with a dry cloth or spray with a moisture remover. Replace defective or worn parts.

If no fault is found following the above steps, contact your Volvo dealer.

Rest pressure incorrect

Test rest pressure and the fuel system for leaks.*
If no fault is found following the steps above, contact your Volvo dealer

* Should be checked by a Volvo dealer.

pg. 75 Service diagnosis

Condition: Erratic idle (misfiring)

Possible cause

Intake system leaking.

Spark plugs, high tension leads or distributor cap worn (defective)

Worn spark plugs.

Uneven compression.

Correction

Check vacuum hose connections at manifold and auxiliary air valve.

Clean distributor cap and leads, check the cap for cracks. Replace defective or worn parts.

Remove. Clean or replace spark plugs.

Test compression.*

Condition: Engine stalls at irregular intervals

Possible cause

Defective wires.

Intake system leaking. Check vacuum hose connections at manifold and auxiliary air valve.

Fuel filter clogged. Clean fuel tank filter and replace line fuel filter.

Correction

Check wire terminals at: fuel pump, fuse No. 1 and 11, coil, distributor, ignition switch and relays.

Condition: Misfiring at highway driving speed

Possible cause

Spark plugs fouled.

Correction

Drive the vehicle in a lower gear and keep the engine rpm higher for a few miles in order to remove carbon deposit on the spark plugs. If this procedure is not effective, clean or replace the spark plug.

Please be aware that misfiring spark plugs can cause damage to the catalytic converter.

* Should be checked by a Volvo dealer.

Condition: Low top speed, loss of power

Possible cause	Correction
Air filter clogged.	Check air filter.*
Throttle misadjusted.	Check that the throttle touches the high speed stop when the accelerator is fully depressed.*
Fuel filter clogged.	Clean fuel tank filter and replace fuel line filter.*

Condition: Excessive fuel consumption

Possible cause	Correction
Fuel lines leaking.	Check tightness.
Spark plugs worn.	Replace plugs.
Air filter clogged.	Check/replace.*
Oxygen sensor system faulty	Check for open circuit or other electrical fault. *

* Should be checked by a Volvo dealer.



[Contents](#) | [Top of Page](#)

1985 VOLVO 740 GL, GLE, Turbo

Car care

pg. 77 Car care

Car care includes not only maintaining the appearance of the car, but also protecting the car exterior from the effects of air pollution, rain and mud.

The rustproofing compound under the car should be checked regularly and, if necessary, damaged areas should be repaired.

The paintwork should also be touched up immediately, if damaged, to prevent rust formation.

Rustproofing	78
Paintwork damage	80
Washing the car	82
Cleaning the upholstery	84

pg. 78 Rustproofing

What causes rust

The two most common causes of rust to your car are:

The accumulation of road dirt and moisture in hard-to-get-at cavities and other areas under the car. The removal of paint and protective coatings on the outside of the car and underneath through damage by stones, gravel or minor accidents.

Several factors influence the speed at which corrosion will occur:

1. The length of time various parts of a car stay wet. Parts of the car filled with road dirt and water remain damp for long periods of time even after other parts have dried. Particular attention should be paid to the underside of the car and floor sections inside. The floor sections stay wet because moisture collects and remains under the floor matting. Drain holes located at the bottom of the doors can get clogged with dirt, trapping water inside the door and causing the door to rust through at the bottom.

2. Corrosion will be accelerated in areas of higher relative humidity, especially where temperatures often stay above the freezing point and where the atmosphere is affected by industrial pollution, or where salt is used for de-icing the roads.

Where parts of the car are covered with road dirt containing road salt, corrosion will be accelerated at lower relative humidity than if the surface were clean.

3. Increased temperature will cause an accelerated rate of corrosion of those parts of the car which are not well ventilated to permit quick drying.

4. Industrial pollution and the presence of salt will also accelerate the deterioration of paint finishes.

The foregoing identifies the need for every car owner to keep his or her car-particularly the underside-as clean and dry as possible and to repair any minor damage to paintwork and protective coating as soon as possible.

The need is more important in those areas where road salt is used for de-icing, the relative humidity is higher, air pollution is present, and temperatures regularly stay above freezing.

Rustproofing, inspection and touching-up

Your Volvo was carefully and thoroughly rustproofed at the factory. The underbody and wheelhousings were sprayed with a thick, durable rustproofing compound and the beams, internal cavities and end sections were sprayed with a low viscous, penetrating rustproofing agent.

There are two very effective methods of maintaining this protection:

- Keep your car clean.

Clean the underbody, wheelhousings and the edges of the fender using water at high pressure.

- Inspect and touch-up the rustproofing if necessary.

The invisible (internal) rustproofing

The invisible rustproofing (used for beams, internal cavities and end sections) must be retreated after not more than 3 years and, thereafter, every second year.

Bear in mind, if good results are to be obtained, these sections must be treated with a fine spray of Volvo-approved rustproofing compound at a workshop with the correct spraying equipment. Consult your local Volvo dealer.

pg. 79 Rustproofing

The visible rustproofing

You should check the visible (external) rustproofing at regular intervals (at least once a year). If it is necessary to touch-up the rustproofing, this should be done immediately to prevent moisture penetration. Wash and dry the car thoroughly before touching up. Use spray-on or brush-on rustproofing compounds. An oil can with a long flexible spout may be used for parts which are difficult to reach.

There are three different types of rustproofing compounds available:

- a. thin (ML), for seams under the car.
- b. thin (transparent) for visible pans.
- c. thick, for parts on the underbody and wheel housing which experience most wear.

Parts of the car which may need to be touched up and the rustproofing compound recommended are:

- visible welded seams and panel seams-(type b)
- underbody and wheel housings-(type c)
- hood-(type b)
- door hinges-(type b)
- hood hinges and locks-(type b).

After completion of all work on the vehicle, remove excess rustproofing compound with a cloth soaked in kerosene.

The sheet metal surfaces of the engine compartment are protected by a transparent wax-based rustproofing compound. The compound withstands normal washings without deterioration.

Mineral based solvents will, however, dissolve the compound, especially so if they contain emulgators. In such cases the wax protection should be renewed.

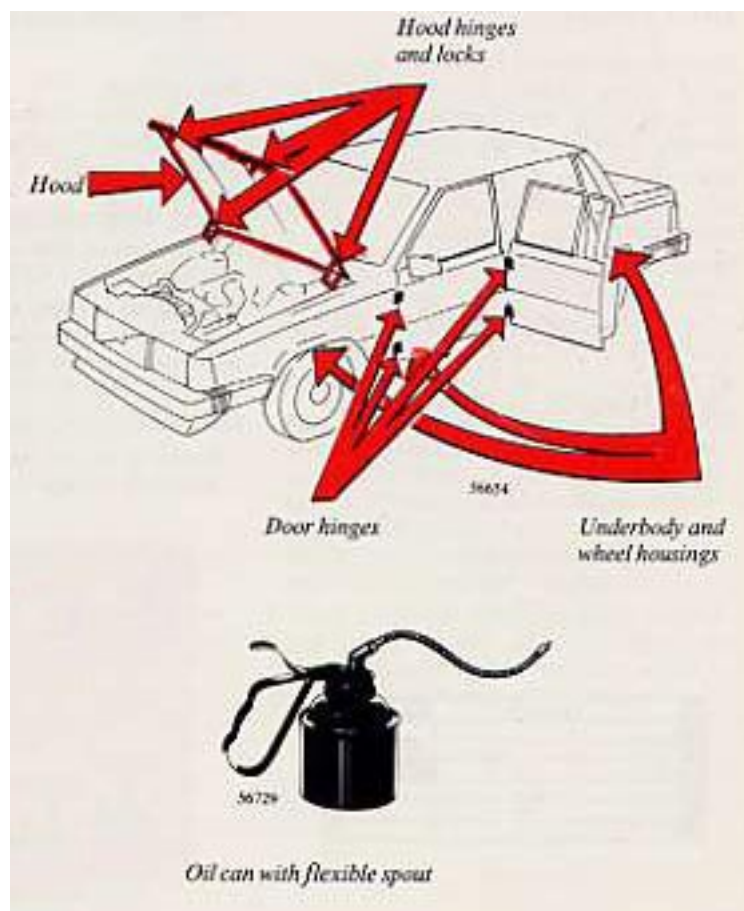

Paint touch-up

Paint damage requires immediate attention to avoid rusting. Make a habit of checking the finish regularly; when washing the car for instance. Touch up if necessary.

Paint repairs require special equipment and skill. Contact your Volvo dealer for any extensive damages. Minor scratches can be repaired by using Volvo touch-up paint.

NOTE: When ordering touch-up paint from your Volvo dealer, use the paint code indicated on the model plate. The plate is located on the panel above the right-side head lights.



Minor stone chips and scratches

Material:

Rust remover

Primer - brush-on type

Surface finish - brush-on type

Penknife or similar

Brush

NOTE:

When touching up the car, it should be well cleaned and dry and have a surface temperature about 60°F (+15°C).

Scars on the surface (where the paint has not been completely penetrated). Repairs can be made directly after light scraping to remove dirt.

Deep scars, (down to the bare metal):

1 Scrape or sand the damaged surface lightly and break the edges of the scar.



Apply the rust remover. (Avoid contact with eyes and skin!) Wait a few minutes and then rinse carefully with water and wipe dry.

2 Thoroughly mix the primer and apply it with a small brush.



When the primer surface is dry, the paint can be applied using a brush. Mix the paint thoroughly; apply several thin paint coats and let dry after each application.

pg. 81 Paint touch-up



3 If there is a longer scratch, you may want to protect surrounding paint by masking it off.

Touching up damaged paint on fender edges and sills

Material:

Rust remover

Primer - spray

Surface finish - spray

Sand paper (H 150 - 300 grit)

Thinner

NOTE: When touching up the car, it should be well cleaned and dry and have a temperature exceeding 60°F (+15°C).

Mask with tape and paper prior to painting larger surfaces. Remove the masking immediately after application of the last paint coat, before the paint starts to dry.

Touching up is as follows:

1. Remove paint flakes.

2. Sand the damaged surface and wash it clean with thinner.

Apply the rust remover. (Avoid contact with skin!). Wait a few minutes and then rinse carefully with water and wipe dry.

3. Shake the spray can for at least 1 minute. Spray on the primer. Move the can slowly and evenly back and forth over the spot and about 8-12 in. (20-30 cm) from the surface. Protect the surrounding surfaces with suitable paper.

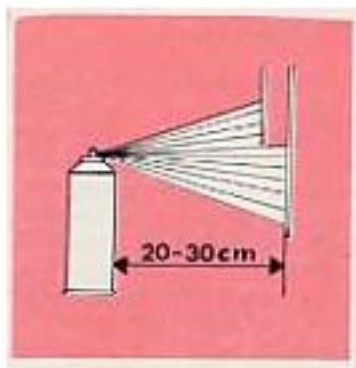

NOTE!

Spray painting should be done in a well ventilated and dust-free area.

4. When the primer has dried, apply the surface enamel in the same way. Spray on several times and allow the paint to dry a minute or so between each application.

Washing the car

The car should be washed at regular intervals since dirt, dust, insects and tar spots adhere to the paint and may cause damage.

When washing the car, do not expose it to direct sunlight. Use lukewarm water to soften the dirt before you wash with a sponge, and plenty of water, to avoid scratching.

A detergent can be used to facilitate the softening of dirt and oil.

A water-soluble grease solvent may be used in cases of sticky dirt.

However, use a washplace equipped with a drainage separator.

Dry the car with a clean chamois and remember to clean the drain holes in the doors and rocker panels.

Tar spots can be removed with kerosene or tar remover after the car has been washed.

After washing, lubricate the electrically-operated antenna mast with a cloth soaked in oil.

A stiff-bristle brush and lukewarm soapy water can be used to clean the wiper blades. Frequent cleaning improves visibility considerably.

NOTE: It is particularly important to wash the car frequently in the wintertime to prevent corrosion, when salt has been used on the roads. Also wash off the dirt from the underside (wheel housings, fenders, etc.)

In areas of high industrial pollution more frequent washing is also recommended.

Suitable detergents

Special car washing detergent or household detergent can be used. A suitable mixture is about 2.5 fl. oz. (8.5 cl) of detergent to 2.6 US gal. (10 liters) of warm water. After washing with a detergent the car should be well rinsed with clean water.

Bird droppings

Remove from paintwork as soon as possible. Otherwise the finish may be permanently damaged.

CAUTION!

When the car is driven immediately after being washed, apply the brakes a few times in order to remove any moisture from the brake linings.



NOTE: When washing the car, remember to remove dirt from the drain holes in the doors and sills.

pg. 83 Automatic car washing, Polishing and waxing, Chromed parts

Automatic washing - simple and quick

An automatic wash is a simple and quick way to clean your car, but it is worth remembering that it can never be as thorough as when you yourself go over the car with sponge and water. Keeping the underbody clean is most important, especially in the winter. Some automatic washers do not have facilities for washing the underbody.

Before driving into an automatic wash, make sure that side view mirrors, auxiliary lamps, etc., are secure, otherwise there is risk of the machine dislodging them. You should also lower the antenna. Use automatic washers with clean brushes only. We recommend that you do not wash your car in an automatic wash during the first six months (because the paint will not have hardened sufficiently).

Bear in mind that an automatic wash is never as good as a manual wash.

Polishing and waxing

Normally, polishing is not required during the first year after delivery, however, waxing may be beneficial.

Before applying polish or wax the car must be washed and dried. Tar spots can be removed with kerosene or tar remover. Difficult spots may require a fine rubbing compound. After polishing use liquid or paste wax.

Several commercially-available products contain both polish and wax. Waxing alone does not substitute for polishing a dull surface. A wide range of polymer-based car waxes can be purchased today. The waxes are easy to use and produce a long-lasting, high-gloss finish that protects the bodywork against oxidation, road dirt and fading.

Chromed parts

Chromium-plated and anodized parts should be washed with clean water as soon as they become dirty. This is particularly important if you drive on gravel roads or on roads where salt is used during the

winter. After the car has been washed, apply wax or an anti-rust preparation.

Stains on chrome trim can be removed with commercially-available chrome cleaner. Do not use abrasive compounds or steel wool.

pg. 84 Cleaning the upholstery

Cleaning the upholstery

Generally, the **fabric** can be cleaned with soapy water or a detergent. For more difficult spots caused by oil, ice cream, shoe polish, grease, etc., use a stain remover.

The **plastic** in the upholstery can be washed.

To clean **leather upholstery**, use soft cloth and mild soap solution, using, for instance, common bath soap.

For more difficult spots, consult an expert for the choice of cleaning agent.

On no account must gasoline, naphtha or similar cleaning agents be used on the plastic or the leather since these can cause damage.

As it ages, leather changes appearance, but the typical texture remains. To preserve smoothness and appearance, it is recommended to treat the leather with a special leather preservative after one or two years of use.

Cleaning the seat belts

Clean only with lukewarm water and mild soap solution.

Cleaning floor mats

The floor mats should be vacuumed or brushed clean regularly, especially during the winter when they should be taken out for drying. Spots on textile mats can be removed with a mild detergent.

Bear in mind

- Take extra care when removing stains such as ink or lipstick since the coloring can spread.
- Use solvents sparingly. Too much solvent can damage the seat padding.
- Start from the outside of the stain and work toward the center.



[Contents](#) | [Top of Page](#)

1985 VOLVO 740 GL, GLE, Turbo

Volvo Service

pg. 85 Service - an investment!

An investment which will pay dividends in the form of improved reliability, durability, and resale value.

Maintenance schedule	86
Volvo service	88
Engine compartment	89
Engine oil	91
Exhaust Emission Service	93
Automatic transmission fluid	99
Rear axle oil	100
Power steering fluid, brake fluid	101
Lubrication, body	102
Coolant	103
Drive belts	104

pg. 86 Servicing

1985 MAINTENANCE SCHEDULE 740

A= Adjust (Correct if necessary)

R= Replace

I= Inspect (Correct or Replace if necessary)

L= Lubricate

Maintenance Operation	Miles	600-1,200	7,500	15,000	22,500	30,000	37,500	45,000
	(Km)	(1,000-2,000)	(12,200)	(25,000)	(37,500)	(50,000)	(62,500)	(75,000)
EMISSION SYSTEM MAINTENANCE								
Engine oil and Oil filter ¹	R	R	R	R	R	R	R	R
Cooling System Hoses and Connections	I							
Engine Drive Belts	A					I		
Torque Manifold Nuts	A							
Valve Clearance						I		
Vacuum Fittings, Hoses and Connections	I							
Air Cleaner Filter						R		
Spark Plugs						R		
Fuel System Cap, Tank, Lines and Connections	I							
Torque Catalytic Converter Mounting Bolts	A							
Automatic Transmission Oil	I	I	I	R	I	I	R	
Manual Transmission Oil	R	I	I	I	I	I	I	
Rear Axle Oil	R	I	I	I	I	I	I	
Timing Gear Belt	A							R ²

1) Oil and oil filter cartridge are first changed at 600-1,200 mile (1,000-2,000 km) inspection. Subsequent oil and filter changes should be made at 7,500 miles (12,500 km) intervals or **at least every sixth months, twice as often for Turbo engine**. However, adverse conditions such as high ambient temperatures, trailer towing, hill climbing, driving long distances at high speeds, extended periods of idling or low speed conditions, short trip operation at freezing temperatures require oil changes more frequently (every third month).

2) Not included in emissions system maintenance but we recommend that the camshaft drive belt be replaced every 45,000 miles (75,000 km).

Maintenance beyond 45,000 miles (75,000 km)

For service intervals beyond 45,000 miles (75,000 km) refer to the Maintenance Service Schedules

Chart provided with your vehicle.

pg. 87 Servicing

1985 MAINTENANCE SCHEDULE 740

A= Adjust (Correct if necessary)

R= Replace

I= Inspect (Correct or Replace if necessary)

L= Lubricate

Maintenance Operation	Miles	600- 1,200	7,500	15,000	22,500	30,000	37,500	45,000
	(Km)	(1,000- 2,000)	(12,200)	(25,000)	(37,500)	(50,000)	(62,500)	(75,000)
MISCELLANEOUS MAINTENANCE								
ENGINE								
Engine Coolant						R		
Fuel (Line) Filter								
PCV Nipple (Orifice)				2		2		2
Ventilation Hoses								
BRAKES								
Inspect Brakes. Replace components as necessary.				I		I		I
Change Brake Fluid ¹						R		
STEERING								
Tire Wear (Align front end if needed.)				I		I		I
Check power steering fluid level.	I	I	I	I	I	I	I	I
BODY								
Trunk, Hood Hinges and Latches.				L		L		L

1) For detailed information, see [page 101](#).

2) Volvo recommends the flame guard be cleaned every 15,000 miles (25,000 km).

The following items should be checked weekly by the driver (it takes only a few moments):

- Engine oil level
- Brake fluid level
- Radiator coolant level
- Tire pressure (all five tires)
- Operation of all lights
- Horns
- Windshield wipers
- Level of windshield washer fluid

The following should also be carried out at regular intervals:

- Washing
- Polishing
- Cleaning
- Rust protection

pg. 88 Maintenance service

MAINTENANCE

Maintenance services

Your Volvo has passed two major inspections before being delivered to you, according to Volvo specifications. After being driven 600-1,200 miles (1,000-2,000 km), your car should be brought to the Volvo dealer for a service inspection. Engine, manual transmission and rear axle oils will be changed at this time.

Following this inspection, the maintenance inspections outlined in this book should be performed every 7,500 miles (12,500 km), or every 3,750 miles (6,250 km) on Turbo models.

The extended maintenance inspection intervals make it even more advisable to follow this program. Inspection and service should also be performed any time a malfunction is observed or suspected. It is recommended that receipts for vehicle emission services be retained in the event that questions arise concerning maintenance. See your "Maintenance Records Manual".

Maintenance inspection at 7,500 miles (12,500 km) intervals

Volvo advises you to follow the inspection program at 7,500 miles (12,500 km) intervals (3,750 miles or 6,250 km on Turbo models) which is outlined in the "Maintenance Records Manual". This maintenance program contains inspections and services necessary for the proper functioning of your car over the next inspection interval.

The maintenance inspections contain several checks which require special instruments and tools and therefore must be performed by a qualified technician.

To keep your Volvo in top condition, specify time tested and proven Genuine Volvo Parts and Accessories.

The Federal Clean Air Act (USA)

The Clean Air Act requires vehicle manufacturers to furnish written instructions to the ultimate purchaser to assure the proper functioning of those components that control emissions.

The maintenance instructions listed in the "Servicing" section of this Manual represents the minimum maintenance required. These services are not covered by the warranty. You will be required to pay for labor and material used. Refer to your Warranty booklet for further details.

In accordance with Federal Regulations your Volvo is warranted to meet certain Emission Performance Standards. Refer to your Warranty booklet for detailed information.

- Emissions Performance Warranty (USA)
- Limited 5-year/50,000-mile Emission System Warranty (USA)
- 5-year/80,000-kilometer Emission System Warranty (Canada)

pg. 89 Engine Compartment

740 GL, GLE (B230F Engine)

- 1 Data plate
- 2 Expansion tank, coolant
- 3 Oil filler cap, engine
- 4 Oil dipstick, engine
- 5 Brake fluid reservoir
- 6 Oil reservoir, power steering
- 7 Washer fluid reservoir
- 8 Battery
- 9 Engine identification label

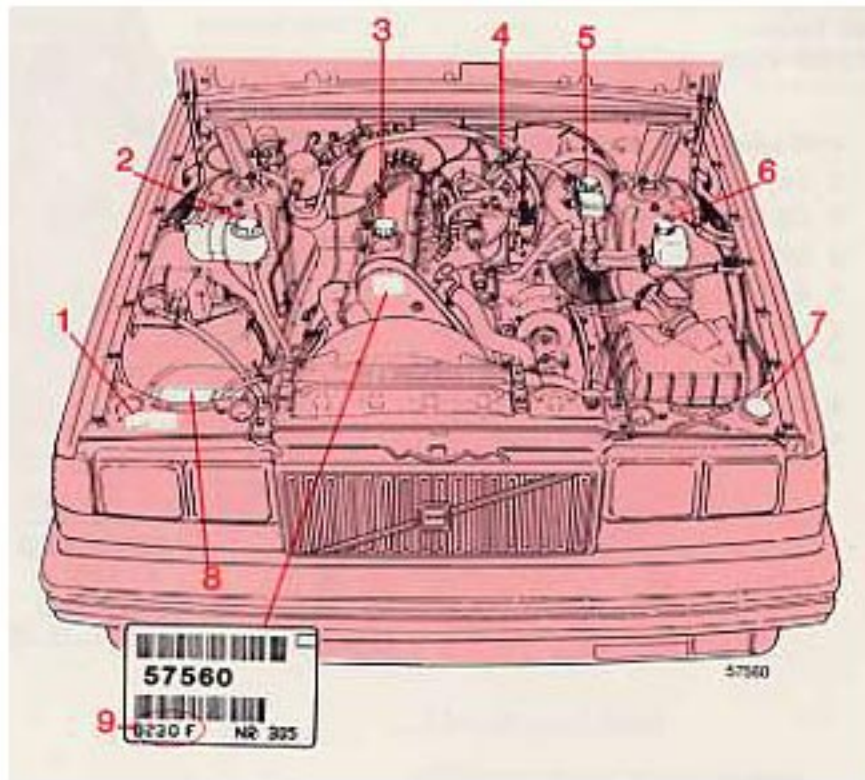

pg. 90 Engine Compartment

740 Turbo

(B230F-Turbo Engine)

- 1 Washer fluid reservoir
- 2 Expansion tank, coolant
- 3 Oil filler cap, engine
- 4 Oil dipstick, engine
- 5 Brake fluid reservoir
- 6 Oil reservoir, power steering
- 7 Battery
- 8 Data plate
- 9 Engine identification label

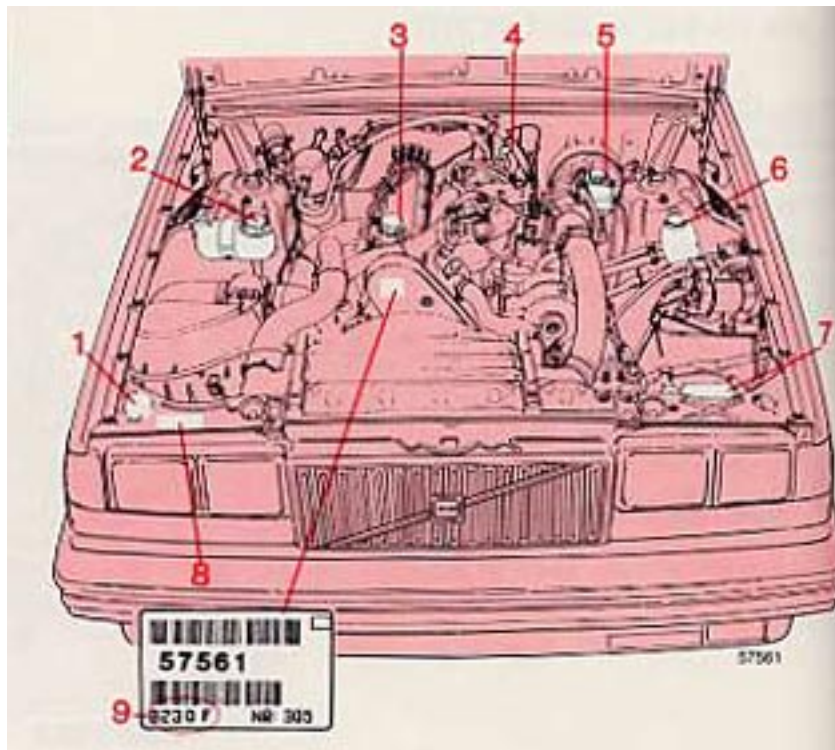

pg. 91 Engine Oil

Checking the oil level

The oil level should be checked each time you refuel. Be sure the oil level is maintained between the upper and lower marks on the dipstick. Low oil level can cause internal damage to the engine and overfilling can result in high oil consumption. The distance between the dipstick marks represents approx. 1 US qt (1 liter) of oil.

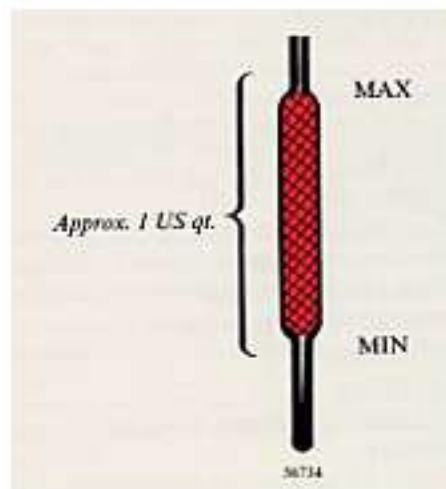

Draining the oil

Drain the oil after driving while it is still hot.

WARNING!

The oil may be very hot.

To add or change engine oil

Add oil of the same kind as already used. Capacity: 4.0 US qts = 3.85 liters incl. oil filter.

After an oil change, the oil level will lie between the two marks on the dipstick i.e. between MAX and MIN. This is normal. Do not add too much oil or excessive oil consumption will result.

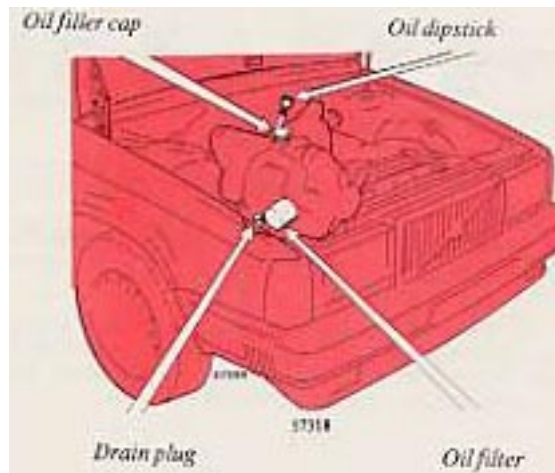

Changing oil Filter

Replace the oil filter at every oil change.

pg. 92 Engine Oil

Oil quality

Meeting API specification SF(CCMC class G2)

Oils with designations SF/CC and SF/CD comply with these requirements.

Viscosity (stable ambient temperatures):

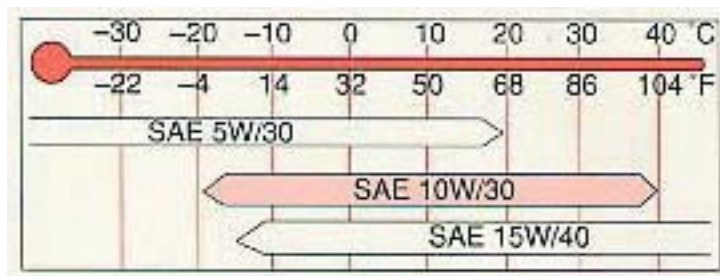

SAE 15W/40 oil is recommended for use in severe driving conditions that increase oil consumption and raise oil temperatures (e.g. mountain driving with frequent decelerations, or fast highway driving). Note, however, the higher temperature range of 15W/40 oil.

Volvo recommends the use of fuel-economy-improving oils. When using these oils, the Volvo recommended oil change intervals must be followed.

Synthetic or semisynthetic oils may be used if their specifications comply with the oil quality requirements.

Volvo does not recommend additional oil additives, as they can adversely affect the engine.

Changing oil and oil filter

Oil and oil filter are first changed at the 600-1,200 mile (1,000-2,000 km) service. Thereafter, changes should be made as specified by this table:

Driving conditions	Oil and oil filter change interval
<p>Severe conditions such as:</p> <ul style="list-style-type: none"> • Extended periods of idling and low-speed operation • Short trip operation at freezing temperatures • Long periods of driving in dusty or sandy areas • Trailer hauling • Hill climbing • Driving long distances at high speed 	<p>740 GL, GLE Every 7,500 miles (12,500 km) or every third month whichever comes first.</p> <p>740 Turbo Every 3,750 miles (6,250 km) or every third month whichever comes first.</p>
<p>Normal conditions, that is conditions not mentioned above</p>	<p>740 GL, GLE Every 7,500 miles (12,500 km) or every sixth month whichever comes first.</p> <p>740 Turbo Every 3,750 miles (6,250 km) or every sixth month whichever comes first.</p>

Torque exhaust manifold nuts

The manifold nuts should be torqued at the 600-1,200 mile (1,000-2,000 km) inspection. A loose

manifold could alter air/fuel ratio and cause an increase in emissions and/or poor driveability.

Valves

The valve clearance should be checked and, if necessary, adjusted every 30,000 miles (50,000 km).

Air cleaner

Replace the air cleaner cartridge with a new one every 30,000 miles (50,000 km). The cartridge should be replaced more often when driving under dirty and dusty conditions. The filter cannot be cleaned and, therefore, should always be replaced with a new one.

Vacuum fittings, hoses and connections

Unstable idle, misfiring, or poor emission control is often caused by leaking vacuum hoses or connections. Check hoses and connections on distributor vacuum unit, connections on heater control servo systems and hydraulic brake servo.

Checking and adjusting idle speed

Your Volvo is equipped with an electronically-controlled idle speed system that requires no checking or adjustment.

Fuel system cap, tank and lines, and connections

The effectiveness of the fuel system to contain hydrocarbons is dependent largely on a leak-free system. Check for proper sealing of gasoline filler cap which contains "O" ring-type seals. Check all evaporative hoses in vehicle for tightness. Check fuel lines under vehicle and repair if necessary.

Fuel (line) filter

The fuel filter is located next to the fuel pump. This filter is to be changed every 60,000 miles (100,000 km). The Filter is replaced as one complete unit. Replace more frequently if contaminated fuel is introduced into the tank (or if there is reason to suspect that this has occurred).

Timing Gear Belt

The timing gear belt should be adjusted at the 600-1200 mile (1000-2000 km) inspection .We recommend the belt be replaced every 45,000 miles (75,000 km).

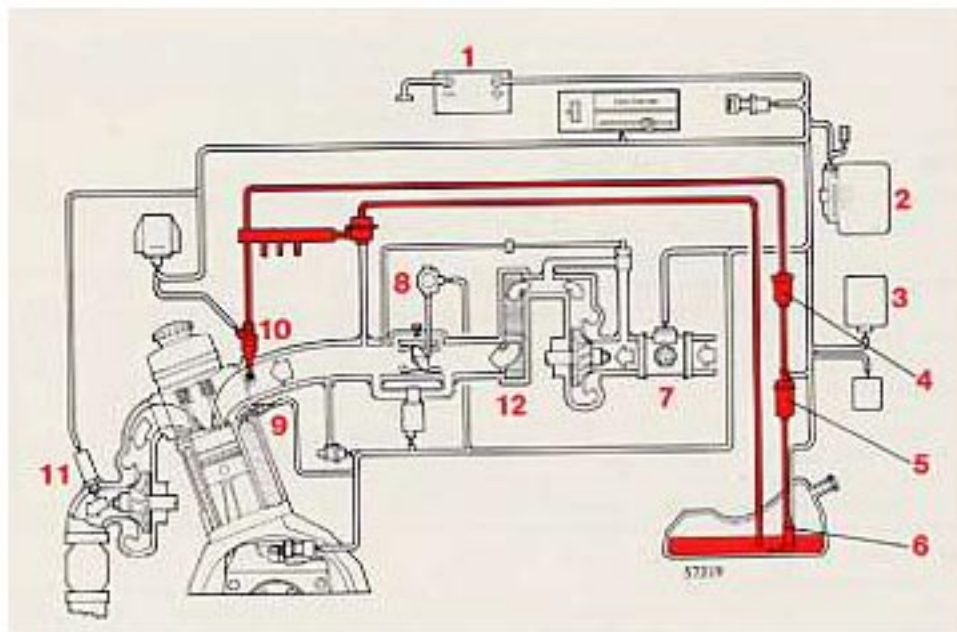

- 1 Battery**
- 2 Injection control unit**
- 3 Ignition control unit**
- 4 Fuel filter**
- 5 Fuel pump**
- 6 Fuel feed pump**
- 7 Air mass meter**
- 8 Throttle switch**
- 9 Temperature sensor**
- 10 Injector**
- 11 Oxygen sensor**
- 12 Intercooler**

LH Jetronic 2.2 fuel system

The B230F engine (740 GL, GLE) and the B230F-Turbo engine (740 Turbo) both have the same type of fuel-injection system.

The LH Jetronic 2.2 fuel injection system is all-electronic and is microprocessor-controlled. It can continually compensate for variations in engine load, speed and temperature to give the best economy and power. The most unique feature of the system is an air mass meter that measures the mass of the inducted air instead of the volume. In this way the system can make instantaneous adjustments for changes in air temperature or density, thus always assuring the best economy with the lowest possible exhaust emission.

Lambda-sond^{TN} (oxygen sensor) system

This is an emission control system designed to reduce emissions and improve fuel economy. An oxygen sensor monitors the composition of the exhaust gases leaving the engine. The exhaust gas analysis is fed into an electronic unit which continually influences the a frequency valve. This adjusts the air-fuel ratio to provide optimum conditions for combustion and efficient reduction of the three major pollutants (hydrocarbons, carbon monoxide and nitrous gases) by a 3-way catalytic converter.

pg. 96 Servicing

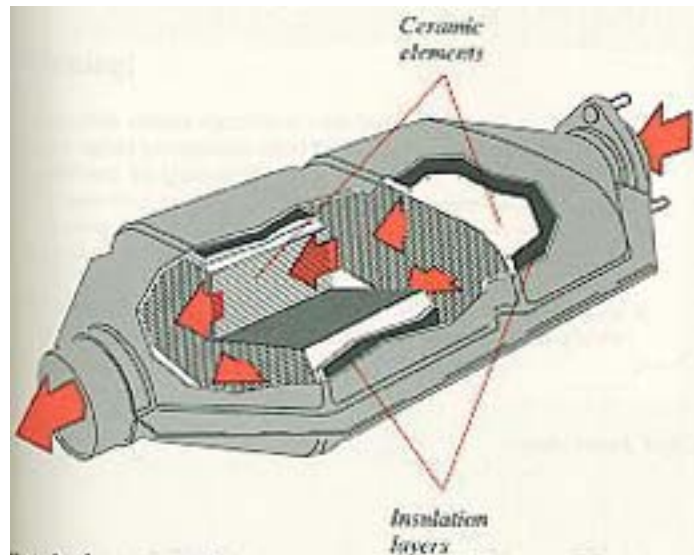

Catalytic converter

This is a supplementary device in the exhaust system, designed to clean exhaust gases. This device is mainly a container with a ceramic material insert, designed to let the exhaust gases pass through channels in the insert. The channel walls are covered by a thin layer of platina-palladium. These metals act as catalysts, permitting chemical reaction to occur without actually taking part in it. The emission (CO, HC, NOX) content will increase if the catalytic converter is damaged. Lambda-sond equipped vehicles use Catalytic Converters containing platinum and rhodium.

Torque Catalytic Converter mounting bolts

The Catalytic Converter mounting bolts should be torqued after the first 600-1,200 miles (1,000-2,000 km).

Caution: Vehicles with Catalytic Converter must use unleaded fuel only. Otherwise the Catalytic Converter will become ineffective. See "Fuel requirements".

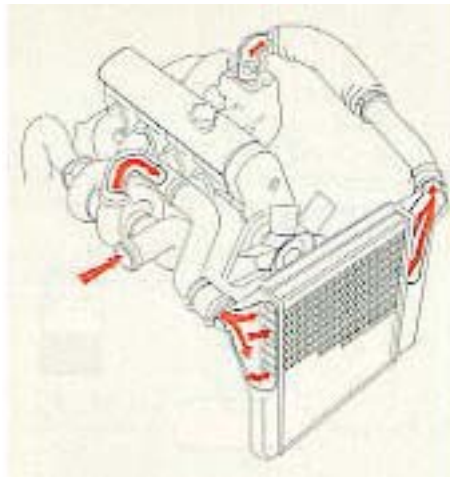

The Intercooler Boost System

The B230F-Turbo engine with the Intercooler Boost System employs a turbo-compressor to force air into the engine inlet manifold and the Intercooler Boost System to cool the compressed inlet air. The resulting increase in air flow raises pressure in the intake manifold by approx. 8 psi (over atmospheric pressure) and engine power output by approx. 50 horsepower over that developed by the normally-aspirated engine.

The intercooler (which resembles a radiator) is located between the turbo-compressor and inlet manifold.

pg. 97 Servicing

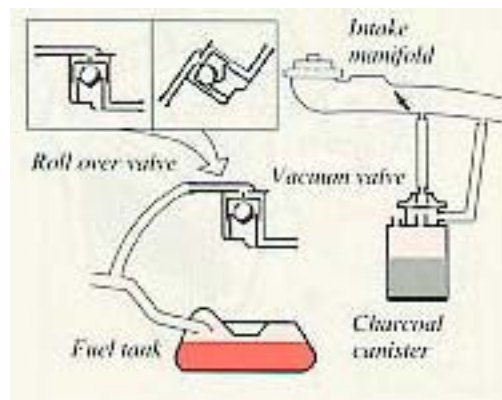

Evaporative control system

The 740 is equipped with a gas-evaporative control system, which prevents gasoline fumes from being released into the atmosphere.

The system is comprised of an expansion chamber in the fuel tank, a roll-over valve on the cross member in front of the fuel tank, and a charcoal canister with built-in vacuum valve under the left-front wheel housing.

The components are interconnected by hoses which channel fuel vapor from the gas tank to the charcoal filter, where it is stored until the engine is started and then drawn into the engine's fuel-induction system.

Crankcase ventilation

The engines equipped with positive crankcase ventilation which prevents crankcase gases from being released into the atmosphere. Instead, the crankcase gases are admitted to the intake manifold and cylinders.

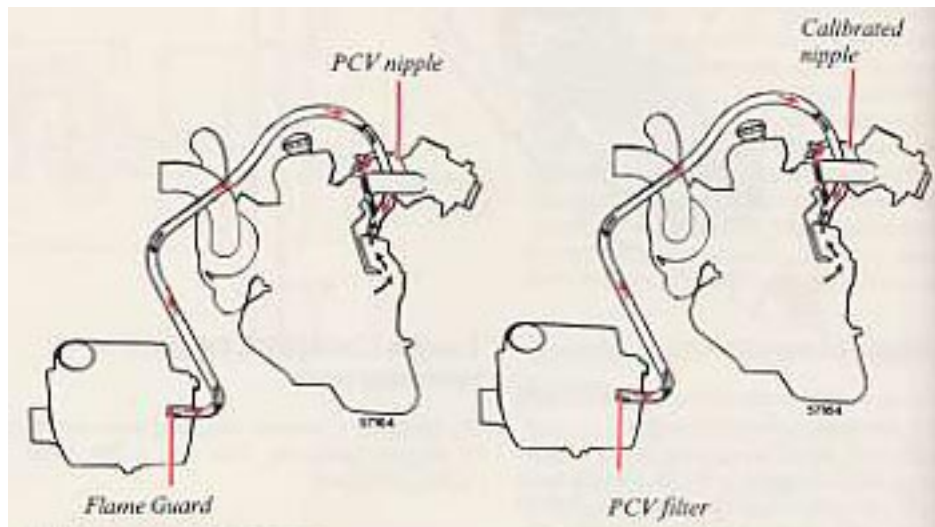

PCV system, 740 GLE (B230F engine)

The PCV nipple in the intake manifold should be cleaned every 60,000 miles (100,000 km). It is recommended that the flame guard be cleaned every 15,000 miles (25,000 km).

PCV system, 740 Turbo (B230F-Turbo engine)

The PCV nipple in the intake manifold and the filter at the end of the PCV hose in the air cleaner should be removed and cleaned after 60,000 miles (100,000 km).

Check/replace hoses at the same time.

pg. 98 Servicing

WARNING!

The ignition system operates at very high voltages. Special safety precautions must be followed to prevent injury. Always turn the ignition off when:

- Connecting engine test and diagnostic equipment to the vehicle (timing light, tach-dwell tester, ignition oscilloscope, etc).
- Replacing ignition components e.g. plugs, coil, distributor, HT leads etc.
- Do not touch any part of the ignition system while the engine is running. This may result in unintended movements and body injury.

Replacing spark plugs

The spark plugs should be changed every 30,000 miles (50,000 km).

However, city driving or fast highway driving may necessitate changing after 7,500 miles (12,500 km) of driving. When installing new plugs, be sure to fit the right type and use correct torque, see "Specifications". When changing the plugs, check that the suppressor connectors are in good condition. Cracked or damaged connectors should be replaced.

When changing spark plugs, clean the cables and cable terminals, also the rubber seals. If the car is driven on roads where salt is used during the winter, coat the cables with silicone.

Ignition timing

The ignition timing is set electronically and cannot be adjusted.

pg. 99 Manual transmission, rear axle

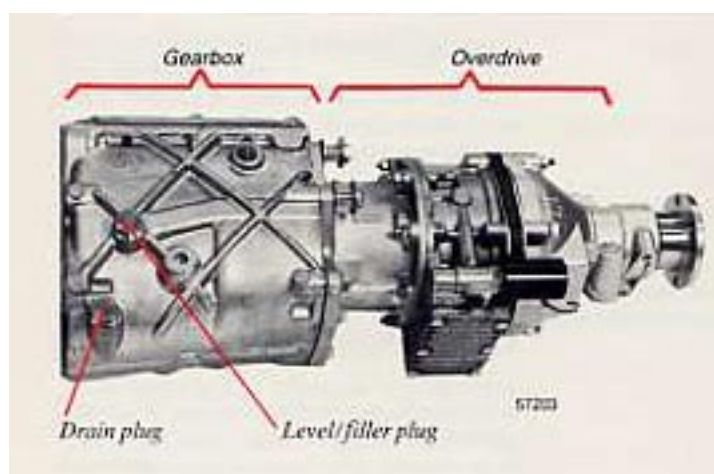

Manual transmission with overdrive (M46)

Capacity: 2.4 US qts (2.3 liters)

Fluid type: Automatic Transmission Fluid Type F or G (FLM). Engine oil (SAE 10W/40 or 10W/30) is recommended for use in areas where the temperature seldom drops below 14°F (-10°C).

Note! Do not mix ATF and engine oil.

Replace: at 600-1,200 mile (1,000-2,000 km) service only.

The oil level should be up to the filler plug. Drain the oil immediately after driving, while it is still hot, by removing plug.

Transmission and overdrive are lubricated by the same oil. Therefore, when the oil is drained through the drain plug, also remove cover on the overdrive and clean strainer.

Note: Refer to "Specifications" section of this manual for additional information on transmission.

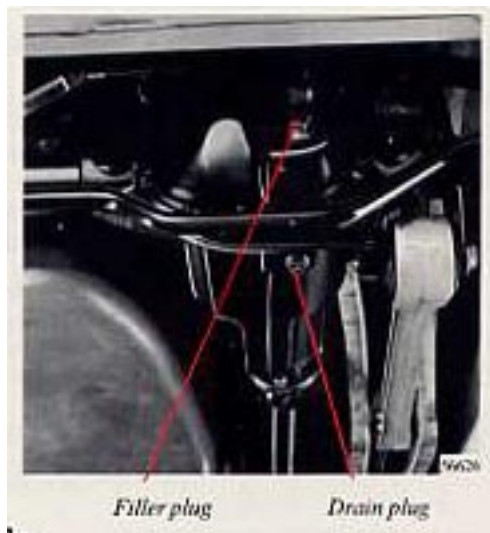

Rear axle

Capacity: 1.7 US qts (1.6 liters)

Oil type: API GL-5(MIL-L-2105 B or C).

Viscosity: SAE 90 or 80W/90.

Replace: at 600-1,200 mile (1,000-2,000 km)service only.

The oil level should be up to the filler plug.

Drain rear axle oil through drain plug.

When the temperature is consistently below 15°F (-10°C), use API GL-5 SAE80W oil.

pg. 100 Automatic transmission



Automatic transmission oil

Capacity: See "Specifications" section.

Fluid type: Automatic Transmission Fluid type Dexron IID.

Replace: Every 22,500 miles (37,500 km).

CAUTION!

Oil spilled on a hot exhaust pipe constitutes a fire risk.

A Cold transmission: **oil temperature +105°F (+40°C)**. This is a normal temperature for the transmission after idling for about 10 minutes.

At oil temperature below +105°F (+40°C), the level may be below the MIN mark.

B Warm transmission: **oil temperature +195°F (+90°C)**. This temperature is reached after driving for about 30 minutes.

At oil temperature above +195°F (+90°C), the level may be above the MAX mark.

NOTE:

The engine should be idling when checking transmission fluid level.

Check the oil level as follows:

Park the car on level surface with the engine idling.

Slowly move the selector lever through all the gear positions and then to position P. Wait 2 minutes before checking the oil level. As the illustration shows, the dipstick has a "Cold" and a "Warm" side. The oil level should be between the MIN and MAX marks.

Wipe the dipstick with a clean cloth. **CAUTION!** The oil may be very hot!

Do not use rags that could leave lint on the dipstick.

The transmission is topped up via the dipstick tube.

The space between the MIN and MAX marks on the dipstick corresponds to 0.5 US qt. (0.5 liter). Do not fill the transmission with too much oil, since this can result in oil being ejected from the transmission. Too little oil, on the other hand, can negatively affect transmission operation, particularly in very cold weather.

pg. 101 Brake and clutch fluids, Power steering fluid

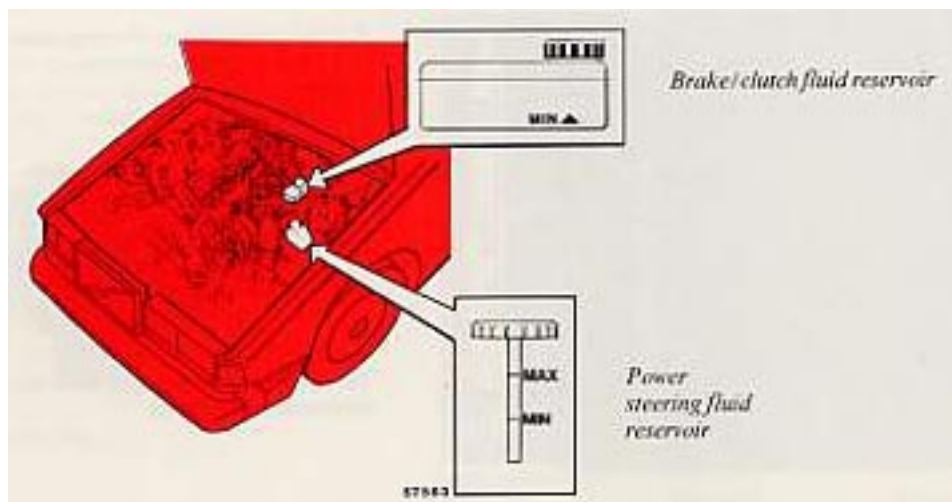

Brake and clutch fluids

(Note that some models have a clutch controlled by a cable.)

The fluid reservoir serves both the brake system and (where applicable) the clutch control system (with hydraulic control).

The fluid level should be above the MIN mark.

Fluid type: DOT 4

Replace: Every second year or 30,000 miles (50,000 km). The brake fluid should be replaced once a year or every 15,000 miles (25,000 km) when driving under extremely hard conditions (mountain driving etc.)

Check, without removing the cap, that the level is above the "MIN" mark of the fluid reservoir. Always entrust brake fluid changing to a Volvo dealer.

Power steering fluid

The fluid level should lie between the MIN and MAX marks on the dipstick (cool engine).

Check fluid level with engine idling and after driving while the fluid still is hot. Wipe the reservoir clean.

Fluid type: ATF

Replace: no fluid change required

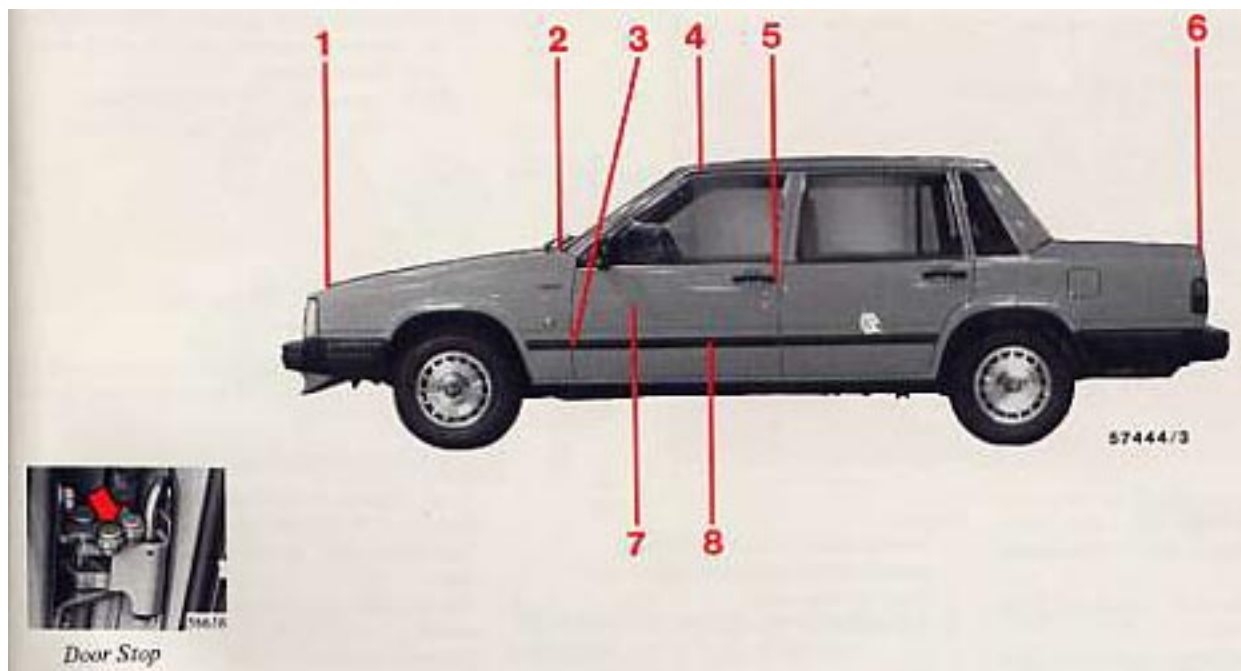

No. Lubricating point	Lubricant
1 Hood lock	Paraffin wax
2 Hood hinges	Oil
3 Door stop	Oil
4 Sunroof wind deflector	Oil
5 Door lock catch plate	Paraffin wax
6 Trunk lid lock	Lock oil
Key hole	Lock oil
7 Window regulator	Oil, grease
Locking device (on inside of door)	Silicone grease
8 Front seat slide rail and latch	Oil
9 Key hole	Lock oil
10 Striker plate	Paraffin wax

To avoid rattles and unnecessary wear, the body should be lubricated a few times per year.

Note!

During winter, locks and doors and trunk lid should be treated with special anti-freeze lubricant to prevent freezing.

pg. 103 Cooling system

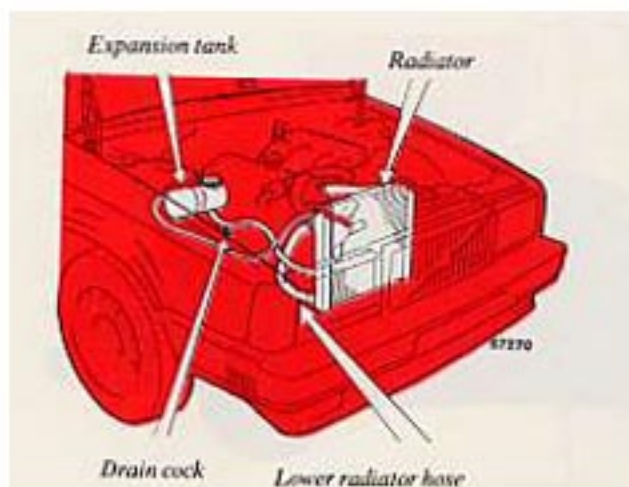

Check coolant level

The cooling system must be filled with coolant and not leak to operate at maximum efficiency. Check the coolant level when filling fuel. The level should be between the "MAX" and "MIN" marks on the expansion tank. The check should be made with particular thoroughness when the engine is new or when the cooling system has been drained.

Do not remove the filler cap other than for topping-up with coolant. Frequent removal may prevent coolant circulation between the engine and the expansion tank during engine warm-up and cooling.

Changing coolant

Every two years or 30,000 miles (50,000 km) the cooling system should be drained, flushed and refilled. Remove the expansion tank cap. Open the drain cocks on both sides of the engine block and disconnect the lower radiator hose.

Fill coolant through the expansion tank. The heater controls should be fully open when draining and filling.

Add coolant until the level is up to the MAX mark or slightly above.

Start engine and run until hot. Check the cooling system connections for tightness. Also re-check the coolant level.

Capacity: See "Specifications"

Coolant: Volvo coolant type C (blue green)

Caution!

The cooling system must always be kept filled to correct level. If it is not kept filled, there can be high local temperature in the engine which could result in damage.

Top up with coolant

Top up with coolant by filling the expansion tank when level is at the "MIN" mark. Use a mixture of 50 percent anti-freeze/summer coolant and 50 percent water all year round. Top up to the "MAX" mark.

If the engine is warm, and you are going to top up coolant, unscrew the cap slowly in order to allow any excess pressure to escape.

NOTE: Do not top up with water only. Water by itself reduces the rust-protective and antifreeze qualities of the coolant and has a lower boiling point. It can also cause damage to the cooling system if it should freeze.

pg. 104 Drive belt

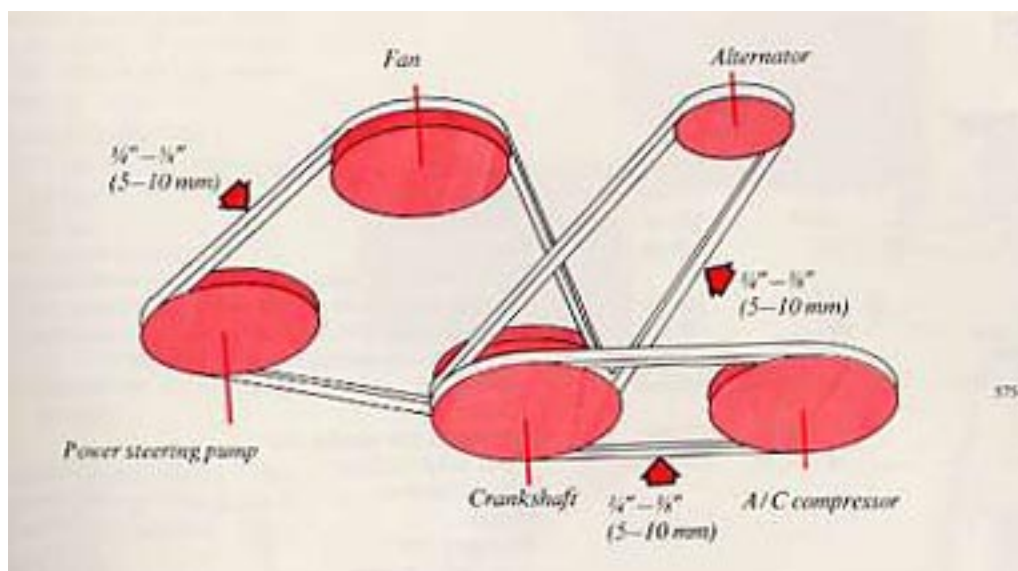

Checking the belt tension

The belt tension can be checked by depressing the fan belt (engine not running!) at a point midway between the alternator and fan. It should be possible to press down the belt about 1/4"-3/8" (5-10 mm). This also applies to other drive belts on the engine.

Belt check

Check the belts regularly to make sure they are in good condition and are clean. Worn or dirty belts can cause poor cooling and low alternator output as well as impair the operation of the power steering and the air conditioning unit.

Belt adjustment and replacement

The belts can be difficult to reach and it is advisable to let your Volvo dealer adjust the tension of the

belts or replace them if necessary.



[Contents](#) | [Top of Page](#)

1985 VOLVO 740 GL, GLE, Turbo

Specifications

pg. 105 Specifications

Dimensions and weights	740 GL, GLE 740 TURBO
Length	188.4" 478.5 cm
Width	68.9" 175 cm
Height	56.5" 143 cm
Wheelbase	109" 277 cm
Track:	
front	57.5" 146 cm
rear	57.5" 146 cm
Turning circle, between curbs	32.5 ft. 9.9 m
	See also section "Trailer hauling".
Gross Vehicle Weight (GVW):	
GL/GLE	3965 lbs. 1800 kg
Turbo	4010 lbs. 1820 kg
Capacity weight	1000 lbs. 455 kg
Permissible axle weight, front:	
GL, GLE	1940 lbs. 880 kg
Turbo	2050 lbs. 930 kg
Permissible axle weight, rear:	
GL, GLE	2030 lbs. 922 kg
Turbo	2090 lbs. 950 kg
Max. roof load	220 lbs. 100 kg
Max. trailer weight	3300 lbs. 1500 kg
Curb weight	2862-3067 lbs. 1298-1391 kg
The max permissible axle loads must not be exceeded!	

NOTE: When adding accessories, equipment, luggage and other cargo to your vehicle, the total loaded weight capacity of the vehicle must not be exceeded. Consult your Volvo dealer for information.

All specifications are subject to change without notice.

pg. 106 Label information

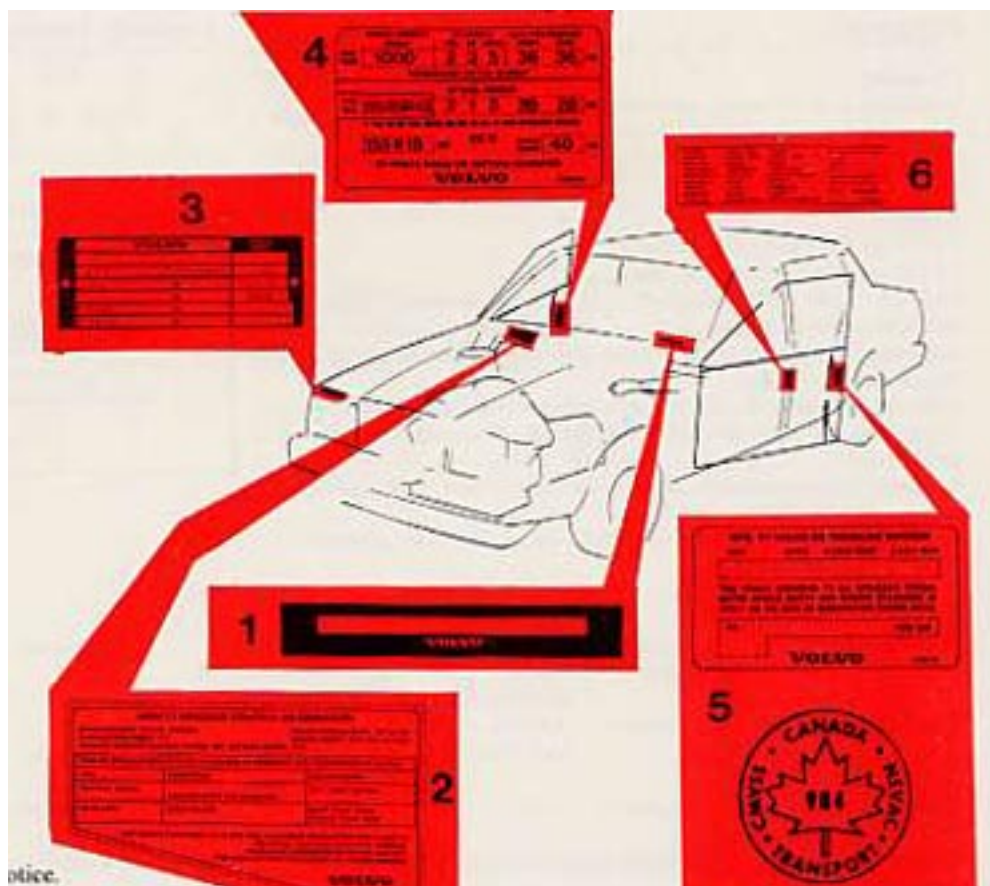

The Vehicle Identification Number (VIN) should always be quoted in all correspondence concerning your vehicle with the dealer and when ordering parts.

1 Vehicle identification number (VIN)

VIN plate is located on top left surface of dashboard. The VIN is also stamped on the right hand door pillar.

2 Vehicle emission control information

Your Volvo is designed to meet all applicable safety and emissions standards, as evidenced by the certification label on the right side of the firewall. For further information regarding these regulations, please consult your Volvo dealer.

3 Model plate

Vehicle Identification Number (VIN). Codes for color and upholstery etc. This plate is located on panel above right headlight.

4 Loads and tire pressures

5 Federal motor vehicle safety standards (FMVSS) specifications (USA) and Ministry of Transport (CMVSS) Standards (Canada)

This label is located on rear facing side of the driver's door.

6 Service label

Label on left-rear door frame.

Information on certain components.

All specifications are subject to change without notice.

pg. 107 Oils

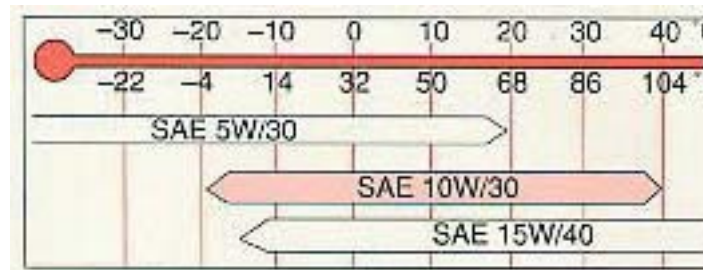

Engine Oil

Oil quality:

According to API SF.

Oils with designation SF/CC and SF/CD comply with these demands.

Synthetic or semi-synthetic oils may be used if their specifications comply with the above.

Volvo recommends the use of fuel economy improving oils. When using these oils, the Volvo recommended oil change intervals must be followed.

Volvo does not recommend oil additives as they can adversely affect the engine.

Capacity: (incl. oil filter) 4.0 US qts. (3.85 liters): on Turbo models, add 0.7 US qts/b. (0.6 liters) if oil cooler is drained.

Manual transmission	Quality	ATF type F or G	Capacity	2.4 US qts. (2.3 liters)
Automatic transmission	Quality	ATF Dexron IID	Capacity	7.9 US qts. (7.5 liters)

Rear axle	Quality	API-GL-5 (MIL-L-2105 B or C) SAE 90 or 80W/90	Capacity	1.7 US qts. (1.6 liters)
Power steering	Quality	ATF	Capacity	0.7 US qts. (0.7 liter)
Brake fluid	Brake fluid type	DOT 4	Capacity	0.43 US qts. (0.4 liter)

NOTE:

SAE 15 W/40 oil is recommended for use in severe driving conditions which involve high oil temperatures or excessive oil consumption e.g. mountain driving with frequent deceleration, or high-speed driving. Note, however, the higher temperature range of 15W/40 oil.

All specifications are subject to change without notice.

pg. 108 Specifications

740 GL,GLE (B230F engine)

Liquid-cooled, gasoline, 4-cylinder inline engine. Cast-iron cylinder block with cylinders bored directly in block. Aluminum-alloy cylinder head with single overhead camshaft and separate intake and outlet channels. Engine lubrication is provided by a gear pump driven from the crankshaft. Full-flow type oil filter. Exhaust emission control accomplished by fuel injection, Lambda-sondTM system and catalytic converter.

Type designation

Output (SAE J 1349)

Max. torque (SAE J 1349)

Number of cylinders

Bore

Stroke

Displacement

Compression ratio

Valve clearance, cold engine

inlet and exhaust

Valve clearance, warm engine

inlet and exhaust

Volvo B230F

114 hp at 5400 rpm (85 kW at 90 rps)

136 ft. lbs. (185 Nm) at 2750 rpm

4

3.78" (96 mm)

3.15" (80 mm)

2.32 Liters

9.5:1

0.014-0.016"

(0.35-0.40 mm)

0.016-0.018"

(0.40-0.45 mm)

All specifications are subject to change without notice.

740 Turbo (B230F-Turbo engine)

Liquid-cooled, gasoline, 4-cylinder inline engine. Cast-iron cylinder block with cylinders bored directly in block. Aluminum-alloy cylinder head with single overhead camshaft and separate intake and outlet channels. Engine lubrication is provided by a gear pump driven from the crankshaft. Full-flow type oil filter. Exhaust emission control accomplished by fuel injection, Lambda-sond™ system and catalytic converter. Exhaust-gas-driven turbo-compressor with intercooler.

Type designation	Volvo B230F-Turbo
Output (SAE J 1349)	160 hp at 5300 rpm (119 kW at 88 rps)
Max. torque (SAE J 1349)	187 ft. lbs. (253 Nm) at 2900 rpm
Number of cylinders	4
Bore	3.78" (96 mm)
Stroke	3.15" (80 mm)
Displacement	2.32 Liters
Compression ratio	8.7:1
Valve clearance, cold engine inlet and exhaust	0.014-0.016" (0.35-0.40 mm)
Valve clearance, warm engine inlet and exhaust	0.016-0.018" (0.40-0.45 mm)

All specifications are subject to change without notice.

pg. 109 Specifications

740 GL, GLE (B230F engine)

Cooling system

Type	Positive pressure, Closed system
Thermostat: begins to open at:	196-200 °F (91-93 °C)
fully open at:	215 °F (97 °C)
Fan belts, designation:	HC-38 x 925
Coolant:	Volvo coolant type C (blue- green)

Capacity: 10 US qts (9.5 liters)

Fuel system

The engine is equipped with an electronic fuel injection system (type LH-Jetronic 2.2)

Ignition system

Firing order	1-3-4-2
Ignition setting (cannot be adjusted)	(12° B.T.D.C. at 750 rpm)
Spark plugs:	Volvo P/N 271409-5 0.024-0.028" (0.6-0.7 mm)
Tightening torque	15-22 ft. lbs. (20-30 Nm)
Distributor, direction of rotation	Clockwise

* Bosch WR7 DC (or equivalent)

740 Turbo (B230F-Turbo engine)

Cooling system

Type	Positive pressure. Closed system
Thermostat: begins to open at:	196-200 °F (91-93 °C)
fully open at:	215 °F (97 °C)
Fan belts, designation:	HC-38 x 925
Coolant:	Volvo coolant type C (blue-green)
Capacity:	10 US qts (9.5 liters)

Fuel system

The engine is equipped with an electronic fuel injection system (type LH-Jetronic 2.2)

Ignition system

Firing order	1-3-4-2
--------------	---------

Ignition setting(cannot be adjusted)	(12° B.T.D.C . at 900 rpm)
Spark plugs:	Volvo P/N 271409-5 0.024-0.028" (0.6-0.7 mm)
Tightening torque	15-22 ft. lbs. (20-30 Nm)
Distributor, direction of rotation	Clockwise

* Bosch WR7 DC (or equivalent)

All specifications are subject to change without notice.

pg. 110 Specifications

Power transmission

Manual or automatic transmission.

Hypoid type final drive.

Manual transmission	M46
Reduction ratios:	
1st gear	4.03:1
2nd gear	2.16:1
3rd gear	1.37:1
4th gear	1:1
Overdrive	0.79:1
Reverse	3.68:1

Rear Axle :

Reduction ratios:	3.54:1
	3.31:1

Automatic transmission AW71 (740 Turbo)

Reduction ratios:

1st gear	2.45:1
----------	--------

2nd gear	1.45:1
3rd gear	1:1
4th gear	0.69:1
Reverse	2.21:1

Rear Axle :

Reduction ratios: 3.73:1

Automatic transmission ZF 4HP-22 (with lock-up)(740 GL, GLE)

Reduction ratios:

1st gear	2.73:1
2nd gear	1.56:1
3rd gear	1:1
4th gear	0.73:1
Reverse	2.09:1

Rear Axle :

Reduction ratios: 3.91:1

Speeds at 1000 engine rpm (manual transmission)

Rear axle ratio	3.54:1		3.31:1	
	mph	km/h	mph	km/h
1st gear	5.0	8.0	5.3	9.0
2nd gear	9.2	14.8	9.8	16.0
3rd gear	14.5	23.4	15.5	25.0
4th gear	19.9	32.10	21.3	35.0
Overdrive	25.2	40.6	26.9	42.0
Reverse	5.4	8.7	5.8	10.0

Front end

McPherson-type spring and strut suspension. Shock absorbers housed in strut casing. Rack-and-pinion steering.

Safety-type steering column.

The alignment specifications apply to an unladen car but include fuel, coolant, and spare wheel.

Toe-in, measured on the wheel rim: 5/64" +/- 1/64" (2 mm +/- 0.5 mm)

tire sides: 3/32" +/- 1/32" (2.5 mm +/- 1 mm)

All specifications are subject to change without notice.

pg. 111 Specifications

Electrical system

12 V, negative ground.

Voltage-controlled alternator. Single-wire system with chassis and engine used as conductors.

Voltage	12V
Battery, type	Maintenance free
Capacity	450 A, 90 min
Electrolyte, specific gravity	1.28
Recharge at	1.23
Alternator, rated output	980W
max. current	70 A

Lights. 12 V	US Bulb No.	Power	Socket	No. of bulbs
Headlights, inner	H4651	Halogen	Sealed beam	2
Headlights, outer	H4656	Halogen	Sealed beam	2
Parking lights, front	1157	21/5W/32/3 cp	BAY 15 d	2
Turn signals, front	1157	21/5W/32/3 cp	BAY 15 d	2
Turn signals, rear	1073	21 W/32 cp	BA 15 s	2
Tail lights	67	5 W/4 cp	BA 15 s	2
Tail light/Stop light	1157	21/5W/32/3 cp	BAY 15 d	2
Back-up lights	1073	21 W/32 cp	BA 15 s	2
Rear fog lights	1073	21 W/32 cp	BA 15 s	2

Bulbs	Power	Socket	No. of bulbs
Fog lights	55 W	H3	2
License plate light	4 W	W 2.1 x 9.5d	2
Door warning lights	3 W	W 2.1 x 9.5d	4
Interior light	10 W	SV 8.5	1
Reading lights, front	5 W	W 2.1 x 9.5d	2
Engine compartment light	10 W	SV 8.5	1
Trunk light	10 W	SV 8.5	1
Glove box light	2 W	BA 9 s	1
Instrument lighting	3 W	W 2.1 x 9.5d	3
Lighting control panel	1.2 W	Volvo P/N 966326	12
A/T selector	1.2 W	Volvo P/N 966326	1
ashtray, rear	1.2 W	Volvo P/N 966326	1
Warning lights			
charging	1.2 W	Volvo P/N 966326	1
oil pressure	1.2 W	Volvo P/N 966326	1
parking brake	1.2 W	Volvo P/N 966326	1
brake failure	1.2 W	Volvo P/N 966326	1
bulb failure	1.2 W	Volvo P/N 966326	1
Indicator lights			
seat belts, rear	2 W	Ba 9s	1
seat belts, front	1.2 W	Volvo P/N 966326	1
turn signals	1.2 W	Volvo P/N 966326	2
high beams	1.2 W	Volvo P/N 966326	1
overdrive	1.2 W	Volvo P/N 966326	1

washer fluid level	1.2 W	Volvo P/N 966326	1
Shift indicator 4th gear	1.2 W	Volvo P/N 966326	1

All specifications are subject to change without notice.

pg. 112 Specifications

Vehicle Loading

The tires on your Volvo should perform to specifications at all normal loads when inflated as recommended on the tire information label. The label is located on the rear-facing edge of the right front door. This label lists both tire and vehicle design limits. Do not load your car beyond the load limits indicated.

Tire Pressure Label



WARNING!

Improperly inflated tires will reduce tire life, adversely affect vehicle handling and can possibly lead to failure resulting in loss of vehicle control without prior warning.

Tool kit

- Wheel nut wrench.
- 2 screwdrivers (1 Phillips, 1 standard)
- Tommy bar
- 2 open end wrenches.

Capacities

740 GL, GLE

740 Turbo

Fuel tank (approx.)	15.8 US gal. 60 liters	15.8 US gal. 60 liters
Cooling system	10 US qts. 9.5 liters	10 US qts. 9.5 liters
Engine, at oil change	4.0 US qts. 3.85 liters	4.0 US qts.* 3.85 liters
Manual transmission (M46)	2.4 US qts 2.3 liters	2.4 US qts 2.3 liters
Automatic transmission (AW71)		7.9 US qts. 7.5 liters
Automatic transmission (ZF 4HP-22)	8.1 US qts. 7.7 liters	
Rear axle	1.7 US qts. 1.6 liters	1.7 US qts. 1.6 liters
Power steering gear	0.7 US qts. 0.7 liters	0.7 US qts. 0.7 liters

* If oil cooler is drained, add 0.7 US qts (0.6 liters)

All specifications are subject to change without notice.

pg. 113 Service manual

Service Manuals for your Volvo are available for purchase. These are the same manuals used by competent Volvo technicians.

Major sections within the Service Manual System include: 0-General Information; 1- Lubrication and Service; 2-Engine; 3-Electrical System; 4-Power Transmission; 5-Brakes; 6- Suspension and Steering; 7-Springs, Shock absorbers and Wheels; 8-Body and Interior.

A Service Manual Brochure/Order Form was placed in the car prior to delivery from the dealer to you. Complete ordering information is provided.

Please note that these manuals may be offered for sale by your Volvo dealer. Prices charged by the dealer can vary from those listed in the brochure (according to Federal law).

Additional copies of the Brochure/Order Form may be obtained from your Volvo dealer, or by mail directly from:

Volvo Cars of North America
 Rockleigh Industrial Park
 Rockleigh, New Jersey 07647
 Attention: Volvo Service Literature

Note that the above pertains to vehicles sold in the U.S.A. only.



Volvo supports Voluntary Mechanic Certification by the N.I.A.S.E. Certified mechanics have demonstrated a high degree of competence in specific areas.

Besides passing exams each mechanic must also have worked in the field for two or more years before a certificate is issued.

These professional mechanics are fully able to analyze vehicle problems and perform the necessary service procedures to keep your Volvo at peak operating condition.

Note! The above pertains to USA only.

All specifications are subject to change without notice.



[Contents](#) | [Top of Page](#)

1985 VOLVO 740 GL, GLE, Turbo

Index

pg. 114-115 Specifications

A

Air conditioning	21, 22, 23
Air louvers	20
Alternator, important note	46
Anti-freeze	103
Anti-rust treatment	78
Ash trays	18
Automatic transmission, driving with	42
Automatic transmission, oil	100

B

Battery	111
Body and chassis	102
Brake fluid	101
Brakes	52
Break-in period	37
Bulb failure warning light	8, 9
Bulbs	64 , 111

C

Capacities	112
Car care	77
Catalytic Converter	51

Chassis number	106
Checking coolant	103
Checking oil	91
Child safety	29
Child safety locks	33
Cigarette lighter	18
Climate control	21, 22, 23
Clock	6
Cold start	40
Cold weather driving	54
Control lights	8
Coolant	103
Coolant, drain	103
Cooling system	103
Cruise control	13

D	
Defroster	21, 22, 23
Demister	17
Diagnosis	73
Dimensions and weights	105
Dipstick	91
Door lock anti-freeze	54
Doors and locks	32
Drain plug, engine	91
Drain plug, rear axle	99
Drive belts	104
Driving economy	39
Driving with trunk lid open	46

E	
Electrical system	111

Emergency towing (pulling)	48
Engine number	89-90
Engine	89-90
Engine oil	91-92
F	
Fan belts	104
Fault Tracing	73
Federal Clean Air Act	88
Fog lights	16
Front seats	28
Front wheel alignment	110
Frozen locks	54
Fuel requirements	38
Fuel gauge	6
Fuel tank cap	38
Fuses	69
G	
Gas filler cap	38
Gasoline requirements	38
Gear shift positions	41, 42
H	
Hand Brake	18
Hazard warning flasher	12
Headlight flasher	12
Headlights	15
replacement	64
Heating	21, 22, 23
Hood lock	35
Horn	4
I	
Ignition and steering wheel lock	11

Instrument lights	6
Instrument and controls	4
Interior light	27
J	
Jack	63
Jump start	50
K	
Keys	3
Kick-down	44
L	
Label information	106
License plate lights	67
Lights	15
Locks	3 , 32
Long distance trips	55
Lubrication	102
Lumbar support	28
M	
Maintenance service	86
Manual transmission, driving with	41
Manual transmission, oil	99
O	
Odometer	6
Oil change, engine	91-92
Oil change, rear axle	99
Oil change, transmission	99-100
Oil filter	91-92
Oil pressure	9
Overdrive	41
P	
Paint touch-up	80
Parking brake	18

Parking lights	15
Polishing	83
Power steering fluid	101
Power train	110
R	
Radios	24
Rear axle oil	99
Rear foglights	16
Rear view mirrors	26
Rear window demister	17
Rustproofing	78
Rust protection	78
S	
Seat belts	30
Seats	28
Service diagnosis	73
Servicing	85
Shift positions	41-42
Shop manuals, Volvo	113
Snow chains	58
Snow tires	58
Spare wheel	61
Spark plugs	109
Specifications	105
Speedometer	6
Starting engine	40
Starting key	3
Steering wheel lock	11
Storage space	36
Sunroof	27
T	
Tachometer	6

Temperature gauge	6
Tire pressure	59
Tires	57
Tire wear indicator	58
Tools	112
Touch up	80
Towing	49
Trailer hauling	53
Transmission oil	99-100
Trunk	33
Turn signals	12
Type designations	106
U	
Upholstery, cleaning	84
V	
Vehicle identification number	106
Vehicle storage	56
Ventilation outlets	20
VIN (Vehicle Identification Number)	106
W	
Warning lights	8
Warranty	88
Warranty inspection	88
Washer fluid	14, 54
Washer nozzles	14
Washing	82
Waxing	83
Weights	105
What causes rust	78
Wheel alignment	110
Wheel change	62

Wheels and tires	57
Window lifts	19
Windshield washers	14
Windshield wipers	14
Winter driving	54
Wiper blades, replacement	72

WARNING!

Detergents and solvents

Do not use gasoline containing lead or benzene as a detergent or solvent.

Both lead and benzene causes headaches, sickness etc. In sufficiently large doses they can cause damage to the blood forming compounds of the body.

WARNING!

Carbon monoxide is a poisonous colorless and odorless gas which is present in all exhaust gases. If you ever smell exhaust fumes inside the vehicle, make sure the passenger compartment is ventilated and immediately return the vehicle to dealer for correction.

Never sit in a parked or stopped car for any extended amount of time nor have it unattended while engine is running.

Never operate the engine in confined, unventilated areas.

740 GL, GLE Engine B230F

When filling gas always check:



Fuel: Octane rating 91 RON (Unleaded) 87 (R + M)/2

Canada: Unleaded regular

Check without removing the cap that the **brake fluid** level is above the Min-mark. Brake fluid DOT 4.

Oil level between dipstick marks. The distance between the marks represents approx. 1 US qt. = 1 liter. When necessary, add oil of the same type as already used.

Coolant level between the expansion tank marks. Mixture 50 percent anti-freeze and 50 percent water.

Battery-maintenance free type, it is only necessary to check the electrolyte level at each service.

Washer fluid reservoir should be filled with water and solvent (wintertime; windshield washer anti-freeze).

Changing a wheel, see pages 62, 63
 a bulb, see pages 64-69
 a fuse, see pages 69-71

Tire pressures, cold tires, psi

VEHICLE CAPACITY		OCCUPANTS			COLD TIRE PRESSURE	
WEIGHT		FR.	RR.	TOTAL	FRONT	REAR
MAX LOAD	1000	2	3	5	36	36
RECOMMENDED FOR FUEL ECONOMY						
OPTIONAL PRESSURE						
TIRE SIZE	185-65R15	2	1	3	28	28
* SEE US ON THE DRIVE OR 4PS (11 psi) IS THE MINIMUM PRESSURE						

GL and GLE models have 14" wheels and Special Spare tire pressure of 40 psi (280 kPa).

This pressure should be maintained irrespective of where on the car the Special Spare tire is used.

56812

When filling gas always check: **740 Turbo Engine B230 F-Turbo**
Fuel: Octane rating 91 RON (Unleaded) 87 (R+M)/2
 Canada: Unleaded regular



- Check without removing the cap that the **brake fluid** level is above the Min-mark. Brake fluid DOT 4.
- Oil** level between dipstick marks. The distance between the marks represents approx. 1 US qt. = 1 liter. When necessary, add oil of the same type as already used.
- Coolant** level between the expansion tank marks. Mixture 50 percent anti-freeze and 50 percent water.
- Battery**-maintenance free type, it is only necessary to check the electrolyte level at each service.
- Washer fluid** reservoir should be filled with water and solvent (wintertime: windshield washer anti-freeze).

Changing a wheel, see pages 62, 63
 a bulb, see pages 64-69
 a fuse, see pages 69-71

Tire pressures, cold tires, psi

VEHICLE CAPACITY WEIGHT	OCCUPANTS			COLD TIRE PRESSURE	
	FRONT	REAR	TOTAL	FRONT	REAR
MAX LOAD 1000	2	3	5	36	36
RECOMMENDED FOR FULL ECONOMY					
OPTIONAL PRESSURE					
TIRE SIZE 185-65R15	2	1	3	28	28

* TIRE AIR NET FWD WEIGHT AND WPL (LBS) TO THESE RECOMMENDED PRESSURES

56812

Turbo models have 15" wheels and Special Spare tire pressure of 50 psi (350 kPa). This pressure should be maintained irrespective of where on the car the Special Spare tire is used.

VOLVO

Volvo Car Corporation
 Göteborg, Sweden



[Contents](#) | [Top of Page](#)

Free Manuals Download Website

<http://myh66.com>

<http://usermanuals.us>

<http://www.somanuals.com>

<http://www.4manuals.cc>

<http://www.manual-lib.com>

<http://www.404manual.com>

<http://www.luxmanual.com>

<http://aubethermostatmanual.com>

Golf course search by state

<http://golfingnear.com>

Email search by domain

<http://emailbydomain.com>

Auto manuals search

<http://auto.somanuals.com>

TV manuals search

<http://tv.somanuals.com>