

# 940 Owner's Manual

## VOLVO

### 940

### 1 9 9 3

This manual deals with the operation and care of your Volvo.

Welcome to the world-wide family of Volvo owners. We trust that you will enjoy many years of safe driving in your Volvo, an automobile designed with your safety and comfort in mind. To help ensure your satisfaction with this vehicle, we encourage you to familiarize yourself with the equipment descriptions, operating instructions and maintenance requirements/recommendations in this manual. We also urge you and your passengers to wear seat belts at all times in this (or any other) automobile. And, of course, please do not operate a vehicle if you may be affected by alcohol, medication or any impairment that could hinder your ability to drive.

Your Volvo is designed to meet all applicable safety and emission standards, as evidenced by the certification labels attached to the driver's door opening and on the left wheel housing in the engine compartment. for further information please contact your dealer.

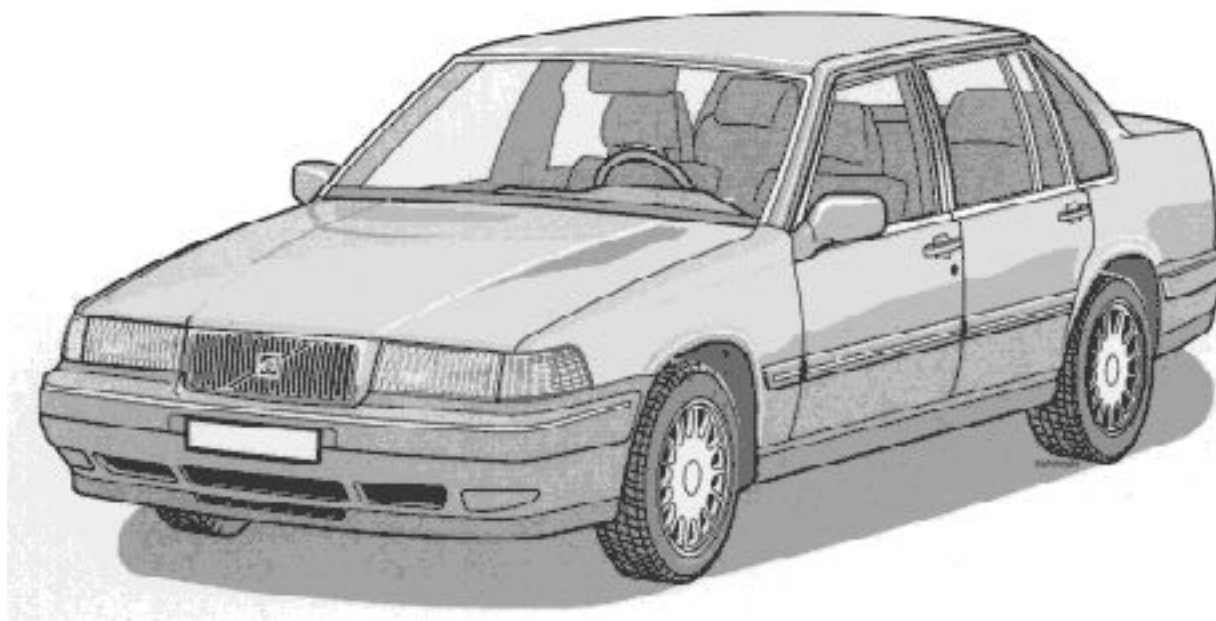

## Contents

[Instruments and controls ... 1](#)

[Body and interior ... 2](#)

[Occupant safety, Reporting safety defects ... 3](#)

[Starting and driving ... 4](#)

[Wheels and tires ... 5](#)

[In case of emergency ... 6](#)

[Car care ... 7](#)

[Service and routine maintenance ... 8](#)

[Specifications ... 9](#)

## Important

You should also be familiar with the information in the first three chapters of this book.

Information contained in the balance of the manual is extremely useful and should be studied after operating the vehicle for the first time.

The manual is structured so that it can be used for reference. It should thus be kept in the car for ready access.

Do not export your Volvo to another country before investigating the country's applicable safety and exhaust emission requirements. In some cases it may be difficult or impossible to comply with these requirements. Modifications to the emission control system(s) may render your Volvo not certifiable for legal operation in the U.S., Canada or other countries.

## Notice:

Your Volvo is designed to meet all applicable safety and emission standards, as evidenced by the certification labels attached to the door opening sheet metal and on the left wheel housing in the engine compartment. For further information regarding these regulations, please contact your dealer.

All information, illustrations and specifications contained in this manual are based on the latest product information available at the time of publication. Volvo reserves the right to make model changes at any time, or to change specifications or design, without notice and without incurring obligation.

©Volvo Cars of North America, Inc.



[Contents](#) | [Top of Page](#)

## Instruments, switches and controls

## Instruments, switches and controls

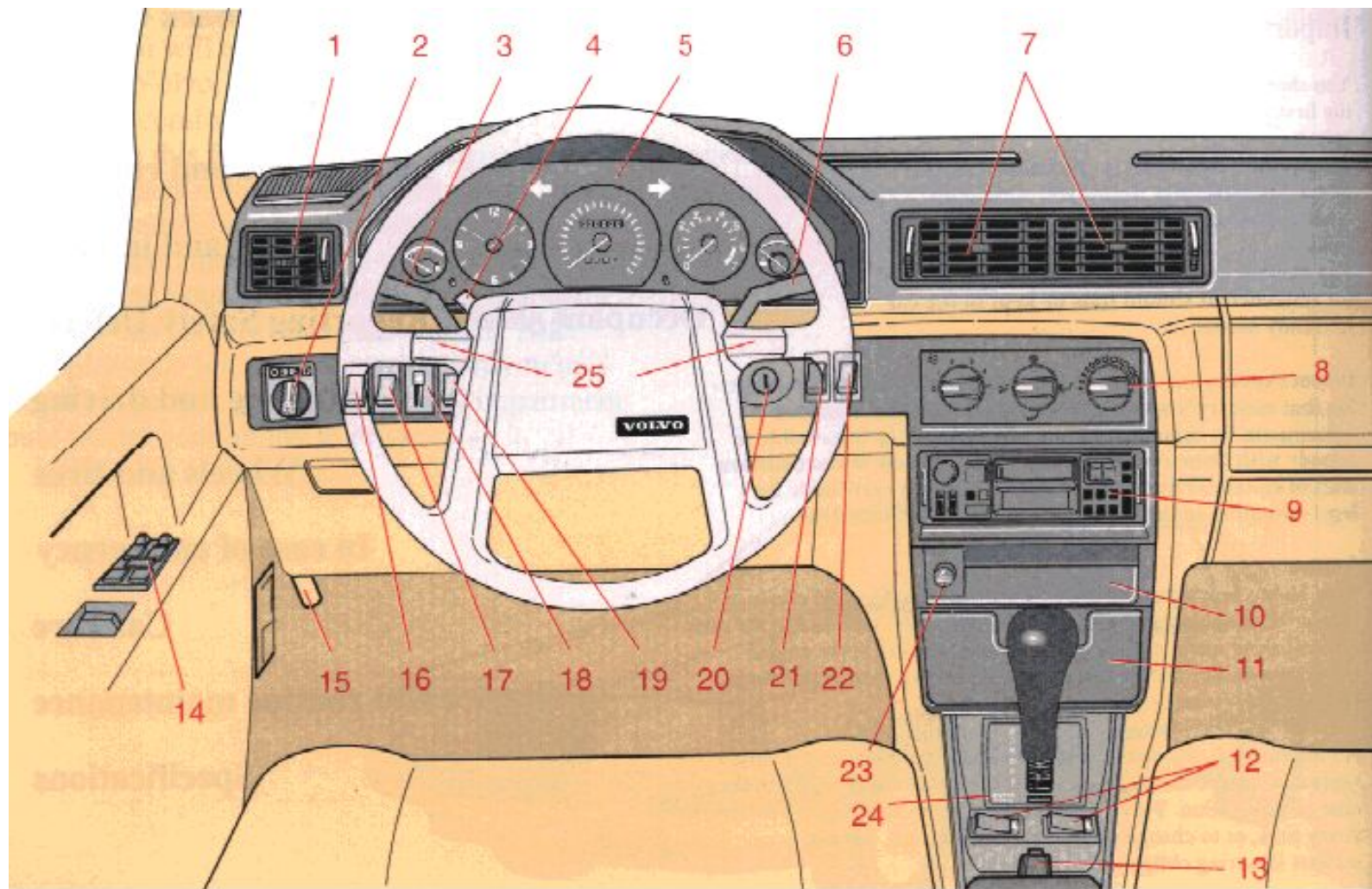

pg. 1:1 Instruments, switches and controls

**IMPORTANT!**

Your car is equipped with a Shiftlock-Keylock system.

**SHIFTLOCK:**

When your car is parked, the gear selector is locked in the (P)ark position. To release the selector from this position, turn the ignition key to position II (or start the engine), depress the brake pedal, press the button on the front side of the gear selector and move the selector from (P)ark.

If it is necessary to manually override the Shiftlock system, see page 6:18 for instructions.

**KEYLOCK:**

This means that when you switch off the ignition, the gear selector must be in the (P)ark position before the starting (ignition) key can be removed from the ignition switch.

The pages in this section provide detailed descriptions of the vehicle's instruments and controls. Note that vehicles may be equipped differently, depending on special legal requirements, etc.

- [1:11](#) 1 Air louver
- [1:6](#) 2 Headlights, parking lights
- [1:6](#), [1:10](#) 3 Turn signals, Cruise Control
- [1:6](#) 4 Hazard warning lights
- [1:2](#) 5 Instruments
- [1:7](#) 6 Wiper/washer
- [1:11](#) 7 Air louvers
- [1:11](#) 8 Heating and air conditioning
- [1:17](#) 9 Audio system
- 10 Space for additional equipment
- [1:16](#) 11 Ash tray
- [1:14](#) 12 Electrically-heated front seats
- [1:16](#) 13 Parking brake
- [2:5](#) 14 Power door mirrors
- [1:15](#) Electrically operated windows
- [2:9](#) 15 Hood release handle
- [1:8](#) 16 fog lights
- 17 Space for additional equipment
- [1:8](#) 18 Instrument illumination
- [1:8](#) 19 Power antenna
- [1:7](#) 20 Starting (ignition) switch/steering wheel lock
- [1:9](#) 21 Heated rear window/side door mirrors
- [1:9](#) 22 Electrically operated sun roof (option)
- [1:16](#) 23 Cigarette lighter
- [6:18](#) 24 Shiftlock override button
- 25 Horn

pg. 1:2 Instruments



1 Ambient temperature indicator (certain models)

Indicates the temperature slightly above the surface of the road. An amber warning lamp lights up when the temperature is in

the range of 23-36° F (-5 - + 2° C). At low speeds or when the car is not moving, the temperature readings may be slightly higher than the actual ambient temperature due to heat generated by the engine.

## 2 Fuel gauge

The total fuel tank capacity is approx. 19.8 US gals (75 liters). When the warning light comes on, there are approximately 1.6 US gals. (6 liters) of fuel remaining in the tank. See "Refueling" for further information.

## 3 Quartz crystal clock/clock set button

Press the button and turn to set the clock.

## 4 Speedometer

## 5 Odometer

## 6 Trip odometer/reset button

Used for measuring shorter distances. The last digit indicates 1/10 mile/kilometer. A black number on a white background = original speedometer. A red number on a white background = replacement speedometer.

## 7 Tachometer

Reads thousands of engine rpm. Engine should not be operated in red range.

## 9 Boost pressure gauge ( Turbo-engine cars only )

The boost pressure gauge is divided into sections. Black section: The engine acts as a normally-aspirated engine. Best fuel economy is achieved while driving in this range. White section : The turbocharger provides boost pressure.

## 8 Temperature gauge

The pointer should be approximately midway on the gauge face when driving. If the pointer approaches the red range repeatedly, check coolant level and fan belt tension. Do not drive the car with the pointer in the red range. See sections "Coolant" and Drive belts".

**Warning! Allow engine to cool before adding coolant.**

pg. 1:3 Indicator and warning lights





- 1 Turn signal, left
- 2 Turn signal, right
- 3 Malfunction indicator lamp
- 4 Direction indicator, trailer
- 5 Service reminder indicator
- 6 Low washer fluid level  
If the lamp glows continuously when the engine is running, there is only about 1/2 - 1 US qts. remaining in the washer fluid reservoir.
- 7 Rear fog lamp
- 8 Bulb failure
- 9 Generator not charging
- 10 Low engine oil pressure
- 11 High beams
- 12 Brake failure
- 13 Parking brake applied
- 14 ABS-system, see p. 1:5
- 15 (Not in use)
- 16 (Not in use)
- 17 4th gear engaged
- 18 Fasten seat belts
- 19 SRS
- 20 (Not in use)
- 21 (Not in use)

#### pg. 1:4 Warning lights

The warning lights described on pages 1:4 and 1:5 should never stay on when driving

When the ignition key is turned on, and before the engine starts, all of the warning lights should be on to test the function of the bulbs. Should a light not go off after the engine has started, the system indicated should be inspected. However, the parking brake reminder light will not go off until the parking brake is fully released.



#### Generator warning light

If the light comes on while the engine is running, check the tension of the generator drive belt as soon as possible.

**NOTE:** This warning lights is illuminated if the generator is not charging. However, parking brake, brake failure and bulb failure warning lights will be illuminated at the same time due to the design of the system.



#### Malfunction indicator lamp

If the lamp comes on (or stays on after the vehicle has started), the engine diagnostic system has detected a possible fault in the emission control system. Although driveability may not be affected, see an authorized Volvo retailer as soon as possible for inspection.



#### Oil pressure warning light

If the light comes on while driving, the oil pressure is too low. Stop the car and then stop the engine immediately and check the engine oil level. See the section titled "Engine oil". If the light stays on after restart, have the car towed to the nearest authorized Volvo retailer. After hard driving, the light may come on occasionally when the engine is idling. This is normal, provided it goes off when the engine speed is increased.



#### Parking brake reminder light

This light will be on when the parking brake (hand brake) is applied. The parking brake lever is situated between the front seats. Canadian models are equipped with this warning light: 



#### Brake fluid warning light

If the light comes on while driving or braking, this indicates that the brake fluid level is too low. Stop immediately, open the hood and check the brake fluid level in the reservoir (see section "Engine compartment" for reservoir position)!

Canadian models are equipped with this warning light: 

### **WARNING!**

**If the level is below the MIN mark in either section of the reservoir: DO NOT DRIVE. Tow the car to a Volvo retailer and have the brake system checked and any leakage repaired.**

pg. 1:5 Indicator lights



#### Service reminder indicator

This light will come on at 10,000 mile (16,000 km) intervals. It is a reminder to the driver that the 10,000 mile (16,000 km) service interval has been exceeded. The light will stay on 2 minutes after the start until reset by the servicing dealer.

\* Turbo models: 5,000 miles (8,000 km)



#### Anti-lock Brake System (ABS)

If the warning lamp lights up there is a malfunction of the ABS system (the standard braking system will however function). The vehicle should be driven to a Volvo retailer for inspection.

See page 4:20 for additional information.

Canadian models are equipped with this warning light: 



### Supplemental Restraint System (SRS)

If the light comes on (or stays on after the vehicle has started), the SRS diagnostic system has detected a fault. Drive to an authorized Volvo retailer for an inspection of the system. (See section "SRS" for further information.)



### Bulb failure warning light

The light will come on if any of the following bulbs are defective:

one of the low beam headlights

one of the tail lights

one of the brake lights when the brake pedal is depressed.

Check the fuse and bulb.

See sections titled "Replacing bulbs" and "Fuses".

Should the warning light come on after a defective outside bulb has been replaced, the corresponding bulb on the other side of the car should also be replaced.



[Contents](#) | [Top of Page](#)



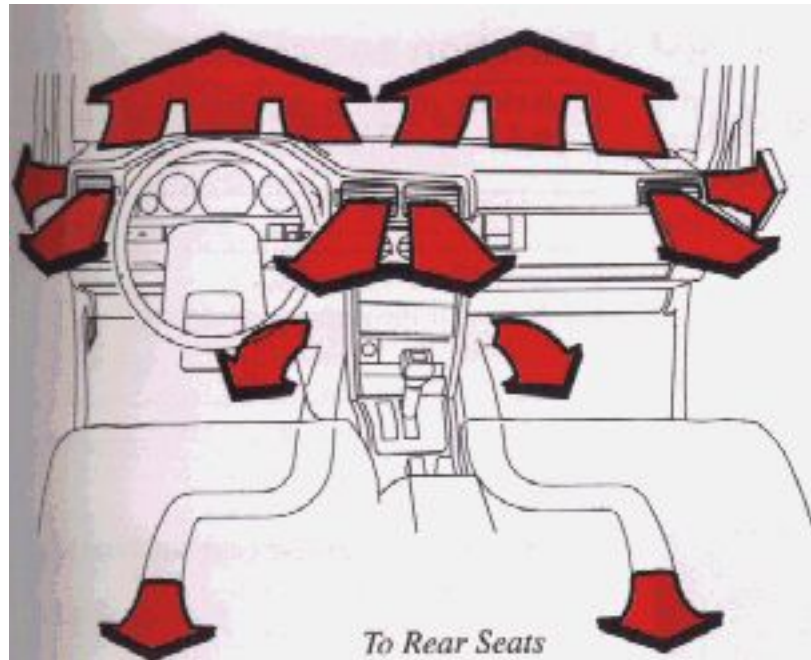

## Heating and air conditioning

Your Volvo is equipped with a heating system combined with air conditioning.

Depending on which function you select, warm or cool/cold air is distributed to the different parts of the passenger compartment.

The air conditioning system in your car contains a CFC-refrigerant - R134a. This is an environmentally friendly substance having minimal effect on the earth's ozone layer.

The system contains 2.1 lbs (0.95 kg) R134a.

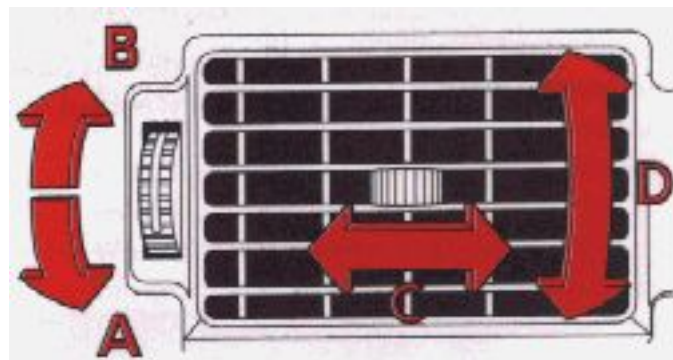

Air louvers (dash)

A Open

B Closed

C Directing air flow horizontally

## D Directing air flow vertically

A certain amount of air will always enter through the dash air louvers as long as they are open, independently of the position of the air distribution control.

Close the dash air louvers to obtain maximum air flow to floor or windshield.

pg. 1:12 Heating and air conditioning

## Heating and ventilation with air conditioning

### Blower

0 = off

5 = max speed

### Function selector

Set desired function

### Temperature dial

Set desired temperature

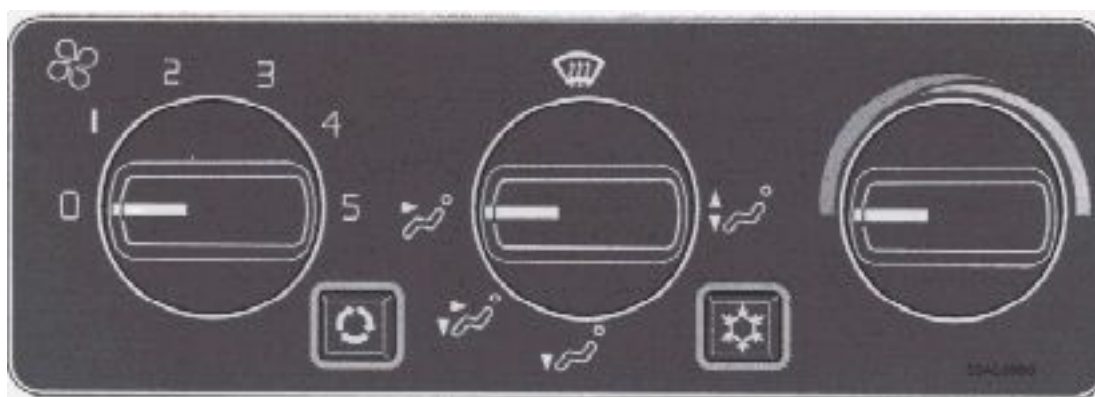

Air in the passenger compartment recirculates with this button depressed.

Will not function in defrost setting.

Light is on when the button is depressed and the headlights or parking lights are on.







The air conditioning system is OFF when this button is depressed .

The light is on when the button is depressed and the headlights or parking brake are on \* .

\* When the function selector is in the  mode, the air conditioning system is ON regardless of button position.

### Function selector

-  Air through panel vents
-  Defrost. Air to windshield and side windows.
-  Air to floor, windshield and side windows.
-  Air through floor vents.

- Bi-level. Air through floor and panel vents.

pg. 1:13 Heating and air conditioning (cont.)

### Maximum heating:



Close the center panel vents. When the passenger compartment has become sufficiently warm, set the blower control to position 2 and adjust the temperature.

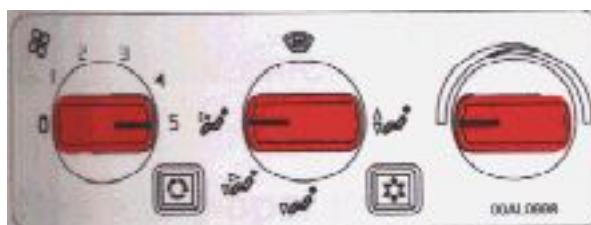

### Maximum cooling:



Open the vents. The A/C button should not be depressed. Adjust the temperature with the temperature dial.

### To demist / Defrost the windows



Set the function dial to position . When the windows have cleared set the blower control to position 2 and the function selector to . Always keep the air intake grille at the base of the windshield free of snow.

### Operating tips

The air conditioning system functions only at temperatures above 45°F (7°C).

The air conditioning will only function if the blower is set to position 1 or higher.



Choose this position if the outside air is contaminated with exhaust gases, smoke, etc or to heat/cool the car quickly. In this position, very little air is drawn into the passenger compartment from the outside. Do not leave the system in this mode for more than 10-15 minutes since the air inside the car will become stale. The temperature can be controlled with the temperature dial.

Remember: If the panel vents are open, a certain amount of air will always flow through, regardless of the position the function dial is in. To increase the flow of air to either the floor or the windows, close the panel vents. The outer vents can be opened to avoid mist on the side windows.

The air conditioning system will function best if it is used regularly.

Water under the vehicle in hot weather can be the result of condensation from the air conditioning system.

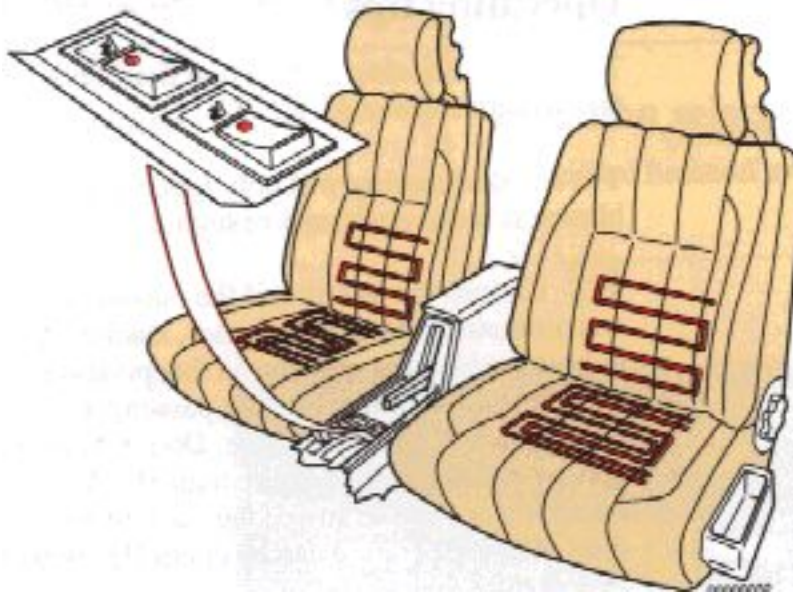

## Heated front seats

The front seats are equipped with electrically-heated backrests and seat cushions. Switched on and off as required. When switched on, the seats are automatically heated and when the optimum temperature is reached, the heating automatically switches off .

While driving, the passenger seat heating should be switched off when the seat is not occupied.

## pg. 1:15 Electrically operated windows

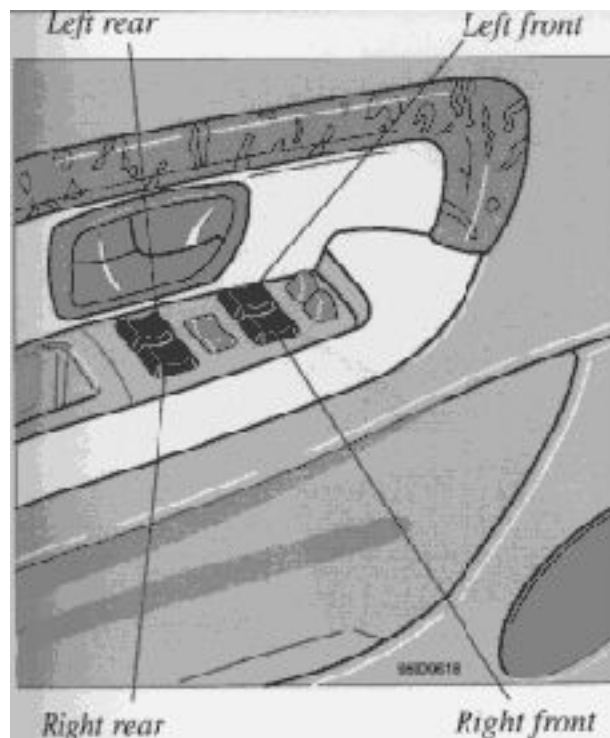

## Electrically-operated windows



The electrically operated windows are controlled by switches from the driver's armrest as shown in the above illustration.

The starting (ignition) switches must be ON (position II) for the electrically operated windows to function. The window is lowered if the rear part of the switch is pressed and raised if the front part of the switch is pressed.

**WARNING! Remove the starting (ignition) key when children are left unattended in the vehicle.**

**Make sure that children's hands are clear before raising the windows.**

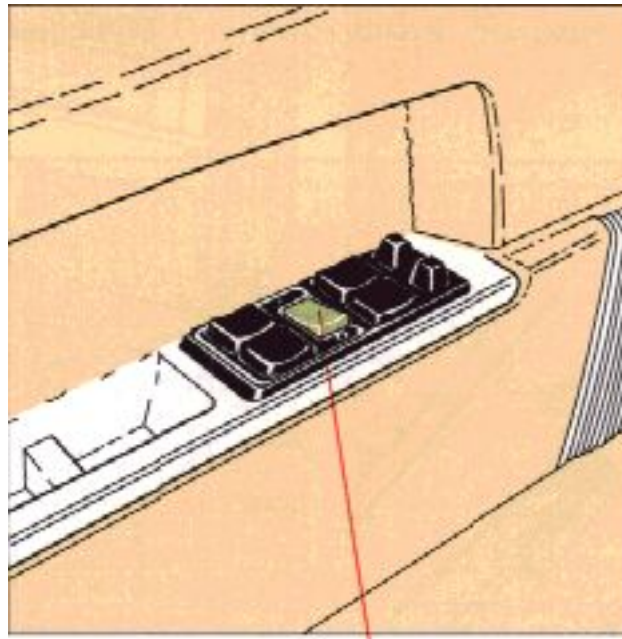

*Cut-out switch*

### Cut-out switch for electrically-operated rear-door windows

If the car is equipped with rear door windows, this function can be disabled by a switch located on the driver's door armrest. This switch is positioned 90° in relation to the other switches.

- The rear door windows can be raised or lowered with the respective door switch as well as the switch on the driver's door.
- The rear door windows cannot be raised or lowered with the respective door switch but instead only with the corresponding switch on the driver's door.



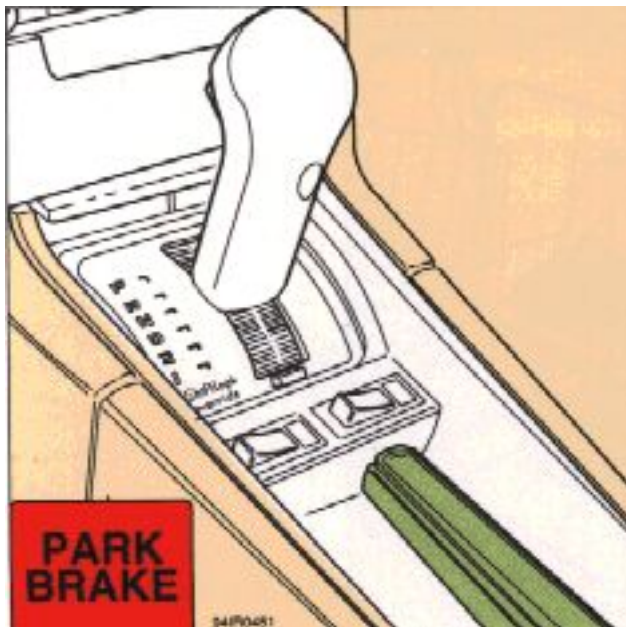

### Parking brake (hand brake)

The lever is situated between the front seats. The brake is applied to the rear wheels. In order to obtain the best possible performance of the parking brake, see section titled "Brake System".

### **WARNING!**

Always use the parking brake (hand brake) when parking. On hills, also turn the front wheels toward the curb.

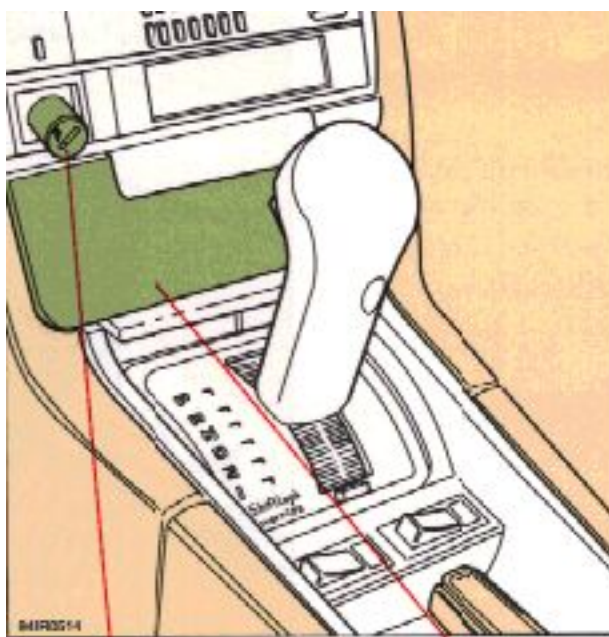

Lighter

Ash tray

### Cigarette lighter

To operate, depress the knob fully. When the knob automatically releases, the cigarette lighter is ready for use.

The starting (ignition) switch must be switched on (position I or II) for the cigarette lighter to function.

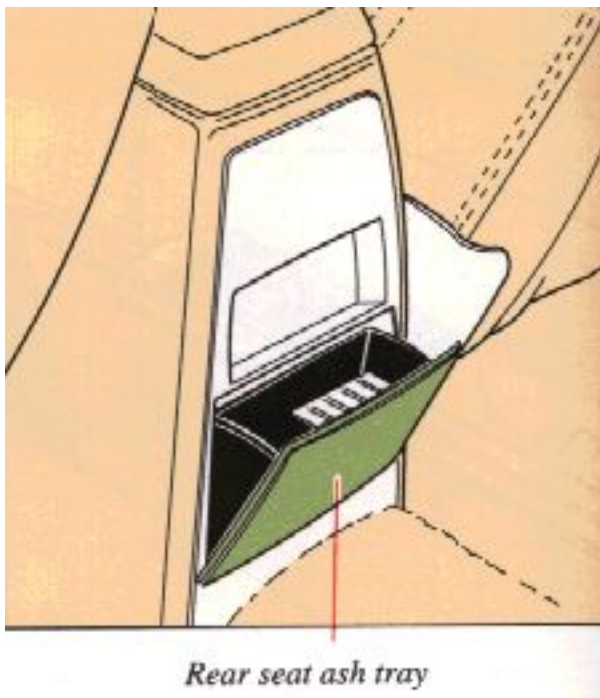

## Ash trays

To remove the ash trays depress the center spring and remove.



[Contents](#) | [Top of Page](#)

## pg. 1:17 Audio system CR-915, general description

The following 21 pages describe the use of your CR-814 cassette radio and CD remote control. See page 1:44 for specifications. See page 1:33 for information on the CR-718 cassette radio.

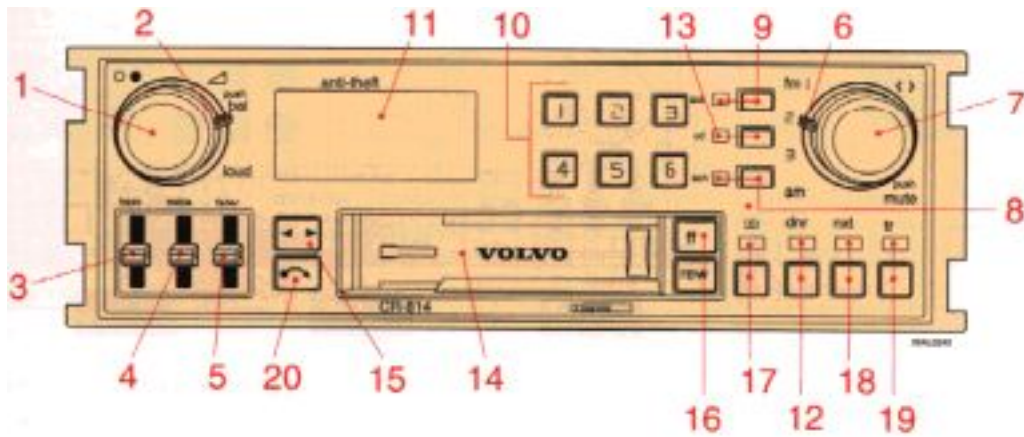

1.

- ON/OFF
- Volume
- Balance left-right (push)

2. Loudness selector

3. Bass control

4. Treble control

5. Fader front/rear

6. Waveband selector

7.

- Frequency tuning
- Pause/Mute (press)
- CD - Track no. selector

8. Scanning

9.

- Autostore
- CD - Random play

10.

- Prest buttons
- CD - Disk no. selector

11. Display

12. DNR selector

13.

- CD mode selector
- Anti-theft indicator

14. Cassette slot
15. Tape direction (REV)
16.
  - Lockable fast winding (ff=rev)  
("Seek" function in radio mode)
  - CD - Disk no. selector (ff=up)
  - CD - Disk no. selector (rew=down)
17. DOLBY B selector
18.
  - Next selector
  - CD - Track no. selector (up)
19. Tuner recall
20. Cassette eject

CD =applicable only when set is in  
CD mode and connected to a CD changer

pg. 1:18 Anti-theft code

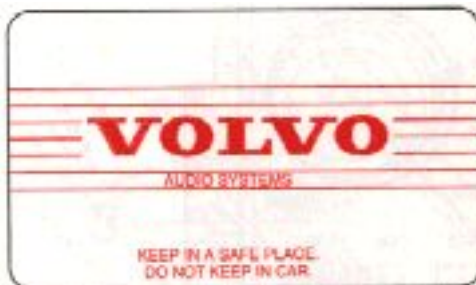

The radio features anti-theft circuitry. While the unit is powered but the ignition is OFF (key removed), the "CD" indicator lamp (13) flashes to indicate the anti-theft system. If the set is removed from the vehicle or if the battery power is disconnected, a special code must be entered to enable operation of the set.

Refer to the radio code card supplied with your vehicle or ask your dealer for the correct code or ask your dealer for the correct code .

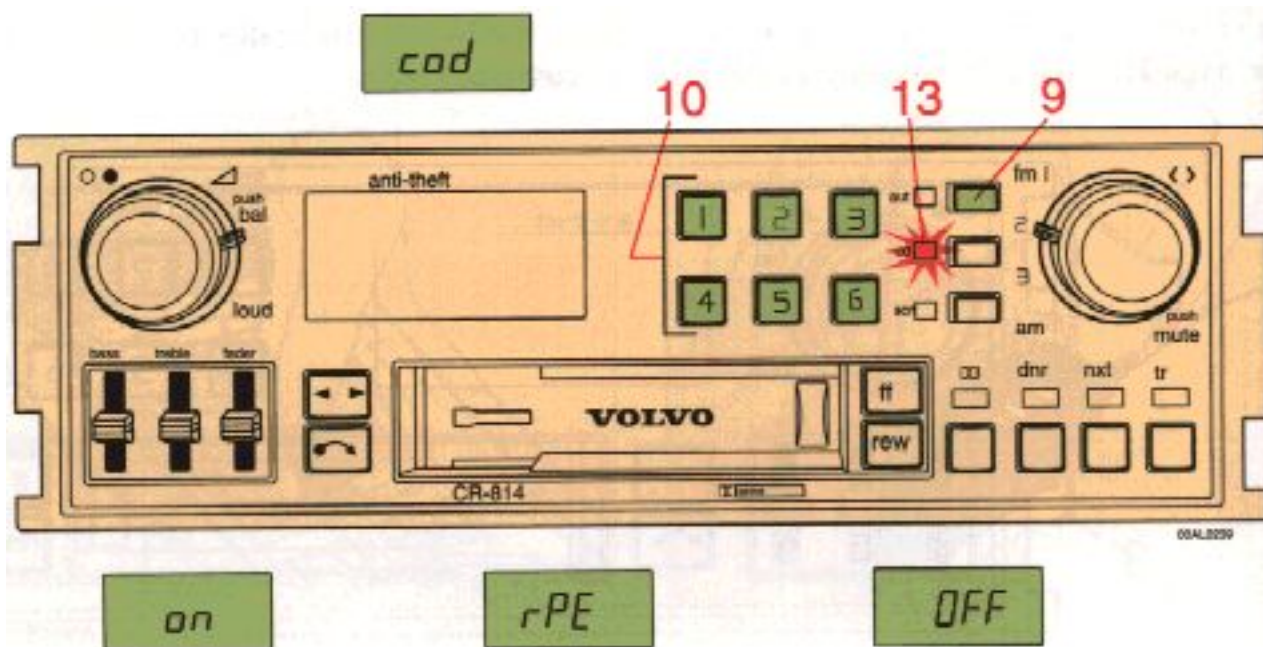

To enter the code

When the set has been disconnected from power the set displays "cod" after being switched on. the "cd" indicator lamp (13) flashes. Enter the 6-digit code using the preset buttons (10). Please note that only 4 digits will be seen in the display. Press the "aut" button (9). Do not press "aut" until you have entered the correct code. If the correct code is entered "on" is displayed and the set is now ready for use. If you enter an incorrect code you must enter the correct code from the beginning again.

Incorrect code

If an incorrect code is entered "rpE" is displayed. Enter the correct code.

Once you have attempted to enter an incorrect code three times the set will lock and remains locked for 1 hour.

"OFF" is displayed.

The unit must be connected and turned on during this time.

Enter the code again once this time has elapsed.



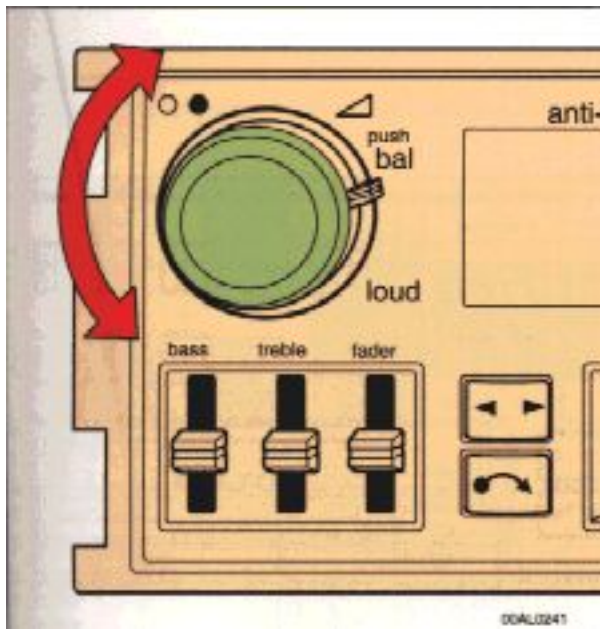

### On/off switch and volume control

Turn the button clockwise to switch on and to increase the volume.

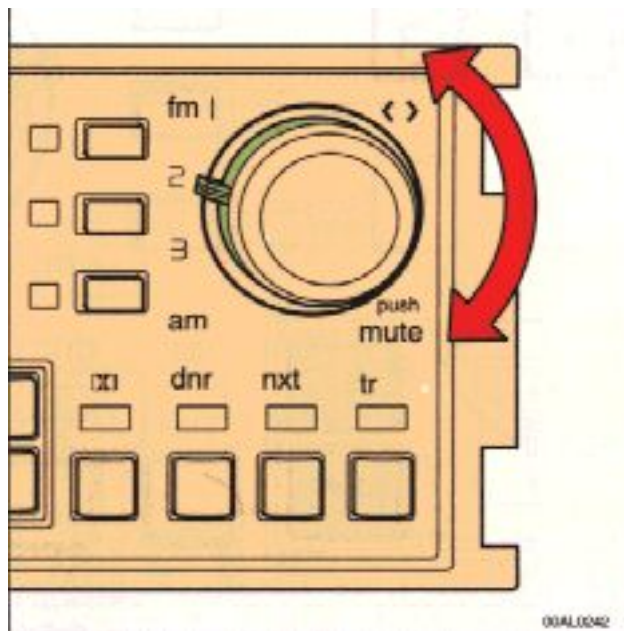

### Waveband selector

The desired waveband is set by turning the inner knob. The set waveband and frequency is displayed. **NOTE!** There are three FM positions and one AM position which make it possible to store 3 x 6 FM stations and 6 AM stations.



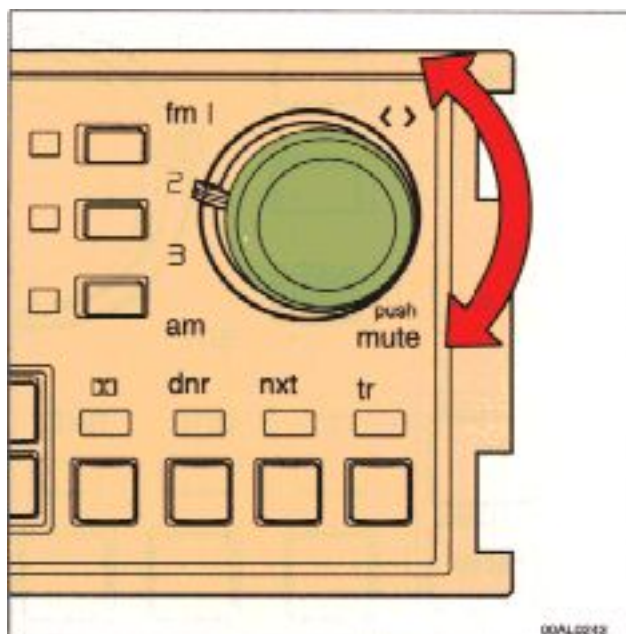

## Manual tuning

Turn the outer knob counter-clockwise to tune to lower frequencies and clockwise to tune to higher frequencies. The tuned frequency is displayed.

pg. 1:20 Radio

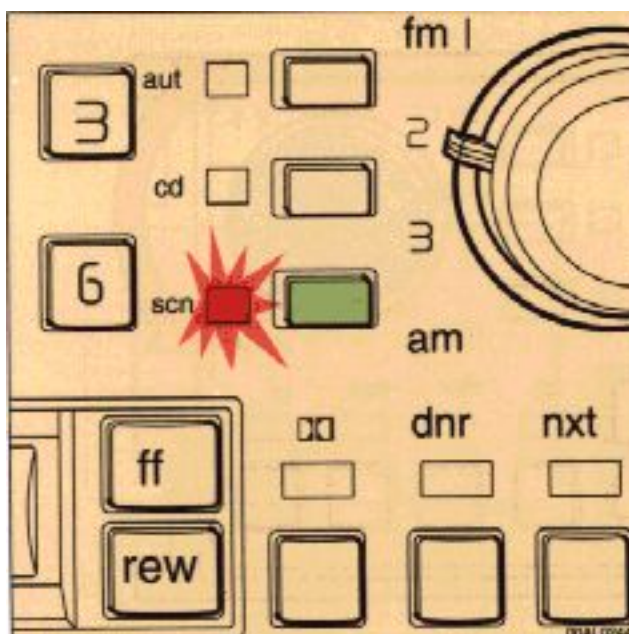

## Scan tuning

Depress the "scn" button. The radio scans the entire waveband and stops at every audible station for 8 seconds. Scanning is then resumed. If you want to retain the station press the "scn" button a second time within the 8 seconds.

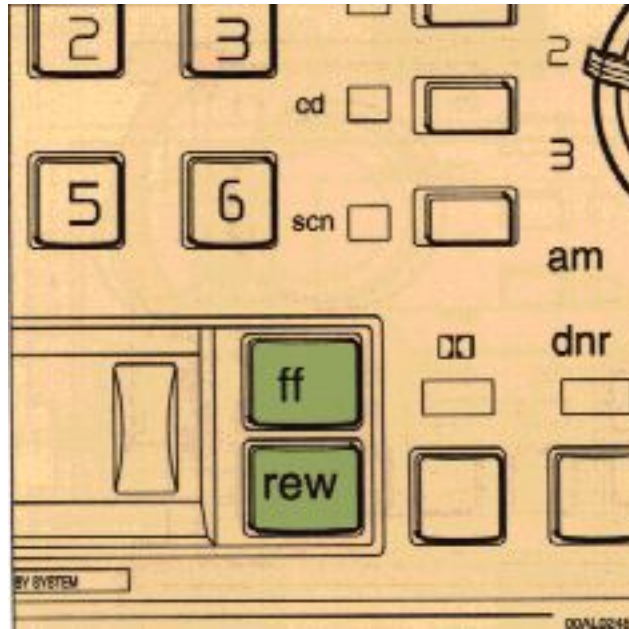

### Seek tuning

Depress the "ff" button to seek for higher frequencies and "rew" to seek for lower frequencies. The radio seeks the next audible station and stops there. If you wish to continue the seek tuning press the "ff" or "rew" button once more.

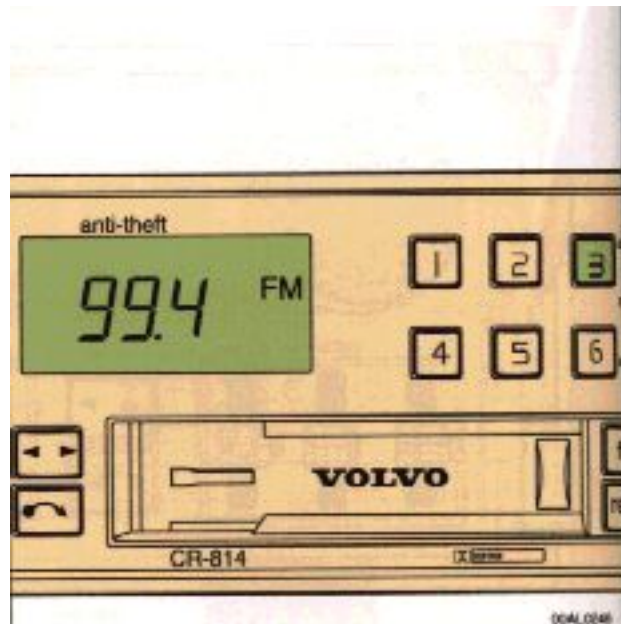

### Preset programming

1. Tune to the desired frequency.
2. Depress and hold a preset button. The audio will cut out. Keep the button depressed until the audio comes on again (approx 2 seconds).
3. The frequency is now stored on this preset button.

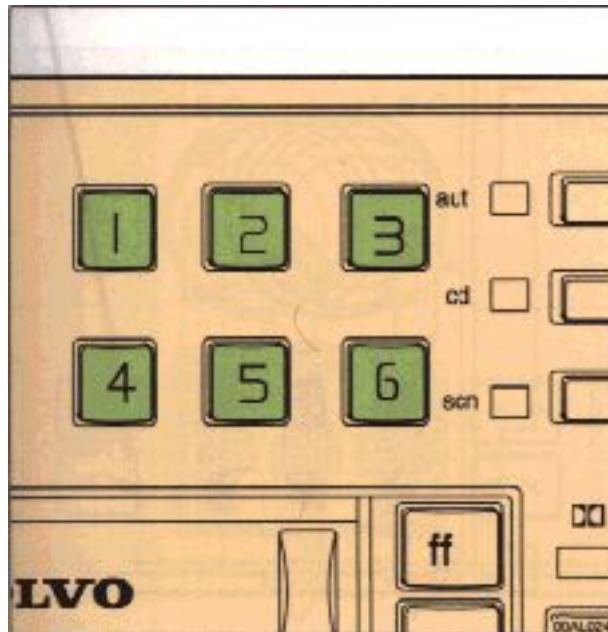

### Preset buttons

Depress the preset button to tune in to the programmed frequency. The set frequency is displayed.

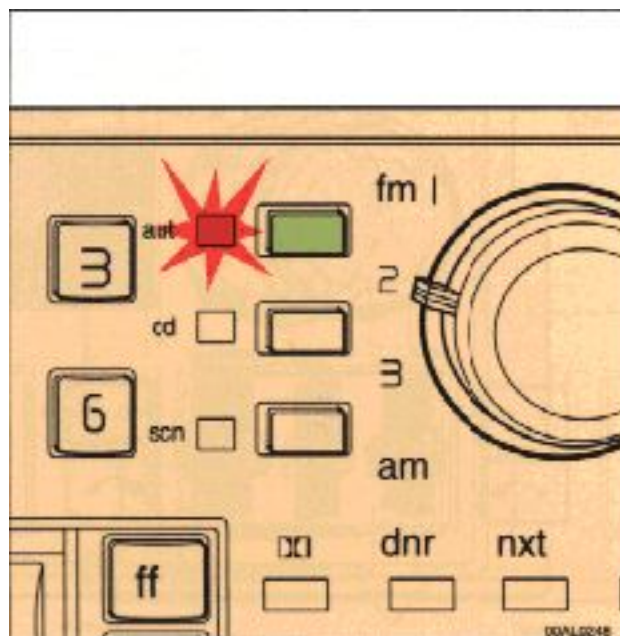

### Automatic programming (Autostore )

(Automatically seeks and stores up to 6 strong AM or FM stations)

This feature works on both wavebands, but if you change waveband and use the autostore function on this new waveband, the autostored stations on the previous waveband will be cancelled. The antenna must be fully extended when using this function.

1. Depress and hold the "aut" button for at least 1 second. The indicator lamp is lit. A number of strong stations (maximum six) on the chosen waveband are now automatically stored in the memory. The lowest frequency is heard. If there are no audible stations, "no" is displayed.
2. Press the "aut" button to obtain another autostored station. A new station will be selected each time the "aut" button is pressed.

pg. 1:22 Radio (cont.)

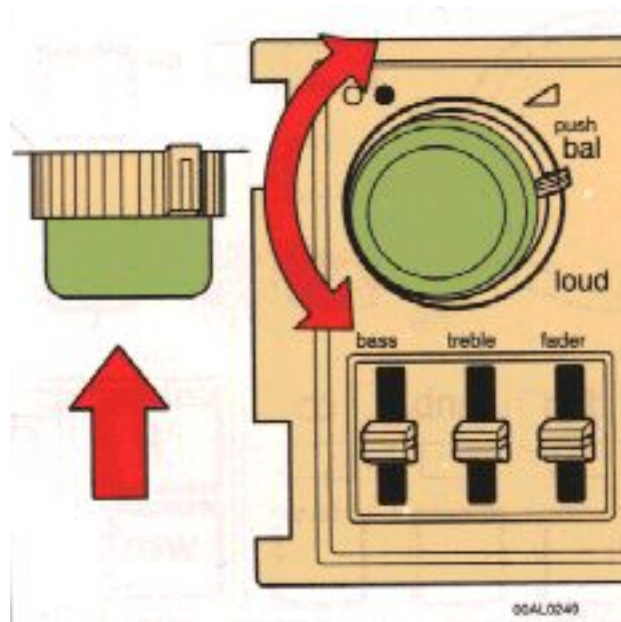

### Balance control

Depress the control knob and turn clockwise/counter-clockwise to adjust right/left speaker balance. A "detent" indicates the "equalized" left/right balance position.

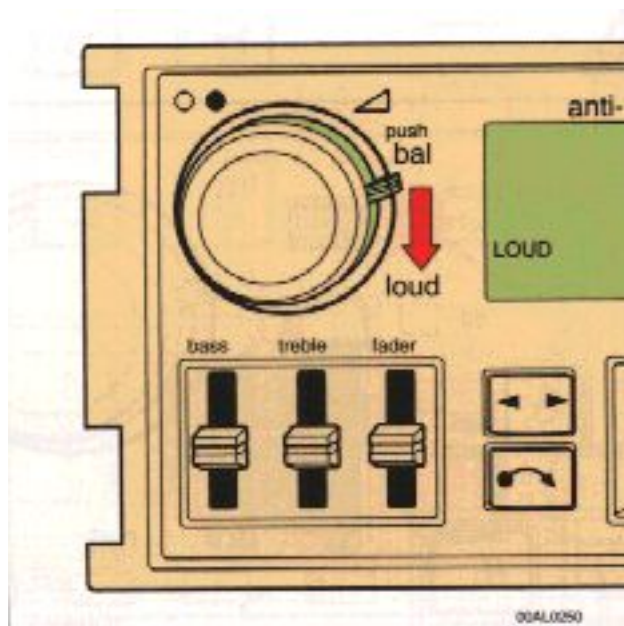

### LOUDNESS selector

When "Loudness" is engaged, bass and treble are enhanced at low volumes. "LOUD" is displayed when this function is engaged.

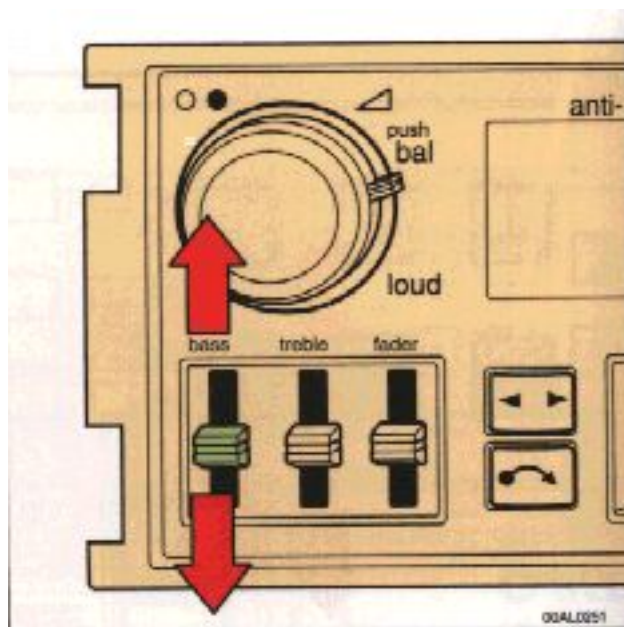

### Bass control

Adjust the bass by sliding the control up or down.

(Up to increase, down to decrease. The "detent" indicates "equalized" bass.)



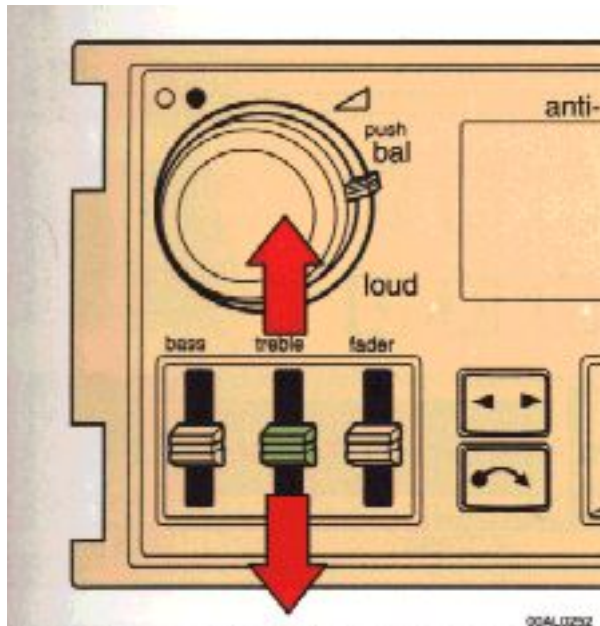

### Treble control

Adjust the treble by sliding the control up or down.

(Up to increase, down to decrease. The "detent" indicates "equalized" treble.)

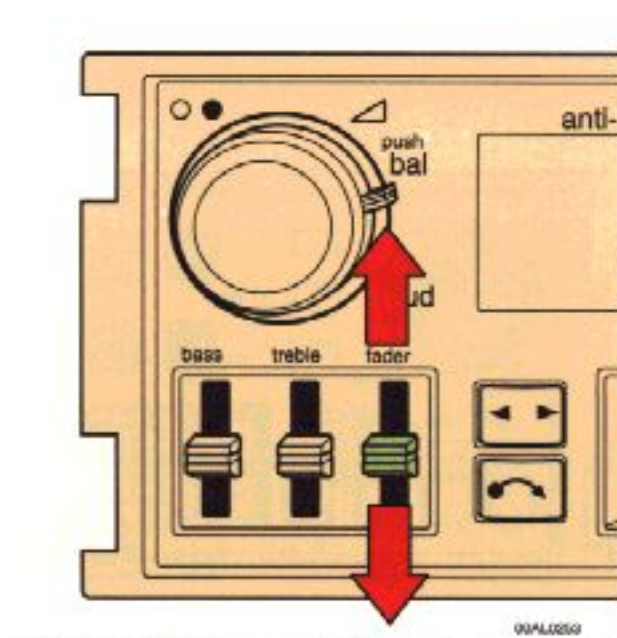

### Fader control

Adjust front/rear speaker balance by sliding the control up or down.

(Up to direct more sound to the front speakers, down to direct more sound to the rear speakers. The



"detent" indicates "equalized" front/rear balance position.)

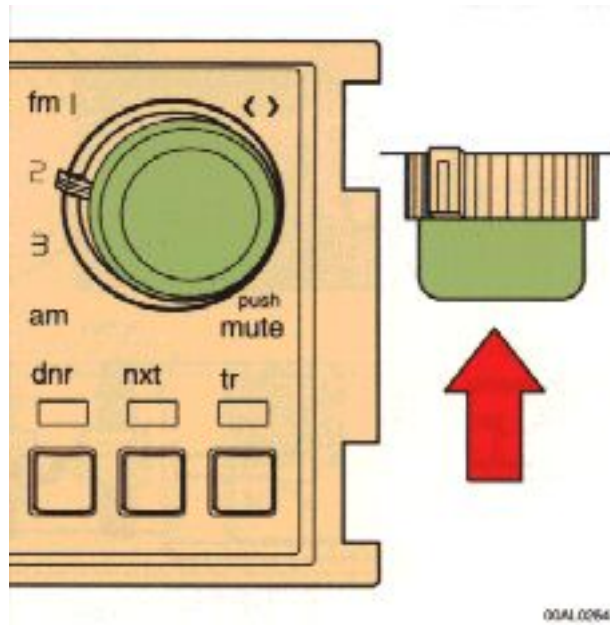

### Mute function

Press the tuning knob to temporarily mute the sound. "PAU" is displayed.

pg. 1:24 Radio (cont.)

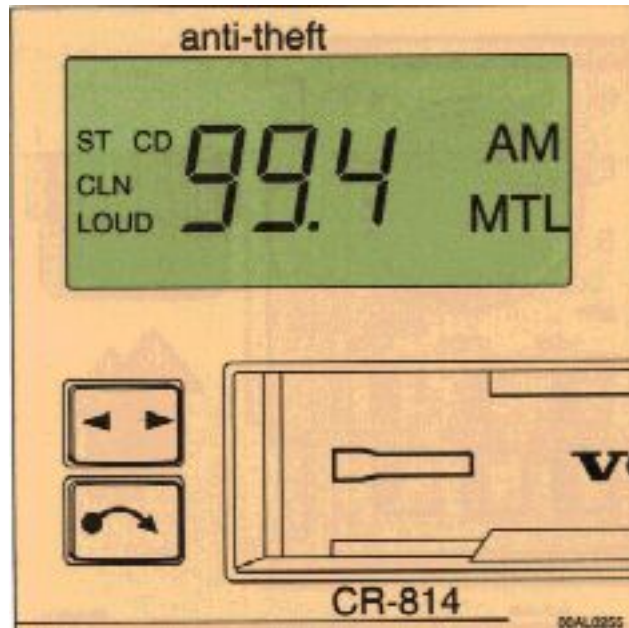

### Display

The display shows the set waveband (AM, FM) radio frequency, ST (stereo) LOUD (loudness), tape direction, compact disc number and track number when these functions are engaged.



[Contents](#) | [Top of Page](#)

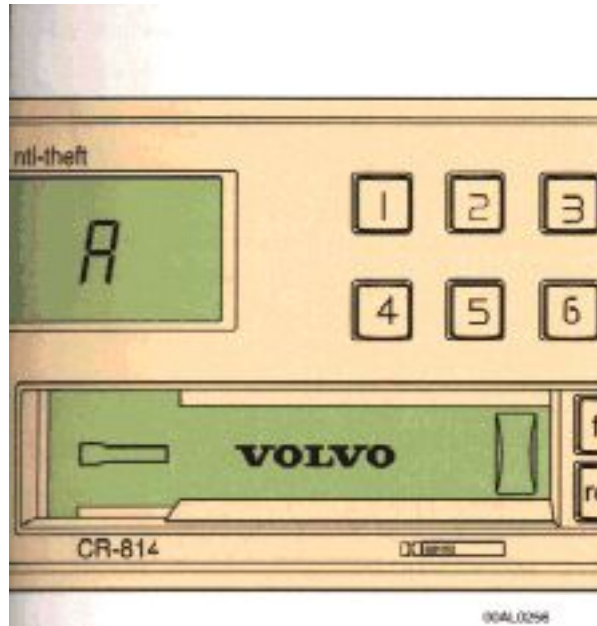

### Cassette insert

Insert the cassette with the open side to the left and with the A side upwards. The unit automatically loads the cassette, the radio is disconnected and the tape starts playing. A or B is displayed, indicating which side of the tape is being played.

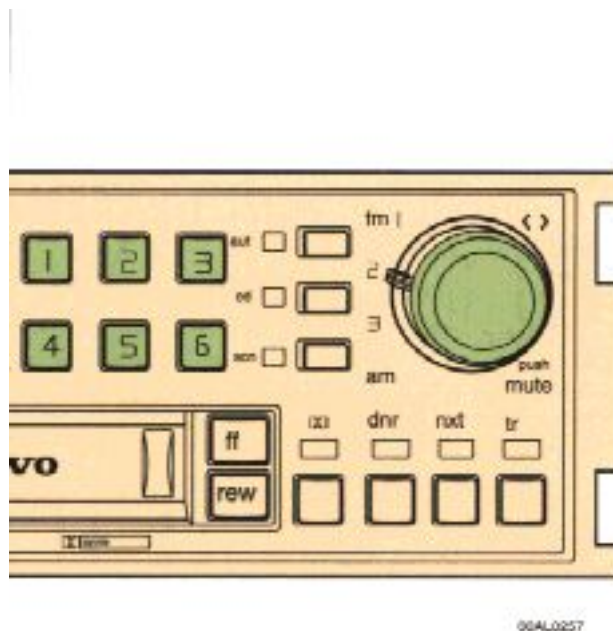

To re-enter Radio mode

There are three alternative ways to re-enter radio mode:

- turn the manual tuning knob
- push the "aut" button
- push any preset button. The cassette remains in place and is not ejected.

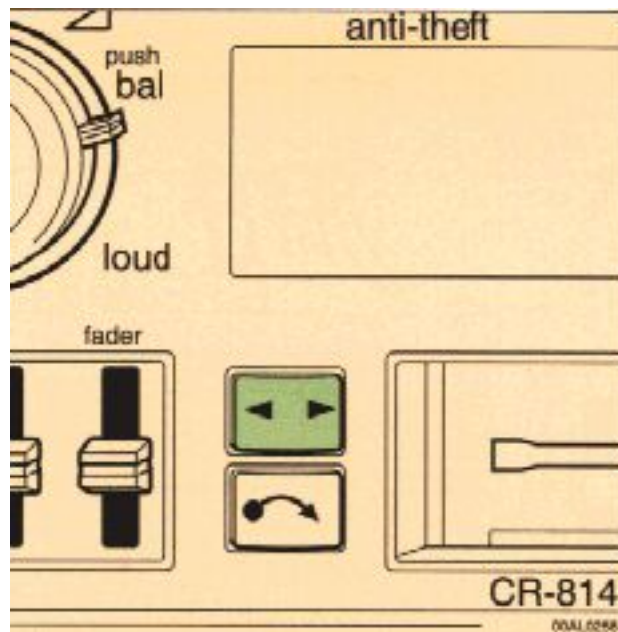

To re-enter Tape mode

If the tape player has been disconnected, but the cassette has not been ejected, the tape mode can be re-entered by pressing the  button.

pg. 1:26 Cassette deck (cont.)

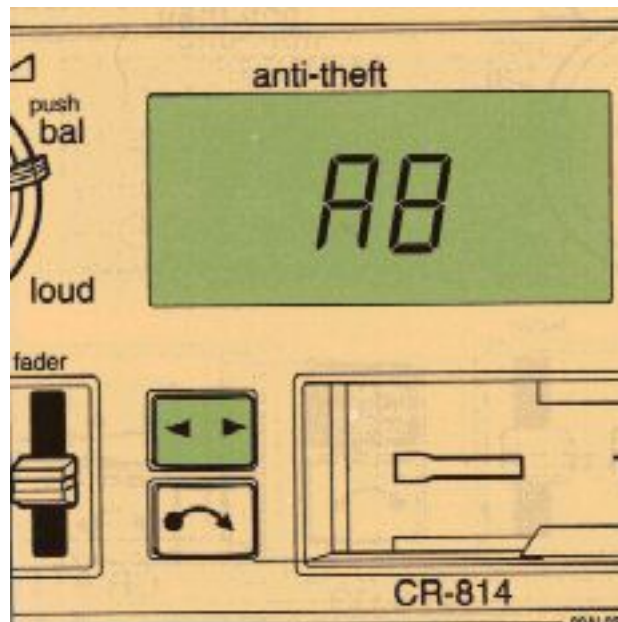

Tape direction (REV) 

Press the button to play the other side of the tape. The side being played is displayed.

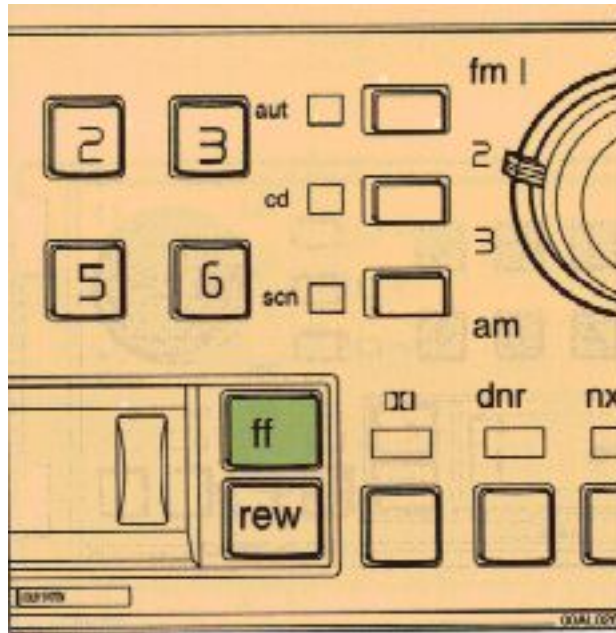

Fast winding

The tape is advanced with "ff" and rewound with "rew". The button flashes during fast winding. Stop fast winding by pushing the button once more.

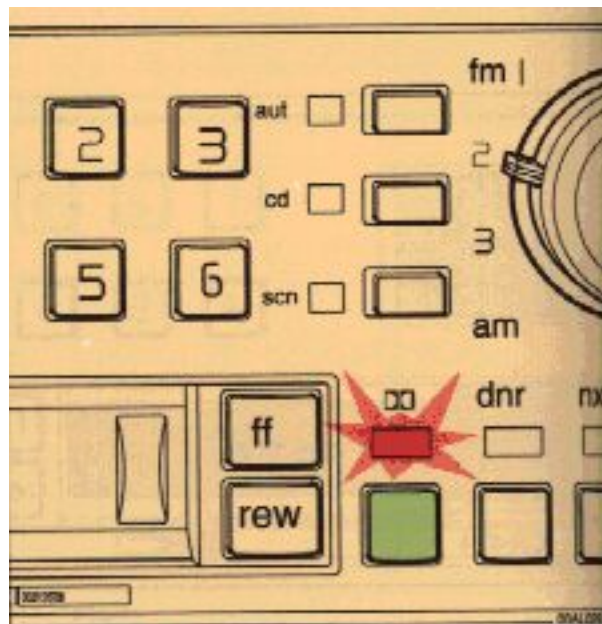

DOLBY B selector 



This set has a DOLBY B noise reduction system for tape playback. Depress the DOLBY selector when playing a DOLBY pre-recorded tape. This function should not be engaged for non-DOLBY tapes. The indicator lamp is lit when this function is engaged.

pg. 1:27 Cassette deck (cont.)

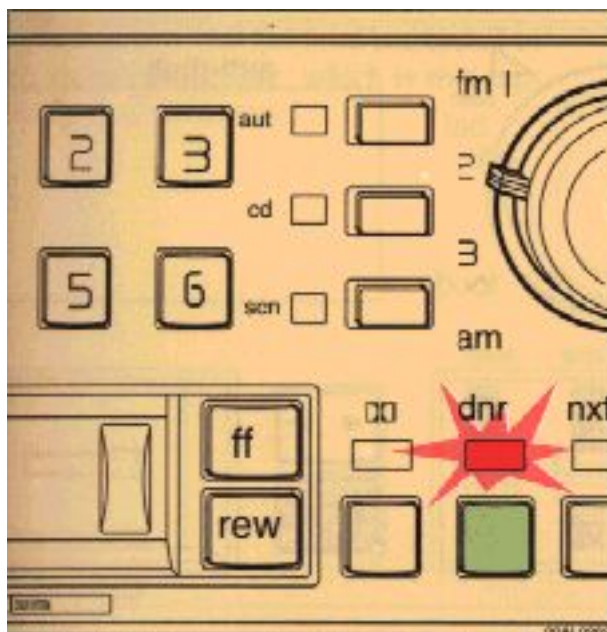

### DNR selector

This is a noise reduction system for tape playback and radio reception. It is effective even if the tape has not previously been recorded with DNR. The indicator lamp is lit when this function is engaged.

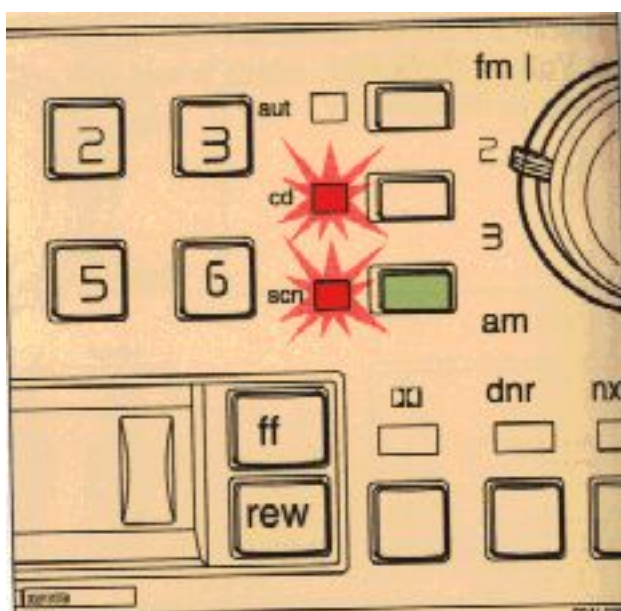

### Scanning

Depress the "scn" button. The tape player scans the entire tape and stops at every song for 8 seconds. Scanning is then resumed. If you want to retain the song press the "scn" button once more within the 8 seconds.

There must be a pause of approx. 5 seconds between the songs for this function to operate.

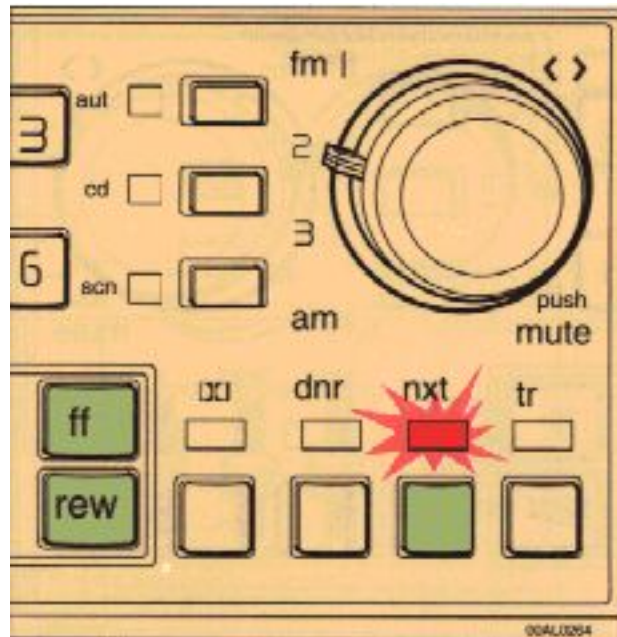

### NXT (next) selector

Press "nxt" and the indicator lamp is lit. If you press "ff" the tape will be advanced to the next song. If you press "rew" the tape will be rewound to the beginning of the song you just listened to. There must be a pause of approx. 5 seconds between the songs for this function to operate.

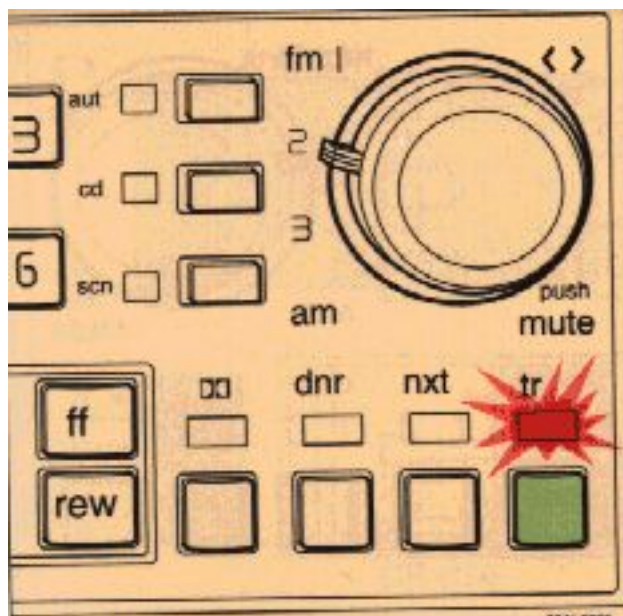

## Tuner recall

If the "ff", "rew", "scn" or "nxt" buttons are used, the radio is normally muted. However, if you depress the "tr" button the radio is tuned in while the tape is being wound. The last station listened to is automatically tuned. Once the tape starts to play again, the radio cuts out. This function can be permanently engaged. The "tr" indicator is then lit.

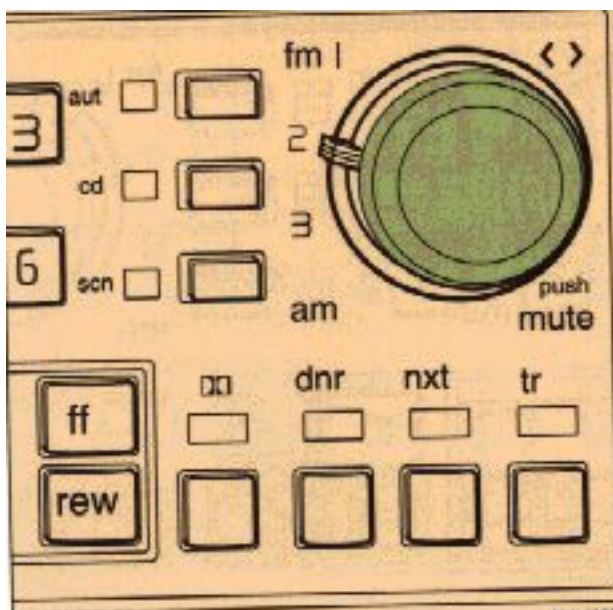

## Pause

If you press the tuning knob the tape is stopped and the set is silent. To start the tape press the knob again. "PAU" is displayed.

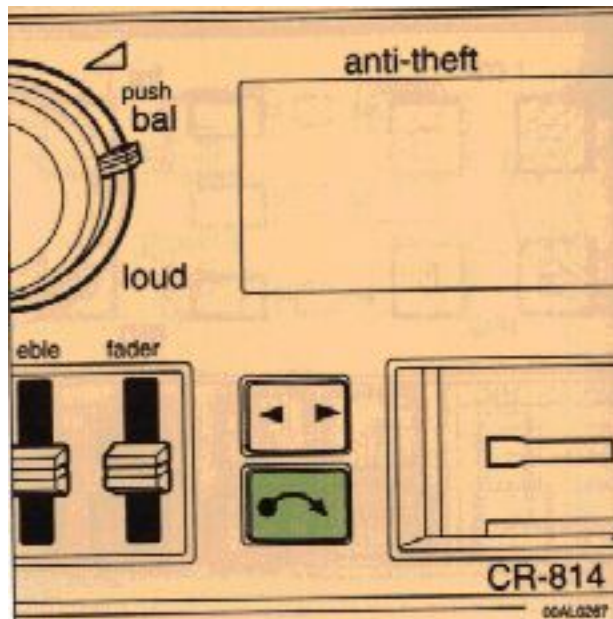

### Cassette eject

When this button is depressed the tape stops and the cassette is ejected. The radio automatically cuts in.

### Automatic Cleaning indicator

After approx. 10 - 15 hours operation, "CLN" is displayed, indicating that the tape heads should be cleaned!

We recommend the use of a Volvo Cleaning Cassette. Regular use maintains sound quality, cleans vital parts and prevents tape tangle.

pg. 1:29 CD - Remote (accessory)

The functions described below are only applicable if the set has been connected to the Volvo CD changer, which is sold separately as an accessory.

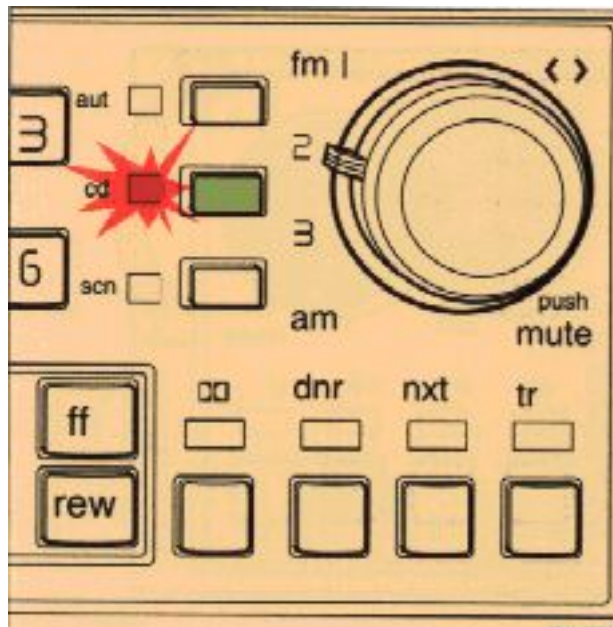

## CD mode selector

Press "cd" to actuate the CD mode.

The indicator is lit.

The disc/track last listened to will continue to play.

If the CD-changer cartridge is empty, "---" is displayed.

If a selected disc does not exist, the disc no. and "5--" is displayed, and the next disc is automatically selected.

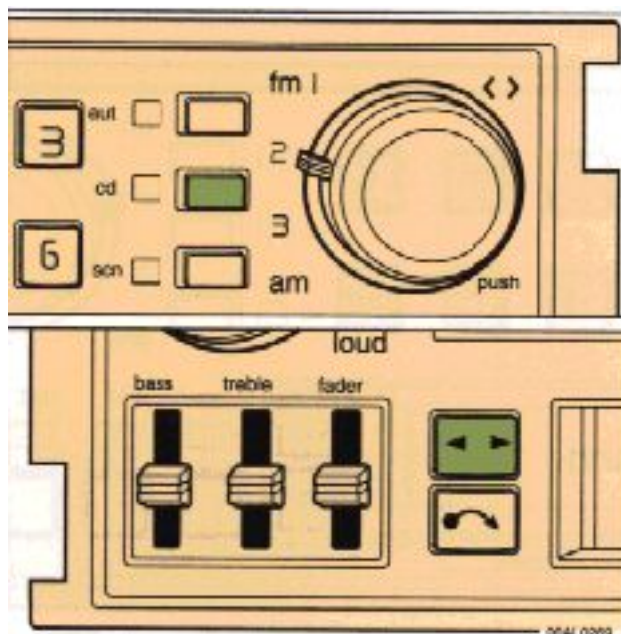



To re-enter radio mode

Press the "cd" button. The indicator light turns off.

To re-enter tape mode 

If a cassette is already inserted, the tape player will re-engage if the "rev" button is pressed

pg. 1:30 CD - Remote (accessory) (cont.)

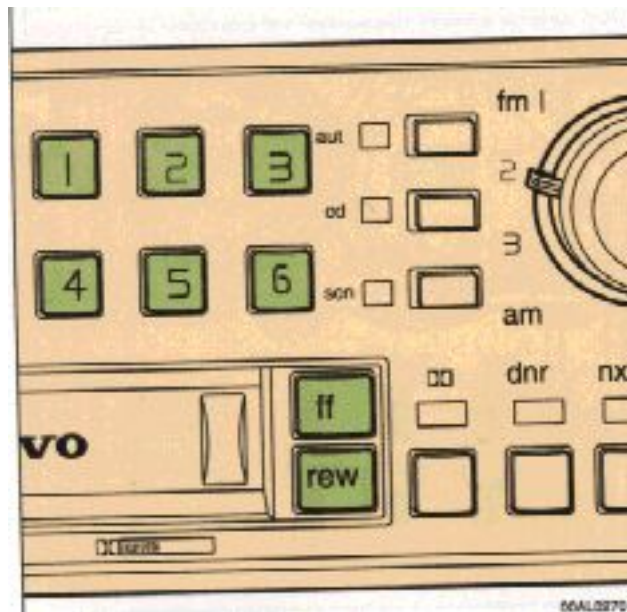

Disc no. selector

Depress one of the preset buttons ( 1-6) to select the disc number required. The selected disc no. and track no. is displayed.

Changing selected Disc no.

Press another preset button to change to another disc number. Press "ff" for forward selection or "rew" for backward selection. The chosen disc no. and track no. is displayed.

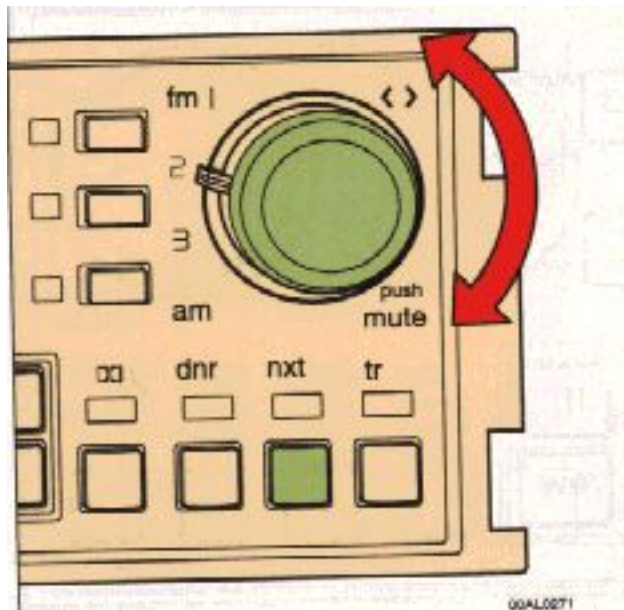

### Track no. selector

Turn the outer knob to select the track number required.

### Changing selected track no.

Turn the outer knob to change the selected track number or press "nxt" for forward selection. The chosen disc no. and track no. is displayed.

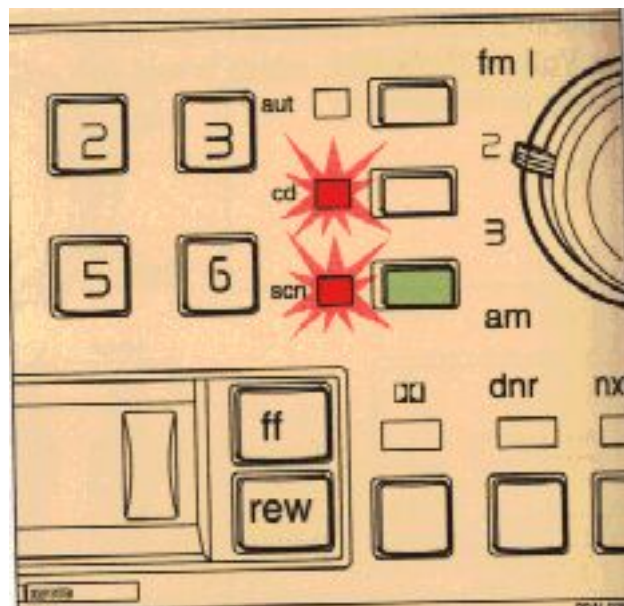

### Scanning

Depress the "scn" button. The set scans the entire disc and stops at every track for 8 seconds. Scanning is then resumed. If you want to retain the track press the "scn" button once more within the 8 seconds.

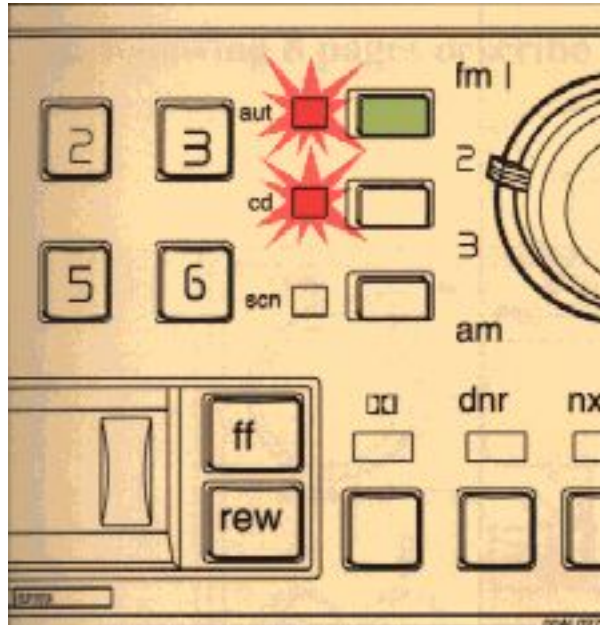

### Random choice

Press the "aut" button to actuate the random mode. From a disc chosen at random 5 songs are played (also chosen at random). A new disc is then played in the same way. The indicator lamp is lit when this function is engaged

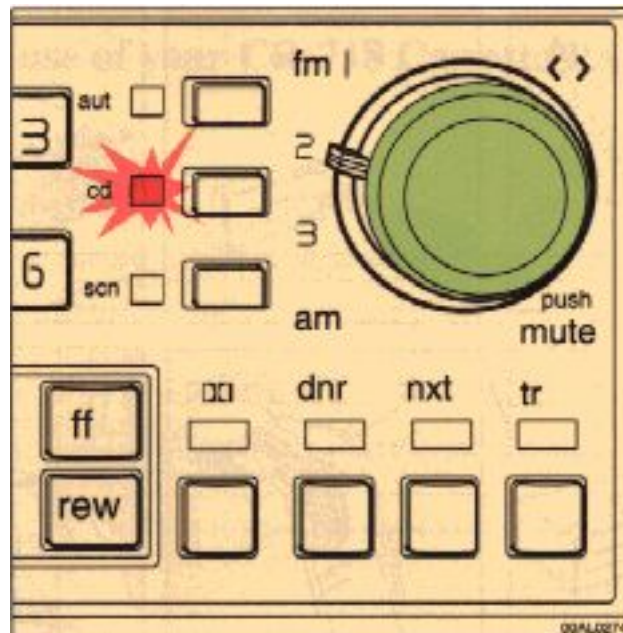

### Pause

If you press the tuning knob the disc is stopped and the set is silent. To start the disc press the knob

again. "PAU" is displayed.

pg. 1:32 CD - Remote (certain models)

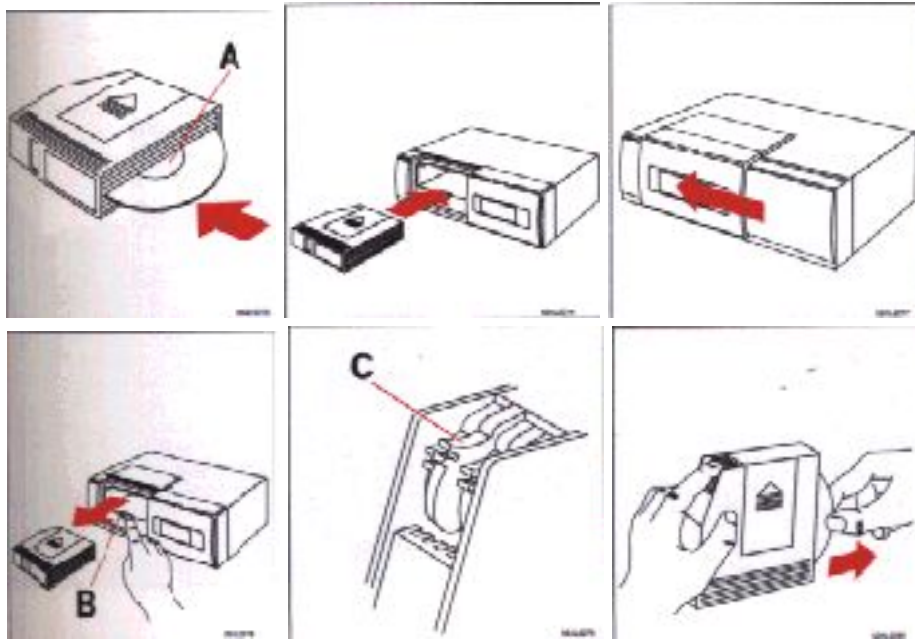

## CD changer

The CD changer, which is available separately, is loaded with a cartridge containing 6 discs. Extra cartridges are available at your Volvo dealer.

Insert the discs into the cartridge, label (A) up.

Insert the cartridge and close the cover.

Eject the cartridge by pressing the eject button (B).

Remove the discs by depressing the lock tabs (C).

## Operating tips:

- Before using a new disc for the first time, remove any burrs in the center/outer edge by running the stem of a pen or similar object around the hole/edge of the disc.
- Use high quality discs only.
- Keep the discs clean. Wipe them with a soft, clean, lint-free cloth, working from the center outwards. If necessary, dampen the cloth with a neutral soap solution. Dry thoroughly before using.
- Never use cleaning spray or anti-static liquid. Use only cleaners specifically made for CD's
- Use discs of the correct size only (3.5" discs should never be used).
- Do not put tape or labels on the disc itself.
- Condensation may occur on discs/optical components of the changer in cold winter weather. The disc can be dried with a clean, lint-free cloth. Optical components in the CD changer may, however, take up to one hour to dry off.
- Never attempt to play a disc which is damaged in any way.

- When not in use, the discs should be stored in their covers. Avoid storing discs in excessive heat, direct sunlight or dusty.



[Contents](#) | [Top of Page](#)



## pg. 1:33 Audio system, General description

The following 8 pages describe the use of your CR-718 Cassette Radio. See page 1:44 for specifications

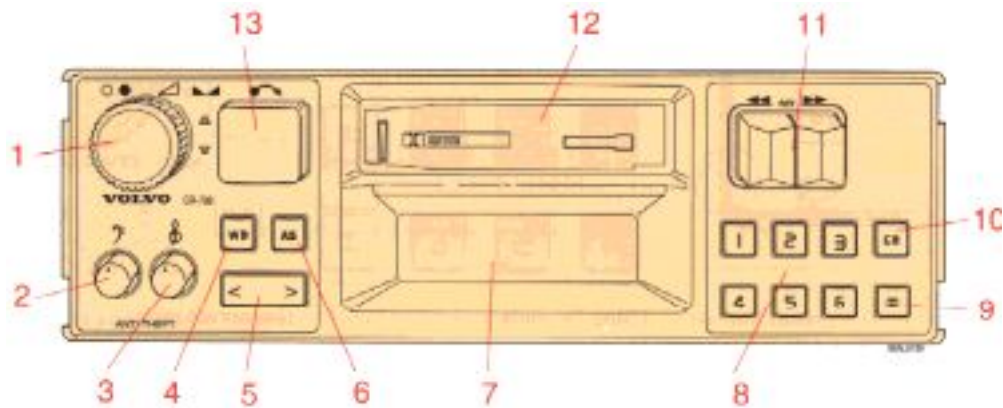

1.
  - On/off (turn)
  - Volume (turn)
  - Balance left/right (push-turn)
  - Fader front/rear (pull-turn)
2. Bass control
3. Treble control
4. Waveband selector
5. Frequency tuning up/down
6. Autostore
7. Display
8. Preset buttons
9. DOLBY selector
10. Chrome/metal selector
11.
  - Lockable fast winding (left/right)
  - Tape direction selector press both buttons
12. Cassette slot
13. Cassette eject

## pg. 1:34 Anti-theft code

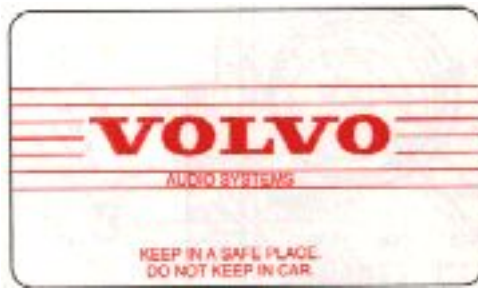

The radio features anti-theft circuitry. If the set is removed from the vehicle or if the battery power is disconnected, a special code must be entered to enable operation of the set. Refer to the radio code card supplied with your vehicle or ask your dealer for the correct code.

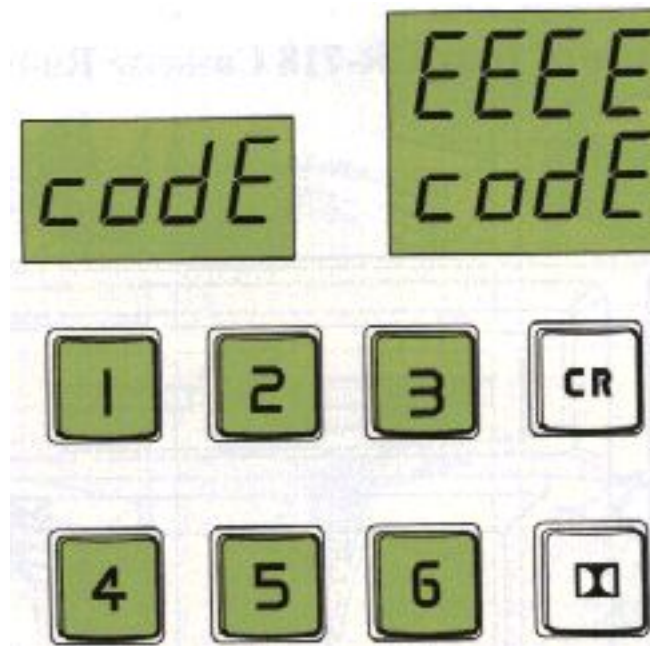

### Using the code

After installation or when the set has been disconnected from power, the set displays "code" when it is switched on.

Enter the 4-digit code using the preset buttons. If the correct code is entered, "code" is no longer displayed and the set is ready to use.

### Incorrect code

If an incorrect code has been entered "EEE" is displayed for 1 second and then "code". Enter the correct code. After three unsuccessful coding attempts the set locks for 2 hours. The unit must be connected and turned on during this time. Enter the code again once this time has elapsed.

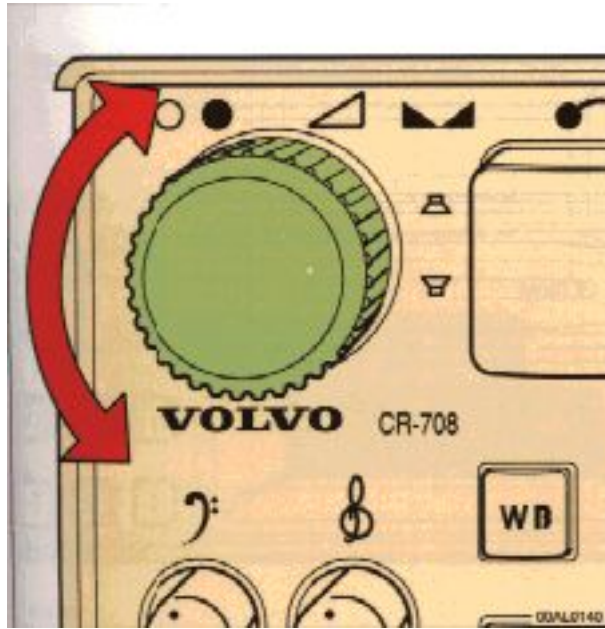

On/off switch and volume control

Turn the button clockwise to switch on and to increase volume.

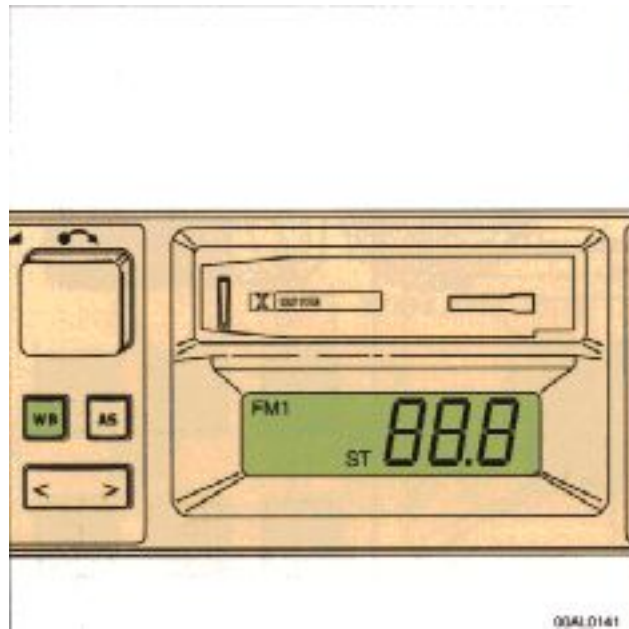

Waveband selector

The desired waveband is set by pressing the button. The frequency and waveband is shown on the display.

NOTE! There are two FM wavebands and one AM waveband. This makes it possible to store more FM stations in the memory.

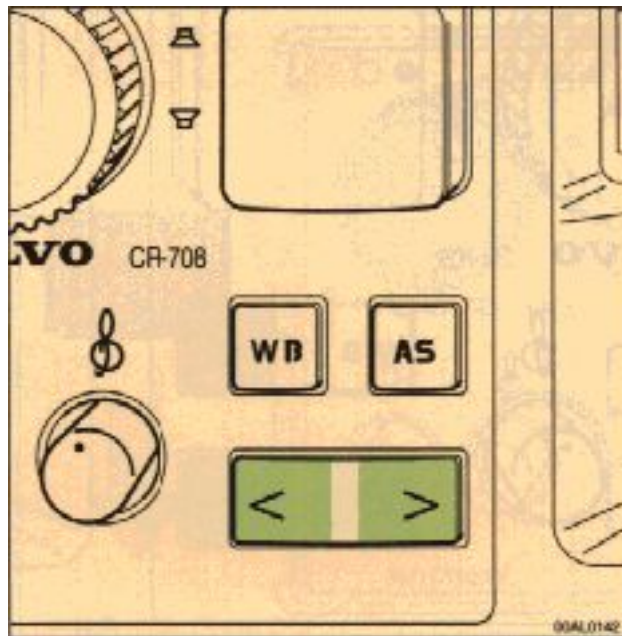

### Manual tuning

Press the left side of the button to tune down and the right side to tune up. Release the button when the desired frequency is displayed.

pg. 1:36 Radio (cont.)

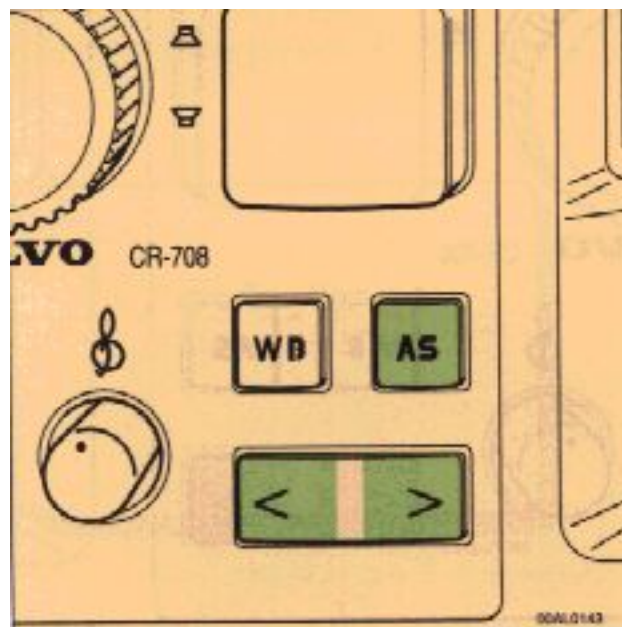

### Automatic programming (autostore)

This function works on the FM and AM wavebands and has 8 memories in autostore mode on each waveband. The antenna must be fully extended when using this function.

1. Depress and hold the "AS" button until "a" is displayed. Now a maximum of eight strong stations on the selected waveband are automatically stored in the autostore memory. The lowest frequency among these is transmitted. If there are no audible stations --- is displayed.
2. Press the "AS" button once again if you wish to listen to another memorized autostored station. for each press a new station is set. Change between stations in the autostore memory by pressing the tuning button to the left or right.
3. Press one of the preset buttons to leave the autostore mode.

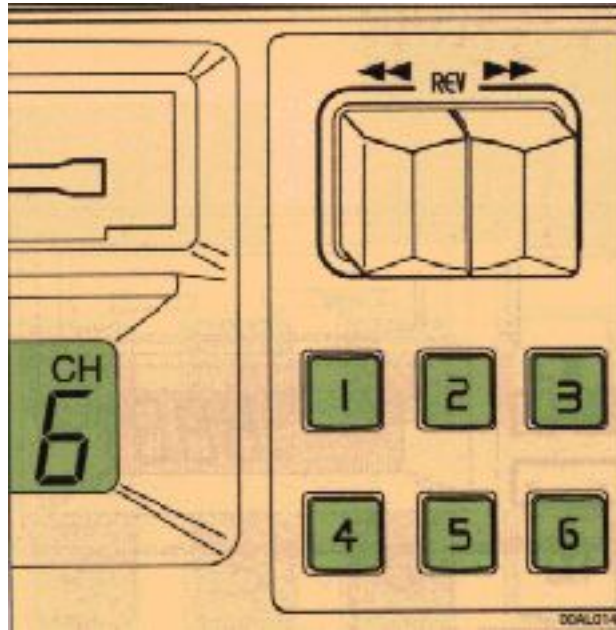

### Preset buttons

To select a pre-programmed radio frequency, depress the preset button. The preset button number and frequency will be displayed.



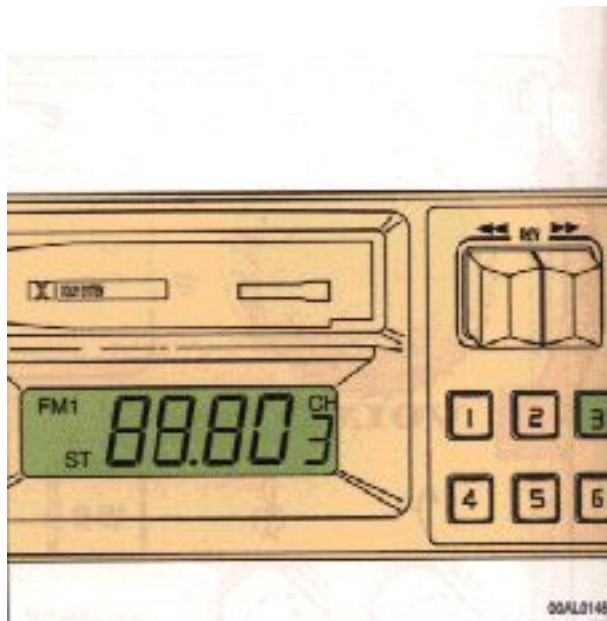

### Preset programming

1. Tune in to desired frequency.
2. Depress and hold a preset button. The audio cuts out. Keep the button depressed until the audio comes on (approx. 2 sec.).
3. The frequency is now stored on this preset button.

pg. 1:37 Radio (cont.)

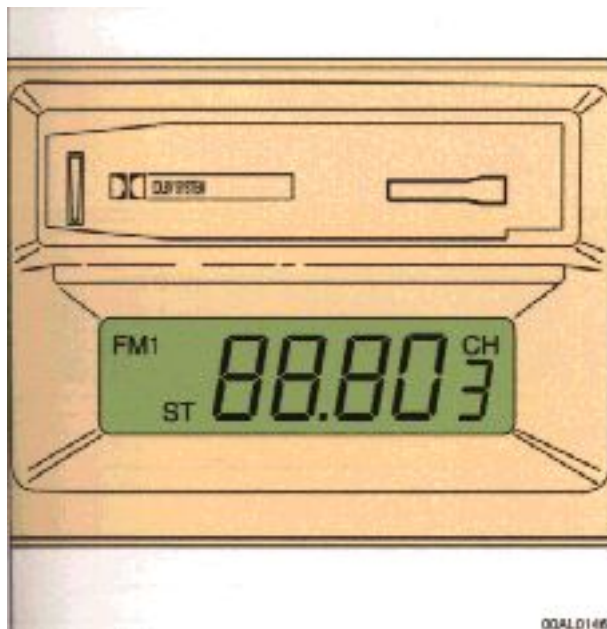

### Display

The display shows the selected waveband, preset number, frequency and ST (stereo).

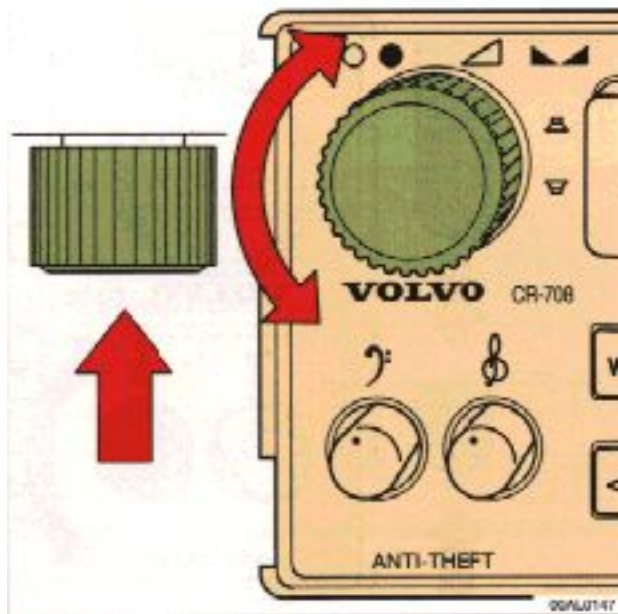

### Balance control

Push in the knob and turn it to the left or right to adjust left/right speaker balance. A "detent" indicates the equalized left/right balance position.

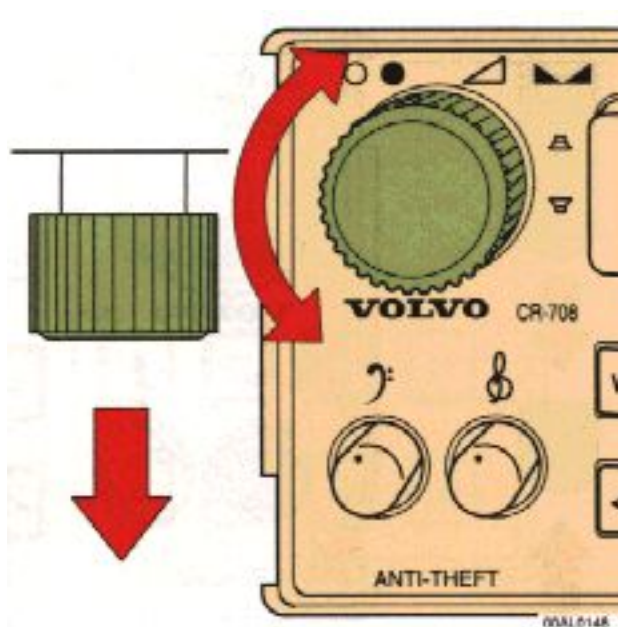

### Fader control

Pull out the knob and turn it to the left or right to adjust front/rear speaker balance. A "detent" indicates the equalized front/rear balanced position.

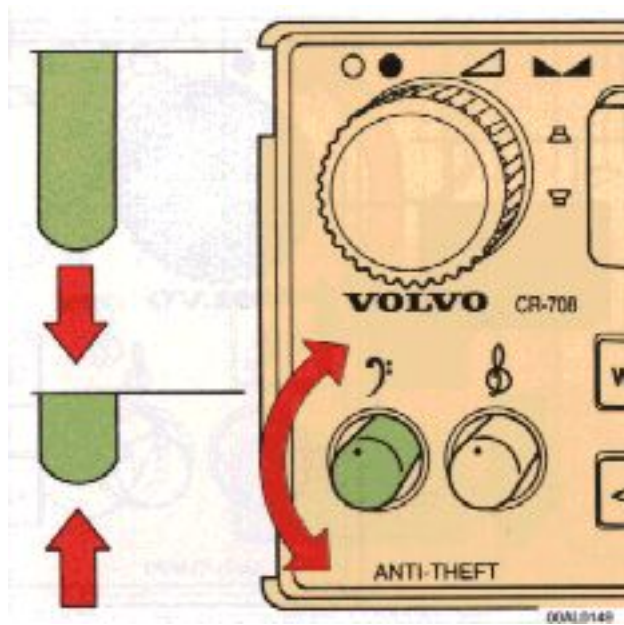

### Bass control

Adjust the bass by pulling out the button and turning it to the left or right. Depress the button after adjustment.

The "detent" indicates "equalized" bass.

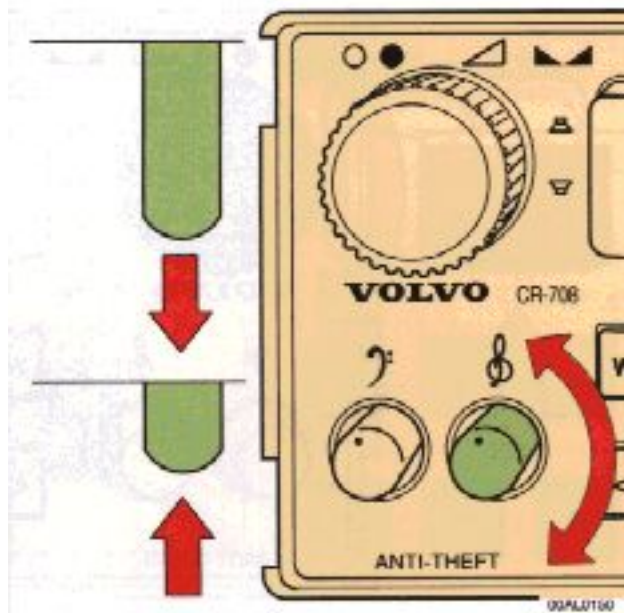

### Treble control

Adjust the treble by pulling out the button and turning it to the left or right. Depress the button after adjustment.

The "detent" indicates "equalized" treble.



[Contents](#) | [Top of Page](#)

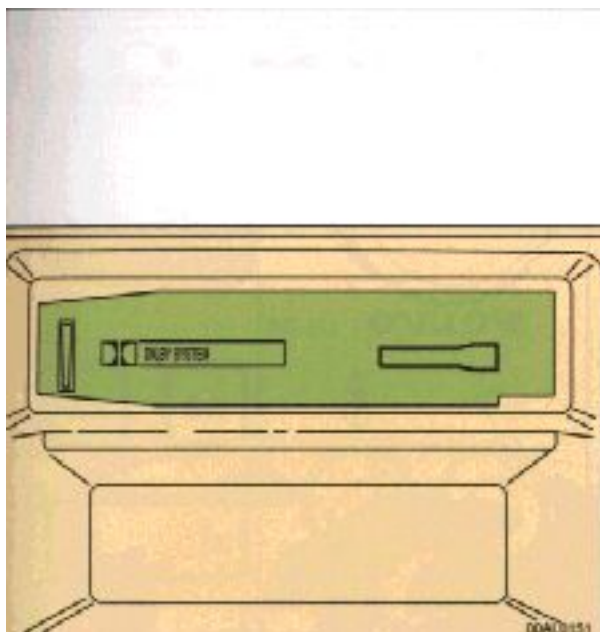

## Cassette slot

The cassette is inserted with the roll of tape to the right-hand side. When the cassette is inserted, the radio is automatically disengaged. Push the cassette gently into place. The cassette will start to play automatically. The arrows show the tape direction. When one side of the tape has been played the unit will automatically play the other side (auto-reverse). If the unit is switched off while playing a cassette, the cassette will remain in position. The drive rolls will be disconnected in order to avoid tape tangle (pinch-off).

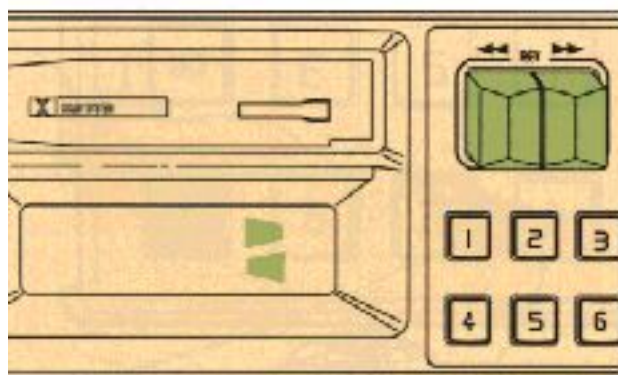

00AL0152

## Reversing the tape



Depress both buttons to play the other side of the tape.  
The arrows in the display indicate the direction of the tape.

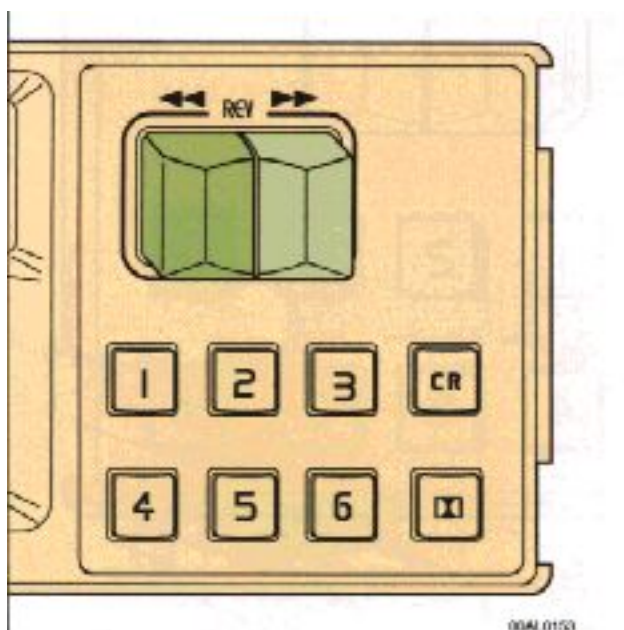

### Fast winding

Press either of these buttons (see arrows for direction) for fast winding. Depress fully to lock the button. Press opposite button to stop fast winding.

pg. 1:40 Cassette deck (cont.)

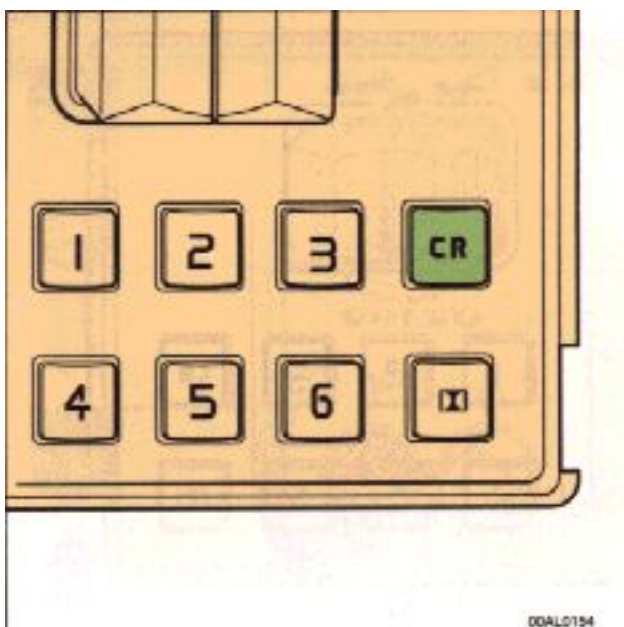

### Chrome/metal tape selector

Depress the "CR" selector before playing a chrome or metal tape. "CR" will be displayed. This function should not be engaged for standard tapes.

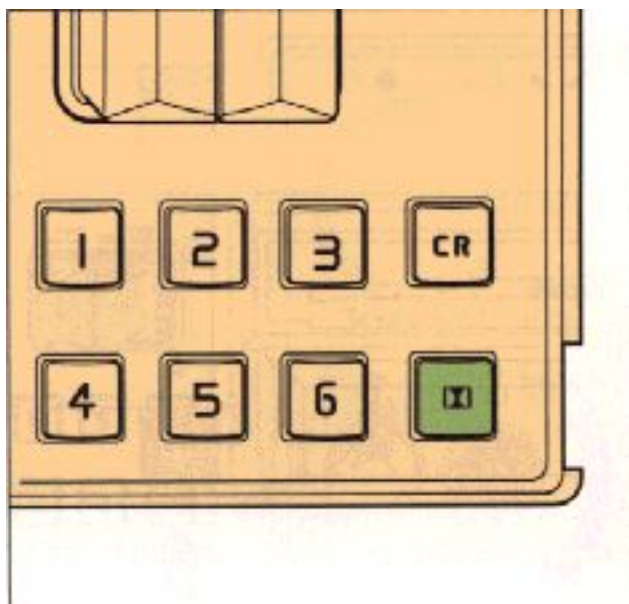

### DOLBY selector

This set has a DOLBY B noise reduction system. Depress the DOLBY selector when playing a DOLBY pre-recorded tape. DOLBY will be displayed. This function should not be engaged for non-DOLBY tapes.

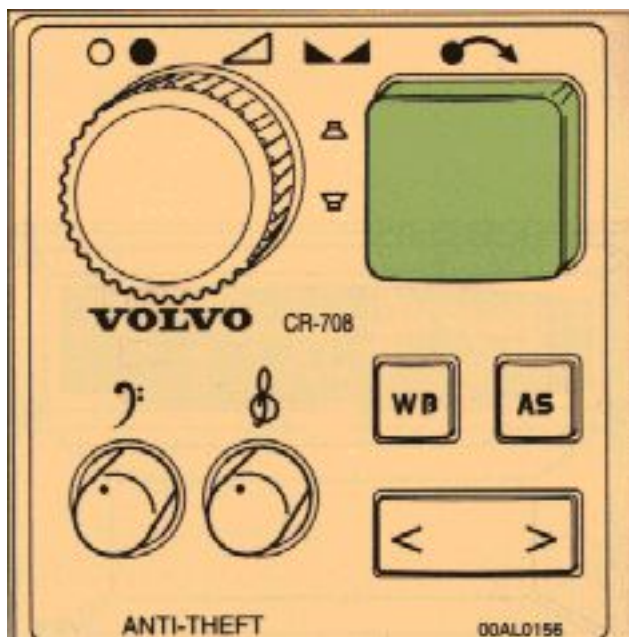

### Cassette eject

If the button is pressed the tape will stop and the cassette will be ejected. The radio will be automatically

engaged.

pg. 1:41 General information

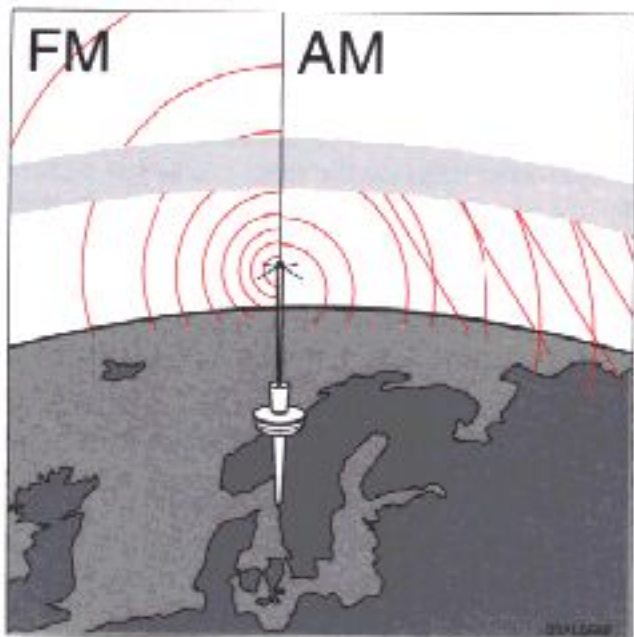

### Sending signals

The FM waves do not follow the earth's surface nor do they bounce off the atmosphere. for this reason their range is limited.

The AM waves follow the earth's surface and reflect against the atmosphere, giving them a wide range.

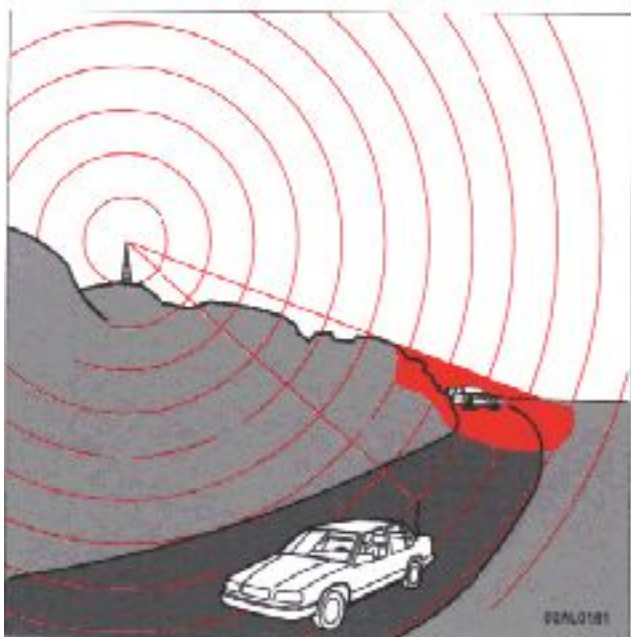

## Weak reception (fading)

Because of the limited range of the FM senders and the fact that these waves are very reflective, this problem usually occurs with FM reception. If the sender is blocked by buildings or mountains, static can result.

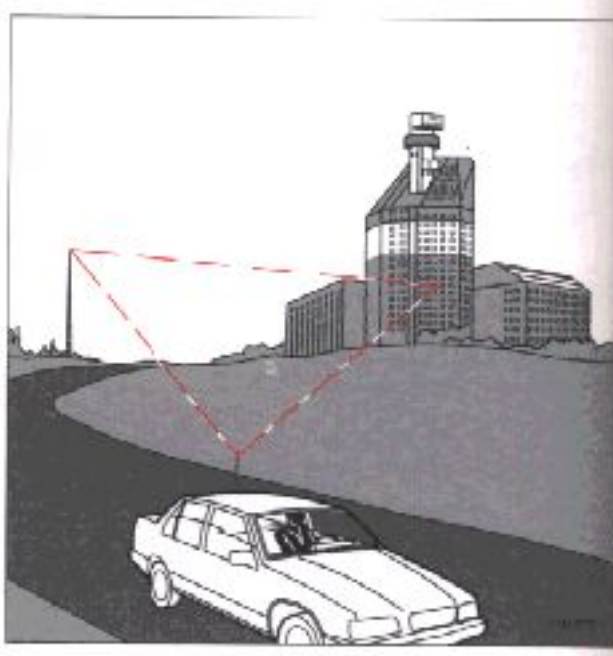

## Static

The reason why FM but not AM is audible in covered parking areas, under bridges, etc., is that FM signals reflect against solid objects such as buildings. Because these waves are very reflective, static can result. This static is the result of the reflected signal and the direct signal reaching your antenna at slightly different times causing a cancellation of all signals. This problem occurs largely in built-up areas.

pg. 1:42 Cross modulation, FM - reasons for distortion, AM - reasons for distortion

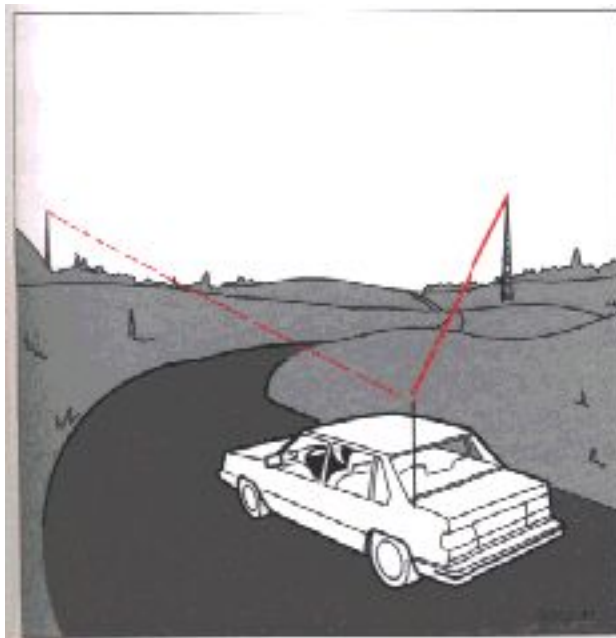

### Cross modulation

If you listen to a weak station in the vicinity of a stronger one, both stations may be received simultaneously.

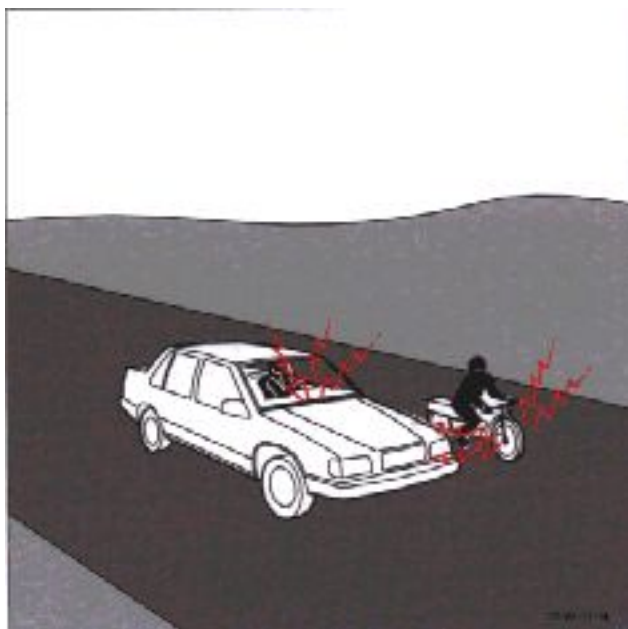

### FM - reasons for distortion

FM is affected by the electrical systems of nearby vehicles, especially those without suppression. The distortion increases if the station is weak or poorly set.

The FM reception is not as sensitive to electrical disturbances as AM.





## AM - reasons for distortion

AM reception is sensitive to electrical disturbances such as power lines, lighting, etc.

pg. 1:43 Radio

## FM stereo reception

Stereo reception places very high demands on the signal quality which means the type of distortions previously mentioned become even more obvious. The signal strength needs to be stronger for good stereo reception and this limits the effective range of the sender.

We hope that this information proves to be useful and provides you with a better understanding of the problems related to car radio reception.

Reception conditions are not always optimum and this is, of course, beyond our control. However, we have endeavored to make the Volvo Audio System of a quality that will enable you to enjoy the best possible reception no matter what the reception conditions may be.

## Radio antenna

**NOTE:** Always lower the antenna (by switching off the radio) when using an automatic car wash or entering a garage. The antenna should be cleaned at least every 10,000 miles (16,000 km) or more frequently if needed. Use WD40 for cleaning.

- Spray the antenna with WD40 and wipe it clean and dry with a rag. Spray it again.
- Lower and raise the antenna. Wipe it clean and dry again.
- Lower and raise the antenna 4-6 times. Make sure it is dry and free from dirt or lubricating oil.

pg. 1:44 Technical specifications

## Cleaning of magnetic head

In order to maintain the best possible sound quality and to ensure troublefree operation, Volvo recommends the use of Volvo Cleaning Cassette (available from your Volvo dealer) at regular intervals (10 to 15 hrs).

### Cassettes/Compact Discs

Store cassettes/discs in their cases.

Do not touch the tape/disc surface with your fingers.

Cassettes/discs should not be exposed to direct sunlight or extreme temperatures.

Keep cassettes/discs away from oil, grease and other contaminants.

for optimal tape deck performance Volvo does not recommend the use of C-120 tapes.

Take up tape slack using a pen or a pencil before inserting a cassette.

Never play a damaged disc. This may cause CD changer break-down.

### CR-814

#### Tape player

Fully logical, 4-track 2 channel stereo

DOLBY B and DNR

Channel separation 40 dB

Frequency range

Normal tapes 120 uS 40 dB

Chrome/metal tapes 70 uS 40 dB

Signal strength

- DOLBY B 65dB

- DOLBY OFF 55dB

Wow and flutter 0.13 %

Fuse 5 A

Spare fuses are available at your Volvo dealer.

#### Radio

Output 2 x 6W (10% dist.)

#### System

PLL system with tuned HF front end and

automatic wide band gain control

Tuning range CR-814 FM 87.9 - 107.9 MHz

AM 530 -1710 kHz

Sensitivity FM 2.0mV

AM 7.0mV  
Stereo separation 35dB  
CD changer  
See separate information  
CR-718  
Tape player  
4-track, 2-channel stereo  
DOLBY and CrO2 selector  
Tape speed: 4.76 cm/sec.  
Pinch-off  
Output: 2 x 6 W(10% dist.)  
Output impedance: 4 Ohms  
System voltage: 12 Volts, negative ground  
Fuse: 5 A  
System: Superheterodyne system with HF-step.  
Electronic suppression device  
Frequency range:  
CR - 718 FM 87.9 - 107.9 MHz  
AM 530 - 1700 kHz  
Sensitivity: FM 1.5 $\mu$ V  
AM 6.5 $\mu$ V

---



[Contents](#) | [Top of Page](#)

pg. 1:6 Lighting, Turn signals, Hazard warning flasher



## Headlights and parking lights

 All lights off \*

 Parking lights on \*\*

 Headlights and parking lights are on if starting (ignition) switch is in position I or II.

If the headlight switch is in position  all lights will go out when starting switch is switched off.

With the headlight switch in position  the parking lights will stay on (headlights off) with the daytime running light switch (A) in position .

The high beams can only be switched on if the headlight switch is in position .

Switch from high to low beams, and vice versa, by moving the turn signal switch lever on the left side of the steering column towards the steering wheel.

\* Models equipped with daytime running lights:

The low beams will come on automatically when the engine is switched.

## Turn signals

1 Lane change position : In maneuvers such as lane changing, the driver can flash the turn signals by moving the turn signal lever to the first stop and holding it there. The lever will return to the neutral position when released.

2 Signal lever engaged for normal turns

Note: Defective turn signal bulb will cause turn signal indicator and remaining signal lights to flash more rapidly than normal.

3 High beam/low beam switch (headlights on)

Move the lever towards the steering wheel and release it.

3 Headlight flasher (headlights off)

Move the lever towards the steering wheel.

The headlight high beam will be on until the lever is released.

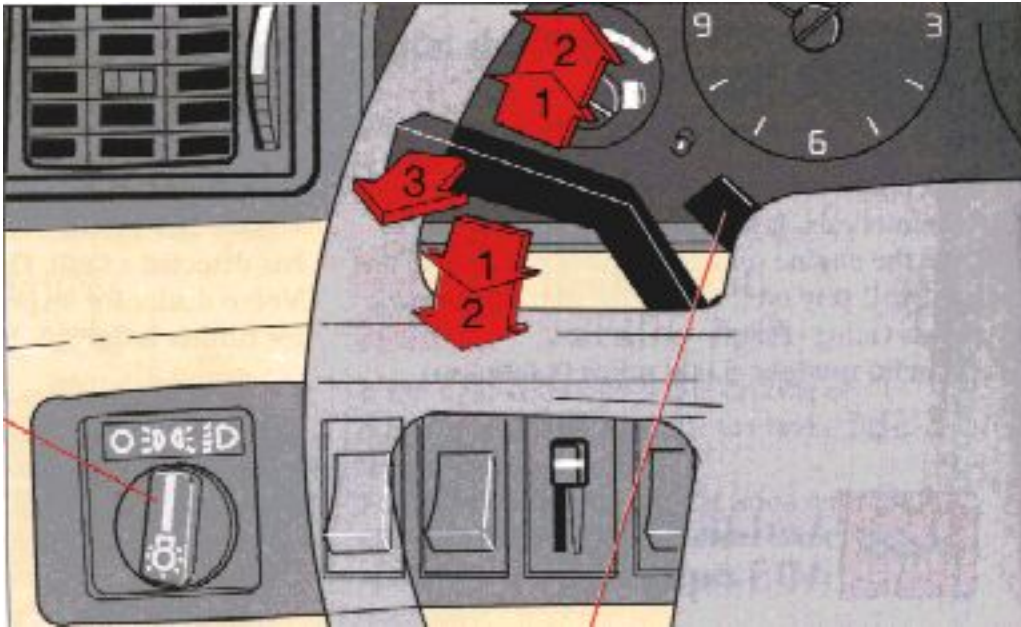

## Hazard warning flasher

The four-way flasher should be used to indicate that the vehicle has become a traffic hazard.

NOTE: Regulations regarding the use of the hazard warning flasher may vary from state to state.

pg. 1:7 Windshield, wipers/washers, Ignition switch

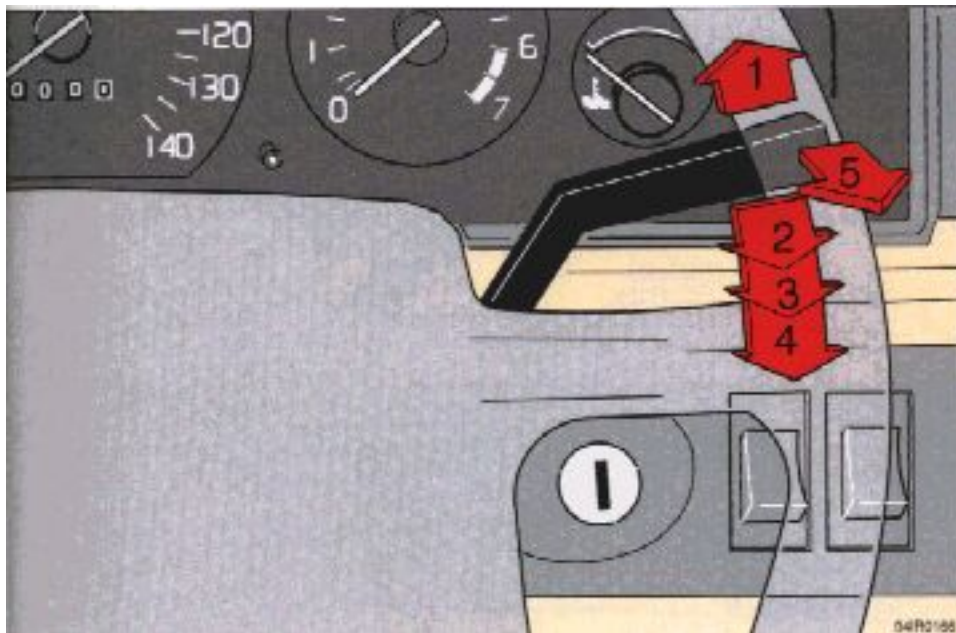

## Wipers/washer



1 Intermittent wiper.

With switch in this position, the wipers will sweep approximately every seventh second.

2 "Single sweep" position.

Switch returns automatically when released

3 Wipers, low speed.

4 Wipers, high speed

5 Windshield wiper/washer, headlight wiper/washer (certain models)

The wiper will make 2-3 complete sweeps across the windshield and headlights after lever is released.

Starting (ignition) switch/steering wheel lock

The steering wheel lock might be under tension when the car is parked. Turn the steering wheel slightly to free the ignition key. In order to reduce car theft, make sure the steering wheel lock is engaged before leaving the car.

A chime will sound if the starting key is left in the ignition lock and the front door on the driver's side is opened.

0 Locked position:

remove the key to lock the steering wheel.

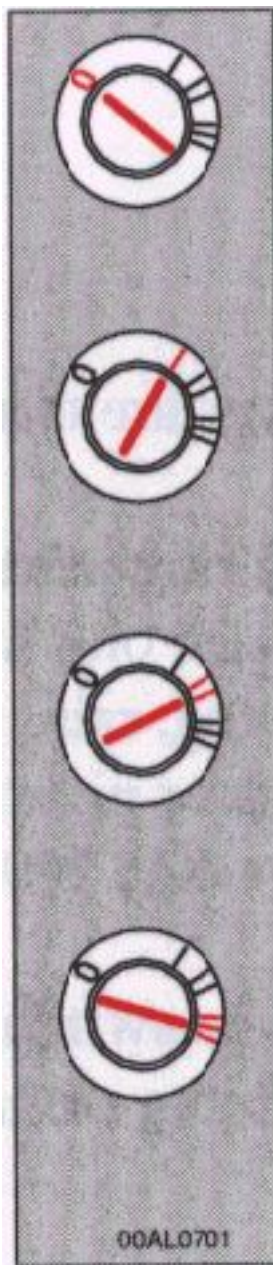
**WARNING:**

Never turn the key to position 0 while driving or when the car is being towed.

**I Intermediate position:**

Certain accessories etc. on.

**II Drive position:**

key position when engine is running.

**III Starting position:**

release the key when the engine start. The key returns automatically to the Drive position.

\* The gear selector must be in the (P)ark position before the key can be removed from the ignition switch.

pg. 1:8 fog lights, Instrument illumination

Rear fog light only (certain models)

On models equipped with a rear foglight only, the switch has no indicator lamp. The rear foglight is considerably brighter than the normal tail lights and should be used only when the atmospheric conditions, such as fog, rain, snow, smoke or dust reduce the daytime or nighttime visibility of other vehicles to less than 500 ft (150 meters). The lowbeam headlights must be switched on. Note that the local regulations governing the use of these lights may vary.



## Front and rear foglights (certain models)

The switch has two settings:

- 1 Front foglights ON.
- 2 Front and rear foglights ON.

When both front and rear foglights are turned on both indicators will light.

The rear foglight is considerably brighter than the normal tail light and should be used only when the atmospheric conditions, such as fog, rain, snow, smoke or dust reduce the daytime or nighttime visibility of other vehicles to less than 500 ft (150 meters).

The lowbeam headlights must be switched on. Note that local regulations governing the use of these lights may vary.

## Instrument illumination

To increase the brightness, move the slide switch up.

To decrease the brightness, move the slide switch down.

## Power antenna

The power antenna switch can be used to retract the antenna when the audio system is turned on. This will permit operation of the cassette drive with the antenna in the down position.

**CAUTION:** Always lower the antenna when entering a garage or car wash to avoid antenna damage.

The antenna mast should be cleaned and lubricated every 10,000 miles (16,000 km). See page 1:43



pg. 1:9 Rear window demister, Electrically-operated sun roof, Tailgate wiper/washer

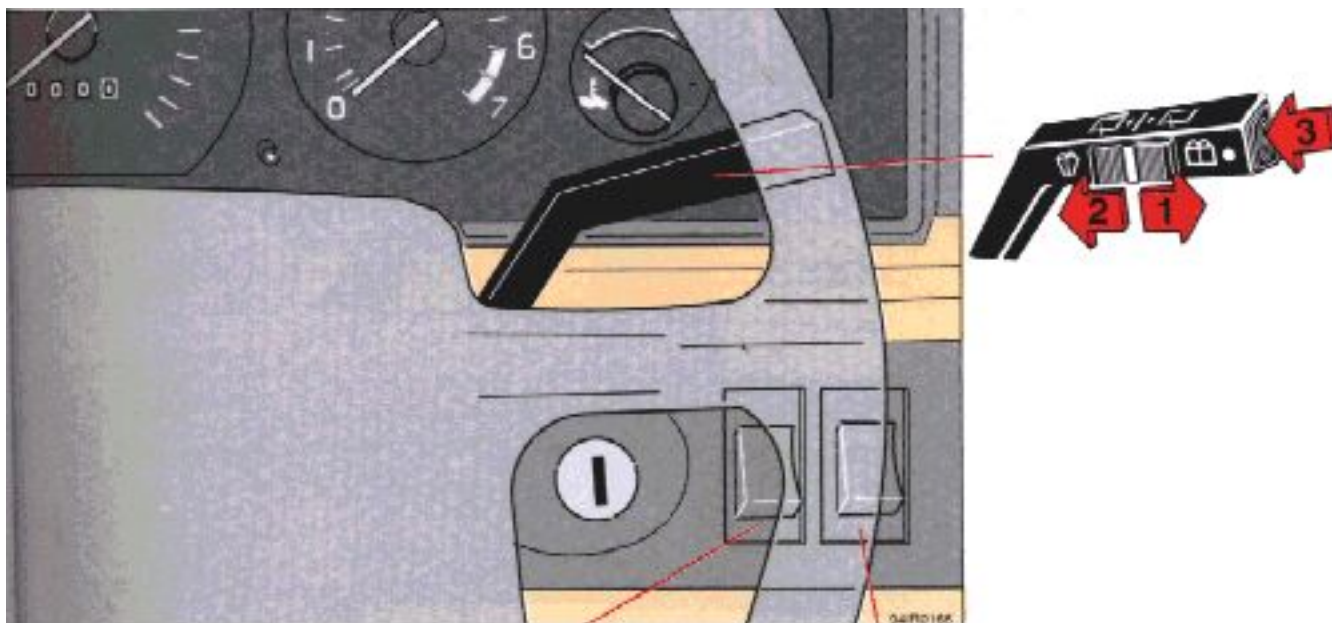

### Rear window demister

To operate, depress the switch. The indicator lamp in the switch will come on.

### Electrically-operated sun roof

To open the sun roof as a sliding roof, depress the top portion of the rocker switch.

To raise the rear edge of the sun roof, depress the bottom portion of the switch.

To close the sun roof, depress the side of the rocker switch opposite the side used to open the sun roof.

NOTE: In case of a sun roof malfunction, see "Emergency sun roof operation", page 6:18

## Tailgate window wiper/washer (wagon)

The tailgate window wiper/washer is operated by a switch at the end of the wiper level.

1. The wiper operates continuously.
2. Intermittent position: the wiper strokes approximately every 10 seconds.
3. Tailgate washer.

After the button is released the wiper strokes 2-3 additional times before stopping.

The electrical circuit is protected by fuse 14, located in the central electrical unit. See the section entitled "Fuses".

pg. 1:10 Cruise control

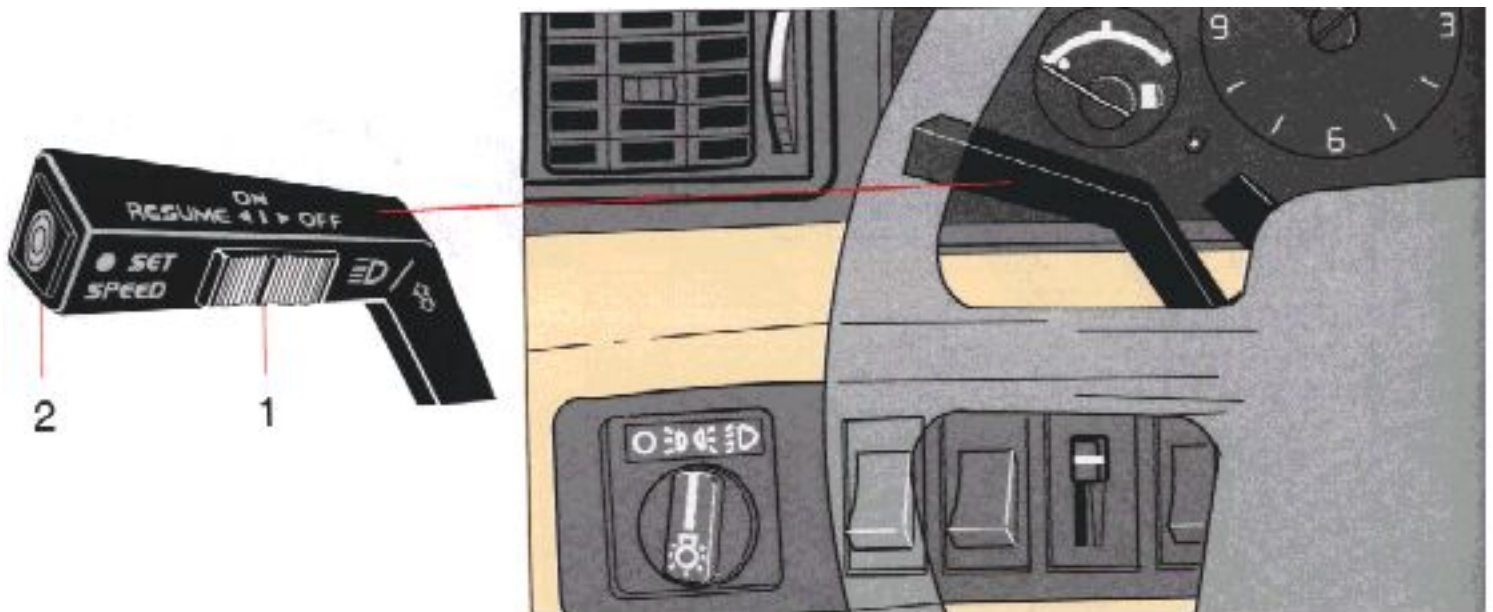

## Cruise control

The cruise control switches are located on the turn signal switch lever.

To engage and set desired speed:

- Set switch (1) to ON.
- Accelerate to desired cruise speed.
- Depress SET SPEED switch (2).



**NOTE:** The cruise control cannot be engaged at speeds below 22 mph (35 km).

### Operating brake pedal

This will automatically disengage the cruise control. Previously selected cruise control speed is retained in the memory and by momentarily setting the switch to RESUME position, that speed will be re-engaged.

### Acceleration

If the cruise control is already engaged, the cruising speed can be increased or decreased by depressing the SET SPEED button (2). The vehicle will then maintain the current speed.

Depressing the SET SPEED button briefly will result in a 1 mph (1.6 km/h) increase in the set speed.

### NOTE:

When driving on a grade, actual vehicle speed may vary slightly from the set cruise control speed. If actual speed falls below 70% of set speed or if the wheels spin, the cruise control will disengage automatically.

Momentary acceleration, such as for passing, does not interrupt cruise control operation. The previously selected speed will be maintained without having to set switch to RESUME.

To disengage the cruise control system : set switch (1) to position OFF, or depress the brake pedal. Switching off the starting (ignition) switch or moving the gear selector to position N will automatically disengage the cruise control system.

**WARNING!** The cruise control should not be used in heavy traffic or when driving on wet or slippery roads. Do not use or resume cruise control in reverse gear.



[Contents](#) | [Top of Page](#)

## Body and interior

### pg. 2:1 Body and interior

#### Body and interior

The seats, seat belts, doors, sun roof, mirrors, etc. are described on the following pages.

[2:2](#) Doors and Locks

[2:4](#) Front seats

[2:5](#) Rear-view/side-view mirrors

[2:6](#) Interior light, sun roof

[2:7](#) Child safety locks, Trunk lid (sedan)

[2:8](#) Storage spaces

[2:9](#) Hood

[2:10](#) Trunk, long load storage

[2:11](#) Tailgate/child safety lock (wagon)

[2:12](#) Station wagon tailgate, storage spaces (wagon)

[2:13](#) forlding rear seat (wagon)

[2:14](#) Removing seat cushions, Securing cargo

[2:15](#) Cargo space lighting, spare tire, jack (wagon)

### pg. 2:2 Keys

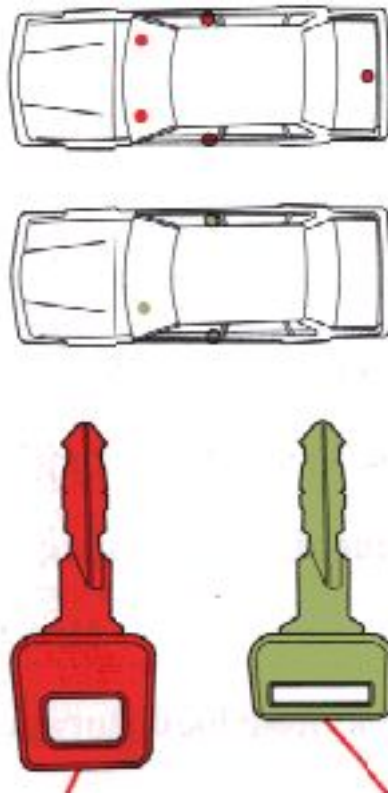

Master key Service key  
This key operates all Front doors  
locks in the vehicle. Starting (ignition)/Steering wheel lock

Number tag



The key number codes are stamped on a separate tag supplied with the keys. This tag should be separated from the key ring and kept in a safe place. The back of the tag is coated with adhesive tape. In the event of the original keys are lost, duplicates may be ordered from your Volvo dealer. The central locking system is described in detail in section Doors and locks.

## Door locks

The vehicle is equipped with a central locking system. This means the lock on the driver's door controls the locks on the other doors (including the trunk or tailgate) automatically.

If the driver's door is locked or unlocked from the outside using the key, the other doors will be locked or unlocked automatically.

To lock/unlock the car by using the lock button on the inside of the driver's door, push/pull to lock/unlock all the doors. Check the action of the buttons on the other doors to verify their correct function (lock/unlock). The driver's door can be locked only by using the key when outside the vehicle.

**WARNING!**

The lock buttons should not be in the down position during driving. In case of an accident, this may hinder rapid access to the occupants of the vehicle. Also see information on "child safety locks".

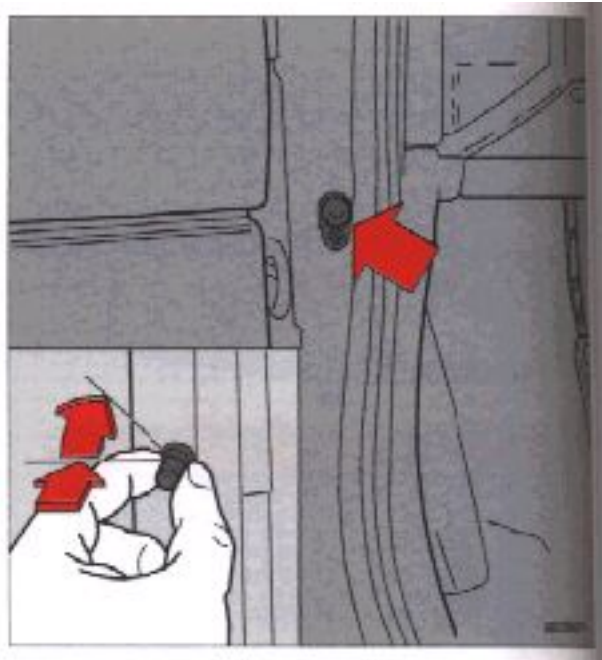

To avoid battery drain

The interior light and the warning lights in the rear of the doors come on when a door is opened. To avoid battery drain when the doors are opened for prolonged periods, these lights can be switched off by pushing in and turning the door light switches slightly clockwise. When the door is closed the switch will return to its normal position.

pg. 2:4 Front seats

Height adjustment (manual)

The front section of the driver's seat can be adjusted to three height positions and the rear section to four. Lever forward = front height adjustment

Lever rearward = rear height adjustment  
Do not adjust the seat while driving.

The front and rear sections of the passenger's seat can each be adjusted to two positions. Suitable tools must be used to carry out the adjustments.

fore-aft seat adjustment (manual)

Pull control upward, then slide seat forward or rearward to desired position.  
Make sure that the seat is properly secured when you release the control.

Seat back inclination adjustment (manual)

Rotate control clockwise to tilt seat back rearward.  
Rotate counterclockwise to tilt seat back forward.  
Note that body weight must be shifted to allow seat back to move forward or rearward.

Electrically operated driver's seats (certain models)



A Seat front ( raise/lower )

B forward - rearward

C Seat rear ( raise/lower )

D Backrest tilt



**WARNING!** Do not adjust the seat while driving. The seat should be adjusted so that the brake pedal can be depressed fully. In addition, position the seat as far rearward as comfort and control allow. The seat rails on the floor must not be obstructed in any way when the seat is moved.

The starting (ignition) key (certain models) must be in at least position I before the seat can be operated.

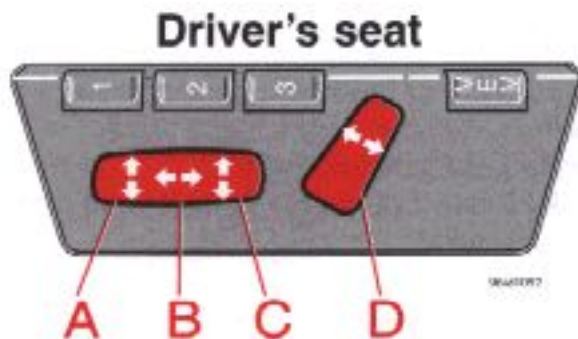

Movement of the driver's seat can be STOPPED at any time by pressing any button on the seat's control panel.

**WARNING!** The driver's seat is operable with the ignition OFF. Therefore, children should never be left unattended in the car.



### Programming the memory

Three seat positions can be programmed. To program a seat position:

1. Adjust the seat to the desired position.
2. Depress the MEM button.
3. Press button 1 to program the current position of the seat.

Buttons 2 and 3 can be programmed in the same way for two additional seat positions. To move the seat to a programmed position, depress button 1, 2 or 3 until the seat stops. If the button is released before the seat has reached the programmed position, it will stop as a safety precaution.

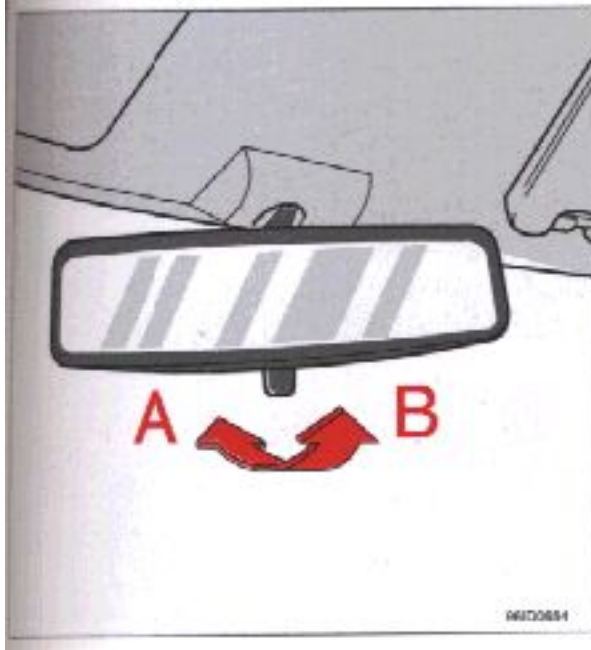

Rear-view mirror

A Normal position

B Night position, reduces glare from following headlights

**CAUTION:** Never use ice scrapers made of metal as they can easily scratch the mirror surface.

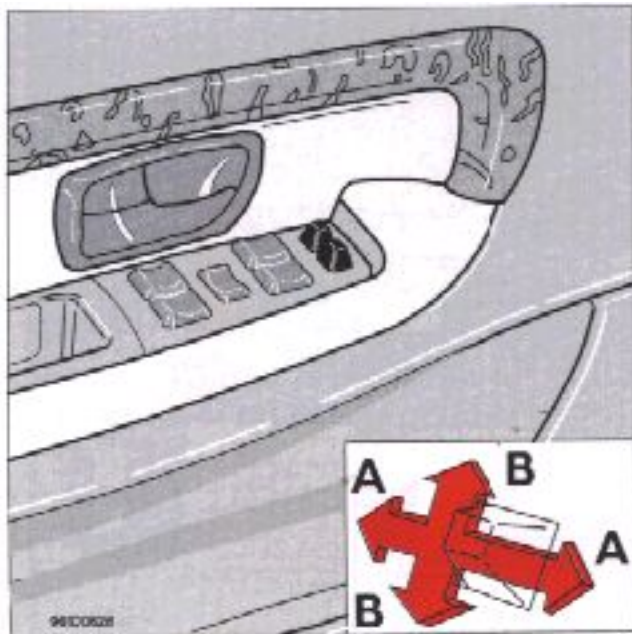

*Control switches*

## Electrically-operated side-view mirrors

The control switches are located in the driver's door armrest.

A Adjustment sideways

B Adjustment up/down

**WARNING!** Objects seen in the wide-angle right side-view mirror are closer than they appear to be.

The mirrors should always be adjusted prior to driving.

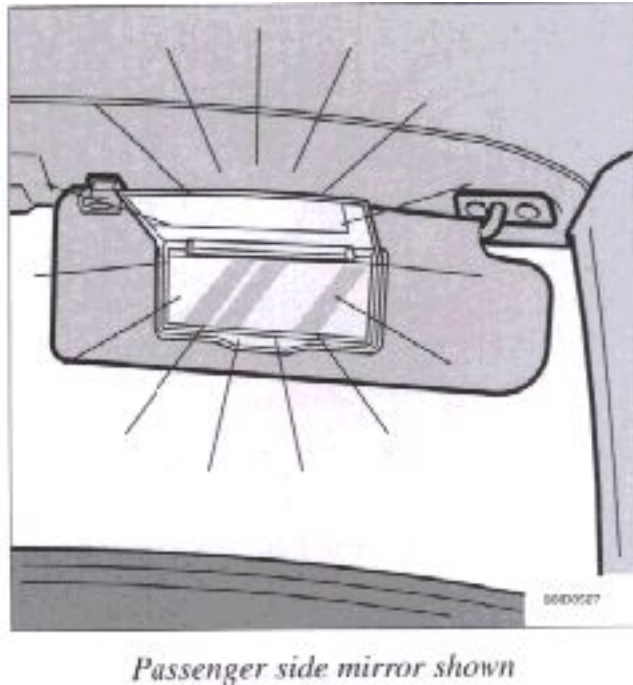

*Passenger side mirror shown*

## Vanity mirrors

The vanity mirrors are located on both front sun visors (certain models).  
The lamps light up when the covers are opened.



[Contents](#) | [Top of Page](#)

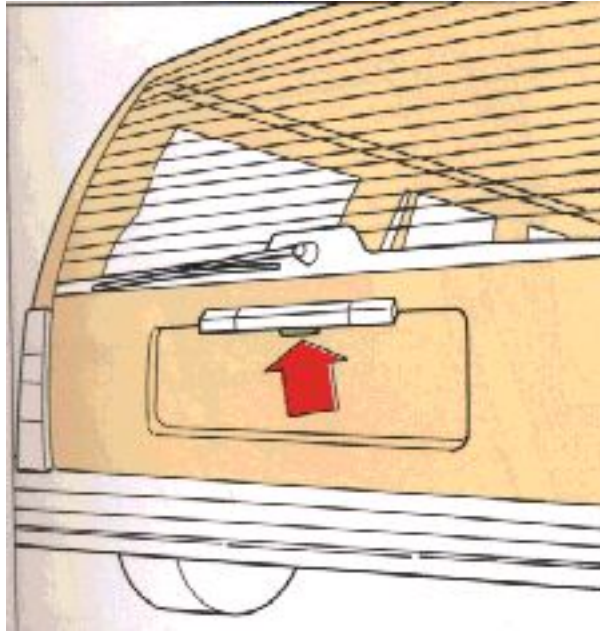

*Opening the tailgate*

### *Tailgate*

To unlock - turn the key clockwise and allow it to spring back.

To lock - turn the key counter-clockwise and allow it to spring back.

**NOTE:** If the vehicle has a central locking system the tailgate will be unlocked and locked at the same time as the driver's door. The tailgate is opened by pressing up the catch on the handle.

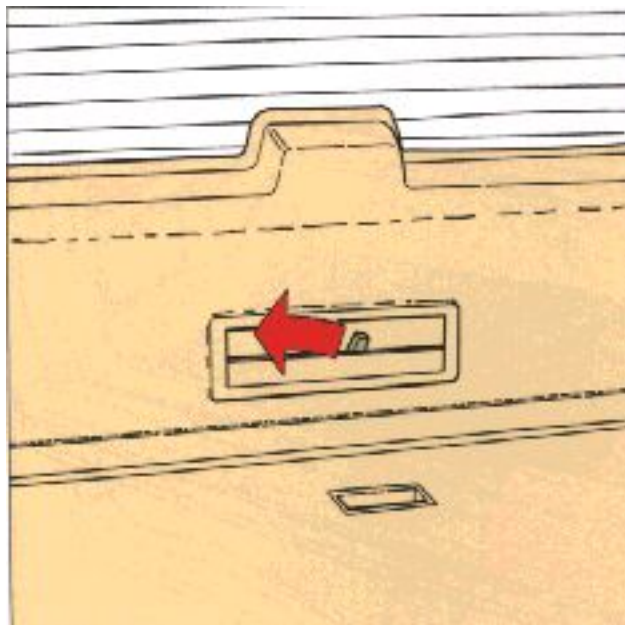

*Opening from the inside*

*To open the tailgate from the inside of the vehicle move the lever to the left and push outwards.*

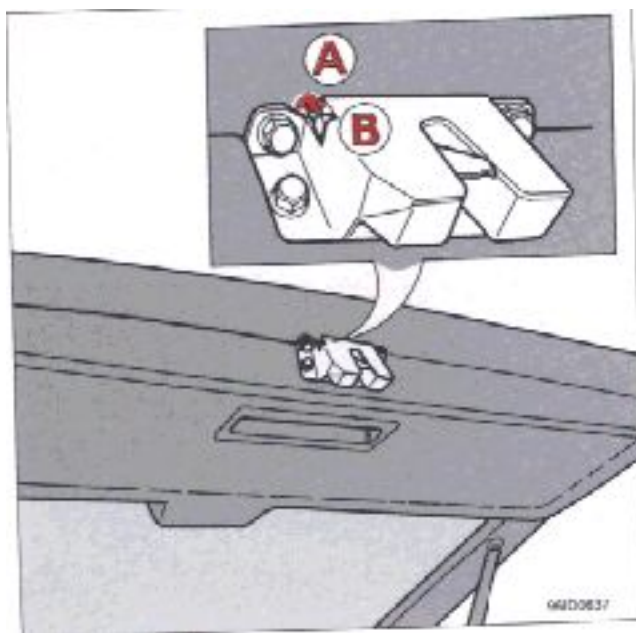

*Location and setting of child safety lock*

## Child Safety lock

The tailgate incorporates a safety catch which is located to the side of the lock.

A the tailgate functions normally

B the tailgate cannot be opened from the inside.



pg. 2:12 Concealed storage bins, Rear seat head restraints (wagon)

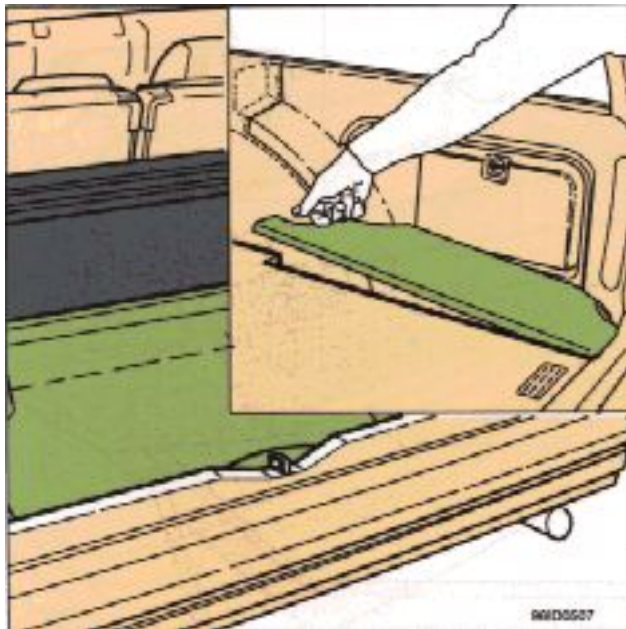

*Opening the small storage bin*

*Concealed storage bins*

There are 3 storage bins under the floor of the cargo space; the largest bin can be locked with a key.

The lid of the largest storage bin is hinged in the middle.

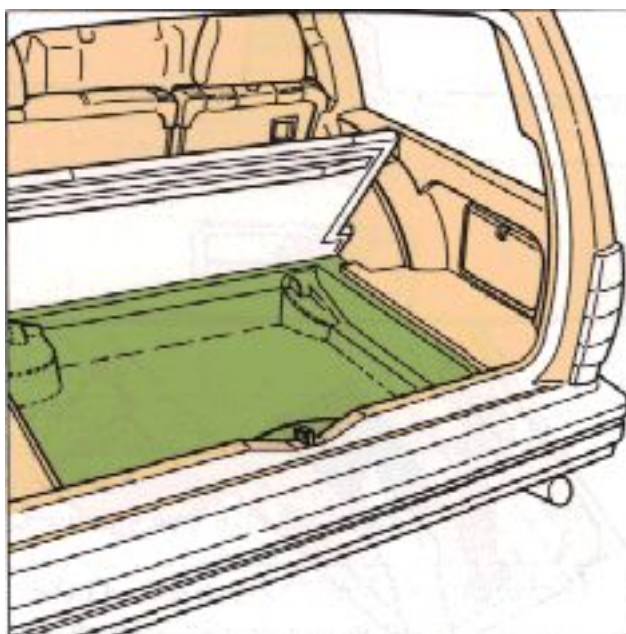

The lid of the largest bin is hinged in the middle (not useable if the auxiliary child seat is installed).

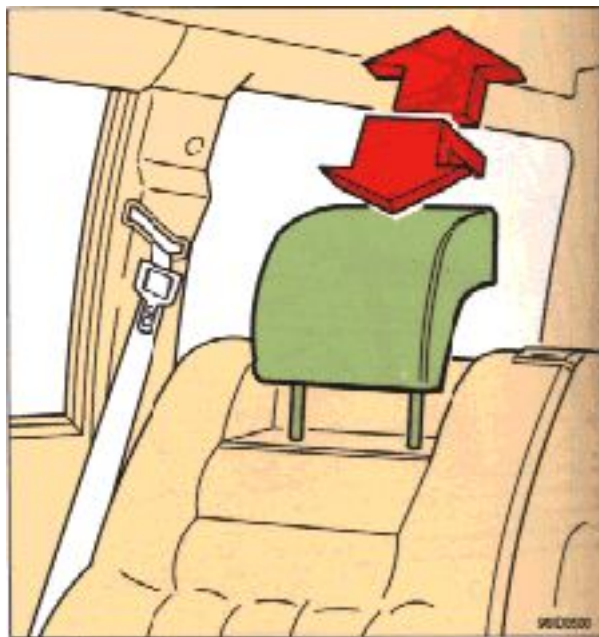

forlding rear seat; increasing the cargo space

The rear head restraints can be raised by pulling straight up or lowered by grasping the restraint, pulling it slightly forward and pushing down.

pg. 2:13 forlding rear seat (wagon)



*Seat cushion strap*

The rear seat is split 60/40 so that each section can be forlded independently.

Straighten front backrests if they are tilted too far to the rear.

Pull the strap to lift the seat cushion and swing the cushion up and toward the back of the front seats.

Move the backrest release lever rearward and forld the backrest down.

The center head restraint must be lowered manually if it has been raised. The outboard head restraints retract automatically and do not need to be lowered before the backrest is forlde down.

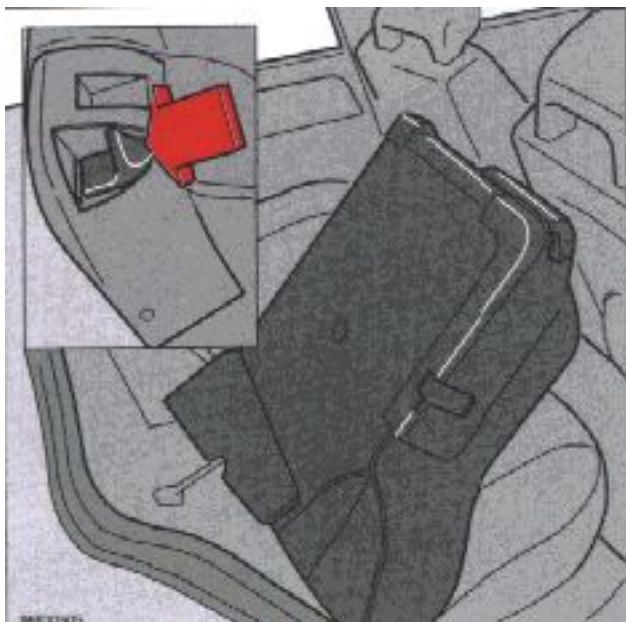

*Release lever - backrest*

*When the backrest is raised, the outboard head restraints return to their normal position and must be raised manually if required.*

*The backrest must lock into place. The red lock indicator will not be visible if the seat has locked into place incorrectly.*

**WARNING!** When the rear seat is forlde down, do not place heavy objects against the backs of the front seat. This places a severe strain on the forlde down backrest of the rear seat. Be sure to secure cargo. Cargo must not be stacked higher than the top of seatbacks. This will reduce the possibility of luggage, etc. becoming projectiles during sudden maneuvers, rapid braking or an accident. The red lock indicator is visible when the backrest is NOT locked in position and not visible when the backrest is correctly locked in place. Passengers should never sit in the rear seat when the backrest is not locked in place.



*Latches fit into holes*

**CAUTION:** Check that latches under seat cushions engage holes at top edge of backrest.  
Seat belts must be correctly positioned as seat is returned to normal position.

pg. 2:14 Removing seat cushions, Tool box, Securing cargo (wagon)

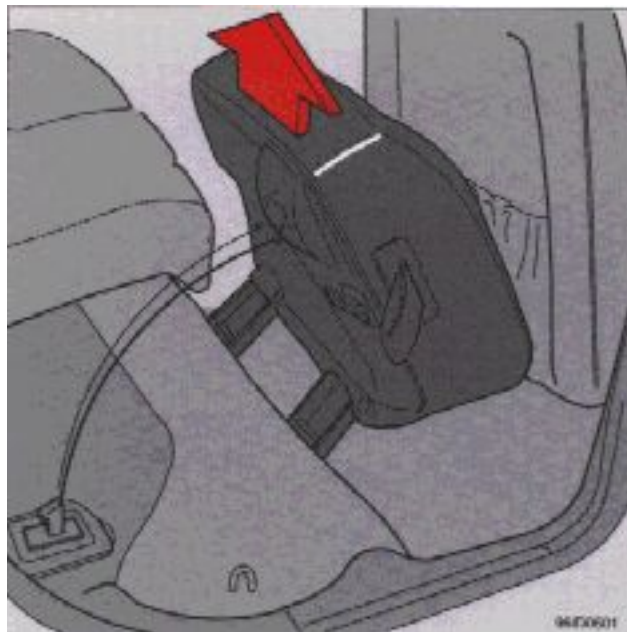

*Lift the seat cushion part way and remove the seat.*

### *Removing seat cushions*

The seat cushion can be easily removed to provide a slightly larger cargo storage area. To remove, lift

seat cushion out of the hinges.



*Tool box*

Tool box

The tool box can be released by turning the catch.

**WARNING!** Do not place extremely heavy articles the front seats, as the backrest which is folded down is then placed under severe strain.  
Be sure to secure cargo. Hard and sharp articles could otherwise damage the frontseat backrest and/or cause injury to passengers in the event of rapid braking or a collision.



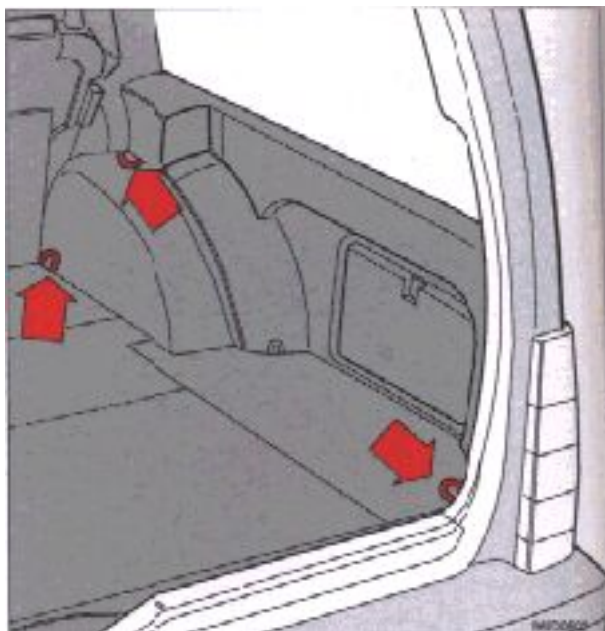

*Always secure cargo*

## Securing cargo

As a safety precaution, the cargo space is equipped with six eyelets to which straps can be attached to secure luggage.

**WARNING!** The eyelets are not to be used as passenger restraints. See page 3:8. Unless the wagon is equipped with Volvo's auxiliary seat for children (option), passengers should not ride in this section of the car.

pg. 2:15 Cargo space lighting, Spare tire and jack (wagon)

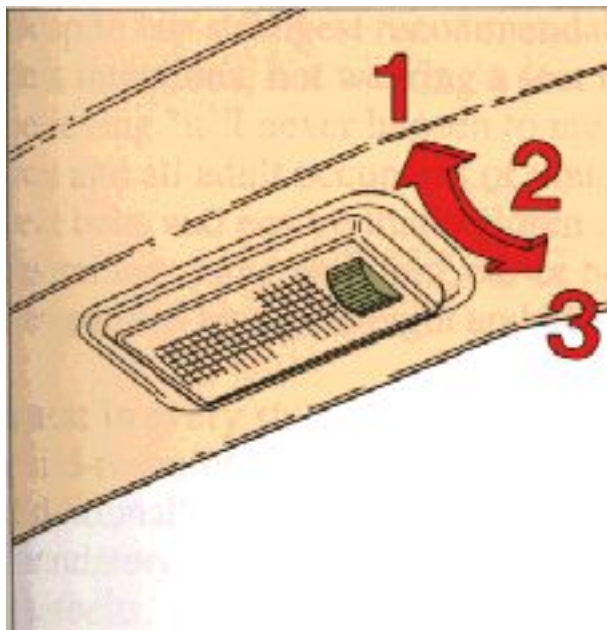



## Switch positions

### Cargo space lighting

There is an extra courtesy light at the rear of the cargo space.

- 1 Light comes on when the tailgate is opened
- 2 The light is always OFF
- 3 The light is always ON

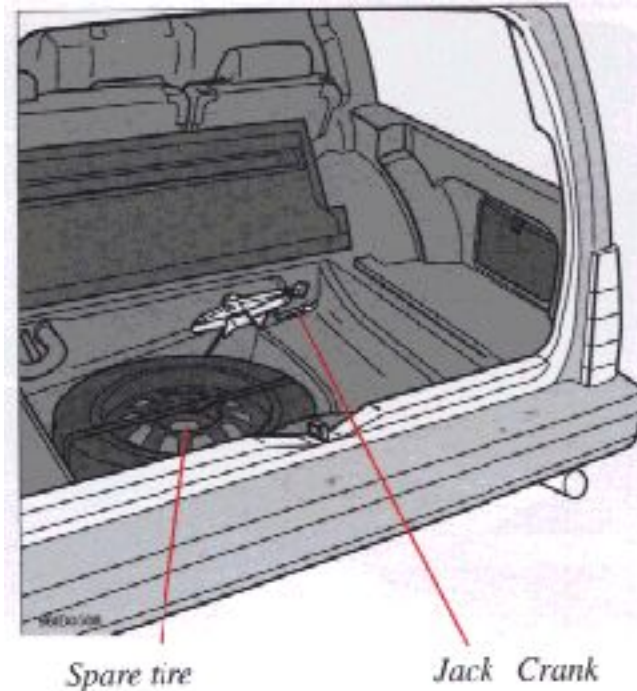

Spare tire and jack

*Spare tire*

*Jack*

*Crank*

Spare tire and jack

The spare tire and the jack are located beneath the floor mat in the large storage bin. Always secure the spare tire and the jack to prevent them from rattling.

**NOTE:** See pages 6:3-6:4 for information on how the jack should be used.



[Contents](#) | [Top of Page](#)

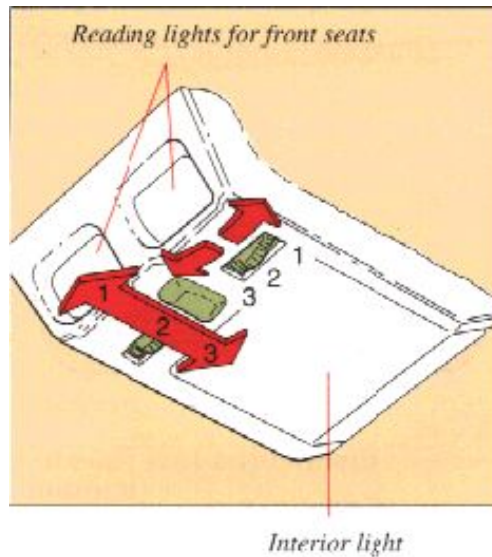

### Interior light

- 1 Light always on.
- 2 Light always off
- 3 Light is on when either of the front or rear doors are opened.

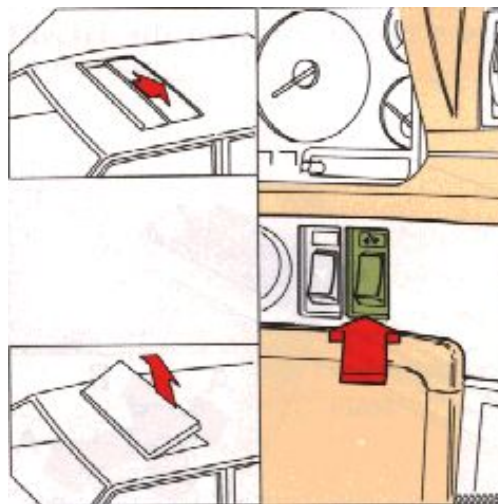

*Switch for electrically-operated sun roof*

### Electrically-operated sun roof (certain models)

To open the sun roof as a sliding roof, depress the top portion of the rocker switch.

To raise the rear edge of the sun roof, depress the bottom portion of the switch.

To close the sun roof, depress the side of the rocker switch opposite the side used to open the sun roof.

**NOTE:** In case of a sun roof malfunction, see "Emergency sun roof operation", page 6:18.

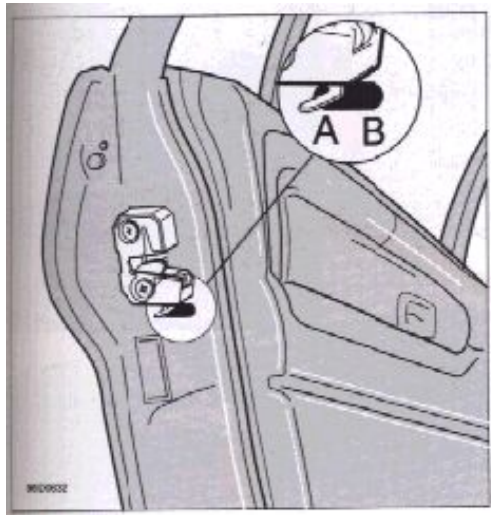

### Child safety locks

The buttons are located on the rear door jambs.

A The door lock functions normally.

B The door cannot be opened from the inside.

Normal operation from outside.

### WARNING!

Remember, in the event of an accident, the rear seat passengers cannot open the doors from the inside with the buttons in position B .

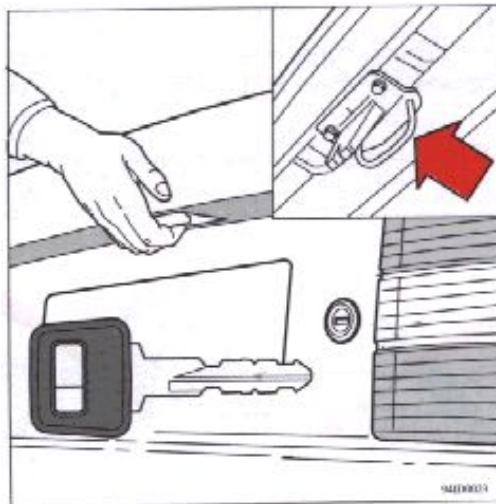

### Trunk lid

The trunk lock is incorporated in the central locking system. This means that you can either lock or unlock the trunk by means of driver's door lock.

You can also operate the trunk lock directly with the master key even if the vehicle is centrally locked.

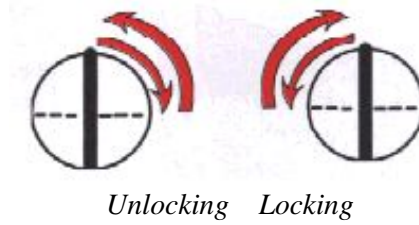

Withdraw key in vertical position.

The trunk lock can also be disconnected from the central locking system by turning the key counterclockwise as shown below:



Withdraw key in horizontal position.

The trunk is now always locked.

This option can be used if for example, you lend your car to somebody. If you give only the service key to the driver it will not be possible to open the trunk.

To reconnect the lock to the central locking system:



Withdraw key in vertical position



Pocket on rear of front seats

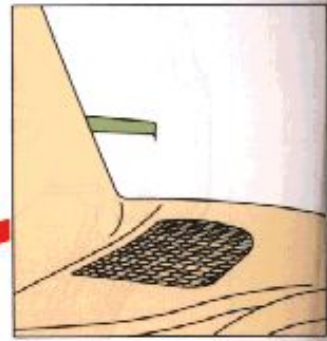

Clip for parking stubs

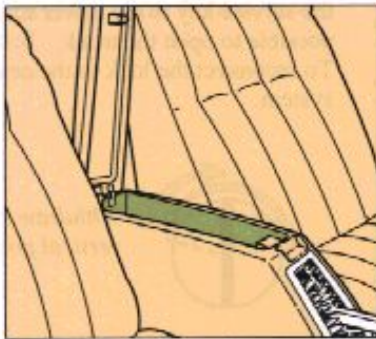
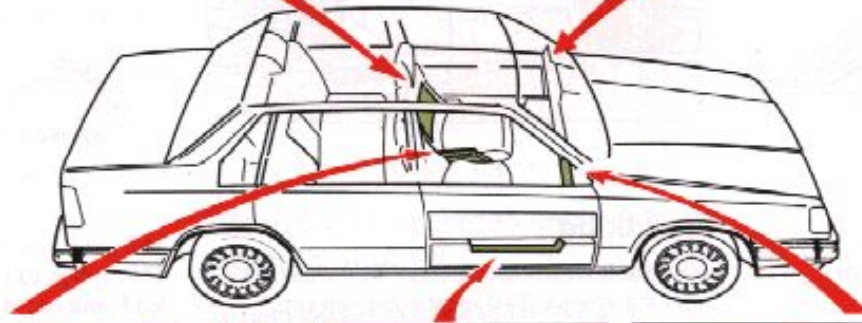

Between front seats



Compartment in front door

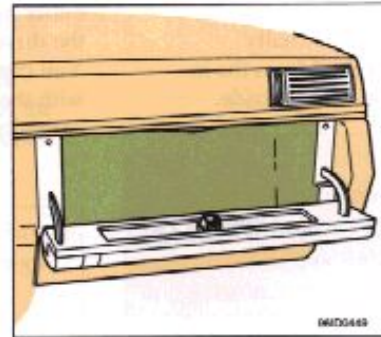

Glove compartment

2:8

**WARNING!**

Packages on the rear window shelf can obscure vision and may become dangerous projectiles in the event of a sudden stop or an accident.

pg. 2:9 Hood

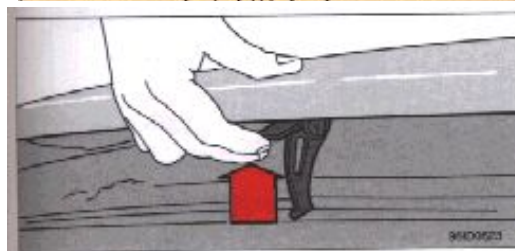



To open the hood

Pull the release handle. It is located under the left side of the dash.

Lift the hood slightly, insert a hand under the center line of the hood and depress the safety catch handle. Open the hood.

**WARNING!**  
Check that the hood locks properly when closed.

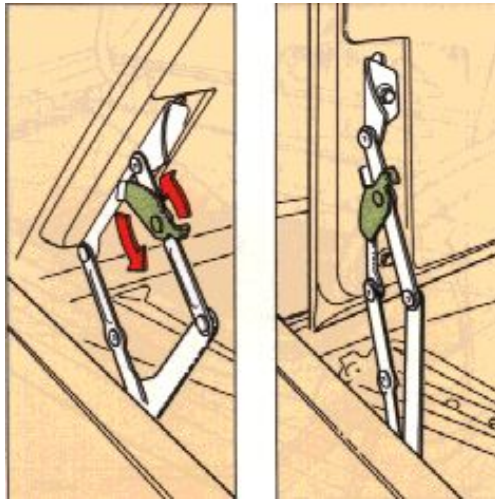

The normal opening angle for the hood approximately 55°. By turning the catches on the hinges as illustrated, the hood can be opened to the vertical position. The catches will return to their normal position when the hood is closed.

pg. 2:10 Trunk, Long load storage (sedan)

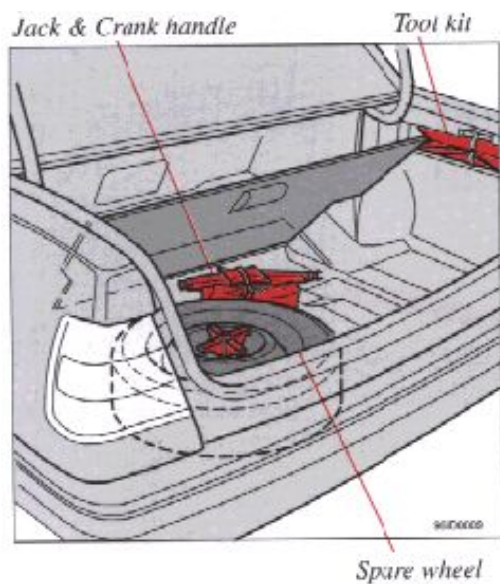

*Tool bag*

*Jack*

*The jack must be completely forloded for it to fit in the bracket.*

*Secure the jack with the strap*

NOTE: See pages 6:3-6:4 for information on how the jack should be used.

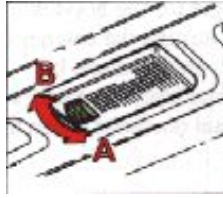

### Trunk light

A Light always off.

B Light is on when trunk lid is opened.

### Long load storage

In the panel behind the rear seat is a door which makes it possible to carry long loads such as skis, etc.

### WARNING!

Cover sharp edges on load to help prevent injury to occupants. Secure load to help prevent shifting during sudden stops.



Please note that the flap in the rear seat is only intended for light loads such as skis, carpets, etc.

Max. length of load 6 1/2 ft = 2 m.

Max. weight of load 33 lbs = 15 kg.

### WARNING!

Always turn engine off and apply parking brake when loading/unloading the vehicle. Place transmission selector in P (PARK) position to help prevent inadvertent movement of selector.



[Contents](#) | [Top of Page](#)

## Occupant safety

## pg. 3:1 Occupant safety

## Occupant safety

[3:2](#) Seat belts[3:4](#) Volvo SRS[3:7](#) Child safety[3:10](#) Occupant safety[3:10](#) Reporting Safety Defects

Despite our strongest recommendations, and your best intentions, not wearing a seat belt is like believing "It'll never happen to me!". Volvo urges you and all adult occupants of your car to wear seat belts and ensure that children are properly restrained, using an infant, car or booster seat determined by age, weight and height.

Fact: In every state and province, some type of child-restraint legislation has been passed. Additionally, most states and provinces have already made it mandatory for occupants of a car to use seat belts.

So, urging you to "buckle up" is not just our recommendation - legislation in your state or province may mandate seat belt usage. The few seconds it takes to buckle up may one day allow you to say, "It's a good thing I was wearing my seat belt".

## pg. 3:2 Seat belts



## Seat belts

Always fasten the seat belts before you drive or ride.

Two lights above the rear view mirror will be illuminated for 4-8 seconds after the starting (ignition) key is turned to the driving position. One light is located in the instrument panel and one in the console between the front seats.

A chime will sound at the same time if the driver has not fastened his seat belt. The rear seats are provided with self-retracting inertia reel belts. The front seats are provided with single roller belts with tensioners.

## To buckle:

Pull the belt out far enough to insert the latch plate into the receptacle (buckle for rear seats) until a

distinct snapping sound is heard. The seat belt retractor is normally "unlocked" and you can move freely, provided that the shoulder belt is not pulled out too far. The retractor will lock up as follows:

- if the belt is pulled out rapidly
- during braking and acceleration
- if the vehicle is leaning excessively
- when driving in turns



In order for the seat belt to provide maximum protection in the event of an accident, it must be worn correctly. When wearing remember:

- The belt should not be twisted or turned.
- The lap belt must be positioned low on the hips (not pressing against the abdomen). Make sure that the shoulder belt is rolled up into its retractor and that the shoulder and lap belts are taut.

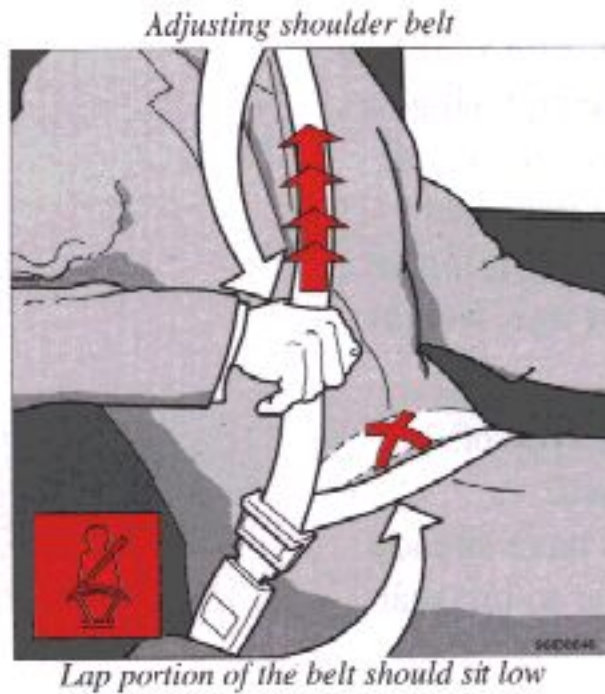

Before exiting the car, check that the seat belt retracts fully after being unbuckled. If necessary, guide the belt back into the retractor slot.

**WARNING!** Any device used to induce slack into the shoulder belt portion of the three-point belt system will have a detrimental effect on the amount of protection available to you in the event of a collision.

The seat back should not be tilted too far back. The shoulder belt must be taut in order to function properly.





### Rear head restraint

The center head restraint can be adjusted according to the passenger's height. The restraints should be carefully adjusted to support the occupant's head.



### During pregnancy

Pregnant women should always wear seat belts. Remember that the belt should always be positioned in such a way as to avoid any possible pressure on the abdomen. The lap portion of the belt should be located low, as shown in the above illustration.

**WARNING!** Never use a seat belt for more than one occupant. Never wear the shoulder portion of the belt under the arm, behind the back or otherwise out of position. Such use could cause injury in event of accident. As the seat belts lose much of their strength when exposed to violent stretching, they should be replaced after any collision, even though they may appear to be undamaged. Never repair the belt on your own; have this done by an authorized Volvo dealer only.

pg. 3:4 Volvo SRS



*As an enhancement to the three-point seat belt system, your Volvo is equipped with a Supplemental Restraint System (SRS). The Volvo SRS consists of a driver's side airbag with a driver's side knee bolster (5) and seat belt tensioners in both front door pillars (4). The system is designed to supplement the protection provided by the three-point seat belt system.*

The interior of an SRS-equipped Volvo looks very much the same as any other. The only indications of the system's presence are the "SRS" embossed on the steering wheel pad, and the knee bolster beneath the steering column.

The airbag is folded and located in the center of the steering wheel. It is released only during certain frontal or front-angular collisions, depending upon the crash severity, angle, speed and object impacted.

**WARNING!**

As its name implies, SRS is designed to be a SUPPLEMENT to - not a replacement for - the three-point belt system. The airbag is designed not to be released in the event of a side or rear-end collision, or during a rollover situation. For maximum protection, wear seat belts at all times. Be aware that no system can prevent all possible injuries that may occur in an accident.

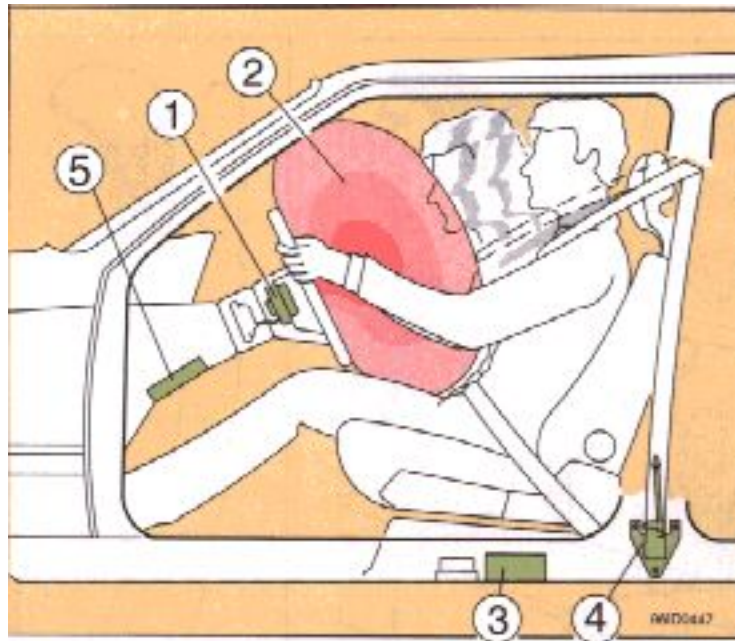

The airbag system includes a gas generator (1) surrounded by the airbag itself (2) and two front seat belt tensioners (4). To deploy the system, the sensor (3) activates the gas generators causing the airbags to be inflated with nitrogen gas. As the movement of the seat's occupants compresses the airbags, some of the gas is expelled at a controlled rate to provide better cushioning. Both seat belt tensioners also deploy, minimizing any seat belt slack.

The entire process, including inflation and deflation of the airbags, takes approximately two-tenths of a second.

### WARNING!

When installing any optional equipment make sure that the SRS system is not damaged. Do not attempt to service any component of the SRS yourself. Attempting to do so may result in serious personal injury. If a problem arises, take your car to the nearest authorized Volvo Dealer for inspection as soon as possible.

pg. 3:5 Volvo SRS



A self-diagnostic system incorporated in the sensor monitors the SRS. If a fault is detected, the "SRS"

warning light will illuminate. The light is included in the warning/indicator light cluster in the instrument panel. Normally, the SRS warning lamp should light up when the ignition is switched on and should go out after 10 seconds or when the engine is started. Check that this light is functioning properly every time the car is started. Check that this light is functioning properly every time the car is started.

The following items are monitored by all the self-diagnostic system:

- Sensor unit
- Cable harness
- Gas generator ignitor

**WARNING! Never drive an SRS equipped car with your hands on the steering wheel pad/airbag housing.**

**WARNING! If the SRS warning light stays on after the engine has started or if it comes on while you are driving, drive the car to the nearest authorized Volvo dealer for inspection as soon as possible.**



*The above is a sample of the label found on all seat belts equipped with tensioners, located on the front seat belts near the lower anchorage point.*

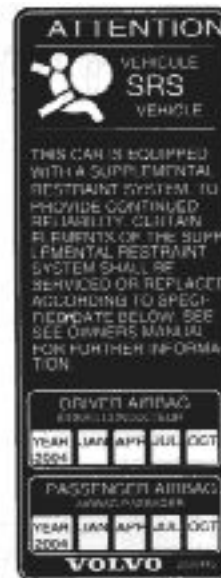

*The above is a sample of the decal which can be found on the driver's door pillar.*

*There is no maintenance to perform on the SRS yourself. The only periodic maintenance recommended on the SRS is that the air bag modules and front seat belts (including tensioners) should be replaced approximately every ten years and that the other components in the system (wiring, connectors, etc.) should also be inspected at this time. The SRS decal on your car shows the month and year servicing is due. This service must be performed by an authorized Volvo dealer. Should you have any questions about the SRS system, please contact your authorized Volvo Dealer or*

## General SRS information

In a collision where deployment occurs, the air bag and seat belt tensioners activate. Some noise occurs and a small amount of powder is released. This powder is not harmful and does not indicate fire.

**NOTE:** Deployment of SRS components occurs only one time during an accident.

If you are involved in an accident which has resulted in air bag deployment, we recommend the following:

- Have the car towed to an authorized Volvo dealer or collision repair shop. Even if the car is driveable after an accident, we do NOT recommend driving the car with a deployed air bag.
- Have the SRS replacement performed by an authorized Volvo dealer OR ask the body shop performing the collision repairs to have the SRS replacement done at a Volvo dealer.
- Have all deployed/damaged SRS components (air bag and front seat belt assemblies) replaced with new, genuine Volvo-brand components.



[Contents](#) | [Top of Page](#)



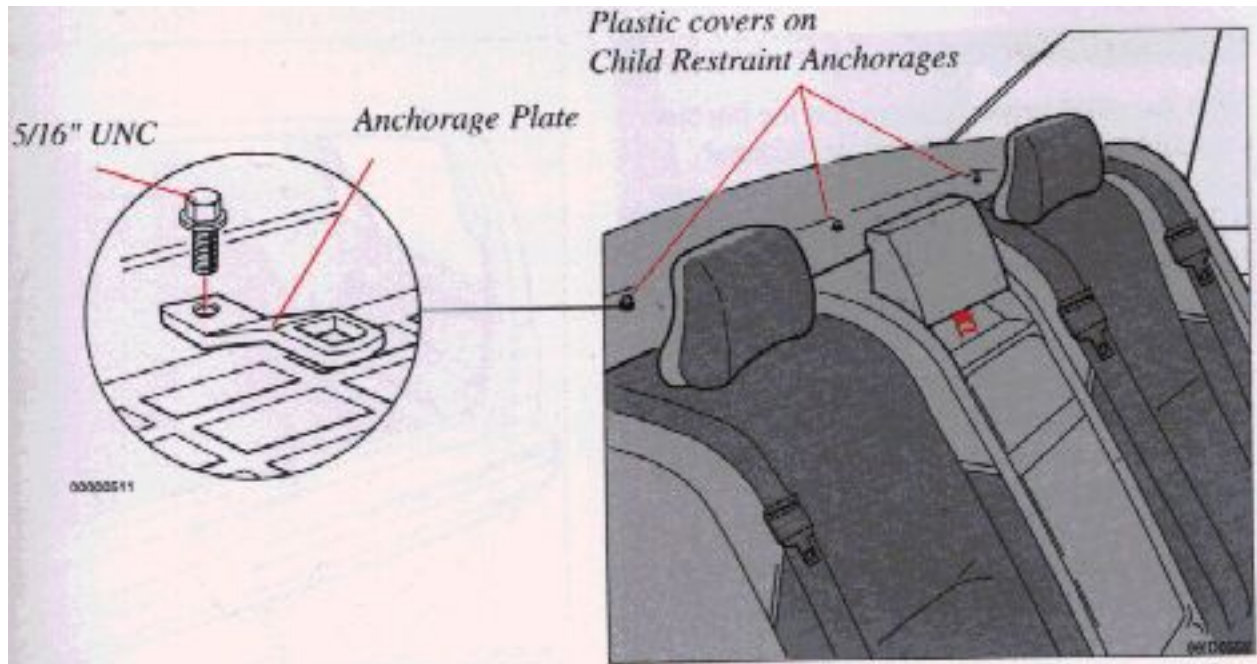

### Child Restraint Anchorages

Volvo cars are fitted with Child Restraint Top Tether Anchorages in the rear seat. There are three anchorages under the rear section of the car's rear window shelf on sedans and on the back rest on wagons. The backrest on wagons must be folded down slightly to reach the anchorages. When the car is delivered, the holes for these anchorages are covered by plastic covers. In cars designated for Canada, one top tether anchorage set will be in the glove box.

The top tether anchorage set includes the top tether anchorage plate, an 5/16" UNC bolt and a plastic trim cover. If another set is needed, consult your Volvo dealer.

### Installing the top tether

Remove the plastic cover on the anchorage point you want to use. This can be done with a suitable coin. The cover is removed counter-clockwise. Refer to the child seat manufacturer's instructions for securing the seat. An additional bolt may be required for sedans. This may be obtained from your authorized Volvo dealer.



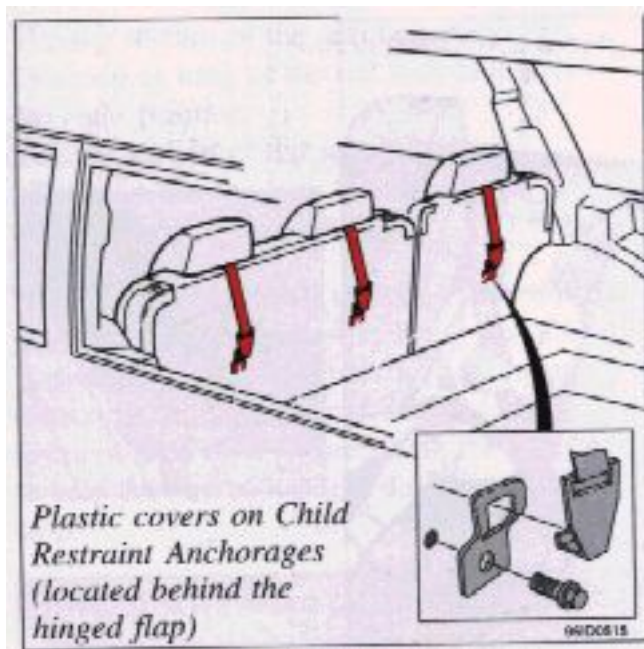

**WARNING!** Child Restraint Anchorages are designed to withstand only those loads imposed by correctly fitted Child Restraints. Under no circumstances are they to be used for adult seat belts or harnesses.

The anchorages are not able to withstand excessive forces on them in the event of collision if full harness seat belts or adult seat belts are installed to them. An adult who uses a belt anchored in a Child Restraint Anchorage runs a great risk of suffering severe injuries should a collision occur. Do not install rear speakers which would require the removal of the top tether anchors or interfere with the proper use of the top tether strap.

pg. 3:8 Child safety (cont.)



## Integrated booster cushion (certain models)

Volvo's own integrated booster cushion has been specially designed to help safeguard a child seated in the center position of the rear seat. In combination with the standard three-point seat belt, it is approved for children weighing between 22.7 and 36 kg (50 and 80 lbs) and between 117 and 137 cm (46 and 54 in ) in height. Press button A to forld up the booster cushion when it is not in use.

### Sedan

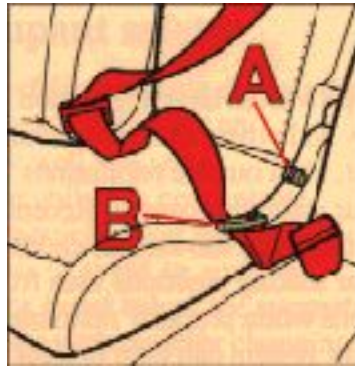

With the child seated on the cushion, the hip section of the three-point belt must pass through seat belt guide B.

### Wagon

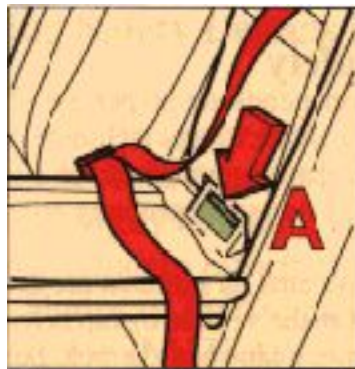

The hip section of the three-point seat belt must fit snugly across the child's hips, not across the stomach.

#### **WARNING!**

In the event of a collision while the integrated booster cushion was occupied, the entire booster cushion and center seat belt must be replaced. The booster cushion should also be replaced if it is badly worn or damaged in any way. This work should be performed by an authorized Volvo dealer only. The booster cushion should be cleaned while in place if the vehicle if possible. If not, please consult your Volvo dealer.

## Child safety

Volvo recommends the proper use of restraint systems for all occupants including children. Remember that, regardless of age and size, a child should always be properly restrained in a car.

Restraint systems for children are designed to be secured in the vehicle by lap belts or the lap portion of a lap-shoulder belt. Such child restraint systems can help protect children in cars in the event of an accident only if they are used properly. However, children could be endangered in a crash if the child restraints are not properly secured in the vehicle. Failure to follow the installation instructions for your child restraint can result in your child striking the vehicle's interior in a sudden stop.

Holding a child in your arms is NOT a suitable substitute for a child restraint system. In an accident, a child held in a person's arms can be crushed between the vehicle's interior and an unrestrained person. The child could also be injured by striking the interior, or by being ejected from the vehicle during a sudden maneuver or impact. The same can also happen if the infant or child rides unrestrained on the seat. Other occupants should also be properly restrained to help reduce the chance of injuries or increasing the injury of a child.

All states and provinces have legislation governing how and where children should be carried in car. Find out the regulations existing in your state or province. Recent accident statistics have shown that children are safer in rear seating positions than front seating positions when properly restrained. A child restraint system can help protect a child in a vehicle. Here's what to look for when selecting a child restraint system:

- It should have a label certifying that it meets applicable Federal Motor Vehicle Safety Standards (FMVSS 213-80) - or in Canada, CMVSS 213.
- Make sure the child restraint system is approved for the child's height, weight and development - the label required by the standard or regulation, or instructions for infant restraints, typically provide this information.
- In using any child restraint system, we urge you to look carefully over the instructions that are provided with the restraint. Be sure you understand them and can use the device properly and safely in this vehicle. A misused child restraint system can result in increased injuries for both the infant or child and other occupants in the vehicle.
- If your child restraint requires a top tether strap, consult your authorized Volvo dealer for top tether anchorage and installation information.

When a child has outgrown the child safety seat, you should use the rear seat with the standard seat belt fastened. The best way to help protect the child here is to place the child on a cushion so that the seat belt is properly located on the hips.

A specially designed and tested booster cushion for children between 22.7 - 36 kg (50 - 80 lbs) and 117 - 137 cm (46 - 54") can be obtained from your Volvo dealer.

If necessary, an auxiliary seat for children is available for use in the luggage compartment of station

wagon models. This seat is designed for two children, each up to 88 lbs. and up to 59 inches in height.

pg. 3:10 Occupant safety

## Seat belt maintenance

Check periodically that the anchor bolts are secure and that the belts are in good condition.

Use water and a mild detergent for cleaning.

Check seat belt mechanism function as follows:

Attach the seat belt and pull rapidly on the strap.

**WARNING! Check other traffic before performing the following check.**

Brake firmly from approximately 30 mph (50 km/h) or turn in a tight circle while pulling on the belt. In the above checks you should not be able to pull the belt out.

## Volvo Concern for Safety

Safety is the cornerstone for Volvo. Our concern dates back to 1927 when the first Volvo rolled off the production line. Three-point seat belts, safety cages, and energy-absorbing impact zones were designed into Volvo cars long before it was fashionable or required by government regulation. We will not compromise our commitment to safety. We continue to seek out new safety features and to refine those already in our cars. You can help. We would appreciate hearing your suggestions about improving automobile safety. We also want to know if you ever have a safety concern with your car.

## Occupant safety

How safely you drive doesn't depend on how old you are but rather on:

- how well you see
- your ability to concentrate
- how quickly you make decisions under stress to avoid an accident.

The tips listed below are suggestions to help you cope with the ever changing traffic environment.

- Never drink and drive.
- If you are taking any medication, consult your physician about its potential effects on your driving abilities.
- Take a driver-retraining course
- Have your eyes checked regularly
- Keep your windshield and headlamps clean.
- Replace wiper blades when they start to leave streaks.

- Take into account the traffic, road, and water conditions, particularly with regard to stopping distance.

## Reporting Safety Defects in the U.S.

If you believe that your vehicle has a defect which could cause a crash or could cause injury or death, you should immediately inform the National Highway Traffic Safety Administration (NHTSA) in addition to notifying Volvo Cars of North America. If NHTSA receives similar complaints, it may open an investigation, and if it finds that a safety defect exists in a group of vehicles, it may order a recall and remedy campaign. However, NHTSA cannot become involved in individual problems between you, your retailer, or Volvo Cars of North America. To contact NHTSA, you may either call the Auto Safety Hotline toll-free at 1-800-424-9393 (or 366-0123 in Washington, D.C. area) or write to: NHTSA, U.S. Department of Transportation, Washington D.C. 20590. You can also obtain other information about motor vehicle safety from the Hotline.



[Contents](#) | [Top of Page](#)

## Starting and driving

### pg. 4:1 Starting and driving

#### Starting and driving

This section on starting and driving contains items such as starting the engine, operating gear selector, towing, trailers.

[4:2 Fuel requirements, Refueling](#)

[4:3 Driving economy](#)

[4:4 Starting the engine](#)

[4:5 Transmission](#)

[4:10 Points to remember](#)

[4:12 Emergency towing](#)

[4:13 Vehicle Towing Information](#)

[4:14 Jump starting](#)

[4:15 Cold weather precautions](#)

[4:16 Towing a trailer](#)

[4:17 Brakes](#)

[4:18 Before a long distance trip](#)

[4:19 Vehicle storage](#)

[4:20 Three-way catalytic converter](#)

A new car should be broken-in!

Refrain from utilizing your car's full driving potential during the first 1,200 miles (2,000 km).

Automatic transmission

Do not use "kick-down" during the first 1,200 miles (2,000 km).

### pg. 4:2 Fuel requirements, Refueling

#### Unleaded Fuel

Each Volvo has a three-way catalytic converter and must use only unleaded gasoline. U.S. and Canadian



regulations require that pumps delivering unleaded gasoline be labeled "UNLEADED". Only these pumps have nozzles which fit your car's filler inlet. It is unlawful to dispense leaded fuel into a vehicle labeled "unleaded gasoline only". Leaded gasoline damages the three-way catalytic converter and the heated oxygen sensor system. Repeated use of leaded gasoline will lessen the effectiveness of the emission control system and could result in loss of emission warranty coverage. State and local vehicle inspection programs will make detection of misfueling easier, possibly resulting in emission test failure for misfueled vehicles.

## Octane Rating

Volvo engines are designed for optimum performance on unleaded premium gasoline with an octane rating, AKI of 91, or above. AKI (ANTI KNOCK INDEX) is an average of the Research Octane Number, RON, and the Motor Octane Number, MON,  $(RON + MON / 2)$ . The minimum octane requirement is AKI 87 (RON 91).

## Gasoline Containing Alcohol and Ethers

### "Oxygenated fuels"

Some fuel suppliers sell gasoline containing "oxygenates" which are usually alcohols or ethers. In some areas, state or local laws require that the service pump be marked indicating use of alcohol or ethers. However, there are areas in which the pumps are unmarked. If you are not sure whether there is alcohol or ethers in the gasoline you buy, check with the service station operator. To meet seasonal air quality restrictions, some states require the use of "oxygenated" fuel in certain areas.

Volvo allows the use of the following "oxygenated fuels"; however, the octane ratings listed on this page must still be met.

#### Alcohol -- Ethanol

Fuels containing up to 10% ethanol by volume may be used.

Ethanol may also be referred to as Ethyl alcohol, or "Gasohol".

#### Ethers -- MTBE

Fuels containing up to 15% MTBE may be used.

## Refueling

The fuel tank filler cap is located behind the door on the left rear fender. Open cap slowly during hot weather conditions.

When filling, position the cap in the special bracket on the door.

After filling the tank, install the cap and turn until a "click" is heard.

The fuel tank is designed to hold approximately 19.8 US gals (75 liters) with sufficient volume left over to accommodate possible expansion of the fuel in hot weather. Be aware that the "usable" tank capacity will be somewhat less than the 19.8 US gallons (75 liters) maximum. When the fuel level is low, such factors as ambient temperature, the fuel's "vapor pressure" characteristics, and terrain can affect the fuel

pumps' ability to supply the engine with an adequate supply of fuel. Therefore, it is advisable to refuel as soon as possible when the needle nears the red zone, or when the fuel warning light comes on.

**CAUTION:** Take care not to spill gasoline during refueling.

Gasolines containing alcohol can cause damage to painted surfaces, which may not be covered under the New Vehicle Limited Warranty.

Do not use gasoline containing methanol (methyl alcohol, wood alcohol). This practice can result in vehicle performance deterioration and can damage critical parts in the fuel system.

Such damage may not be covered under the New Vehicle Limited Warranty.

pg. 4:3 Driving economy, Carbon deposits

Economical driving does not necessarily mean driving slowly

Better driving economy may be obtained by thinking ahead, avoiding rapid starts and stops and adjusting the speed of your vehicle to immediate traffic conditions. Observe the following rules:

- Bring the engine to normal operating temperature as soon as possible by driving with a light foot on the accelerator pedal for the first minutes of operation. A cold engine uses more fuel and is subject to increased wear.
- Whenever possible, avoid using the car for driving short distances. This does not allow the engine to reach normal operating temperature.
- Drive carefully and avoid rapid acceleration and hard braking.
- Do not exceed speed limit.
- Avoid carrying unnecessary items (extra load) in the car.
- Check tire pressure regularly (check when tires are cold).
- Remove snow tires when threat of snow or ice has ended.
- Note that roof racks, ski racks, etc., increase air resistance and thereby fuel consumption.
- Turbo: try to keep the boost pressure gauge in the black range.
- Utilize overdrive at speeds above approx. 45 mph (70 km/h)
- Avoid using automatic transmission kick-down feature unless necessary.

Other factors which decrease gas mileage are:

- Worn or dirty spark plugs
- Incorrect spark plug gap
- Dirty air cleaner
- Incorrect valve clearance
- Dirty engine oil and clogged oil filter
- Dragging brakes
- Incorrect front end alignment
- Low tire pressure

Some of the above mentioned items and others are checked at the standard Maintenance Service intervals.

### Deposit control gasoline

Volvo recommends the use of gasoline containing deposit control additives. These additives have shown to be efficient in keeping injectors and intake valves clean. Consistent use of deposit control gasolines will help ensure good driveability and fuel economy. If you are not sure whether the gasoline contains deposit control additives, check with the service station operator.

**Note:**

Do not add additives yourself to the gasoline, unless you are recommended to do so by an authorized Volvo dealer.

pg. 4:4 Starting the engine, Turbo caution

### Starting and stopping a car equipped with automatic transmission

1 Fasten the seat belt.

**WARNING! Before starting, check that the seat is adjusted properly. Make sure the brake pedal can be depressed completely. Move the seat closer if necessary. Refer to section "Front seats".**

2 Apply the parking brake, if not already set. The gear selector is locked in the (P)ark position ( SHIFTLOCK ).

3 Without touching the accelerator pedal , turn the ignition key to the starting position. Allow the starter to operate for 5-10 seconds. Release the key as soon as the engine starts. If the engine fails to start, repeat step 3.

Turbo only : for cold starts at altitudes above 6000 ft (1800 m), depress the accelerator pedal halfway and turn the key to the starting position. Release the accelerator pedal slowly when the engine starts.

4 To release the gear selector, depress the brake pedal . See page 6:18 for instructions on manually overriding the SHIFTLOCK system if the lever cannot be moved. Do not race a cold engine immediately after starting. Oil flow may not reach some lubricating points fast enough to prevent engine damage.

5 Select desired gear. The gear engages after a slight delay, especially noticeable when selecting R.

**CAUTION:** Engine should be idling; never accelerate until after you feel the gear engage! Too rapid acceleration immediately after selecting a gear will cause harsh engagement and premature transmission wear.

6 Release the brakes and accelerate

To stop the car, release the accelerator pedal and apply the brakes.

**NOTE:** Your car is equipped with a KEYLOCK switch system. When the engine is switched off, the gear selector must be in the (P)ark position before the key can be removed from the ignition switch.

**WARNING!**

Never leave car unattended with engine running.

Always open the garage doors fully before starting the engine inside a garage to ensure adequate ventilation. The exhaust gases contain carbon monoxide, which is invisible and odorless but very poisonous.

**WARNING!**

Always place gear selector securely in Park, and apply parking brake before leaving vehicle. Never leave car unattended with engine running.

**Turbo caution**

Never race the engine immediately after starting . Oil flow may not reach some lubricating points fast enough to prevent engine damage.

Do not race the engine just prior to switching off!



[Contents](#) | [Top of Page](#)

## pg. 4:12 Emergency towing (pulling of vehicle)

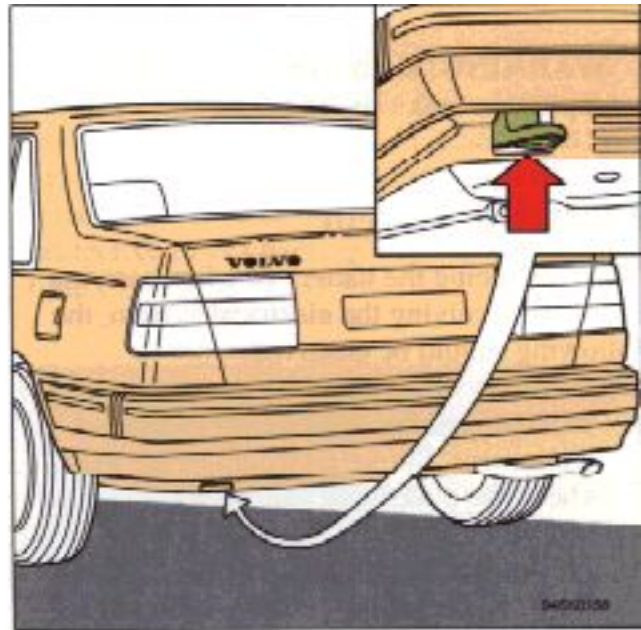
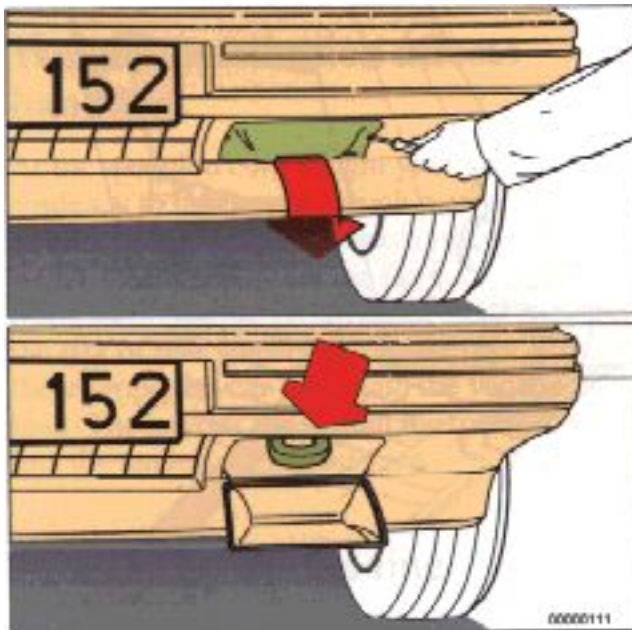

*Front eyelet    Rear eyelet*

Precautionary steps to observe when car is in tow

- Steering must be unlocked.
- Please check with state and local authorities before attempting this type of towing, as vehicles being towed are subject to regulations regarding maximum towing speed, length and type of towing device, lighting, etc.
- Remember that power brake and power steering assists will not be available when engine is inoperative. Brake pedal pressure required is 3 - 4 times above normal and greater steering effort must be exerted.

Automatic transmission

- Gear selector in position N. Check transmission oil level (see section titled "Transmission oil").
- Maximum speed: 20 mph (30 km/h).
- Maximum distance with rear wheels on ground: 20 miles (30 km).
- If the battery is dead, it is not possible to release the gear selector by pressing the brake pedal. Release the gear selector manually, see page 6:18.

Cars equipped with automatic transmission/three-way catalytic converters cannot be started by pushing or pulling the car.

**CAUTION:** The towing eyelets must not be used for pulling another vehicle out of a ditch or any similar purpose involving severe strain.

## pg. 4:13 Vehicle towing information

Only use wheel lift or flat bed equipment.

**CAUTION:**

Sling-type equipment applied at the front will damage radiator and air conditioning lines.

It is equally important not to use slingtype equipment at the rear or apply lifting equipment inside the rear wheels: serious damage to the rear axle may result.

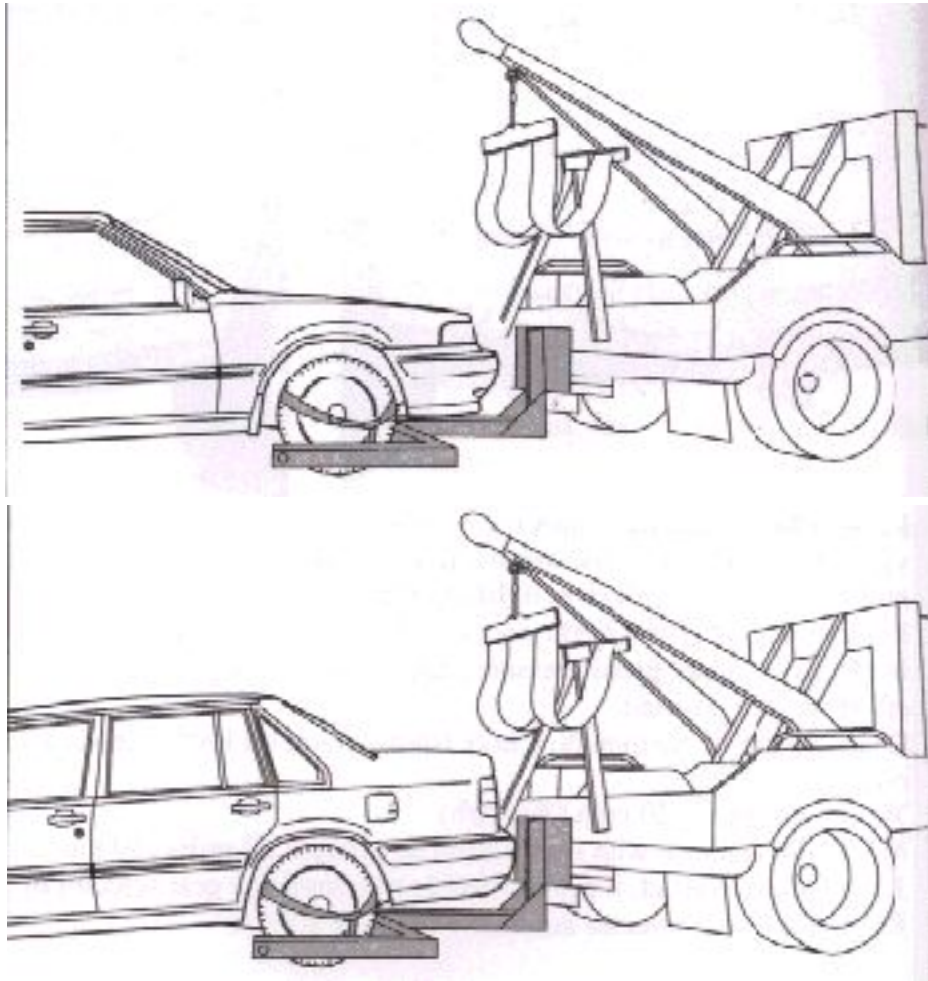

pg. 4:14 Jump starting



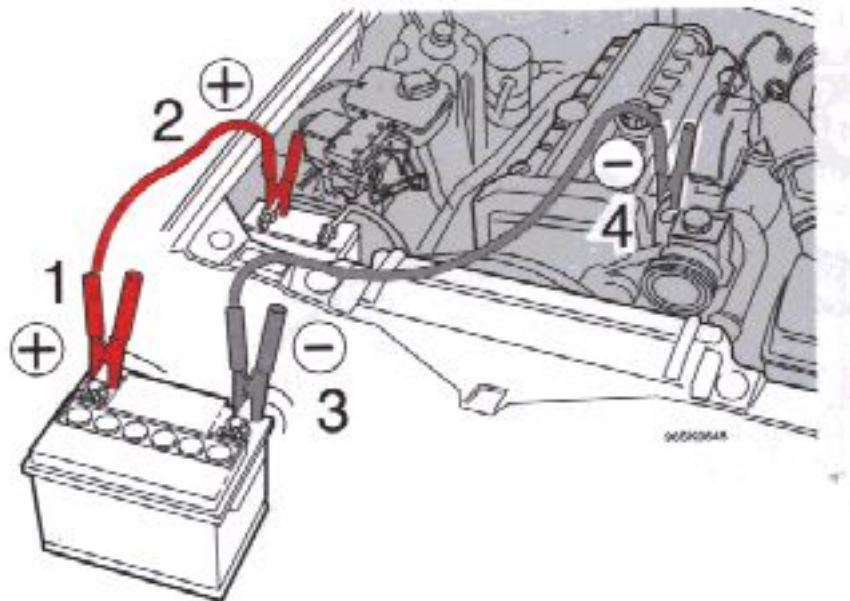

**CAUTION:**

Improper hook-up of jumper cables or use of other than 12-volt batteries could result in damage to equipment and/or battery.

Check that cars are not touching to prevent premature completion of negative circuit. Note the position of the battery terminals and using jumper cables:

- First connect booster battery positive (+) terminal (1) to car battery positive (+) terminal (2).
- Then connect booster battery negative (-) terminal (3) to a stationary solid metal part on the engine at a point away from the battery (4).

Do not connect booster cable to any part of fuel system or any moving parts. Avoid touching hot manifolds.

- After engine has started, remove first the negative (-) terminal jumper cable. Then remove the positive (+) terminal jumper cable.

**WARNING!**

To reduce the possibility of explosion, never expose battery to open flame or electric spark. Do not smoke near battery. Batteries generate hydrogen gas which is flammable and explosive. Battery fluid contains sulfuric acid. Do not allow battery fluid to contact eyes, skin, fabrics or painted surfaces. If contact occurs, flush affected area immediately with water. Obtain medical attention immediately if eyes are affected.

**WARNING!**

Failure to follow the instructions for jump starting can lead to personal injury.

pg. 4:15 Winter driving

## Cold weather precautions

- If you wish to check your car before the approach of cold weather, the following advice is worth noting:

Make sure that the engine coolant contains at least 50 percent antifreeze: that is, 5.3 qts. (5 liters) Volvo Genuine Coolant/Antifreeze. This gives protection against freezing down to  $-31^{\circ}\text{F}$  ( $-35^{\circ}\text{C}$ ). See section "Coolant".

The use of "recycled" antifreeze is not approved by Volvo.

Different types of antifreeze may not be mixed.

- Try to keep the fuel tank well filled - this prevents the formation of condensation in the tank. In addition in extremely cold weather conditions it is worthwhile to add fuel line de-icer before refueling.
- Use the correct grade of engine oil to avoid difficulties when starting. See section "Engine oil".
- The load placed on the battery is greater during the winter since the heater, windshield wipers, lighting etc. are used more often. Moreover, the capacity of the battery decreases as the temperature drops. In very cold weather, a poorly charged battery can freeze and be damaged. It is therefore advisable to check the state of charge more frequently and spray an anti-rust oil on the battery posts.
- The viscosity of the engine oil is important. Oil with low viscosity (thinner oil) improves cold-weather starting as well as decreasing fuel consumption while the engine is warming up. for winter use, 5W-30 oil, particularly the synthetic type, is recommended. Be sure to use good quality oil but do not use this cold-weather oil for hard driving or in warm weather. See section "Engine oil" for more information.
- Use lock spray or grease in the locks.
- To prevent the washer reservoir from freezing, add washer solvents containing antifreeze. This is important since the dirt is often splashed on the windshield during winter driving, thus requiring frequent use of the washers and wipers. The Volvo Washer Solvent should be diluted as follows:  
Down to  $14^{\circ}\text{F}$  ( $-10^{\circ}\text{C}$ ): 1 part anti-freeze and 4 parts water  
Down to  $5^{\circ}\text{F}$  ( $-15^{\circ}\text{C}$ ): 1 part anti-freeze and 3 parts water  
Down to  $0^{\circ}\text{F}$  ( $-18^{\circ}\text{C}$ ): 1 part anti-freeze and 2 parts water  
Down to  $-18^{\circ}\text{F}$  ( $-28^{\circ}$ ): 1 part anti-freeze and 1 part water

**NOTE:** Avoid the use of de-icing spray as they can cause damage to the locks.

## Automatic differential lock

The differential automatically locks at speed between 3 - 25 mph (5 - 40 km/h) if either of the drive wheels begins to lose traction. The differential lock improves power distribution to the drive wheels in slippery conditions, shifting power to the wheel with best traction. It also functions when the transmission is in reverse.

pg. 4:16 Towing a trailer

When preparing for trailer hauling, observe the following:

- Use a trailer hitch which meets Federal Safety Standards for rear end collisions (FMVSS 301-75) for trailer weights exceeding 2000 lbs. (908 kg), use only a trailer hitch offered as a Genuine Volvo Accessory. Since the automatic transmission is subject to increased load and temperature, certain vehicles are equipped with an extra oil cooler as standard equipment. Consult your Volvo dealer for additional information.

- Maximum trailer weight recommended by Volvo is:

Trailers without brakes : 1540 lbs (700kg)

Trailers with brakes: 2" ball - 3300 lbs (1500 kg), 1 7/8" ball - 2000 lbs (908 kg).

Observe legal requirements of the state in which the vehicles are registered.

All Volvo models are equipped with energy-absorbing shock-mounted bumpers. Trailer hitch installation should not interfere with the proper operation of this bumper system.

**WARNING! Never connect a trailer's hydraulic brake system directly to the vehicle brake system, nor a trailer's lighting system directly to the vehicle lighting system. Consult your nearest authorized Volvo dealer for correct installation.**

**WARNING! Bumper-attached trailer hitches must not be used on Volvos, nor should safety chains be attached to the bumper. Trailer hitches attaching to the vehicle rear axle must not be used.**

Trailer towing does not normally present any particular problems, but take into consideration:

- Increase tire pressure to recommended full-load pressure. See section "Wheels and tires".
- Recommended hitch tongue load is 165 (75 kgs) for trailer weights above 2,650 lbs (1,200 kgs) and 110 lbs (50 kgs) for trailer weights below 2,650 lbs (1,200 kgs).
- for trailer weights between 2,650-3,300 lbs (1,200-1,500 kgs) a top speed of 50 mph (80 km/h) should never be exceeded.
- Engine and transmission are subject to increased loads. Therefore, engine coolant temperature should be closely watched when driving in hot climates or hilly terrain. Use lower gear and turn off air conditioner if temperature gauge pointer enters the red range.
- Disengage the overdrive on models with automatic transmission

- Avoid overload and other abusive operation.
- Hauling a trailer affects handling, durability, and economy.
- It is necessary to balance trailer brakes with the towing vehicle brakes to provide a safe stop. Check and observe State/Local regulations.
- More frequent vehicle maintenance is required.
- Remove the ball and drawbar assembly when the hitch is not being used.
- Volvo recommends the use of synthetic engine oil when towing a trailer over long distances or in mountainous areas.
- The trailer hitch tongue load (110/165 lbs - 50/75 kg) is part of the vehicle's capacity weight. It may be necessary to reduce the trunk/cargo area load when towing a trailer to ensure that the max. permissible axle load or gross vehicle weight are not exceeded.

NOTE: Refer to section "Automatic transmission" for additional trailer hauling tips.

pg. 4:17 Brake system



If one of the brake circuits should malfunction, the red warning light will come on. (see page 1:4)

The pedal stroke increases slightly, the pedal feels softer and extra pressure is required for normal braking.

If the light comes on while driving or braking, stop immediately and check the brake fluid level in the reservoir.

### WARNING!

If the fluid level is below the MIN mark in either section of the reservoir: DO NOT DRIVE. Tow the car to a Volvo dealer and have the brake system checked and any leakage repaired.

Moisture on brake discs and brake pads affects braking.

Driving in rain and slush or passing through an automatic car wash can cause water to collect on the brake discs and pads. This will cause a delay in braking effect when the pedal is depressed. To avoid such a delay when the brakes are needed, depress the pedal occasionally when driving through rain, slush etc. This will remove the water from the brakes. Check that brake application feels normal. This should also be done after washing or starting in very damp weather.

Severe strain on the brake system

The brakes will be subject to severe strain when driving in mountains or hilly areas. The speed is usually low which means that the cooling of the brakes is less efficient than when driving on level roads.

To reduce the strain on the brakes it is advisable not to use the brakes excessively.

Instead, shift into a lower gear and let the engine help with the braking. A good rule is to use the same gear downhill as would be used ascending the same grade. for vehicles with automatic transmission use position 2 or, in some cases, 1.

Do not forget that, if you are towing a trailer, the brakes will be subjected to greater load than is normal.

### Breaking-in parking brake (hand brake)

To obtain the best parking brake performance, the brake linings should be broken-in.

Stop 5-7 times from 30 mph (50 km/h). transmission in neutral, applying the parking brake with the release button pressed in during the stop.

The force must not lock the rear wheels. If this happens, rotate the brake enough to let the wheels rotate.

Drive a mile between each stop to cool the brakes. Check for proper parking brake operation.

### WARNING!

The brake lights are not illuminated when applying the parking brake. To warn traffic from behind it is therefore advisable to depress the brake pedal slightly to illuminate the brake lights.

If the brake power-assist does not function

The power assist to the brakes functions only when the engine is running. When the car is moving without the engine running the brake pedal pressure required to stop the car is increased by 3-4 times.

The brake pedal feels stiff and hard.

### pg. 4:18 Long distance trip

#### Before a long distance trip

It is always worthwhile to have your car checked at a Volvo dealer before driving long distances. Your dealer will also be able to supply you with bulbs, fuses, spark plugs and wiper blades for your use in the event that problems occur.

If you prefer to check the car yourself, please note the following:

Check that the engine runs smoothly and that fuel consumption is normal.

- Check engine oil, coolant levels, and for possible fuel leakage.
- Check transmission oil level and rear axle for leakage.
- Check condition of drive belts.
- Check state of charge of battery.
- Examine tires carefully (the spare tire as well), and replace those that are worn. Check tire pressures.

- The brakes, front wheel alignment, and steering gear should be checked by your Volvo dealer only.
- Check all lights, including high beams.
- Reflective warning triangles are legal requirement in some countries.
- Have a word with your Volvo dealer concerning engine adjustments if you intend to drive in countries where it may be difficult to obtain correct fuel.

## City driving

City driving can be a severe driving condition. Low operating speeds, long periods of idling combined with high operating temperatures, air conditioning usage etc. will make necessary more frequent servicing (at least every third month).

### pg. 4:19 Vehicle storage

If you do not intend to use your car for a long time

The following points may be of use if you do not intend to use your car for a long time (e.g. because of a long holiday, winter, etc.)

- Fill fuel tank to prevent water from condensing inside the tank.
- Wash the car carefully and wax it to protect the paint - don't forget the chromed parts.
- The vehicle should be left in a dry, well ventilated garage.
- Do not apply the hand brake. Block the wheels instead.
- Disconnect the battery's negative (-) cable.
- Lift the wiper arms away from the windshield.
- Increase tire pressure to maximum allowed, i.e. 36 psi.
- Open one of the window's slightly for ventilation.
- Ensure that the coolant contains sufficient anti-freeze to provide protection down to -22°F (-30°C).

Volvo Genuine Coolant/Anti-freeze also provides resistance against corrosion.

- Remove all valuables and lock the car.

Keep the battery fully charged.

### pg. 4:20 ABS



ABS

## Anti-lock Brake System - ABS

If the warning lamp lights up there is a malfunction of the ABS system (the standard braking system will however function) and the vehicle should be driven to a Volvo dealer for inspection. The Anti-lock Braking System (ABS) helps to improve vehicle control (stopping and steering) during severe braking conditions by limiting brake lock-up. When the system "senses" impending lock-up, braking pressure is



automatically modulated in order to help prevent lockup, which could lead to a skid. The system performs a self-diagnostic test when the vehicle is started and at 4 mph (6 km/h). The driver may detect one pulsation of the brake pedal. This is normal.

To obtain optimal effect from the ABS system, constant pressure should be kept on the brake pedal while the system is modulating the brakes.

The switching of the ABS modulator will be audible at this time.

Please be aware that ABS does not increase the absolute braking potential of the vehicle. While control will be enhanced, ABS will not shorten stopping distances on slippery surfaces.



[Contents](#) | [Top of Page](#)

## pg. 4:5 Automatic transmission

The following "Special Tips" apply to cars with automatic transmission

- for steep hills and when driving for prolonged periods at low speed position 1 should be selected. Avoid, however, repeated changes since this can cause overheating of the transmission oil. for driving on mountain roads with long persistent uphill gradients, select position 2.
- When negotiating long, steep downhill slopes, position 1 or 2 should be selected, in order to obtain the best possible engine braking effect.
- Do not hold the car stationary on an incline by using the accelerator pedal; instead, engage the parking brake. This prevents unnecessary heating of the transmission oil.
- When towing, prepare as follows:  
Disengage the 4th gear (the indicator light on the instrument panel goes on).

Engine warm-up - initial driving procedure

Experience shows that engines in vehicles driven short distances are subject to abnormally-rapid wear because the engine never reaches normal operating temperature. It is therefore beneficial to reach normal operating temperature as soon as possible. This is best achieved by driving with a light foot on the accelerator pedal for a few minutes after starting, rather than prolonged idling.

## pg. 4:6 Automatic transmission (cont.)

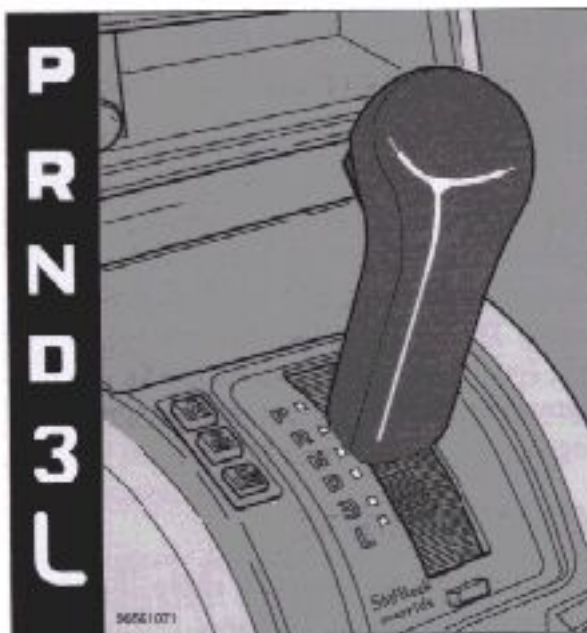

Gear selector positions

P park  
R reverse  
N neutral  
D drive  
2 intermediate  
1 low

## P (Park)

Use this position when parked with the engine running or stopped

Never use P while car is in motion.

The transmission is mechanically locked when in position P. Also, apply the parking brake when parking on grades.

### **WARNING!**

Never leave the car when the engine is running. If, by mistake, the gear selector is moved from P, the car may start moving.

The gear selector is locked in the P position - SHIFT-LOCK.

To release the selector, start the engine and depress the brake pedal. See section 6:18 for instructions on manually releasing the gear selector.

## R (Reverse)

Never engage R while is moving forward.

## N (Neutral)

Neutral position = no gear is engaged. The engine can be started in this position. Use parking brake.

## Driving gears

## D (Drive)

D is the normal driving position. Upshifts and downshifts of the forward gears occur automatically and are governed by accelerator pedal position and vehicle speed.

## Lock-up

With the gear selector in position D (Drive) the lockup device disengages the torque converter at speeds above approx. 47-56 mph (75-90 km/h). It provides lowered engine speeds and improved mileage. The lockup engagement may be noticed as an extra upshift when accelerating.

pg. 4:7 Automatic transmission (cont.)

## 2 (intermediate position)

Upshifts and downshifts of first two gears (low and intermediate) occur automatically. No upshift to 3rd or 4th gear occurs. Position 2 may be used to obtain forced downshift to 2nd gear for increased engine braking effect.

## 1 (low position)

If position 1 is selected when driving at high speeds, 2 is engaged first and 1 when the speed has dropped to approx. 30 mph (50 km/h). No upshift can occur once 1 is engaged. Use position 1 to select low gear when no upshift is desired, for instance, when entering and descending steep grades.

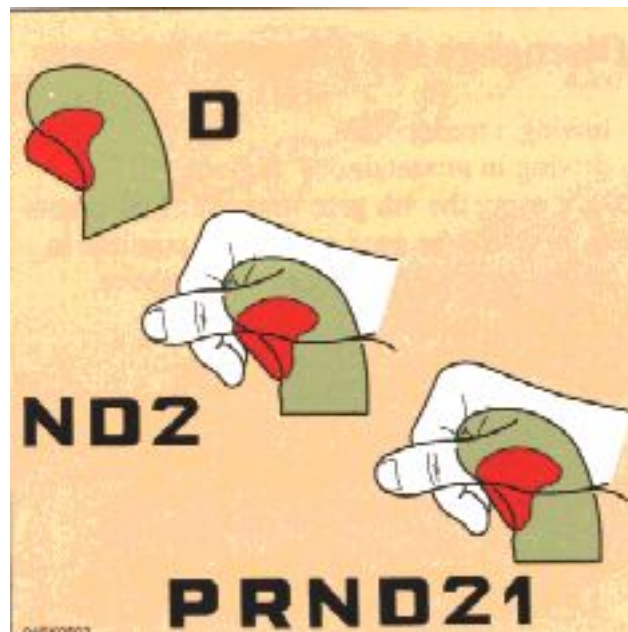

## Shift gate

The gear selector can be moved freely between D and 2. Selections of other positions are obtained by depressing the selector knob prior to moving the selector.

Slightly depressing the selector knob allows selection of positions N, D, 2 and L. Fully depressing the selector knob allows selection of positions R and P. This is also necessary when initially bringing the selector out of position P.

Fully depressing the selector knob thus permits shifting freely between all positions.

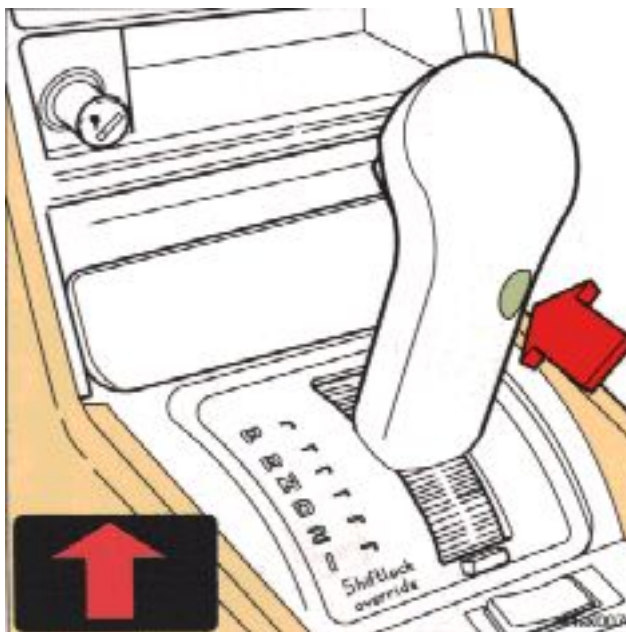

#### 4th gear disengagement:

The 4th gear is engaged automatically after the transmission has shifted through 1st, 2nd and 3rd gears at certain speeds and loads. By pressing in the button at the rear of the selector level, the 4th gear can be disengaged, thus providing a three-speed transmission. As a reminder the  $\epsilon$  light on the dashboard glows. By pressing in the button again, the transmission reverts to four-speed operation and the  $\epsilon$  light shuts off.

#### Disengage the 4th gear when:

- towing a trailer
- driving in mountainous regions.

Since using the 4th gear improves fuel economy, it should be used as often as possible in conditions other than those stated above.

#### WARNING!

- Never select P or R while the car is in motion.
  - When initially selecting positions D, 3, 2, 1, or R, your foot should press firmly on the brake pedal to ensure that the car is standing still with the engine idling.
  - The gear selector should not be downshifted to 2 or 1 at speeds above 75 mph (125 km/h). \*
- \* Always observe local speed limits.

#### Kick-down

Automatic shift to a lower gear (kick-down) is achieved by depressing the accelerator pedal fully and briskly. An up-shift will be achieved when approaching the top speed for a particular gear or by releasing the accelerator pedal slightly. Kick-down can be used for maximum acceleration or when passing at highway speeds below a certain limit.

**NOTE:** The kickdown feature should not be used during the break-in period.

pg. 4:9 Three-way catalytic converter

### Three-way catalytic converter cautions

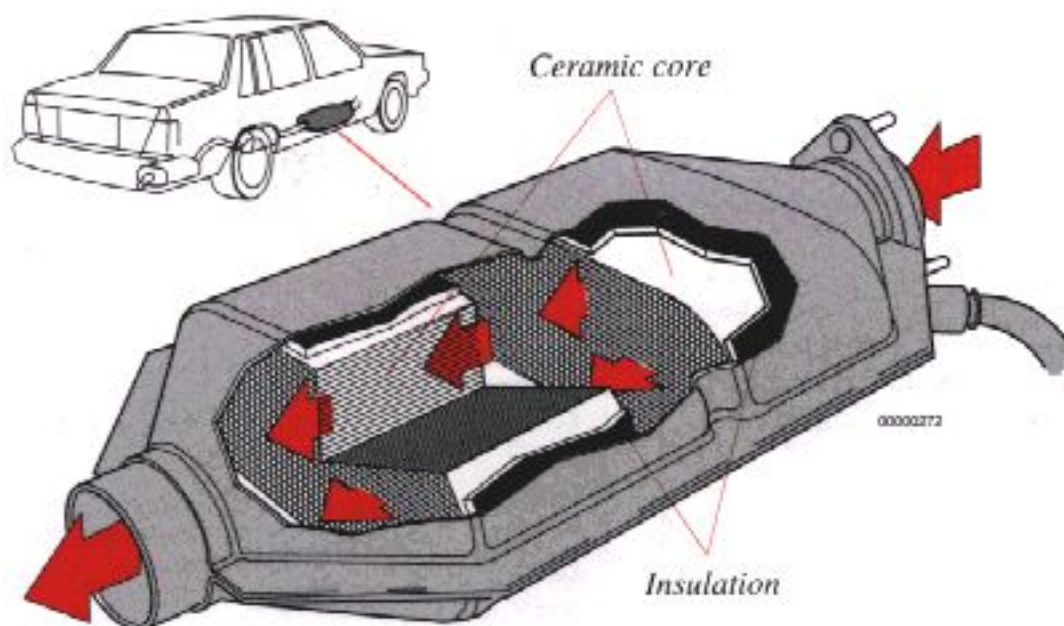

- Keep your engine properly tuned. Certain engine malfunctions, particularly involving the electrical, fuel or distributor ignition systems, may cause unusually high three-way catalytic converter temperatures. Do not continue to operate your vehicle if you detect engine misfire, noticeable loss of power or other unusual operating conditions, such as engine overheating or backfiring. A properly tuned engine will help avoid malfunction that could damage the three-way catalytic converter.
- Remember that tampering or unauthorized modification to the engine or the vehicle may be illegal and can cause three-way catalytic converter or exhaust system overheating. This includes:
  - Altering fuel injection settings or components. Adjusting distributor ignition timing beyond specified limits.
  - Altering emission system components or location or removing components
  - Repeated use of leaded fuel.
- Do not park your car over combustible materials, such as grass or leaves, which can come into contact with the hot exhaust system and cause such materials to ignite under certain wind and weather conditions.



- Excessive starter cranking (in excess of one minute), with an intermittently firing or flooded engine, can cause three-way catalytic converter or exhaust system overheating.

**NOTE:** Unleaded fuel is required for cars with three-way catalytic converters. A label on the instrument panel and inside fuel tank filler door will remind owners and filling station attendants of this requirement.

**Important!** It is unlawful to dispense leaded fuel into any vehicle labeled "unleaded gasoline only".

pg. 4:10 Points to remember

## Weight distribution affects handling

At the specified curb weight your car has a tendency to understeer, which means that the steering wheel has to be turned more than might seem appropriate for the curvature of a bend. This ensures good stability and reduces the risk of rear wheel skid. Remember that these properties can alter with the vehicle load. The heavier the load in the trunk, the less the tendency to understeer.

## Handling, roadholding

Vehicle load, tire design, and inflation pressure, all affect vehicle handling. Therefore, check that the tires are inflated to the recommended pressure according to the vehicle load. See "Tire pressure" section. Loads should be distributed so that capacity weight or maximum permissible axle loads are not exceeded.

**WARNING!** It is recommended that tire of the same make and dimensions be used on all four wheels (including the use of snow tires). Do not use bias ply tires as this will adversely alter vehicle handling characteristics.

### **WARNING!**

An extra mat on the driver's floor can cause the accelerator pedal to catch. Check that the movement of the accelerator pedal is not impeded. Not more than one protective floor covering may be used at one time.

### **CAUTION:** Driving through standing water

Drive slowly and carefully if going through standing water (i.e. flooded roadways, etc.). Damage to engine could result if excess water is ingested through the air intake system.

Never drive the vehicle in water deeper than 1 foot (300 mm).

**WARNING! Do not drive with trunk lid or tailgate open!**

Poisonous exhaust gases may enter via the trunk lid or tailgate.

If the trunk lid/tailgate must be kept open for any reason, proceed as follows:

- Close the windows.
- Set the ventilation system control to  and blower control to its highest setting.

### Roof racks (removable and permanent)

Roof rails are available as Volvo accessories. Observe the following points when is use:

- Avoid single-point loads. Distribute the load evenly.
- Place heavier cargo at bottom of load.
- Observe that center of gravity and handling are influenced by load weight.
- Increasing load size increases wind resistance and, thus, adversely affects fuel economy.
- Anchor the cargo correctly with a cord.
- Drive carefully. Avoid rapid starts, fast cornering and hard braking.
- Max. roof load is 220 lbs. (100 kg) for removable racks mounted on drip rails. for permanent roof racks, check the manufacturers weight specifications.
- Max. roof load is 70 lbs (30 kg) for permanent rack mounted directly on roof.

### Cooling system

The risk for overheating is greatest, especially in hot weather, when:

- towing a trailer up steep inclines for prolonged periods at wide open throttle and low engine rpm.
- idling for prolonged periods while the air conditioning is in operation. stopping the engine suddenly after high speed driving (so-called "after-boiling" can occur).

pg. 4:11 Points to remember (cont.)

To avoid overheating, the following rules should be followed:

- Reduce speed and downshift when towing a trailer up long, steep inclines. The risk of overheating can be reduced by switching off the air conditioning system for a short time.
- Do not let the engine idle unnecessarily for prolonged periods.
- Do not stop the engine immediately after high-speed driving, but instead, allow the engine to idle for 1/2-1 minute before switching off.

When the risk of overheating is imminent, or in the event of overheating, (the temperature gauge goes repeatedly into, or stays continually in, the red section) the following precautions should be taken:

- Switch off the air conditioning system.
- Stop the car and put the gear lever into neutral (position N). Do not stop the engine!
- Increase the engine speed to approx. 2000 rpm (twice idling speed)
- If the vehicle is overheating, switch the heater to full (maximum) position.

- Check the level of coolant in the expansion tank. Top-up, if necessary. See "Cooling System".

The engine must NOT be running when coolant is topped-up.

## Electrical system

When replacing the battery or when carrying out work involving the electrical system, the following should be observed:

- A battery connection to the wrong terminal will damage the diodes. Before connections are made, check the polarity of the battery with a voltmeter.
- If booster batteries are used for starting, they must be properly connected to minimize the risk of the diode being damaged. for correct connection, see "Jump starting" section.
- Never disconnect the battery circuit (for example, to replace the battery) while the engine is running, as this will immediately ruin the generator. Always make sure that all the battery connections are properly tightened.
- If any electrical/welding work is performed on the vehicle, the battery's ground lead (negative cable) and all the connecting cables of the generator must be disconnected and the welder cables placed as near the welding point as possible.
- If the radio has an anti-theft code and the battery has been disconnected, the code must be re-entered before the radio will function properly.

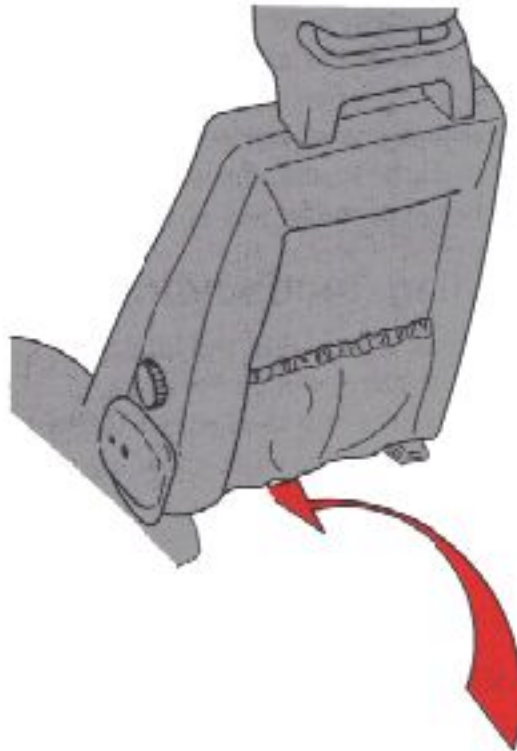

**WARNING!**

The Supplemental Restraint System is grounded under the driver's seat. Do not loosen the two screws grounding the unit. Do not ground other electrical components using these screws or any other points near them. Faults in the system could occur if it is improperly grounded.



[Contents](#) | [Top of Page](#)

## Wheels and tires

pg. 5:1 Wheels and tires

### Wheels and tires

The handling and riding comfort of the vehicle is dependent on the inflation pressure and the type of tires fitted. Read the following pages carefully.

[5:2](#) General information

[5:3](#) Tread wear indicators

[5:4](#) Inflation pressure

pg. 5:2 Wheels and tires (cont.)

### General information

Your vehicle is equipped with tires according to the tire information label located on the rear facing side of the right front door.

#### Wheels:

6" x 15" steel wheels

6" x 15" alloy wheels (certain models)

#### Tires:

185/65 R 15

195/65 R 15 (certain models)

The tire designation is coded as follows:

195 = tire width in mm.

60 = tire profile. This is the relationship (in percent) between the section height and the width of the tire.

R = radial tires.

15 = diameter in inches

The tires have good road holding characteristics and offer good handling on dry and wet surfaces. Certain models are equipped with "all-season" tires, which provide a somewhat higher degree of winter roadholding than tires without the "all-season" rating. However, for optimum road holding on icy or snow covered roads - we recommend suitable winter tires on.

When replacing tires, be sure that the new tires are the same size designation, type (radial) and preferably from the same manufacturer, on all four wheels. Otherwise there is a risk of altering the car's road-holding and handling characteristics.

**NOTE:** When storing wheel/tire assemblies (e.g. winter tires and wheels), either lay the assemblies on their sides or suspend them off the ground. Laying wheel/tire assemblies on their sides for prolonged periods can cause wheel and/or tire damage.

## Snow chains

Snow tire chains can be used on your Volvo with the following restrictions:

- Snow chains should be installed on your rear wheels only.
- Snow chains can be used on the tires and wheels provided as original production equipment with your Volvo. If accessory, aftermarket or "custom" tires and wheels are installed and are wider than 205 mm, chains CANNOT be used. Sufficient clearances between chains and brakes, suspension and components must be maintained.
- Some strap-on type chains will interfere with brake components and therefore CANNOT be used.

## CAUTION:

- Check local regulations regarding the use of snow chains before installing.
- Always follow the chains manufacturer's installation instructions carefully. Install chains as tightly as possible and re-tighten periodically.
- Never exceed the chain manufacture's specified maximum speed limit. (Under no circumstances should that limit be higher than 30 mph (50 km/h).
- Avoid bumps, holes or sharp turns when driving with snow chains.
- The handling of the vehicle can be adversely affected when driving with chains. Avoid fast or sharp turns as well as locked wheel braking.

pg. 5:3 Wheels and tires (cont.)

## Wear indicator

The tires have a so-called "wear indicator" in the form of a number of narrow strips running across or parallel to the tread. When approx. 1/16" (1.6 mm) is left on the tread, these strips show up and indicate that the tire should be replaced.

Tires with less than 1/16" (1.6 mm) tread have a very poor grip in rain or snow.

When replacing worn tires, it is recommended that the tire be identical in type (radial) and size as the one being replaced. Using a tire of the same make (manufacturer) will prevent alteration of the driving characteristics of the vehicle.

To improve tire economy:

- Maintain correct tire pressure.



- Drive smoothly: avoid fast starts, hard braking and tire screeching.
- Tire wear increases with speed.
- Do not change wheel location unless necessary.
- Correct front wheel alignment is very important. Unbalanced wheels impair tire economy and driving comfort.
- Unbalanced wheels impair tire economy and driving comfort.
- Hitting curbs or potholes can damage the tires and/or wheels permanently.

## Flat spots

All tires become warm during use. After cooling, when the vehicle is parked, the tires have a tendency to distort slightly, forming flat spots. These flat spots can cause vibrations similar to the vibrations caused by imbalanced wheels.

They do, however, disappear when the tire warms up. The degree to which the flat spots form depends on the type of cord used in the tire. Remember that, in cold weather, it takes longer for the tire to warm up and consequently longer for the flat spot to disappear.

## Snow tires, studded tires \*

### Tires for winter use:

Use snow tires fitted to the standard 15" wheels (preferably steel).

Suitable tire size: 185/65R15 on all four wheels. Do not mix tires of different design, as this could negatively affect overall tire road grip especially during slippery road conditions!

Studded tires should be run-in 300-600 miles (500-1000 km) during which the car should be driven as smoothly as possible to give the studs the opportunity to seat properly in the tires. The car tires should have the same rotational direction throughout their entire lifetime. In other words, if you wish to rotate the wheels, make sure that the same wheels are always on the same side of the car.

NOTE: Regulations governing the use of studded tires may vary from one state or province to another.

### **WARNING! Special wheel rims for air dams**

**Only special wheel rims, tested and approved by Volvo, are suitable for use with the air dam installed on the 940.**

pg. 5:4 Wheels and tires

## Checking and correcting tire pressure

Check the tire pressure when refueling.

The tire pressure should be corrected only when the tires are cold. With warm tires, correct only when

the pressure is too low. The tire temperature rises after driving just a few miles.

## Vehicle Loading

The tires on your Volvo will perform to specifications at all normal loads when inflated as recommended on the tire information label located on the rear facing side on the right front door. This label lists both the tire and vehicle design limits.

Do not load your car beyond the load limits indicated.

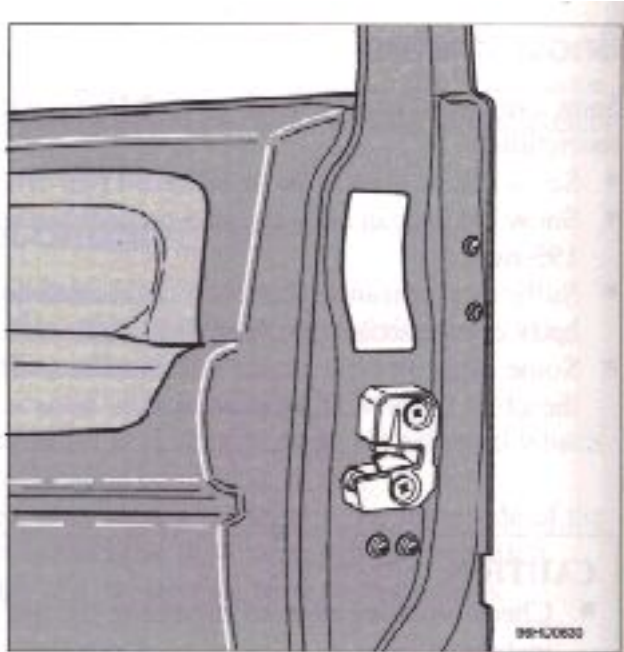

*Located on rear edge of right front door*

VEHICLE CAPACITY		OCCUPANTS		COLD INFLATION PRESSURE	
WEIGHT	PWT	FR	TOTAL	FRONT	REAR
MAX. LOADING	2 3 5			PSI	
RECOMMENDED FOR FUEL ECONOMY					
OPTIONAL INFLATION					
TIRE SIZE	2 1 3			PSI	
* SEE AFT FOR TIRE PRESSURE LIMITS AND PSI FOR RECOMMENDED TIRE LOADS					
SIZE		PSI (PSI)		INFLATION PRESSURE PSI	
SEE OWNER'S MANUAL FOR ADDITIONAL INFORMATION					
<b>VOLVO</b>					

*(Sample tire pressure label)*

**NOTE:** This label is a sample. See label on your car for correct data.



[Contents](#) | [Top of Page](#)

**In case of emergency**

## pg. 6:1 In case of an emergency

## In case of emergency

Even if you maintain your car in good running condition, there is always the possibility that something might go wrong and prevent you from driving, such as a punctured tire, blown fuse or bulb....

[6:2](#) Special spare tire

[6:2](#) Changing a wheel

[6:5](#) Replacing bulbs

[6:12](#) Replacing fuses

[6:15](#) Replacing wiper blades

[6:16](#) Troubleshooting (Service diagnosis)

## pg. 6:2 Spare tire, wheel changing

The spare wheel is located in the trunk, beneath the carpet (sedans), or beneath the rear cargo-area floor (wagons).

- Remove the wheel cap, using the screwdriver in the tool kit.
- With the car still on the ground, use the box wrench from the tool kit to loosen the wheel nuts 1/2 - 1 turn. Turn the nuts counterclockwise to loosen.

## pg. 6:3 Wheel changing

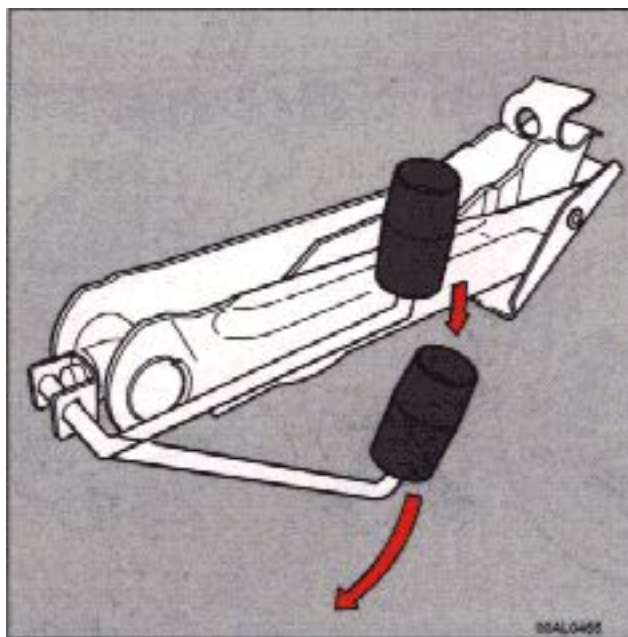
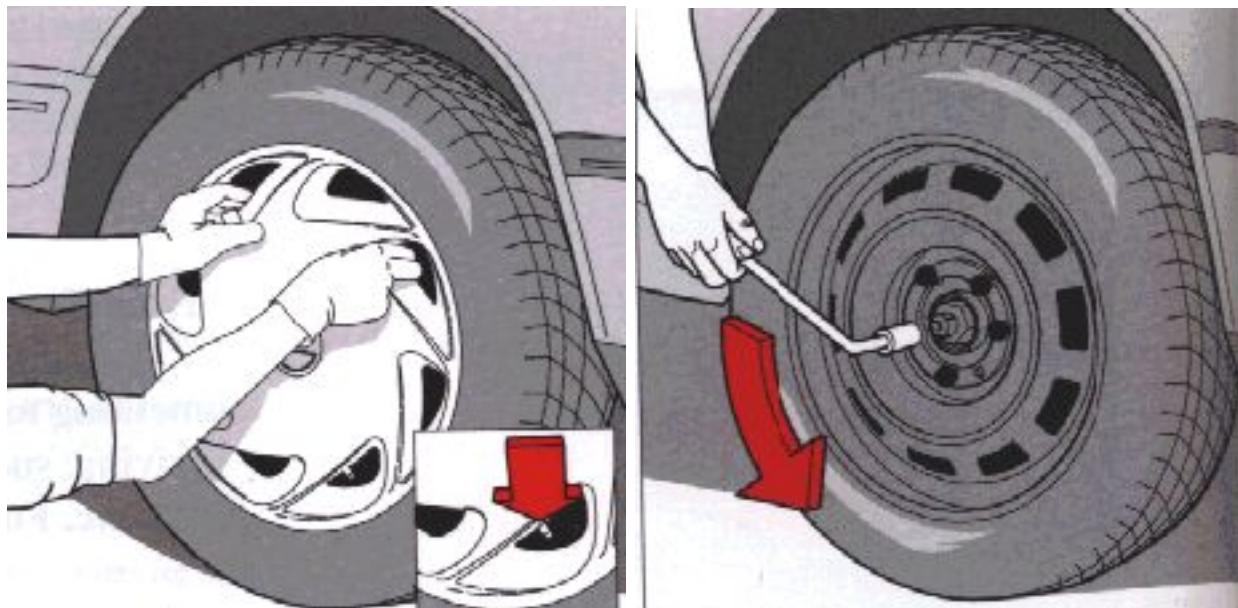
**NOTE:**

To avoid excessive wear and the necessity of rebalancing, mark and reinstall wheels in same location and position as before removal. To lessen the chance of imbalance, each wheel hub is equipped with a guide stud to ensure that a removed wheel can be reinstalled in its original position (as when changing over to winter tires/wheels). When reinstalling the wheel cap, allow a gap of approximately 1/5" (5 mm) between the cap and the rim to help prevent imbalance.

**NOTE:** The crank handle on the jack can be folded out by pressing the nob on the handle downward (see illustration above). To attach the jack, refer to the illustration on the following page.

pg. 6:4 Wheel changing (cont.)

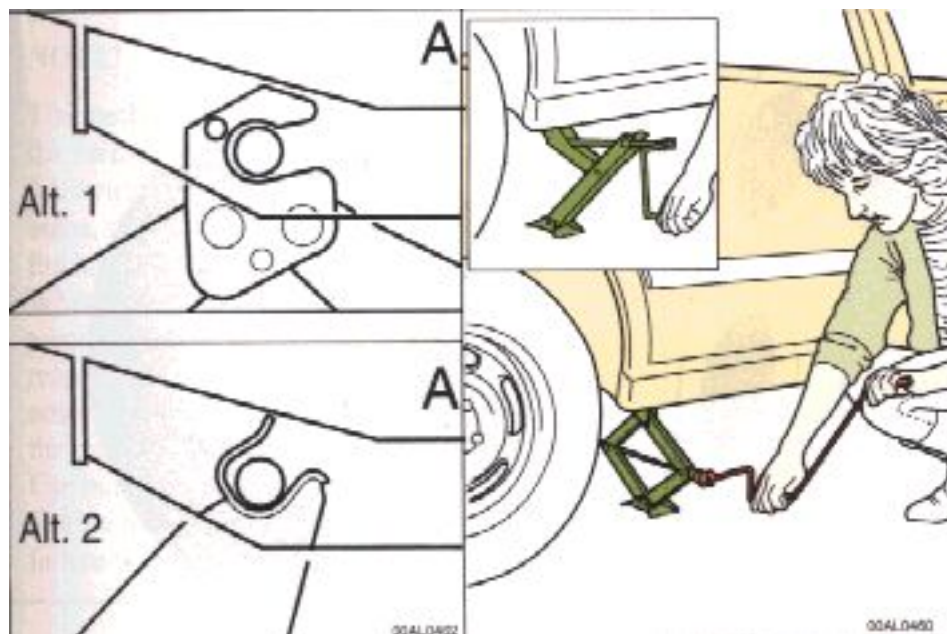

*Jack attachment*

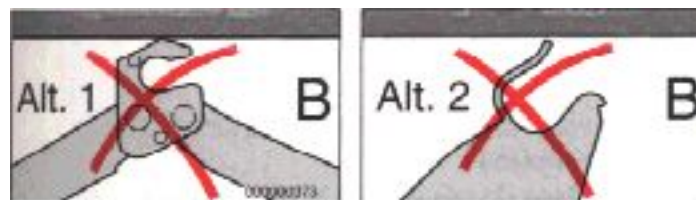

There is a jack attachment adjacent to each wheel location. Hang the jack from the attachment (alt. 1) or position the jack on the bar in the jack attachment (alt. 2) as shown in the illustration above and crank while simultaneously guiding the base to the ground. The base of the jack must be flat on a level, firm, non-slippery surface. Before raising the car check that the jack is still correctly positioned in the attachment. Now raise the vehicle until the wheel is free of the ground. Unscrew the wheel nuts completely and carefully remove the wheel so as not to damage the tread of the studs.

### WARNING!

- The jack's hook engage the bar in the jack attachment (A). The car's weight must not rest on the jack's attachment (B).
- Be sure the jack is on a firm, level, non-slippery surface.
- Never allow any part of your body to be extended under a car supported by a jack.
- Use the jack intended for the car when replacing a wheel. for any other job, use stands to support the end of the car being worked on.
- Apply the parking brake, select position P (automatic transmission).
- Block the wheels standing on the ground. Use rigid wooden blocks or large stones.
- The jack should be kept well-greased.

### Installing the wheel



Clean the contact surfaces on the wheel and hub. Lift the wheel and place it on the hub. Make sure that you align the wheel with the guide stud on the wheel hub prior to installation. Install the wheel nuts crosswise and tighten lightly. The bevelled side of the nuts should face the wheel. Lower the vehicle to the ground and alternately tighten the nuts to 63 lbs. (85 Nm). Install the wheel cap. Some models have a hub cap that extends to the wheel rim. The valve symbol on the inside of the hub cap should be installed toward the valve. After driving for a short time, a gap of approximately 0.2" (5 mm) will develop between the wheel cover and the rim. This is normal.

---



[Contents](#) | [Top of Page](#)

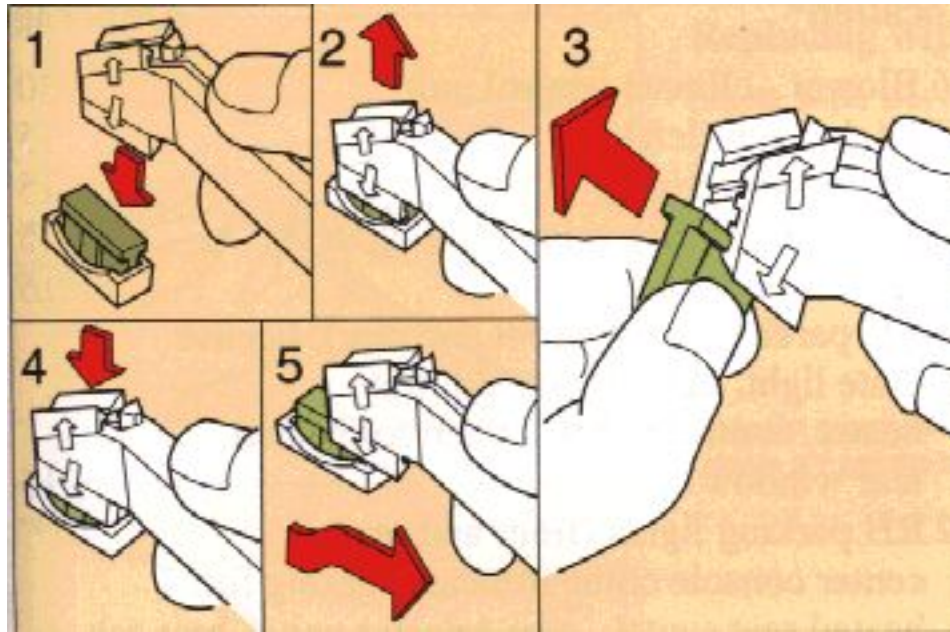

It is necessary to remove the fuses to see if they are blown, see next page for information on fuses and related circuits.

If you find it difficult to obtain access to the fuses, unclip the fuse tool on the right-hand side of the fuse compartment and use it to remove the fuse, see illustration.

- 1 Press the tool onto the fuse.
- 2 Pull the tool and fuse straight up
- 3 Pull out the fuse from the tool and push in a new fuse in the same way.
- 4 Push in the fuse in the fusebox with the tool.
- 5 Slide the tool out.

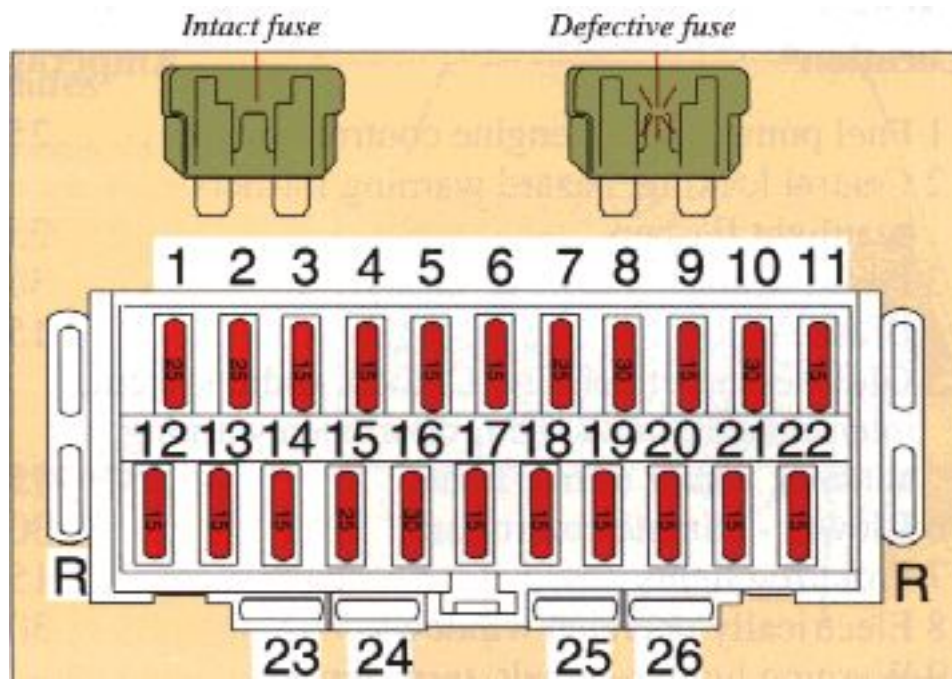

The fuses are removed by pulling them straight out. If they are defective, the metal wire is broken. When fitting a new fuse, be certain to use one with the same amperage and color as the one removed (see top of fuse)! Spare fuses are located on each side of the fusebox (1x15A, 1x25A, 1x30A).

pg. 6:14 Fuses (cont.)

#### Location\* Amperage

- 1 Fuel pump (main), engine control systems 25
- 2 Central locking, hazard warning flashers, headlight flashers 25
- 3 Power seats 30
- 4 Brake lights 15
- 5 Glove compartment light, clock, audio system, interior light, trunk light, door open warning, antenna, vanity mirror lights 15
- 6 Blower - climate control unit 30
- 7 Front fog lights 15
- 8 Electrically operated windows 30
- 9 Warning light, seat belt, turn signals, heated front seats, electrically-operated windows, shift-lock 15
- 10 Heated rear window power sunroof heated side-view mirrors 30
- 11 Fuel pump (tank), heated oxygen sensor 15
- 12 Back-up lights, cruise control, disengagement of 4th gear on automatic transmission 15
- 13 Spare
- 14 Electrically-operated side view mirrors, cigarette lighter, radio, rear wiper/washer (wagon), ambient temperature sensor 15
- 15 Horn, windshield wash/wipe, power seats 25
- 16 Blower - climate control unit 30
- 17 High beam (left) 15

- 18 High beam (right) 15
- 19 Low beam (left), relay - fog light(s) 15
- 20 Low beam (right) 15
- 21 LH parking lights (front and rear), license plate light, light for: ash tray, heater, control panel, switch for heated rear window 15
- 22 RH parking lights (front and rear), center console compartment, lighting for: heated seat switch, gear selector panel, rear ash tray 15
- 23 Heated front seats 25
- 24 Spare
- 25 Rear fog light 25
- 26 Audio system 15

for more detailed information concerning function and location of relays, fuses, etc., refer to the Volvo Service Manuals. These can be purchased directly using the Service Literature Brochure/Order form or through your Volvo dealer.

\* Some of the equipment/systems listed may be available on certain models only.

**NOTE:** On cars equipped with ABS, the system is protected by an additional 10A fuse located under the instrument panel to the left of the steering wheel.

pg. 6:15 Replacing wiper blades, Adjusting washer nozzles

### Replacing wiper blades

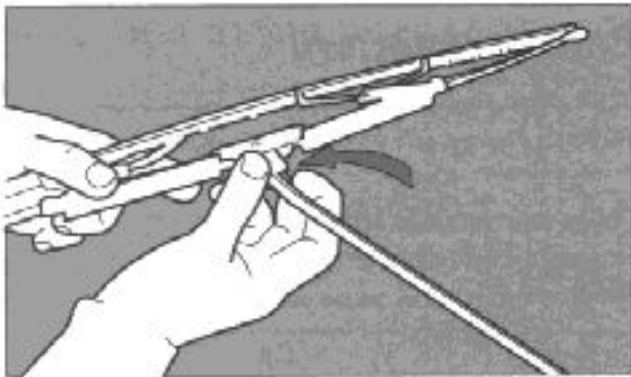

Lift the wiper arm off the windshield and hold blade at right angles to arm. Pinch the end of the plastic clip located at the back of the arm.

Slide the wiper blade along the arm to release it from the hook.

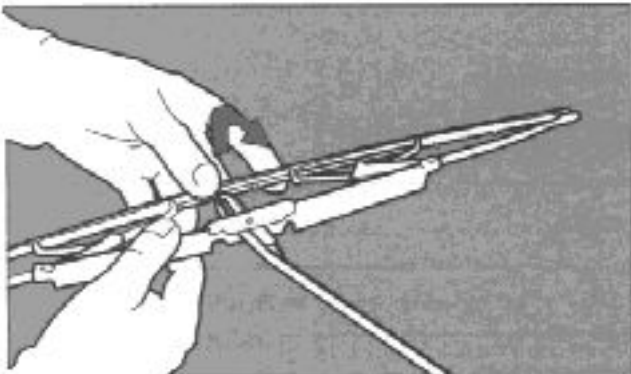

Install new blade (installation is the reverse of removal) and make sure that it is properly attached to the wiper arm.

for reasons of safety, you should change the windshield wiper blades as soon as they start to leave marks on the windshield or fail to wipe efficiently and cleanly.

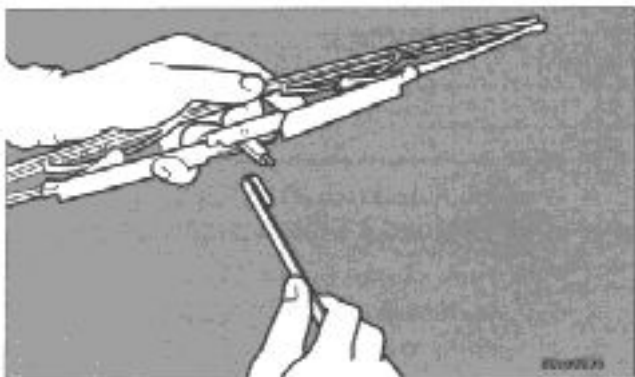

To obtain maximum lifetime from a set of wiper blades, clean them with a stiff-bristle brush and warm, soapy water as part of a normal car wash.

### Adjusting washer nozzles

The washer jets should spray the windshield as shown. Use the edge of a small screwdriver to adjust the nozzles, if necessary.

### Washer fluid reservoir

The washer fluid reservoir is located in the engine compartment and holds approx. 0.5 US gal. (2.0 liters) on sedan models and approx. 0.8 US gals (3.2 liters) on wagon models.

During cold weather, the reservoir should be filled with windshield washer solvent.

## pg. 6:16 Service diagnosis

This section contains information which can be of help in the event of a breakdown. Only those faults which can be rectified with the vehicle's tool kit are listed.

The engine does not start or is difficult to start.

The instructions for starting the engine have not been followed.  
follow the instructions in section "Starting the engine".

The battery is poorly charged or dead  
Start the vehicle by using an auxiliary battery.  
Recharge the battery.  
Find out why the battery is poorly charged.

### Poor contact in the electrical system

Check all leads to spark plugs, coil, distributor, battery and starter motor.

No fuel reaching engine

Check that there is fuel in the tank.

Check that none of the hoses in the fuel system are loose.

Check that the fuses for the pump are not faulty, fuses No. 1 and 11.

Faulty distributor ignition system

Check spark plugs, electrode gap should be 0.028" (0.7 mm), and wipe clean.

Check distributor cap for cracks and wipe clean on inside.

Check that all electric leads in the distributor ignition system are clean and correctly connected.

Misfiring and erratic engine operation

Faulty distributor ignition system

Check spark plugs, electrode gap should be 0.028" (0.7 mm), and wipe clean.

Check distributor cap for cracks and wipe clean on inside.

Check that all electric leads in the distributor ignition system are clean and correctly connected.

Ice in injection system

Park the vehicle in a warm garage and add fuel line de-icer to the fuel system.

Blocked air cleaner/fuel filter

Change cleaner/filter

pg. 6:17 Service diagnosis (cont.)

Tire imbalance or vibration during driving

Wheel imbalance

Have the wheels re-balanced.

Level of oil in power-assisted steering pump too low

Check and fill oil, see section "Power steering fluid".

Engine overheats

Radiator hose cracked or leaking



Check and replace if necessary

Insufficient coolant

Check and fill coolant, see section "Cooling system".

Fan belt frayed or belt tension incorrect

Replace or adjust tension.

pg. 6:18 Service diagnosis (cont.)

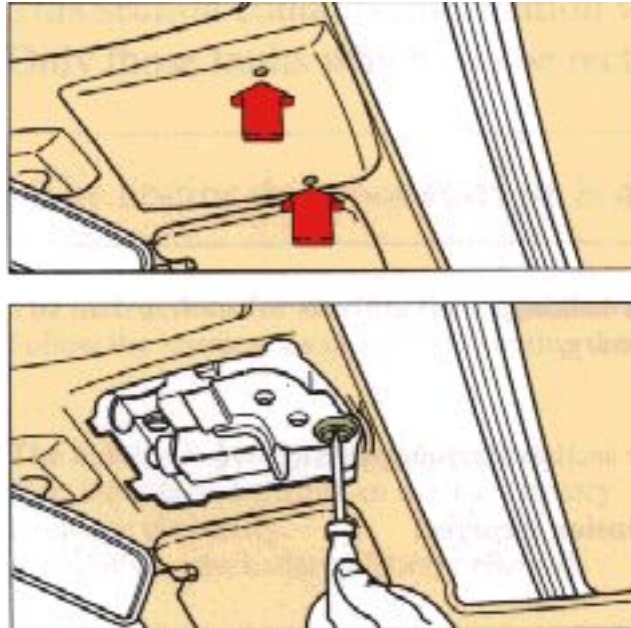

Emergency sun roof operation

If, because of an electrical fault (e.g. a blown fuse), it is not possible to operate the sun roof electrically, then it is manually.

First, using a small screwdriver, remove the two screws that secure the sun roof motor cover to the headliner. Then using a screwdriver, depress the white plastic clutch pin in the center of the motor screw (see illustration) and turn the screw to close or open the roof as desired.

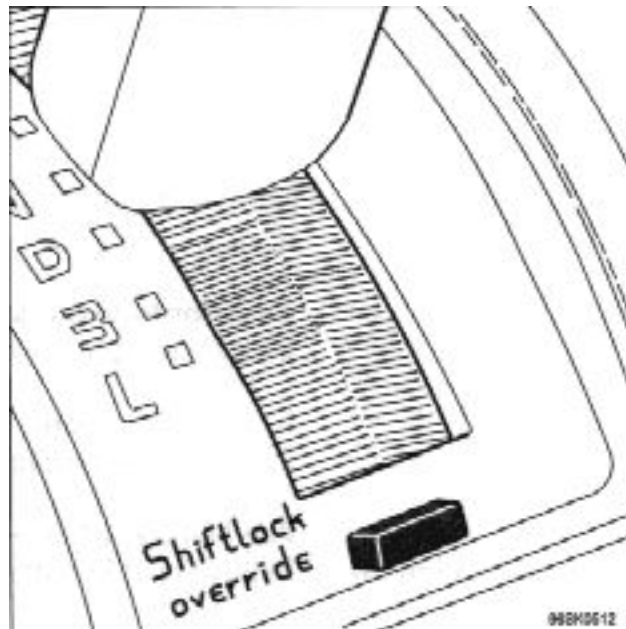

## Shiftlock release

The gear selector is locked in the P position. To manually release the shift lock, turn the starting (ignition) key to position I and press firmly on the "SHIFTLOCK OVERRIDE" button located near the base of the gear selector (see illustration). While holding the override button down, move the gear selector from the (P)ark position.



[Contents](#) | [Top of Page](#)

## pg. 6:5 Replacing bulbs

**NOTE!**

The method for replacement of bulbs in the various lighting units is shown on the following pages. Make sure when installing bulbs, that the guide pin on the socket fits into its corresponding recess. When installing Halogen bulbs, do not touch the glass with your fingers. The reason for this is that grease, oil or any other impurities can be carbonized onto the bulb and damage the reflector. Use bulbs of correct type and voltage. Failure to do so could cause the bulb failure warning light to activate.

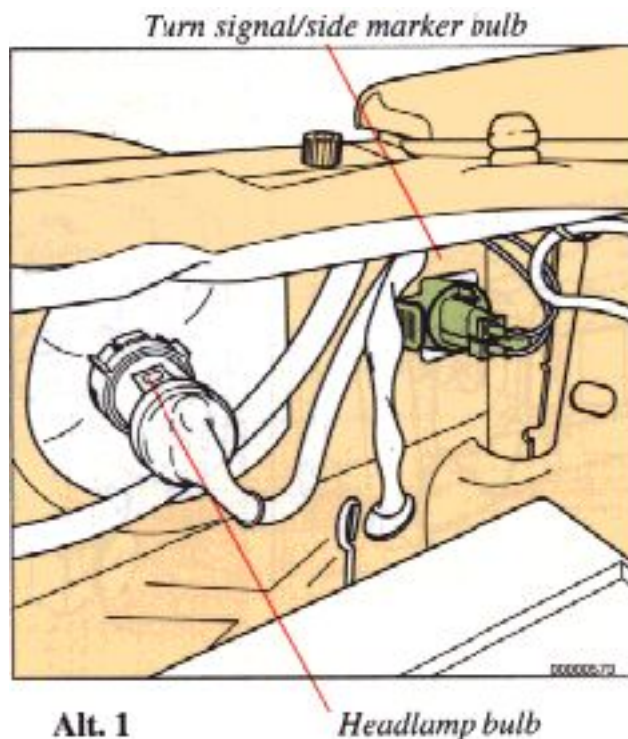

## Headlamps

- 1 Pull the connector out.
- 2 Loosen the ring by turning it counterclockwise.
- 3 Pull the bulb straight out.
- 4 Replace the bulb and reinstall the unit in the reverse order.

Bulb Power US Bulb No.

Headlamp (45/65) HB1/9004

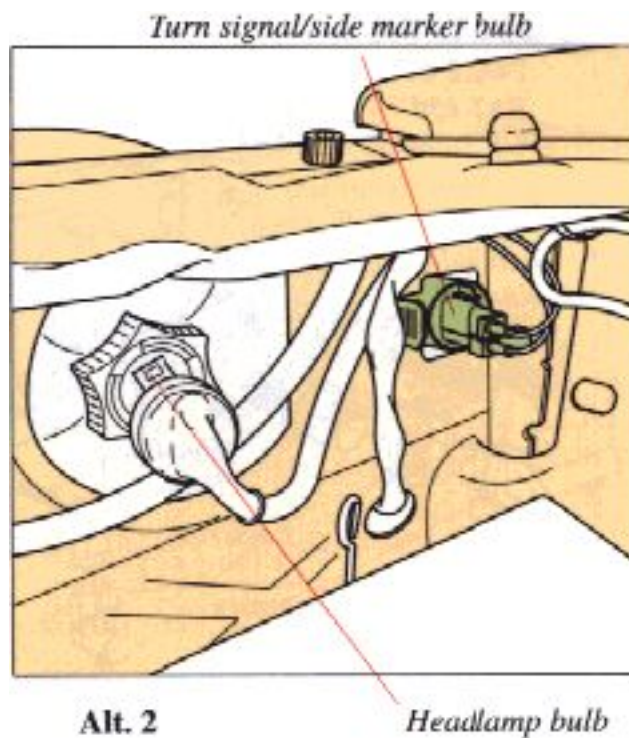

### Turn signal/parking light/side marker bulb

- 1 To remove, turn the lamp holder 1/4 turn counter-clockwise.
- 2 Press the bulb in and turn it 1/4 turn counter-clockwise.
- 3 Replace the bulb and reinstall the unit in the reverse order.

Power CP (W) Socket US Bulb No.

24/2.2 (21/5) BAY 15d 1157 NA

pg. 6:6 Replacing bulbs (cont.)

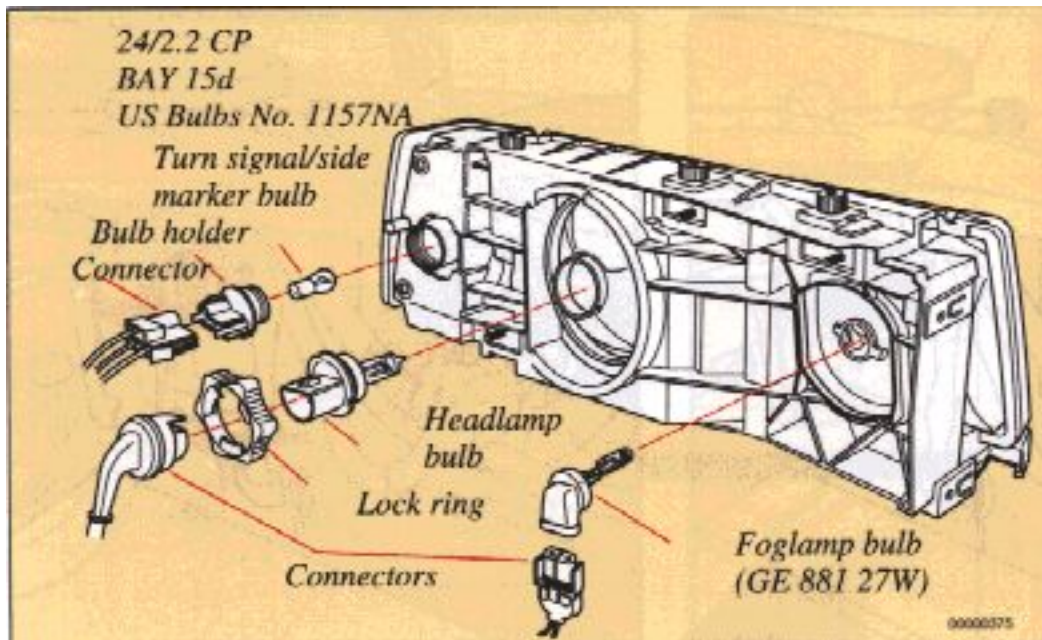

Models with front fog lamps

Access to the bulbs is obtained from the engine compartment. Switch off the lights and ignition key.

fog lamps

- 1 Turn the lamp holder 1/4 counter-clockwise.
- 2 Remove the bulb from the connector by pushing the catches to the sides.
- 3 Replace the bulb and the holder.

Note : Reinstall the unit carefully to avoid changing the direction of the beam.

Bulb Power US Bulb No.

foglamp (27 W) GE881



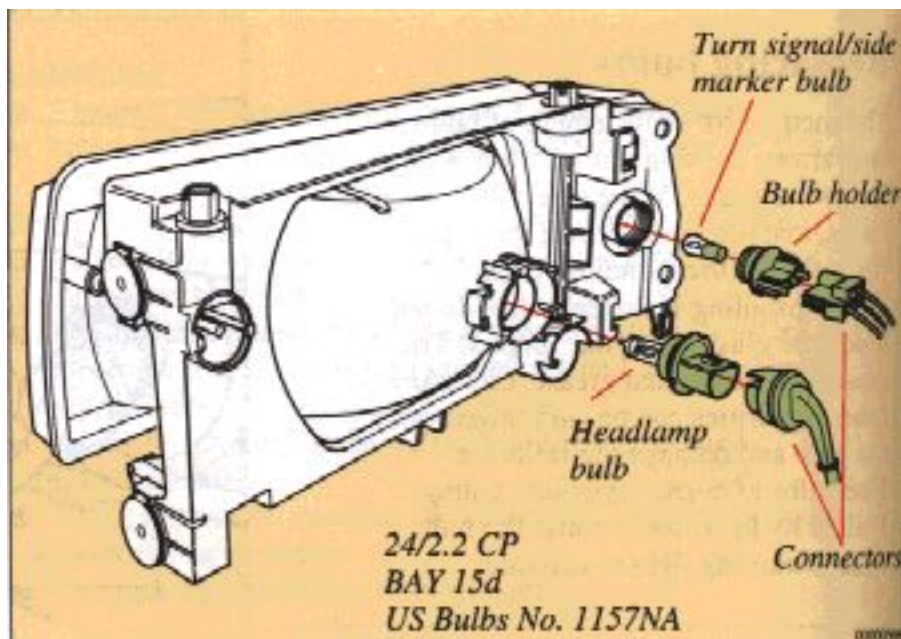

### Models without front fog lamps

Note : It may be necessary to remove the washer fluid reservoir fill tube in order to gain access to the bulb holder.

pg. 6:7 Replacing bulbs, Sedans

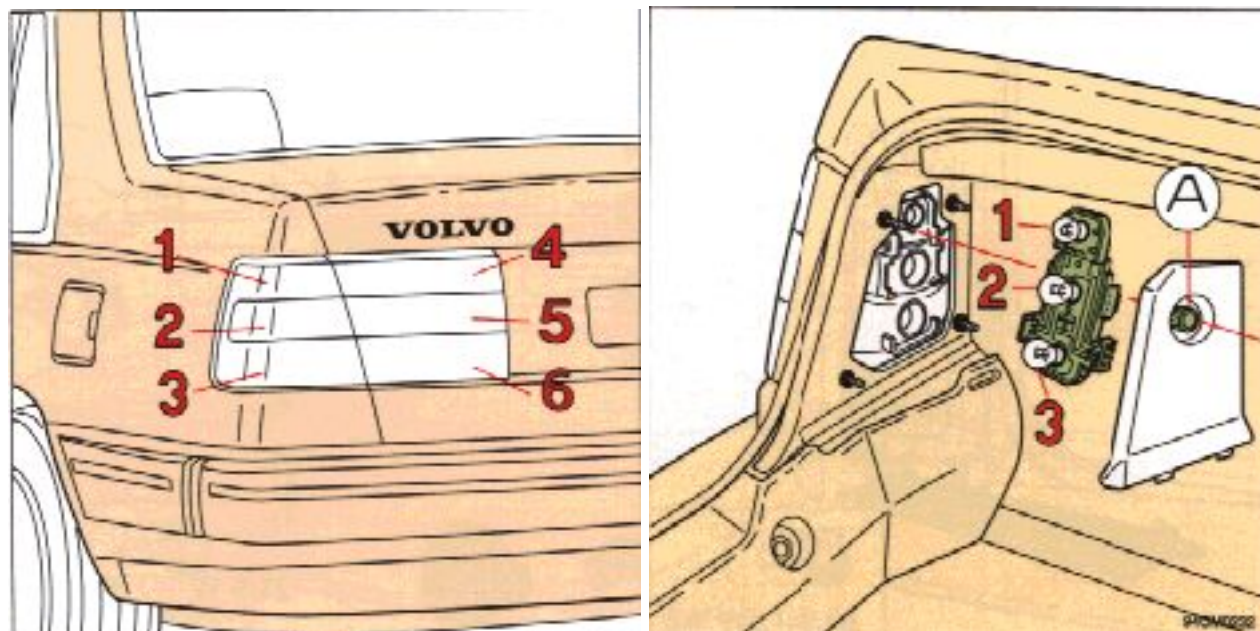

### Replacing tail lights bulbs (sedan models)

All tail lamp bulbs are replaced from inside of trunk. To avoid confusion, replace the bulbs one at a time.



- 1 Unscrew and remove tail lamp inside cover. Note that inside cover is hooked at the lower edge.
- 2 Remove plastic screw A and remove bulb holder and bulb (one unit).
- 3 Depress bulb in bulb holder, turn it slightly counterclockwise, and remove it.
- 4 Install a new bulb. Install bulb holder in tail lamp.
- 5 Check that bulb lights. Replace tail lamp inside cover.

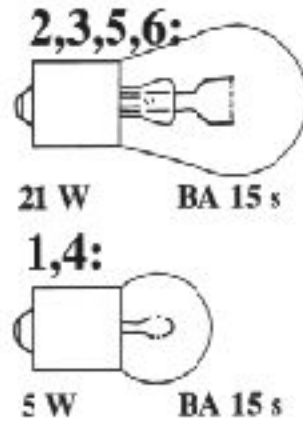

**Bulbs Power Socket US Bulb No  
CP(W)**

- 1,4 Tail light 4 (5) BA 15s 67
- 2 Rear turn signal 32 (21) BA 15s 1156
- 3 Brake light 32 (21) BA 15s 1156
- 5 Back-up light 32 (21) BA 15s 1156
- 6 Rear foglight\* 32 (21) BA 15s 1156

\* One light only, on left side

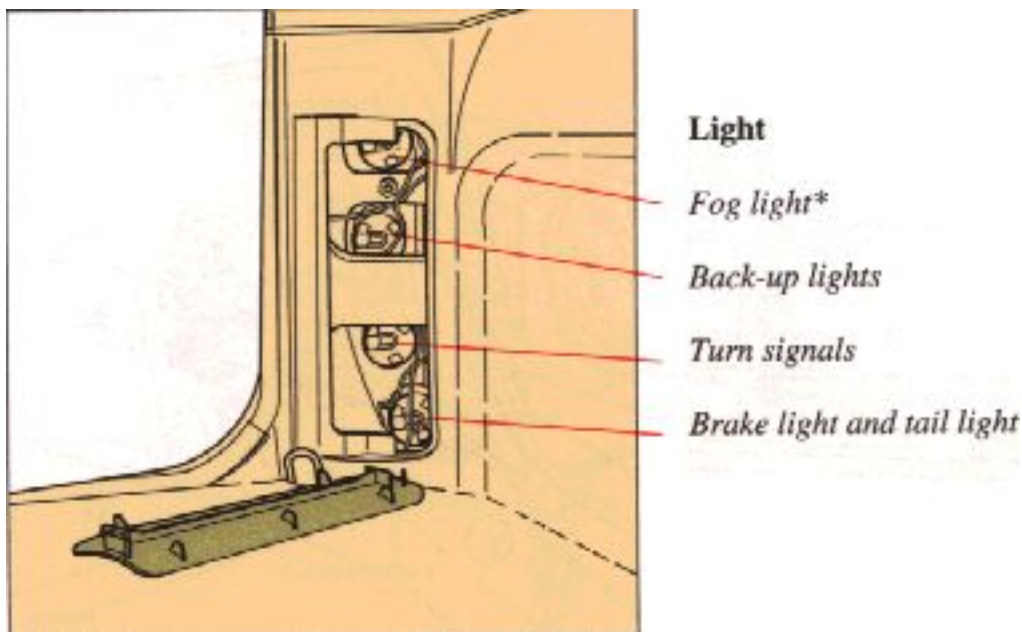

*All tail light bulbs are replaced from inside the vehicle*

### Light Wattage Socket

*fog light \* 21W 32CP BA15s*

*Back-up lights 21W 32CP BA15s*

*Turn signals 21W 32CP BA15s*

*Brake light and tail light 21/5W 32/3CP BAY15d*

White lamp holders on the right side, black holders on the left side.

\* Left side only

### Replacing tail light bulbs (wagon models)

To avoid confusion, replace the bulbs one at a time.

- Turn off the lights
- Remove the cover with a screw driver
- Rotate the bulb holder about 1/2" (1 cm) counterclockwise and remove the holder from the tail light cluster.
- Gently press the bulb into the holder, then rotate the bulb counterclockwise in order to release it.
- Install a new bulb in the holder and replace the bulb holder in the tail light cluster.
- Turn the bulb holder clockwise
- Check that the bulb lights
- Re-install cluster cover

pg. 6:9 Replacing bulbs

**WARNING!**  
When using a screwdriver to pry plastic components, take care to avoid scratching or breakage. Use eye protection whenever possible.

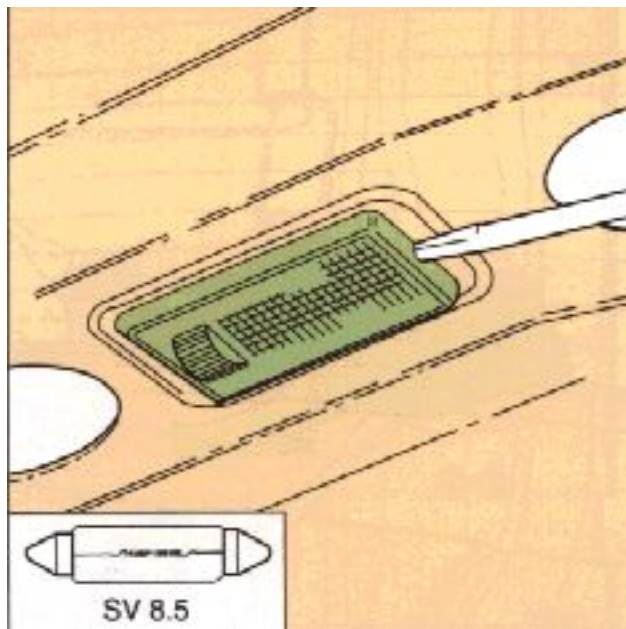

Trunk light  
(sedan models)

Depress the catch with a screwdriver and remove the light assembly. Lift it out remove.  
Replace the bulb.

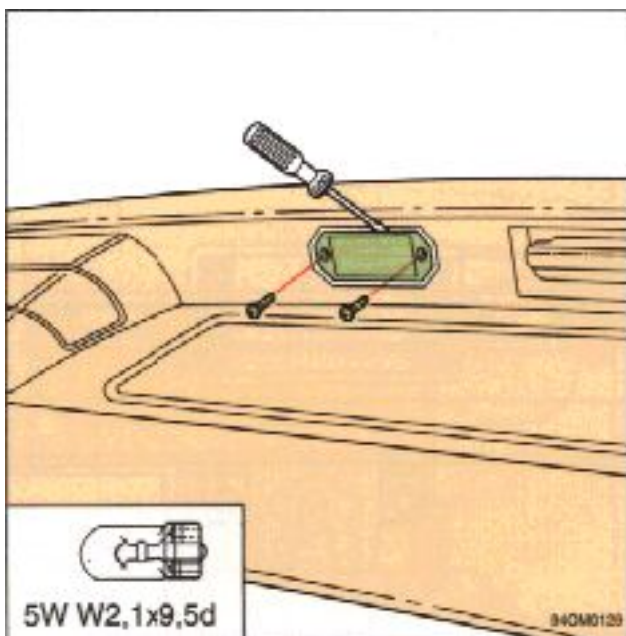

## License plate light (sedan models)

Remove the screws with a screwdriver. Insert a screwdriver and pry off the light assembly.  
Replace the bulb and re-install light housing.

Bulb Power Socket Bulbs Power Socket  
Trunk light 10W SV8.5 License plate light 5W W2,1x9,5d

### pg. 6:10 Replacing bulbs (cont.)

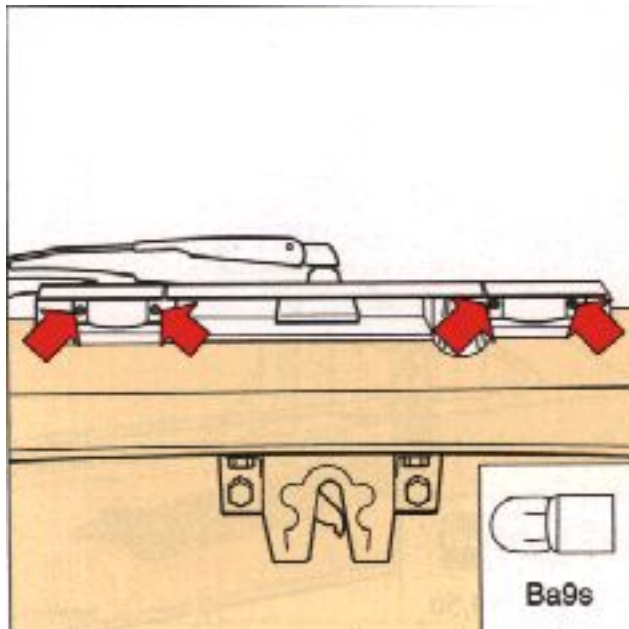

## License plate light (wagon models)

Remove the screws with a screwdriver.  
Remove lamp housing. Depress the bulb and rotate it counter-clockwise. Remove the bulb.  
Install a new bulb and re-install light housing.

Bulb Power Socket  
License plate light 4W Ba 9s

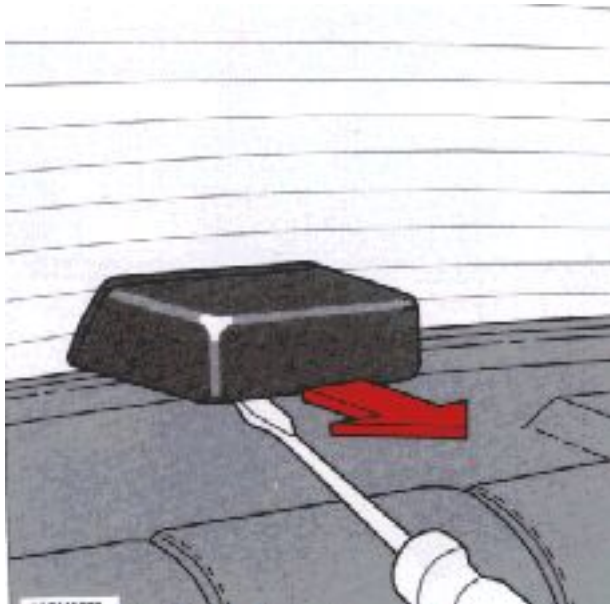

*Depress catch with screwdriver*

## High-level brake lights

To remove:

Turn off ignition. Depress catch with a screwdriver.

Grasp the cover with both hands and pull it towards you.

## Bulb Power Socket

High level brake light 21W 32cp Ba 15s

(US bulb no. 1156)



*Depress catches*

Depress catches and fit new bulb.

To fit:

Fit the reflector and check that the light works.

Sedan models

Press the cover into position, noting the position of the alignment pin at the top.

Wagon models

Align the catches and press the cover into position.

pg. 6:11 Replacing bulbs (cont.)

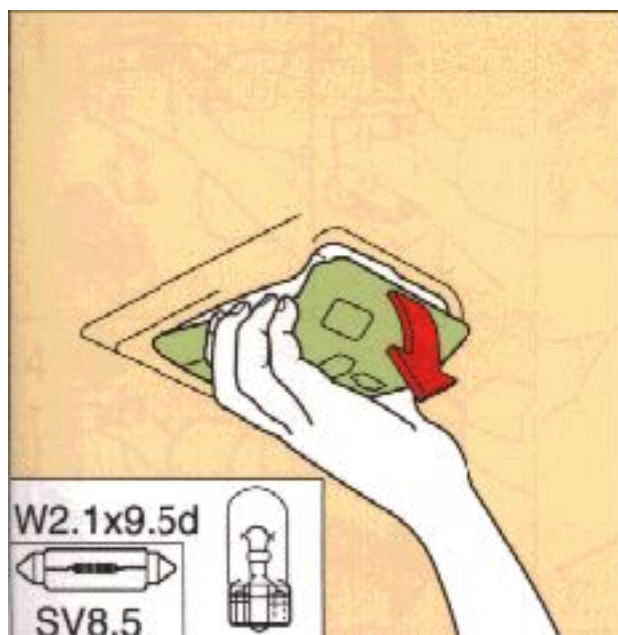

Interior light and reading lights

Take hold of the front section of the light as shown and pull straight down.

Replace the blown bulb and check operation before reinstalling the bulb housing.

Bulb Power Socket

Interior light 10W SV8.5

Reading light 5W W2.1x9.5d



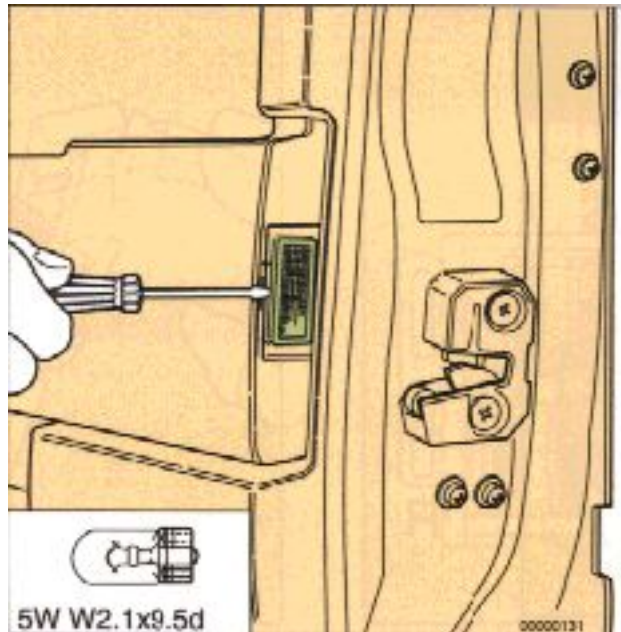

### Door Warning lamps

All doors are equipped with red warning lamps. To replace a bulb, insert a screwdriver as shown in picture and gently turn it to remove the lens. Withdraw the bulb, replace it and re-insert the lens

### Bulb Power Socket

Door warning lamp 3W W2.1x9.5d

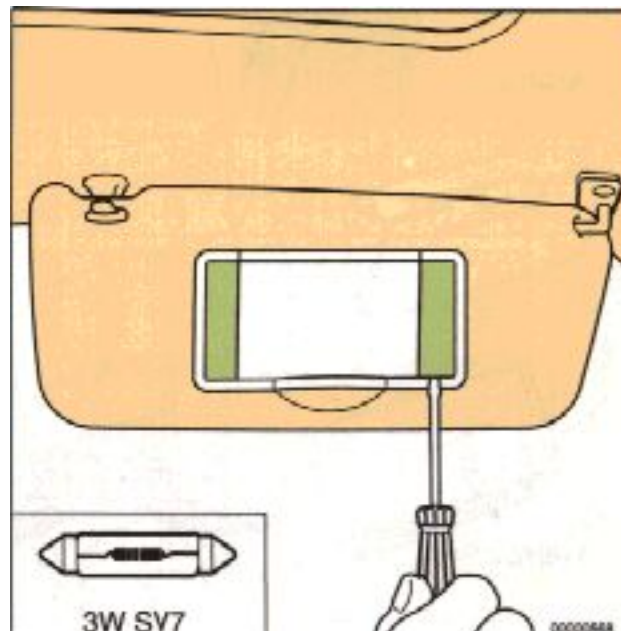

*Insert screwdriver and turn*

### Vanity mirror

Insert a screwdriver and turn it to remove the lens. Replace the bulb and press the lens back into place.

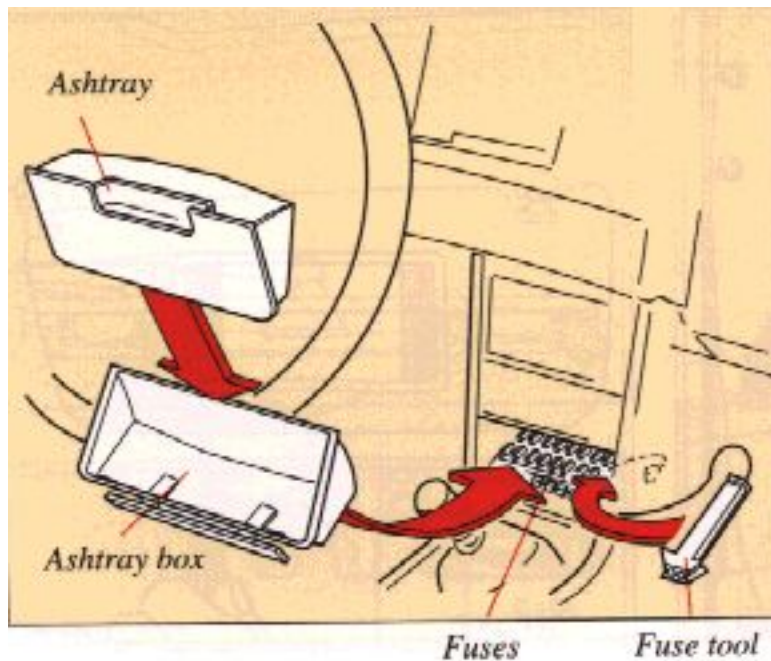

## Fuse replacement

A blown fuse is indicated by the failure of all the units protected by it, and it is caused by overloading the circuits. The fuses (and relays) are located in the central electrical unit behind the ashtray in the center console.

To obtain access to the central electrical unit:

Remove the ashtray. Pull out and depress the tongue.

Press up the section marked "electrical fuses-press" and remove the unit.

There are 25 fuses in two rows. See following pages for fuse designations/locations.



[Contents](#) | [Top of Page](#)

## Car care

### pg. 7:1 Car care

Car care includes not only maintaining the appearance of the car, but also protecting the car exterior from the effects of air pollution, rain and mud.

The rustproofing compound under the car should be checked regularly and, if necessary, damaged areas should be repaired.

The paintwork should also be touched up immediately, if damaged, to prevent rust formation.

### [7:2 Rustproofing](#)

### [7:4 Paintwork damage](#)

### [7:6 Washing the car](#)

### [7:8 Cleaning the upholstery](#)

### pg. 7:2 Rustproofing

What causes rust

The two most common causes of rust to your car are:

- The accumulation of road dirt and moisture in hard-to-get-at cavities and other areas under the car.
- The removal of paint and protective coatings on the outside of the car and underneath through damage by stones, gravel or minor accidents.

Several factors influence the speed at which corrosion will occur:

- The length of time various parts of a car stay wet. Parts of the car filled with road dirt and water remain damp for long periods of time even after other parts have dried. Particular attention should be paid to the underside of the car and floor sections inside. The floor sections stay wet because moisture collects and remains under the floor matting. Drain holes located at the bottom of the doors can get clogged with dirt, trapping water inside the door and causing the door to rust at the bottom.
- Corrosion will be accelerated in areas of higher relative humidity, especially where temperatures often stay above the freezing point and where the atmosphere is affected by industrial pollution, or where salt is used for de-icing the roads.

Where parts of the car are covered with road dirt containing road salt, corrosion will be accelerated at lower relative humidity than if the surface were clean.

- Increased temperature will cause an accelerated rate of corrosion of those parts of the car which are not well ventilated to permit quick drying.

- Industrial pollution and the presence of salt will also accelerate the deterioration of paint finishes.

The foregoing identifies the need for every car owner to keep his or her car-particularly the underside-as clean and dry as possible and to repair any minor damage to paintwork and protective coating as soon as possible.

The need is more important in those areas where road salt is used for de-icing, the relative humidity is higher, air pollution is present, and temperatures regularly stay above freezing.

### Rustproofing, inspection and touching-up

Your Volvo was carefully and thoroughly rustproofed at the factory.

The underbody and wheelhousings were sprayed with a thick, durable rustproofing compound and the beams, internal cavities and end sections were sprayed with a low viscous, penetrating rustproofing agent.

There are two very effective methods of maintaining this protection:

- Keep your car clean.

Clean the underbody, wheelhousings and the edges of the fenders using water at high pressure.

- Inspect and touch-up the rustproofing if necessary.

### The invisible (internal) rustproofing

As part of your maintenance schedule, it is important that the invisible rustproofing (used for beams, internal cavities and end sections) be retreated first after 36 months and, thereafter, every 24 months.

Bear in mind, if good results are to be obtained, that these sections must be treated with a fine spray of Volvo-approved rustproofing compound by your authorized Volvo dealer.

pg. 7:3 Rustproofing

### The visible rustproofing

The visible (external) rustproofing must be inspected by an authorized Volvo dealer at 20,000 mile (32,000 km) intervals. If it is necessary to touch-up the rustproofing, this should be done immediately to prevent moisture penetration. Wash and dry thoroughly before touching up. Use spray-on or brush-on rustproofing compounds.

There are two different types of rustproofing compounds available:

- a. thin (transparent) for visible parts.
- b. thick, for parts on the underbody and wheel housing which experience most wear.

Parts of the car which may need to be touched up and the recommended rustproofing compound are:

- visible welded seams and panel seams-(thin)
- underbody and wheel housings-(thick)
- door hinges-(thin)

- hood hinges and locks-(thin).

After completion of all work on the vehicle, remove excess rustproofing compound with a cloth soaked in kerosene.

The sheet metal surfaces of the engine compartment are protected by a transparent wax-based rustproofing compound. The compound withstands normal washings without deterioration.

Mineral based solvents will, however, dissolve the compound, especially so if they contain emulsifiers. In such cases the wax protection should be renewed.

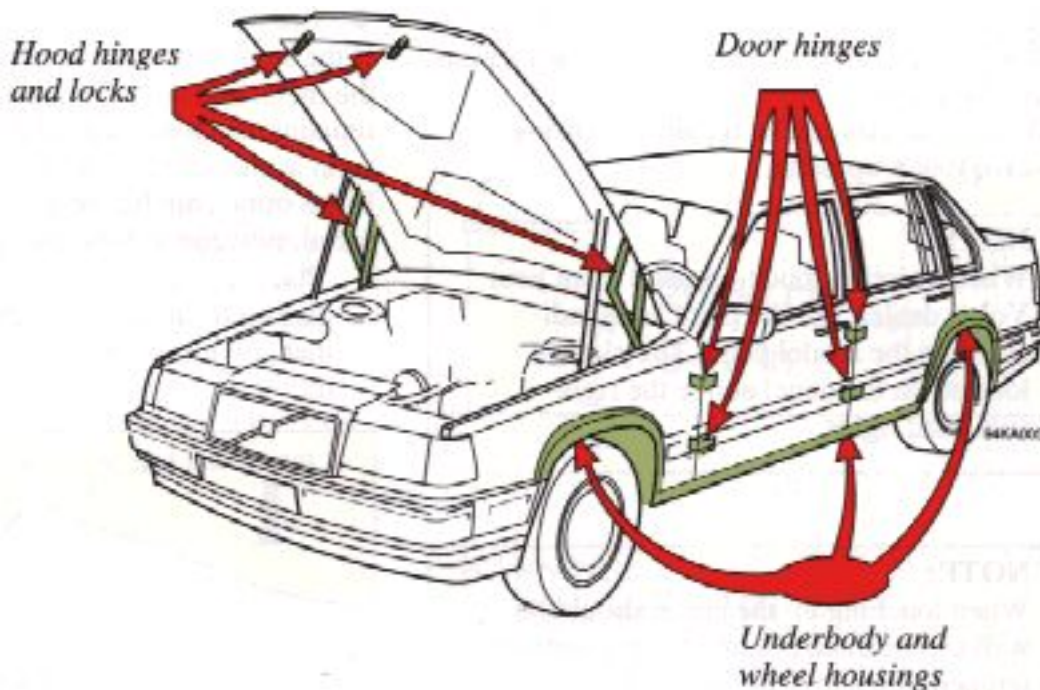

pg. 7:4 Paint touch-up

## Paint touch-up

Paint damage requires immediate attention to avoid rusting. Make it a habit to check the finish regularly; when washing the car for instance. Touch up if necessary. Paint repairs require special equipment and skill. Contact your Volvo dealer for any extensive damages.

Minor scratches can be repaired by using Volvo touch-up paint.

**NOTE:** When ordering touch-up paint from your Volvo dealer, use the paint code indicated on the model plate. The plate is located on the panel above the right-side head lights.

**NOTE:** When touching up the car, it should be cleaned and dry. The surface temperature should be above 60°F (+15°C).

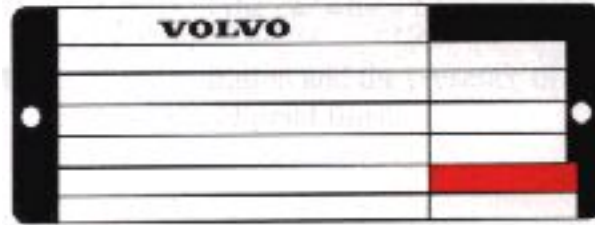

Minor stone chips and scratches

Material:

- Primer - can
- Paint - touch-up bottle
- Masking tape
- Brush

If the stone chip has not penetrated down to the metal and undamaged layer of paint remains, the touch-up paint can be applied as soon as the spot has been cleaned.

If the stone chip has been penetrated down to the metal, proceed as follows:

1 Place a strip of masking tape over the damaged surface. Pull the tape off so that any loose flakes of paint adhere to it.

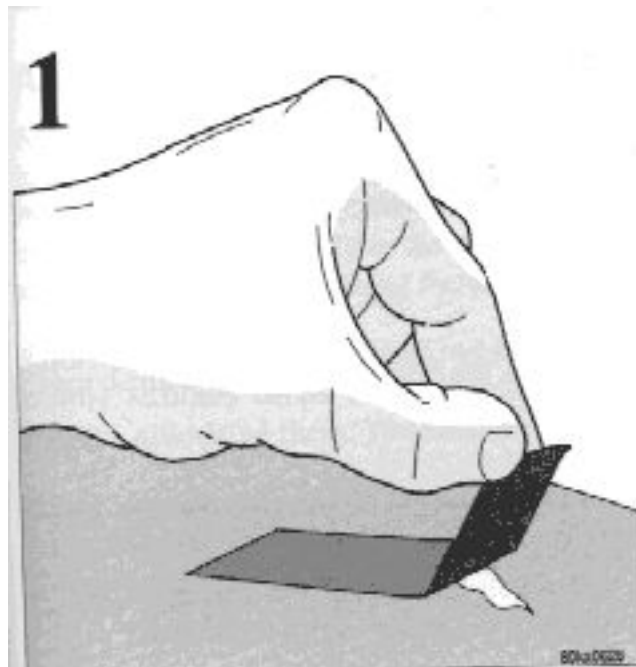

Remove loose flakes of paint with masking tape

2 Thoroughly mix the primer and apply it with a small brush.



2

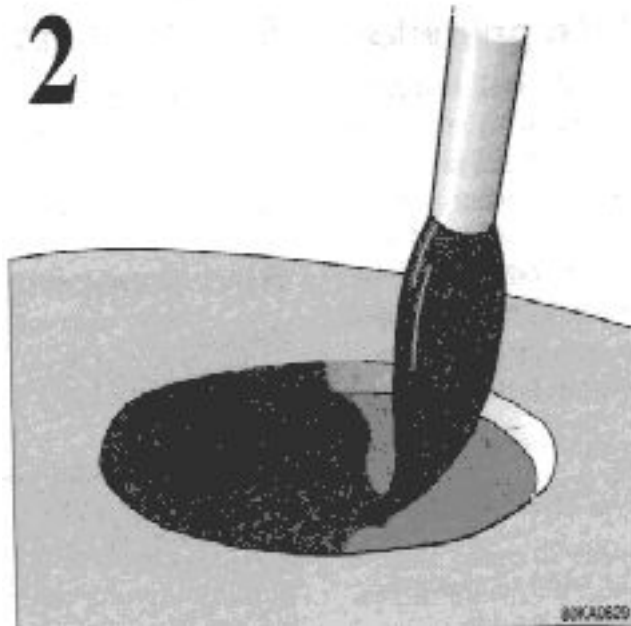

When the primer surface is dry, the paint can be applied using a brush.  
Mix the paint thoroughly: apply several thin paint coats and let dry each application.

pg. 7:5 Paint touch-up (cont.)

3

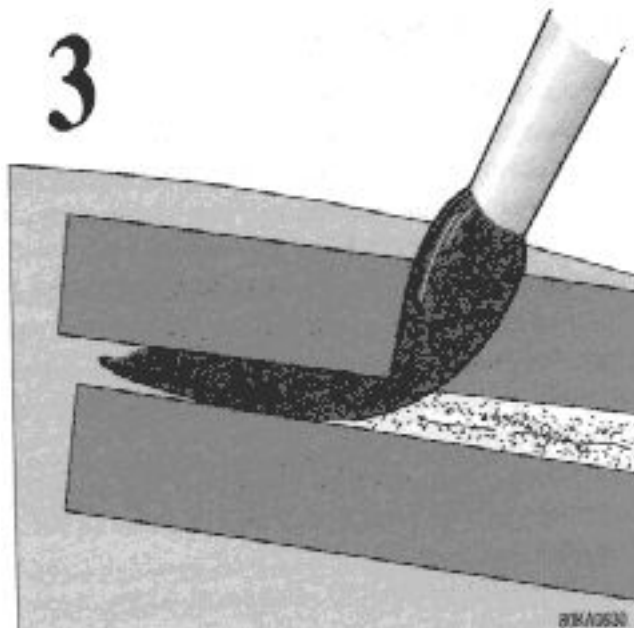

3 If there is a longer scratch, you may want to protect surrounding paint by masking it off.

Touching up damaged paint on fender edges and sills

Material:

- Primer - spray
- Paint - spray
- Masking tape

**NOTE:**  
When touching up the car, it should be well cleaned and dry and have a temperature exceeding 60°F (+15°C).

Mask with tape and paper prior to painting larger surfaces. Remove the masking immediately after application of the last paint coat, before the paint starts to dry.

Touching up is as follows:

- Remove paint flakes with masking tape.
- Shake the spray can for at least 1 minute. Spray on the primer. Move the can slowly and evenly back and forth over the spot and about 8-12 in. ( 20 - 30 cm) from the surface. Protect the surrounding surfaces with suitable paper.

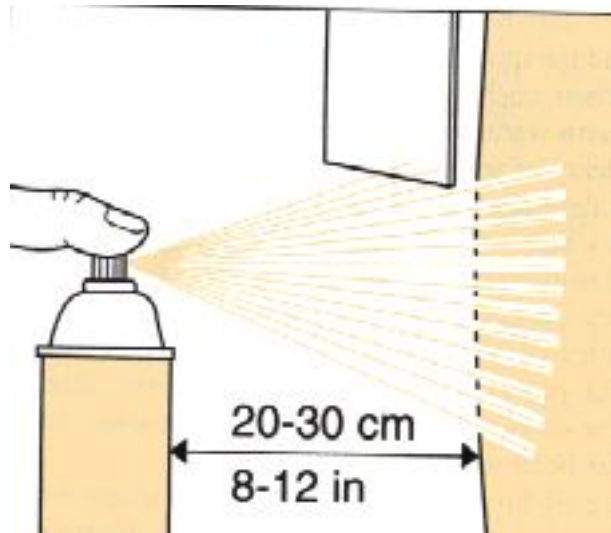

**WARNING!**  
Spray painting should be done in a well ventilated and dust-free area.

- When the primer has dried, apply the surface enamel in the same way. Spray on several times and allow the paint to dry a minute or so between each application.

## Washing the car

The car should be washed at regular intervals since dirt, dust, insects and tar spots adhere to the paint and may cause damage.

When washing the car, do not expose it to direct sunlight. Use lukewarm water to soften the dirt before you wash with a sponge, and plenty of water, to avoid scratching.

A detergent can be used to facilitate the softening of dirt and oil. A water-soluble grease solvent may be used in cases of sticky dirt.

However, use a washplace equipped with a drainage separator.

Dry the car with a clean chamois and remember to clean the drain holes in the doors and rocker panels. The power radio antenna must be dried after washing.

Tar spots can be removed with kerosene or tar remover after the car has been washed.

After washing the engine, the spark plug wells should be blown dry.

A stiff-bristle brush and lukewarm soapy water can be used to clean the wiper blades. Frequent cleaning improves visibility considerably.

During high pressure washing the spray mouthpiece must never be closer to the vehicle than 13" (30 cm). Do not spray into locks.

### NOTE:

It is particularly important to wash the car frequently in the wintertime to prevent corrosion, when salt has been used on the roads. Also wash off the dirt from the underside (wheel housings fenders, etc..)

In areas of high industrial fallout more frequent washing is also recommended.

## Suitable detergents

Special car washing detergents or liquid dishwashing detergent can be used. A suitable mixture is about 2.5 fl. oz. (8.5 cl.) of detergent to 2.6 US gal. (10 liters) of warm water. After washing with a detergent the car should be well rinsed with clean water.

## Bird droppings

Remove from paintwork as soon as possible. Otherwise the finish may be permanently damaged.

**WARNING!**

When the car is driven immediately after being washed, apply the brake several times in order to remove any moisture from the brake linings.

Engine cleaning agents should not be used when the engine is warm. This constitutes a fire risk.

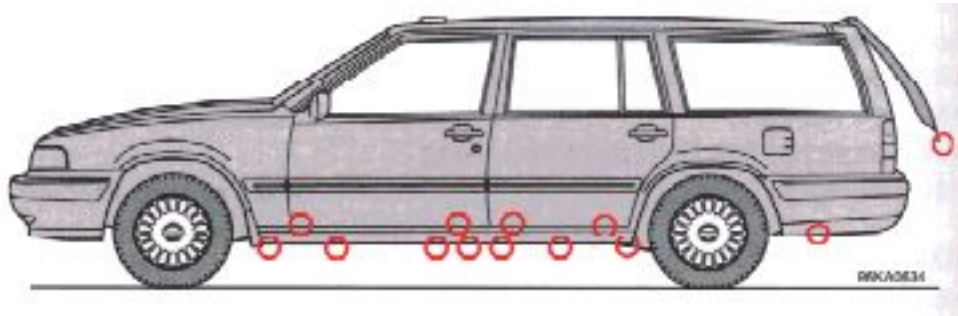

**NOTE:** When washing the car, remember to remove dirt from the drain holes in the doors and sills.

pg. 7:7 Automatic car washing, Polishing and waxing, Chromed parts

### Automatic washing - simple and quick

An automatic wash is a simple and quick way to clean your car. Keeping the underbody clean is most important, especially in the winter. Some automatic washers do not have the facilities for washing the underbody. Before driving into an automatic wash, make sure that the side view mirrors, auxiliary lamps, etc., are secure, otherwise there is risk of the machine dislodging them. You should also lower the antenna. We recommended that you do not wash your car in an automatic wash during the first six months (because the paint will not have hardened sufficiently).

### Polishing and waxing

Normally, polishing is not required during the first year after delivery, however, waxing may be beneficial.

Before applying polish or wax the car must be washed and dried. Tar spots can be removed with kerosene or tar remover. Difficult spots may require a fine rubbing compound.

After polishing use liquid or paste wax.

Several commercially-available products contain both polish and wax. Waxing alone does not substitute for polishing of a dull surface.

A wide range of polymer-based car waxes can be purchased today.

The waxes are easy to use and produce a long-lasting, high-gloss finish that protects the bodywork against oxidation, road dirt and fading.

### Chromed parts

Chromium-plated and anodized parts should be washed with clean water as soon as they become dirty. This is particularly important if you drive on gravel roads or on roads where salt is used during the winter. After the car has been washed, apply wax or an anti-rust preparation. Stains on chrome trim can be removed with commercially-available chrome cleaner. Do not use abrasive compounds or steel wool.

## pg. 7:8 Cleaning the upholstery

### Cleaning the upholstery

Volvo recommends the use of Volvo approving cleaning products which are available at your authorized Volvo dealer.

The fabric can be cleaned with soapy water or a detergent. for more difficult spots caused by oil, ice cream, shoe polish, grease, etc..., use a clothing/clothing fabric stain remover.

The plastic in the upholstery can be washed with soapy water or a mild detergent.

Leather upholstery can be cleaned with a soft cloth and mild soap solution.

for more difficult spots, consult your Volvo dealer.

On no account must gasoline, naphtha or similar cleaning agents be used on the plastic or the leather since these can cause damage.

### Cleaning the seat belts

Clean only with lukewarm water and mild soap solution.

### Cleaning floor mats

The floor mats should be vacuumed or brushed clean regularly, especially during the winter when they should be taken out for drying. Spots on textile mats can be removed with a mild detergent.

### Bear in mind

- Take extra care when removing stains such as ink or lipstick since the coloring can spread.
- Use solvents sparingly. Too much solvent can damage the seat padding.
- Start from the outside of the stain and work toward the center.







## Volvo service

## pg. 8:1 Volvo Service

Service - an investment!

An investment which will pay dividends in the form of improved reliability, durability, and resale value.

[8:2](#) Maintenance schedule

[8:4](#) Volvo service

[8:5](#) Engine oil

[8:7](#) Servicing

[8:12](#) Power steering fluid, brake fluid

[8:13](#) Transmission fluid

[8:14](#) Coolant

[8:15](#) Lubrication, body

[8:16](#) Drive belts

[8:17](#) Engine compartment

## pg. 8:2 Servicing

Maintenance schedule

A = Adjust (Correct if necessary) I = Inspect (Correct or Replace if necessary)

R = Replace L = Lubricate

Maintenance Operation thousand miles (thousand km)	5 (8)	10 (16)	15 (25)	20 (32)	25 (40)	30 (48)	35 (56)	40 (64)	45 (72)	50 (80)	55 (88)	60 (96)
EMISSION SYSTEM MAINTENANCE												
Engine oil and filter	R	R	R	R	R	R	R	R	R	R	R	R
Engine drive belts tension				I		I		I				I
Valve clearance						A						A
Air cleaner filter						R						R

Spark plugs						R						R
Automatic transmission fluid						I		R				R
Rear axle oil		I		I		I		I		I		I
Timing belt - B 230 F		A								R		A
Timing belt - B 230 FT		A								R		A

- 1) These service intervals apply to turbo models only.
- 2) for detailed information, see "Engine oil" section.
- 3) for services beyond 60,000 miles (96,000 km), consult your "Maintenance Records manual".
- 4) B 230 FD only: Adjust at 10,000 miles (16,000 km) - no cost to owner. Replace belt at 100,000 miles (160,000 km).
- 5) Turbo models with EGR: Adjust at 10,000 miles (16,000 km) - no cost to owner.

pg. 8:3 Servicing (cont.)

Maintenance Operation thousand miles (thousand km)	10 (16)	20 (32)	30 (48)	40 (64)	50 (80)	60 (96)
<b>MISCELLANEOUS MAINTENANCE</b>						
<b>ENGINE</b>						
Fuel (Line) Filter						R
PCV Nipple (Orifice)/hoses,clean						I
EGR valve, clean						
Battery	I	I	I	I	I	I
<b>BRAKES</b>						
Inspect Brakes, Replace components as necessary	I	I	I	I	I	I
Change brake fluid			R			R
<b>STEERING</b>						
Rotate tires/check tire wear; (Align if needed.)	I	I	I	I	I	I
Check power steering fluid level.	I	I	I	I	I	I
<b>BODY</b>						
Power antenna (clean)	I	I	I	I	I	I
Trunk, Hood Hinges and Latches	I	I	I	I	I	I

- 1) for services beyond the 60,000 miles (96,000 km), consult your Maintenance Records manual".

- 2) B 230 FD only: clean at 100,000 miles (160,000 km).
- 3) 30,000 miles (48,000 km) or every two years
- 4) B230 FD only: Recommended but not required to maintain Volvo Emission Warranty.

---

The following items should be checked weekly by the driver (it takes only a few minutes):

- Engine oil level
- Brake fluid level
- Radiator coolant level
- Tire pressure (all five tires)
- Operation of all lights
- Horns
- Windshield wipers
- Level of windshield washer fluid

The following should also be carried out at regular intervals:

- Washing
- Polishing
- Cleaning
- Rust protection

pg. 8:4 Maintenance service, Warranty

Maintenance service at 10,000 \* mile (16,000 km) intervals

Volvo advises you to follow the service program at 10,000 mile (16,000 km) intervals which is outlined in the "Maintenance Records Manual". This maintenance program contains inspections and services necessary for the proper function of your car over the next 10,000 miles (16,000 km).

The maintenance services contain several checks which require special instruments and tools and therefore must be performed by a qualified technician.

To keep your Volvo in top condition, specify time tested and proven Genuine Volvo Parts and Accessories.

\* Turbo models: 5,000 miles (8,000 km)

The Federal Clean Air Act - U.S.

The Clean Air Act requires vehicle manufacturers to furnish written instructions to the ultimate purchaser to assure the proper functioning of those components that control emissions.

The maintenance instructions listed in the "Servicing" section of this Manual represent the minimum

maintenance required. These services are not covered by the warranty. You will be required to pay for labor and material used. Refer to your Warranty booklet for further details.

## Maintenance services

Your Volvo has passed several major inspections before being delivered to you, according to Volvo specifications. The maintenance services outlined in this book should be performed as indicated. The extended maintenance service intervals make it even more advisable to follow this program. Inspection and service should also be performed any time a malfunction is observed or suspected. It is recommended that receipts for vehicle emission services be retained in the event that questions arise concerning maintenance. See your "Maintenance Records Manual".

## Applicable warranties - U.S.

In accordance with U.S. Federal Regulations, the following list of applicable U.S. warranties is provided. For Canadian specification vehicles, see your separate warranty booklet.

- New Car Limited Warranty
- Parts and Accessories Limited Warranty
- Corrosion Protection Limited Warranty
- Seatbelt and Supplemental Restraint Systems Limited Warranty
- Emission Design and Defect Warranty
- Emission Performance Warranty

These are the Federal warranties; other warranties are provided as required by state law.

Refer to your separate Warranty booklet for detailed information concerning each of the warranties.

pg. 8:5 Engine oil

## Checking the oil level

The oil level should be checked every time the car is refueled. Be sure the oil level is maintained between the upper and lower marks on the dip-stick. Low oil level can cause internal damage to the engine and over-filling can result in high oil consumption. The distance between the dipstick marks represents approx. 1 US qt (1 liter) of oil.

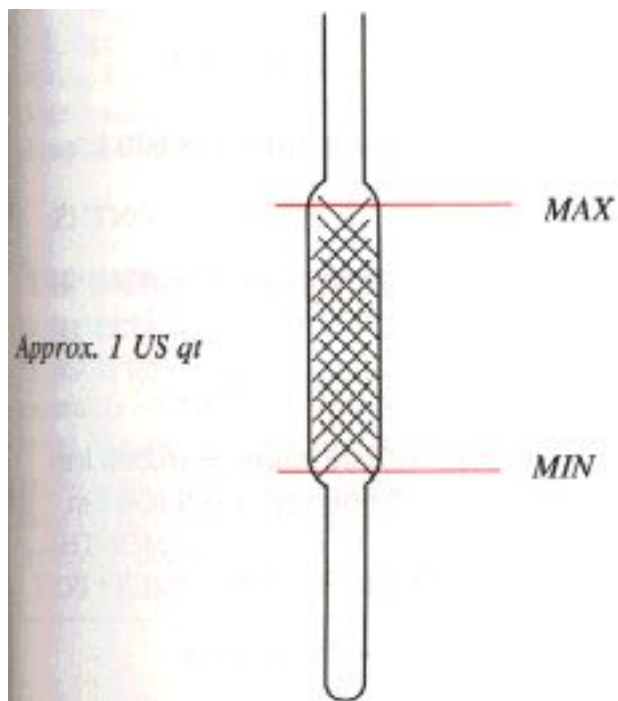

## Draining the oil

Drain the oil after driving while it is still hot.

**Warning!**  
The oil may be very hot.

## To add or change engine oil

Add oil of the same kind as already used. Capacity: 4.0 us qts = 3.85 liters incl. filter\*

After an oil change, the oil level will lie between the two marks on the dipstick i.e. between MAX and MIN. This is normal. Do not add too much oil or excessive oil consumption will result.

\* if oil cooler (Turbo models) is drained, add 0.7 US qts (0.6 liters).

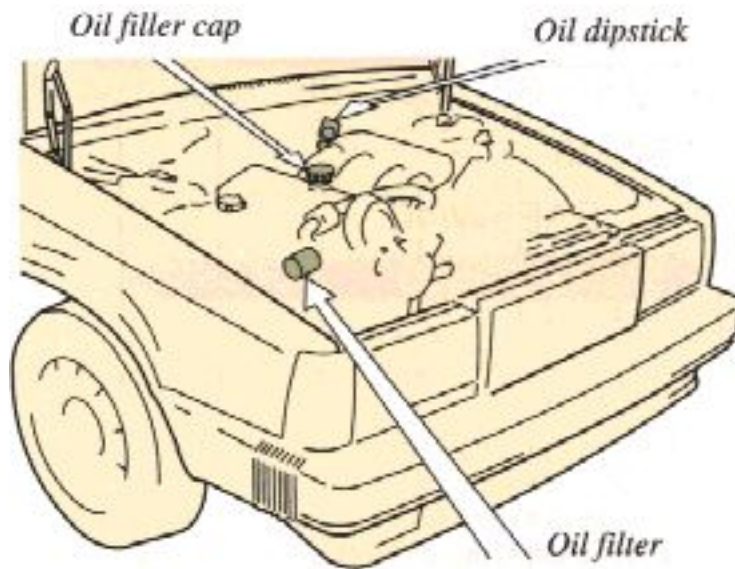

**Warning!**  
Oil spilled on a hot exhaust pipe constitutes a fire risk.

## Changing oil filter

Replace the oil filter at every oil change.

If you change the engine oil and filter yourself, your Volvo dealer can assist you in disposing of the used oil. Engine oil can be harmful to your skin - gloves should be worn when performing this work.

pg. 8:6 Engine oil (cont.)

## Oil quality

### Meeting API specification SG

for best fuel economy and engine protection consult with your authorized Volvo dealer for recommended oils. Oil with designation SG/CD complies with this requirement. Oil with a different quality rating may not provide adequate engine protection.

Viscosity (stable ambient temperatures):



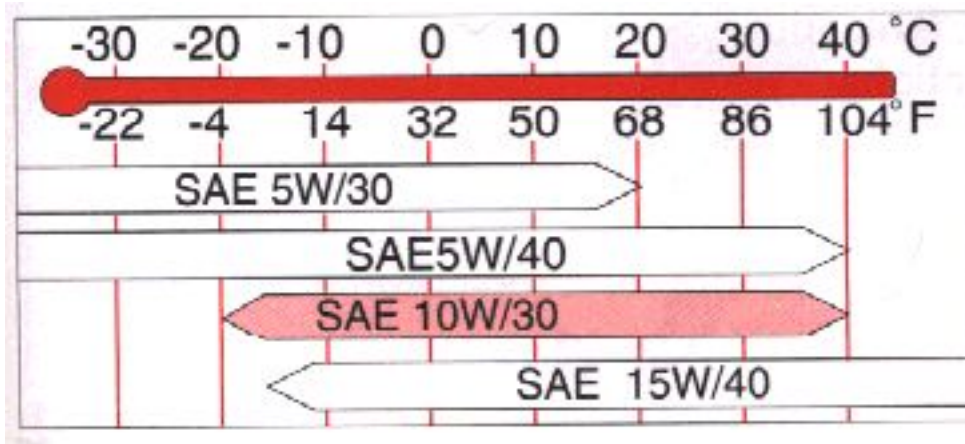

Do not use oils with other viscosity ratings. The use of incorrect viscosity oil can shorten engine life. Volvo recommends the use of energy-conserving oils. Look for the API label. Synthetic oils complying with oil quality requirements are recommended for: driving in areas of sustained temperature extremes (hot or cold), when towing a trailer over long distances or for a prolonged driving in mountainous areas. Volvo does not recommend additional oil additives, as they can adversely affect the engine. SAE 15W/40 is recommended for use in driving conditions that raise oil temperature and increase oil consumption (i.e., mountain driving; trailer towing).  
NOTE: SAE 15W/40 must not be used at low ambient temperatures; see viscosity chart.

### Changing oil and oil filter

Oil and oil filter changes should be made as specified in the following table:

If driving conditions include:	Then the correct oil/oil filter change interval is:
<ul style="list-style-type: none"> <li>● Extended periods of idling and/or low-speed operation</li> <li>● Frequent short trips (less than 7 miles = 11 km)</li> <li>● Extended periods of driving in dusty and/or sandy areas</li> <li>● Trailer towing</li> <li>● Driving in mountainous areas</li> </ul>	EVERY 5,000 miles= 8,000 km OR EVERY 6 MONTHS, WHICHEVER COMES FIRST
<ul style="list-style-type: none"> <li>● Primarily highway driving</li> <li>● Frequent trips of longer than 7 miles = 11 km</li> <li>● Normal driving</li> </ul>	EVERY 10,000 miles = 16,000 km; 5,000 =8,000 KM* OR EVERY 12 MONTHS WHICH EVER COMES FIRST

\* Turbo models



American Petroleum Institute (API) labels. These labels certify the oil conforms to the applicable standards and specifications of the API.

---



[Contents](#) | [Top of Page](#)

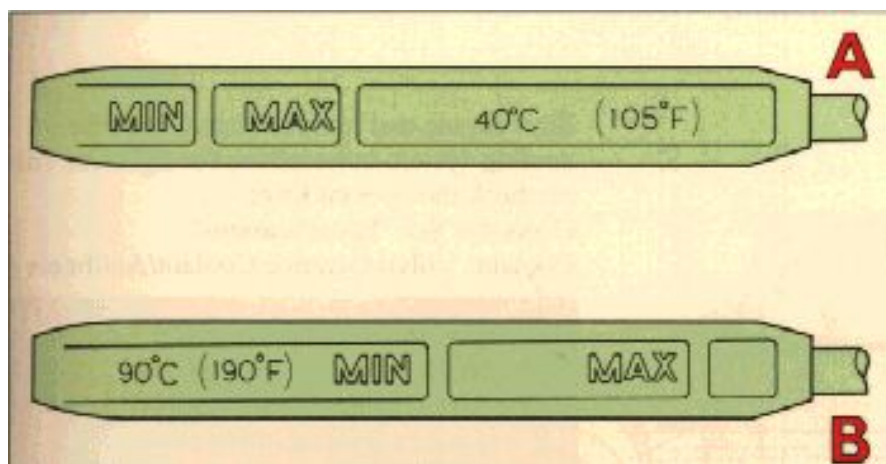

### Automatic transmission oil

Capacity: See "Specifications" section

Fluid type: Automatic Transmission Fluid type Dexron IID or IIE.

Replace: Every 20,000 miles (32,000 km).

**Warning!**  
Oil spilled on a hot exhaust pipe constitutes a fire risk.

**A Cold transmission:** oil temperature + 105°F (+40°C).

This is a normal temperature for the transmission after idling for about 10 minutes.

At oil temperature below + 105°F (+40°C), the level may be below the MIN mark.

**B Warm transmission:** oil temperature + 190°F (+90°C).

This temperature is reached after driving for about 30 minutes.

At oil temperature above +190°F (+90°C), THE LEVEL MAY BE ABOVE THE max MARK.

**NOTE:**  
The engine should be idling when checking transmission fluid level.

Check the oil level as follows:

Park the car on level surface with the engine idling.

Slowly move the selector lever through all gear positions and then to position P. Wait 2 minutes before checking the oil level. As the illustration shows, the dipstick has a "Cold" and a "Warm" side. The oil level

should be between the MIN and MAX marks. Wipe the dipstick with a clean cloth.

**Warning! The oil may be very hot**

Do not use rags that could leave lint on the dipstick.

The transmission is topped up via the dipstick tube.

The space between the MIN and MAX marks on the dipstick corresponds to 0.5 US qt (0.5 liter). Do not fill the transmission with too much oil, since this can result in oil being ejected from the transmission.

Too little oil, on the other hand, can negatively affect transmission operation, particularly in very cold weather.

pg. 8:14 Cooling system

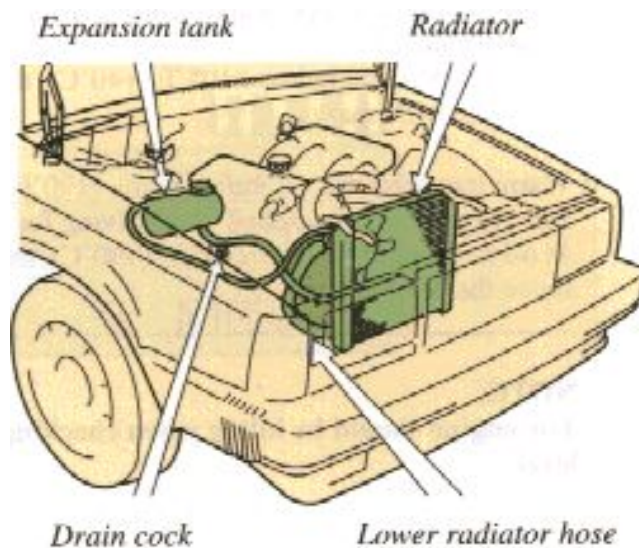

*If you change the coolant yourself, your Volvo dealer can also assist you in disposing of the used coolant.*

### Check coolant level

The cooling system must be filled with coolant and not leak to operate at maximum efficiency. Check the coolant level regularly. The level should be between the "Max" and "Min" marks on the expansion tank. The check should be made with particular thoroughness when the engine is new or when the cooling system has been drained.

Do not remove the filler cap other than for topping-up with coolant. Frequent removal may prevent coolant circulations between the engine tank during engine warm-up and cooling.

### Changing coolant

Normally, the coolant does not need to be changed. If the system must be drained, use the following procedure:

Remove the expansion tank cap. Open the drain cock on the right side of the engine block and disconnect the lower radiator hose.

Fill coolant through the expansion tank. The heater controls should be fully open when draining and filling. Add coolant until the level is up to the MAX mark or slightly above.

Start the engine and run until hot. Check the cooling system connections for tightness. Also re-check the coolant level.

Capacity: See "Specifications"

Coolant: Volvo Genuine Coolant/Antifreeze only

**CAUTION!**

The cooling system must always be kept filled to correct level. If it is not kept filled, there can be high local temperatures in the engine which could result in damage. Different types of anti-freeze/coolant may not be mixed.

**WARNING:** If the engine is warm and you are going to top up coolant, unscrew the cap slowly in order to allow any excess pressure to escape.

**NOTE:** Do not top up with water only. Water by itself reduces the rust-protective and anti-freeze qualities of the coolant and has a lower boiling point. It can also cause damage to the cooling system if it should freeze.

pg. 8:15 Lubrication

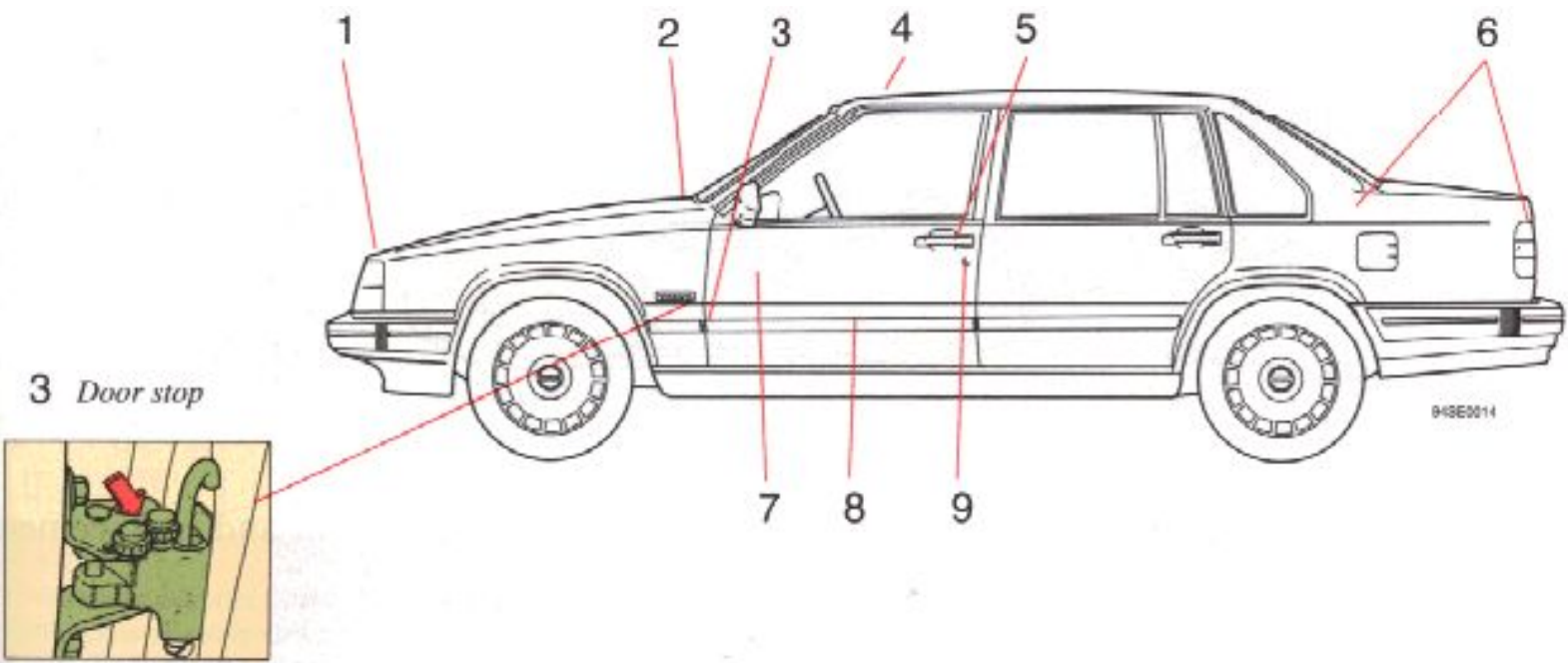

No. Lubricating hint Lubricant  
1 Hood lock and latch Oil

- 2 Hood hinges Oil
- 3 Door stop and hinges Oil
- 4 Sun roof wind deflector Oil
- 5 Door lock catch plate Oil
- 6 Trunk lid lock Low temperature keyhole and hinges grease
- 7 Window regulator Oil, grease locking device silicone (on inside of door) grease
- 8 Front seat slide rail and latch Oil
- 9 Door lock keyhole Low temperature grease

To avoid rattles and unnecessary wear, the body should be lubricated a few times per year.

pg. 8:16 Drive belts

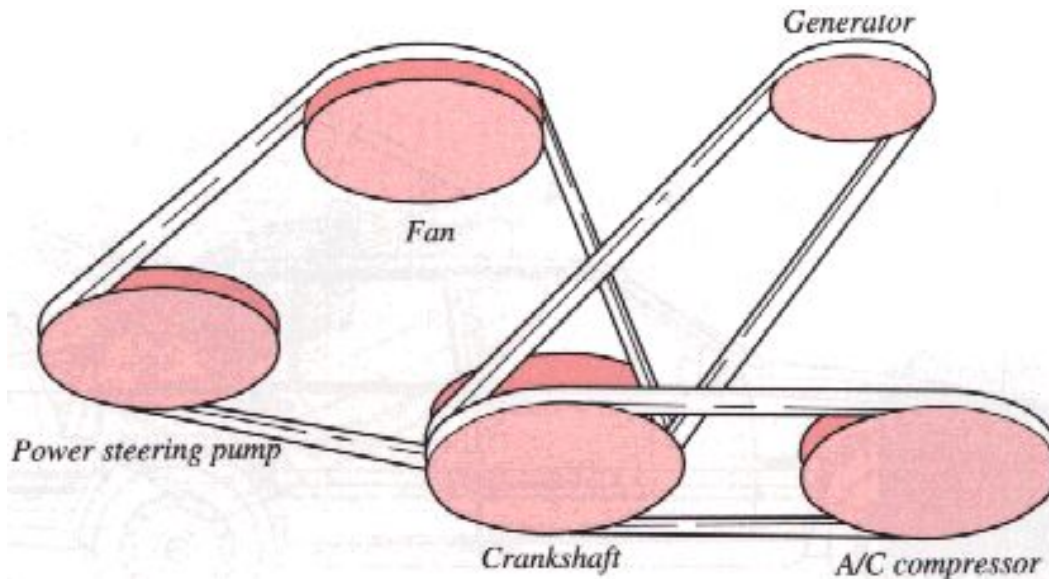

### Checking the belt tension

The belt tension can be checked by depressing the fan belt (engine not running!) at a point midway between the generator and fan. It should be possible to press down the belt about 1/4" - 3/8" (5-10 mm). This also applies to other drive belts on the engine.

**WARNING! The engine must not be running when this check is performed.**

### Belt check



Check the belt regularly to make sure it is in good condition and is clean. Worn or dirty belts can cause poor cooling and low generator output as well as impair the operation of the power steering and the air conditioning unit.

### Belt adjustment and replacement

The belts can be difficult to reach and it is advisable to let your Volvo dealer adjust the tension of the belts or replace them, if necessary.

pg. 8:17 Engine compartment

940 B 230 F

- 1 Data plate
- 2 Expansion tank, coolant
- 3 Oil filler cap, engine
- 4 Oil dipstick, engine
- 5 Oil dipstick, automatic transmission
- 6 Brake fluid reservoir
- 7 Oil reservoir, power steering
- 8 Washer fluid reservoir
- 9 Battery
- 10 Engine identification label

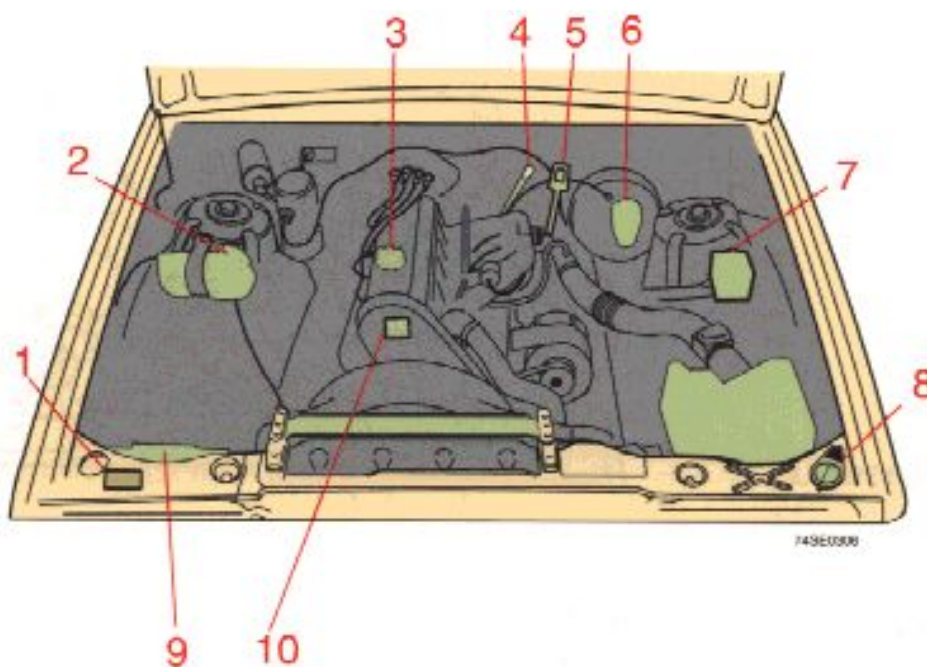

**WARNING!**

The cooling fan may start or continue to operate (for up to 6 minutes) after the engine has been switched off.

pg. 8:18 Engine compartment

940 Turbo  
(B 230 F- Turbo engine)

- 1 Washer fluid reservoir
- 2 Expansion tank, coolant
- 3 Oil filler cap, engine
- 4 Oil dipstick, engine
- 5 Oil dipstick, automatic transmission
- 6 Brake fluid reservoir
- 7 Oil reservoir, power steering
- 8 Battery
- 9 Data plate
- 10 Engine identification label

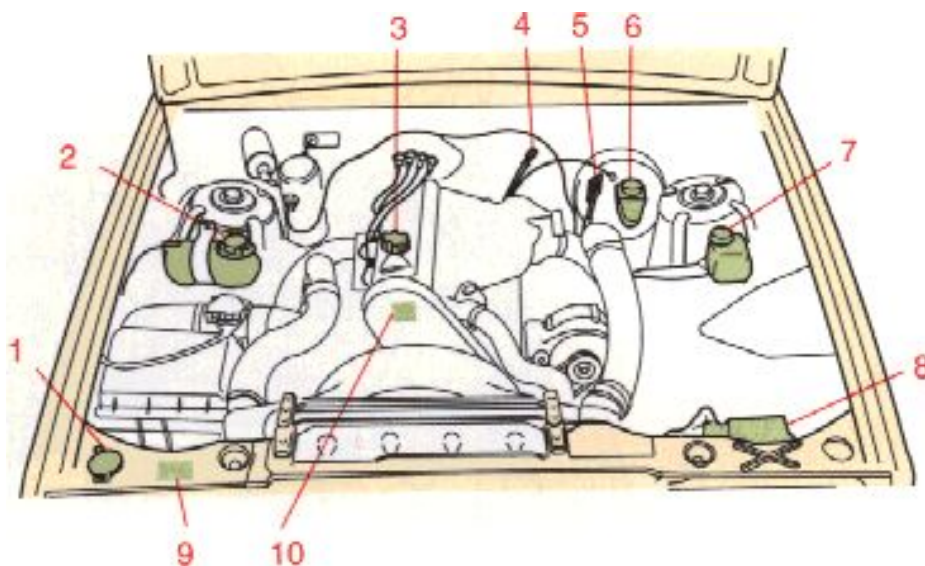

**WARNING!**

The cooling fan may start or continue to operate (for up to 6 minutes) after the engine has been switched off.



[Contents](#) | [Top of Page](#)

## Valves

The valve clearance should be check and, if necessary, adjusted every 30,000 miles (48,000 km).

## Air cleaner

Replace the air cleaner cartridge with a new one every 30,000 miles (48,000 km). The cartridge should be replaced more often when driving under dirty and dusty conditions, The filter cannot be cleaned and, therefore, should always be replaced with a new one.

## Vacuum fittings, hoses and connections

Unstable idle, misfiring, or poor emission control is often caused by leaking vacuum hoses or connections. Check hoses and connections on distributor vacuum unit, connections on heater control servo systems and hydraulic brake servo.

## Checking and adjusting idle air control system

Your Volvo is equipped with an electronically-controlled idle air control system that requires no checking or adjustment.

## Fuel system cap, tank and lines, and connections

The effectiveness of the fuel system to contain hydrocarbons is dependent largely on a leakfree system. Check for proper sealing of gasoline filler cap which contains "O" ring-type seals. Check all evaporative hoses in vehicle for tightness. Check fuel lines under vehicle and repair if necessary.

## Fuel (line) filter

The fuel line filter is located next to the fuel pump. This filter should be replaced every 100,000 miles (160,000 km). The filter is replaced as one complete unit.

Replace more frequently if contaminated fuel is introduced into the tank (or if there is reason to suspect that this has occurred).

B 230 FD only: Replacement is recommended but not required to maintain VOlvo Emission Warranty.

## Timing belt

### B 230 F/FT

Replace the timing belt every 50,000 miles (80,000 km).

B230 FD only:

Replace timing belt every 100,000 miles (160,000 km)

pg. 8:8 Servicing (cont.)

*1 Battery*

*2 Injection control module*

*3 Ignition control module*

*4 Fuel filter*

*5 Fuel pump*

*6 Fuel feed pump*

*7 Mass air flow sensor \**

*8 Throttle position switch*

*9 Temperature sensor*

*10 Injector*

*11 Heated oxygen sensor*

*12 Charge air cooler (Turbo models)*

\* Pressure meter on certain models

## Fuel system

The fuel injection system is all-electronic and microprocessor-controlled. It can continually compensate for variations in engine load, speed and temperature to give the best economy and power. A mass air flow sensor or a pressure meter on certain models, measures the inducted air. In this way the system can make instantaneous adjustments for changes in air temperature or density, thus always assuring the best economy with the lowest possible exhaust emissions.

## Heated oxygen sensor

This is an emission control system designed to reduce emissions and improve fuel economy. The heated oxygen sensor monitors the composition of the exhaust gases leaving the engine. The exhaust gas analysis is fed into an electronic control module. This adjusts the air-fuel ratio to provide optimum conditions for combustion and efficient reduction of the three major pollutants (hydrocarbons, carbon monoxide and nitrous gases) by a three-way catalytic converter.

## Pulsed Secondary Air Injection (certain models)

This system adds air to the hot exhaust gases as they are expelled from the engine. This causes a secondary combustion of residual hydrocarbons and carbon monoxide, resulting in lower emissions levels in the exhaust gases.

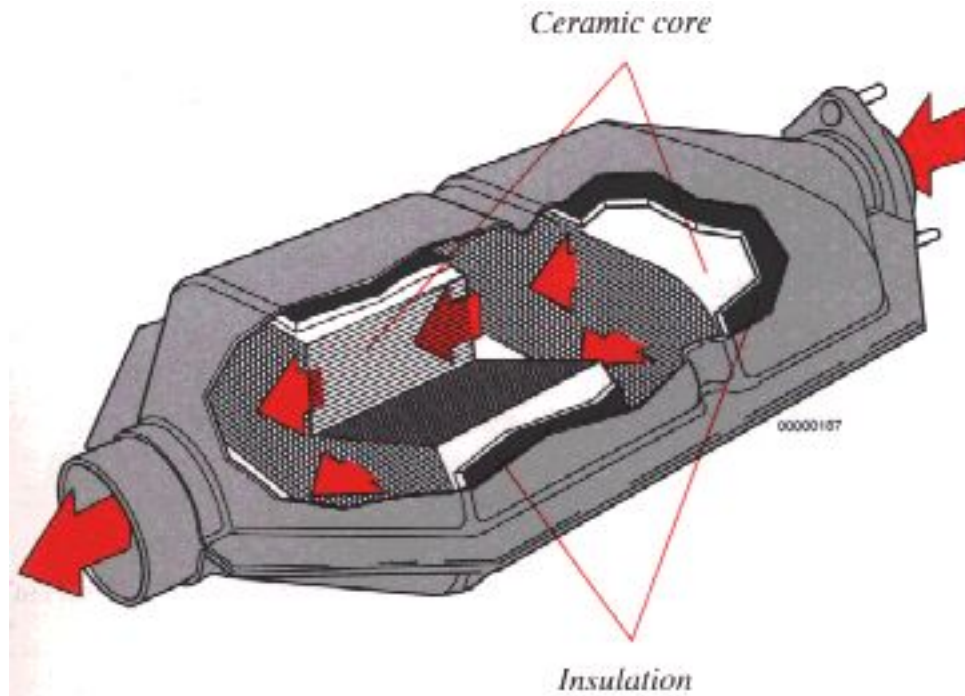

### Three-way Catalytic Converter

This is a supplementary device in the exhaust system, designed to clean exhaust gases. This device is mainly a container with a ceramic material insert, designed to let the exhaust gases pass through channels in the insert. The channel walls are covered by a thin layer of platinum-palladium. These metals act as catalysts, permitting a chemical action to occur without actually taking part in it. The emission (CO, HC, NO<sub>x</sub>) content will increase if the three-way catalytic converter is damaged. Vehicles equipped with heated oxygen sensors use three-way catalytic converters containing platinum and rhodium.

#### CAUTION:

Vehicles with a three-way catalytic converter must use unleaded fuel only. Otherwise the three-way catalytic converter will become ineffective. See "Fuel requirements".

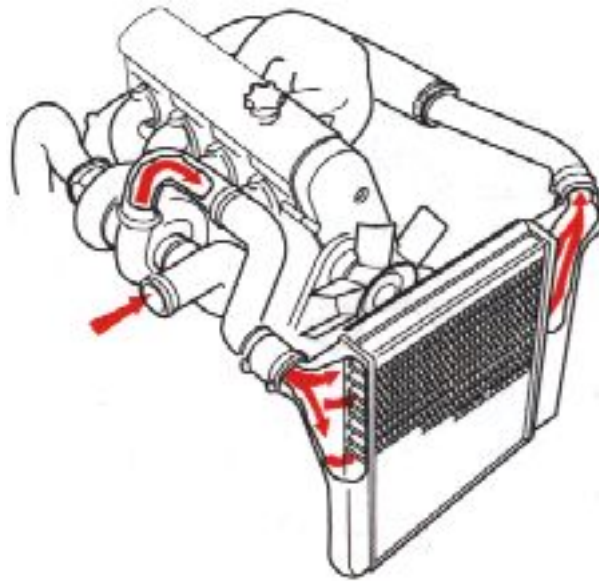

### Charge air cooler (Intercooler)

The B230F-Turbo engine employs a turbocharger to force air into the engine inlet manifold and a charge air cooler to cool the compressed inlet air. The resulting increase in air flow raises pressure in the intake manifold by approx. 8 psi (over atmospheric pressure) and engine power output by approx. 46 horsepower over that developed by the normally-aspirated engine.

The charge air cooler (which resembles a radiator) is located between the turbocharger and inlet manifold.

pg. 8:10 Servicing (cont.)

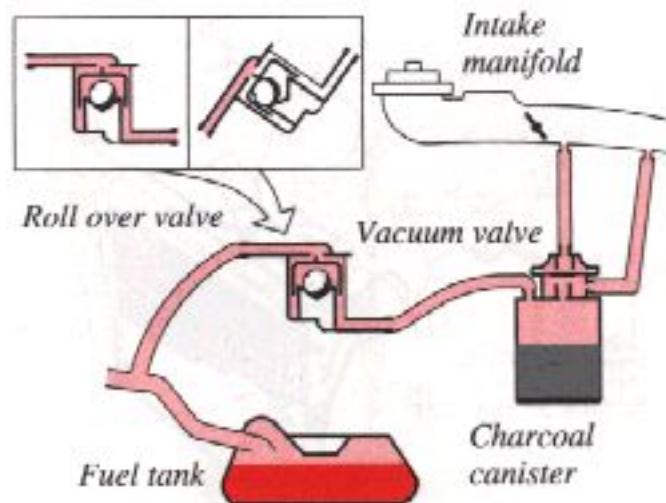

### Evaporative control system

The 940 is equipped with a gas-evaporative control system, which prevents gasoline fumes from being released into the atmosphere. The system is comprised of an expansion chamber in the fuel tank, and a



charcoal canister with built-in vacuum valve under the left-front wheel housing. The components are interconnected by hoses which channel fuel vapor from the gas tank to the charcoal filter, where it is stored until the engine is started and then drawn into the engine's fuel-induction system.

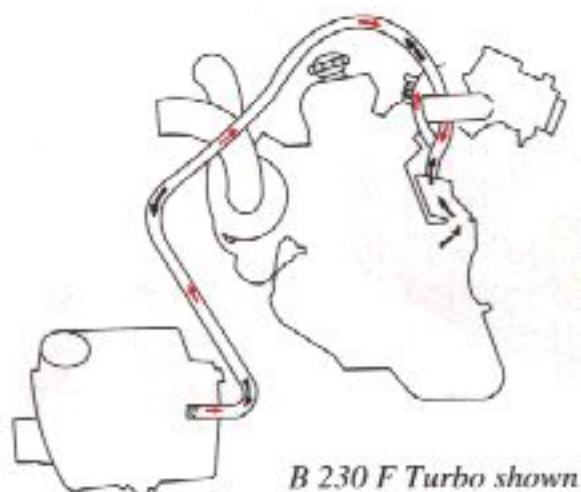

### Crankcase ventilation

The engine is equipped with positive crankcase ventilation which prevents crankcase gases from being released into the atmosphere. Instead, the crankcase gases are admitted to the intake manifold and cylinders.

### PCV system

The PCV nipple in the intake manifold should be removed and inspected every 60,000 miles (96,000 km).

Check/replace hoses at the same time.

### Exhaust Gas Recirculation (EGR)

This system operates by returning some of the exhaust gases to the engine to be recombusted: since this lowers the combustion temperature the amount of nitrogen oxides released into the atmosphere is reduced.

The EGR valve should be cleaned at 100,000 miles (160,000 km) and thereafter cleaned every 20,000 miles (32,000 km).

\* B 230 FD only: clean at 100,000 miles (160,000 km).

**WARNING!**

The distributor ignition system operates at very high voltages. Special safety precautions must be followed to prevent injury.

Always turn the ignition off when:

- connecting engine test and diagnostic equipment to the vehicle (timing light, tach-dwell tester, ignition oscilloscope, etc..).
- Replacing distributor ignition components e.g. plugs, coil, distributor, HT leads etc.
- Do not touch any part of the distributor ignition system while the engine is running. This may result in unintended movements and body injury.

## Replacing spark plugs

The spark plugs should be changed every 30,000 miles (48,000 km). However, city driving or fast highway driving may necessitate changing after 15,000 miles (24,000 km) of driving. When installing new plugs, be sure to fit the right type and use correct torque, see Specifications. When changing the plugs, check that the suppressor connectors are in good condition. Cracked or damaged connectors should be replaced. When changing the spark plugs, clean the terminals and the rubber seals.

**CAUTION:** Do not use silicone-based lubricants, which can have adverse effects on electrical components.

## Battery:

- Make sure the battery leads are properly connected and tightened.
- Never disconnect the battery when the engine is running.
- The battery leads must be disconnected when recharging the battery.
- Turn radio off before disconnecting the battery. If the radio has an anti-theft code and the battery has been disconnected, the code must be re-entered before the radio will function properly.

Batteries contain corrosive and toxic acids. It is of the utmost importance that old batteries are disposed of correctly. Your Volvo dealer can assist you in this matter.

pg. 8:12 Brake fluid, Power steering fluid

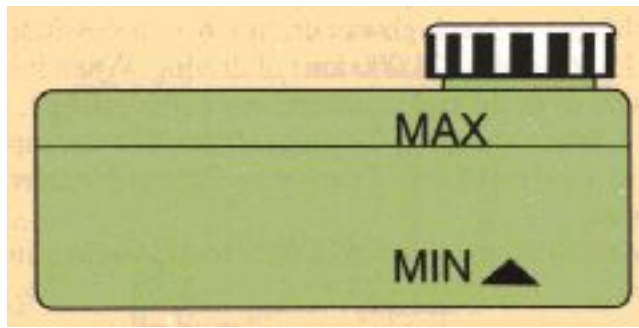

## Brake fluid

The fluid level should be above the min mark.

Fluid type: DOT 4+

Replace\*: every second year or 30,000 miles (48,000 km). The brake fluid should be replaced once a year or every 15,000 miles (25,000 km) when driving under extremely hard conditions (mountain driving etc.)

Check, without removing the cap, that the level is above the "MIN" mark of the fluid reservoir. Always entrust brake fluid changing to an authorized Volvo dealer.

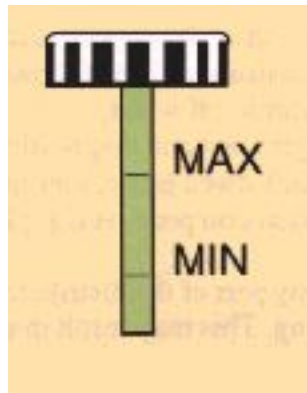

## Power steering fluid

The fluid level should lie between the MIN and MAX marks on the dipstick (cool engine).

Check fluid level with engine idling and after driving while the fluid still is hot. Wipe the reservoir clean.

Fluid type: ATF

Replace: No fluid change required.



[Contents](#) | [Top of Page](#)

## Specifications

pg. 9:1 Specifications

### Specifications

[9:2](#) Dimensions and weights

[9:3](#) Label information

[9:4](#) Oil specifications

[9:5](#) Engine specifications

[9:8](#) Electrical system specifications/  
bulbs

[9:9](#) Capacities

pg. 9:2 Specifications

### Dimensions and weights

940

940 Turbo

Length (sedan) 191.7 " (487 cm)

Length (wagon) 190.5 " (484 cm)

Width 68.9 " (175 cm)

Height 56.5 " (143 cm)

Wheelbase 109 " (277 cm)

Track:

front 57.5" (146 cm)

rear 57.5 " (146 cm)

Turning circle, between curbs 32.5 ft. (9.9 m)

Trunk capacity (sedans) 16.8 cu. ft (0.487 m)

Cargo capacity (wagons)

39.3 cu. ft. (1.1 m)

With rear seat down 74.9 cu. ft. (2.1 m)

### **WARNING!**

**When adding accessories, equipment, luggage and other cargo to your vehicle, the total weight capacity of the vehicle must not be exceeded.**

Consult your Volvo dealer for information.

All specifications are subject to change without notice.

### Gross Vehicle Weight (GVW): USA Canada

940 (sedan) 4150 lbs (1882 kg) 1880 kg  
940 (wagon) 4320 lbs (1961 kg) 1960 kg  
940 Turbo (sedan) 4190 lbs (1902 kg) 1900 kg  
940 Turbo (wagon) 4380 lbs (1988 kg) 1985 kg

### Capacity weight

940 (sedan) 930 lbs (422 kg) 420 kg  
940 (wagon) 1030 lbs (467 kg) 470 kg  
940 Turbo (sedan) 925 lbs (420 kg) 415 kg  
940 Turbo (wagon) 1040 lbs (482 kg) 470 kg

### Permissible axle weight, front:

940 (sedan) 2040 lbs (925 kg) 925 kg  
940 (wagon) 2040 lbs (925 kg) 925 kg  
940 Turbo (sedan) 2075 lbs (941 kg) 945 kg  
940 Turbo (wagon) 2070 lbs (939 kg) 940 kg

### Permissible axle weight, rear

940 (sedan) 2180 lbs (989 kg) 990 kg  
940 (wagon) 2380 lbs (1080 kg) 1080 kg  
940 Turbo (sedan) 2170 lbs (984 kg) 985 kg  
940 Turbo (wagon) 2380 lbs (1080 kg) 1080 kg

Curb weight (sedan) 3163-3229 lbs 1435-  
(1436-1466 kg) 1473 kg

Curb weight (wagon) 3237-3308 lbs 1470-  
(1470-1502 kg) 1506 kg

Max. roof load\* 220 lbs (100 kg) 100 kg  
Max. trailer weight (w/o brakes) 1540 lbs (700 kg) 700 kg



Max. trailer weight

(with brakes - 2" ball) 3300 lbs (1500 kg) 1500 kg

Max. trailer weight

(with brakes - 1 7/8" ball) 2000 lbs (900 kg) 900 kg

Max. tongue weight 165 lbs (75 kg) 75 kg

The max permissible axle loads must not be exceeded

pg. 9:3 Label information

### 1 Vehicle Identification Number (VIN) \*

VIN plate is located on top left surface of dashboard. The VIN is also stamped on the right hand door pillar.

### 2 Vehicle Emission Control Information

Your Volvo is designed to meet all applicable emissions standards, as evidenced by the certification label on the left wheelhousing. for further information regarding these regulations, please consult your Volvo dealer.

### 3 Model Plate

Vehicle Identification Number (VIN). Codes for color and upholstery etc. This plate is located on panel above right headlight.

### 4 Loads and Tire Pressures

### 5 Federal Motor Vehicle Safety Standards (FMVSS) specifications (USA) and Ministry of Transport (CMVSS) Standards (Canada)

Your Volvo is designed to meet all applicable safety standards, as evidenced by the certification label on the rear facing side of the driver's door. for further information regarding these regulations, please consult your Volvo dealer.

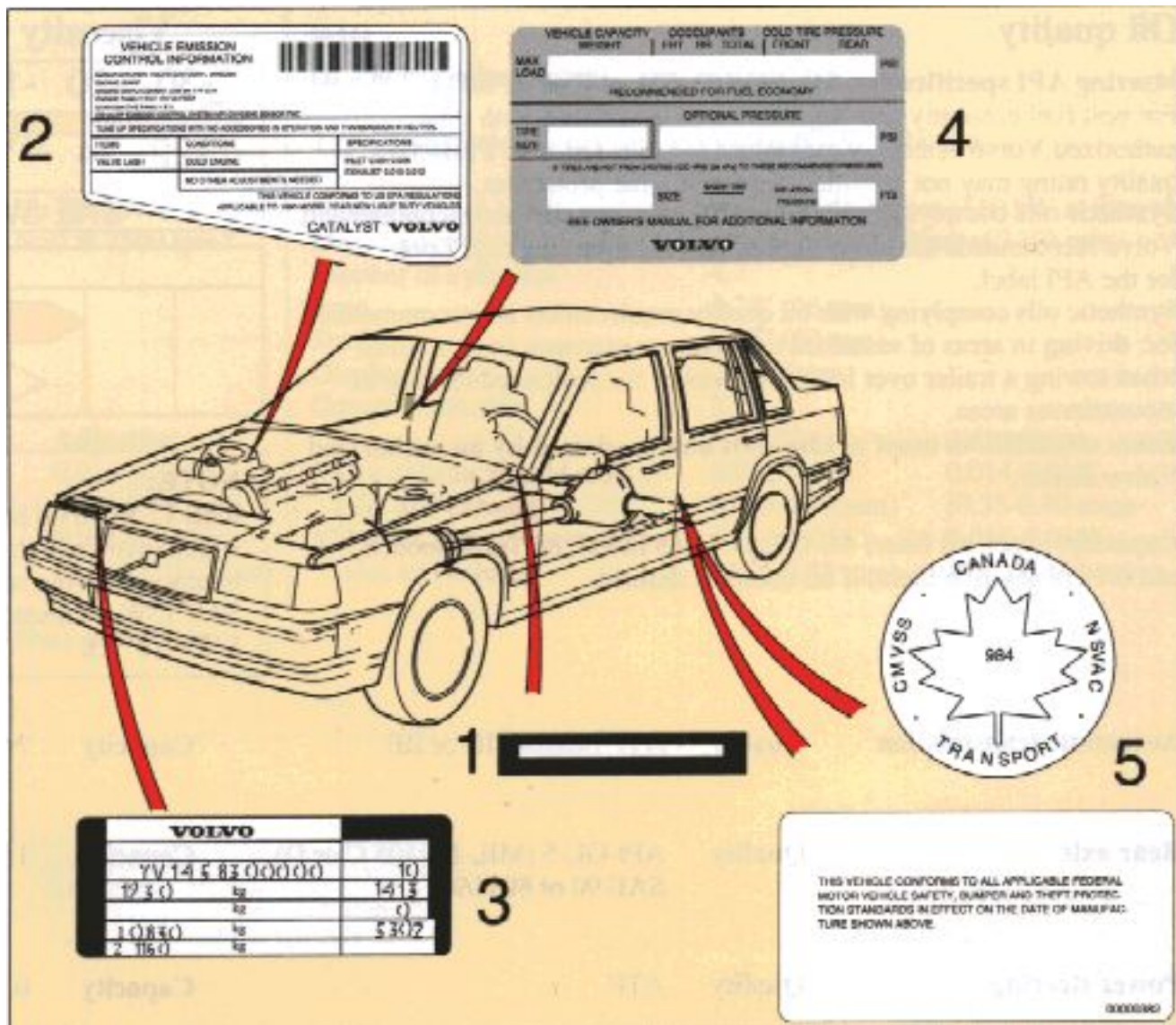

\* The Vehicle Identification Number (VIN) should always be quoted in all correspondence concerning your vehicle with the dealer and when ordering parts.

All specifications are subject to change without notice.

pg. 9:4 Specifications

Oil quality

Meeting API specification SG

for best fuel economy and engine protection, consult with your authorized Volvo retailer for recommended oils. Oil with designation SG/CD complies with this requirement. Oil with a different quality rating may not provide adequate engine protection.

Synthetic oils complying with oil quality requirements are recommended Volvo recommends the use of

fuel economy improving oils. Look for the API label.

Synthetic oils complying with oil quality requirements are recommended for : driving in areas of sustained temperature extremes (hot or cold), when towing a trailer over long distances or for prolonged driving in mountainous areas.

Volvo does not recommend oil additives as they can adversely affect the engine.

Capacity (including oil filter): 4.0 US qts. (3.85 liters); on Turbo models, add 0.7 US qts (0.6 liters) if oil cooler is drained.

Automatic transmission fluid	Quality : ATF Dexron IIDE/IIIE	Capacity : 7.9 US qts. (7.5 liters)
Rear axle	Quality : API-GL-5 (MIL-L-2105 C or D) SAE 90 or 80W/90	Capacity : 1.7 US qts (1.6 liters) sedans/wagons
Power steering	Quality : ATF	Capacity : 0.7 US qts. (0.7 liters)
Brake fluid	Brake fluid type : DOT 4+	Capacity : 0.66 US qts. (0.5 liters)

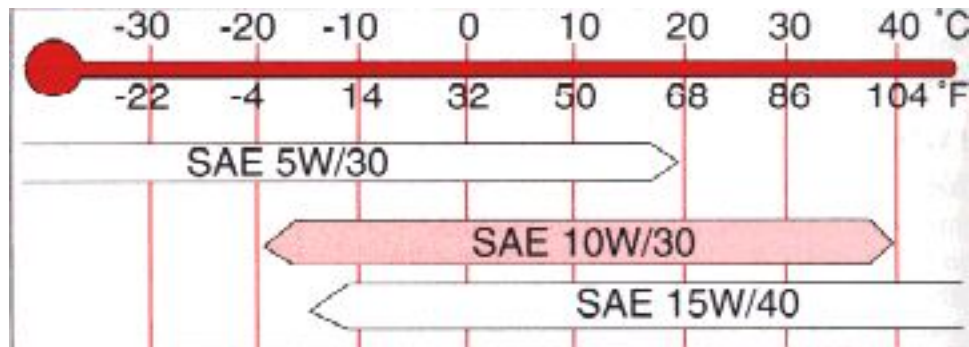

**NOTE :**

SAE 15 W/40 oil is recommended for use in severe driving conditions which involve high oil temperatures or excessive oil consumption e.g. mountain driving with frequent deceleration, or high-speed driving. SAE 15W-40 must not be used at ambient temperatures below 5°F (-15°C).

pg. 9:5 Specifications

940

(B 230F engine)

Type designation Volvo B 230F

Output (SAE J 1349) 114 hp at 5400 rpm (85 kW at 90 rps)

Max. torque (SAE J 1349) 134 ft. lbs. (183 Nm) at 2500 rpm

Number of cylinders 4

Bore 3.78" (96 mm)

Stroke 3.15" (80 mm)

Displacement 2.32 Liters

Compression ratio 9.8:1

Checking Adjusting

Valve clearance, cold engine 0.012-0.016" 0.014-0.016"  
inlet and exhaust (0.30-0.40 mm) (0.35-0.40 mm)

Valve clearance, warm engine 0.014-0.018" 0.016-0.018"  
inlet and exhaust (0.35-0.45 mm) (0.040-0.045 mm)

\* California: 135 ft. lbs. (183 Nm) at 2500 rpm

940

(B 230F-Turbo engine)

Type designation Volvo B 230 F-Turbo

Output (SAE J 1349) 162 hp at 4800 rpm (119 kW at 80 rps)

Max. torque (SAE J 1349) 195 ft. lbs. (265 Nm) at 3450 rpm

Number of cylinders 4

Bore 3.78" (96 mm)

Stroke 3.15" (80 mm)

Displacement 2.32 Liters

Compression ratio 8.7:1

Checking Adjusting

Valve clearance, cold engine 0.012-0.016" 0.014-0.016"  
inlet and exhaust (0.30-0.40 mm) (0.35-0.40 mm)

Valve clearance, warm engine 0.014-0.018" 0.016 0.018"  
inlet and exhaust (0.35-0.45 mm) (0.40-0.45 mm)

pg. 9:6 Specifications

Cooling system

Type Positive pressure, closed system

Thermostat: begins to open at

(940/GL) 198° F (92° C)

(Turbo) 189° F (87° C)

Fan belts, designation: (940/GL) HC47cog x 1013

(Turbo) HC47cog x 1000

Coolant: Volvo Genuine Coolant/Anti-freeze

Capacity: 10 US qts (9.5 liters)

Distributor ignition System

Firing order 1-3-4-2

Distributor ignition setting:

(940/GL) 12° B.T.D.C. at 750 rpm

(Turbo) 12° B.T.D.C. at 750 rpm

Spark plugs (940/GL/Turbo) Volvo P/N270746-1

Spark plug gap 0.028-0.032" (076-0.8 mm)

Tightening torque 15-22 ft. lbs. (20-30 Nm)

Distributor, direction of rotation Clockwise

pg. 9:7 Specifications

## POWER TRANSMISSION

Automatic transmission AW71

Reduction ratios:

1st gear 2.45:1

2nd gear 1.45:1

3rd gear 1:1

4th gear 0.69:1

Reverse 2.21:1

Rear axle reduction ratio:

4.10:1 (940)

3.73:1 (940 Turbo)

## Front suspension

McPherson-type spring and strut suspension. Shock absorbers housed in strut casing. Rack-and-pinion steering.

Safety-type steering column.

The alignment specifications apply to an unladen car, but include fuel, coolant, and spare wheel.

Toe-in, measured on the wheel rim: 2.1 mm +/- 0.9 mm

tire sides: 2.3 +/- 1.2 mm



[Contents](#) | [Top of Page](#)



## ELECTRICAL SYSTEM

12 V, negative ground.

Voltage-controlled generator. Single-wire system with chassis and engine used as conductors.

Voltage 12 V

Battery, type Maintenance free

Capacity 520 A/100 min

Electrolyte, specific gravity 1.28

Recharge at 1.24

Generator, rated output 1350 W (940/GL)

1350W (Turbo)

max. current 100 A

The battery contains corrosive and poisonous acids. It is of the utmost importance that old batteries are disposed of correctly. Your Volvo dealer can assist you in this matter.

The following bulbs may be obtained from your nearest Volvo dealer:

Lights, 12 V	US bulb No.	Power	Socket
Headlights	HB1/9004	65/45 W	-
Parking lights, front			
turn signals, front	1157 N.A.	21/5 W/24/2.2 cp	BAY 15 d
turn signals, rear	1156	21W/32cp	BA 15s
Tail lights	2x67	5 W/4cp	BA 15s
Brake light	1156	21 W/32cp	BA 15s
Tail light/brake light *	1157	21/5W/32/3cp	BA 15d
High-mounted brake light	1156	21 W/32cp	BA 15s
Back-up lights	1156	21 W/32cp	BA 15s

Rear fog light	1156	21 W/32cp	BA 15s
License plate light	5 W	W 2.1 x 9.5 dBA 9s	
License plate light *	4 W	BA 9 s	
Door warning lights	3 W	W 2.1x9.5d	
Interior light	10 W	SV8.5	
Reading lights, front	5 W	W 2.1x9.5d	
Trunk light	10 W	SV8.5	
Glove box light	2 W	BA9 s	
Instrument lighting	3 W	W 2.1x9.5d	
Ashtray, rear	1.2 W	Volvo P/N966326	
Warning lights/			
Indicator lights	1.2 W	Volvo P/N966326	

\* Wagons

pg. 9:9 Specifications

## Vehicle Loading

The tires on your Volvo should perform to specifications at all normal loads when inflated as recommended on the tire information label. The label is located on the rear-facing edge of the right-front door. This label lists both tire and vehicle design limits. Do not load your car beyond the load limits indicated.

## Sample Tire Pressure Label

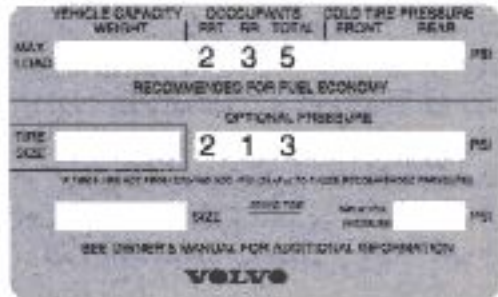

### WARNING!

Improperly inflated tire will reduce tire life, adversely affect vehicle handling and can possibly lead to failure resulting in loss of vehicle control prior warning.

### Capacities

Fuel tank (approx.) 19.8 US gal.

75 liters

Cooling System 10 US qts.

(9.5 liters)

Engine 4.0 US qts. \*

at oil change 3.85 liters

Automatic transmission 7.9 US qts.

7.5 liters

Rear axle 1.7 US qts.

1.6 liters

Power steering gear 0.7 US qts.

0.7 liter

\* Turbo: If oil cooler is drained, add 0.7 US qts (0.6 liter)

All specifications are subject to change without notice.

pg. 9:10 Service manuals

Service Manuals for your Volvo are available for purchase. These are the same manuals used by competent Volvo technicians.

Major sections within the Service Manual System include: 0-General Information; 1- Lubrication and Service; 2- Engine; 3- Electrical System; 4- Power Transmission; 5-Brakes; 6- Suspension and Steering; 7- Springs Shock Absorbers and Wheels; 8- Body and Interior.

A Literature Catalog Request Card was placed in the car prior to delivery from the retailer to you. Complete ordering information is provided

All specifications are subject to change without notice.



Volvo supports Voluntary Mechanic Certification by the A.S.E. Certified mechanics have demonstrated a high degree of competence in specific areas. Besides passing exams each mechanic must also have worked in the field for two or more years before a certificate is issued. These professional mechanics are fully able to analyze vehicle problems and perform the necessary service procedures to keep your Volvo at peak operating condition.

Note that the above pertains to USA only.



Your new Volvo comes with a four year road assistance program named ON-CALL. Additional information, features, and benefits are described in a separate information package in your glove

compartment.

## Essential Information Page

### Inside back cover

#### **WARNING!**

##### Detergents and solvents

Do not use gasoline containing lead or benzene as a detergent or solvent. Both lead and benzene are toxic and may be hazardous to your health.

##### Installation of optional equipment/use of mobile telephones

Incorrectly installed optional equipment, alarm systems or the use of mobile telephones which are not connected to a suitable antenna can cause faults in the car's electronic control systems. Your car is equipped with an accessory connector located under the dashboard on the driver's side. Please consult your Volvo retailer if you have any questions before connecting accessory or optional equipment to the vehicle's electrical systems.

##### Carbon monoxide

Carbon monoxide is a poisonous, colorless and odorless gas which is present in all exhaust gases. If you ever smell exhaust fumes from inside the vehicle, make sure the passenger compartment is ventilated and immediately return the vehicle to your retailer for correction.

Never sit in a parked or stopped car for any extended amount of time, nor have it unattended while the engine is running.

Never operate the engine in confined, unventilated areas.

### Back Cover

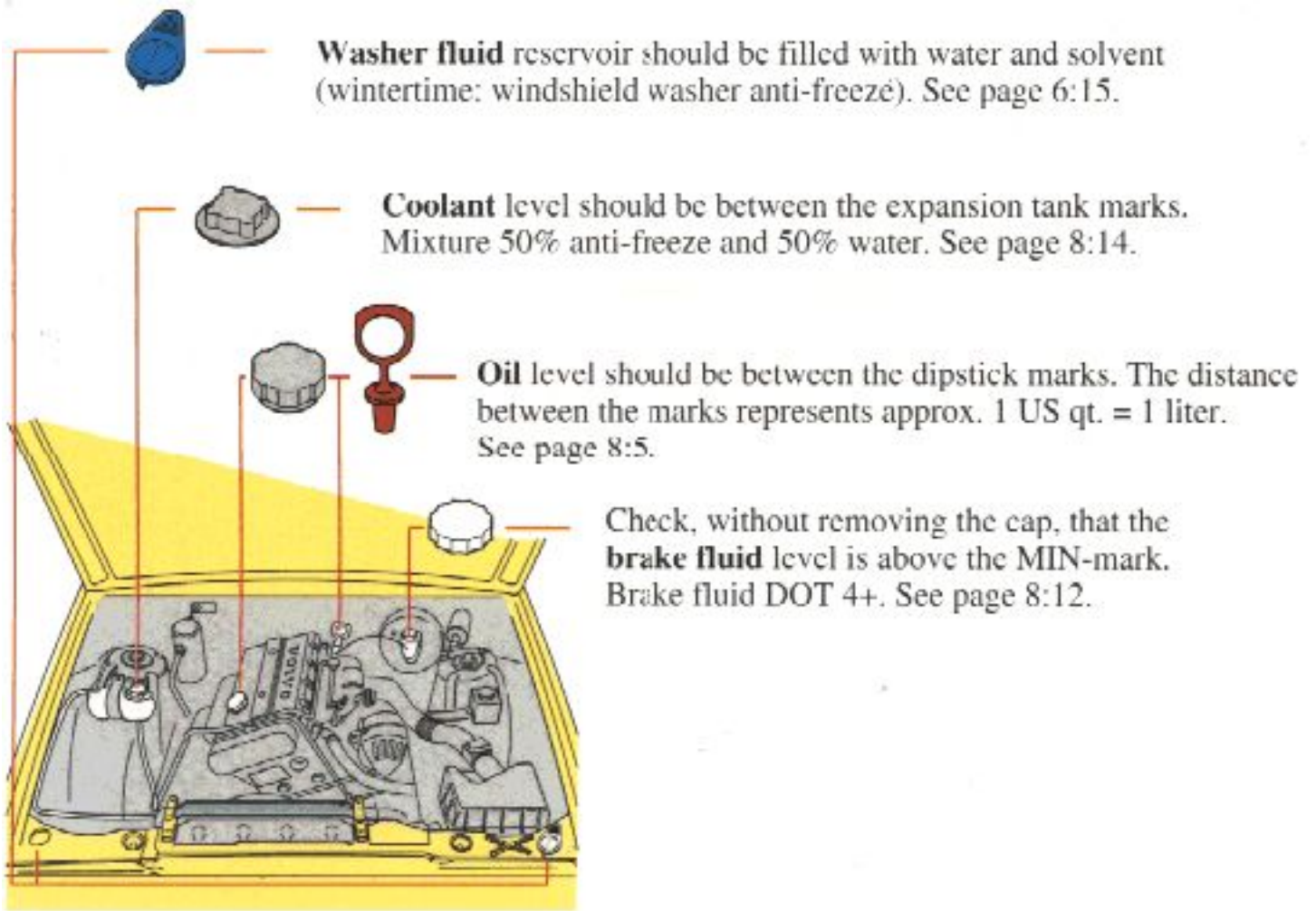

UNLEADED FUEL ONLY  
VOLVO

Octane rating, see p. 4:2.

Tire pressure, see label located on rear edge of right front door.

Bulbs	Power	Socket	US Bulb No.
1	45/65 W		9004
2	27 W		GE 881



3	5 W	BA 15s	67
4	21 W	BA 15s	1156
5	21/5 W	BAY 15d	1157

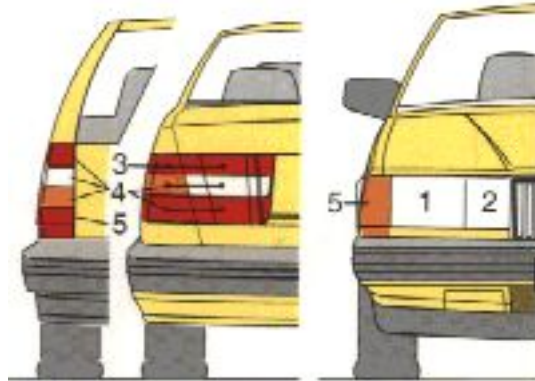

VOLVO  
Volvo Car Corporation

Goteborg, Sweden

TP 3387/2 (Canada & U.S.A.) 20500.9.92 Printed in Sweden. ELANDERS TRYCKERI,  
KUNGSBACKA 199



[Contents](#) | [Top of Page](#)

## Free Manuals Download Website

<http://myh66.com>

<http://usermanuals.us>

<http://www.somanuals.com>

<http://www.4manuals.cc>

<http://www.manual-lib.com>

<http://www.404manual.com>

<http://www.luxmanual.com>

<http://aubethermostatmanual.com>

Golf course search by state

<http://golfingnear.com>

Email search by domain

<http://emailbydomain.com>

Auto manuals search

<http://auto.somanuals.com>

TV manuals search

<http://tv.somanuals.com>