

VOLVO  
**OWNERS MANUAL** V70, V70R & XC70

**VOLVO**  
for life



WEB EDITION

---

## **Dear Volvo owner**

We hope you will enjoy many years of driving pleasure in your Volvo. The car has been designed for the safety and comfort of you and your passengers. Volvo is one of the safest cars in the world. Your Volvo has also been designed to satisfy all current safety and environmental requirements.

In order to increase your enjoyment of the car, we recommend that you familiarise yourself with the equipment, instructions and maintenance information contained in this owner's manual.

**Thank you for choosing Volvo!**

---

## Introduction

### Owner's Manual

A good way of getting to know your new car is to read the owner's manual, ideally before your first journey. This will give you the opportunity to familiarise yourself with new functions, to see how best to handle the car in different situations, and to make the best use of all the car's features. Please pay attention to the safety instructions contained in the manual:

#### **WARNING!**

"Warning!" texts indicate where there is a risk of personal injury in the event of the instructions not being followed.

#### **IMPORTANT!**

"Important!" texts indicate a risk of damage to the car in the event of the instructions not being followed.

The equipment described in the owner's manual is not present in all models. In addition to standard equipment, this manual also describes options (factory fitted equipment) and certain accessories (extra equipment).

**NOTE!** Volvo cars are adapted for the varying requirements of different markets, as well as for national or local legal requirements and regulations.

The specifications, design features and illustrations in this owner's manual are not binding. We reserve the right to make modifications without prior notice.

© **Volvo Car Corporation**

## Volvo Car Corporation and the environment



### Volvo Car Corporation's environmental philosophy

Environmental care, safety and quality are the three core values which influence all operations of the Volvo Car Corporation. We also believe that our customers share our consideration for the environment.

Your Volvo complies with strict international environmental standards and is also manufactured in one of the cleanest and most resource-efficient plants in the world. Volvo Car Corporation has global certification to the ISO 14001 environmental standard, which leads to continuous improvements within the area of the environment.

EPI (Environmental Product Information) environmental product declarations are supplied for all Volvo models. You can now compare the environmental impact of different models and engines.

Read more at [www.volvocars.com/EPI](http://www.volvocars.com/EPI)

### Fuel consumption

Volvo cars have competitive fuel consumption in each of their respective classes. Lower fuel consumption generally results in lower emission of the greenhouse gas, carbon dioxide.

It is possible for the driver to influence fuel consumption, see page 4.

### Efficient emission control

Your Volvo is manufactured following the concept *Clean inside and out* – a concept that encompasses a clean interior environment as well as highly efficient emission control. In many cases the exhaust emissions are well below the applicable standards.

In addition there is a special radiator coating, PremAir®<sup>1</sup>, which can convert hazardous ground-level ozone into pure oxygen.

---

1. PremAir® is a registered trademark of Engelhard Corporation.



---

## Volvo Car Corporation and the environment

### Clean air in the passenger compartment

A sophisticated air cleaning system, IAQS<sup>1</sup> (Interior Air Quality System) ensures that the air in the passenger compartment is cleaner than the air outside.

The system consists of an electronic sensor and a carbon filter. The air intake is closed if the level of reducing gases and oxidising gases, e.g. carbon monoxide, becomes too high, for example in heavy town traffic, queues and tunnels. The entry of nitrous oxides, ground-level ozone and hydrocarbons is prevented by the carbon filter.

### Textile standard

The interior of a Volvo is designed to be healthy and safe – even for people with contact allergies and for asthma sufferers. Extreme attention has been given to choosing environmentally-compatible materials. This means that they also fulfil the requirements of the Öko-Tex 100 ecological standard – a major advance towards a healthier cabin environment.

Öko-Tex certification covers seatbelts, carpets, thread and fabrics for example. Even the leather upholstery undergoes chromium-

free tanning with natural plant substances and meets the requirements.

### Volvo workshops and the environment

Regular maintenance carried out by an authorised Volvo workshop creates the conditions for long service life and low fuel consumption, and contributes to a cleaner environment. When Volvo's workshops are entrusted with the repair and maintenance of the car, it becomes part of our system. We make clear environmental demands regarding the way in which workshops are designed in order to prevent spills and discharges into the environment, and this includes the thorough collection and sorting of the gaseous, liquid and solid waste that arises in our workshops. Our workshop staff have the knowledge and the tools required to guarantee good environmental care.

### Reducing environmental impact

You can help reduce environmental impact, for example, by purchasing eco-labelled car care products and by servicing and maintaining the car according to the instructions in the owner's manual.

The following hints will help you to do your bit for the environment:

- Ensure that your tyre pressures are correct. Poorly inflated tyres increase fuel consumption. If any of the higher tyre pressures recommended by Volvo are used then fuel consumption decreases.
- Since a roof rack and ski box increase air resistance, leading to significantly higher fuel consumption, they should be removed immediately after use.
- Remove unnecessary items from the car – the greater the load the higher the fuel consumption.
- Is your car equipped with an engine block heater? If so, use it for a few hours before starting from cold to reduce fuel consumption and exhaust emissions.
- Drive gently! Avoid accelerating and braking too hard.



---

1. Option.

---

## Volvo Car Corporation and the environment

- Drive in the highest gear possible. Low engine speeds result in lower fuel consumption.
- Ease back on the accelerator on downhill gradients.
- Use engine braking. Take your foot off the accelerator and change down.
- Avoid idling. Switch off the engine in traffic queues.
- Always dispose of environmentally hazardous waste, such as batteries and oils, in an environmentally safe manner. If uncertain, consult an authorised Volvo workshop for advice.
- Service your car regularly.

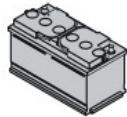

These hints will help you to reduce your fuel consumption without increasing your travel time or lessening the enjoyment of driving. Apart from being kind to your car, you'll be saving money - and the Earth's resources.



---

<b>Safety</b>	<b>9</b>
<b>Instruments and controls</b>	<b>35</b>
<b>Climate control</b>	<b>65</b>
<b>Interior</b>	<b>77</b>
<b>Locks and alarm</b>	<b>99</b>
<b>Starting and driving</b>	<b>111</b>
<b>Wheels and tyres</b>	<b>147</b>
<b>Car care</b>	<b>157</b>
<b>Maintenance and service</b>	<b>163</b>
<b>Audio (option)</b>	<b>191</b>
<b>Telephone (option)</b>	<b>213</b>
<b>Technical data</b>	<b>229</b>



---

## **Safety**

<b>Seatbelts</b>	<b>10</b>
<b>Airbag system</b>	<b>13</b>
<b>Airbags (SRS)</b>	<b>14</b>
<b>Activating/deactivating the airbag (SRS)</b>	<b>17</b>
<b>Side airbags (SIPS bags)</b>	<b>19</b>
<b>Inflatable Curtain (IC)</b>	<b>21</b>
<b>WHIPS</b>	<b>22</b>
<b>When are the safety systems activated?</b>	<b>24</b>
<b>Inspecting the airbags and inflatable curtains</b>	<b>25</b>
<b>Child safety</b>	<b>26</b>

## Seatbelts

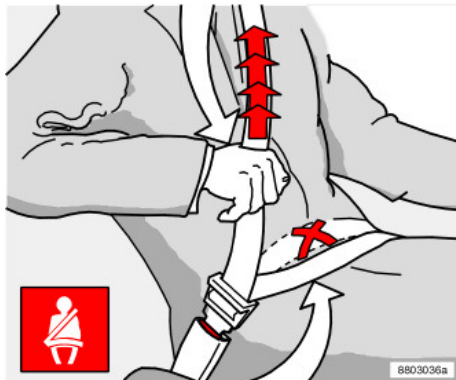

*Tensioning the hip strap. The belt must be positioned low down.*

### Always use a seatbelt

Heavy braking can have serious consequences if the seatbelts are not used. Ensure that all passengers use their seatbelts. Otherwise, rear seat passengers may be thrown forward against the backs of the front seats in the event of a collision.

### Putting on a seatbelt:

- Pull the belt out slowly and secure it by pressing the buckle into the lock. A loud "click" indicates that the belt has locked.

### Taking off a seatbelt:

- Press the red lock button and let the belt retract. If the belt does not retract fully, feed the belt in by hand so that it does not hang loose.

### The belt locks and cannot be withdrawn:

- If it is pulled out too quickly.
- During braking and acceleration.
- If the car leans heavily.

It is important that the belt lies against the body so it can provide maximum protection. Do not lean the backrest too far back. The seatbelt is designed to protect in a normal seating position.

### Keep the following in mind:

- Do not use clips or anything else that can prevent the belt from fitting properly.
- Ensure the belt is not twisted or caught on anything.
- The hip strap must be positioned low down (not over the abdomen).
- Tension the hip strap over the lap by pulling the diagonal shoulder belt as illustrated.

### **WARNING!**

The seatbelts and airbags interact. If a seatbelt is not used or is used incorrectly, this may diminish the protection provided by the airbag in the event of a collision.

### **WARNING!**

Never modify or repair the seatbelts yourself. Contact an authorised Volvo workshop. If the belt has been subjected to a major load, such as in a collision, the entire belt must be replaced. Some of the protective characteristics of the belt may have been lost, even if it appears to be undamaged. Replace the seatbelt if the belt is worn or damaged. The new seatbelt must be type-approved and intended for installation in the same position as the replaced belt.

### **WARNING!**

Each belt is intended for one person only.

## Seatbelts



### Seatbelt reminder

The seatbelt warning symbol in the combined instrument panel and above the rearview mirror comes on until the driver and front seat passenger buckle their seatbelts. The seatbelt reminder switches off after 6 seconds if speed is below 10 km/h. If the driver or front seat passenger have not buckled their seatbelts, the reminder switches on if speed exceeds 10 km/h and switches off if speed drops below 5 km/h.

If the seatbelt is released, the function reactivates when speed exceeds 10 km/h.

**NOTE!** The seatbelt reminder is intended for an adult sitting in the front seat. If a belt-fitted child seat is fitted in the front seat, the seatbelt reminder does not switch on.

### Seatbelts and pregnancy

The seatbelt should always be worn during pregnancy. But it is crucial that it be worn in the correct way. The diagonal section should wrap over the shoulder then be routed between the breasts and to the side of the belly. The lap section should lay flat over the thighs and as low as possible under the belly. It must never be allowed to ride upward. Remove all slack from the belt and insure that it fits close to the body without any twists.

As a pregnancy progresses, pregnant drivers should adjust their seats and steering wheel such that they can easily maintain control of the vehicle as they drive (which means they must be able to easily operate the foot pedals and steering wheel). Within this context, they should strive to position the seat with as large a distance as possible between their belly and the steering wheel.



*Seatbelts and pregnancy.*



## Seatbelts



*Label on seatbelts with seatbelt tensioner.*

### Seatbelt tensioner

All the seatbelts are equipped with belt tensioners. A mechanism in the belt tensioner tightens the belt around the body in the event of a sufficiently violent collision. This provides more effective restraint for passengers.

## Airbag system

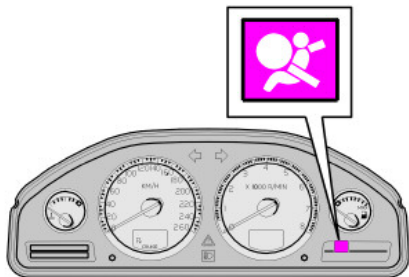

3800779m

### Warning symbol on the combined instrument panel

The Airbag system<sup>1</sup> is monitored continuously by the control module and there is a warning lamp in the combined instrument panel. This lamp comes on when the ignition key is turned to position **I**, **II** or **III**. The symbol goes out after about seven seconds if the Airbag system<sup>1</sup> is working correctly.



As well as the warning symbol, a message appears on the information display. If the warning symbol malfunctions, the warning triangle comes on and the message **SRS AIRBAG SERVICE URGENT** appears on the display. Contact an authorised

Volvo workshop immediately.



### **WARNING!**

If the warning symbol for the Airbag system remains on or comes on while driving, it means that the Airbag system is not functioning fully. The symbol can indicate a fault in the seatbelt buckle, SIPS, SRS or IC system. Contact an authorised Volvo workshop immediately.

1. Includes SRS and seatbelt tensioner, SIPS and IC.

## Airbags (SRS)



### Airbag (SRS) on the driver's side

The car has an SRS airbag (Supplementary Restraint System) in the steering wheel to supplement the protection afforded by the seatbelt. This airbag is fitted into the centre of the steering wheel. The steering wheel is marked SRS AIRBAG.

#### **WARNING!**

The seatbelts and airbags interact. If a seatbelt is not used or is used incorrectly, this may diminish the protection provided by the airbag in the event of a collision.

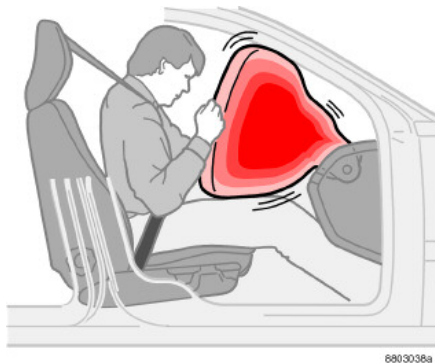

### Passenger airbag (SRS)

The passenger airbag<sup>1</sup> is fitted folded up behind a panel above the glovebox. This panel is marked SRS AIRBAG.

#### **WARNING!**

To minimise the risk of injury if the airbag deploys, passengers must sit as upright as possible with their feet on the floor and backs against the backrest. Seatbelts must be secured.

1. Not all cars have a passenger airbag (SRS). This can be unselected when the car is ordered.

#### **WARNING!**

Never place a child in a child seat or on a booster cushion in the front seat if the airbag (SRS) is activated<sup>1</sup>. Never allow a child to stand or sit in front of the front passenger seat. No one shorter than 140 cm should sit in the front passenger seat if the airbag (SRS) is activated. Failure to follow the advice given above can endanger the life of the child.

1. For information on activated/deactivated airbag (SRS) see page 17.

## Airbags (SRS)

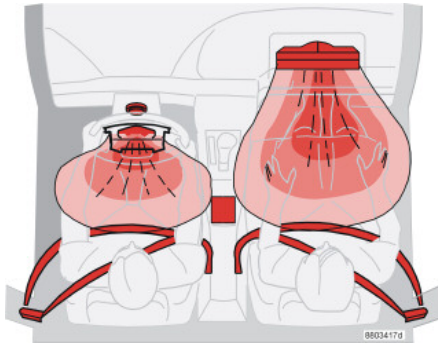

*SRS system, left-hand drive.*

### SRS system

The airbag is equipped with a gas generator. A sufficiently violent collision trips sensors and ignites the gas generator, inflating the airbag with hot gas. To cushion the impact, the airbag deflates when compressed. When this occurs, smoke escapes into the car. This is completely normal. The entire process, including inflation and deflation of the airbag, occurs within tenths of a second.

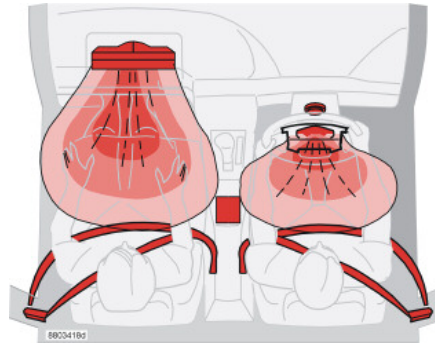

*SRS system, right-hand drive.*

**NOTE!** The sensors react differently depending on the course of the collision and whether the seatbelts on the driver and passenger side are used. It is therefore possible that only one (or none) of the airbags may inflate in a collision. The SRS system senses the force of the collision on the car and adapts accordingly so that one or more airbags is deployed.

**NOTE!** The airbags have a function whereby their capacities are adapted to the collision force to which the vehicle is subjected.

### **WARNING!**

Repairs must only be performed by an authorised Volvo workshop. Work on the SRS system can cause malfunction and result in serious personal injury.

### Airbags (SRS)



*Location of the passenger airbag in left-hand drive and right-hand drive cars.*

#### **WARNING!**

Never interfere with SRS components in the steering wheel or the panel above the glovebox.

Objects and accessories must not be positioned or glued on or near the SRS AIRBAG panel (above the glovebox) or in the area affected by a deployed airbag.

## Activating/deactivating the airbag (SRS)

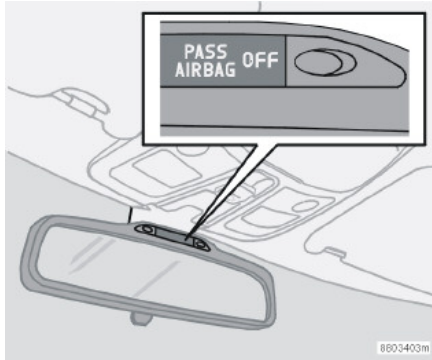

Indicator showing that the passenger airbag (SRS) is deactivated.

### PACOS (option)

The airbag (SRS) for the front passenger seat can be deactivated using a switch. This is necessary if a child seat is to be placed there for example.

### Indicator

A text message in the rearview mirror indicates that the passenger airbag (SRS) is deactivated.

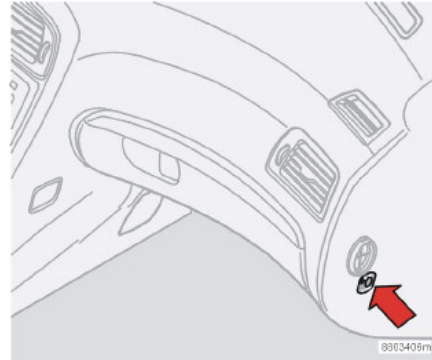

Switch for PACOS (Passenger Airbag Cut Off Switch).

### Activating/deactivating

The switch is located on the passenger end of the dashboard and is accessible when the passenger door is open. Check that the switch is in the required position. Volvo recommends that the ignition key is used to change position. (Other items with a shape similar to a key can be used.)

### **WARNING!**

**Activated airbag** (passenger seat):  
Never place a child in a child seat or on a booster cushion in the front passenger seat when the airbag is activated. This also applies to anyone shorter than 140 cm.

**Deactivated airbag** (passenger seat):  
No one taller than 140 cm should ever sit in the front passenger seat when the airbag is deactivated.  
Failure to follow the advice given above can endanger life.

### **WARNING!**

If the car is equipped with a front passenger airbag (SRS), but does not have PACOS, the airbag will always be activated.

## Activating/deactivating the airbag (SRS)



*Switch for SRS in ON position.*

### Switch position

ON = Airbag (SRS) activated. With the switch in this position, persons taller than 140 cm can sit in the front passenger seat, but never children in a child seat or on a booster cushion.



*Switch for SRS in OFF position.*

OFF = Airbag (SRS) is deactivated. With the switch in this position, children in a child seat or on a booster cushion can sit in the front passenger seat, but never persons taller than 140 cm.

### **WARNING!**

Do not allow anyone to sit in the front passenger seat if the text message in the roof panel indicates that the airbag (SRS) is deactivated and the airbag warning symbol is displayed in the combined instrument panel. This indicates that there has been a severe malfunction. Contact an authorised Volvo workshop as soon as possible.

## Side airbags (SIPS bags)



*Side airbag locations.*

### Side airbags (SIPS bags)

A large proportion of the collision force is transferred by the SIPS (Side Impact Protection System) to the floor, roof, beams, pillars, and other structural parts of the body. The side airbags on the driver's and front passenger seats protect the chest area and are an important part of the SIPS. The side airbags are located in the front seat backrests.



*Inflated side airbag.*

#### **WARNING!**

Side airbags are a supplement to the SIPS system. Always wear a seatbelt.

#### **WARNING!**

Repairs must only be performed by an authorised Volvo workshop. Work on the SIPS system can cause malfunction and result in serious personal injury.

#### **WARNING!**

Do not put objects in the area between the outside of the seat and the door panel, since this area is required by the side airbag.

#### **WARNING!**

Use only Volvo genuine car seat covers, or seat covers approved by Volvo. Other seat covers may impede the operation of the side air bags.

### Child seats and side airbags

The side airbag does not diminish the protection provided by the car to children seated in a child seat or on a booster cushion.

A child seat or booster cushion can be placed on the front passenger seat provided that the car does not have an activated<sup>1</sup> passenger airbag.

1. For information on activated/deactivated airbag (SRS) see page 17.



## Side airbags (SIPS bags)



*Left-hand drive.*

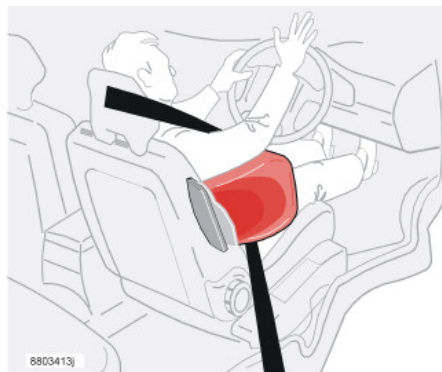

*Right-hand drive.*

### **SIPS bags**

The side airbag is equipped with a gas generator. A sufficiently violent collision trips the sensors and ignites the gas generator, inflating the side airbag. The airbag inflates between the occupant and the door panel and thereby cushions the initial impact while deflating. The side airbag is only normally deployed on the side of the collision.

## Inflatable Curtain (IC)

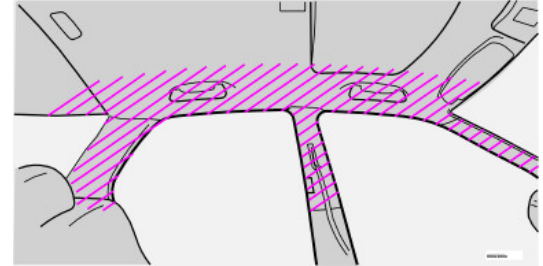
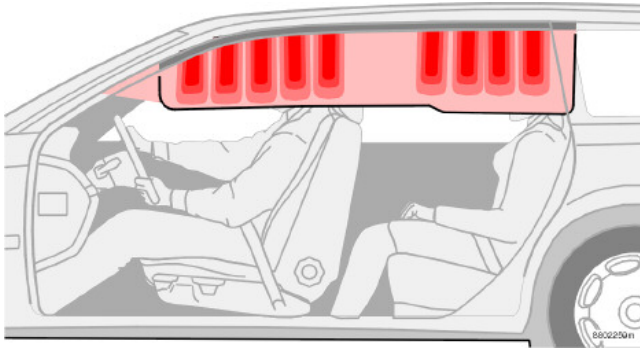

### Properties

The inflatable curtain, IC (Inflatable Curtain), is a supplement to the SIPS system. It is concealed in the headlining along both sides of the roof and protects both front and rear seat passengers. The inflatable curtain is activated by sensors in a sufficiently violent collision. When deployed, the inflatable curtain inflates. The inflatable curtain helps to prevent the driver and passengers from striking their heads on the inside of the car during a collision.

#### **⚠ WARNING!**

Never hang or fasten anything on the roof handles. The hook is only intended for light outer garments (not for hard objects such as umbrellas).

Do not screw or fit anything to the headlining, door pillars or side panels.

This could compromise the intended protection. Only use Volvo genuine parts that are approved for placement in these areas.

#### **⚠ WARNING!**

Do not load the car higher than 50 mm under the top edge of the side windows. Otherwise, the intended protection of the inflatable curtain, which is hidden in the headlining, may be compromised.

#### **⚠ WARNING!**

The inflatable curtain is a supplement to the seatbelts.  
Always use a seatbelt.

## WHIPS



### Protection against whiplash injury - WHIPS

The whiplash protection system (WHIPS) consists of energy absorbing backrests and specially designed head restraints for the front seats. The system is actuated by a rear-end collision, where the angle and speed of the collision, and the nature of the colliding vehicle all have an influence.

#### **WARNING!**

The WHIPS system is a supplement to the seatbelts. Always wear your seatbelt.

### Properties of the seat

When the WHIPS system is deployed, the front seat backrests fall backward to alter the position of the driver and front seat passenger. This diminishes the risk of whiplash injury.

#### **WARNING!**

Never modify or repair the seat or WHIPS system yourself. Contact an authorised Volvo workshop.

### WHIPS system and child seats/ booster cushions

The WHIPS system does not diminish the protection provided by the car to children seated in a child seat or on a booster cushion.

### Correct seating position

For the best possible protection, the driver and front seat passenger should sit in the centre of the seat with as little space as possible between the head and the head restraint.

## WHIPS



### Do not obstruct the WHIPS system

#### **WARNING!**

Do not squeeze rigid objects between the rear seat cushion and the front seat backrest. Make sure you do not to obstruct the function of the WHIPS system.

#### **WARNING!**

If a rear seat backrest is folded down, the corresponding front seat must be moved forward so that it does not touch the folded backrest.

#### **WARNING!**

If a seat has been subjected to extreme forces, such as due to a rear collision, the WHIPS system must be checked by an authorised Volvo workshop. Part of the WHIPS system's protective capacity may have been lost even if the seats appear to be undamaged. Contact an authorised Volvo workshop to have the system checked even after a minor rear-end collision.

## When are the safety systems activated?

System	Triggered
Seatbelt tensioner	In a frontal collision and/or side-impact accident.
Airbags (SRS)	In a frontal collision <sup>1</sup> .
Side airbags (SIPS)	In a side-impact accident <sup>1</sup> .
Inflatable Curtain IC	In a side-impact accident <sup>1</sup> .
Whiplash protection WHIPS	In a rear-end collision.

1. The bodywork of the car could be greatly deformed in a collision without airbag deployment. A number of factors such as the rigidity and weight of the object hit, the speed of the car, the angle of the collision etc. affects how the different safety systems of the car are activated.

If the airbags have been deployed, the following is recommended:

- Have the car transported to an authorised Volvo workshop. Do not drive with deployed airbags.
- Let an authorised Volvo workshop replace components in the car's safety system.
- Always contact a doctor.

**NOTE!** The SRS, SIPS, IC and belt tensioner systems are deployed only once during a collision.



### **WARNING!**

The Airbag control unit is located in the centre console. If the centre console is drenched with water or other liquid, disconnect the battery cables. Do not attempt to start the car since the airbags may deploy. Have the car transported to an authorised Volvo workshop.



### **WARNING!**

Never drive with deployed airbags. They can make steering difficult. Other safety systems may also be damaged. The smoke and dust created when the airbags are deployed can cause skin and eye irritation after intensive exposure. In case of irritation, wash with cold water. The rapid deployment sequence and airbag fabric may cause friction and skin burns.

## Inspecting the airbags and inflatable curtains

### Inspection intervals

The decal on the door pillar(s) shows the dates (year, month) when you should contact an authorised Volvo workshop to inspect and, if necessary, replace the airbags, belt tensioners and inflatable curtains. If you have questions concerning the systems, contact an authorised Volvo workshop.

1. Driver airbag
2. Front passenger airbag
3. Side airbag on the driver's side
4. Side airbag on the passenger side
5. Inflatable curtain on the driver's side
6. Inflatable curtain on the passenger side

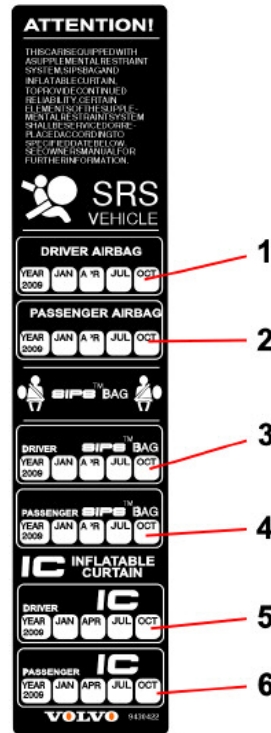

IMG-203360

*This decal is located in the rear left door opening.*

## Child safety



### Children should sit comfortably and safely

The position of a child in the car and the choice of equipment is dictated by the child's weight and size, for more information see page 28.

Children who are shorter than 150 cm must be carried in adequate child protection.

**NOTE!** Regulations regarding the placement of children in cars vary from country to country. Check what laws apply.

Children of all ages and sizes must always sit correctly secured in the car. Never allow a child to sit on the knee of a passenger.

Volvo's own child safety equipment is designed for your car. Use Volvo genuine equipment to best ensure that the mounting points and attachments are correctly positioned and are sufficiently strong.

You may place:

- A child seat or booster cushion on the front passenger seat, provided the passenger airbag is not activated<sup>1</sup>.
- A rear-facing child seat in the rear seat that uses the back of the front seat as support.

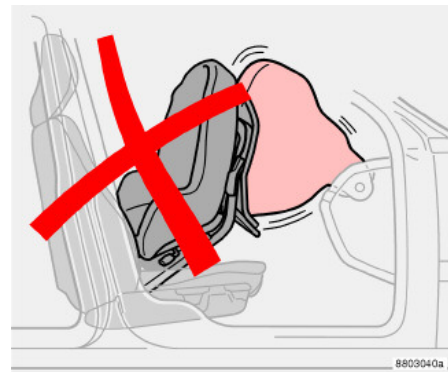

*Airbags (SRS) and child seats are not compatible.*

### Child seats and airbags (SRS)

Always place a child in the rear seat if the passenger airbag (SRS) is activated<sup>1</sup>. A child in a child seat on the front passenger seat may suffer serious injury if the airbag deploys.

#### **WARNING!**

Persons shorter than 140 cm may only sit in the front passenger seat if the passenger airbag is deactivated.

1. For information on activated/deactivated airbag (SRS) see page 17.

## Child safety

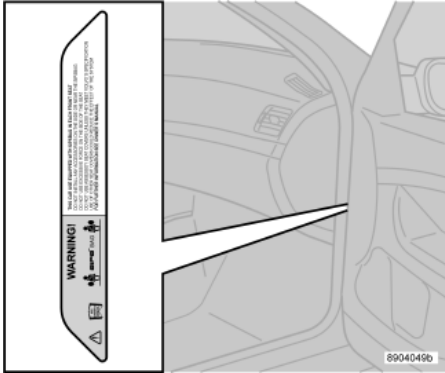

*Location of airbag decal in door opening on front passenger side.*



8903808a

*Decal located on dashboard end face.*



*Decal located on dashboard end face.  
(Australia only).*

### **WARNING!**

Never place a child in a child seat or on a booster cushion in the front seat if the airbag (SRS) is activated.<sup>1</sup>

Failure to follow this advice could endanger the life of the child.

1. For information on activating/deactivating the airbag (SRS), see page 17.



## Child safety

### Placement of children in the car

Weight/age	Front seat	Outer rear seat	Centre rear seat
<10 kg (0–9 months)	<p>Alternatives:</p> <p>Rear-facing child seat, secured with seatbelt.</p> <p>L<sup>1</sup>: Type approval no. E5 03160</p> <p>Rear-facing child seat, secured with Isofix mounting.</p> <p>L<sup>1</sup>: Type approval no. E5 03162</p> <p>Rear-facing child seat, secured with seatbelt and mounting strap.</p> <p>L<sup>1</sup>: Type approval no. E5 03135</p>	<p>Alternatives:</p> <p>Rear-facing child seat, secured with seatbelt and support legs.</p> <p>L<sup>1</sup>: Type approval no. E5 03160</p> <p>Rear-facing child seat, secured with Isofix mounting and support legs.</p> <p>L<sup>1</sup>: Type approval no. E5 03162</p> <p>Rear-facing child seat, secured with seatbelt, support legs and straps.</p> <p>L<sup>1</sup>: Type approval no. E5 03135</p>	<p>Rear-facing child seat, secured with seatbelt, support legs and straps.</p> <p>L<sup>1</sup>: Type approval no. E5 03135</p>
9–18 kg (9–36 months)	<p>Alternatives:</p> <p>Rear-facing child seat, secured with seatbelt.</p> <p>L<sup>1</sup>: Type approval no. E5 03161</p> <p>Rear-facing child seat, secured with Isofix mounting.</p> <p>L<sup>1</sup>: Type approval no. E5 03163</p> <p>Rear-facing child seat, secured with seatbelt and mounting strap.</p> <p>L<sup>1</sup>: Type approval no. E5 03135</p>	<p>Alternatives:</p> <p>Rear-facing child seat, secured with seatbelt and support legs.</p> <p>L<sup>1</sup>: Type approval no. E5 03161</p> <p>Rear-facing child seat, secured with Isofix mounting and support legs.</p> <p>L<sup>1</sup>: Type approval no. E5 03163</p> <p>Rear-facing child seat, secured with seatbelt, support legs and straps.</p> <p>L<sup>1</sup>: Type approval no. E5 03135</p>	<p>Rear-facing child seat, secured with seatbelt, support legs and straps.</p> <p>L<sup>1</sup>: Type approval no. E5 03135</p>

## Child safety

Weight/age	Front seat	Outer rear seat	Centre rear seat
15–36 kg (3–12 years)	Booster cushion with or without backrest. L <sup>1</sup> : Type approval no. E5 03139	Alternatives: Booster cushion with or without backrest. L <sup>1</sup> : Type approval no. E5 03139 Integrated booster cushion. B <sup>2</sup> : Type approval no. E5 03159	Booster cushion with or without backrest. L <sup>1</sup> : Type approval no. E5 03139

1. L: Suitable for certain child seats as listed in the specified type approval. Child seats can be vehicle-specific, limited, semi-universal or universal.
2. B: Integrated and approved for this age group.

### Child safety

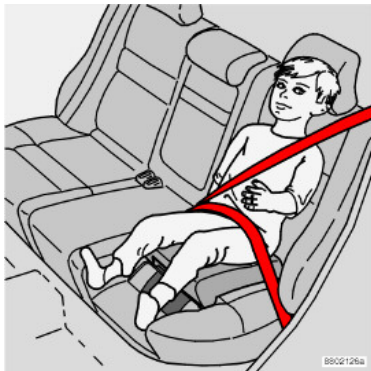

#### **WARNING!**

Never place a child in a child seat or on a booster cushion in the front seat if the airbag (SRS) is activated.

No one shorter than 140 cm should sit in the front passenger seat if the airbag (SRS) is activated<sup>1</sup>.

Failure to follow the advice given above can endanger the life of the child.

1. For information on activated/deactivated airbag (SRS) see page 17.

### Integrated booster cushion (option)

Volvo's integrated booster cushion for the outer rear seats is specially designed to provide optimum safety for children.

Combined with the regular seatbelts, the booster cushion is approved for children weighing between 15 and 36 kg.

## Child safety

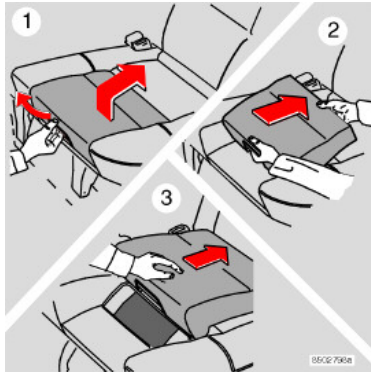

### Raising the booster cushion

- Pull the handle to raise the booster cushion (1).
- Grasp the cushion with both hands and push it backwards (2).
- Push until it locks in place (3).

#### **WARNING!**

The booster cushion must be in the locked position before the child is placed there.

### Check that:

- The seatbelt is locked.
- The seatbelt is in contact with the child's body and is not slack or twisted, and that the belt is positioned correctly across the shoulder.
- The hip strap is low across the hips for optimum protection.
- The belt does not touch the child's throat or lie below the shoulder.
- Carefully adjust the position of the head restraint to suit the child.

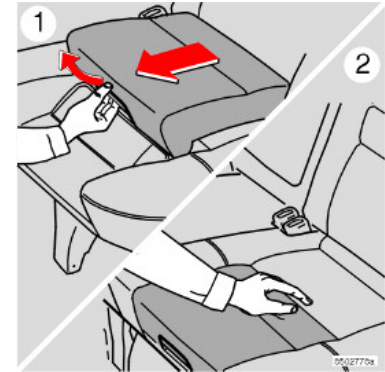

### Lowering the booster cushion

- Pull the handle (1).
- Lower the seat and press until it locks (2).

**NOTE!** Remember to stow away the booster cushion before lowering the rear seat backrest.

#### **WARNING!**

Repair or replacement should only be performed by an authorised Volvo workshop. Do not make any modifications or additions to the booster cushion. If an integrated booster cushion has been subjected to a major load, such as in conjunction with a collision, the entire booster cushion must be replaced. Even if the booster cushion appears to be undamaged, it may not afford the same level of protection. The booster cushion must also be replaced if it is heavily worn.

### Child safety

#### Fitting a child seat

Volvo has child safety products that are designed for and tested by Volvo.

When using other products that are available on the market, it is important to read the fitting instructions included with the product.

- Do not attach the straps for the child seat to the horizontal adjustment bar, springs, rails or beams under the seat. Sharp edges can damage the straps.
- Allow the back of the child seat to rest against the dashboard. This applies to cars without a passenger airbag, or where the airbag is deactivated.



#### **WARNING!**

Never place the child seat in the front seat if the car is equipped with an activated<sup>1</sup> front passenger airbag. If problems arise when fitting child safety products, contact the manufacturer for clearer instructions.

1. For information on activated/deactivated airbag (SRS), see page 17.

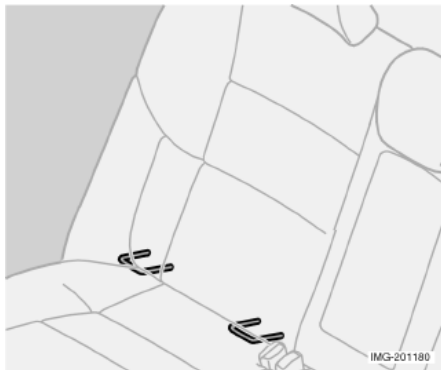

#### **ISOFIX fixture system for child seats (option)**

The outer rear seats have ISOFIX attachment points for child seats. Contact a Volvo dealer for further information on child safety equipment.

## Child safety

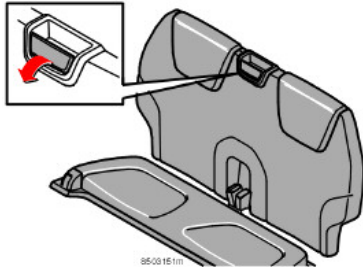

### **⚠ WARNING!**

If your car is fitted with an extra seat then the tailgate must be equipped with a lock cylinder. Unlocking from the outside can now take place in the normal way (key in driver's door and/or with the remote control) as well as by using the key in the tailgate lock cylinder.

The child safety locks in the tailgate must be activated, in order to prevent a child accidentally opening the tailgate from the inside.

If you must take the cargo area cover along on a trip while using the extra seat in the cargo area, proceed as follows:

- Fold both backrests of the backseat into a more upright position (see page 90).
- Carefully position the detached cargo area cover between the rear seat backrests and the extra seat. Fold up the extra seat's head restraint.

### Extra seat (option)

The extra seat is suitable for two children, each weighing between 15 and 36 kg and up to max. 140 cm tall. The maximum total weight is 72 kg.

#### Folding up

- Remove the cargo area cover if your car is so equipped.
- Fold the backrest section forwards until it locks in place.
- Fold the seat cushion forwards.

#### Lowering

- Fold the seat cushion rearwards.
- Pull the backrest section's handle to open it and then fold it downwards.

### **⚠ WARNING!**

When the extra seat is being used, both of the rear seat backrests must be in the raised position, the safety net removed, and the child safety lock open. This is to enable the child to leave the car in the event of an accident.

If your car is fitted with a steel mesh then, without exception, this must be removed before the extra seat is used.



---

## **Instruments and controls**

<b>Overview, left-hand drive cars</b>	<b>36</b>
<b>Overview, right-hand drive cars</b>	<b>38</b>
<b>Combined instrument panel</b>	<b>40</b>
<b>Indicator and warning symbols</b>	<b>41</b>
<b>Information display</b>	<b>44</b>
<b>Switches in the centre console</b>	<b>46</b>
<b>Lighting panel</b>	<b>49</b>
<b>Left-hand stalk switch</b>	<b>50</b>
<b>Right-hand stalk switch</b>	<b>51</b>
<b>Trip computer</b>	<b>53</b>
<b>Cruise control (option)</b>	<b>54</b>
<b>Parking brake, electric socket/cigarette lighter</b>	<b>56</b>
<b>Steering wheel adjustment</b>	<b>58</b>
<b>Power windows</b>	<b>59</b>
<b>Rearview mirror, door mirrors and side windows</b>	<b>61</b>
<b>Power sunroof (option)</b>	<b>63</b>



## Overview, left-hand drive cars

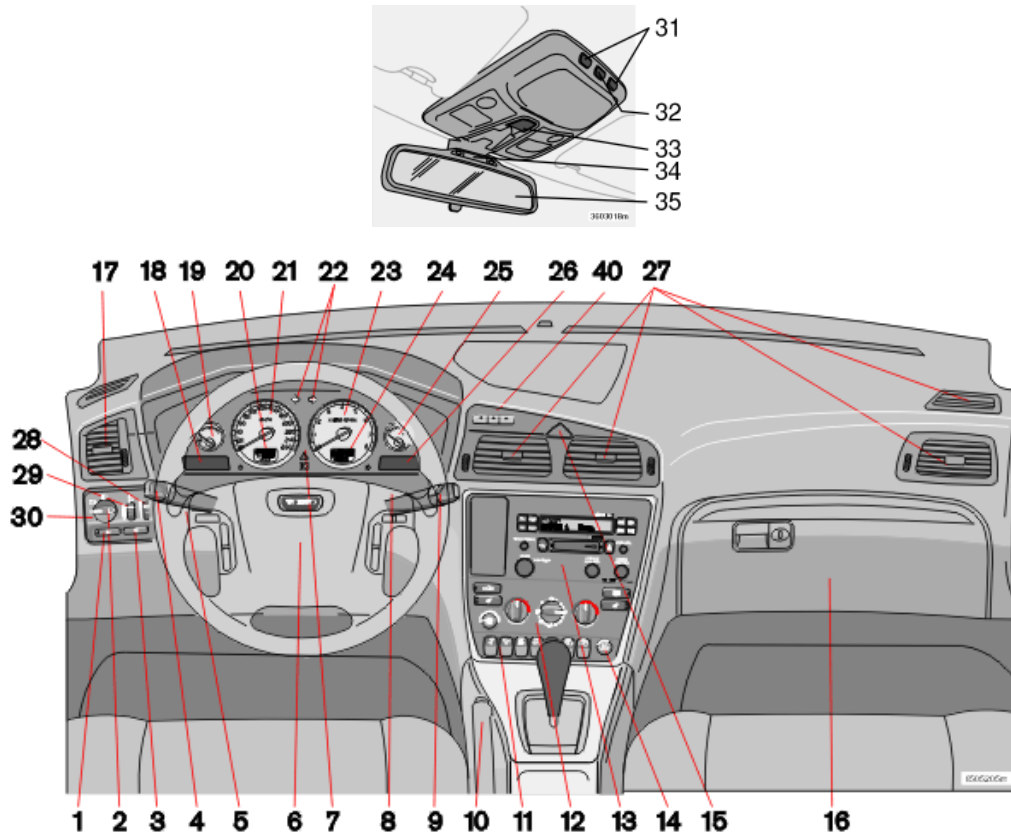

## Overview, left-hand drive cars

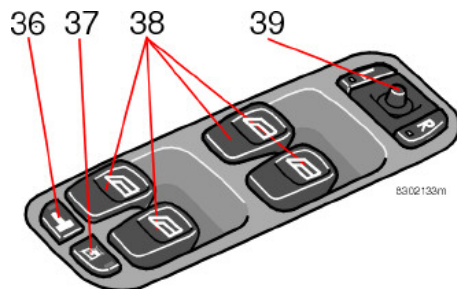

*Control panel in the driver's door*

- |                                               |                   |                                                     |                   |
|-----------------------------------------------|-------------------|-----------------------------------------------------|-------------------|
| 1. Fog lamps .....                            | page 49           | 18. Display.....                                    | page 44           |
| 2. Headlamps, position/parking lights.....    | page 49           | 19. Temperature gauge.....                          | page 40           |
| 3. Rear fog lamp.....                         | page 49           | 20. Odometer, trip odometer/cruise control .....    | page 40/page 54   |
| 4. Direction indicators, beam selection.....  | page 50           | 21. Speedometer .....                               | page 40           |
| 5. Cruise control .....                       | page 54           | 22. Direction indicators.....                       | page 50           |
| 6. Horn .....                                 | -                 | 23. Tachometer.....                                 | page 40           |
| 7. Combined instrument panel .....            | page 40           | 24. Outside temperature, clock, gear position ..... | page 40           |
| 8. Keypad for telephone/audio.....            | page 214/page 198 | 25. Fuel gauge.....                                 | page 40           |
| 9. Windscreen wipers.....                     | page 52           | 26. Indicator and warning symbols .....             | page 41           |
| 10. Parking brake (handbrake) .....           | page 56           | 27. Panel vents .....                               | page 67           |
| 11. Switch panel.....                         | page 46           | 28. Instrument lighting .....                       | page 49           |
| 12. Climate control .....                     | page 68, page 70  | 29. Headlamp levelling .....                        | page 49           |
| 13. Audio system.....                         | page 192          | 30. Lighting panel .....                            | page 49           |
| 14. Electrical socket, cigarette lighter..... | page 47           | 31. Reading lamps.....                              | page 81           |
| 15. Hazard warning flashers .....             | page 48           | 32. Interior lighting.....                          | page 81           |
| 16. Glovebox.....                             | page 86           | 33. Control, sunroof.....                           | page 63           |
| 17. Panel vents .....                         | page 67           | 34. Seatbelt reminder .....                         | page 61           |
|                                               |                   | 35. Rearview mirror.....                            | page 61           |
|                                               |                   | 36. Lock button, for all doors .....                | page 103          |
|                                               |                   | 37. Blocking power windows in the rear doors.....   | page 60           |
|                                               |                   | 38. Controls, power windows .....                   | page 59           |
|                                               |                   | 39. Controls, power door mirrors .....              | page 61           |
|                                               |                   | 40. Active chassis, Four-C (V70 R) .....            | page 48, page 123 |

## Overview, right-hand drive cars

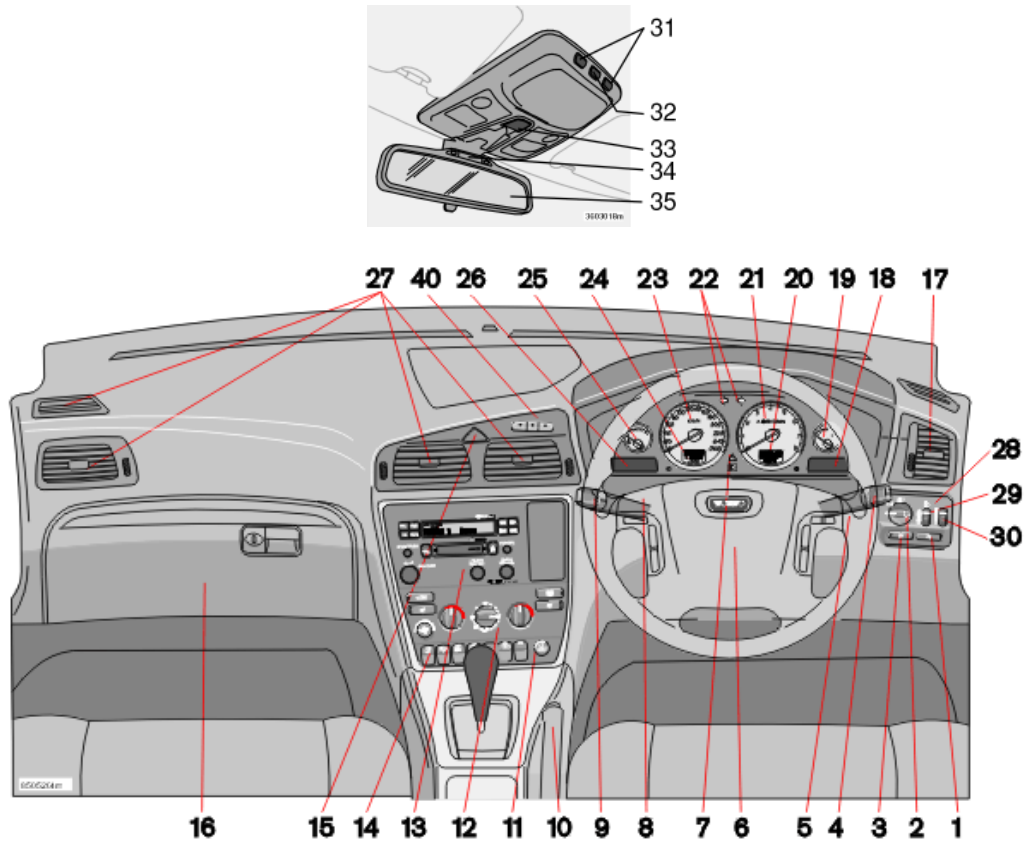

## Overview, right-hand drive cars

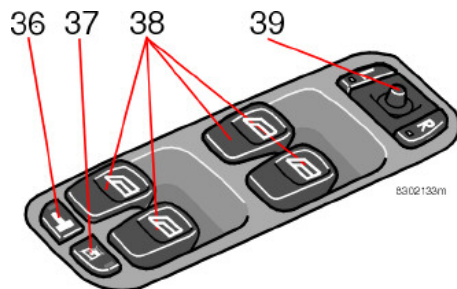

*Control panel in the driver's door*

- |                                               |                   |                                                    |                   |
|-----------------------------------------------|-------------------|----------------------------------------------------|-------------------|
| 1. Rear fog lamp.....                         | page 49           | 18. Indicator and warning symbols.....             | page 41           |
| 2. Headlamps, position/parking lights.....    | page 49           | 19. Fuel gauge.....                                | page 40           |
| 3. Fog lamps.....                             | page 49           | 20. Outside temperature, clock, gear position..... | page 40           |
| 4. Windscreen wipers.....                     | page 52           | 21. Tachometer.....                                | page 40           |
| 5. Keypad for telephone/audio.....            | page 214/page 198 | 22. Direction indicators.....                      | page 50           |
| 6. Horn.....                                  | page 40           | 23. Speedometer.....                               | page 40           |
| 7. Combined instrument panel.....             | -                 | 24. Odometer, trip odometer/cruise control.....    | page 40/page 54   |
| 8. Cruise control.....                        | page 54           | 25. Temperature gauge.....                         | page 40           |
| 9. Direction indicators, beam selection.....  | page 52           | 26. Display.....                                   | page 44           |
| 10. Parking brake (handbrake).....            | page 56           | 27. Panel vents.....                               | page 67           |
| 11. Electrical socket, cigarette lighter..... | page 47           | 28. Lighting panel.....                            | page 49           |
| 12. Climate control.....                      | page 68, page 70  | 29. Headlamp levelling.....                        | page 49           |
| 13. Audio system.....                         | page 192          | 30. Instrument lighting.....                       | page 49           |
| 14. Switch panel.....                         | page 46           | 31. Reading lamps.....                             | page 81           |
| 15. Hazard warning flashers.....              | page 48           | 32. Interior lighting.....                         | page 81           |
| 16. Glovebox.....                             | page 86           | 33. Control, sunroof.....                          | page 63           |
| 17. Panel vents.....                          | page 67           | 34. Seatbelt reminder.....                         | page 61           |
|                                               |                   | 35. Rearview mirror.....                           | page 61           |
|                                               |                   | 36. Lock button, for all doors.....                | page 103          |
|                                               |                   | 37. Blocking power windows in the rear doors.....  | page 60           |
|                                               |                   | 38. Controls, power windows.....                   | page 59           |
|                                               |                   | 39. Controls, power door mirrors.....              | page 61           |
|                                               |                   | 40. Active chassis, Four-C (V70 R).....            | page 46, page 123 |

## Combined instrument panel

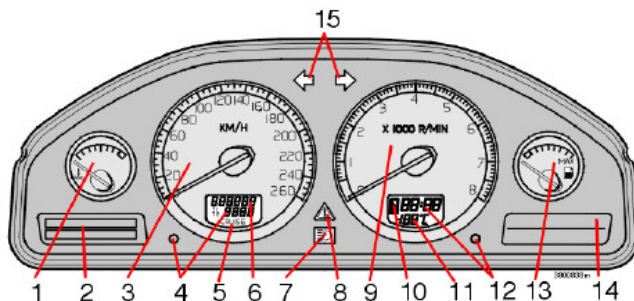

### 1. Temperature gauge

Displays the temperature of the engine cooling system. If the temperature is abnormally high and the needle enters the red zone, a message is shown in the display. Bear in mind that extra lamps in front of the radiator grille reduce the cooling capacity at high outside temperature and high engine loads.

### 2. Display

Information and warning messages are shown in the display.

### 3. Speedometer

Shows the speed of the car.

### 4. Trip odometer, T1 and T2

The trip odometers are used for measuring short distances. The right-hand digit displays tenths of a kilometre. Press the button for more than 2 seconds to reset. Switch between trip odometers with one quick press of the button.

40

### 5. Cruise control indicator

See page 54.

### 6. Odometer

The odometer indicates the total distance the car has travelled.

### 7. Main beam on/off

### 8. Warning symbol

If a fault arises, the symbol lights up and a message is shown in the display.

### 9. Tachometer

Indicates engine speed in thousands of revolutions per minute (RPM). Do not allow the needle of the tachometer to enter the red field.

### 10. Automatic gearbox indicator

The selected gearshift programme is displayed here. If you have Geartronic automatic gearbox and drive using the manual function, the current manual gear is displayed.

### 11. Outside temperature gauge

Displays outside temperature. When the temperature lies between +2 °C to -5 °C, a snowflake symbol is shown in the display. This symbol serves as a warning for slippery road surfaces. When the car is or was stationary, the outside temperature gauge may display a higher reading than the actual temperature.

### 12. Clock

Turn the button to set the clock.

### 13. Fuel gauge

When the lamp in the instrument panel lights, approximately 8 litres of usable fuel remain in the tank.

### 14. Indicator and warning symbols

### 15. Direction indicators - left/right

## Indicator and warning symbols

### Indicator and warning symbols

All indicator and warning symbols<sup>1</sup> light up when the ignition key is turned to position **II** before starting. This is to check that the symbols/lights are working. When the engine starts, all the symbols should go out except the handbrake symbol, which extinguishes when the handbrake is released.



If the engine does not start within five seconds, all symbols extinguish except the symbols for a fault in the car's emissions system and for low oil pressure. Certain symbols may have no

function, depending on the car's specifications.

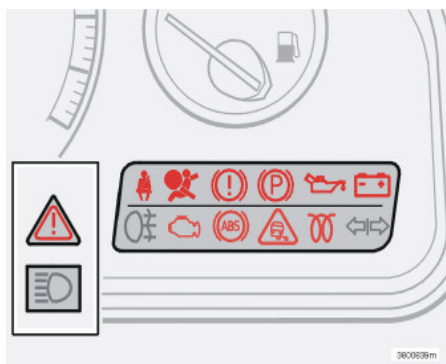

### Warning symbols in the centre of the instrument panel



These symbols are lit with a red or amber glow depending on the severity of the fault.

#### Red symbol:

- Stop the car! Read the message in the display.

Symbol and message text are visible until the fault has been rectified.

#### Yellow symbol:

- Read the message in the display.  
Remedy!

The message text is cleared using the READ button, see page 44, or disappears automatically after 2 minutes.

When the message text "TIME FOR REGULAR SERVICE" is shown, the symbol lamp and message text are cleared using the READ button, or disappear automatically after 2 minutes.

### ABS fault



If the ABS symbol lights, the ABS system is not functioning. The car's normal braking system continues to work, but without the ABS function.

- Stop the car in a safe place and switch off the engine. Restart the engine.
- If the warning symbol goes out, continue driving. It was an indicator error.
- If the warning symbol remains lit, drive to an authorised Volvo workshop to have the ABS system checked.

### Fault in brake system



If the BRAKE symbol lights, the brake fluid level may be too low.

Stop the car in a safe place and check the brake fluid reservoir level.

- If the reservoir level is below MIN, the car should not be driven further. Have it

1. With certain engine variants the symbol for low oil pressure is not lit.

## Indicator and warning symbols

towed to an authorised Volvo workshop to have the brake system checked.



If the BRAKE and ABS warning symbols light at the same time, there may be a problem in the brake force distribution.



Stop the car in a safe place and switch off the engine. Restart the engine.

- If both symbols go out, it was an indicator error.
- If the warning symbols remain lit, check the brake fluid reservoir level.
- If the reservoir level is below MIN, the car should not be driven further. Have it towed to an authorised Volvo workshop to have the brake system checked.
- If the brake fluid level is normal and the lamps remain lit, carefully drive the car to the nearest authorised Volvo workshop to have the brake system checked.

### **WARNING!**

If the BRAKE and ABS warning symbols light at the same time, there is a risk that the rear end will have a tendency to slide during heavy braking.

## Seatbelt reminder



This lamp lights until the driver buckles up.

## Low oil pressure



If the lamp lights while driving, engine oil pressure is too low. Stop the engine immediately and check the oil level. If the lamp lights but the oil level is normal, stop the car and contact an authorised Volvo workshop.

## Fault in car's emissions system



Drive to an authorised Volvo workshop to have the system checked.

## Fault in SRS



If a fault in the SRS system is detected the warning symbol will remain lit or light up while driving. Drive to an authorised Volvo workshop to have the system checked.

## Alternator not charging



If this lamp lights while driving, there is probably a fault in the electrical system. Contact an authorised Volvo workshop.

## Engine preheater (diesel)



This lamp indicates engine preheating. You can start the car when the lamp switches off. Applies to diesel cars only.

## Parking brake applied



The lamp comes on when the parking brake is applied. Always pull the parking brake lever up to its top position.

**NOTE!** The lamp comes on as soon as the parking brake lever reaches position (notch) one.

## Rear fog lamp



This lamp lights when the fog lamp is on.

## Trailer indicator lamp



Flashes when the direction indicators of the car and trailer are used. If the lamp does not flash, one of the direction indicator lamps on the trailer or car is defective.

## Indicator and warning symbols

### Stability systems STC and DSTC<sup>1</sup>

The STC/DSTC system contains several different functions that are described in more detail on page 123.

#### The symbol lights and goes out again after approx. two seconds



The symbol is lit for a system check when the car is started.

#### The symbol flashes



The SC function acts to prevent the car's drive wheels from spinning. The TC function acts to improve the car's traction.

The AYC function acts to prevent skidding.

#### The warning symbol shines with a steady amber glow



TRACTION CONTROL TEMPORARILY OFF is shown in the information display together with the symbol.

The TC function has been temporarily suppressed because the brake temperature is too high.

Automatic reactivation of the function takes place when the brake temperature has returned to normal.

#### The warning symbol shines with a steady amber glow



ANTI-SKID SERVICE REQUIRED appears in the information display together with the symbol. The STC or DSTC system has been switched off because of a fault.

- Stop the car in a safe place and turn off the engine.
- Restart the engine.

If the warning symbol remains lit, drive to an authorised Volvo workshop to have the system checked.

#### Fault in the STC/DSTC systems



A symbol that lights and shines with a constant glow and the message "ANTI-SKID SERVICE REQUIRED" displayed without any of the systems being switched off is an indication of a system fault.

- Stop the car in a safe place and switch off the engine. Restart the engine.

If the warning symbol goes out, the fault was temporary and it is not necessary to visit a workshop.

If the warning symbol remains lit, drive to an authorised Volvo workshop to have the system checked.

#### **WARNING!**

Under normal driving conditions, the STC/DSTC system improves the car's road safety, but this is not an indication to increase speed. Always follow normal safety precautions for cornering and driving on slippery surfaces.

1. Option in certain markets. Standard on V70 R.



### Information display

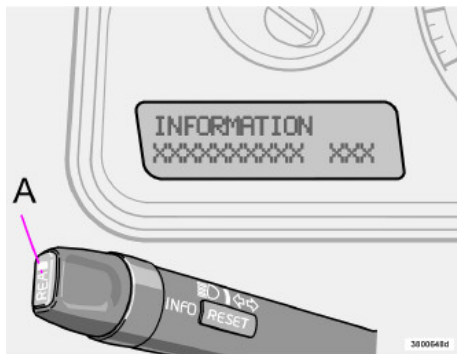

sages stored in the memory by pressing the READ button.

Press the READ button to return read messages to the memory.

**NOTE!** If a warning message interrupts when you are in the trip computer menu or wish to use the telephone, you must first acknowledge the message by pressing the READ button (A).

### Messages in the display

A message appears in the display whenever a warning or indicator symbol comes on. Once you have read and understood the message, press the READ button (A). Read messages are then erased from the display and stored in a memory. Messages regarding faults remain in the memory until the fault has been remedied.

Very serious fault messages cannot be erased from the display. They remain in the display until the fault is remedied.

Messages stored in the memory can be read again. Press the READ button (A) to see stored messages. Scroll through the mes-

## Information display

Message	Specification
STOP SAFELY	Stop and switch off the engine. Serious risk of damage.
STOP ENGINE	Stop and switch off the engine. Serious risk of damage.
SERVICE URGENT	Take your car in for service immediately.
SEE MANUAL	Consult your owner's manual.
SERVICE REQUIRED	Take your car in for service as soon as possible.
FIX NEXT SERVICE	Have your car checked at the next service interval.
TIME FOR REGULAR SERVICE	When this message is shown, the car is due for a service. When the message is displayed is affected by the distance travelled, number of months since last service and engine running time.
OIL LEVEL LOW <sup>1</sup> – FILL OIL <sup>3</sup>	Low engine oil level. Check and remedy as soon as possible. See page 169 for more information.
OIL LEVEL LOW <sup>2</sup> – STOP SAFELY <sup>3</sup>	Low engine oil level. Stop the car safely and check the oil level. See page 169.
OIL LEVEL LOW <sup>2</sup> – STOP ENGINE <sup>3</sup>	Low engine oil level. Stop the car safely, switch off the engine and check the oil level. See page 169.
OIL LEVEL LOW <sup>2</sup> – SEE MANUAL <sup>3</sup>	Low engine oil level. Stop the car safely, switch off the engine and check the oil level. See page 169.
SOOT FILTER FULL – SEE MANUAL <sup>1</sup>	Diesel particle filter requires regeneration. See page 115.

1. Displayed together with yellow warning triangle.
2. Displayed together with red warning triangle.
3. Only applies to engine variants with oil level sensor.

## Switches in the centre console

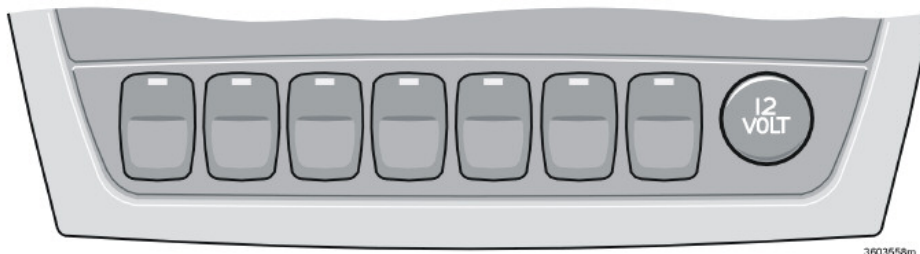

**NOTE!** The order of the buttons may vary.

### Active chassis, Four-C (option)



Press the button to select chassis setting Comfort or Sport, see page 124. The information display shows the current setting for 10 seconds.

### BLIS (Blind Spot Information System) (option)



Press the button to deactivate or reactivate the function. See page 144 for further information.

### STC/DTC system<sup>1</sup>



This button is used to reduce or reactivate the functions of the STC/DTC system.

When the LED in the button is lit, the STC/DTC system is activated (assuming there is no fault).



**NOTE!** Hold the button depressed for at least half a second to reduce the function

of the STC/DTC system. The LED in the button goes out and the text "STC/DTC SPIN CONTROL OFF" is shown in the display.

Deactivate the system if you must use a wheel with different dimensions.

The STC/DTC system is reactivated when the engine is restarted.

### **WARNING!**

Keep in mind that car's driving characteristics may change if you deactivate the STC/DTC system.

1. Option in certain markets. Standard on V70 R.

## Switches in the centre console

### Child safety locks in the rear doors (option)



Use this button to activate or deactivate the electric child safety locks in the rear doors. The ignition key must be in position **I** or **II**. When the child safety locks are

activated, the LED in the button lights. A message is shown on the display when the child safety locks are activated or deactivated.

### Electric socket/Cigarette lighter (option)



The electric socket can be used for various 12 V accessories, e. g. mobile phone or a cooler box.

The ignition key must be at least in position **I** so that the

socket can supply power.

The cigarette lighter is activated by pressing in the button. Once the lighter has been heated, the button pops out again. Pull out the lighter to use it. For safety reasons, always keep the cover in place when the socket is not in use. Maximum current tap 10 A.

### Retractable power door mirrors (option)



This button is used to fold in the door mirrors if they are folded out or to fold them out if they are folded in.

Do as follows if a door mirror has been accidentally folded

in or out:

- Manually fold the door mirror forward as far as possible.
- Turn the ignition key to position **II**.
- Fold the door mirror inward and then outward using the button. The door mirrors have now returned to their original fixed positions.

### Parking assistance (option)



The system is always activated when the car is started. Press the button to deactivate/reactivate parking assistance. See also page 126.

### Deactivation of the deadlocks and detectors



Use this button when you wish to switch off the deadlock function (doors cannot be opened from the inside when locked). This button can also be used when

deactivating the alarm system movement and tilt detectors<sup>1</sup> – e.g. when transporting the car by ferry. The LED lights when the functions are deactivated.

### Auxiliary lamps (accessory)



Use this button if you want the auxiliary lamps of the car to light together with the main beam or to deactivate this function. The LED in the button is lit when the function is active.

1. Option

## Switches in the centre console

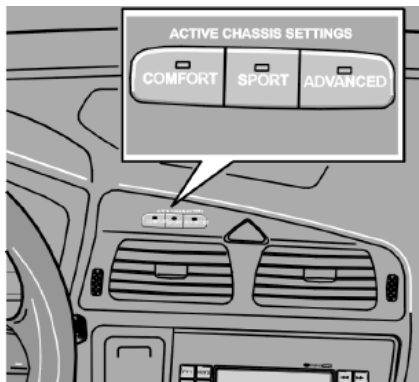

### Active chassis, Four-C (V70 R)

Press one of the buttons to select Comfort, Sport or Advanced mode. For further information, see page 124.

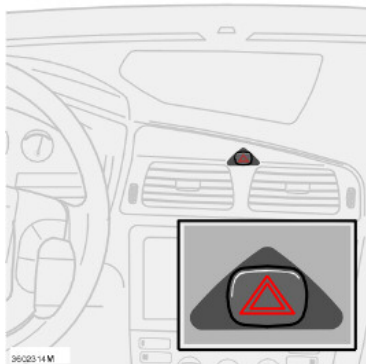

### Hazard warning flashers

Use the hazard warning flashers (all direction indicators flash) when the car is stopped where it could be a traffic hazard or obstruction. Press the button to activate the function.

**NOTE!** Regulations regarding the use of hazard warning flashers vary from country to country.

### Door mirror and rear window defrosters

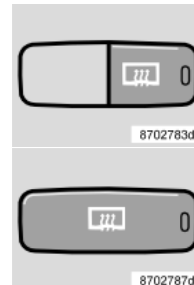

Use the defroster to remove ice and misting from the rear window and door mirrors. Press the switch to start defrosting the rear window and door mirrors. The LED in the switch comes on. Defrosting is automatically disconnected after about 12 minutes.

### Heated front seats

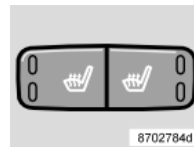

See page 68 or page 71 for further information.

## Lighting panel

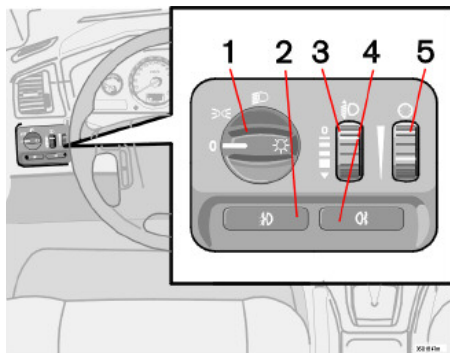

### Headlamp levelling

The load in the car changes the vertical alignment of the headlamp beam, which could dazzle oncoming motorists. Avoid this by adjusting the height of the beam.

- Turn the ignition key to position **II**.
- Turn the headlamp control (1) to one of the end positions.
- Roll the control up or down (3) to raise or lower beam alignment.

Cars with Bi-Xenon headlamps<sup>1</sup> have automatic headlamp levelling, so there is no control (3).

1. Option.

### Position/parking lamps

The position lamps/parking lamps can be switched on irrespective of ignition key position.

- Turn the headlamp control (1) to the centre position.

In ignition key position **II** the position lamps/parking lamps are always on. The number plate lighting is switched on at the same time as the position lamps/parking lamps.

### Headlamps

#### Automatic dipped beam

Dipped beam comes on automatically when the ignition key is turned to position **II**, except when the headlamp control (1) is in the centre position. If necessary the automatic dipped beam can be deactivated by an authorised Volvo workshop.

#### Manual dipped beam (certain countries)

- Turn the ignition key to position **II**.
- Turn the headlamp control (1) clockwise to the end position.

#### Main beam

- Turn the ignition key to position **II**.
- Turn the headlamp control (1) clockwise to the end position.
- Move the left-hand stalk switch towards the steering wheel to the end position and release it, see page 50.

### Fog lamp

**NOTE!** Regulations for use of fog lamps vary from country to country.

#### Front fog lamps (option)

The front fog lamps can be switched on along with the headlamps or the position lamps/parking lamps.

- Press the button (2).

The LED in the button (2) lights when the front fog lamps are switched on.

#### Rear fog lamp

The rear fog lamp can only be switched on with the headlamps or the front fog lamps.

- Press the button (4).

The rear fog lamp indicator symbol in the combined instrument panel and the LED in the button (4) come on when the rear fog lamp is switched on.

### Instrument lighting

The instrument lighting is switched on when the ignition key is in position **II** and the headlamp control (1) is in one of the end positions. The lighting is automatically dimmed during the day and can be controlled manually at night.

- Roll the control up or down (5) for brighter or dimmer lighting.

### Left-hand stalk switch

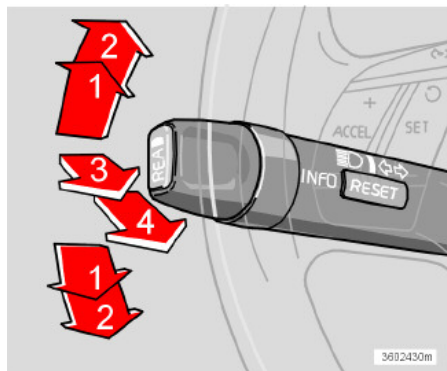

#### Stalk switch positions

1. Short flash sequence, direction indicators
2. Continuous flash sequence, direction indicators
3. Main beam flash
4. Switching, main and dipped beam, and home safe lighting

#### Direction indicators

##### Continuous flash sequence

- Move the stalk switch up or down to end position (2).

The stalk switch remains in its end position and is moved back manually, or automatically by steering wheel movement.

##### Short flash sequence

- Move the stalk switch up or down to position (1) and release.

When the stalk switch is released it returns to its start position and the direction indicators are switched off.

#### Switching, main and dipped beam

The ignition key must be in position II for main beam to be switched on.

- Turn the headlamp control clockwise to the end position, see page 49.
- Move the stalk switch towards the steering wheel to the end position (4) and release.

#### Main beam flash

- Move the stalk switch gently towards the steering wheel to position (3).

Main beam comes on until the stalk switch is released.

#### Home safe lighting



Some of the exterior lighting can be kept switched on and works as home safe lighting after the car has been locked. The time delay is 30 seconds<sup>1</sup>, but can be changed to 60 or 90 seconds by an authorised Volvo workshop.

1. Factory settings.

- Remove the key from the ignition switch.
- Move the stalk switch towards the steering wheel to the end position (4) and release.
- Get out of the car and lock the door.

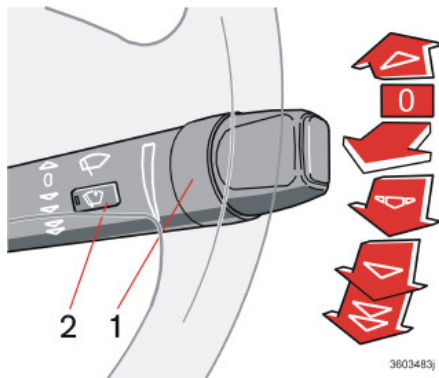
## Right-hand stalk switch



-  The wipers sweep at normal speed.
-  The wipers sweep at high speed.

### IMPORTANT!

Use plenty of washer fluid when the wipers are cleaning the windscreen. The windscreen must be wet when the windscreen wipers are operating.

## Windscreen wipers

**0** The windscreen wipers are turned off when the stalk switch is in position **0**.

 If the stalk switch is moved upwards, the wipers swipe one stroke at a time for as long as the stalk switch is held up.

## Intermittent wiping

 You can adjust and set a suitable speed for intermittent wiping. Rotate the ring (1) clockwise to increase wiper stroke frequency. Rotate the ring anticlockwise to decrease wiper stroke frequency.

## Rain sensor (option)

The rain sensor automatically activates the windscreen wipers based on how much water it detects on the windscreen. The sensitivity of the rain sensor can be adjusted using the ring (1).

- Turn the ring clockwise to increase sensitivity or anticlockwise to decrease sensitivity, (there is an extra swipe when the ring is turned clockwise).

## On/Off

When activating the rain sensor, the ignition key must be in position **I** or **II** and the windscreen wiper stalk switch must be in position **0**.

To activate the rain sensor:

- press the button (2). An LED in the button comes on to indicate that the rain sensor is active.

To turn the rain sensor off, either:

- press the button (2) or
- press the stalk switch downward to another wiper programme. If the stalk switch is raised, the rain sensor will remain active, the wipers make an extra sweep and then return to rain sensor mode when the stalk switch is released back to position **0**.

The rain sensor is automatically deactivated when the key is removed from the ignition switch or five minutes after the ignition is switched off.

### IMPORTANT!

In an automatic car wash:  
Turn off the rain sensor by pressing button (2) while the ignition key is in position **I** or **II**. Otherwise, the windscreen wipers may start and be damaged.

## Windscreen washer

Pull the lever towards the steering wheel to activate the windscreen washer.

## Headlamp washer

(option on certain markets)

Use of the windscreen washer automatically activates the headlamp washer.



### Right-hand stalk switch

High-pressure wash of the headlamps consumes a great deal of washer fluid. To save fluid, the headlamps are only washed every fifth time (within a ten minute period). If ten minutes have elapsed since the last windscreen washing, the headlamps receive a high-pressure wash the next time the windscreen is washed.

### Reduced washing

If only approx. one litre of washer fluid remains in the reservoir, the supply to the headlamps is cut off in order to prioritise cleaning of the windscreen.

### Windscreen washer and headlamp washer (V70 R)

Pull the lever toward the steering wheel to start the windscreen and headlamp washers.

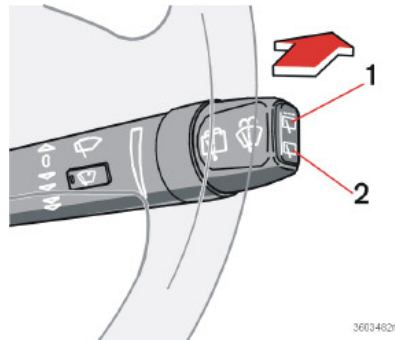

*Wiper/washer function – rear window.*

### Rear window washer and wiper

Move the lever forward to start the rear window washer.

1. Rear window wiper – intermittent wiping
2. Rear window wiper – normal speed

### Wiper - reversing

If you put the car in reverse when the windscreen wiper is engaged, the rear window wiper will be set to intermittent mode<sup>1</sup>. If the rear window wiper is already set to normal speed, this function will not be altered.

- 
1. This function – intermittent wiping when reversing – can be deactivated. Contact an authorised Volvo workshop.

## Trip computer

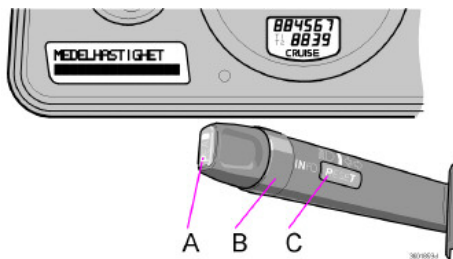

### Controls

To access the trip computer information, you must turn the ring (B) in steps, either forward or backward. By turning again, you return to the starting point.

**NOTE!** If a warning message interrupts while you are using the trip computer, you must first acknowledge the message by pressing the READ button (A) to return to the trip computer.

### Functions

The trip computer displays the following information:

- Average speed
- Speed in miles per hour<sup>1</sup>
- Current fuel consumption
- Average fuel consumption
- Range to empty fuel tank

#### Average speed

The average speed since the last reset (RESET). When the ignition is switched off, the average speed is stored and used as the basis of the new value when you continue driving. This can be reset with the RESET button (C) on the lever.

#### Speed in miles per hour<sup>1</sup>

Current speed is displayed in mph.

#### Current fuel consumption

Continuous information on current fuel consumption, calculated each second. The figure in the display is updated every couple of seconds. When the car is stationary, "----" is shown in the display.

**NOTE!** There may be a slight error in the reading if a fuel-driven heater is used.

#### Average fuel consumption

The average fuel consumption since the last reset (RESET). The average fuel consumption is stored when the ignition is switched off and remains until reset with the RESET button (C) on the lever.

**NOTE!** There may be a slight error in the reading if a fuel-driven heater is used.

#### Range to empty fuel tank

The range to empty is calculated based on the average fuel consumption over the last 30 km. When the range to empty is shorter than 20 km then "----" is shown in the display.

**NOTE!** There may be a slight error in the reading if fuel consumption is changed due to a change in driving style or if a fuel-driven heater is used for example.

1. Certain countries

## Cruise control (option)

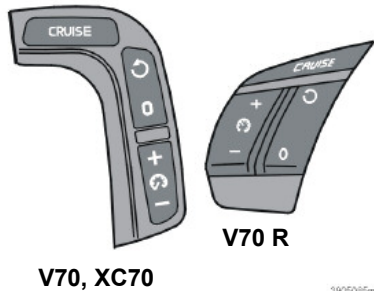

### Increasing or decreasing speed

- Increase or decrease the speed by pressing and holding **+** or **-**. The speed of the car when the button is released is set as the new speed.
- A brief press (less than half a second) on **+** or **-** changes the speed by one km/h.

**NOTE!** A temporary increase in speed (less than one minute) using the accelerator, such as while overtaking, does not affect the cruise control setting. When you release the accelerator, the car will return to the programmed speed.

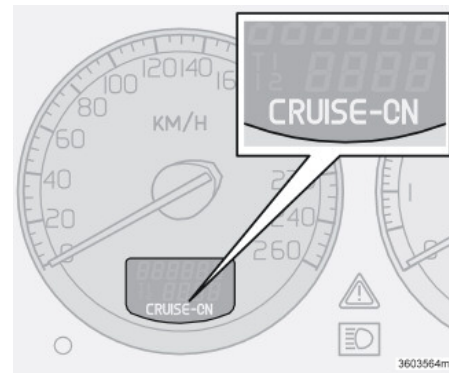

### Activating

The controls for cruise control are to the left of the steering wheel.

Setting the desired speed:

- Press the **CRUISE** button. **CRUISE** is shown on the combined instrument panel.
- Touch **+** or **-** to lock the vehicle speed. **CRUISE-ON** appears on the combined instrument panel.

Cruise control cannot be engaged at speeds below 30 km/h or above 200 km/h.

### Temporary disengagement

Press **0** to disengage the cruise control temporarily. **CRUISE** will be shown on the combined instrument panel. The speed set earlier is stored in the memory.

The cruise control is also temporarily disengaged when:

- The brake pedal or clutch pedal is depressed.
- Speed falls below 30 km/h when travelling uphill.
- The gear selector is moved to position **N**.
- Wheel spin or wheel lock-up occurs.
- A temporary increase in speed lasts longer than one minute.

---

## Cruise control (option)

### Return to the set speed



Press this button to resume the previously set speed. CRUISE-ON appears on the combined instrument panel.

### Disengaging

Press CRUISE to disengage the cruise control. CRUISE-ON goes out on the combined instrument panel.

### Parking brake, electric socket/cigarette lighter

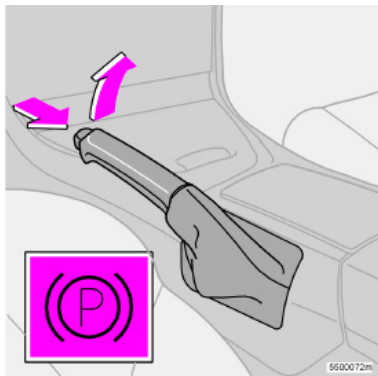

#### Parking brake (handbrake)

The lever is located between the front seats. The parking brake operates on the rear wheels when it is applied. The warning symbol in the combined instrument panel comes on when the parking brake is applied. Always pull the lever up to its top position.

**NOTE!** The lamp comes on as soon as the parking brake lever is pulled to position (notch) one.

#### Apply the parking brake:

- Press the foot brake down firmly.
- Pull the parking brake lever up to its top position.

- Release the foot brake and make sure that the car is stationary.
- Move the gear selector into position:  
**1** for manual gearbox  
**P** for automatic transmission.

#### Parking on a hill:

- If the car is parked uphill, turn the wheels away from the kerb.
- If the car is parked downhill, turn the wheels toward the kerb.

#### Release the parking brake:

- Press the foot brake down firmly.
- Pull the parking brake lever up slightly, press the button, release the parking brake lever and release the button.



#### Electric socket/socket for cigarette lighter

The cover should always be in position if the socket is not in use as a power source or as a cigarette lighter socket.

## Parking brake, electric socket/cigarette lighter

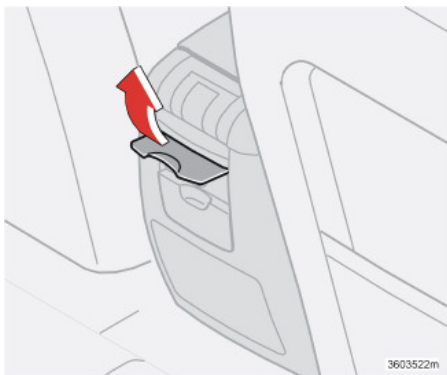

### Electric socket/cigarette lighter, rear seat

The electric socket can be used for various 12 V accessories, such as a mobile phone or a cooler box. Maximum current tap 10 A.

The ignition key must be at least in position **I** so that the socket can supply power.

The cigarette lighter is activated by pushing in the button. Once the lighter has been heated, the button pops out again. Pull out the lighter to use it.

For reasons of safety, always keep the cover in place when the socket is not in use.

## Steering wheel adjustment

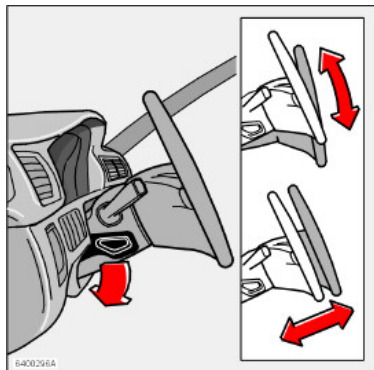

The steering wheel can be adjusted both vertically and front-rear. Press down the control on the left-hand side of the steering column. Then adjust the steering wheel to the position that suits you best. Press the control back into place to lock the steering wheel. If this is difficult, press the steering wheel slightly while pressing the control back.

**⚠ WARNING!**

Adjust the steering wheel before driving, never while driving. Ensure that the steering wheel is locked.

## Power windows

The power windows are operated using the controls in the door armrests. The ignition key must be turned to position **I** or position **II** for the power windows to work. Once you finish driving and remove the ignition key, the windows can still be opened or closed as long as the front doors remain closed.

Open a window by depressing the front of the control, and close it by pulling up the front of the control.

### **WARNING!**

Make sure that children's or other passengers' hands are clear when closing the windows by remote control.

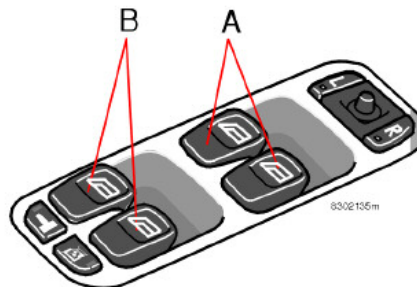

### Power windows in the front doors

Windows can be opened or closed from the front seat two ways.

- Press the control (A) gently downward or pull it gently upward. The power windows are raised or lowered as long as you hold the control.
- Press the control (A) all the way down or pull it all the way up, and then release. The windows then open or close automatically. Movement is stopped if the window is blocked in any way.

**NOTE!** The function auto up for the passenger side is only available in certain markets.

Controls (B) to operate windows in the rear doors.

### **WARNING!**

If there are children in the car: Remember to switch off the supply to the power windows by removing the ignition key if the driver leaves the car. Make sure that children's and other passengers' hands are clear when closing the windows. If the rear door windows are operated from the driver's door: Check that none of the rear seat passengers are in danger of getting their hands caught when closing the windows.



### Power windows

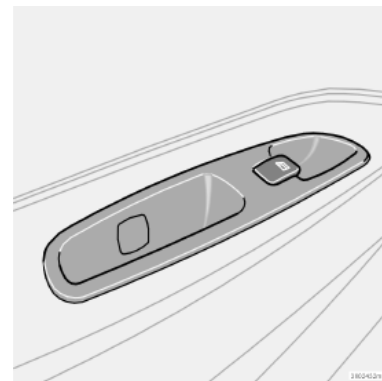
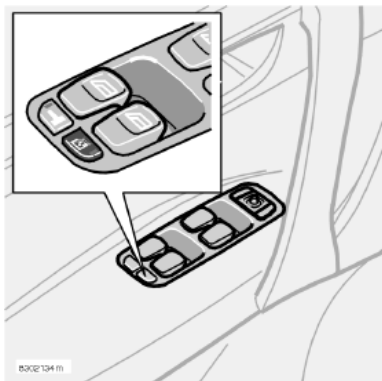

#### **Blocking power windows in the rear doors**

The rear power windows can be blocked using the switch on the driver's door control panel.

The LED in the switch is unlit

The rear door windows can be operated both with the control on each rear door and with the controls on the driver's door.

The LED in the switch is lit

The rear door windows can only be operated from the driver's door.

#### **Power window in the front passenger seat**

The control for the power window at the front passenger seat operates that window only.

#### **Power windows in the rear doors**

The rear door windows can be operated with the controls on the doors and the switch on the driver's door. If the LED in the switch for blocking power windows in the rear doors (located in the driver's door control panel) is lit, the rear door windows can only be operated from the driver's door.

## Rearview mirror, door mirrors and side windows

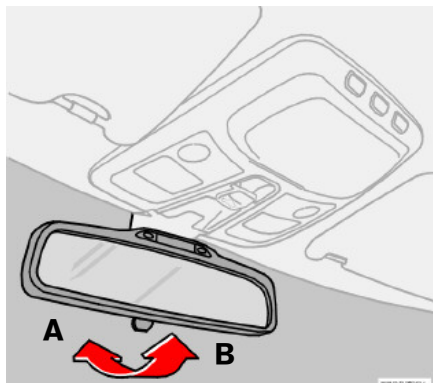

### Interior rearview mirror

A: normal position.

B: dimming position. Use this if the glow from car headlamps behind irritate causes irritation.

Certain models have an auto-dim. Dimming occurs automatically based on comparative light relationships. An authorised Volvo workshop can adjust the sensitivity.

### Seatbelt reminder

The seatbelt warning symbol remains lit in the top edge of the rearview mirror until the driver buckles up.

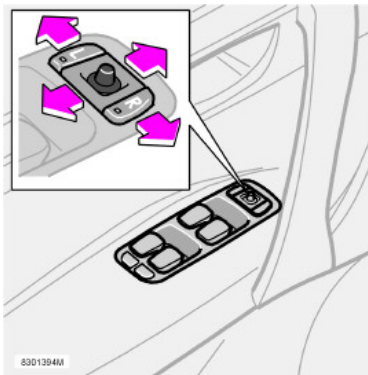

### Door mirrors

The controls for adjusting the two door mirrors are at the front of the driver's door armrest.

Press the **L** or **R** button (**L** = left door mirror, **R** = right door mirror). The LED in the button lights.

Adjust the position with the adjustment control in the centre. Press the button again. The LED should no longer be lit.



### **WARNING!**

Adjust the mirrors before you begin driving!

### **IMPORTANT!**

Use the defroster (see page 48) to remove ice from the mirrors, not an ice scraper. The scraper could scratch the mirror glass.

### Door mirrors with memory function (option)

If the car has door mirrors with memory function, they work together with the memory setting of the seat, see page 79.

**NOTE!** The above applies only if your Volvo is equipped with a driver's power seat.

### Memory function in the remote control (option)

When you unlock the car with one of the remote controls and change the setting of the door mirrors, these new settings are saved in the remote control. The next time you unlock the car with the same remote control and open the driver's door within five minutes, the mirrors will assume their stored positions.

### Laminated side windows (option)

The laminated windows in the front and rear doors improve sound insulation in the passenger compartment and provide better protection against unauthorised entry.

## Rearview mirror, door mirrors and side windows

### Water and dirt-repellent coating on the front windows and/or door mirrors (option)

The front windows and/or door mirrors are treated with a coating that ensures that the view through the windows or in the mirrors is good even if it is raining. For information on glass care, see page 159.



Side windows and mirrors treated with the water and/or dirt-repellent coating are marked with a small symbol.

### IMPORTANT!

Do not use a metal ice scraper to remove ice from the windows. The water and dirt-repellent coating could be damaged. Use the defroster to remove ice from the mirrors!

### Rearview and door mirrors

In certain weather conditions, the function of the dirt-repellent coating is improved if the door mirror defroster is used, see page 48.

Defrost the door mirrors:

- If they are covered with ice or snow.
- In heavy rain and dirty road conditions.
- If they are misted.

## Power sunroof (option)

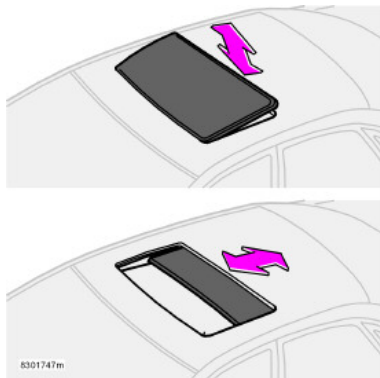

### WARNING!

If there are children in the car:  
Remember to switch off the supply to the sunroof (remove the ignition key) if the driver leaves the car.

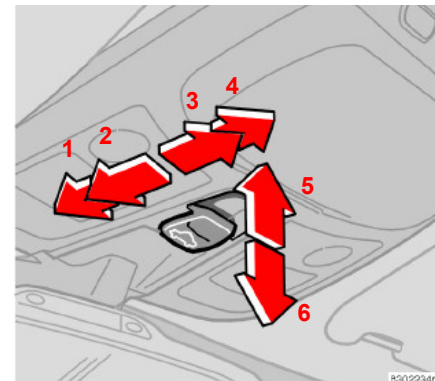

## Open positions

Sunroof controls are located in the headlining. The sunroof can be operated in two different ways:

- Raise/lower trailing edge – ventilation position.
- Rearwards/forwards – opening position/comfort position<sup>1</sup>.

The ignition key must be in position **I** or **II**.

1. In comfort position, the sunroof is not completely open in order to reduce the level of wind noise.

1. Closing, automatic
2. Closing, manual
3. Opening, manual
4. Opening, automatic
5. Opening, ventilation position
6. Closing, ventilation position

### Ventilation position

Open: Press the rear edge of the control (5) upward.

Close: Pull the rear edge of the control (6) downward.

Switch from ventilation position to comfort position: pull the control rearwards to its end position (4) and release.

### Power sunroof (option)

#### Automatic operation

Move the control over the resistance point position (3) to the rearmost end position (4) or over the resistance point position (2) to the front end position (1) and release. The sunroof will open to the comfort position or will close completely.

In order to open from comfort position to maximum opening: Pull the control rearward to the rear once more to the end position (4) and release.

#### Manual operation

Open: Pull the control rearward to the point of resistance (3). The sunroof moves toward the fully open position as long as the button is held in this position.

Close: Press the control forwards to the resistance point (2). The sunroof will move towards its closing position as long as the switch is held in this position.

#### **WARNING!**

If you have children in the car, make sure that their hands are clear when closing the sunroof.

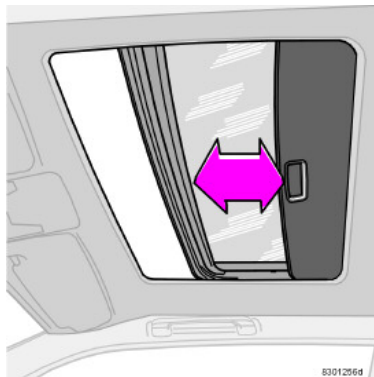

#### **WARNING!**

Pinch protection functions only in the opening position – not in ventilation position.

Make sure children's hands are clear when closing the sunroof.

### Sunscreen

The sunroof features a manual, sliding interior sunscreen. The sunscreen slides back automatically when the sunroof is opened. Grip the handle and slide the screen forwards to close the screen.

### Pinch protection

The sunroof's pinch protection function is activated if the hatch is blocked by an object. If blocked, the sunroof will stop and automatically open to the previous position.

---

## **Climate control**

<b>General information on climate control</b>	<b>66</b>
<b>Manual climate control with air conditioning (AC)</b>	<b>68</b>
<b>Electronic Climate Control (ECC)</b>	<b>70</b>
<b>Air distribution</b>	<b>73</b>
<b>Fuel-driven parking heater (option)</b>	<b>74</b>

### General information on climate control

#### Misting windows

Reduce the problem of windows misting up on the inside by cleaning the windows. Use a regular window cleaner.

#### Particle filter

Make sure the particle filter is replaced regularly. Consult an authorised Volvo workshop.

#### Ice and snow

Remove ice and snow from the climate control air intake (the grille between the bonnet and the windscreen).

#### Fault tracing

An authorised Volvo workshop has the instruments and tools required for any fault tracing or repair of your climate control system. Entrust checks and repairs only to trained personnel.

#### Refrigerant

The air conditioning system contains R134a refrigerant. This refrigerant contains no chlorine, which means that it is harmless to the ozone layer. The system must only be charged with R134a refrigerant. Have an authorised Volvo workshop carry out this work.

#### Ventilation fan function

When the engine is off (and if the ignition key is in position **I** or **II**), the ventilation fan is automatically switched off. This is to prevent the battery from becoming discharged.

To activate the ventilation fan, turn the fan control and set the desired speed.

#### Cars with ECC

##### Actual temperature

The temperature you select corresponds to the physical experience with reference to air speed, humidity, exposure to sun, etc. which affect the interior and exterior of the car.

##### Sensors

The sun sensor is on the upper portion of the dashboard. Remember not to cover it. Do not cover the passenger compartment temperature sensor on the climate control panel.

##### Side windows and sunroof

To ensure that the air conditioning works satisfactorily, close all side windows and the sunroof (if fitted). Also, make sure the air ducts in the parcel shelf are not blocked.

##### Acceleration

The air conditioning system switches off temporarily at full acceleration. You may feel a temporary rise in temperature.

#### Condensation

In warm weather, condensation from the air conditioning system may drip under the car. This is normal.

#### Fuel economy

With ECC, the air conditioning system is controlled automatically and is used just enough to cool the passenger compartment and dehumidify the incoming air. This provides better fuel economy compared to conventional systems where the air conditioning cools the air to just above freezing point.

## General information on climate control

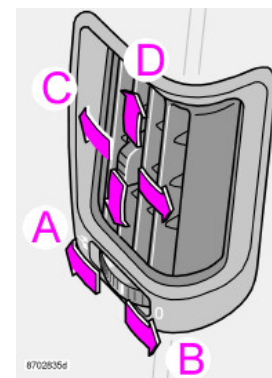
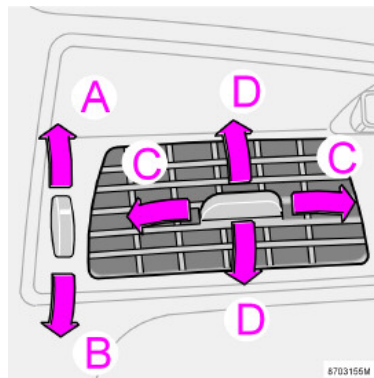
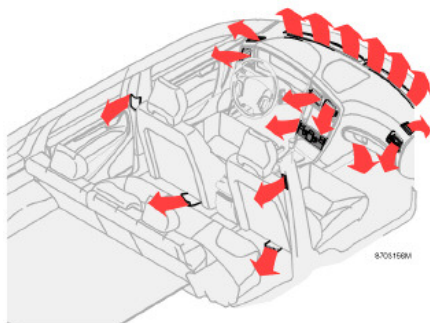

### Air distribution

Incoming air is distributed through several different vents located throughout the car.

### Air vents in the dashboard

- A. Open
- B. Closed
- C. Lateral airflow
- D. Vertical airflow
- Aim the outer vents outwards to remove misting from the front side windows.

### Air vents in the door pillars

- A. Open
  - B. Closed
  - C. Lateral airflow
  - D. Vertical airflow
  - Aim the vents toward the rear side windows to remove misting.
  - Aim the vents inwards in the car for a comfortable climate in the rear seat.
- Bear in mind that small children can be sensitive to airflow and draughts.



## Manual climate control with air conditioning (AC)

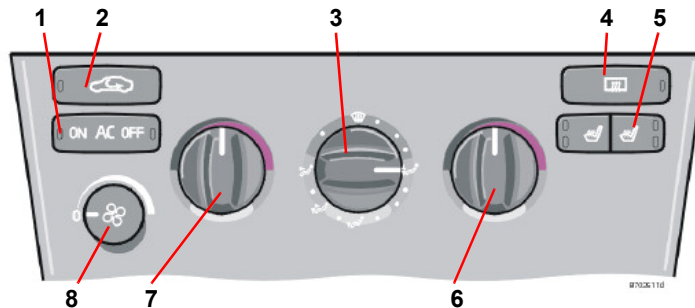

1. AC – ON/OFF
2. Recirculation
3. Air distribution
4. Rear window and door mirror defroster
5. Heated front seats
6. Heating/Cooling – right-hand side
7. Heating/Cooling – left-hand side
8. Fan

You must turn the fan knob (8) from the 0 position to connect the air conditioning.

Use the air conditioning at low temperatures as well (0 15 °C) to dehumidify incoming air.

### AC - ON/OFF



The air conditioning is connected to the cooling and dehumidification function when the ON LED lights. The air conditioning is disconnected when the OFF LED lights.

### Heating/Cooling - left/right-hand side

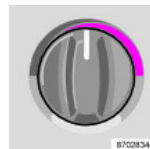

Turn to set how warm or cold the incoming air shall be. For cooler air, the air conditioning must be engaged.

### Heated front seats

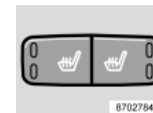

Do as follows for heated front seat(s):

- Press once: High heat – both LEDs in the switch light up.
- Press twice: Low heat – one LED in the switch lights up.
- Press three times: Heating switched off – no LEDs in the switch light up.

An authorised Volvo workshop can adjust the temperature.

## Manual climate control with air conditioning (AC)

### Fan



Fan speed can be increased or decreased by turning the knob. If the knob is set to **0** then the air conditioning is not engaged.

### Rear window and door mirror defrosters



Use this button to quickly remove misting and ice from the rear window and door mirrors, see page 48 for further information about this function.

### Recirculation

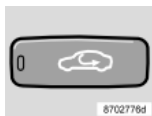



Recirculation can be used to shut out bad air, exhaust, etc. from the passenger compartment. The air in the passenger compartment is then recirculated, i.e. no air

from outside the car is taken into the car when this function is activated. Recirculation (together with the air conditioning system) cools the passenger compartment more quickly in a warm climate.

If you allow the air in the car to recirculate, there is a risk of icing and misting, especially in winter. The timer function minimises the risk of ice, misting and bad air.

Activate the function as follows:

- Press  for more than 3 seconds. The LED flashes for 5 seconds. The air recirculates in the car for 3-12 minutes depending on the outside temperature.
- The timer function is activated each time you press .

To switch off the timer function:

- Press  again for more than 3 seconds. The LED lights for 5 seconds to confirm your selection.

### Air distribution

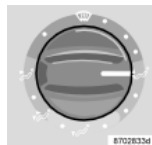

Use the air distribution control positions (marked with dots) between the different symbols to fine-tune air distribution for maximum comfort.

### Defroster

The defroster  on the air distribution control is used to quickly remove misting and ice from the windscreen and side windows. Air flows to the windows at high speed.

When the function is selected the following also takes place to provide maximum dehumidification of the air in the passenger compartment:

- the air conditioning (AC) is automatically engaged (if the fan is not in position **0**)
- recirculation is automatically disengaged.

When the defroster  is switched off the climate control returns to the previous settings.

## Electronic Climate Control (ECC)

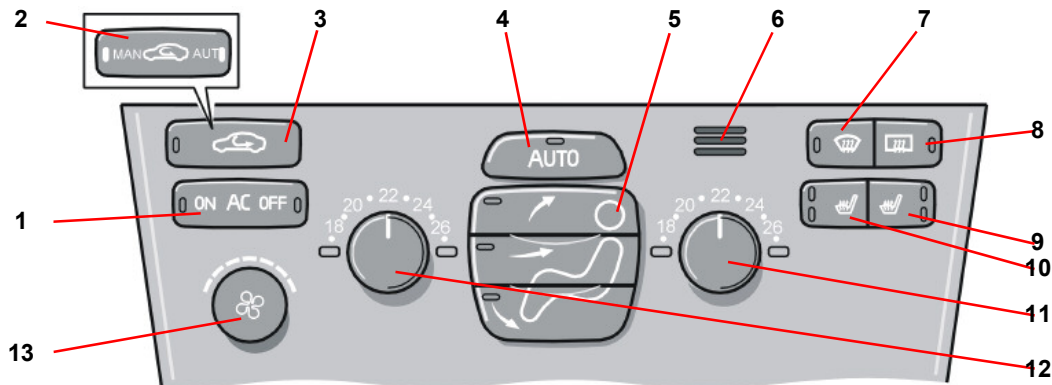

1. AC - ON/OFF
2. Recirculation/Multifilter with sensor
3. Recirculation
4. AUTO
5. Air distribution
6. Passenger compartment temperature sensor
7. Defroster, windscreen and side windows
8. Rear window and door mirror defroster
9. Seat heater - right-hand side
10. Seat heater - left-hand side
11. Temperature - right-hand side
12. Temperature - left-hand side
13. Fan

### AUTO



AUTO function automatically regulates climate control so that the desired temperature is attained. The automatic function controls heating, air conditioning, air quality sensor, fan speed, recirculation, and air distribution. If you select one or more functions manually, the other functions continue operating automatically. All manual settings are switched off when AUTO is pressed.

### Temperature



The two knobs can be used to set the temperature for the passenger and driver's sides of the car. Remember that the car does not heat up or cool down any more quickly even if you select a higher or lower temperature than you want in the passenger compartment.

### Fan

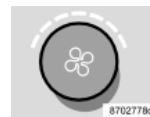

Fan speed can be increased or decreased by turning the knob. If AUTO is selected, fan speed is controlled

## Electronic Climate Control (ECC)

automatically. The previously set fan speed is disconnected.

**NOTE!** If the knob for the fan has been turned so far that the left LED above the knob lights up with an orange light, the fan and the air conditioning system are switched off.

### Rear window and door mirror defrosters

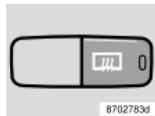

Use this button to quickly remove misting and ice from the rear window and door mirrors, see page 48 for further information about this function.

### Defroster, windscreen and side windows

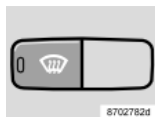

Used to quickly remove misting and ice from the windscreen and side windows. Air flows to the windows at high speed. The

LED in the defroster button comes on when this function is engaged.

When the function is selected the following also takes place to provide maximum dehumidification of the air in the passenger compartment:

- the air conditioning (AC) is automatically engaged (if the fan knob is in final anticlockwise position then the air conditioning is not engaged).
- recirculation is automatically disengaged.

When the defroster  is switched off the climate control returns to the previous settings.

### Air distribution



Air to windows

Air to head and body

Air to legs and feet

Press AUTO to return to automatic air distribution.

### AC - ON/OFF



The air conditioning system is controlled automatically by the system when the ON LED is lit. This way, incoming air is cooled and dehu-

midified sufficiently. When AC OFF is selected and the OFF LED comes on, the air conditioning system is always disengaged; other functions are still controlled automatically. The air conditioning system operates down to approximately 0 °C.

### Heated front seats

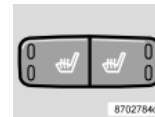

Do as follows for heated front seat(s):

- Press once: High heat – both LEDs in the switch light up.
- Press twice: Low heat – one LED in the switch lights up.
- Press three times: Heating switched off – no LEDs in the switch light up.

An authorised Volvo workshop can adjust the temperature.

### Recirculation





Recirculation can be used to shut out bad air, exhaust, etc. from the passenger compartment. The air in the passenger compartment is then recirculated, i.e. no air from outside the car is taken into the car when this function is activated.

If you allow the air in the car to recirculate, there is a risk of icing and misting, especially in winter.

The timer function (cars with Multifilter and air quality sensor have no timer function) minimises the risk for ice, misting and bad air.

### Electronic Climate Control (ECC)

Activate the function as follows:

- Press  for more than 3 seconds. The LED flashes for 5 seconds. The air recirculates in the car for 3–12 minutes depending on the outside temperature.
- The timer function is activated each time you press .

To switch off the timer function:

- Press  again for more than 3 seconds. The LED lights for 5 seconds to confirm your selection.

### Air quality system (option)



The air quality system consists of a multifilter and a sensor. The filter separates gases and particles, thereby reducing the volume of odours and pollutants enter-

ing the passenger compartment. When the sensor detects contaminated outside air, the air intake is closed and the air in the passenger compartment is recirculated.

When the air quality sensor is active, the green AUT LED lights in .

### Operation

Press  to activate the air quality sensor (normal setting).

Or:





Select one of the following three functions by pressing  repeatedly.

- The AUT LED lights. The air quality sensor is now activated.
- No LED lights. Recirculation is not activated unless needed to cool in a warm climate.
- The LED MAN lights. Recirculation is now activated.

### Keep in mind the following:

- Make it a rule to have the air quality sensor activated at all times.
- Recirculation is limited in cold weather to avoid misting.
- If misting occurs, you should deactivate the air quality sensor.
- If misting occurs, you can use the defroster functions for the windscreen, side windows and rear window, see page 71.
- Follow the Volvo service program for the recommended replacement interval of the Multifilter. If the car is used in environments where more contaminants are present, it may be necessary to change the Multifilter more often.

## Air distribution

Air distribution	Use
 <p>Air through front and rear air vents.</p>	<p>When you want good cooling in a warm climate.</p>
 <p>Air to windows. Air is not recirculated in this position. Air conditioning is always engaged. There is a certain amount of airflow to the air vents.</p>	<p>When you want to remove ice and misting. High fan speed is good for this.</p>
 <p>Air to both floor and windows. There is a certain amount of airflow to the air vents.</p>	<p>When you want comfortable conditions and good demisting in a cold climate. Not too low a fan speed.</p>
 <p>Air to floor. There is a certain amount of airflow to the air vents and the defroster vents for the windscreen and side windows.</p>	<p>When you want to warm your feet.</p>

Air distribution	Use
 <p>Air to floor and air vents.</p>	<p>In sunny weather with cool outside temperatures.</p>

## Fuel-driven parking heater (option)

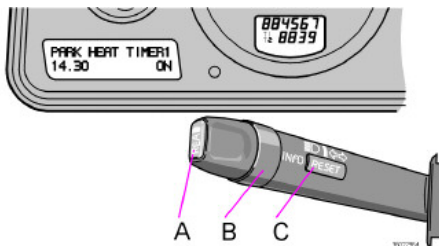

The car's electronic system calculates when heating should be started based on the outside temperature. If the outside temperature exceeds 25 °C, the heater does not switch on. At temperatures from 10 °C and below, the maximum running time of the parking heater is 60 minutes.

If the parking heater does not start despite repeated attempts, a message is shown in the display. Contact an authorised Volvo workshop.

### Messages on the display

Once the settings for TIMER 1, TIMER 2 and Direct Start are activated, the amber warning symbol in the combined instrument panel lights and explanatory text is shown in the display.

When you leave the car, you will receive a message regarding the current settings of the system.

### General

The electrical system must be "awakened" before the parking heater can be programmed.

This is most easily done by:

- pressing the READ button or
- pressing the main beam flash or
- turning on the ignition.

The parking heater can be started immediately or set with two different start times using TIMER 1 and TIMER 2. Start time refers to the time the car should be heated and ready.

#### **WARNING!**

- Switch off the fuel-driven heater before refuelling. Fuel that has been spilled on the ground could be ignited by the exhaust gases.
- Check the information display to ensure the heater is off (PARK HEAT ON is shown in the display when the parking heater is active).

#### **WARNING!**

The car must be outdoors when the petrol or diesel heater is used.

## Fuel-driven parking heater (option)

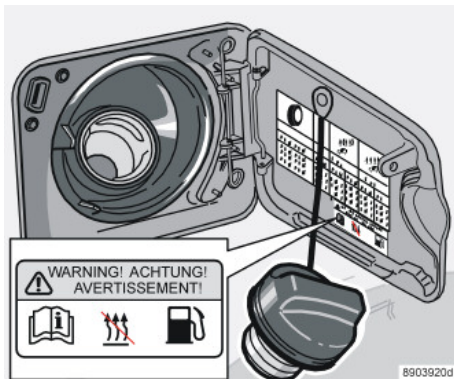

Warning decal on fuel filler flap.

### Parking on a hill

If you park your car on a steep incline, the front of the car should be facing up the slope to ensure the supply of fuel to the parking heater.

### Car clock/timer

For safety reasons, all timer settings will be cleared if the car clock is reset after timer settings have been made.

### Setting TIMER 1 and 2

For reasons of safety, you can only programme times for the following 24 hours, not several days in a row.

- Use the ring (B) to toggle to TIMER 1.
- Briefly press the RESET button (C) so that the hours setting starts to flash.
- Use the ring (B) to set the desired hours.
- Briefly press the RESET button so that the minutes setting starts to flash.
- Use the ring (B) to set the desired minutes.
- Briefly press the RESET button to confirm your setting.
- Press the RESET button to activate the timer.

After setting TIMER 1, toggle to TIMER 2. Settings are made the same way as for TIMER 1.

### Deactivating timer-started heating

Do as follows to manually switch off the heater before the set time has elapsed:

- Press the READ button (A).
- Use the ring (B) to toggle to PARK HEAT TIMER 1 (or 2). The text ON flashes.

- Press the RESET button (C). The text OFF is displayed with a steady glow and the heater is switched off.

### Direct start

- Use the ring (B) to toggle to DIRECT START.
- Press the RESET button (C) to access the ON or OFF options. Select ON.

The heater will now run for 60 minutes. Heating of the passenger compartment will begin as soon as the engine coolant has reached an adequate temperature.

### Deactivating heater after direct start

- Use the ring (B) to toggle to DIRECT START.
- Press the RESET button (C) to make ON and OFF selections available.
- Select OFF.

### Battery and fuel

If the battery is not sufficiently charged or the petrol tank is close to empty, the parking heater will be switched off.

If this is the case, a message will appear in the display. Acknowledge the message using the READ button (A).



## Fuel-driven parking heater (option)

### **IMPORTANT!**

Repeated use of the parking heater in combination with short trips can lead to battery discharge and thereby difficulty starting.

If the heater is used regularly, the car should be driven for the same amount of time as the heater was used in order to ensure that the generator is able to produce enough energy to compensate for the amount consumed.

### **Additional heater (diesel) (certain countries)**

Extra heat from the additional heater may be required in cold weather to reach the correct temperature in the passenger compartment.

The additional heater starts automatically when extra heat is required if the engine is running. It is switched off automatically when the correct temperature is reached or when the engine is switched off.

---

## Interior

<b>Front seats</b>	<b>78</b>
<b>Interior lighting</b>	<b>81</b>
<b>Storage spaces in the passenger compartment</b>	<b>83</b>
<b>Rear seat</b>	<b>88</b>
<b>Cargo compartment</b>	<b>93</b>

## Front seats



5. Backrest rake: turn the wheel.
6. Power seat control panel.

### **WARNING!**

- Adjust the position of the driver's seat before setting off, never while driving.
- Check that the seat is locked in position.

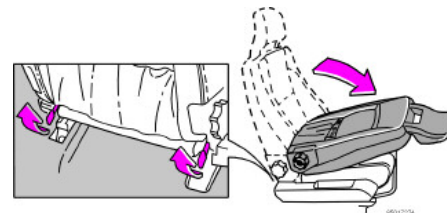

## Seating position

The driver's and passenger seats can be adjusted to the optimum sitting and driving positions

1. Forward/backward: lift the handle to adjust the distance to the steering wheel and pedals. Check that the seat is locked after changing position.
2. Raise/lower front edge of seat cushion: pump up/down<sup>1</sup>.
3. Raise/lower seat: pump up/down
4. Adjust lumbar support: turn the wheel.

## Lowering the front seat backrest

The passenger seat backrest can be folded forward to make room for long loads.

- Move the seat as far back as possible.
- Adjust the backrest to an upright position 90 degrees.
- Lift the catches on the rear of the backrest while folding it forwards.
- Slide the seat forward so that the head restraint is "locked in place" under the glovebox.

1. The control panel (2) is not available with certain upholstery alternatives.

## Front seats

### Power seat (option)

#### Preparations

The seat is usually adjusted when the ignition key is in position **I** or **II**. It can also be adjusted within 4.5 minutes of unlocking the door with the key or remote control. If the door is closed but the ignition key has not yet been inserted in the ignition switch or is in position **0** in the ignition switch, settings can be made within 40 seconds of closing the door.

#### Memory function in the remote control (option)

If the setting of the seat is changed, the new setting is saved in the remote control used to lock the car. The next time the car is unlocked using that remote control and the driver's door is opened within five minutes, the driver's seats and door mirrors assume the stored positions.

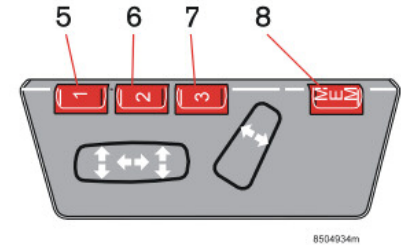
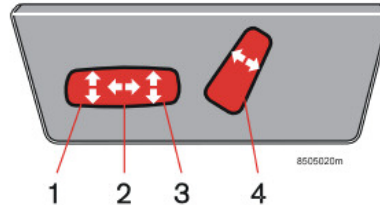

### Seat adjustment

The switches can be used to make the following adjustments:

1. Front edge of seat cushion up/down
2. Seat forward/rearward
3. Seat up/down
4. Backrest rake

The seat can be moved in one direction at a time. The power seats have an overload protector that activates if a seat is blocked by an object. If this occurs, switch off the ignition (position **0**) and wait 20 seconds before operating the seat again.

### Seat with memory function (option)

5. Setting seat and door mirrors, program 1
6. Setting seat and door mirrors, program 2
7. Setting seat and door mirrors, program 3
8. Storing preset positions

Three positions can be stored. After adjusting the seat, hold the MEM (8) button depressed while pressing the button (5). Further seat and door mirror settings can be stored using memory buttons (6) and (7).

### Front seats

#### Setting preset positions

Press and hold one of the memory buttons (5), (6) or (7) until the seat stops. If you release the button, the seat stops immediately for safety reasons.

#### Emergency stop

If the seat accidentally begins to move, press one of the buttons to stop the seat.

#### **WARNING!**

Ensure that there is nothing in front of, behind, or under the seat during adjustment. Ensure that none of the backseat passengers will be trapped. To avoid injury, ensure that children do not play with the switches.

## Interior lighting



### General lighting

General lighting is activated and deactivated by pressing the centre button. General lighting comes on automatically<sup>1</sup> and remains lit for 30 seconds:

- When you unlock the car from the outside using the key or remote control.
- When you have stopped the engine and turned the ignition key to position **0**.

General lighting switches on and remains lit for 10 minutes:

- one of the doors is open
- general lighting is not switched off.

1. The function is light-dependent and is only activated when it is dark.

General lighting switches off:

- the engine is started
- you lock the car from outside using the key or remote control.

Unless switched off manually, general lighting goes out automatically 10 minutes after the engine is switched off.

General lighting can be switched off or on in all situations by briefly pressing the button.

You can disconnect the automatic function by pressing the button for more than 3 seconds. When you then briefly press the button, the automatic function reconnects.

The pre-programmed times of 30 seconds and 10 minutes can be changed. Contact an authorised Volvo workshop.



### Reading lamps front and rear

Switch on the front seat or rear seat reading lamps with the corresponding button.

The lamps switch off automatically 10 minutes after the ignition has been turned off if not switched off manually.

### Interior lighting

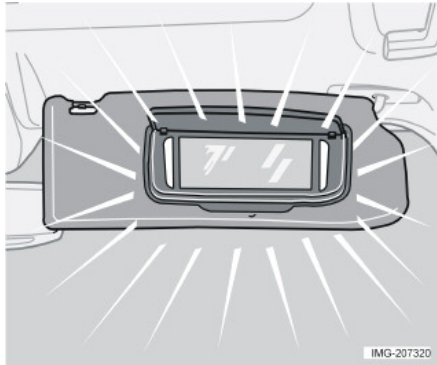

#### Vanity mirror<sup>1</sup>

The light comes on automatically when the cover is lifted.

---

1. Option for certain markets.

## Storage spaces in the passenger compartment

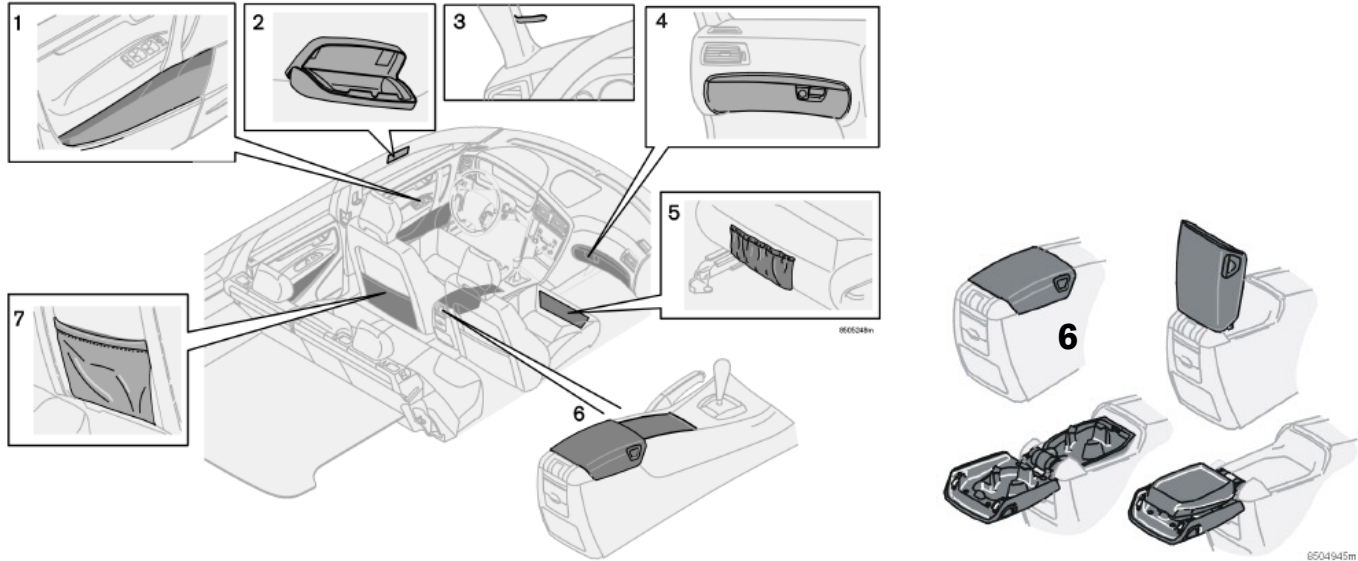

### Storage spaces

1. Compartment in door panel
2. Sunglasses compartment, driver's side (option)
3. Ticket clip
4. Glovebox
5. Storage pocket
6. Storage compartment in the centre console
7. Storage pocket

### **WARNING!**

Ensure that no hard, sharp or heavy objects lie or protrude in such a way that they could cause injury during heavy braking. Always secure large and heavy objects with a seatbelt or cargo retaining straps.



## Storage spaces in the passenger compartment

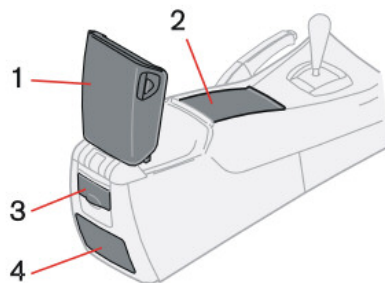

8504938m

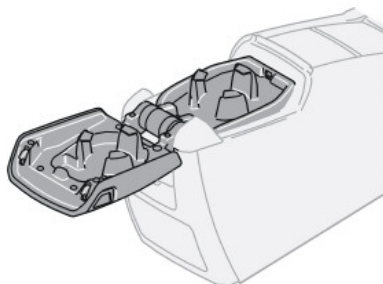

8504939m

### Storage compartment in centre console

#### 1. Rear storage compartment

The rear storage compartment of the centre console can be used to store CDs and the like. This storage compartment can be equipped with:

Privacy handset + holder (option)

#### 2. Front storage compartment (Roller cover)

This storage compartment can be equipped with the following options:

- Cup holder (option)
- Ashtray (option)

#### 3. 12 V socket

#### 4. Ashtray (option)

### Rear storage compartment cup holder for rear seat passengers

To access the storage compartment/privacy handset, press the button on the left-hand side of the armrest and fold the tunnel compartment cover back. To use the cup holder, press the button on the right-hand side of the armrest and fold the upper part of the tunnel compartment cover back. The cup holder and cover can be closed separately.

## Storage spaces in the passenger compartment

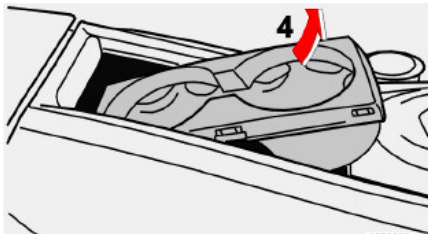
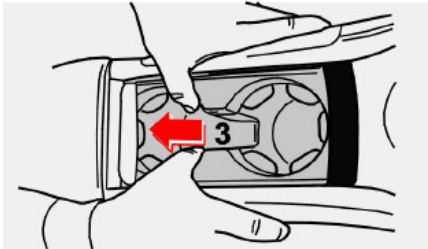
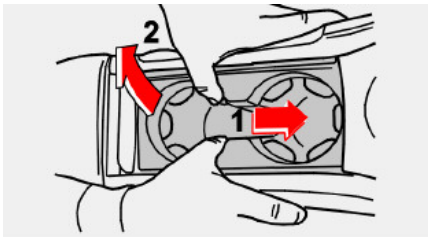

### Cup holder in front storage compartment (option)

The cup holder can be easily removed:

1. Press the cup holder forwards (1), while lifting it at the rear edge (2).
2. Push the cup holder back (3), into the cut-out, under the roller cover.
3. Angle the front edge (4) of the cup holder up and lift out.
4. Repeat the procedure in reverse order to refit the cup holder.

### Cup holder in front storage compartment XC70 (option)

The cup holder can be easily removed:

- Grip the cup holder at the rear and press in the rear wall to loosen it at the rear.
- Angle the rear edge of the cup holder up and lift out.

Repeat the procedure in reverse order to refit the cup holder.

**NOTE!** Make sure that the handbrake gaiter is not trapped.

## Storage spaces in the passenger compartment

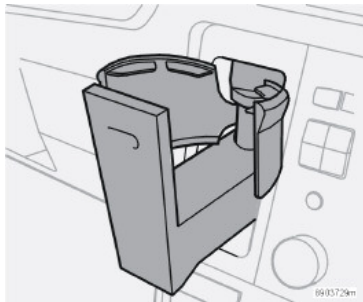

### Dashboard cup holder (option)

- Press the holder to open.
- Press the holder in after use.

**NOTE!** Never use glass bottles. Remember also that hot drinks may cause burns.

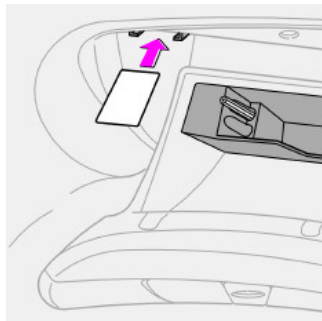

### Glovebox

The glovebox can be used to store things such as the owner's manual, maps, pens and petrol cards.

### Floor mats (option)

Volvo offers custom made floor mats for your car. They must be properly placed and secured in the mat clips in order that they not become entangled the pedals.

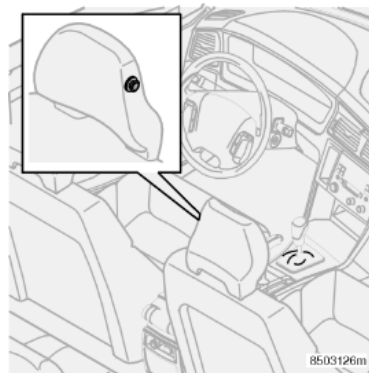

### Coat hanger

The coat hanger is only intended for light garments.

## Storage spaces in the passenger compartment

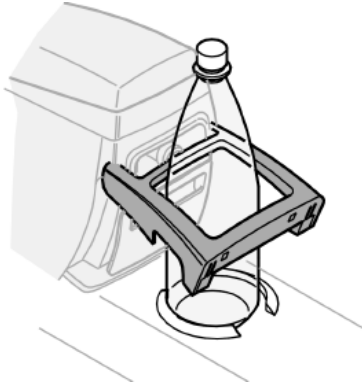

*Cup holder in armrest, rear seat (option).*

### **Bottle holder for rear seat passengers (option)**

Do as follows to use the bottle holder:

- Open the holder.
- Insert the bottle.

The bottle holder can also serve as a waste bin. Insert a bag into the holder and fold it over the edges.

**NOTE!** The bin does not require special bags. Use a regular plastic bag.

## Rear seat

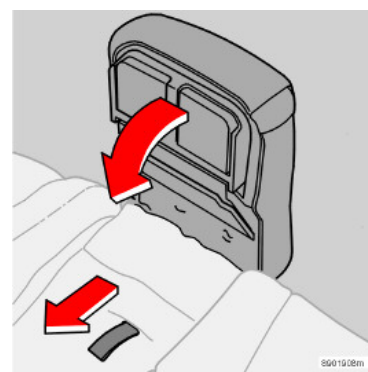
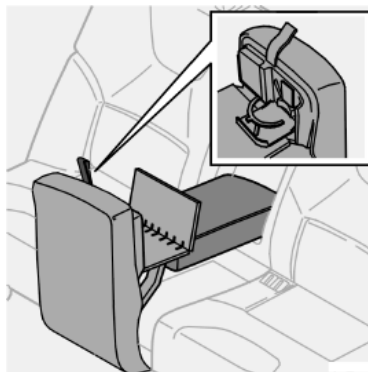
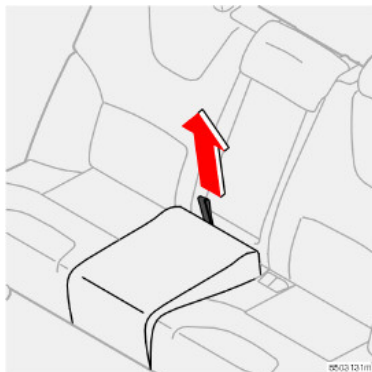
**Collapsible table (option)**

- Lift the strap and fold the seat cushion forward.

If you wish to fold out the table section completely, then the armrest in the rear seat must first be folded forward. If you only wish to use the cup holders then you need not fold out the table section.

To close:

- Fold in the table section and the cup holders.
- Fold the arm under the table inwards. Make sure that your hand does not get trapped.
- Fold the armrest into the rear seat.
- Lift the strap and fold back the seat cushion.

## Rear seat

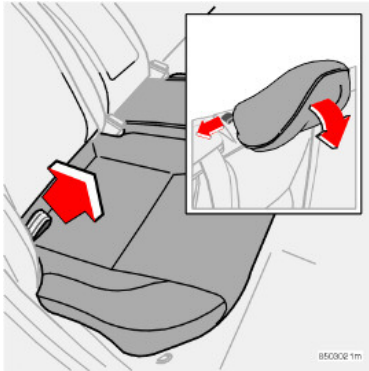

*Lowering the head restraint.*

### Extending the cargo compartment

The rear seat is in two sections and each section can be folded forward separately.

- Tip the front seat backrests into a more upright position if they are excessively reclined.
- Pull the strap on the seat cushion and fold the cushion towards the front seat backrest.
- Fold the outboard head restraints forward by pulling the head restraint strap.

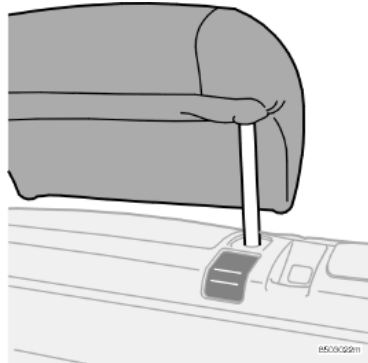

### Centre seat head restraint (V70)

Lower the centre seat head restraint if it is raised.

- Press the release button behind the right-hand support – see illustration.

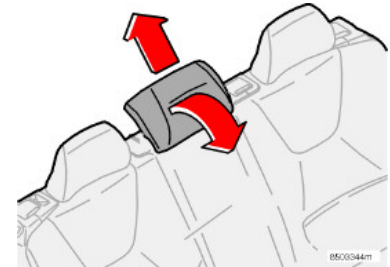

### Centre seat head restraint (XC70)

(Models with 3-portion rear seat)

Raise:

- Pull the head restraint straight up.

Lower:

- Pull the head restraint slightly forward and press down.

## Rear seat

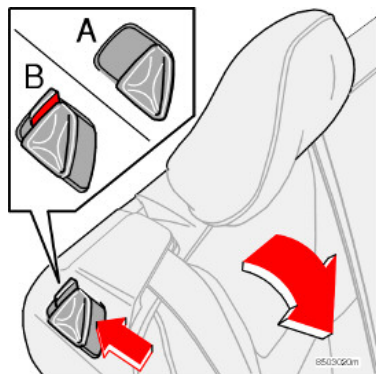

- A. Catch in closed position  
B. Catch in open position.

**Tipping the backrest forwards**

- Press the backrest catch to the rear and tip the backrest forwards.

**⚠ WARNING!**

When the backrests are folded back they must be secured firmly. The text "UN-LOCKED" must not be visible on the catch.

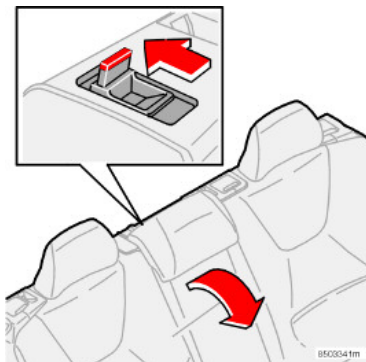

*Centre seat backrest (XC70 with 3-portion rear seat).*

**Folding the centre seat backrest (XC70)**

(Models with 3-portion rear seat)

The left-hand and centre section of the backrest can be folded forward separately. If the right-hand section of the backrest is being folded then the centre section must also be folded.

Folding down the centre seat backrest (without folding down the outer sections):

- Make sure that the head restraint is fully depressed. Press the button on the top edge of this section of the backrest to release the catch.
- Then fold the backrest forward.

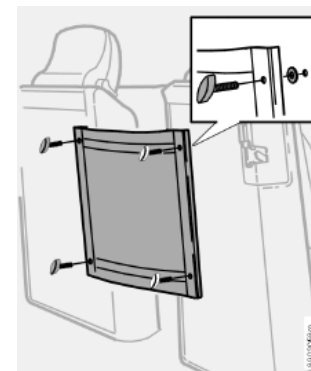
**Divider with storage pockets (XC70 - accessory)**

(Models with 3-portion rear seat)

A divider with storage pockets is available as an accessory for the XC70 with 3-portion rear seat. The divider can prevent objects in the cargo compartment from being thrown forward in the event of sudden braking.

To fit the divider, see the accompanying directions in the kit or contact an authorised Volvo workshop.

## Rear seat

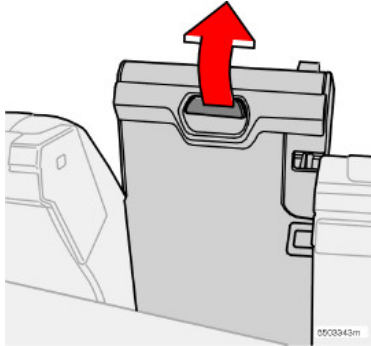

### Removing the centre seat backrest (XC70)

(Models with 3-portion rear seat)

- Press the button on the top edge of this section of the backrest to release the catch.
- Fold the backrest slightly forward.
- Pull in the handle on the rear of the backrest (see illustration above) to release the lower section of the backrest from the rod. Lift out the backrest.

Contact a Volvo dealer for information on accessory equipment that can be fitted between the outer sections of the backrest.

### Refitting the centre seat backrest

(Models with 3-portion rear seat)

The right-hand section of the backrest must be upright when refitting the centre section.

- Refit the backrest by pressing the lower section onto the rod until it locks into place.

Contact a Volvo dealer for information on accessories that can be placed between the outer sections of the backrest and seat cushion.

#### **WARNING!**

(XC70 with 3-portion rear seat)

For safety reasons, the centre seat backrest must not be left unsecured in the car. If the centre seat backrest is removed, then unsecured objects in the cargo compartment can be thrown forward between the outer backrests in the event of sudden braking.

The upper section of the backrest must be folded up when the centre seat backrest is refitted, otherwise the centre backrest cannot be locked and the centre seatbelt cannot be used.



## Rear seat

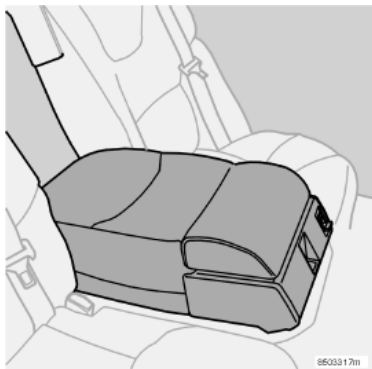

*Centre seat backrest as armrest.*

### Centre armrest (XC70)

(Models with 3-portion rear seat)

The centre seat backrest can be used so that it functions as an armrest.

- Remove the centre seat backrest. See page 91.
- Turn the backrest over (the front of the backrest should be up).
- Press the backrest back onto the rod until it locks into place.
- To reset the backrest to its normal position, pull the handle (which is now on the bottom of the front) to release it from the rod.
- Fold the backrest back into place.



### **WARNING!**

If the centre seat backrest is used as an armrest then the divider (see page 90) must be fitted to prevent objects in the cargo compartment from being thrown forward between the outer backrests in the event of sudden braking.

## Cargo compartment

### General

Payload depends on the car's total kerb weight, including any accessories that are mounted. Kerb weight includes the driver, the weight of the fuel tank when filled to 90 % and various fluids, such as washer fluid and coolant. Mounted accessories, i.e. towbar, load carrier, space box, etc., are included in the kerb weight.

The payload capacity of the car is reduced by the number of passengers and their weight.

#### **WARNING!**

The driving characteristics of the car change based on its kerb weight and how heavily it is loaded.

### Loading the cargo compartment

The seatbelts and airbags provide the driver and passengers substantial protection, especially in head-on collisions. However, you must also remember to protect yourself against injuries from behind. When loading cargo, bear in mind that improperly secured or incorrectly loaded objects in the cargo compartment could be thrown forward with great speed and force in the event of a collision or sudden braking, causing serious injuries.

**NOTE!** Bear in mind that if an object weighing 20 kg is subjected to a head-on collision at a speed of 50 km/h, its impact weight will be 1000 kg.

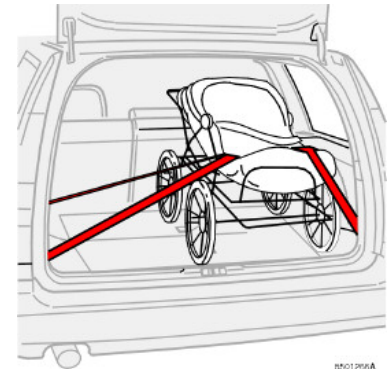
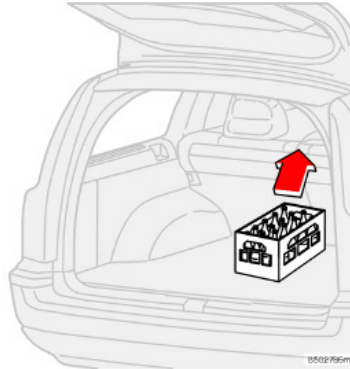

Think about the following when loading:

- Place the load by the backrest.
- Position heavy loads as low as possible.
- Position wide loads on each side of the division in the backrest.
- Secure the load with retaining straps using the car's lashing eyes.
- Never load above the backrest without a load net.
- When the rear seat backrest is folded down, do not load objects higher than 50 mm from the top edge of the rear passenger door windows. Otherwise, the protection offered by the inflatable curtain hidden inside the headlining will be compromised.

#### **WARNING!**

Do not load extremely heavy objects up by the front seats. The lowered backrest will be pressed down unnecessarily hard. Never load cargo above the backrests! If you do so, the load could be thrown forward in the event of sudden braking or a collision and severely injure you or your passengers. Remember to always secure (bind) the load properly.

## Cargo compartment

### Cargo area volume (measured with 1-litre boxes)

Rear backrest raised, load up to top edge of backrest: 485 l

Rear backrest lowered, load up to top edge of front seat backrests: 745 l

Rear backrest lowered, load up to headlining: 1641 l

#### **WARNING!**

When the rear seat backrest is folded down, do not load objects higher than 50 mm from the top edge of the rear passenger door windows. Otherwise, the protection offered by the inflatable curtain hidden inside the headlining will be compromised.

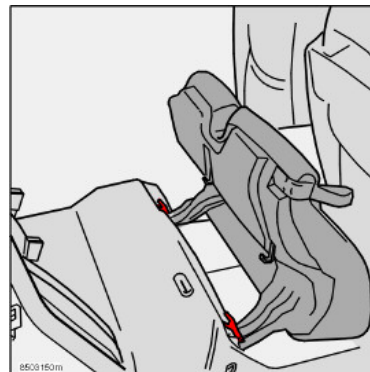
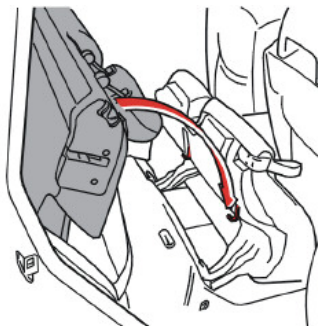

**NOTE!** Make sure that the holes in the plastic ferrules on the top of the backrest engage with the hooks on the bottom of the seat cushion.

When you later raise the backrest and seat cushion, the head restraints must be returned to their normal positions.

### Removing the seat cushion

(2 or 3-portion rear seat)

The seat cushion can be easily removed to provide a slightly longer cargo compartment.

- Pull the red lock pins forward to unlock the seat cushion.
- Then lift the seat cushion.
- Do this in the reverse order when replacing the seat cushion.

## Cargo compartment

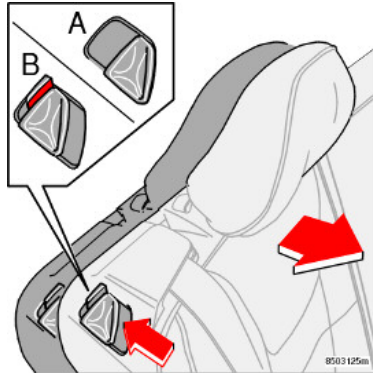

A. Catch in closed position.

B. Catch in open position.

### Rear seat backrest positions

You can adjust the height of both backrest positions in the rear seat. Proceed as follows to adjust a backrest to cargo position<sup>1</sup>:

- Press the catch until the red mark is visible.
- Pull the backrest forwards to a new locked position.
- Make sure that the backrest is secured in a locked position and that the red mark is no longer visible.
- Follow the same procedure to adjust the backrest to an upright position.

1. The cargo position increases the cargo area.

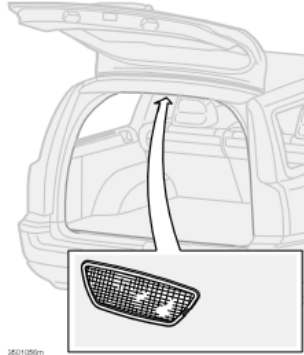

### Cargo area lighting

An extra roof lamp is fitted at the end of the cargo compartment.

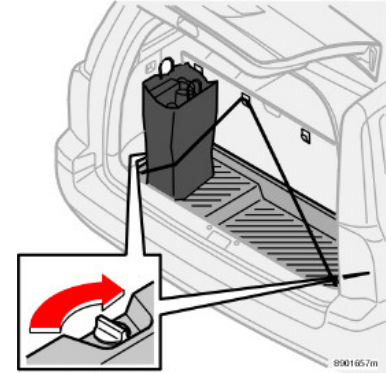

### Holder for grocery bags (option)

- Open the tailgate.
  - Hang or secure your grocery bags by means of tensioning straps or holders.
- To remove the plastic trough, turn the two knobs at the sides.

## Cargo compartment

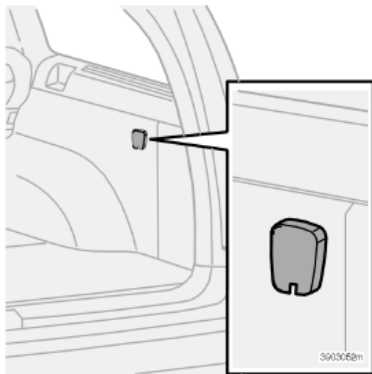

### Electric socket in the cargo compartment

Slide down the cover when you wish to use the socket. It works regardless of whether the ignition is on or off.

If the ignition is switched off and a power consumer that uses more than 0.1 A is connected to the electric socket, a warning message is shown on the display.

**NOTE!** Remember not to use the socket when the ignition is switched off, there is a risk of draining the battery.

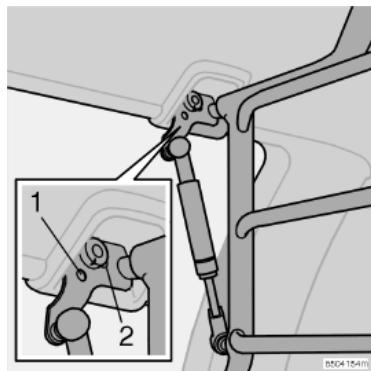

*Red marking – unlocked.*

*Green marking – locked.*

### Safety grille XC70

For reasons of safety, the safety grille in the cargo compartment must always be fastened and secured correctly.

Fit the protective grille as follows:

- Fold down the backrests.
- Use a Torx screwdriver to press in and turn the knob (1) to red (to unlock).
- Insert the spring-loaded ends of the safety grille into the attachment points (see illustration).
- Press in and turn the knob (1) to green (to lock).

**NOTE!** The green marking on the bracket (2) and the marking on the knob (1) must be opposite each other after installation. Otherwise there is no impact protection.

Remove the safety grille as follows:

- Fold down the backrests.
- Use a Torx screwdriver to press in and turn the knob (1) towards red so that the marking on the knob matches the marking on the bracket.
- Press the safety grille towards the car's opposite bracket until it leaves the roof panel. Ease off when you have passed the roof panel and carefully pull the grille towards you, so that the grille also detaches on the other side. Do not angle the grille too much as it would wedge in and could be difficult to pull out.

## Cargo compartment

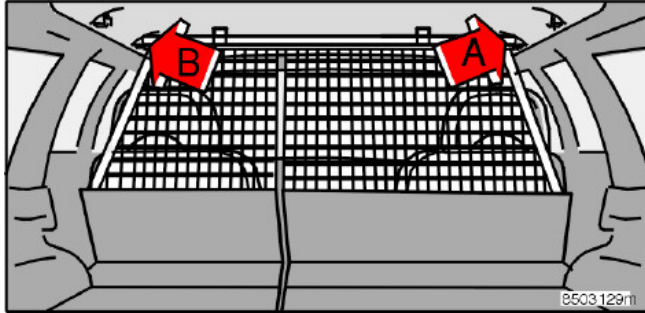

### Nylon cargo net V70

(2-portion rear seat)

The cargo net is produced from strong nylon fabric, which can be rolled out from the rear of the back seat. The cargo net is self-locking after being raised for about 1 minute, if the backrests in the rear seat are raised.

- Pull up the right-hand cargo net.
- First hook the rod in the bracket on the right-hand side (A). Then pull the rod out and hook it on the left-hand side (B).
- Pull up the left-hand cargo net and secure it to the rod.
- Remove in reverse order.

The cargo net can also be used when the rear seat is folded forwards.

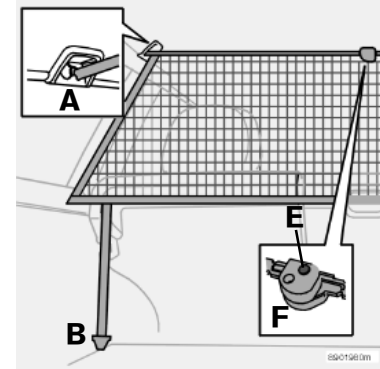

### Nylon cargo net XC70

(Models with 3-portion rear seat)

Volvo XC70 can be equipped with a cargo net made of strong nylon fabric, attachable to designated brackets in the roof headlining and tightened from eyelets on the floor<sup>1</sup>.

The net can be fastened behind the upright backrests of the rear seats. If the rear seats are folded down, the net can also be fastened behind the front seats (see illustrations).

1. If your car is equipped with a rear-facing extra seat.

## Cargo compartment

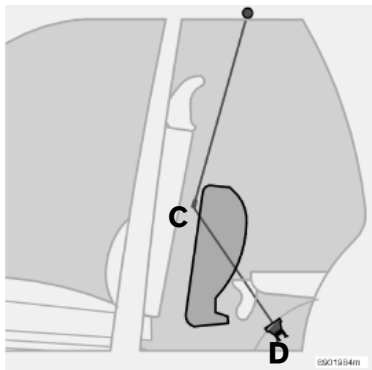

The upper and lower rods are fitted with a hinge in the middle so that the cargo net can be folded together. If necessary, fold out the rods until they are locked.

- Secure the upper rod in the front or rear ceiling bracket (A).
- Secure the other end of the rod in the ceiling bracket on the other side.
- Secure the cords of the cargo net in the eyelets on the floor (B) when the net is secured in the rear ceiling brackets or (D) when the net is secured in the front ceiling brackets.
- Tighten the cargo net with the cords.

**NOTE!** If the cargo net is fitted to the front ceiling brackets and the seat cushions of the

rear seat are folded forward, the cargo net should be pulled in front of the seat cushions and behind the backrests of the front seats (C).

**NOTE!** The cargo net cords must not be attached to the eyelets on the floor beneath the front seats. If these eyelets are used and the front seats are moved back then the net or upper attachments would be damaged.

### Folding the cargo net

The cargo net can be folded together and placed under the floor of the cargo compartment in cars not equipped with an auxiliary bass speaker (option) or auxiliary child seat (option).

Press the buttons (E) in the cargo net hinge (F) to release the hinge and fold the net together.

### **WARNING!**

For safety reasons the cargo net must not be used if children are sitting in the extra seat in the cargo compartment.

It is essential to ensure that the upper attachments of the cargo net are correctly fitted and that the cords are securely attached.

Damaged nets must not be used.

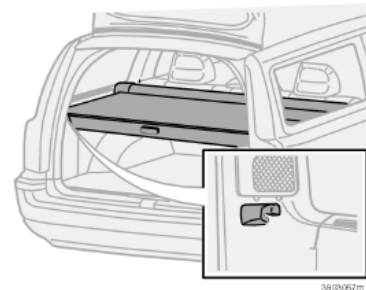

### Cargo cover (option)

Pull out the cargo area cover, pull it over the cargo and hook it into the recesses in the rear pillars of the cargo compartment.

### Removing the cargo area cover

- Press in the end piece of the cargo area cover, guide it up and release.
- To fit, press the end pieces of the cargo area cover down into the holders.

---

## **Locks and alarm**

<b>Keys and remote controls</b>	<b>100</b>
<b>Locking and unlocking</b>	<b>103</b>
<b>Child safety locks</b>	<b>106</b>
<b>Alarm (option)</b>	<b>107</b>



## Keys and remote controls

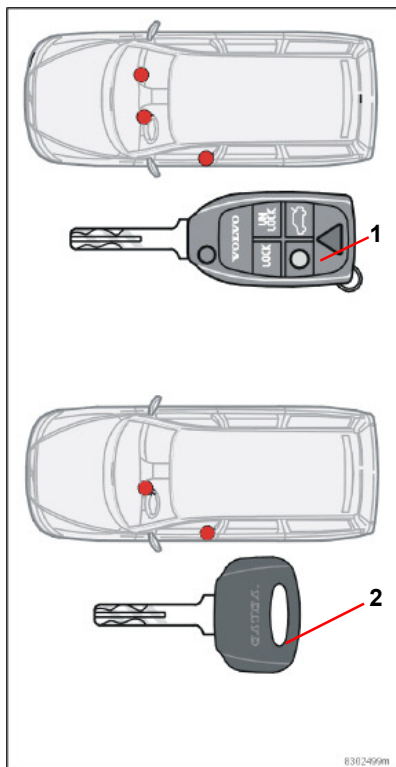

1. Master key  
This key opens all locks.
2. Service key<sup>1</sup>  
This key is for the front door, ignition switch and steering wheel lock only.

### Keys - Electronic immobiliser

Your car is delivered with two master keys and one service key<sup>1</sup>. One of the master keys is collapsible and equipped with an integrated remote control.

#### Loss of key

If you should lose one of your keys, bring the remaining keys to an authorised Volvo workshop. As a crime prevention measure, the code for the lost key is erased from the system and the other keys must be re-coded in the system.

The key blades' unique code is available at authorised Volvo workshops, which can produce new key blades.

A maximum of six remote controls/key blades can be programmed and used for one single car.

### Electronic Immobiliser

The keys are equipped with coded chips. This code must match the reader in the ignition switch. The car can only be started if the correct key with the correct code is used.

1. Certain markets only.

**NOTE!** The master key blade (1) must be fully extended (as illustrated) when starting the car. Otherwise there is a risk that the immobiliser function will prevent the car from starting.

### Ignition keys and electronic immobiliser

The ignition key must not hang with other keys or metal objects on the same key ring. The electronic immobiliser could be activated erroneously and the car will not start.

## Keys and remote controls



1. Unlock
2. Open the tailgate
3. Alarm function
4. Approach lighting
5. Locks
6. Folding/opening the key

### Remote control functions

#### Unlocking

- Press button (1) to unlock all doors, the tailgate and the fuel filler flap.

#### Tailgate

- Press button (2) twice to unlock the tailgate only.

**NOTE!** The function does not open the tailgate.

#### Alarm function

The alarm function can be used to attract attention in the event of an emergency. If the red button (3) is held depressed for at least three seconds or is pressed twice in a short period of time, the direction indicators and horn are triggered. The alarm is deactivated automatically after 25 seconds or by pressing any of the buttons on the remote control.

#### Approach lighting

Do the following when you approach the car:

- Press the yellow button (4) on the remote control.

The interior lighting, position/parking lamps, number plate lighting and door mirror lamps (option) will switch on. These lamps will remain lit for 30, 60 or 90 seconds. An authorised Volvo workshop can select a suitable time setting.

To extinguish the approach lighting:

- Press the yellow button again.

#### Locking

Lock all doors, tailgate and fuel filler flap with button (5).

There is a delay of approx. 10 minutes for the fuel filler flap.

#### Folding/opening key

The key can be folded by pressing button (6) while folding the key blade into the keypad.

The folding key will open automatically with one press of the button.

### Keys and remote controls

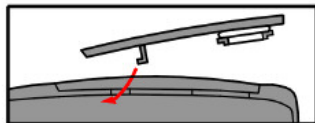
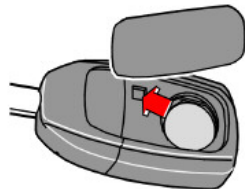

03/02/190m

Take the battery to an authorised Volvo workshop so that it will be dealt with in an environmentally safe manner.

### Changing the remote control battery

Replace the battery after repeated failure by the locks to respond when remote control signals are transmitted within a normal distance.

- Remove the cover by carefully prizing up the rear edge of with a small screwdriver.
- Replace the battery (type CR 2032, 3 V)
  - with the plus side facing up. Avoid touching the battery and its contact surfaces with your fingers.
- Refit the cover. Make sure the rubber seal is properly fitted and free from damage to prevent water from entering.

## Locking and unlocking

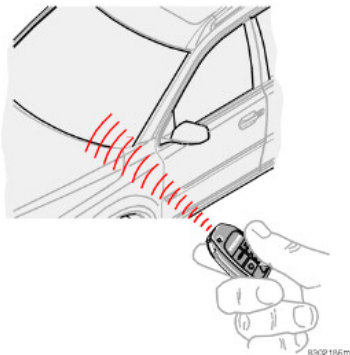

tentionally. For cars with alarms, see page 107

### Automatic locking

The doors lock automatically when vehicle speed exceeds 7 km/h and remain locked until a door is opened from the inside or unlocked using a central locking button.

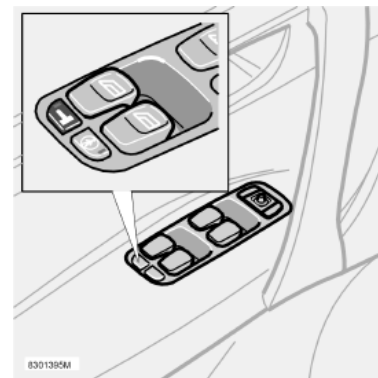

### Locking/unlocking the car from the outside

All doors and the tailgate can be unlocked simultaneously – from the outside – using the master key or its remote control. In this mode, all side door locks and inside door handles are inoperative.

The fuel filler flap can be opened when the car is unlocked. The flap remains unlocked for 10 minutes after the car has been locked.

### Automatic relocking

If none of the doors or the tailgate is opened within two minutes of unlocking, all are locked again automatically. This function prevents the car from being left unlocked unin-

### Locking and unlocking the car from the inside

Using the control in the door panel, all doors and the tailgate can be locked or unlocked simultaneously.

Additionally, each door can be locked with the lock button and unlocked by opening the door using the handle.

The above applies only if the car was not locked from the outside!

### Locking and unlocking

#### Locking/unlocking the tailgate with the remote control

To unlock the tailgate only: Press the button on the remote control twice slowly within 3 seconds. If all doors are locked when the tailgate is closed, it remains unlocked and has no alarm function after it is closed.

The other doors remain locked and continue to have their alarm function.

To arm the alarm and lock the tailgate only when you close it, press the LOCK button again.

**NOTE!** Automatic relocking:

If you use this button to unlock the tailgate without opening it, it will automatically relock after approx. 2 minutes.

However, the automatic relocking function will not operate if you open and then shut the tailgate.

#### Locking the glovebox

The glovebox can only be locked/opened using the master key – not with the service key.

#### Deadlocks<sup>1</sup>

Your car has a special deadlock function, which means that the doors cannot be opened from the inside if they are locked.

Deadlocks can only be activated from the outside by the driver's door being locked with the key or remote control. All doors must be closed before deadlocks can be activated. Once activated, the doors cannot be opened from the inside. The car can only be unlocked from the outside via the driver's door or by using the remote control.

Deadlocks are engaged after a 25 second delay once the doors have been closed.

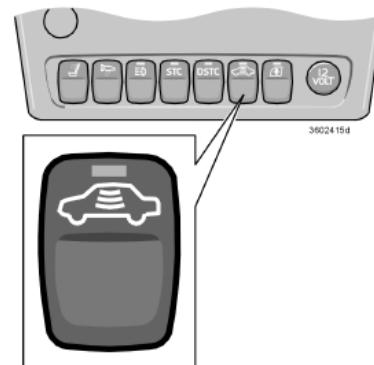

#### Temporary deactivation of the deadlocks and any detectors

If others prefer to remain seated in the car with the doors locked from the outside – e.g. during transport by ferry – it is possible to deactivate the deadlocks.

- Insert the key into the ignition switch, turn it to position **II** and then back to position **I** or **0**.
- Press the button.

If the car is equipped with an alarm, movement and tilt detectors are also deactivated. See page 108.

1. Certain countries

## Locking and unlocking

The LED in the button comes on until the car is locked with the key or remote control. A message is shown in the display as long as the key remains in the ignition switch. The sensors will be reactivated the next time the ignition is switched on.



### **WARNING!**

Do not allow anyone to remain in the car without first deactivating the deadlock.

## Child safety locks

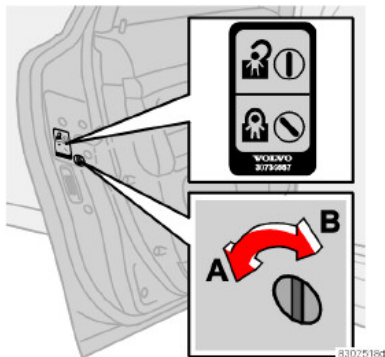

Control for child safety lock – left-hand rear door.

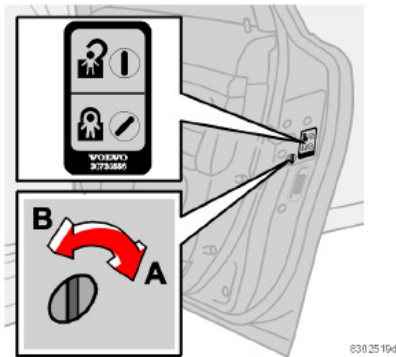

Control for child safety lock – right-hand rear door.

### Mechanical child safety locks – rear doors

The controls for the child safety locks are in the rear edge of each rear door and are only accessible when the door is open. Use a flat metal object, such as a screwdriver, to turn the control and thus activate or deactivate the child safety lock.

- A. Child-safe position – the doors cannot be opened from inside; turn outwards.
- B. Not child-safe position – the doors can be opened from inside; turn inwards.

### **WARNING!**

Remember that in the event of an accident, rear seat passengers cannot open the rear doors from the inside if the child safety locks are activated. Therefore, keep the doors unlocked while driving! In the event of an accident, rescue personnel will then be able to enter the car from the outside.

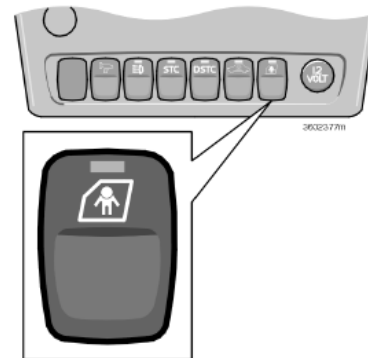

Electric child safety locks.

### Electric child safety locks – rear doors (option)

Use the button in the centre console to activate or deactivate the child safety locks in the rear doors. The ignition key must be in position **I** or **II**. The LED in the button comes on when the child safety lock is activated. A message appears in the display when you activate or deactivate the child safety lock.

**NOTE!** The rear doors cannot be opened from the inside as long as the electric child safety locks are activated.

## Alarm (option)

### The alarm system

When the alarm is armed, it continually monitors all alarm inputs. The alarm is triggered if:

- The bonnet is opened.
- The tailgate is opened.
- A side door is opened.
- The ignition switch is turned with a non-approved key or subjected to force.
- Movement is detected in the passenger compartment (if a motion sensor is fitted – option for certain markets only).
- The car is raised or towed away (if a tilt sensor is fitted – option for certain markets only).
- A battery cable is disconnected.
- Anyone tries to disconnect the siren.

### Activating the alarm

Press the LOCK button on the remote control. A long flash signal from the direction indicators of the car confirms that the alarm is activated and all doors are closed. In certain markets, the key or the control in the driver's door can be used to arm the alarm.

### Deactivating the alarm

Press the UNLOCK button on the remote control. Two short flash signals from the direction indicators of the car confirm that the

alarm is deactivated. In certain markets, the key can be used to deactivate the alarm.

### Automatic alarm activation

If none of the doors or the boot lid is opened within two minutes of the alarm being deactivated, and the car was unlocked with the remote control, the car reactivates the alarm automatically. The car locks at the same time. This function prevents you from accidentally leaving the car without the alarm on.

In certain countries (e.g. Belgium, Israel) the alarm is reactivated after a certain delay if the driver's door was opened and closed but the car was not re-locked.

### Deactivating a triggered alarm

Press the UNLOCK button on the remote control if the alarm sounds and you wish to deactivate it. Two short flashes of the direction indicators are given as confirmation.

### Audio signal - Alarm

The audio signal is given from a siren with a reserve battery. Each alarm signal lasts 25 seconds.

### Visual signal - Alarm

When the alarm is triggered, all direction indicators flash for 5 minutes or until the alarm is deactivated as described earlier.



### Alarm (option)

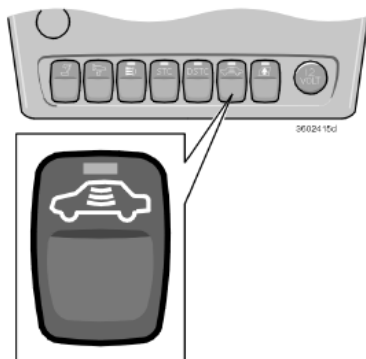

#### Temporary deactivation of detectors and deadlocks

To avoid inadvertently triggering of the alarm, for example when leaving a dog in the car or during a ferry crossing, the movement and tilt detectors can be temporarily deactivated:

- Insert the key in the ignition switch, turn it to position **II** and then back to position **I** or **0**.
- Press the button.

The LED in the button lights until you lock the car with the key or remote control.

A message will be shown in the display as long as the key remains in the ignition switch.

The sensors will be reactivated when the ignition is restarted.

If your car has deadlocks, they are reactivated at the same time. See page 104.

#### Indicator lamp on the dashboard (certain countries)

An indicator lamp (LED) at the top of the dashboard indicates alarm status:

- Lamp not lit: Alarm is deactivated.
- The lamp flashes once every other second: the alarm is armed.
- Lamp flashes quickly, after deactivating the alarm and until the ignition is switched on: The alarm has been triggered.

If there is a fault in the alarm system, a message appears in the display.

If the alarm system does not function correctly, have an authorised Volvo workshop examine the car.

#### **IMPORTANT!**

Do not attempt to repair or modify alarm system components. All such attempts can affect terms of insurance.

## Alarm (option)

### Testing the alarm system

#### Testing the passenger compartment motion sensor

- Open all the windows.
- Activate the alarm. Alarm activation is confirmed with a slow flash of the LED.
- Wait 30 seconds.
- Test the movement detector in the passenger compartment by lifting a bag or similar from the seat cushion. The alarm should now sound and flash.
- Deactivate the alarm by unlocking the car with the remote control.

#### Testing the doors

- Arm the alarm.
- Wait 30 seconds.
- Unlock the driver's door with the key blade.
- Open one of the doors. The alarm system should sound and flash.
- Repeat the test for the other doors.
- Deactivate the alarm by unlocking the car with the remote control.

#### Testing the bonnet

- Get into the car and deactivate the movement detector.

- Arm the alarm (remain in the car and lock the doors with the button on the remote control).
- Wait 30 seconds.
- Open the bonnet with the handle under the dashboard. The alarm should now sound and flash.
- Deactivate the alarm by unlocking the car with the remote control.

#### Testing the tailgate

- Arm the alarm.
- Wait 30 seconds.
- Unlock with the key on the driver's side.
- Open the tailgate. The alarm system should now sound and flash.
- Deactivate the alarm by unlocking the car with the remote control.



---

## Starting and driving

<b>General</b>	<b>112</b>
<b>Refuelling</b>	<b>114</b>
<b>Starting the car</b>	<b>115</b>
<b>Manual gearbox</b>	<b>117</b>
<b>Automatic gearbox</b>	<b>118</b>
<b>Brake system</b>	<b>121</b>
<b>Stability system</b>	<b>123</b>
<b>FOUR-C (Active chassis)</b>	<b>124</b>
<b>Parking assistance (option)</b>	<b>125</b>
<b>Towing and recovery</b>	<b>127</b>
<b>Start assistance</b>	<b>129</b>
<b>Driving with a trailer</b>	<b>130</b>
<b>Towing equipment</b>	<b>132</b>
<b>Detachable towbar</b>	<b>134</b>
<b>Load on the roof</b>	<b>136</b>
<b>Adjusting headlamp pattern</b>	<b>139</b>
<b>BLIS (Blind Spot Information System) - option</b>	<b>144</b>

### General

#### Economical driving

Economical driving results from driving gently with anticipation and adapting your driving style and speed to the situation.

Keep in mind the following:

- Drive the engine to operating temperature as soon as possible! That is to say: do not let the engine idle, but drive with a light load as soon as you can.
- A cold engine consumes more fuel than a warm one.
- Avoid driving short distances where the engine never has time to reach operating temperature.
- Drive gently! Avoid unnecessary quick accelerations and heavy braking.
- Do not drive with unnecessary, heavy loads in the car.
- Do not use winter tyres when the roads are clear and dry.
- Remove the load carrier when it is not in use.
- Do not open side windows unnecessarily.

#### Do not drive with the tailgate open

If you drive with the tailgate open, some of the exhaust gases and poisonous carbon monoxide could be sucked into the car through the

cargo area. If you must drive a short distance with the tailgate open, proceed as follows:

- Close all windows.
- Distribute the air between the windscreen and floor while running the fan at high speed.

#### Your new car – slippery road surfaces

Driving on a slippery road may feel different depending on whether you choose a car with a manual or an automatic gearbox. Practice skid driving under controlled conditions so that you know how your new car reacts.

#### Do not overload the battery

The electrical functions in the car load the battery to varying degrees. Avoid having the ignition key in position **II** when the engine is turned off. Use position **I** instead, as less power is used. The 12 volt outlet in the cargo area supplies power even when the ignition key is removed.

Examples of functions that use a lot of power:

- ventilation fan
- windscreen wipers
- audio system
- parking lights

Also take note of different accessories that load the electrical system. Do not use func-

tions that consume a lot of current when the engine is switched off. A text is shown in the display in the combined instrument panel if battery voltage is low. The message in the display remains until the engine has started. The energy economy function shuts down certain functions or reduces the load on the battery, e.g. by lowering ventilation fan speed and switching off the audio system.

Charge the battery by starting the engine.

## General

### **Do not allow the engine and cooling system to overheat**

Under certain conditions, e.g. when driving in hilly terrain and with a heavy load, especially in warm weather, there is a risk of the engine and cooling system overheating.

#### **To avoid overheating in the cooling system:**

- Drive at low speeds if driving with a trailer up a long incline.
- Switch off the air conditioning temporarily.
- Avoid letting the engine idle.
- Do not turn the engine off immediately you stop, if the car has been driven hard.
- Remove any auxiliary lamps from in front of the grille if driving in extreme high temperatures.

#### **To avoid the engine overheating:**

Do not exceed engine speeds of 4500 rpm (diesel engine: 3500 rpm) if driving with a trailer or caravan in hilly terrain. The oil temperature can become too high.

### Refuelling

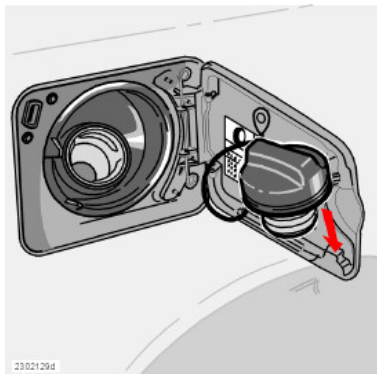

*The fuel cap is inside the fuel filler flap on the right-hand rear wing and hangs up on the inside of the fuel filler flap.*

#### Opening the fuel filler flap

The fuel filler flap can be opened when the car is unlocked.

**NOTE!** The filler flap remains unlocked for ten minutes after the car has been locked.

#### Fuel filler flap

There may be overpressure in the tank if outdoor temperatures are high. Open the cap slowly. Do not overfill the fuel tank. Stop refuelling when the pump cuts out for the first time! If the tank is overfilled fuel may overflow at high temperatures!

After refuelling, replace the fuel cap and turn until one or more clicks is heard.

#### **WARNING!**

Never carry an activated mobile phone when refuelling – the ring signal could cause spark build-up and ignite petrol fumes, leading to fire and injury.

#### Refuelling with petrol

**NOTE!** Do not add cleaning additives unless specifically recommended by a Volvo workshop.

#### **IMPORTANT!**

Petrol-powered cars must always be refuelled with unleaded petrol so as not to damage the catalytic converter.

#### Refuelling with diesel

At low temperatures, paraffin can emanate from diesel fuel ( $-5\text{ °C}$  -  $-40\text{ °C}$ ), which may cause problems when starting. Make sure you use a special winter grade fuel during cold weather.

## Starting the car

### Starting the engine (petrol)

- Apply the parking brake (handbrake).

#### Automatic gearbox

Gear selector in position **P** or **N**.

#### Manual gearbox

- Gear lever in neutral and clutch pedal fully depressed. This is particularly important in very cold conditions.

**NOTE!** The master key blade must be fully extended (as illustrated on page 100) when starting the car. Otherwise there is a risk that the immobiliser function will prevent the car from starting.

- Turn the ignition key to the start position. If the engine does not start within 5-10 seconds, release the key and repeat the start attempt.

### Starting the engine (Diesel)

- Apply the parking brake (handbrake).

#### Automatic gearbox

Gear selector in position **P** or **N**.

#### Manual gearbox

- Gear lever in neutral and clutch pedal fully depressed. This is particularly important in very cold conditions.

**NOTE!** The master key blade must be fully extended (as illustrated on page 100) when starting the car. Otherwise there is a risk that

the immobiliser function will prevent the car from starting.

- Turn the ignition key to the driving position. A symbol on the combined instrument panel will come on indicating that the engine preheater is activated. Turn the key to the start position when the lamp extinguishes.

**NOTE!** The idling speed can be noticeably higher than normal for certain engine types during cold starting. This is so that the emissions system can reach normal operating temperature as quickly as possible, which minimises exhaust emissions and protects the environment.

### Diesel particle filter (certain models)

Certain diesel cars are equipped with a particle filter which results in additionally effective exhaust purification. When the engine is at its normal operating temperature (the engine is warm) a "regeneration" of the filter takes place automatically, which means that the particles collected in the filter are burned away and the filter is emptied.

Regeneration takes between 10 and 15 minutes. During this time fuel consumption may increase slightly.

### Winter driving

If the car is frequently driven short distances in cold weather then the engine does not reach normal operating temperature. This means that regeneration of the diesel particle filter does not take place and the filter is not emptied.

When the filter has become approx. 80 % full of particles then a yellow warning triangle in the dashboard display is shown along with the warning text SOOT FILTER FULL SEE MANUAL.

Regeneration should be carried out regularly if the car is frequently driven short distances in cold weather in order to avoid impaired function of the filter.

- Start regeneration of the filter by driving the car until the engine reaches normal operating temperature, preferably on a main road or motorway. The car should then be driven for approximately 20 minutes more.
- To clear the warning text when regeneration is complete, switch off the ignition, remove the key, wait for at least three minutes and switch the ignition on again.
- Use the parking heater (option) in cold weather so that the engine reaches normal operating temperature more quickly.



## Starting the car

### IMPORTANT!

If the filter fills up with particles then it can be difficult to start the engine and the filter will be incapable of functioning and must then be replaced.

### Ignition keys and electronic immobiliser

The ignition key must not hang with other keys or metal objects on the same key ring. The electronic immobiliser could be activated accidentally. If this happens – remove the excess keys and restart the car.

Never rev the engine hard straight after a cold start! If the engine does not start or misfires, contact a Volvo workshop.

### WARNING!

Never remove the ignition key from the steering wheel lock while driving or when the car is being towed! Never switch off the ignition (key to position **0**) or remove the ignition key while the car is in motion. The steering wheel lock could be activated, making the car impossible to steer.

### Ignition switch and steering lock

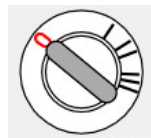

IMG-203301

#### 0 - Locked position

The steering wheel locks when the ignition key is removed.

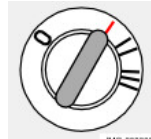

IMG-203303

#### I - Intermediate position - "radio position"

Certain electrical components can be switched on. The engine's electrical system is not activated.

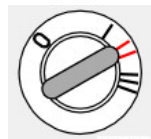

IMG-203304

#### II - Driving position

The key position when driving. The car's entire electrical system is connected.

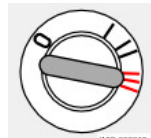

IMG-203305

#### III - Start position

The starter motor is connected. Release the key once the engine has started. The key automatically springs back to the driving position.

If the key is hard to turn, the front wheels may be turned in such a way that there is tension in the steering wheel lock. Turn the wheel back and forth to make it easier to turn the key.

Ensuring that the steering wheel is locked when you leave the car minimises the risk of theft.

## Manual gearbox



### Gear positions, five-speed

Depress the clutch pedal fully with each gear change. Remove your foot from the clutch pedal between gear changes! Follow the appropriate shifting pattern.

For the best possible fuel economy, use the highest gear possible as often as possible.



### Reverse gear inhibitor

Engage reverse gear when the car is completely stationary.

To put the car in reverse, the gear lever must first be moved to neutral (between 3rd and 4th gear). Thus, reverse cannot be directly selected from 5th gear due to the reverse gear inhibitor.

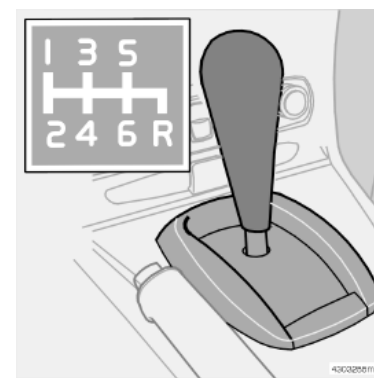

### Gear positions, six-speed

Depress the clutch pedal fully with each gear change. Remove your foot from the clutch pedal between gear changes! Follow the appropriate shifting pattern.

For the best possible fuel economy, use the highest gear possible as often as possible.

# Automatic gearbox

## Cold start

When starting in low temperatures, the gear changes can sometimes feel hard. This is due to the gearbox oil's viscosity at low temperatures. To minimise engine emissions, the gearbox shifts up later than normal when the engine is started at low temperatures.

## Turbo engine

When the engine is cold, the transmission shifts gears at higher revs. This allows the catalytic converter to reach normal operating temperature more quickly, with less exhaust emissions.

## Adaptive system

The gearbox is controlled by what is known as an adaptive system. The system continually monitors how the gearbox is behaving and senses every gear change for optimum change quality.

## Lock-up function

The gears have a lock-up function (locked gears), which gives better engine braking and lower fuel consumption.

## Safety systems

Cars with an automatic gearbox have special safety systems.

## Keylock

To remove the ignition key, the gear selector must be in the **P** position. The key is locked in all other positions.

## Parking position (P position)

Stationary car with engine running:

- Hold your foot on the brake pedal when moving the gear selector to another position.

## Electric gear inhibitor - Shiftlock

### Parking position (P position)

To be able to move the gear selector from the **P** position to other gear positions, the ignition key must be in position **I** or **II** and the brake pedal must be depressed.

### Neutral position (N position)

The brake pedal must be depressed to move the gear selector from position **N** to other gear positions when the ignition key is in position **I** or **II**.

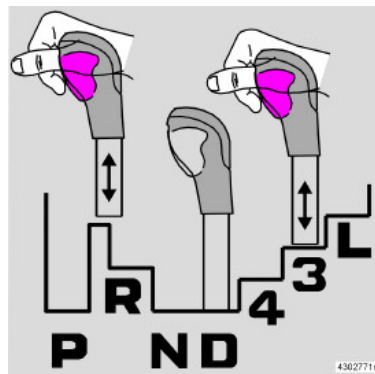

## Mechanical gear selector inhibitor

The gear selector can be moved freely between **N** and **D**. Other positions are locked with a latch that is released with the inhibitor button on the gear selector.

Press the inhibitor button to move the lever forward or back between the different gear positions.

## Automatic gearbox

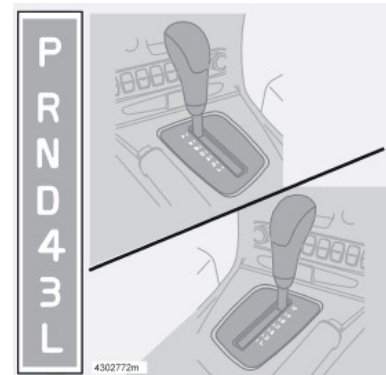
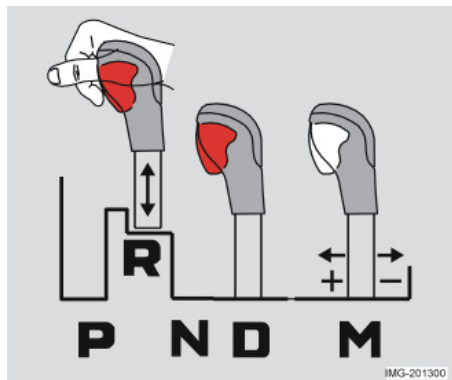
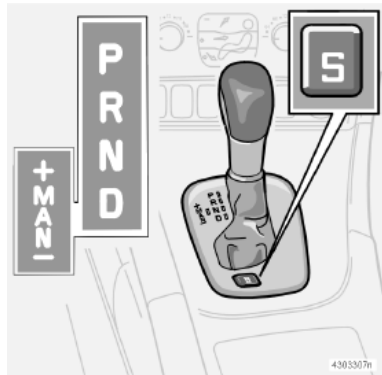

### Geartronic<sup>1</sup>

The V70 R with Geartronic has an **S** button instead of a **W** button located at the gear selector. The gearbox sports programme is activated using the **S** button. An LED is lit in the button to indicate active mode.

The S programme provides sportier characteristics. It allows higher engine speed for the gears while responding more quickly to acceleration. During active driving, the use of a lower gear is prioritised – leading to a delayed upshift.

### Manual positions, Geartronic

To move from the automatic driving position **D** to a manual position, move the gear selector to the left. To go from position **MAN** to the automatic driving position **D**, move the selector to the right to position **D**.

### While driving

The manual gearshift mode can be selected at any time while driving. The engaged gear is locked until you choose another gear. The car will only shift down automatically if you slow down to a very slow speed.

If the gear lever is moved to - (minus) the car changes down a gear and engine brakes. If the gear lever is moved to + (plus) the car changes up a gear.

### P - Park

Select this position when you wish to start the engine or park the car.

The car should be stationary when you select **P**!

In **P** the gearbox is mechanically locked. Always apply the parking brake when parking the car.

### R - Reverse

The car should be stationary when you select **R**.

### N - Neutral

**N** is the neutral position. No gear is engaged and the engine can be started. Apply the parking brake when the car is stationary with the gear selector is in position **N**.

1. V70 R has Geartronic as standard.

### Automatic gearbox

#### D - Drive

**D** is the normal driving position. The car automatically shifts between the different gears of the gearbox based on the level of acceleration and speed. The car should be stationary when selecting **D** from position **R**.

#### 4 - Low gear

Up and downshifts between 1st, 2nd, 3rd and 4th are automatic. There is no upshift to 5th gear.

Position **4** can be used:

- For mountain driving.
- When driving with a trailer.
- To increase engine braking.

#### 3 - Low gear

Up and downshifts between 1st, 2nd, and 3rd are automatic. There is no upshift to 4th gear.

Position **3** can be used:

- For mountain driving.
- When driving with a trailer.
- To increase engine braking.

#### L - Low gear

Select **L** if you wish to drive in 1st or 2nd.

Position **L** gives the best engine braking for mountain driving, etc.

#### W - Winter



The **W** button<sup>1</sup> by the gear selector engages and disengages the winter programme **W**. The symbol **W** is shown in the combined instrument panel

when the winter programme is activated.

The winter programme starts the gearbox in 3rd gear to make it easier to pull off on slippery roads. When the programme is engaged, lower gears are activated only by kick-down.

The **W** programme can only be selected in position **D**.

#### Kick-down

When the accelerator is pressed all the way to the floor, beyond the position normally regarded as full acceleration, a lower gear is immediately engaged. This is known as kick-down.

When maximum speed for this gear is reached, or if the accelerator is released from the kick-down position, the gearbox automatically changes up.

Kick-down is used when maximum acceleration is needed, such as for overtaking.

To prevent overrevving, the gearbox control program has a protective downshift inhibitor.

The kick-down function<sup>2</sup> cannot be used in the manual positions. Return to automatic position **D**.

#### All-wheel drive - AWD

All-wheel drive is always engaged.

All-wheel drive means that all four road wheels are driven at the same time. Power is automatically distributed between front and rear wheels. An electronically controlled clutch system distributes the power to the pair of wheels that grips best. This provides the best traction and prevents wheel spin.

Under normal driving conditions, the majority of power is transmitted to the front wheels.

All-wheel drive improves driving safety in rain, snow and icy conditions.

#### Speed related power steering<sup>3</sup>

If the car is equipped with speed related power steering this means that it is easier to steer at low speeds, which in turn facilitates parking etc.

As speed is increased the steering force is adapted to give the driver enhanced sensitivity.

---

1. V70 R with Geartronic has an S button instead.

---

2. Applies to Geartronic only.  
3. Option

## Brake system

### Brake servo

If the car is rolling or is being towed with the engine turned off, the brake pedal must be pressed about five times harder than when the engine is running. If the brake pedal is pressed when the engine is started, you will feel the pedal drop. This is normal and due to the brake servo becoming active. This may be more noticeable if the car has emergency brake assistance (EBA).

**NOTE!** If braking with the engine switched off, press the brake pedal sharply once, not repeatedly.

#### **WARNING!**

The brake servo only works when the engine is running.

### Brake circuits



This symbol lights if a brake circuit is not working.

If a fault should occur in one of the circuits, it is still possible to brake the car. The brake pedal will travel further and may feel softer than normal. Harder pressure on the pedal is needed to produce the normal braking effect.

### Dampness can affect braking characteristics

Brake components become wet when the car is driven in heavy rain, through pools of water or when the car is washed. This may alter brake pad friction characteristics so that there is a delay before braking effect is noticed.

Press the brake pedal lightly from time to time if driving for long stretches in rain or slushy snow, as well as after setting off in very damp or cold weather. This warms up the braking surfaces and dries off any water. It is also recommended to do this before parking the car for a long period in such weather conditions.

### If the brakes are used heavily

When driving in the Alps or other roads with similar characteristics, the car's brakes are heavily loaded even if the brake pedal is not being depressed especially hard.

Because speed is often low, the brakes are not cooled as effectively as when driving on flat roads at higher speed.

So as not to overload the brakes, shift down when driving downhill instead of using the foot brake. Use the same gear driving downhill as you would use driving uphill. This using engine braking more efficiently and requires the foot brake for only brief periods.

#### **WARNING!**

If the BRAKE and ABS warning symbols are lit at the same time, a fault may have occurred in the brake system. If the level in the brake fluid reservoir is normal, drive carefully to the nearest authorised Volvo workshop to have the brake system checked.

If the brake fluid is under the MIN level in the brake fluid reservoir, do not drive further before topping up the brake fluid. The reason for the loss of brake fluid must be investigated.

Bear in mind that driving with a trailer puts an additional load on the car's brakes.

### Anti-lock braking system (ABS)



The ABS system (Anti-lock Braking System) is designed so that the wheels do not lock when braking.

This retains the best possible steering response when braking. This improves your ability to swerve to avoid obstacles. The ABS system does not increase your total braking capacity. However, as the driver you have increased ability to steer and thus better control over the car, which in turn increases safety.

### Brake system

After the engine has started and reached a speed of about 20 km/h, a short self-test can be both heard and felt. When the ABS system functions, you can hear and feel pulses in the brake pedal. This is completely normal.

**NOTE!** You must depress the brake pedal fully to take maximum advantage of the ABS system. Do not release the pedal when you hear and feel the ABS pulses. Practice braking with the ABS system at a suitable spot such as a track to practice skidding.

#### The ABS symbol lights up:

- For approximately two seconds during the system test when the car is started.
- If the ABS system has shut down due to a fault.

#### Electronic brake force distribution system - EBD

The Electronic Brakeforce Distribution system (EBD) is an integrated part of the ABS system. The EBD system controls the brake force to the rear wheels so that the best possible braking force is always available. Pulses will be heard and felt through the brake pedal when the system regulates brake force.

#### **WARNING!**

If the BRAKE and ABS warning symbols are lit at the same time, a fault may have occurred in the brake system. If the level in the brake fluid reservoir is normal, drive carefully to the nearest authorised Volvo workshop to have the brake system checked.

If the level of brake fluid in the reservoir is below the MIN mark, the car should not be driven until the brake fluid has been topped up.

The reason for the loss of brake fluid must be investigated.

#### Emergency Brake Assistance - EBA

The Emergency Brake Assistance function (EBA) is integrated in the DSTC system and is designed to provide immediate maximum brake force whenever rapid braking is necessary. The system detects the need for heavier braking by registering how quickly the brake pedal is applied.

The EBA function is active at all speeds. For safety reasons, it cannot be switched off.

When the EBA function is activated, the brake pedal sinks while maximum braking force is applied. Continue braking without releasing the brake pedal. The EBA function disengages when the pressure on the brake pedal is released.

## Stability system

When the stability system<sup>1</sup> is in action, it may seem like the car does not respond normally to acceleration. This is because the system detects the amount of friction on the road surface and allows the different stability system functions to operate.

The car is either equipped with STC (Stability and Traction Control) – Stability and traction control system or DSTC (Dynamic Stability and Traction Control) – Dynamic stability and traction control system.

See page 41 for further information on warning symbols in the combined instrument panel

Function/ system	STC	DSTC <sup>1</sup>
TC	X	X
SC	X	X
AYC		X

### Traction Control - (TC)

The Traction Control function transfers power from the spinning drive wheel to the drive wheel which has grip by braking the spinning drive wheel. To increase forward traction in this situation, it may be necessary to depress the accelerator more than usual. A pulsing sound is heard when Traction Control is working. This is completely normal. The TC

function is most active at low speeds. It cannot be deactivated.

### Spin Control (SC)

The Stability Control function prevents the drive wheels from slipping during acceleration. This improves road safety on slippery surfaces. Under certain conditions, such as when driving with snow chains or in deep snow or sand, it may be beneficial to deactivate the SC function to increase traction. This is done with the STC/DSTC button.

### Active Yaw Control (AYC)

The Active Yaw Control function automatically brakes one or more wheels to stabilise the car in the event of a skid. If the brake pedal were to be depressed in this situation, it would feel more rigid than usual and a pulsing sound would be heard.

The AYC function is always active and cannot be deactivated.



### WARNING!

Suppressing the STC or DSTC system may alter the driving characteristics of the car. Always take care when cornering and driving in slippery conditions.

1. Option on certain markets



### FOUR-C (Active chassis)



*Four-C switch in the centre console (does not apply to the V70 R)*

#### Active chassis – FOUR-C<sup>1</sup>

The car is equipped with an extremely advanced active chassis system – Continuously Controlled Chassis Concept – that is regulated electronically. The functions of the system are based on a number of sensors that continually monitor the car's movements and reactions, such as vertical and lateral acceleration, vehicle speed and wheel movements.

The Four-C control unit analyses data from the sensors and performs the necessary shock absorber setting adjustments up to 500 times per second. This results in extremely fast and accurate individual shock absorber control, which contributes to variations in chassis characteristics.

Chassis characteristics can be modified at any time while driving, when the nature of the road changes or when you desire a change in driving style. This change occurs in a matter of milliseconds.

The effect produced by pressing the accelerator pedal is linked to your choice of chassis characteristics. (Only applies to R-models).

#### Comfort

Comfort mode adjusts the chassis setting so that the body is insulated from uneven sections of the road surface, which allows for better glide. Shock absorption is softer and body movements are minimal. This setting is recommended for long-distance driving or driving on slippery road surfaces.

When the ignition is switched off in Comfort setting, the chassis will resume the same mode when the car is re-started.

#### Sport

In Sport mode, steering responses are quicker than in Comfort mode. Damping is harder and the body follows the road surface to minimise rolling during quick cornering. The car feels sportier.

When the ignition is switched off in Sport setting, the chassis will resume the same mode when the car is re-started.

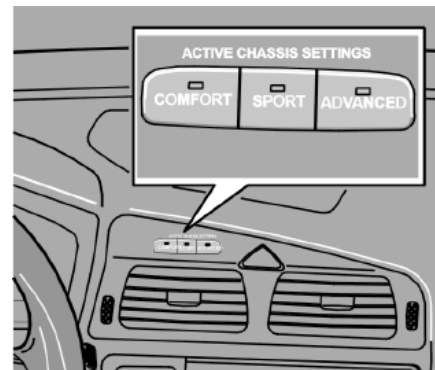

*Four-C switch (V70 R)*

#### Advanced<sup>2</sup>

In Advanced mode, shock absorber movements are minimal and optimised for maximum traction. Acceleration response is more direct, the automatic gearbox shift schedule is sportier and roll during cornering is minimised. This setting is recommended for flat, even road surfaces only.

When the ignition is switched off in Advanced setting, the chassis will resume the same mode when the car is re-started.

1. Option for certain markets. Standard on V70 R.

2. Only applies to V70 R.

## Parking assistance (option)

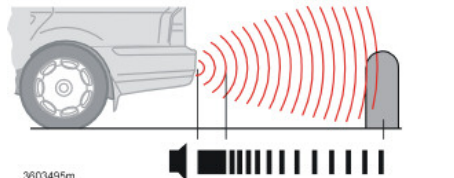
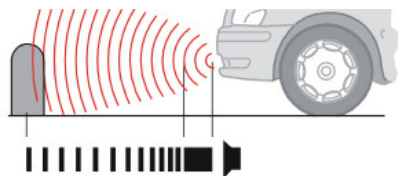

3603495m

*Parking assistance, front and rear*

### General

Parking assistance is used as an aid to parking. A signal indicates the distance to a detected object.

The frequency of the signal increases as you come closer to an object<sup>1</sup> in front of or behind the car.

The tone becomes constant at a distance of about 30 cm. If there are objects within this distance both behind and in front of<sup>1</sup> the car, the signal alternates between front and rear speakers.

1. Provided that the parking assistance is mounted both front and rear.

If the volume of another sound source from the audio system is high, this is automatically lowered.

The system is always activated when the car is started.

### **WARNING!**

Parking assistance does not relinquish the driver's own responsibility during parking. The sensors have blind spots where objects cannot be detected. Be aware of children and animals near the car.

### Front parking assistance

The measurement area straight in front of the car is approx. 0.8 m. The text message PARK ASSIST ACTIVE appears in the audio display when the sensors react to an obstacle in front of the car.

Front parking assistance cannot be combined with extra lights because the sensors are affected by the extra lights.

### Rear parking assistance

The measurement area straight behind the car is approx. 1.5 m. The text message PARK ASSIST ACTIVE appears in the audio display when the gear is engaged.

The system must be deactivated when driving with a trailer, bike carrier on the towbar or the like as they would trigger the sensors.

Rear parking assistance is deactivated automatically when towing a trailer if a Volvo genuine trailer cable is used.

## Parking assistance (option)

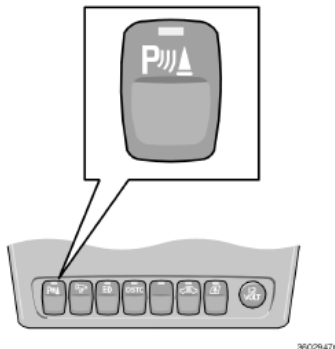

### Deactivating and reactivating the parking assistance

Parking assistance can be deactivated with the button in the switch panel. The LED in the switch goes out. Parking assistance is reactivated when the switch is turned on and the LED illuminates.

### Front parking assistance

The front parking assistance is active at speeds of below 15 km/h, even during reversing. The signal comes from the front loudspeakers.

### Rear parking assistance

Rear parking assistance is activated when reverse gear is engaged. The signal comes from the rear speakers.

### Fault indicator



**The information symbol comes on and stays lit**

**PARK ASSIST SERVICE**

**REQUIRED** is shown in the information display in the centre of the combined instrument panel together with the symbol.

REQUIRED is shown in the information display in the centre of the combined instrument panel together with the symbol.

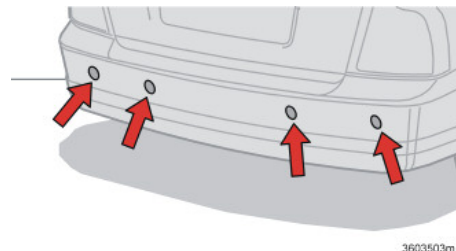

3603503m

### **IMPORTANT!**

In certain conditions the parking assistance system may produce incorrect warning signals that are caused by external sound sources that emit the same ultrasonic frequencies that the system works with. Examples of such sources include horns, wet tyres on asphalt, pneumatic brakes and motorcycle exhaust pipes. This does not indicate any fault in the system.

### *Parking assistance sensors*

### **Cleaning the sensors**

The sensors must be cleaned regularly to ensure that they work properly. Clean them with water and car shampoo.

The sensors can react if covered by ice and snow.

## Towing and recovery

### Do not bump start the engine

If you bump start a car with manual gearbox, the catalytic converter may be damaged.

Cars with automatic gearbox cannot be bump started. Use a booster battery if the battery is flat.

### If the car must be towed

- Unlock the steering wheel lock so that the car can be steered.

Keep in mind the highest legally permissible speed.

Bear in mind that the brake and power steering servos do not function when the engine is off. Approx. five times more pressure must be exerted on the brake pedal and steering requires much more force than usual.

- Drive gently.
- Keep the towline taut in order to avoid unnecessary jerking.

### For automatic gearboxes

- The gear selector should be in position **N**.
- The maximum permissible speed when towing a car with automatic gearbox is 80 km/h.
- Longest permitted distance: 80 km.
- The engine cannot be towed to start (bump started). See "Jump starting" on the next page.

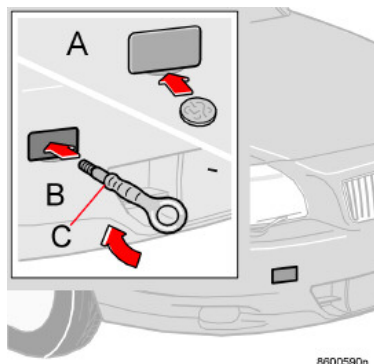

*Towing eye, front*

### Towing eye

The towing eye is located in the tool kit in the cargo area. You must screw the towing eye into place before towing. The sockets and covers for the towing eye are located on the right-hand side of each bumper.

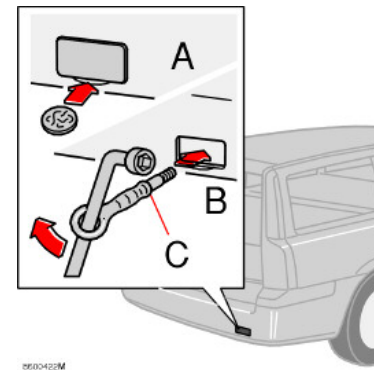

*Towing eye, rear*

### To fit the towing eye:

- A. Release the cover<sup>1</sup> by carefully prizing in the groove with a coin for example.
- B. Screw in the towing eye properly, right up to the flange (C). Use the wheel nut wrench.

After use, unscrew the towing eye and refit the cover.

1. The method of opening the cover may vary.

### Towing and recovery

To screw in the rear towing eye, you must first remove a plastic bolt from the bracket for the rear towing eye. Use the wheel nut wrench from the tool kit to unscrew the plastic bolt. Refit the plastic bolt after use.

#### Recovery

The towing eye may only be used for towing on roads, not for recovery after driving into a ditch or the like. Professional help should be called for recovery.

## Start assistance

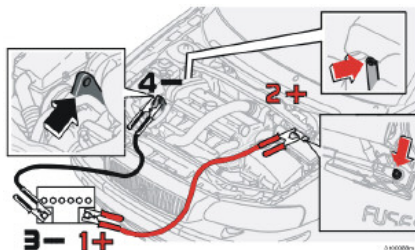

### Starting with a booster battery

If for some reason the battery in your car is discharged, you can "borrow" current from a spare battery or another car's battery to start the engine. Always check that the clamps are fastened properly to prevent sparking during the start attempt.

To avoid the risk of explosion, we recommend you do exactly as follows.

- Turn the ignition key to position **0**.
- Ensure that the other battery is 12 volt.
- If the booster battery is in another car, stop the engine of that car and make sure the cars are not touching.

- Connect the red cable between the booster battery positive terminal (1+) and the red connection in the engine compartment (2+). Attach the clamp to the contact point located beneath a small black cover with a plus sign which is integrated in the fuse box cover.
- Connect one clamp of the black cable to the negative terminal of the booster battery (3-).
- Connect the other clamp of the black cable to the lifting eye on your car's engine (4-).
- Start the engine of the "donor car". Let the engine run a few minutes at a speed slightly higher than idle 1500 rpm.
- Start the engine of the car with the flat battery.
- Remove the clamps in reverse order.

**NOTE!** Do not remove the clamps during the start attempt (risk of spark build-up).

- The towing bracket on the car must be of an approved type. Your Volvo dealer can advise you as to which towing bracket to use.
- Distribute the load on the trailer so that the weight on the towing bracket follows the specified maximum towball load.

### **WARNING!**

The battery can generate oxyhydrogen gas, which is highly explosive. One spark, which can be generated if you connect the jump leads incorrectly, is sufficient to make the battery explode.

The battery contains sulphuric acid, which can cause serious burns. If the acid comes into contact with eyes, skin or clothing, flush with large quantities of water. If acid splashes into the eyes, seek medical attention immediately.

- Increase tyre pressure so that it corresponds to the pressure for full load. See the tyre pressure table!
- Clean the towing bracket regularly and grease the towball<sup>1</sup> and all moving parts to prevent unnecessary wear.
- Do not drive with a heavy trailer when your car is brand new! Wait until it has driven at least 1000 km.
- The brakes are loaded much more than usual on long and steep downhill slopes. Downshift to a lower gear and adjust your speed.

1. Does not apply to ball hitch with vibration damper.

### Driving with a trailer

- If the car is driven with a heavy load in a hot climate, the engine and gearbox may overheat. The temperature gauge in the combined instrument panel goes into the red zone when the car overheats. Stop and let the engine idle for a few minutes.
- If the car overheats, the air conditioning system can be temporarily switched off.
- The gearbox reacts with a built-in protection function if the car overheats. See the message in the display!
- The engine is loaded more heavily than usual when driving with a trailer.
- For reasons of safety, you should not drive faster than 80 km/h, even if the laws of certain countries permit higher speeds.
- The highest trailer weight permitted for a trailer without brakes is 750 kg.
- If you park with a trailer, always set the gear selector to **P** (automatic gearbox) or put the car in a gear (manual gearbox). If you park on a steep hill, put chocks under the wheels.
- Avoid driving on inclines exceeding 12 % if the trailer weight exceeds 1200 kg. Do not drive with a trailer at all on inclines exceeding 15 %.

### Trailer weights

See page 231 for permitted trailer weights.

**NOTE!** The stated maximum permitted trailer weights are those permitted by Volvo. National vehicle regulations can further limit trailer weights and speeds. Towbars can be certified for higher towing weights than the car can actually tow.



### **WARNING!**

Follow the stated recommendations for trailer weights. Otherwise, the rig may be difficult to control during evasive manoeuvres and braking.

### Driving with trailer

#### - automatic gearbox

- When parking on hills, apply the parking brake before moving the gear selector to **P**. When starting on a hill, first put the gear selector in drive and then release the parking brake.
- Select a low gear in the gearbox when driving on steep inclines or when driving slowly. This prevents the gearbox from upshifting if you have an automatic gearbox. The gearbox oil will be cooler.
- If you have a Geartronic gearbox, do not use a higher manual gear than the engine can "handle". It is not always economical to drive in high gears.

**NOTE!** Some models require an oil cooler for the automatic gearbox when driving with a trailer. Check with your nearest Volvo dealer as to what applies to your car if you have a retrofitted towbar.

## Driving with a trailer

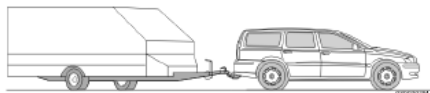

### Levelling

If your car is equipped with automatic levelling, the rear suspension always retains the correct ride height regardless of load. When the car is stationary, the rear suspension sinks. This is completely normal. When starting with a load, the level is pumped up after a certain distance.



## Towing equipment

### Towbars

The towball must be cleaned and greased regularly. If a towball hitch with vibration damper is used, it is not necessary to grease the towball.

If the car is equipped with a detachable towbar, the towball mounting instructions must be followed carefully, see page 134.

**NOTE!** Always take off the towball section after use. Keep it in the cargo area.

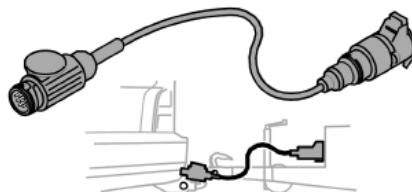

IMG-201504

#### **WARNING!**

Be sure to attach the trailer's safety cable to the correct place.

#### **WARNING!**

If the car is fitted with a Volvo detachable towbar: follow the assembly instructions for the towball section carefully. The towball section must be locked with the key before setting off. Check that the indicator window shows green.

### Trailer cable

An adapter is required if the car's towbar has 13 pin electrics and the trailer has 7 pin electrics. Use an adapter cable approved by Volvo. Make sure the cable does not drag on the ground.

## Towing equipment

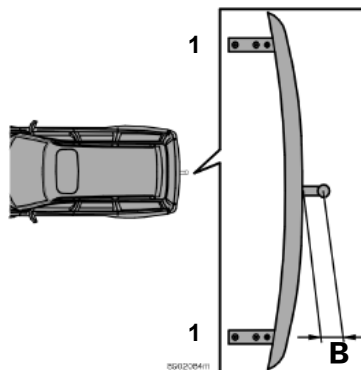
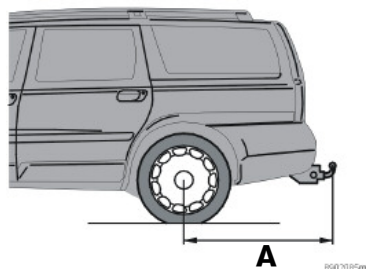

### Specifications

#### Distance A

Fixed towbar

V70/V70 AWD: 1094 mm

XC70: 1125 mm

Max. ball pressure: 75 kg

1. Attachment points under the car

#### Distance B

V70/V70 AWD, XC70: 70 mm

## Detachable towbar

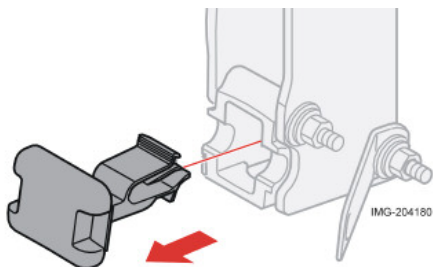

### Fitting the towball

1. Remove the guard plug.

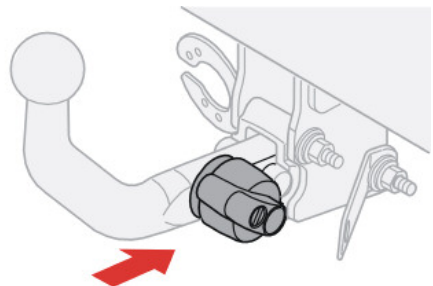

4. Insert the towball section until you hear a click.

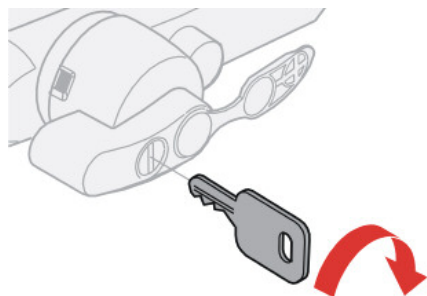

2. Ensure that the mechanism is in the unlocked position by turning the key clockwise.

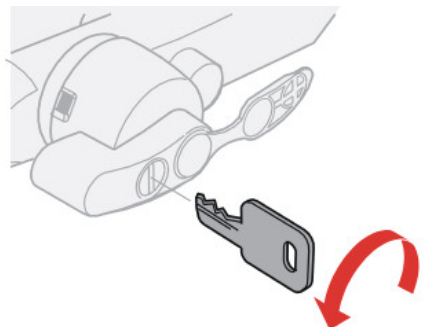

5. Turn the key anticlockwise to the locked position. Remove the key from the lock.

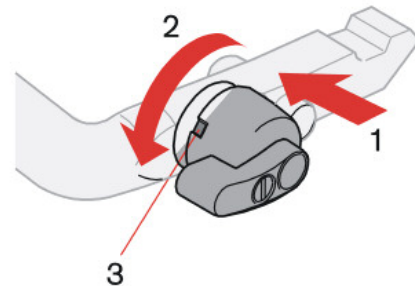

3. Check that the indicator window (3) shows red. If the window does not show red, press in (1) and turn the locking wheel anticlockwise (2) until you hear a click.

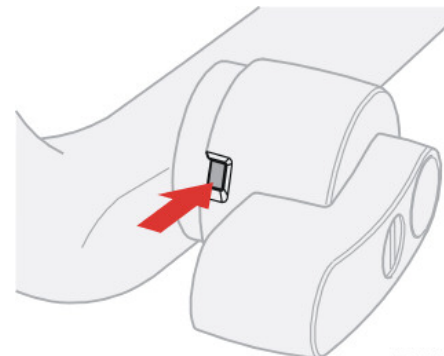

6. Check that the indicator window shows green.

## Detachable towbar

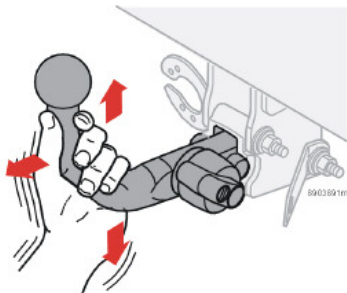

7.

Check that the towball section is secure by pulling it up, down and back. If the towball section is not fitted correctly then it must be removed and refitted in accordance with the previous steps.

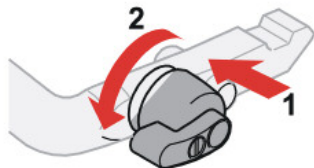

2. Push in the locking wheel and turn it anti-clockwise until you hear a click.

IMG-204188

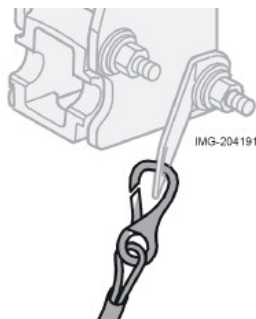

8.

**NOTE!** The trailer's safety cable must be attached to the attachment on the towbar.

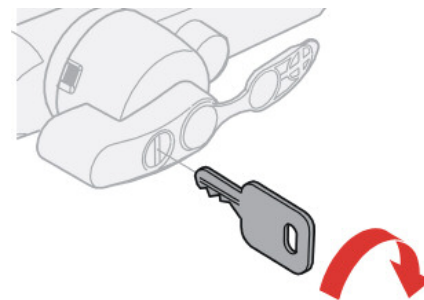

### Removing the towball

1. Insert the key and turn it clockwise to the unlocked position.

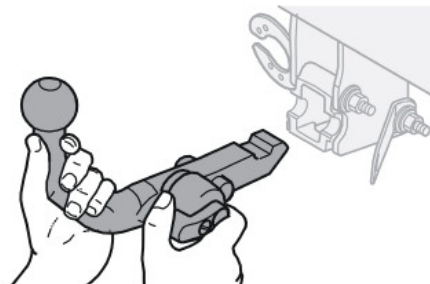

3. Turn the locking wheel down fully, until it comes to a stop. Hold it in this position while pulling the towball rearward and upward.

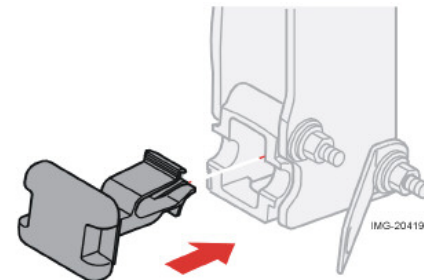

4. Insert the guard plug.

### Load on the roof

#### General

The load capacity is affected by extra accessories mounted on the car, such as a towbar, the load on the towball (75 kg with trailer hitched), load carriers and roof box, as well as the passengers' combined weight. The car's load carrying capacity is reduced by the number of passengers and their weight.

#### **WARNING!**

The car's driving characteristics change depending on how heavily it is loaded and how the load is distributed.

#### **WARNING!**

Load no more than 100 kg on the roof, inclusive of the load carriers or space box. The car's centre of gravity and driving characteristics are altered by roof loads.

#### Using load carriers (accessory)

To avoid damaging your car and to achieve the best level of safety when driving, we recommend that you only use load carriers that Volvo has specially designed for your car.

- Check periodically that the load carriers and load are properly secured. Lash the load securely with retaining straps.
- Distribute the load evenly over the load carriers. Do not load lopsidedly. Place the heaviest items at the bottom.
- Remember that the car's centre of gravity and driving characteristics change if you have a load on the roof.

- Keep in mind that the car's wind resistance and fuel consumption increase in proportion to the size of the load.
- Drive gently. Avoid quick accelerations, heavy braking and taking curves hard.
- Remove the load carrier when it is not in use. This reduces wind resistance and fuel consumption.

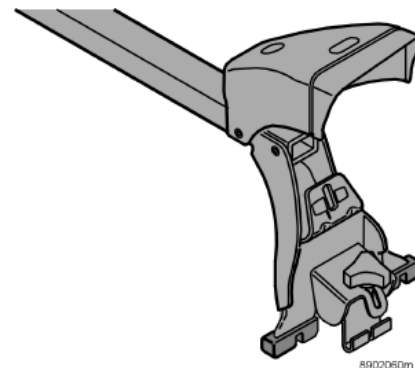

#### Fitting load carriers

- Make sure the load carrier is placed in the right direction (see the marking on the decal under the cover).

## Load on the roof

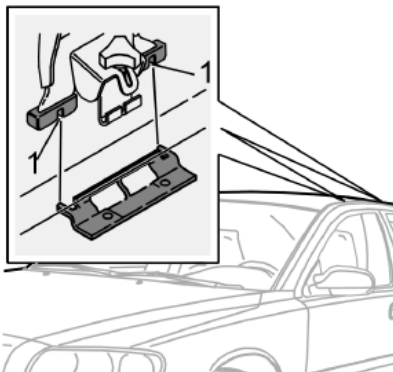

- Replace the cover.
- Check that the roof rack is properly secured.
- Check the knobs regularly to see that they are properly tightened.

- Fit the guide pins into the guide holes (1).
- Carefully lower the bracket on the other side to the roof.
- Screw the knob up a bit.
- Press the knob against the roof bracket and catch the hook in the roof bracket under the roof rail.
- Screw the load carrier in place.
- Fit the guide pins of the other brackets into the guide holes.
- Screw the load carrier in place.
- Check that the hook is properly secured in the roof bracket.
- Tighten the knobs alternately until the carrier feels secure.

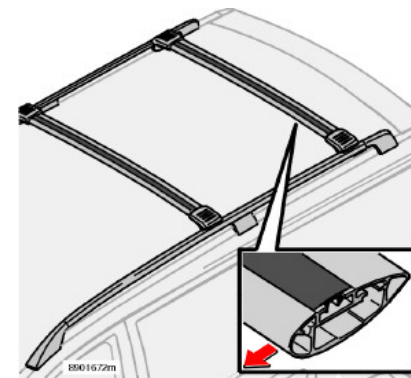

### Load carriers' location - roof rails

Make sure that the load carriers are placed the right way round on the roof rails. The load carriers can be placed anywhere along the roof rail.

When driving without a roof load, the front load carrier should be positioned about 50 mm in front of the centre roof mounting and the rear load carrier positioned about 35 mm in front of the rear roof mounting (illustrated above). This is to keep wind noise to a minimum.

## Load on the roof

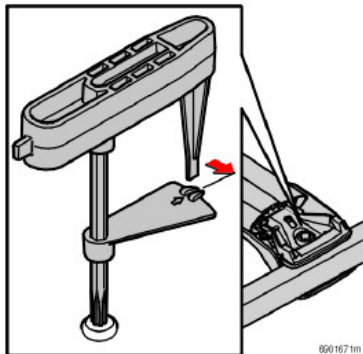

### Fitting load carriers

Make sure that the load carrier sits correctly against the roof rail. Screw on the load carrier using the enclosed torque wrench. Tighten to the marking on the torque wrench (corresponds to 6 Nm). See illustration.

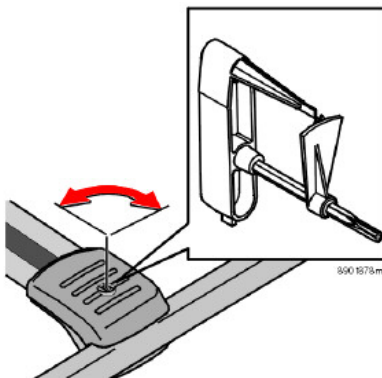

### Load carrier cover

Use the end of the torque wrench (see illustration) or the ignition key to loosen or secure the cover. Rotate  $\frac{1}{4}$  turn.

## Adjusting headlamp pattern

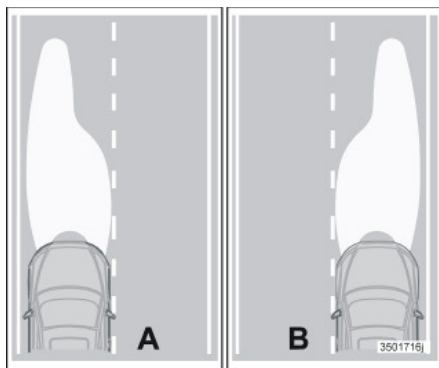

*A. Headlamp pattern for left-hand traffic*

*B. Right-hand traffic*

### Correct light pattern for left or right-hand traffic

So as not to dazzle oncoming drivers, the headlamp beam pattern can be altered by masking the headlamps. The quality of the beam pattern may not be as good.

### Headlamp masking

Copy the templates and transfer the pattern to a self-adhesive, waterproof material such as opaque tape or the like.

The mask is positioned using the dot (5) in the headlamp lens as a reference point. The

reference measurement (X) indicates the distance from the dot (5) to the corner of the mask, marked with an arrow.

After copying the templates located on the next page, check the measurements so that the reference measurements cover enough of the beam pattern.



## Adjusting headlamp pattern

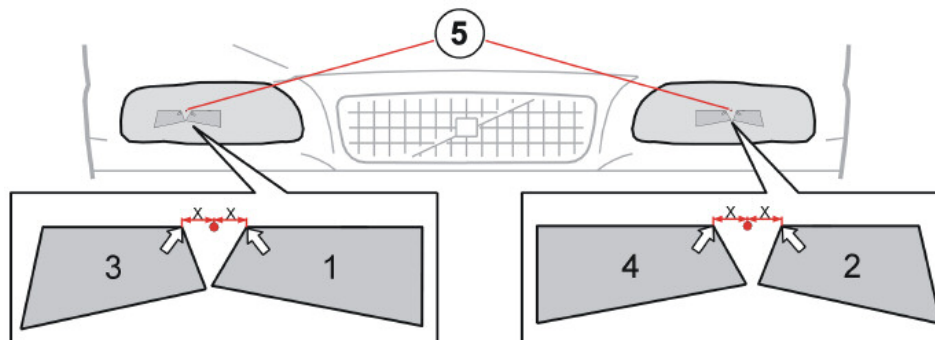

3501783m

*Location of halogen headlamp masks, 1 and 2 = LHD variant, 3 and 4 = RHD variant*

### Halogen headlamps, LHD variant

Copy templates 1 and 2. Check the measurements to ensure they are correct. Transfer the template to a self-adhesive, waterproof material and cut it out.

#### Reference measurements:

Template 1. (3) = 70 mm, (4) = 40 mm

Distance to dot in headlamp lens:

(5) = 13 mm.

Template 2. (6) = 55 mm, (7) = 40 mm

Distance to dot in headlamp lens:

(8) = 18 mm.

### Halogen headlamps, RHD variant

Copy templates 3 and 4. Check the measurements to ensure they are correct. Transfer the template to a self-adhesive, waterproof material and cut it out.

#### Reference measurements:

Template 3. (1) = 55 mm, (2) = 41 mm

Distance to dot in headlamp lens:

(5) = 17 mm.

Template 4. (6) = 70 mm, (7) = 39 mm

Distance to dot in headlamp lens:

(8) = 14 mm.

## Adjusting headlamp pattern

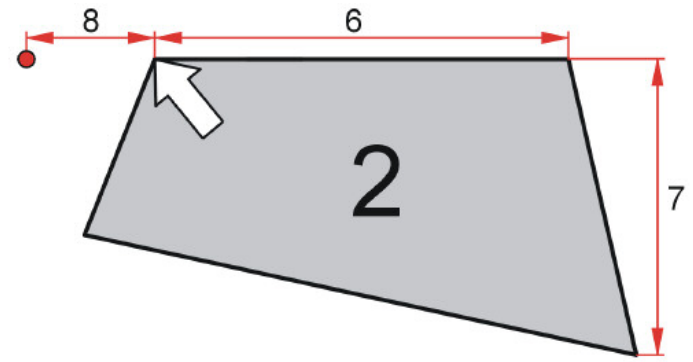
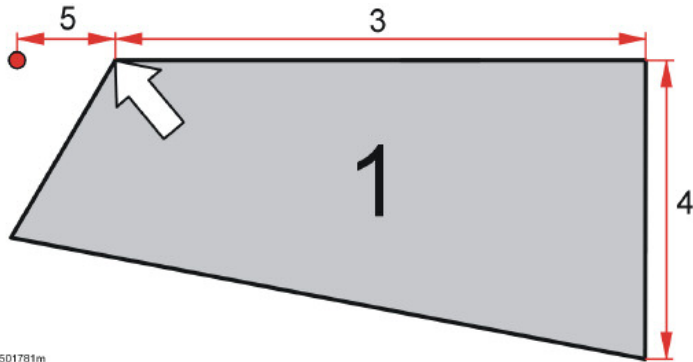

3501781m

Masking templates for halogen headlamps, LHD variant

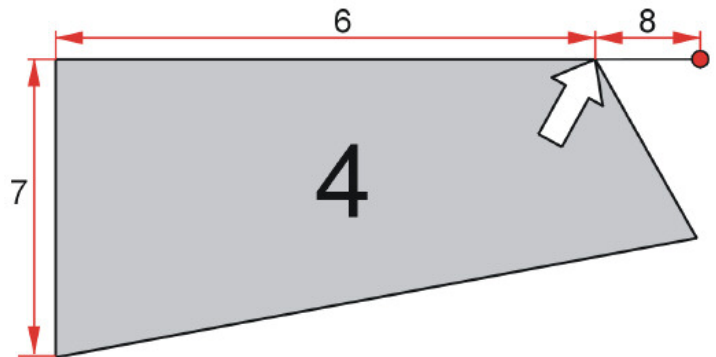
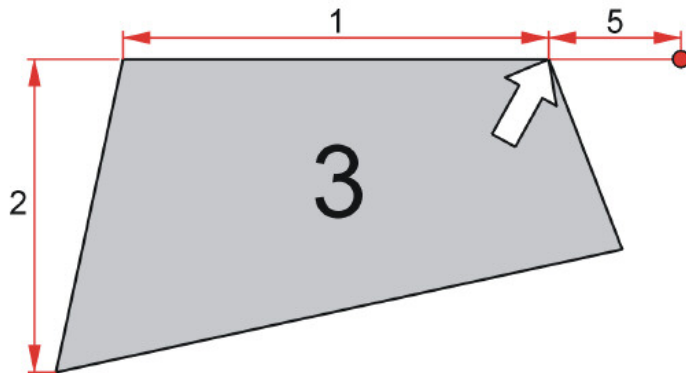

3501784n

Masking templates for halogen headlamps, RHD variant

## Adjusting headlamp pattern

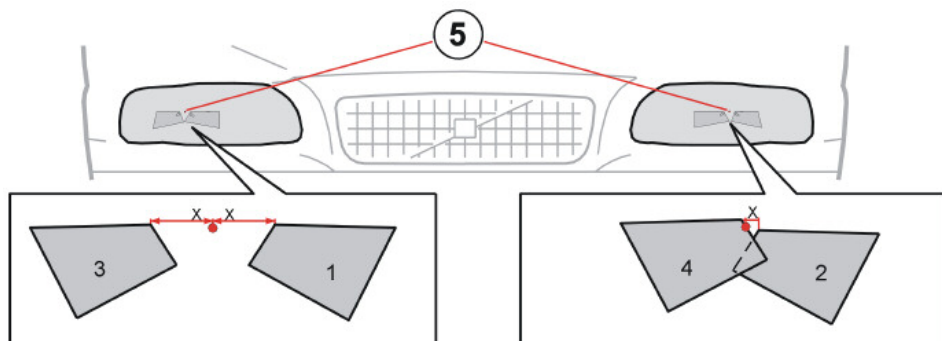

3501805m

Location of Bi-Xenon headlamp masks, 1 and 2 = LHD variant, 3 and 4 = RHD variant

### Headlamp masking

Copy the templates and transfer the pattern to a self-adhesive, waterproof material such as opaque tape or the like.

The mask is positioned using the dot (5) in the headlamp lens as a reference point. The reference measurement (X) indicates the distance from the dot (5) to the corner of the mask.

After copying the templates located on the next page, check the measurements so that the reference measurements cover enough of the beam pattern.

### Bi-Xenon headlamps, LHD variant

Copy templates 1 and 2. Check the measurements to ensure they are correct. Transfer the template to a self-adhesive, waterproof material and cut it out.

#### Reference measurements:

Template 1. (3) = 56 mm, (4) = 43 mm

Distance to dot in headlamp lens:  
(5) = 29 mm.

Template 2. (6) = 56 mm, (7) = 42 mm

Distance to dot in headlamp lens:  
(8) = 6 mm.

### Bi-Xenon headlamps, RHD variant

Copy templates 3 and 4. Check the measurements to ensure they are correct. Transfer the template to a self-adhesive, waterproof material and cut it out.

#### Reference measurements:

Template 3. (1) = 56 mm, (2) = 42 mm

Distance to dot in headlamp lens:  
(5) = 29 mm.

Template 4. (6) = 56 mm, (7) = 41 mm

Distance to dot in headlamp lens:  
(8) = 0 mm.

## Adjusting headlamp pattern

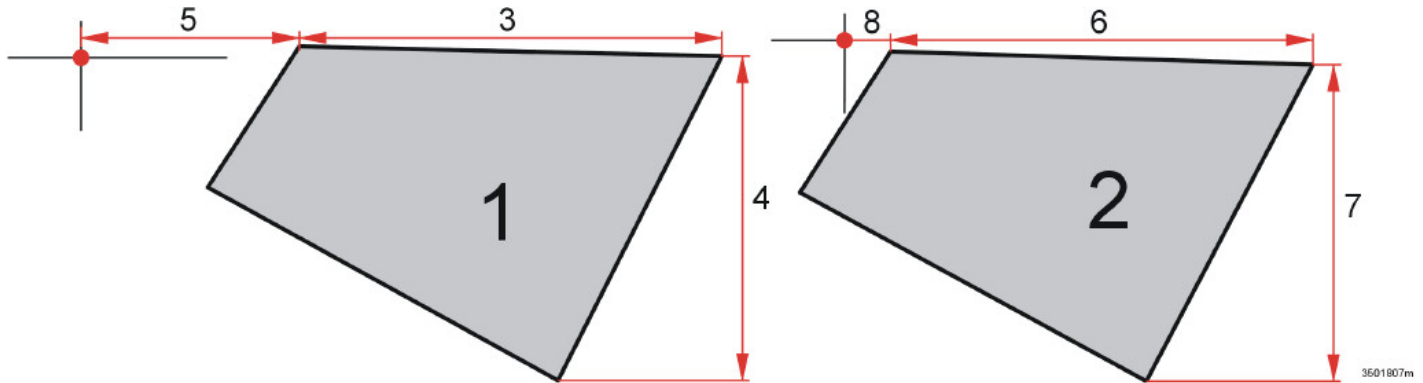

3501807m

Masking templates for Bi-Xenon headlamps, LHD variant

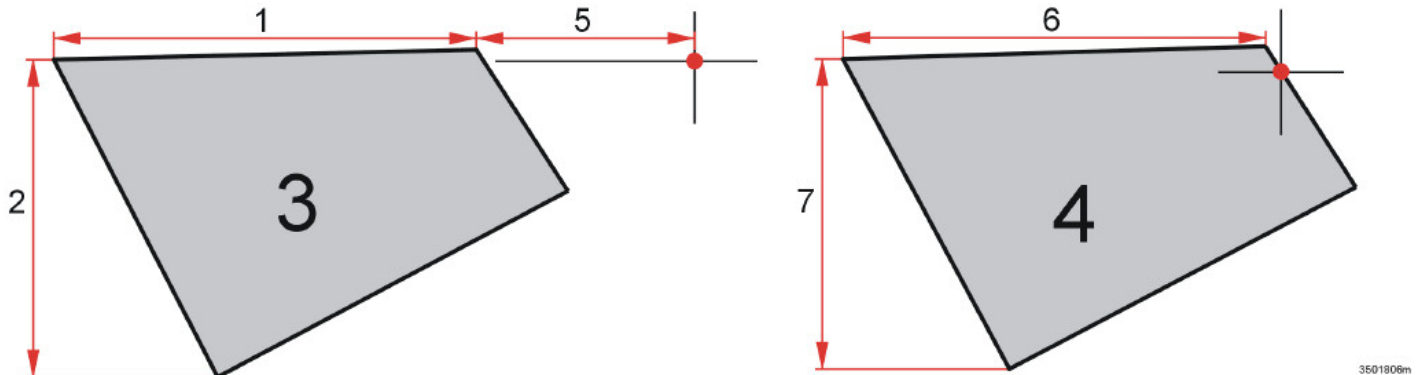

3501806m

Masking templates for Bi-Xenon headlamps, RHD variant

## BLIS (Blind Spot Information System) - option

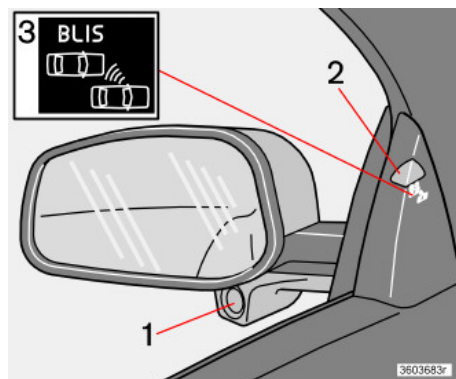

1 - BLIS camera, 2 - Indicator lamp, 3 - BLIS symbol

### BLIS

BLIS is an information system which indicates whether there is another vehicle moving in the same direction in the so-called "blind spot".

#### **WARNING!**

The system is a supplement to, and not a replacement for, the existing rearview mirrors. It can never replace the awareness and responsibility of the driver. The responsibility for changing lanes safely rests with the driver.

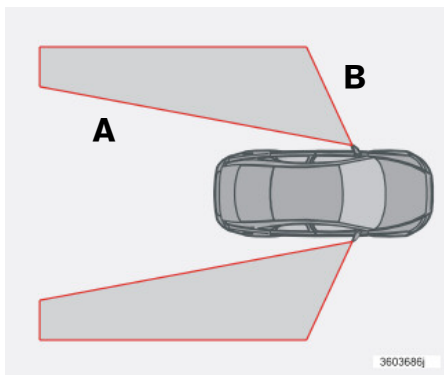

"Blind spots" covered by BLIS

Distance A = approx. 9.5 m

Distance B = approx. 3 m

The system is designed to work most effectively when driving in dense traffic on multi-lane highways.

BLIS is based on digital camera technology. The cameras (1) are fitted under the door mirrors.

When a camera has detected a vehicle inside the blind spot zone then an indicator lamp is lit in the door panel (2). The light comes on with a constant glow to draw the driver's attention to a vehicle in the blind spot.

**NOTE!** The lamp comes on on the side of the car where the system has detected the vehi-

cle. If the car is overtaken on both sides at the same time then both lamps come on.

BLIS also has an integrated function which warns the driver if a fault should arise in the system. If, for example, the system's cameras are obscured then the BLIS indicator lamp flashes and a message is shown in the dashboard display (see the table on page 146). In such cases, check and clean the lenses. If necessary, the system can be switched off temporarily by pressing the BLIS button (see page 146).

### When BLIS operates

The system operates when the car is driven at a speed above 10 km/h.

### When you overtake another vehicle

- The system reacts if you overtake another vehicle at a speed of **up to 10 km/h faster** than the other vehicle.

### When you are overtaken by another vehicle

The system reacts if you are overtaken by a vehicle travelling up to 70 km/h faster than you are travelling.

## BLIS (Blind Spot Information System) - option

### **WARNING!**

- BLIS does not work in sharp bends.
- BLIS does not work when the car is reversing.
- A wide trailer coupled to the car can conceal other vehicles in adjacent lanes. It can prevent vehicles in the screened area from being detected by BLIS.

### **System function in daylight and darkness**

#### ***Daylight***

In daylight the system reacts to the **shape** of the surrounding vehicles. The system is designed to detect motor vehicles such as cars, trucks, buses and motorcycles

#### ***Darkness***

In darkness the system reacts to the **headlamps** of surrounding vehicles. If its headlamps are not switched on then the system does not detect the vehicle. This means for example that the system does not react to a trailer without headlamps which is towed behind a car or truck.

### **WARNING!**

- The system does not react to bicycles or mopeds.
- The BLIS cameras can be disrupted by intensive light or when driving in the dark when there are no light sources (e.g. street lighting or other vehicles). The system may then interpret the lack of light as if the cameras have been blocked. In both cases a message is shown in the dashboard display. When driving in such conditions the system can be temporarily switched off (see the information on the next page). When the text message has faded out then the system returns to full function.
- The BLIS cameras have the same limitations as the human eye, i.e. they "see" worse in heavy snowfall or thick fog for example.

### **Cleaning**

In order to work most effectively the BLIS camera lenses must be clean. The lenses can be cleaned with a soft cloth or damp sponge. Clean the lenses carefully so that they are not scratched.

### **IMPORTANT!**

- The lenses are electrically heated to melt ice or snow. If necessary, brush snow away from the lenses.

## BLIS (Blind Spot Information System) - option

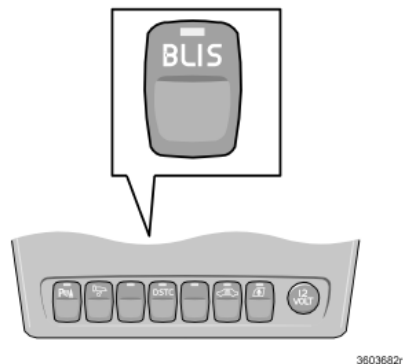

### Switching off and reactivating BLIS

- BLIS is activated automatically each time the ignition is switched on. The indicator lamps in the door panels flash three times when the ignition is switched on.
- The system can be switched off by pressing the BLIS button in the switch panel in the centre console (see illustration above). The LED in the button goes out when the system is switched off and a text message is shown in the display in the dashboard.
- BLIS can be reactivated by pressing the button. An LED in the button then comes on, a new text message is shown in the display and the indicator lamps in the

door panels flash three times. Press the READ button, see page 44, to clear the text message.

<b>BLIS system messages</b>	
<b>System status</b>	<b>Text in the display</b>
BLIS not functioning	BLIND-SPOT SYST SERVICE REQUIRED
Right-hand camera blocked	BLIND-SPOT SYST R CAMERA BLOCKED
Left-hand camera blocked	BLIND-SPOT SYST L CAMERA BLOCKED
Both cameras blocked	BLIND-SPOT SYST CAMERAS BLOCKED
BLIS system off	BLIND-SPOT INFO SYSTEM OFF
BLIS system on	BLIND-SPOT INFO SYSTEM ON
BLIS function reduced	BLIS FUNCTION REDUCED

The messages above are only shown if the ignition key is in position **II** (or if the engine is running) and BLIS is active (i.e. if the driver has not switched off the system).

---

## **Wheels and tyres**

<b>General</b>	<b>148</b>
<b>Tyre pressure</b>	<b>151</b>
<b>Warning triangle and spare wheel</b>	<b>152</b>
<b>Changing wheels</b>	<b>154</b>



### General

#### Driving characteristics and tyres

The tyres greatly affect the car's driving characteristics. The type of tyre, dimensions, tyre pressure and speed rating are important for how the car performs.

When changing tyres, ensure that tyres of the same type and dimensions, and preferably also the same make, are fitted to all four wheels. Follow the recommended tyre pressures specified on the tyre pressure label, see page 151.

#### Designation of dimensions

The dimensions are stated on all car tyres. Example: 205/55R16 91 W.

205	Section width (mm)
55	Ratio between section height and width (%)
R	Radial ply
16	Rim diameter in inches (")
91	Tyre load index (in this case 615 kg)
W	Speed rating (in this case 270 km/h).

#### Speed ratings

The car is approved as a whole, which means that dimensions and speed ratings must not differ from those specified on the vehicle's registration document. The only exception to these conditions is winter tyres (both those

with studs and those without). If such a tyre is chosen, the car must not be driven faster than the speed rating of the tyre (for example, class Q can be driven at a maximum of 160 km/h). Remember that traffic regulations determine how fast a car can be driven, not the speed class of the tyres.

Note! Maximum permitted speeds indicated.

Q	160 km/h (used only on winter tyres)
T	190 km/h
H	210 km/h
V	240 km/h
W	270 km/h

#### New tyres



Tyres are perishable. After a few years they begin to harden at the same time as the friction capacity/characteristics gradually deteriorate. Therefore aim to get as fresh tyres as possible when you replace them. This is especially important with regard to winter tyres. The week and year of manufacture, the tyre's DOT marking (Department of Transportation), are stated with four digits, for example 1502. The tyre in the illustration was manufactured in week 15 of 2002.

#### Tyre age

All tyres older than six years should be checked by an expert even if they seem undamaged. The reason for this is that tyres age and decompose, even if they are hardly ever or never used. The function can therefore be affected due to the tyre's constituent materials being broken down, and it should then not be used.

This also applies to spare tyres, winter tyres and tyres saved for future use.

Examples of external signs which indicate that the tyre is unsuitable for use are cracks or discolouration.

The age of the tyre can be determined by the DOT marking, see illustration above.

## General

### Tyres with tread wear indicators



Tread wear indicators are narrow treadless bands across the width of the tread. On the side of the tyre are the letters TWI (tread wear indicator). When only

1.6 mm of tread remains, this band is clearly visible. Change the tyres as soon as possible. Remember that tyres with little tread depth provide very poor grip in rain and snow.

### Winter tyres

Volvo recommends winter tyres with particular dimensions. These are stated on the tyre pressure label, see page 151 for its location. The tyre dimensions are dependent on the engine variant. When driving on winter tyres, these must be fitted to all four wheels.

**NOTE!** Ask a Volvo dealer which rim and tyre types are most suitable.

### Studded tyres

Studded winter tyres should be run in gently for 500-1000 km so the studs settle properly into the tyre. This gives the tyre, and especially the studs, a longer lifespan.

**NOTE!** The legal provisions for the use of studded tyres vary from country to country.

### Tread depth

Road conditions with ice, slush and low temperatures place considerably higher demands on tyres than summer conditions. It is therefore not recommended to drive on winter tyres that have a tread depth of less than four millimetres.

### Snow chains

Snow chains may only be used on the front wheels. This also applies to all-wheel-drive cars.

Never drive faster than 50 km/h with snow chains. Avoid driving on bare ground as this wears out both the snow chains and tyres. Never use quick-fit snow chains as the space between the brake disks and the wheels is too small.

### IMPORTANT!

Use Volvo genuine snow chains or equivalent chains designed for the car model, and tyre and rim dimensions. Consult an authorised Volvo workshop.

### Locking wheel bolts

Locking wheel bolts can be used on both aluminium and steel rims. If steel rims with locking wheel bolts are used in combination with wheel covers then the locking wheel bolts must be fitted furthest from the air valve. Otherwise the wheel cover cannot be fitted on the rim.

### General

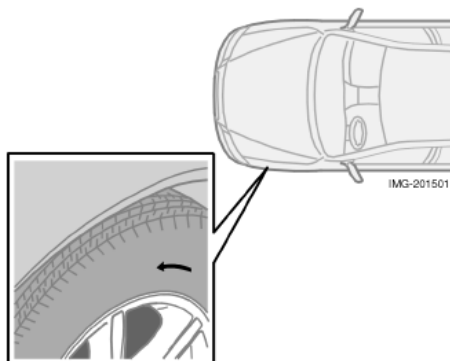

*The arrow shows the tyre's direction of rotation.*

### Summer and winter wheels

When summer and winter wheels are changed they should be marked with which side of the car they were mounted on, for example **L** for left and **R** for right. Tyres with a tread pattern which are designed to only turn in one direction have the direction of rotation marked with an arrow on them. The tyre should always rotate in the same direction throughout its lifespan. Tyres should only be switched between front and rear positions, never between left and right-hand sides, or vice versa. If the tyre is mounted incorrectly, the car's braking characteristics and capacity to force rain, snow and slush out of the way

are adversely affected. Tyres with the greatest tread depth should always be fitted to the rear of the car (to decrease the risk of skidding.)

Wheels should be stored lying down or hanging up, and not standing up.

Contact an authorised Volvo workshop if you are uncertain about tread depth.

## Tyre pressure

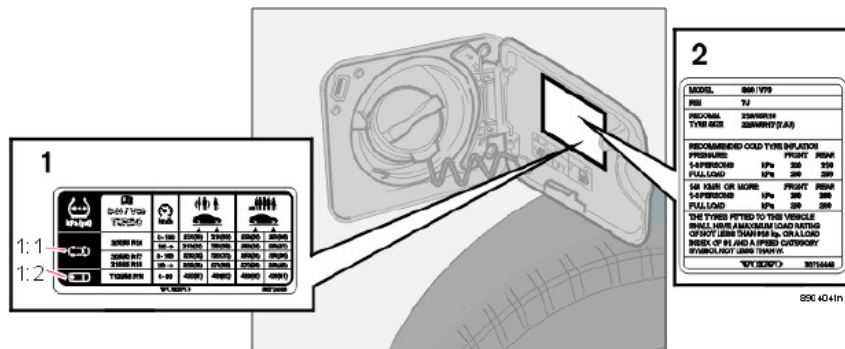

### Recommended tyre pressure

The tyre pressure decal on the inside of the fuel filler flap shows what pressure the tyres should have with different load and speed conditions.

- Other markets (not USA, Canada)
  - Volvo original tyre
  - Spare tyre
- Australia

### Checking the tyre pressure

Check the tyre pressure regularly. The correct tyre pressure is shown in the tyre pressure table. The stated tyre pressures refer to cold tyres. (Cold tyres mean the tyres are the same temperature as the ambient temperature.)

Driving with the wrong tyre pressure adversely affects the car's driving characteristics and can increase tyre wear. After just a few kilometres of driving, the tyres warm up and the pressure increases. Therefore air should not be released if the pressure is checked when the tyres are warm. However the pressure should be increased if it is too low.

### Warning triangle and spare wheel

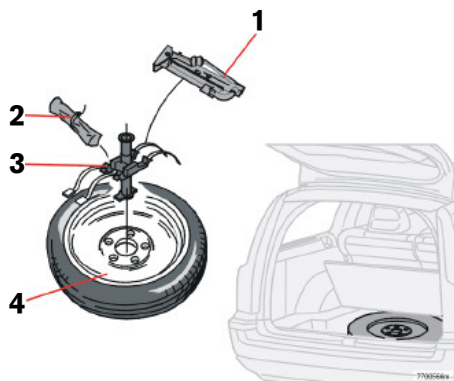

- Lift out the jack and tool kit.
- Unscrew the spare wheel and lift it out.
- Return and secure everything in reverse order. Make sure that the spare wheel is securely in place and that the jack and tool kit are properly secured.

### Temporary spare

The spare wheel<sup>1</sup> "Temporary Spare" should only be used for the short time it takes to repair or replace the normal tyre.

By law, it is only legal to use the spare wheel/tyre temporarily in connection with damage to a tyre. A wheel/tyre of this type should be replaced with a normal wheel/tyre as soon as possible.

Remember also that this tyre combined with the normal tyres will affect driving characteristics. The maximum speed with the "Temporary Spare" spare wheel is therefore 80 km/h.

**NOTE!** Only use the car's own genuine spare wheel! Tyres with other dimensions may cause damage to your car. Only one spare wheel may be used at a time.

### Spare wheel, tools and jack

1. Jack
2. Tool kit with towing eye
3. Mounting
4. Spare wheel

The spare wheel<sup>1</sup> and jack and tool kit are located under the floor of the cargo compartment. Remove the spare wheel as follows.

- Remove the rear floor hatch by folding it up approx. 45° and pulling back. Lock the front floor hatch in raised position.
- Undo the screws in the plastic trough (accessory) and lift it out.

1. Certain variants and markets

## Warning triangle and spare wheel

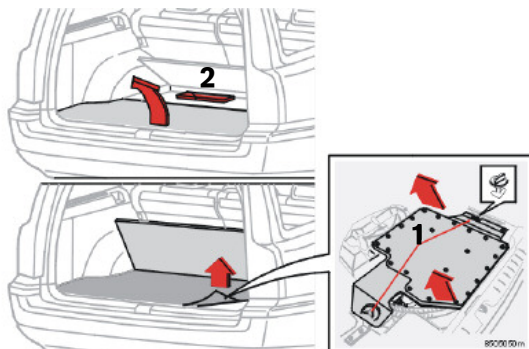

### Warning triangle (certain countries)

1. Clips
2. Warning triangle (different location for cars with extra seat)

Follow the regulations in force regarding the warning triangle for the country you are driving in.

**NOTE!** If the car is equipped with an extra seat in the cargo compartment then the warning triangle (2) is located in a special compartment in the front section of the spare wheel trough.

### Spare wheel, tools, jack - cars with auxiliary bass speaker (option)

The jack and tool kit are located in a compartment above the spare wheel. Remove the spare wheel as follows.

- Remove the rear floor hatch by folding it up approx. 45 degrees and pulling back. Lift out the front floor hatch.
- Remove the carpet over the bass speaker.
- Loosen the wheel and turn the clip (1) 90 degrees.
- Lift up the bass speaker while gripping the upper right and rear left-hand corner.

Lift up and in, and then let the bass speaker rest against the left-hand side in the cargo compartment.

- Refit and secure everything in reverse order. Make sure that the spare wheel is securely in place and that the jack and tool kit are properly secured.

### Changing wheels

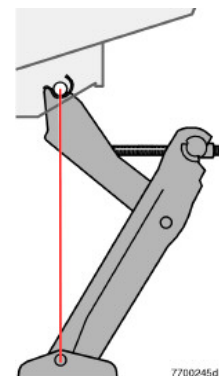
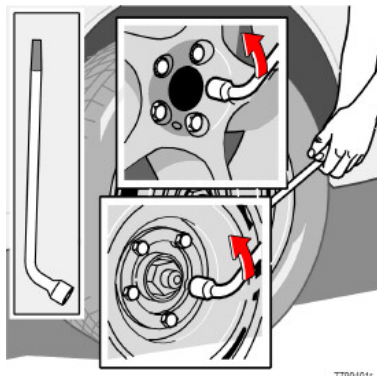
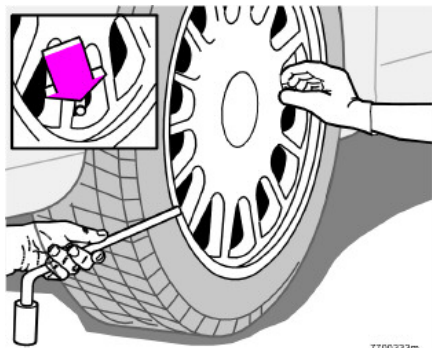

#### Removing a wheel

Remember to set out the warning triangle if you must change a wheel in a trafficked area. The spare wheel is under the plastic trough in the cargo compartment.

- Apply the parking brake and engage 1st gear if the car has a manual gearbox - **P** if it has automatic gearbox. Place chocks on either side the wheels remaining on the ground; use heavy wooden blocks or large stones.
- Cars with steel wheel rims have removable wheel covers. Prize off the wheel cover with a thick screwdriver or similar. If tools are not available, the wheel cover can be prized off by hand. Use protective gloves. When refitting the wheel cover, make sure the cover is properly aligned over the air valve.
- Loosen the wheel bolts 1/2-1 with the socket wrench. Loosen the nuts by turning them anticlockwise.
- There are two jacking points on each side of the car. Hold the jack against the pin in the jacking point as illustrated and crank the foot of the jack down so it is pressed squarely on the ground. Check that the jack sits in the anchorage as illustrated and that the foot is positioned vertically under the anchorage.
- Lift the car so that the wheel is free. Remove the wheel nuts and lift off the wheel.

## Changing wheels



7700244d

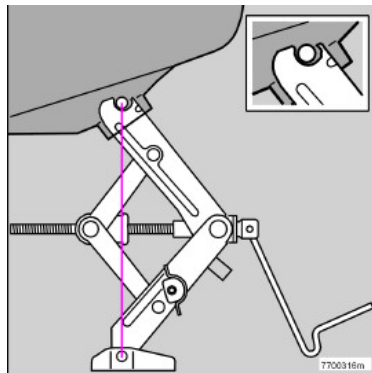

*Jack designed for cars with all-wheel drive.*

### Fitting the wheel

- Clean the contact surfaces on the wheel and hub.
- Fit the wheel. Screw the wheel nuts.
- Lower the car so that the wheel cannot rotate.
- Tighten the wheel nuts alternately. It is important that the wheel nuts are tightened properly. Tighten to 140 Nm. Check the torque with a torque spanner.
- Put on the wheel cover (steel rim).



### **WARNING!**

Never crawl under the car when it is raised on the jack.

Passengers must leave the car when it is raised on the jack.

Ensure that passengers wait with the car - or preferably a crash barrier - between them and the road.





---

**Car care**

<b>Cleaning</b>	<b>158</b>
<b>Touching up paintwork</b>	<b>160</b>
<b>Rustproofing</b>	<b>162</b>

## Cleaning

### Washing the car

Wash the car as soon as it becomes dirty, especially in the winter when road salt and moisture can lead to corrosion.

Wash the car as follows:

- Do not park the car in direct sunshine. Washing a car with hot paintwork can cause permanent paintwork damage. Wash the car in a car wash with waste water separator.
- Thoroughly rinse dirt off the underbody of the car.
- Rinse the entire car to remove loose dirt. When using a high-pressure washer, make sure that its nozzle is not closer than 30 cm to the bodywork. Do not spray directly at the locks.
- Wash with a sponge using a lot of water with or without detergent.
- Use warm water (max. 35 °C), not water that is too hot.
- If the dirt is ingrained, you can wash the car with cold degreasing agent, but be sure that there is a waste water separator where you are washing the car. When using cold degreasing agent, make sure that the car is not in direct sunlight and that the paint is not warm due to sunlight

or a warm engine. Sunlight and heat can cause permanent damage. Consult a Volvo workshop.

- Dry the car with a clean, soft chamois.
- Clean the wiper blades with a lukewarm soap solution.

### Suitable detergent

Car shampoo.

Keep the following in mind:

- Always remove bird droppings from the paintwork as soon as possible. Bird droppings contain chemicals that can affect and discolour paintwork very quickly. Discoloration cannot be removed with polish.

### IMPORTANT!

Sharp objects and Velcro may damage the fabric upholstery.



### WARNING!

Do not wash the engine while it is warm. Risk of fire! Entrust engine washing to an authorised Volvo workshop.

### Automatic car washes

An automatic car wash is a simple and quick way of washing the car. Bear in mind, however, that an automatic car wash can never replace a proper handwashing – the brushes of a car wash cannot reach everywhere.

### IMPORTANT!

Washing by hand is gentler to the paintwork than an automatic car wash. The paintwork is also more sensitive when it is new. For this reason, handwashing is recommended during the first few months with a new car.



### WARNING!

After washing: always test the brakes so that moisture and corrosion do not affect the brake lining and impair the brakes! Lightly depress the brake pedal now and then when driving long distances in rain or slush so that the brake lining warms and dries. You should also do this when you begin driving after damp or cold weather.

## Cleaning

### Exterior plastic parts

A special cleaning agent, available from Volvo dealers, is recommended for cleaning exterior plastic parts. Never use strong stain removers.

### Cleaning the interior

#### Treating spots on fabric upholstery

A special cleaning agent, available from Volvo dealers, is recommended for cleaning the fabric upholstery. Other chemicals can impair the fire retardant qualities of the upholstery.

#### **IMPORTANT!**

Sharp objects and Velcro may damage the fabric upholstery.

#### Treating spots on leather upholstery

A special cleaning agent, available from Volvo dealers, is recommended when cleaning leather upholstery. Treat the leather upholstery once or twice a year using Volvo's leather care kit. Never use strong solvents. Such products may damage fabric, vinyl and leather upholstery.

#### Treating spots on interior plastic parts and surfaces

A special cleaning agent, available from Volvo dealers, is recommended for cleaning interior

plastic parts and surfaces. Do not scrape or rub spots. Never use strong stain removers.

### Cleaning seatbelts

Use water and a synthetic detergent. A special textile cleaning agent is available from Volvo dealers. Make sure the seatbelt is dry before allowing it to retract.

### Polishing and waxing

Polish and wax the car when you feel the paintwork is matte and when you wish to give the paintwork extra protection, such as before winter.

The car does not usually need polishing until after one year. It can be waxed earlier.

Wash and dry the car thoroughly before you begin polishing and/or waxing. Clean of asphalt and tar stains with white spirit. More stubborn marks can be removed with fine rubbing paste designed for paintwork. Polish first with a polish and then wax with fluid or solid wax. Carefully follow the instructions on the package. Many preparations contain both polish and wax.

Do not polish or wax surfaces warmer than 45 °C.

### Cleaning door mirrors and front door windows with water-repellent coating (option)

Never use products such as car wax, degreaser or the like on mirror/ glass surfaces as this could ruin their water-repelling properties.

Take care when cleaning so as not to damage the glass surface.

To avoid damaging glass surfaces when removing ice – only use plastic ice scrapers.

There is natural wear of the water-repellent coating.

**NOTE!** Treatment with a special finishing agent available from Volvo dealers is recommended in order to maintain the water-repellent properties. This should be used first after three years and then each year.

## Touching up paintwork

### Paintwork

Paint is an important part of the car's rust-proofing and should therefore be checked regularly. Repair paintwork damage immediately so that it does not start to rust. The most common types of paintwork damage that you can repair yourself are:

- Minor stone chips and scratches.
- Damage to wing edges and doors.

When repairing paintwork, the car should be clean and dry with a temperature above +15 °C.

### Colour code

Make sure you have the right colour. The colour code number is on the data plate in the engine compartment.

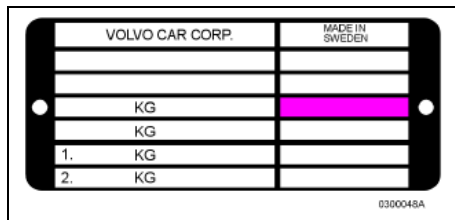

Variant 1

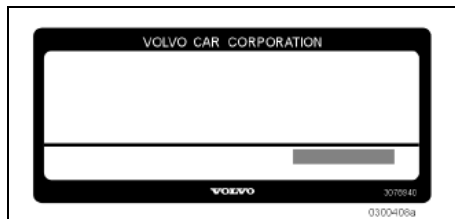

Variant 2



Only China

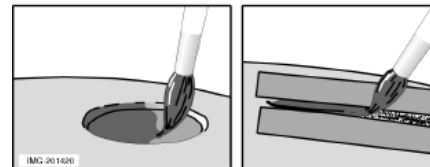
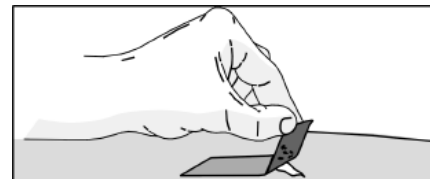

*Remove any paint residue with tape.  
Mask if necessary.*

### Minor stone chips and scratches

Material:

- Primer in a can
- Paint in a can or a touch-up pen
- Brush
- Masking tape
- If the stone chip has not gone down to the bare metal and an unpainted colour coat remains, you can add paint immediately after removing dirt.

---

## Touching up paintwork

### **Do as follows if the stone chip went down to the bare metal:**

- Fasten a piece of masking tape over the damaged surface. Then remove the tape, removing any paint residue (illustration 1).
- Stir the primer thoroughly and apply using a fine brush or matchstick (illustration 2).
- When the primer is dry, apply the surface coat with a brush.
- Make sure the paint is well stirred and apply several thin coats; allowing it to dry between coats.
- The procedure is the same for scratches, but masking tape can be used to protect undamaged paintwork (illustration 3).
- Wait a day or so and then finish the repair by polishing. Use a soft rag and apply lapping paste sparingly.

## Rustproofing

### Rustproofing – check and repair

Your car received a thorough and complete rustproofing at the factory. Parts of the body are made of galvanised sheet metal. The underbody is protected by a wear-resistant anti-corrosion compound. Members, cavities and enclosed sections are sprayed with a thin, penetrating rust inhibitor.

The car's rustproofing is maintained by doing the following:

- Keep the car clean! Hose down the underbody. During high pressure washing - hold the nozzle at least 30 cm from painted surfaces!
- Check and repair the rustproofing regularly.

The car's rustproofing does not normally require treatment for approximately 8 years. After that time, it should be treated at three year intervals. If your car requires treatment, consult an authorised Volvo workshop for assistance.

### Repair

If you want to repair the rustproofing yourself, make sure the area is clean and dry. Hose down, wash and dry the car thoroughly. Use a rustproofing agent in a spray can or one that is intended for brush application.

There are two different types of rustproofing agents:

- Thin (colourless), for visible areas.
- Thick, for areas prone to wear on the underbody.

Possible repair areas with these agents:

- Visible welds and sheet metal joints - thin fluid
- Underbody - thick fluid
- Door hinges - thin fluid
- Bonnet hinges and catch - thin fluid

Once you have finished treatment, excess rustproofing can be wiped off with a rag dipped in a recommended cleaning agent. Parts of the engine and suspension strut mountings in the engine compartment are treated at the factory with a wax-based, colourless rustproofing. This withstands normal detergents without dissolving and losing its rustproofing ability.

If you wash the engine using aromatic solvents, such as turpentine or white spirit (especially those that do not contain emulsifiers), the protective wax should be renewed after washing. Your Volvo dealer handles such waxes.

---

## Maintenance and service

<b>Volvo service</b>	<b>164</b>
<b>Self-maintenance</b>	<b>165</b>
<b>Bonnet and engine compartment</b>	<b>167</b>
<b>Diesel</b>	<b>168</b>
<b>Oils and fluids</b>	<b>169</b>
<b>Wiper blades</b>	<b>173</b>
<b>Battery</b>	<b>174</b>
<b>Replacing bulbs</b>	<b>176</b>
<b>Fuses</b>	<b>184</b>



### Volvo service

#### Volvo service programme

Before the car left the factory, it was thoroughly test driven. It was checked again in accordance with Volvo Car Corporation regulations before it was handed over to you.

To keep your Volvo as safe and reliable as possible, follow the Volvo service programme specified in the Service and Warranty Booklet. Have an authorised Volvo workshop carry out service and maintenance work. Volvo workshops have the personnel, special tools and service literature to guarantee the highest quality of service.

#### **IMPORTANT!**

For the Volvo warranty to apply, check and follow the instructions in the Service and Warranty Booklet.

#### Special service measures

Certain service measures, which affect the car's electrical system, can only be performed using electronic equipment specially developed for your car. Always contact an authorised Volvo workshop before beginning or performing service work that affects the electrical system.

#### Installing accessories

The incorrect connection and installation of accessories can negatively affect the car's electrical system. Certain accessories only function when the appropriate software has been programmed into the car's electrical system. Always contact an authorised Volvo workshop before installing accessories which are connected to or affect the electrical system.

#### Recording vehicle data

One or more of the computers in your Volvo are capable of recording detailed information. This information is intended for use in research to enhance safety and for diagnosing faults in some of the in-car systems. The data may include details regarding seatbelt use by the driver and passengers, the functions of various vehicle systems and modules, and status information about the engine, throttle, steering, brakes and other systems. This data can also include details of the way the car is driven. This type of information can include, without being limited to, specific details such as vehicle speed, the use of the brake and accelerator pedals and steering wheel position. This latter type of data can be stored for a limited period while the car is being driven and subsequently during a collision or a near-collision. Volvo Car Corpora-

tion will not disclose the stored information without consent. However, Volvo Car Corporation may be forced to disclose the information due to national legislation. Volvo Car Corporation and its workshops may also read and use the information.

## Self-maintenance

### Note the following before you begin working on your car:

#### Battery

Ensure that the battery cables are correctly connected and tightened.

Never disconnect the battery when the engine is running (e.g. when replacing the battery).

Never use a fast charger to charge the battery. The battery cables should be disconnected when recharging.

The battery contains acid that is both corrosive and toxic. Handle the battery in an environmentally-suitable way. Let your Volvo dealer assist you.

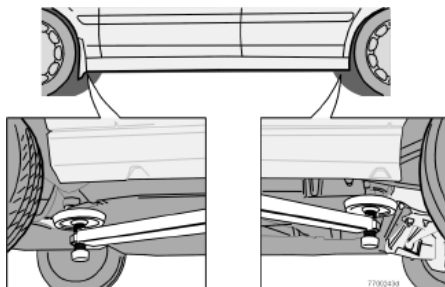

#### Lifting the car

If the car is lifted with a workshop jack, it should sit with the front edge on the engine support arm. Do not damage the splashguard under the engine. Ensure that the jack is positioned so that the car cannot slide off the jack. Always use axle stands or the like.

If you raise the car using a two pillar workshop lift, ensure that the front and rear lift arms are fixed under the lifting points on the door sill. See the illustration.

#### **WARNING!**

The car ignition system has very high voltage!

The voltage in the ignition system is dangerous!

Do not touch spark plugs, ignition cables or the ignition coil when the engine is running or the ignition is switched on!

The ignition should be switched off when:

- Conducting engine tests.
- Replacing parts in the ignition system, such as spark plugs, ignition coil, distributor, ignition cables, etc.

#### **WARNING!**

Never try to repair any part of the SRS or SIPS bag systems yourself.

Any interference in the system could cause malfunction and serious injury. All work should only be performed by an authorised Volvo workshop.

### Self-maintenance

#### Check regularly

Check the following at regular intervals, for example, when refuelling:

- Coolant – The level must be between the MIN and MAX marks on the expansion tank.
- Engine oil – The level must be between the MIN and MAX marks.
- Power steering fluid – The level must be between the MIN and MAX marks.
- Washer fluid – The reservoir should be well filled. Use washer antifreeze at temperatures around freezing.
- Brake and clutch fluid – The level must be between the MIN and MAX marks.



#### **WARNING!**

Bear in mind that the radiator fan may start automatically some time after the engine has been switched off.

Always have the engine cleaned by a workshop. There is a risk of fire if the engine is hot.

## Bonnet and engine compartment

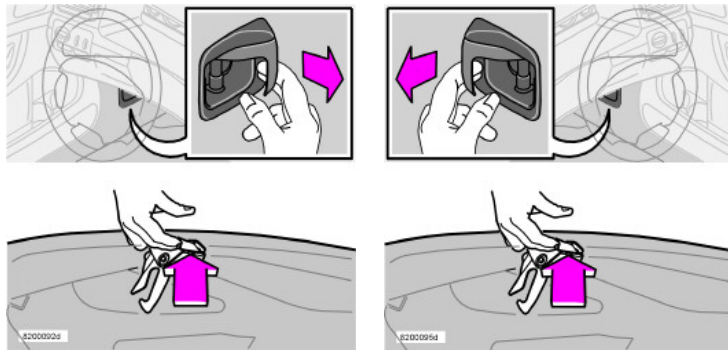

*Left and right-hand drive cars.*

### Opening the bonnet

To open the bonnet:

- Pull the handle on the far left under the dashboard. You will hear when the catch releases.
- Insert your hand under the centre of the front edge of the bonnet and press up the safety catch.
- Open the bonnet.

#### **⚠ WARNING!**

Check that the bonnet locks properly when closed.

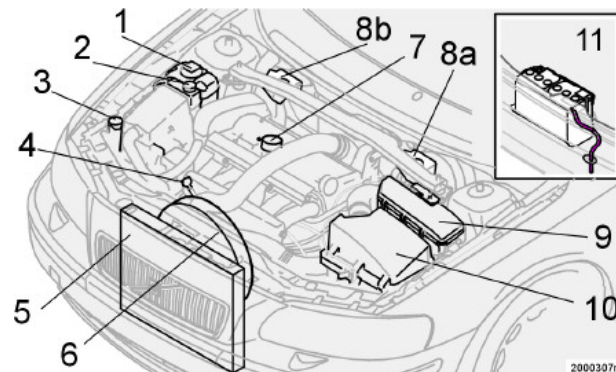

### Engine compartment

The appearance of the engine compartment may vary slightly due to engine variant. However, the components listed are in the same positions.

1. Expansion tank, cooling system.
2. Power steering fluid reservoir.
3. Washer fluid reservoir.
4. Engine oil dipstick.
5. Radiator.
6. Radiator fan.
7. Engine oil filler pipe.
8. a) Clutch/brake fluid reservoir (left-hand drive car).  
b) Clutch/brake fluid reservoir (right-hand drive car).
9. Relay/fuse box.

10. Air filter. (The cover has a different design depending on engine variant.)
11. Battery (in cargo area).

### Diesel

#### Fuel system

Diesel engines are sensitive to contaminants. Only use diesel fuel from a well-known oil company that fulfils the requirements for recommended fuel grade as described on page 241. Never use diesel of dubious quality. Special diesel fuel designed for low temperatures around freezing point is available from the major oil companies. This fuel is less viscous at low temperatures and reduces the risk of wax building up in the fuel system.

The risk of condensation building up in the tank is reduced if the tank is kept well filled.

Make sure that the area around the filler pipe is clean when refuelling.

Avoid spilling onto the paintwork. Wash off any spills with detergent and water.

#### Empty tank

No special procedures are required if the tank is run dry. The fuel system is bled automatically if the ignition switch is kept in position **II** for approx. 60 seconds before the start attempt.

#### **IMPORTANT!**

Diesel type fuels which must not be used: special additives, Marine Diesel Fuel, fuel oil, RME (Rape Methyl Ester), vegetable oil.

These fuels do not fulfil the requirements in accordance with Volvo recommendations and generate increased wear and engine damage that is not covered by the Volvo warranty.

#### **Draining condensation from the fuel filter**

The fuel filter separates condensation from the fuel. Condensation can disrupt engine operation.

The fuel filter must be drained at the intervals specified in the Service and Warranty Booklet or if you suspect that the car has been filled with contaminated fuel.

## Oils and fluids

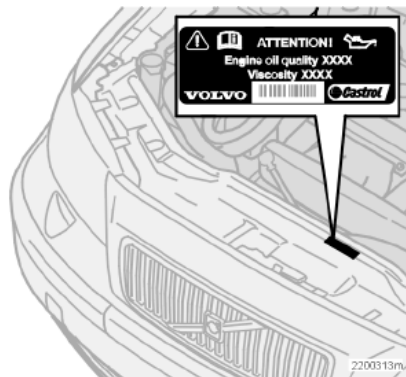

*Engine compartment decal for oil grade*

### IMPORTANT!

Always use oil of the prescribed grade, see the engine compartment decal. Check the oil level frequently and change the oil regularly. The engine will be damaged if lower grade oil is used or if the car is driven with the oil level too low.

Volvo recommends  oil products.

Using oil of a higher than specified grade is permitted. Volvo recommends using an oil of a higher grade than that specified on the

decal for adverse driving conditions. See page 236.

### Adverse driving conditions

Check the oil level more frequently for long journeys:

- towing a caravan or trailer
- in mountainous regions
- at high speeds
- in temperatures colder than  $-30\text{ }^{\circ}\text{C}$  or hotter than  $+40\text{ }^{\circ}\text{C}$
- shorter driving distances (shorter than 10 km) at low temperatures (under  $5\text{ }^{\circ}\text{C}$ )

This may result in abnormally high oil temperature or oil consumption.

### Checking and changing the engine oil and oil filter

**NOTE!** Change the oil and oil filter in accordance with the intervals specified in the Service and Warranty Booklet.

### IMPORTANT!

When filling oil to top up a low oil level, the oil being filled must be of the same grade and viscosity as the oil in the engine.

Certain engine variants have an oil level sensor, see 236.

Checking the oil level in a new car is especially important before the first scheduled oil change. The Service and Warranty Booklet specifies the odometer readings for oil changes.

Volvo recommends checking the oil level every 2500 km. The most accurate measurements are made on a cold engine before starting. The measurement will be inaccurate if taken immediately after the engine is switched off. The dipstick will indicate that the level is too low because the oil has not had time to flow down into the oil sump.

### Oils and fluids

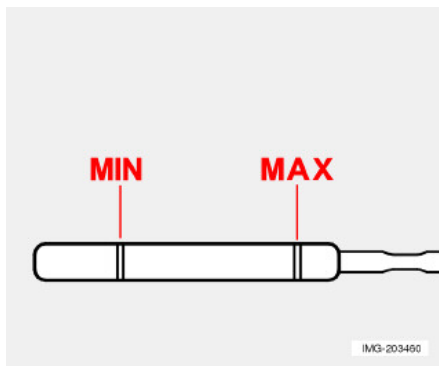

*The oil level must be within the area marked on the dipstick.*

#### Checking the oil in a cold engine:

- Wipe the dipstick clean before checking the level.
- Check the oil level using the dipstick. The oil level must be between the MIN and MAX marks.
- If the level is close to the MIN mark, start by topping up with 0.5 litres of oil. Top up until the oil level is nearer the MAX than the MIN mark on the dipstick. See page 236 for capacities.

#### Checking the oil in a warm engine:

- Park the car on a level surface, switch off the engine and wait 10-15 minutes to allow the oil time to run back to the sump.

- Wipe the dipstick clean before checking the level.
- Check the oil level using the dipstick. The oil level must be between the MIN and MAX marks.
- If the level is close to the MIN mark, start by topping up with 0.5 litres of oil. Top up until the oil level is nearer the MAX than the MIN mark on the dipstick. See page 236 for capacities.

#### **IMPORTANT!**

Never fill above the MAX mark. Oil consumption may increase if too much oil is poured into the engine.



#### **WARNING!**

Do not spill oil onto the hot exhaust manifold due to the risk of fire.

## Oils and fluids

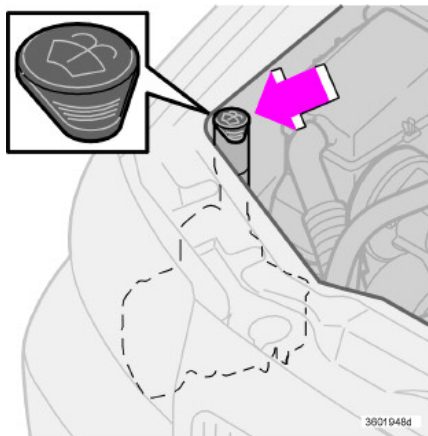

Washer fluid reservoir

### Washer fluid reservoir

The windscreen and headlamp washers have the same fluid reservoir. See capacities and recommended grade for fluids on page 238.

Use washer fluid during the winter so that the fluid does not freeze in the pump, reservoir and hoses.

Tip: clean the wiper blades when topping up washer fluid.

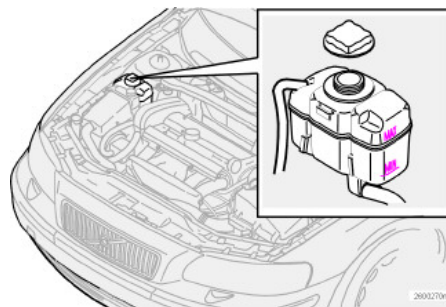

Coolant reservoir

### Coolant reservoir

Check the coolant regularly. The level should lie between the MIN and MAX marks on the expansion tank. Top up with fluid when the level has fallen to the MIN mark.

See capacities and recommended grade for fluids and oils on page 238.

When topping up the coolant, follow the instructions on the packaging. It is important that the mixture of coolant concentrate and water is correct for the prevailing weather conditions. Never top up with water only. The risk of freezing increases with both too little and too much coolant concentrate.

### IMPORTANT!

Always use coolant with anti-corrosion agent as recommended by Volvo. New cars are filled with coolant that can withstand temperatures down to approximately  $-35\text{ }^{\circ}\text{C}$ .

### IMPORTANT!

The engine must only be run with a well-filled cooling system. High temperatures can occur, causing a risk of damage (cracks) to the cylinder head.

### ⚠ WARNING!

The coolant may be very hot. If the coolant requires topping up when the engine is at operating temperature, unscrew the expansion tank cap slowly to gently release the overpressure.



## Oils and fluids

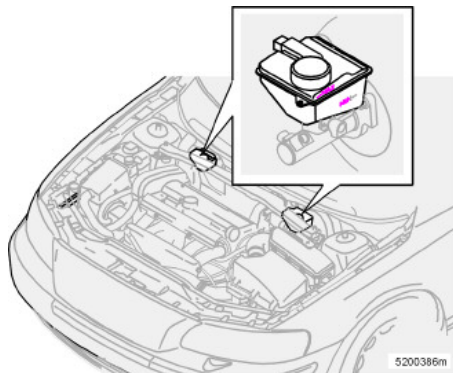

*Clutch and brake fluid reservoir*

### Clutch and brake fluid reservoir

The brake and clutch fluid have a common reservoir<sup>1</sup>. The fluid level must be between the MIN and MAX marks. Check the level regularly. Change the brake fluid every other year or at every other regular service.

See capacities and recommended grade for fluids and oils on page 238.

**NOTE!** The fluid should be changed annually on cars driven in conditions requiring hard, frequent braking, such as driving in mountains or tropical climates with high humidity.



### WARNING!

If the level of brake fluid in the reservoir is below the MIN mark, the car should not be driven until the brake fluid has been topped up.

The reason for the loss of brake fluid must be investigated.

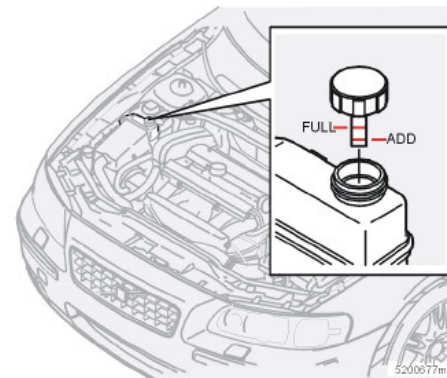

*Power steering fluid reservoir*

### Power steering fluid reservoir

Check the level at every service. It is not necessary to change the fluid. The level should lie between the ADD and FULL marks.

See capacities and recommended grade for fluids and oils on page 238.

**NOTE!** It is possible to steer if a fault should occur in the power steering system or if the car loses electrical power and requires towing. Bear in mind that steering will be more difficult than normal and more force will be required to turn the steering wheel.

1. Location dependent on whether car is left or right-hand drive.

## Wiper blades

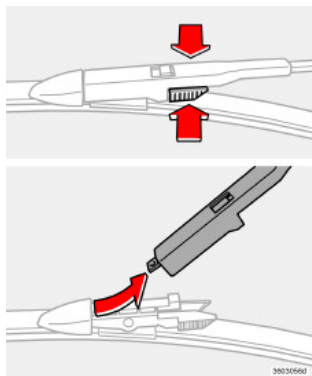

### Replacing windscreen wiper blades

- Fold out the wiper arm and grasp the wiper blade.
- Press in the ribbed spring catch on the wiper blade while lifting it off at the arm extension.
- Fit the new blade in reverse order and check that it is properly secured.

**NOTE!** Bear in mind that the wiper blade on the driver's side is longer than the one on the passenger side.

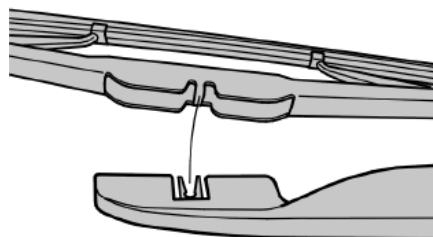

### Replacing rear window wiper blades

- Fold out the wiper arm.
- Pull the wiper blade outward towards the tailgate. Press the new blade in place.
- Check that the blade is properly secured.

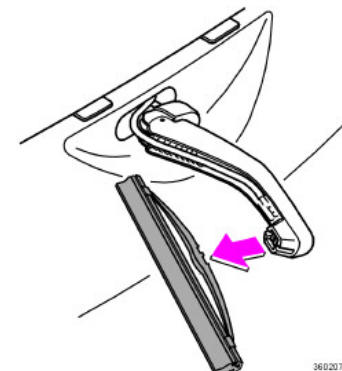

### Replacing a headlamp wiper blade<sup>1</sup>

- Fold the wiper arm forward.
  - Pull the wiper blade outward.
- Press the new blade in place. Check that the blade is properly secured.

1. Applies to V70 R

## Battery

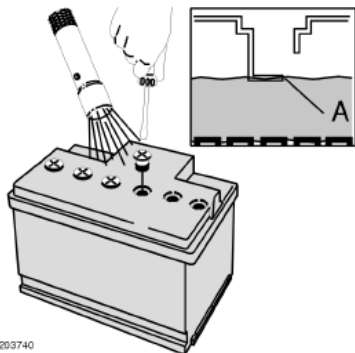

IMG-203740

### Battery care

The service life and function of the battery is influenced by factors such as the number of starts, discharging, driving style, driving conditions and climatic conditions.

For the battery to function satisfactorily, consider the following:

- Regularly check that the battery fluid level is correct **(A)**.
- Check all cells. Use a screwdriver to remove the caps. Each cell has its own maximum level mark.
- If necessary, top up with distilled water to the battery's maximum mark.

**NOTE!** Never fill above the maximum mark **(A)**.

### IMPORTANT!

Always use distilled or deionised water (battery water).

- Tighten the caps properly.

**NOTE!** The life of the battery is shortened if it becomes discharged repeatedly.

### Symbols on the battery

These symbols displayed on the battery.



0300348a



0300352a



0300351a

Use protective goggles.

Further information in the owner's manual.

Store the battery out of the reach of children.



0300347a

The battery contains corrosive acid.



0300349a

Avoid sparks and naked flames.



0300350a

Risk of explosion.

## Battery

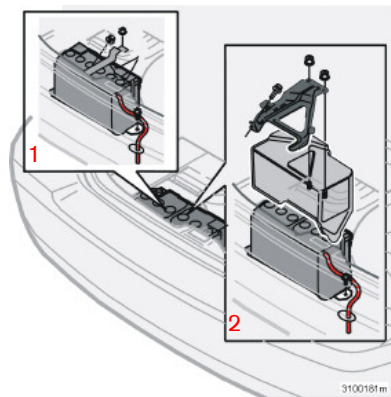

1. Battery without cover

2. Battery with cover

### Changing the battery

#### Removing the battery

- Switch off the ignition and remove the key.
- Wait at least 5 minutes before touching any electrical terminals. This allows time for the information in the car's electrical system to be stored in the control modules.
- Undo the screws from the lock brace over the battery and remove the brace.
- Bend up the plastic cover over the negative battery terminal or unscrew the cover from the battery.

- Disconnect the negative battery lead.
- Detach the lower console holding the battery.
- Bend aside the plastic cover and disconnect the positive cable.
- Remove the battery.

#### Fitting the battery

- Fit the battery into position.
- Position the lower console and screw it in place.
- Connect the positive cable, press in and fold down the plastic cover.
- Connect the negative cable, fold down the plastic cover.
- Fit the plastic cover or the cover over the battery.
- Make sure the evacuation hose is correctly connected to both the battery and the outlet in the bodywork.
- Fit the lock brace over the battery and tighten the screws.

#### **⚠ WARNING!**

Batteries can generate oxyhydrogen gas, which is highly explosive. A spark, which can be generated if you connect the jump leads incorrectly, is sufficient to make the battery explode. The battery also contains sulphuric acid, which can cause serious burns. If the acid comes into contact with eyes, skin or clothing, flush with large quantities of water. If acid splashes into the eyes, seek medical advice immediately.

## Replacing bulbs

### General

All bulb specifications are given on page 244.

The following list contains bulbs and point-source lamps that are specialised or unsuitable for changing except at a workshop:

- General interior lighting in the roof.
- Reading lamps
- Glovebox lighting
- Direction indicators in the door mirrors.
- Approach lighting in the door mirrors.
- High-level brake light.
- LEDs in the rear lamp cluster.

### IMPORTANT!

Never touch the bulbs' glass with your fingers. Grease and oils from your fingers are vaporised by the heat, coating and damaging the reflector.

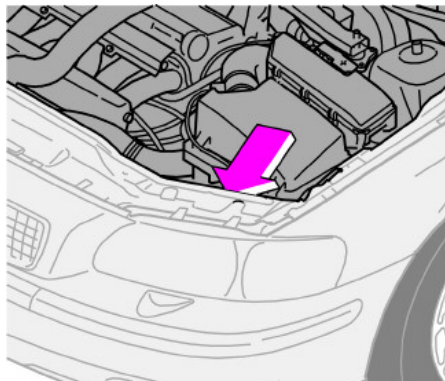

### Changing front bulbs

All front bulbs (except for fog lamps) are changed by first removing the lamp housing from the engine compartment.

#### **WARNING!**

On cars with Bi-Xenon headlamps, all work on the lights should be carried out at an authorised Volvo workshop. Bi-Xenon headlamps must be handled with extreme care due to the high-voltage unit.

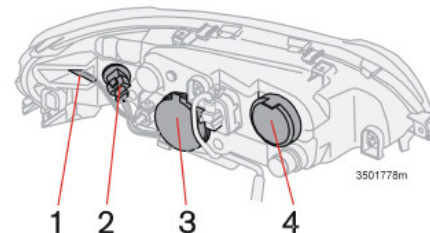

**NOTE!** If you experience difficulty when replacing a bulb then we recommend that you contact an authorised Volvo workshop.

### Location of the bulbs in the headlamp<sup>1</sup>

1. Side marker lamp
2. Direction indicator
3. Dipped beam, position lamp
4. Main beam bulb

On certain variants, a white plastic sleeve may impede bulb replacement. This can be broken off and discarded.

1. Applies to halogen headlamps

## Replacing bulbs

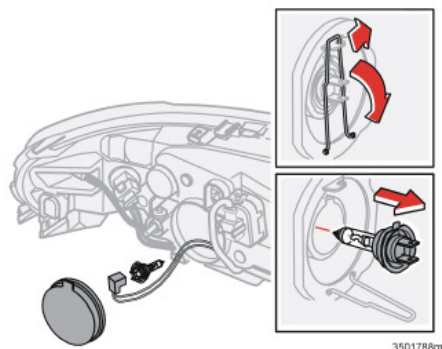

*Dipped beam bulb*

### Dipped beam

#### To remove the bulb:

- Switch off all lights and turn the ignition key to position **0**.
- Remove the cover.
- Unplug the connector.
- Disconnect the spring clamp. First push to the right so that the spring disconnects and then out and down.
- Pull out and remove the bulb.

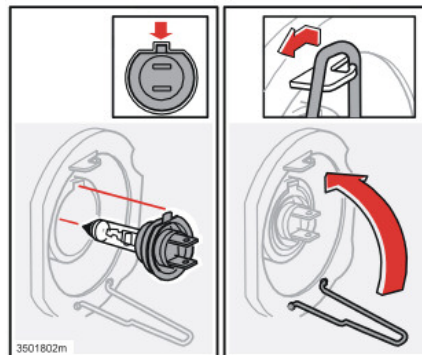

*Fitting the dipped beam bulb*

#### To fit:

- Fit the new bulb. It can only be positioned one way.
- Press the clamp spring upwards and a little to the left so that it secures in its catch.
- Plug in the connector.
- Refit the cover.

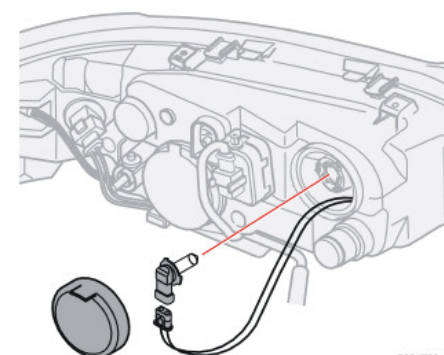

*Main beam bulb*

### Main beam

#### To remove the bulb:

- Switch off all lights and turn the ignition key to position **0**.
- Remove the cover.
- Pull out the lamp.
- Unplug the connector.
- Turn the lamp anticlockwise a half turn, pull out and remove the bulb.

## Replacing bulbs

### To fit:

- Fit the new bulb. It can only be positioned one way.
- Plug in the connector.
- Put the lamp back in place and turn it so that the connector faces down.
- Refit the cover.

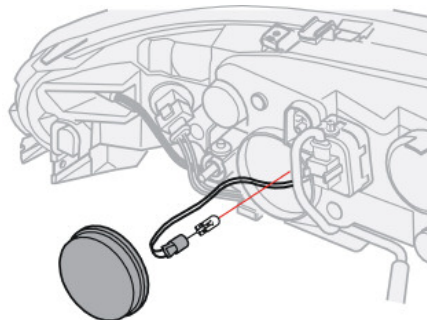

*Position and parking lamp bulb*

### Position/parking lamps

#### To remove the bulb:

- Switch off all lights and turn the ignition key to position **0**.
- Remove the cover (same cover as for dipped beam).
- Pull out the lamp.
- Unplug the connector.

#### To fit:

- Fit the new bulb.
- Plug in the connector.
- Refit the cover.

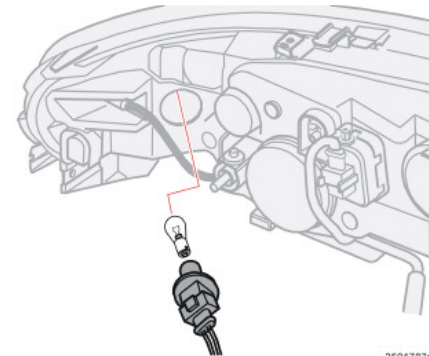

*Direction indicator bulb, left-hand side*

### Direction indicator, left-hand side

#### To remove the bulb:

- Switch off all lights and turn the ignition key to position **0**.
- Twist the bulb holder anticlockwise and remove it.
- Press the bulb inwards, turn it anticlockwise and remove it from the bulb holder.

#### To fit:

- Fit the new bulb by pressing in and turning clockwise.
- Refit the bulb holder in the lamp housing and turn it clockwise.

## Replacing bulbs

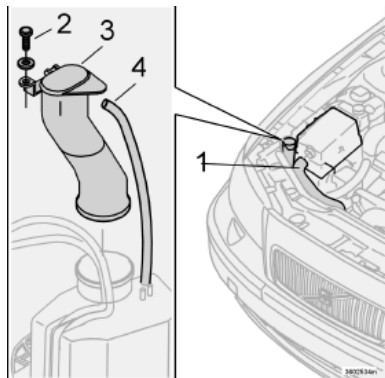

*Direction indicator bulb, right-hand side*

### Direction indicator, right-hand side

- Switch off all lights and turn the ignition key to position **0**.
- Remove the radiator hose (1) from the radiator.
- Remove the screw (2) to the filler pipe.
- Pull the pipe (3) straight up.
- Remove the ventilation hose (4) from the pipe.
- Replace the bulb.
- Check that the washer fluid reservoir gasket between the filler pipe and the holder is properly secured.
- Push the filler pipe (3) back into place.

- Refit the ventilation hose onto the filler pipe (4).
- Screw in the screw (2) to the filler pipe and refit the radiator hose to the radiator (1).

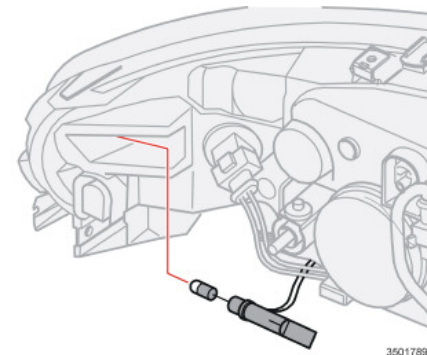

3501789m

*Side marker lamp*

### Side marker lamps

- Turn the bulb holder clockwise and pull it out.
- Replace the bulb.
- Refit the bulb holder by turning it anticlockwise.



## Replacing bulbs

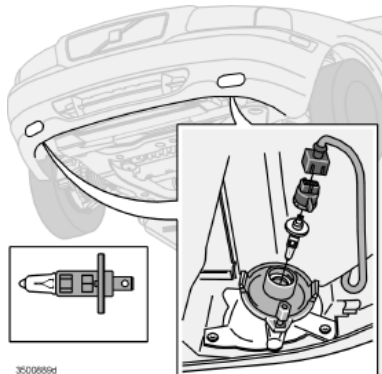

*Fog lamp*

### Front fog lamps (option)

#### To remove the bulb:

- Switch off all lights and turn the ignition key to position **0**.
- Turn the bulb holder slightly anticlockwise.
- Pull out and remove the bulb.

#### To fit:

- Fit the new bulb. It can only be positioned one way.
- Refit the bulb holder, turn it clockwise slightly. The "TOP" mark must be upward.

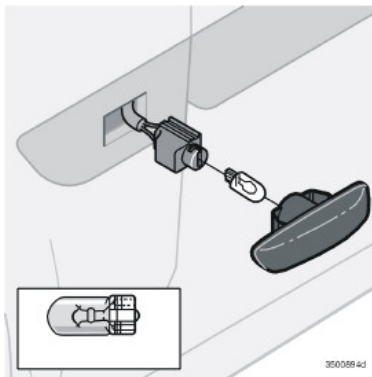

*Side direction indicator*

### Side direction indicators

#### To remove the bulb:

- Open the front door halfway.
- Slide your hand behind the front wing and press out the lamp together with lamp housing. Do not disconnect the leads.
- Turn the bulb holder a quarter turn clockwise and pull it straight out of the lamp housing.
- Detach the bulb from the connector by pulling it straight out.

#### To fit:

- Connect the new bulb to the connector and fit it in the lamp housing by turning it a quarter turn clockwise.

- Refit the lamp with lens in the front wing. Press it straight inward.

## Replacing bulbs

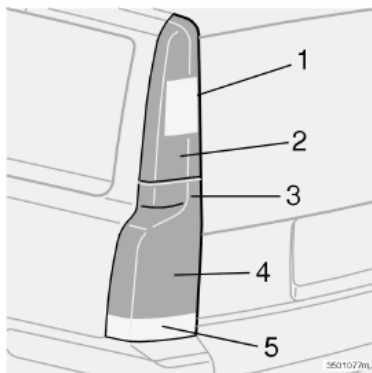

- Turn the bulb holder anticlockwise and remove.
- Press the bulb inwards, turn anticlockwise and take out the bulb.
- Replace the bulb.
- Fit the bulb holder in place and twist it clockwise.
- Close the access panel.

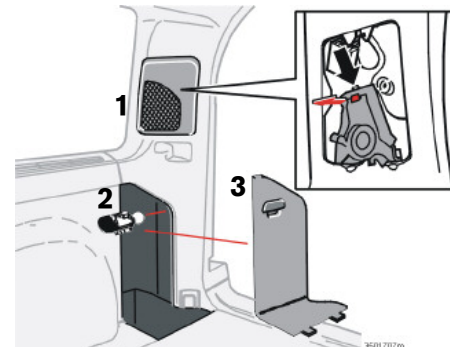

## Replacing the reversing, position/parking and rear fog lamp

Bulb specifications can be found on page 244.

1. Direction indicator lamp
  2. Brake light
  3. Position/parking lamps
  4. Position/parking lamp, fog lamp (left-hand side only)
  5. Reversing lamp
- Switch off all lights and turn ignition the key to position **0**.
  - Open the access panel.

## Replacing the brake light and rear direction indicator lamp

Bulb specifications can be found on page 244.

1. Speaker grille
  2. Bulb holder
  3. Access panel
- Switch off all lights and turn the ignition key to position **0**.
  - Carefully prize off the speaker grille using a slotted screwdriver.
  - Pull out the red tab in the speaker.
  - Then press on the black pin above the extracted red tab and twist out the speaker.

### Replacing bulbs

- Twist the bulb holder anticlockwise and withdraw it.
- Replace the bulb.
- Fit the bulb holder in place and twist it clockwise.
- Refit the speaker and press in the red tab.
- Press the speaker grille back into position.

**NOTE!** If the error message "Bulb Failure"/ "Check brake light" remains after a faulty bulb has been replaced then an authorised Volvo workshop needs to be consulted to rectify the fault.

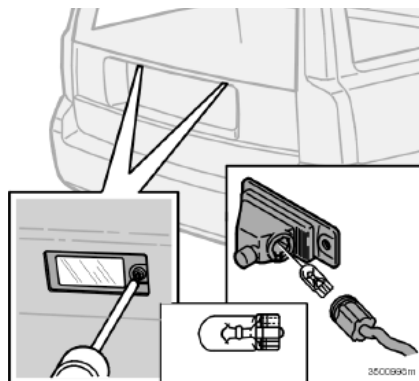

### Number plate lighting

- Switch off all lights and turn ignition the key to position **0**.
- Remove the screw with a screwdriver.
- Loosen the whole lamp housing carefully and pull it out.
- Turn the connector anticlockwise and pull out the bulb.
- Replace the bulb.
- Refit the contact and turn clockwise.
- Refit the entire lamp housing and screw it into place.

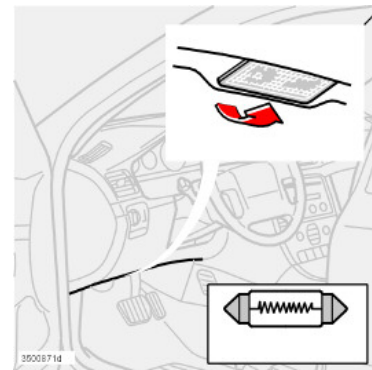

### Courtesy lighting

There is courtesy lighting under the dashboard on the driver and passenger sides.

- Insert a screwdriver and gently turn so that the lamp housing comes loose.
- Remove the bulb.
- Fit a new bulb.
- Refit the lamp housing.

## Replacing bulbs

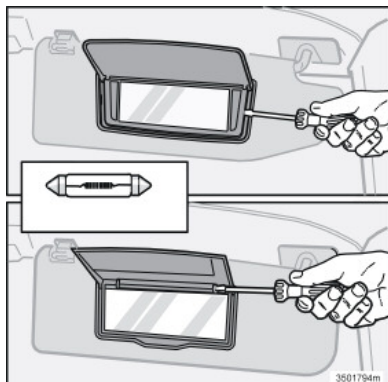

*Vanity mirror, different versions*

### **Vanity mirror lighting**

- Insert a screwdriver and turn so that the lamp lens releases.
- Remove the bulb.
- Fit a new bulb.
- First press the bottom of the lamp glass back into place above the four hooks. Then press the top in place.

### Fuses

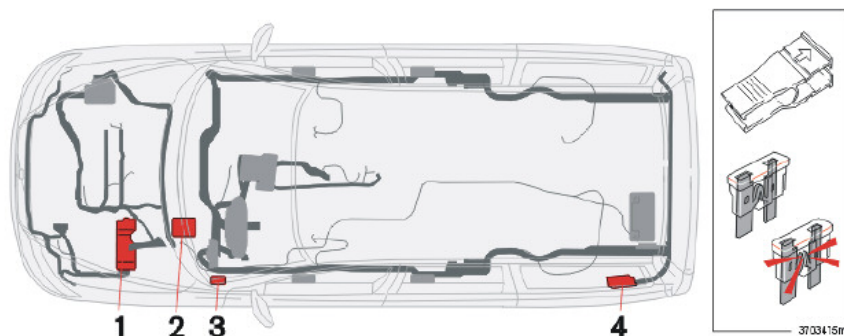

*Cable routing may vary slightly due to engine variant. However, the components listed are in the same positions.*

All electrical functions and components are fused to protect your car's electrical system from damage by short circuiting and overloading.

Fuses are housed in four different locations in the car:

1. Relay/fuse box in the engine compartment.
2. Fuse box in the passenger compartment within the sound barrier on the driver's side.
3. Fuse box in passenger compartment at the end face of the dashboard on the driver's side.
4. Fuse box in cargo area.

#### Changing

If an electrical component or function does not work, this may be because the component's fuse was temporarily overloaded and blew.

- Look in the fuse diagram to locate the fuse.
- Pull out the fuse and check from the side to see whether the curved wire has blown.
- If this is the case, replace it with a new fuse of the same colour and amperage.

There are a number of spare fuses in the cover on the end face of the dashboard. There are also pliers which facilitate the removal and fitting of fuses.

If the same fuse blows repeatedly, there is a fault in the component. Contact an authorised Volvo workshop to have it checked.

## Fuses

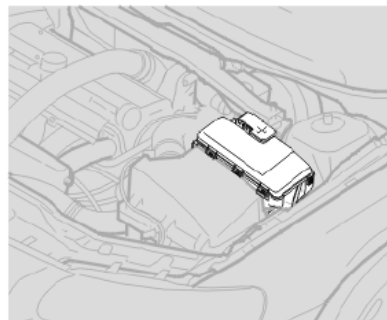
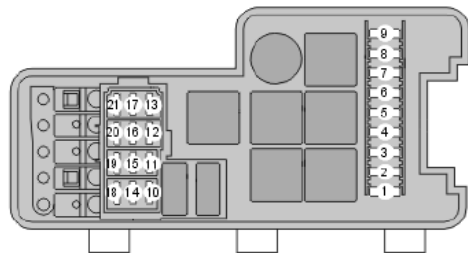

37 037 57 m

Press in the plastic catches on the short sides of the box and pull the cover upward.

### Relay/Fuse box in the engine compartment

- |                                                                                           |      |                                                                                                            |      |
|-------------------------------------------------------------------------------------------|------|------------------------------------------------------------------------------------------------------------|------|
| 1. ABS.....                                                                               | 30 A | 12. Engine control module (ECM) (petrol) injection valves (petrol), mass air flow sensor (petrol).....     | 15 A |
| 2. ABS .....                                                                              | 30 A | mass air flow sensor (diesel).....                                                                         | 5 A  |
| 3. High-pressure washer, headlamps .....                                                  | 35 A | 13. Electronic throttle module (ETM), (petrol) .....                                                       | 10 A |
| 4. Parking heater (option).....                                                           | 25 A | Electronic throttle module (ETM), air mixing valve, fuel pressure regulator, solenoid valve, (diesel)..... | 15 A |
| 5. Auxiliary lamps (option).....                                                          | 20 A | 14. Lambda-sond (petrol) .....                                                                             | 20 A |
| 6. Starter motor relay.....                                                               | 35 A | Lambda-sond (diesel) .....                                                                                 | 10 A |
| 7. Windscreen wipers.....                                                                 | 25 A | 15. Crankcase ventilation heater, solenoid valves (petrol) .....                                           | 10 A |
| 8. Transmission control module (TCM), diesel, R-models .....                              | 15 A | solenoid valves, glow plugs (diesel) .....                                                                 | 15 A |
| 9. Fuel pump .....                                                                        | 15 A | 16. Dipped beam, left .....                                                                                | 20 A |
| 10. Ignition coils (petrol), engine control module (ECM), injection valves (diesel) ..... | 20 A | 17. Dipped beam, right.....                                                                                | 20 A |
| 11. Accelerator pedal sensor (APM), AC compressor, fan electronics box.....               | 10 A | 18. ....                                                                                                   | -    |
|                                                                                           |      | 19. Engine control module (ECM) supply, engine relay .....                                                 | 5 A  |
|                                                                                           |      | 20. Position lamps .....                                                                                   | 15 A |
|                                                                                           |      | 21. ....                                                                                                   | -    |

## Fuses

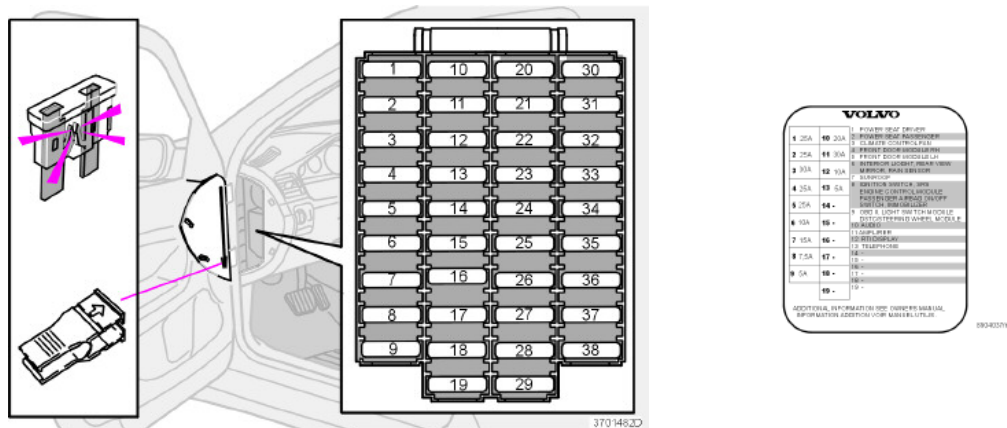

A decal which indicates the positions and amperages of the fuses is located in the end face box cover.

### Fuses in the passenger compartment at dashboard end face on driver's side

- |       |                                                                                                                                                                                           |       |
|-------|-------------------------------------------------------------------------------------------------------------------------------------------------------------------------------------------|-------|
| 1.    | Power driver's seat.....                                                                                                                                                                  | 25 A  |
| 2.    | Power passenger seat .....                                                                                                                                                                | 25 A  |
| 3.    | Climate control system fan.....                                                                                                                                                           | 30 A  |
| 4.    | Control module, right front door .....                                                                                                                                                    | 25 A  |
| 5.    | Control module, left front door.....                                                                                                                                                      | 25 A  |
| 6.    | General lighting, ceiling (RCM),<br>Upper Electronic Module (UEM) .....                                                                                                                   | 10 A  |
| 7.    | Sunroof.....                                                                                                                                                                              | 15 A  |
| 8.    | Ignition switch, SRS system, engine control module (ECM) SRS deactivation passenger side (PACOS), electronic immobiliser (IMMO), transmission control module (TCM), diesel, R-models..... | 7.5 A |
| 9.    | OBDDII, light switch (LSM), Steering Angle Sensor (SAS), Steering Wheel Module (SWM).....                                                                                                 | 5 A   |
| 10.   | Audio .....                                                                                                                                                                               | 20 A  |
| 11.   | Amplifier .....                                                                                                                                                                           | 30 A  |
| 12.   | RTI display.....                                                                                                                                                                          | 10 A  |
| 13.   | Telephone .....                                                                                                                                                                           | 5 A   |
| 14-38 | .....                                                                                                                                                                                     | -     |

## Fuses

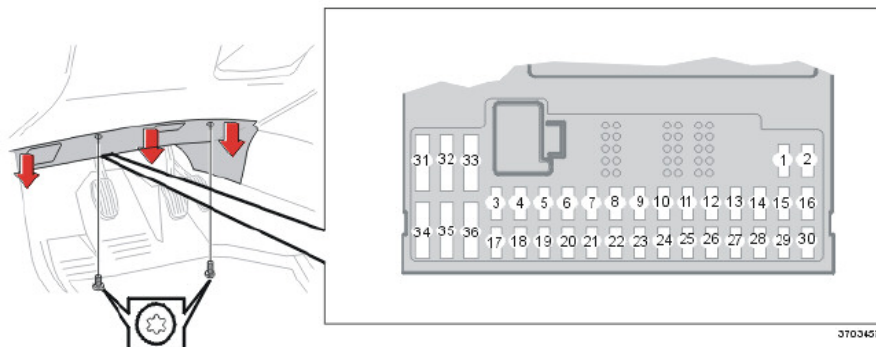

### Fuses in the passenger compartment within the sound barrier on the driver's side

1. Seat heating, right side.....	15 A	13. Reserve .....	-
2. Seat heating, left side.....	15 A	14. Headlamp wipers (V70 R) .....	15 A
3. Horn .....	15 A	15. ABS, STC/DSTC .....	5 A
4. - .....	-	16. Bi-fuel, Electronically Controlled Power Steering (ECPS), Bi-Xenon, headlamp levelling.....	10 A
5. - .....	-	17. Fog lamp, front left.....	7.5 A
6. Reserve.....	-	18. Fog lamp, front right .....	7.5 A
7. Reserve.....	-	19. Reserve .....	-
8. Siren.....	5 A	20. Reserve .....	-
9. Brake lamp switch feed .....	5 A	21. Transmission Control Module (TCM), reverse gear inhibitor (M66) .....	10 A
10. Combined instrument panel (DIM), climate control (CCM), parking heater, power driver's seat .....	10 A	22. Main beam, left .....	10 A
11. Front and rear seat socket .....	15 A	23. Main beam, right .....	10 A
12. - .....	-	24. - .....	-
		25. - .....	-
		26. Reserve .....	-



## Fuses

27. Reserve.....	-
28. Power passenger seat, audio.....	5 A
29. Reserve.....	-
30. BLIS .....	5 A
31. Reserve.....	-
32. Reserve.....	-
33. Vacuum pump .....	20 A
34. Washer pump, headlamp wipers (V70 R) .....	15 A
35. - .....	-
36. - .....	-

## Fuses

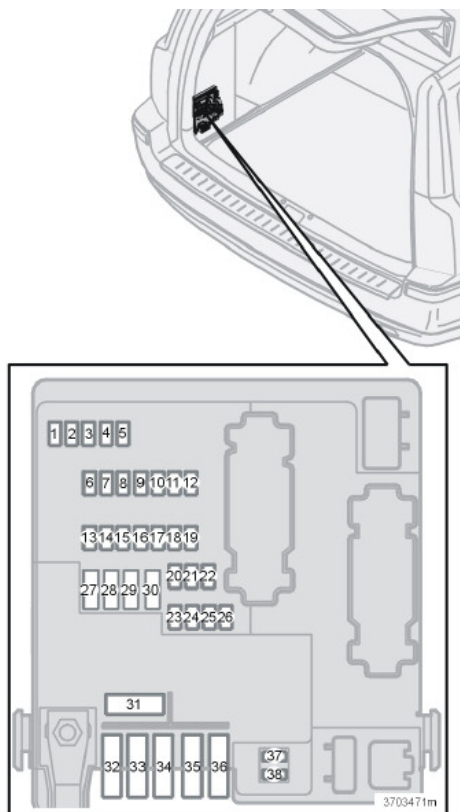

### Fuses in the cargo area

1. Reversing lamp.....	10 A
2. Position lamps, fog lamps, cargo area lighting, number plate lighting, LEDs in brake lighting.....	20 A
3. Accessories (AEM).....	15 A
4. Reserve .....	-
5. REM electronics.....	10 A
6. CD changer, TV, RTI.....	7.5 A
7. Towing bracket wiring (30-feed).....	15 A
8. Cargo area socket.....	15 A
9. Rear right door: power window, power window lock.....	20 A
10. Rear left door: power window, power window lock.....	20 A
11. Reserve .....	-
12. Reserve .....	-
13. Diesel filter heater.....	15 A
14. Subwoofer.....	15 A
15. Reserve .....	-
16. Reserve .....	-
17. Audio accessories.....	5 A
18. Reserve .....	-
19. Rear wiper.....	15 A
20. Towing bracket wiring (15-feed).....	20 A
21. Reserve .....	-
22. -.....	-
23. AWD.....	7.5 A
24. Four-C SUM.....	15 A
25. -.....	-
26. Parking assistance.....	5 A

### Fuses

27. Main fuse: Towing bracket wiring, Four-C, Parking assistance.....	30 A
28. Central locking system (PCL) .....	15 A
29. Trailer lighting, left: Position lamp, direction indicator .....	25 A
30. Trailer lighting, right: Brake lamp, fog lamp, direction indicator .....	25 A
31. Main fuse: Fuse 37, 38.....	40 A
32. - .....	-
33. - .....	-
34. - .....	-
35. - .....	-
36. - .....	-
37. Heated rear window .....	20 A
38. Heated rear window .....	20 A

---

## Audio (option)

<b>Overview HU-450</b>	<b>192</b>
<b>Overview HU-650</b>	<b>193</b>
<b>Overview HU-850</b>	<b>194</b>
<b>Audio functions HU-450/650/850</b>	<b>195</b>
<b>Audio functions HU-450</b>	<b>196</b>
<b>Audio functions HU-650/850</b>	<b>197</b>
<b>Radio functions HU-450/650/850</b>	<b>198</b>
<b>Radio functions HU-450</b>	<b>199</b>
<b>Radio functions HU-650/850</b>	<b>200</b>
<b>Radio functions HU-450/650/850</b>	<b>201</b>
<b>Cassette player HU-450</b>	<b>206</b>
<b>CD player HU-650</b>	<b>207</b>
<b>Internal CD changer HU-850</b>	<b>208</b>
<b>External CD changer HU-450/650/850</b>	<b>209</b>
<b>Dolby Surround Pro Logic II HU-850</b>	<b>210</b>
<b>Technical data</b>	<b>211</b>

## Overview HU-450

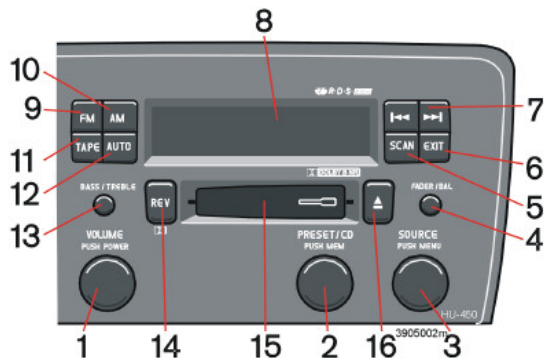

- |                                                                                                                          |                                                                                                                                 |                    |
|--------------------------------------------------------------------------------------------------------------------------|---------------------------------------------------------------------------------------------------------------------------------|--------------------|
| 1. POWER (on/off) – Press VOLUME – Turn                                                                                  | 7. Navigation buttons –<br>CD/radio – seek/change station or track<br>Cassette – Fast forward/rewind/select next/previous track | 16. Cassette eject |
| 2. PRESET/CD PUSH MENU –<br>Stored radio stations<br>CD changer (option)                                                 | 8. Display                                                                                                                      |                    |
| 3. SOURCE PUSH MENU –<br>Opens main menu – Press<br>Turn to select:<br>Radio – FM, AM<br>Cassette<br>CD changer (option) | 9. FM – Shortcut between FM1, FM2, FM3                                                                                          |                    |
| 4. FADER – Press out and turn<br>BAL – Press out, pull and turn                                                          | 10. AM – Shortcut between AM1, AM2                                                                                              |                    |
| 5. SCAN – Automatic station search                                                                                       | 11. TAPE – Shortcut                                                                                                             |                    |
| 6. EXIT – Scroll back in the menu                                                                                        | 12. AUTO – Automatic station preset                                                                                             |                    |
|                                                                                                                          | 13. BASS – Press out and turn<br>TREBLE – Press out, pull and turn                                                              |                    |
|                                                                                                                          | 14. Cassette – direction select –<br>CD changer (option) – Random                                                               |                    |
|                                                                                                                          | 15. Cassette opening                                                                                                            |                    |

## Overview HU-650

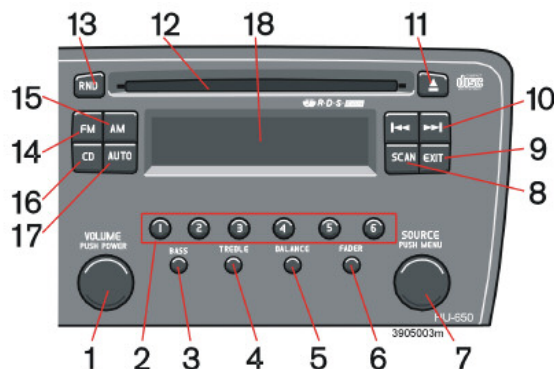

- |                                                                                                                                                                                                                                                                                                                                                                                                                                                                                                                                                   |                                                                                                                                                                                                                                                                                                                                                                     |
|---------------------------------------------------------------------------------------------------------------------------------------------------------------------------------------------------------------------------------------------------------------------------------------------------------------------------------------------------------------------------------------------------------------------------------------------------------------------------------------------------------------------------------------------------|---------------------------------------------------------------------------------------------------------------------------------------------------------------------------------------------------------------------------------------------------------------------------------------------------------------------------------------------------------------------|
| <ol style="list-style-type: none"> <li>1. POWER (on/off) – Press VOLUME – Turn</li> <li>2. Station preset buttons/selecting position in CD changer (1-6)</li> <li>3. BASS – Press out and turn</li> <li>4. TREBLE – Press out and turn</li> <li>5. BALANCE – Press out and turn</li> <li>6. FADER – Press out and turn</li> <li>7. SOURCE PUSH MENU – Opens main menu – Press Turn to select:<br/>Radio – FM, AM<br/>CD<br/>CD changer (option)</li> <li>8. SCAN – Automatic station search</li> <li>9. EXIT – Scroll back in the menu</li> </ol> | <ol style="list-style-type: none"> <li>10. Navigation buttons – seek/change station or track</li> <li>11. CD eject</li> <li>12. CD slot</li> <li>13. CD random</li> <li>14. FM – Shortcut between FM1, FM2, FM3</li> <li>15. AM – Shortcut between AM1, AM2</li> <li>16. CD – Shortcut</li> <li>17. AUTO – Automatic station preset</li> <li>18. Display</li> </ol> |
|---------------------------------------------------------------------------------------------------------------------------------------------------------------------------------------------------------------------------------------------------------------------------------------------------------------------------------------------------------------------------------------------------------------------------------------------------------------------------------------------------------------------------------------------------|---------------------------------------------------------------------------------------------------------------------------------------------------------------------------------------------------------------------------------------------------------------------------------------------------------------------------------------------------------------------|

## Overview HU-850

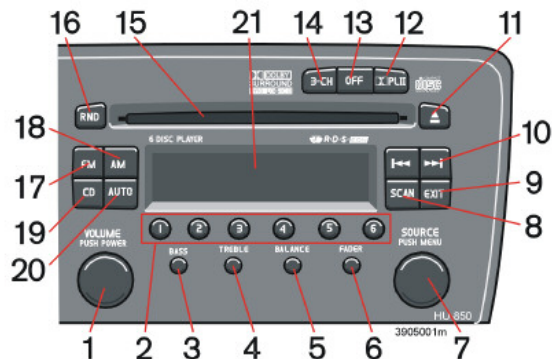

1. POWER (on/off) – Press VOLUME – Turn
2. Station preset buttons/selecting position in CD changer (1-6)
3. BASS – Press out and turn
4. TREBLE – Press out and turn
5. BALANCE – Press out and turn
6. FADER – Press out and turn
7. SOURCE PUSH MENU – Opens main menu – Press Turn to select:  
Radio – FM, AM  
CD  
CD changer (option)
8. SCAN – Automatic station search
9. EXIT – Scroll back in the menu
10. Navigation buttons – seek/change station or track
11. CD eject
12. Dolby Surround Pro Logic II
13. 2-channel stereo
14. 3-channel stereo
15. CD slot
16. CD random
17. FM – Shortcut between FM1, FM2, FM3
18. AM – Shortcut between AM1, AM2
19. CD – Shortcut
20. AUTO – Automatic station preset
21. Display

## Audio functions HU-450/650/850

### On/Off switch

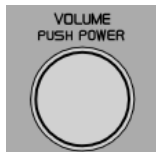

Press the knob to turn on or switch off the radio.

### Volume control

Turn the knob clockwise to increase volume. Volume control is electronic and

lacks an end stop. If you have a steering wheel keypad, increase or decrease volume with (+) or (-) buttons.

### Low battery voltage

If battery voltage is low, a text appears in the combined instrument unit display. The energy economy function of the car may switch off the radio. Charge the battery by starting the engine.

### Volume control - TP/PTY/NEWS

If a cassette or CD is playing when the radio receives a traffic bulletin, news or selected programme type, the function is interrupted and the bulletin or message is broadcast with the volume selected for traffic information, news or programme type. When the bulletin or message is finished, the unit immediately returns to the previously set volume and resumes playing the cassette or CD.

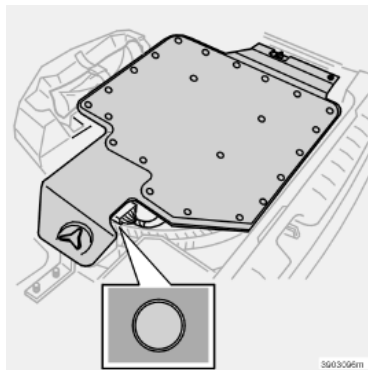

### Volume control - auxiliary bass speaker (option)

Turn the knob clockwise to increase volume (+6 dB).

Turn the knob anticlockwise to decrease volume or turn off the speaker.

The knob in the centre position = normalised position.



## Audio functions HU-450

### Bass



Adjust the bass by pressing out the knob and turning it to the left or right.

The bass is "normalised" in the centre position. Press the knob back into its

original position after adjustment.

### Treble



Adjust the treble by pressing the knob, pulling it out farther and turning it to the left or right. The treble is "normalised" in the centre position. Press the knob

back into its original position after adjustment.

### Fader - Balance front/rear



Set a suitable balance between the front and rear speakers by pressing the knob and turning it right (more sound from front pair) or left (more sound from rear

pair). The balance is "normalised" in the centre position. Press the knob back into its original position after adjustment.

### Balance - right/left



Adjust balance by pressing and pulling out the knob and turning it left or right. The balance is "normalised" in the centre position. Press the knob back into its

original position after adjustment.

### Selecting the sound source

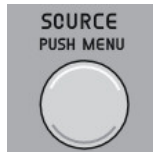

There are two ways to select sound source:

Either with the shortcut keys AM, FM, TAPE or with the SOURCE knob. Turn the SOURCE knob to select

between radio settings (FM1, FM2, FM3 and AM1, AM2). If a cassette player or CD changer (option) is connected, it can also be selected with the knob.



Press the AM or FM button repeatedly to toggle between FM1, FM2, FM3 and AM1, AM2.

The selected sound source is shown on the display.

## Audio functions HU-650/850

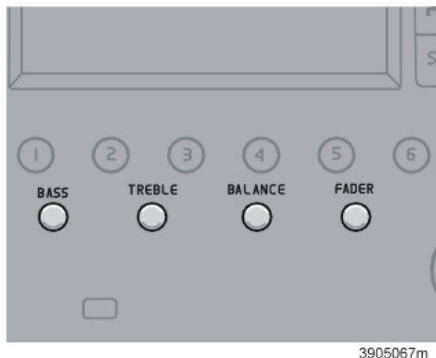

### Bass

Adjust the bass by pressing out the knob and turning it to the left or right.

The bass is "normalised" in the centre position. Press the knob back into its original position after adjustment.

### Treble

Adjust the treble by pressing the knob and turning it to the left or right. The treble is "normalised" in the centre position. Press the knob back into its original position after adjustment.

### Balance - right/left

Adjust balance by pressing the knob and turning it left or right. The balance is "normalised" in the centre position. Press the knob back into its original position after adjustment.

### Fader - Balance front/rear

Set a suitable balance between the front and rear speakers by pressing the knob and turning it right (more sound from front pair) or left (more sound from rear pair). The balance is "normalised" in the centre position. Press the knob back into its original position after adjustment.

### Selecting the sound source

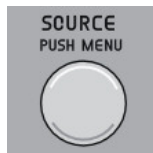

There are two ways to select sound source:

Either with the shortcut keys AM, FM, TAPE or with the SOURCE knob.

Turn the SOURCE knob to select between radio settings (FM1, FM2, FM3 and AM1, AM2). If a cassette player or CD changer (option) is connected, it can also be selected with the knob.

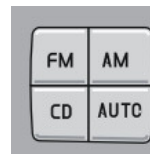

Press the AM or FM button repeatedly to toggle between FM1, FM2, FM3 and AM1, AM2.

The selected sound source is shown on the display.



## Radio functions HU-450/650/850

### Scanning







Press the SCAN button to start the search. When the radio finds a station, it stops there for about 10 seconds and then continues its search. To listen to the station, press the SCAN or EXIT button.

### Tuning

Press  or  to seek lower or higher frequencies. The radio searches for the next audible station and then stops. Press the button again to continue the search.

### Manual tuning

Press and hold  or . MAN is shown in the display. The radio slowly scrolls in the desired direction, increasing its tempo after a few seconds. Release the button when the desired frequency appears in the display. The frequency can then be adjusted by briefly pressing one of the arrow keys  or  within five seconds.



V70, XC70

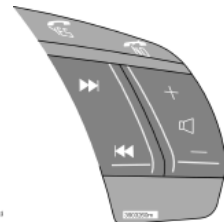

V70 R

### Steering wheel keypad

If you have a keypad in the steering wheel, press the right or left arrow to select preset stations.

**NOTE!** If the car is equipped with an integrated telephone, the steering wheel keypad cannot be used for radio functions while the telephone is in use. Telephone information is continuously displayed while the telephone is in use. Switch off the telephone with . If there is no SIM card in the telephone, switch it off, see page 216.

## Radio functions HU-450

### Programming stations

- Set the desired frequency.
- Briefly press the PRESET/CD knob. Select a number by turning forward or back. Press again to store the desired frequency and station.

### Preset



To select a preset radio programme, turn the PRESET/CD knob to the stored number. The preset programme is shown in the display.

### Autostoring stations

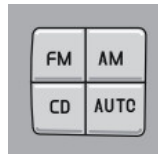

This function automatically seeks and stores up to 10 strong AM or FM stations in a separate memory. The function is especially useful in areas in which you are

unfamiliar with the radio stations or their frequencies.

- Select radio mode using the AM or FM button.
- Start the search by pressing and holding AUTO (more than 2 seconds).
- AUTO is shown in the display and a number of strong stations (max. 10) from

the set frequency band are saved in the autostore memory. If there are no stations with sufficient signal strength, NO STATION is displayed.

- Briefly press the AUTO button or one of the arrows of the steering wheel keypad to scroll to another of the automatically preset stations.

AUTO is shown in the display when the radio is in autostore mode. The text disappears when you return to ordinary radio mode.

Return to ordinary radio mode by pressing FM, AM or EXIT or by turning the PRESET/CD knob.

Returning to autostore mode:

Briefly press AUTO.

## Radio functions HU-650/850

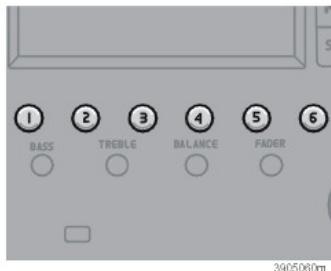

### Storing stations

To store stations on the preset buttons 1-6:

- Set the desired station.
- Press and hold the desired station storage button. The sound mutes a few seconds. STATION STORED is shown in the display.

Up to 6 stations each can be stored under AM1, AM2, FM1, FM2 and FM3 - a total of 30 stations.

### Autostoring stations

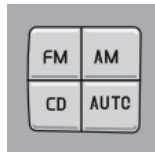

AUTO seeks and stores up to ten strong AM or FM stations in a separate memory. If more than ten stations are found, the ten strongest are selected. This function is particularly useful in areas in which you are unfamiliar with the radio stations and their frequencies.

- Select radio mode using the AM or FM button.
- Start the search by pressing and holding AUTO (more than 2 seconds).
- AUTO is shown in the display and a number of strong stations (max. 10) from the set frequency band are saved in the autostore memory. If there are no stations with sufficient signal strength, NO STATION is displayed.
- Briefly press the AUTO button or one of the arrows of the steering wheel keypad to scroll to another of the automatically preset stations.

AUTO is shown in the display when the radio is in autostore mode. The text disappears when you return to ordinary radio mode.

Return to ordinary radio mode by pressing the FM, AM or EXIT button.

Returning to autostore mode:

- Briefly press AUTO.

## Radio functions HU-450/650/850

### Radio Data System - RDS

RDS is a system that links together specific network transmitters. It is used, for example, to tune the correct frequency of a station irrespective of the transmitter or the active audio source (e.g. CD). The system can also be used for receiving traffic information and for finding broadcasts of a specific type.

Radio text is also a component of RDS. A radio station can, for example, transmit information about the radio programme currently being broadcast.

Some radio stations do not use RDS or only use a limited range of its features.

### PI seek (automatic search for stations)

When listening to an RDS transmitter, various information, such as traffic information, is stored in the radio.

When a preset RDS transmitter is later selected, the radio updates the transmitter's RDS information. If the radio is at the boundary or just outside of the transmitter's range, the radio automatically seeks the strongest possible transmitter of that channel.

If there is no audible transmitter, the radio quiets and the PI SEEK appears in the display until the station is found.

### Traffic information - TP station

Traffic information from RDS stations interrupts other sound sources. The message is heard at the volume set for this specific feature. As soon as the message ends, the audio system returns to the previous sound source and volume setting.

#### Activating traffic information:

- Select radio mode using the FM button and press SOURCE.
- Select TP and press SOURCE.
- Turn SOURCE, select TP ON (flashing text) and press SOURCE.
- Press EXIT.

#### Deactivate TP:

- Select radio mode using the FM button and press SOURCE.
- Select TP and press SOURCE.
- Turn SOURCE, select TP OFF (flashing text) and press SOURCE.
- Press EXIT.

TP is shown in the display when the function is activated. Press EXIT if you do not wish to listen to a traffic bulletin.

The TP function remains active and the radio waits for the next traffic bulletin.

### Activate traffic information from a special channel:

- Select radio mode using the FM button.
- Activate the station from which traffic information is to be received.
- Press SOURCE.
- Turn SOURCE, select ADVANCED MENU and press SOURCE.
- Turn SOURCE, select RADIO SETTINGS and press SOURCE.
- Turn SOURCE, select TP STATION and press SOURCE.
- Turn SOURCE, select SET CURRENT and press SOURCE.
- Press EXIT.

### Deactivating TP Station

- Select radio mode using the FM button and press SOURCE.
- Turn SOURCE, select ADVANCED MENU and press SOURCE.
- Turn SOURCE, select RADIO SETTINGS and press SOURCE.
- Turn SOURCE, select TP STATION and press SOURCE.
- Turn SOURCE, select TP STATION OFF and press SOURCE.
- Press EXIT.

## Radio functions HU-450/650/850

### Alarm

"Alarm!" is shown in the radio display when an alarm message is broadcast. This function warns motorists for serious collisions or other hazardous situations such as a collapsed bridge or nuclear mishap.

### TP search

This function allows you to listen to traffic information when travelling between different areas and countries without selecting a station.

- Select radio mode using the FM button and press SOURCE.
- Turn SOURCE, select ADVANCED MENU and press SOURCE.
- Turn SOURCE, select RADIO SETTINGS and press SOURCE.
- Turn SOURCE, select TP SEARCH and press SOURCE.
- Turn SOURCE, select TP SEARCH ON or TP SEARCH OFF (flashing text) and press SOURCE.
- Press EXIT.

### News

Messages with a programme code (such as news from RDS stations) will interrupt other sound sources at the volume set for this specific feature. As soon as the news

broadcast is finished, the audio system returns to the previous sound source and volume setting.

#### Activating News:

- Select radio mode using the FM button and press SOURCE.
- Turn SOURCE, select NEWS and press SOURCE.
- Turn SOURCE, select NEWS ON (flashing text) and press SOURCE.
- Press EXIT.

NEWS appears in the display.

#### Deactivating News:

- Select radio mode using the FM button and press SOURCE.
- Turn SOURCE, select NEWS and press SOURCE.
- Turn SOURCE, select NEWS OFF (flashing text) and press SOURCE.
- Press EXIT.

NEWS disappears from the display.

Press EXIT if you do not wish to listen to a news broadcast. The News function remains active and the radio waits for the next news programme.

### Interruptions for news from the current station

- Select radio mode using the FM button.
- Activate the station from which traffic information is to be received.
- Press SOURCE.
- Turn SOURCE, select ADVANCED MENU and press SOURCE.
- Turn SOURCE, select RADIO SETTINGS and press SOURCE.
- Turn SOURCE, select NEWS STATION and press SOURCE.
- Turn SOURCE, select SET CURRENT and press SOURCE.
- Press EXIT.

#### Deactivating News Station:

- Select radio mode using the FM button and press SOURCE.
- Turn SOURCE, select ADVANCED MENU and press SOURCE.
- Turn SOURCE, select RADIO SETTINGS and press SOURCE.
- Turn SOURCE, select NEWS STATION and press SOURCE.
- Turn SOURCE, select NEWS STN OFF and press SOURCE.
- Press EXIT.

## Radio functions HU-450/650/850

Programme type	Displayed
OFF	PTY OFF
News	News
Current affairs	Current
Information	Info
Sport	Sport
Education	Educ
Drama	Theatre
Culture and Art	Culture
Science	Science
Varied speech	Enterta
Pop music	Pop
Rock music	Rock
Easy listening	Easy list
Light classic	L Class
Serious classic	Classical
Other music	Other M
Weather & Metro	Weather
Finance	Economy
Children's progs	For children
Social affairs	Social
Religion	Spiritual
Phone In	Telephone
Travel and holiday	Travel
Leisure and hobby	Leisure
Jazz music	Jazz
Country music	Country
National music	Nation M

Programme type	Displayed
Oldies music	"Oldies"
Folk music	Folk
Documentary	Document

### Programme type - PTY

Use the PTY function to select between the various programme types.

- Select radio mode using the FM button and press SOURCE.
- Turn SOURCE, select PTY and press SOURCE.
- Turn SOURCE, select PTY in the menu and press SOURCE.
- The radio begins seeking the selected programme type.
- If you do not wish to listen to the station found by the radio, continue the search using the left or right arrow key.
- If the radio does not find a station with the selected programme type, it returns to the previous frequency.

Not all radio stations have a PTY designation.

### PTY standby

PTY mode is then in standby until the selected programme type is broadcast. When this happens, the radio automatically switches to the station broadcasting the selected programme type.

Deactivating:

- Select radio mode using the FM button and press SOURCE.
- Turn SOURCE, select PTY and press SOURCE.
- Turn SOURCE, select PTY OFF and press SOURCE.
- Press EXIT.

The PTY symbol disappears from the display and the radio resumes normal mode.

### PTY language

The PTY function can be used to select the language used in the radio display (English, German, French or Swedish).

- Select radio mode using the FM button and press SOURCE.
- Turn SOURCE, select ADVANCED MENU and press SOURCE.
- Turn SOURCE, select RADIO SETTINGS and press SOURCE.
- Turn SOURCE, select PTY LANGUAGE and press SOURCE.
- Turn SOURCE, select language and press SOURCE.
- Press EXIT.



## Radio functions HU-450/650/850

### Automatic frequency updating

The AF function is normally activated and ensures that the radio tunes to the strongest available transmitter.

#### Activating AF:

- Select radio mode using the FM button and press SOURCE.
- Turn SOURCE, select ADVANCED MENU and press SOURCE.
- Turn SOURCE, select RADIO SETTINGS MENU and press SOURCE.
- Turn SOURCE, select AF ON (flashing text) and press SOURCE.
- Press EXIT.

#### Deactivating AF:

- Select radio mode using the FM button and press SOURCE.
- Turn SOURCE, select ADVANCED MENU and press SOURCE.
- Turn SOURCE, select RADIO SETTINGS MENU and press SOURCE.
- Turn SOURCE, select AF OFF (flashing text) and press SOURCE.
- Press EXIT.

### Regional radio programmes

The regional function is normally deactivated. When the function is activated you can

continue to listen to a regional broadcasts even if the signal is weak.

#### Activating REG:

- Select radio mode using the FM button and press SOURCE.
- Turn SOURCE, select ADVANCED MENU and press SOURCE.
- Turn SOURCE, select RADIO SETTINGS MENU and press SOURCE.
- Turn SOURCE, select REG ON (flashing text) and press SOURCE.
- Press EXIT.

#### Deactivating REG:

- Select radio mode using the FM button and press SOURCE.
- Turn SOURCE, select ADVANCED MENU and press SOURCE.
- Turn SOURCE, select RADIO SETTINGS MENU and press SOURCE.
- Turn SOURCE, select REG OFF (flashing text) and press SOURCE.
- Press EXIT.

### EON - Local/Distant (Enhanced Other Networks)

When EON is activated, the radio programme is interrupted for traffic bulletins, news broadcasts or the like from other channels.

The function has two levels:

Local - only interrupts if the signal is strong.

Distant - also interrupts with weaker signals.

- Select radio mode using the FM button and press SOURCE.
- Turn SOURCE, select ADVANCED MENU and press SOURCE.
- Turn SOURCE, select RADIO SETTINGS MENU and press SOURCE.
- Turn SOURCE, select EON (flashing text) and press SOURCE.
- Turn SOURCE, select Local or Distant and press SOURCE.
- Press EXIT.

### Resetting RDS functions

Resets all radio settings to the original factory settings.

- Select radio mode using the FM button and press SOURCE.
- Turn SOURCE, select ADVANCED MENU and press SOURCE.
- Turn SOURCE, select RESET TO DEFAULT and press SOURCE.
- Press EXIT.

---

## Radio functions HU-450/650/850

### ASC (Active Sound Control)

The ASC function automatically adapts the volume of the radio to vehicle speed.

#### Activating ASC:

- Select radio mode using the FM button and press SOURCE.
- Turn SOURCE, select ADVANCED MENU and press SOURCE.
- Turn SOURCE, select AUDIO SETTINGS MENU and press SOURCE.
- Turn SOURCE, select ASC LEVEL and press SOURCE.
- Turn SOURCE select LOW, MEDIUM, HIGH or Off and press SOURCE.

### Radio text

Some RDS stations broadcast information, such as about programme content and artists.

Hold the FM button depressed a few seconds to access any transmitted radio text, which then appears in the display. After the text is shown twice, the radio once again displays the station/frequency. A brief press on EXIT ends the radio text display.

## Cassette player HU-450

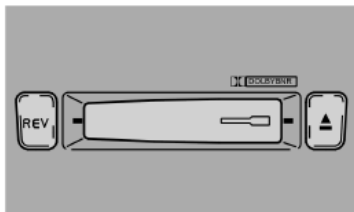

### Cassette opening

Insert the cassette in the slot with the wider part to the right. TAPE Side A appears in the display. When one side is finished, the player automatically plays the other side (auto reverse). To play a cassette that is already in the player, turn the SOURCE knob or press the TAPE shortcut key.

### Changing tape direction

Press the REV button in order to play the other side of the cassette; the side being played will be shown in the display.

### Cassette eject



If you press the button, the tape stops and the cassette is ejected. Turn the SOURCE knob to select a new programme source. The cassette can be inserted or ejected even if the system is switched off.

### Dolby B Noise Reduction

This is a preset function which can be switched off as follows: press and hold the REV button until the Dolby symbol disappears from the  display. Press the same button again in order to reactivate the Dolby function.

Dolby Noise Reduction is manufactured under license of Dolby Laboratories Licensing Corporation. Dolby and the double D symbol  are trademarks of Dolby Laboratories Licensing Corporation.

### Scanning





Scan plays the first ten seconds of each track.

Press the SCAN or EXIT button when you find a track you wish to listen to.



### Fast forward/reverse



The tape is fast forwarded by pressing and holding  and is rewound with . "FF" (fast forward) or "REW" (rewind) is shown in the display during this time.

Press the button again to stop fast forwarding/rewinding.

### Next track, Previous track

Pressing  automatically fast forwards the tape to the next track. Pressing  automatically rewinds the tape to the previous track. For this function to be operational, there must be a five second pause between tracks. If the car is equipped with a steering wheel keypad, the arrows can also be used.

## CD player HU-650

### CD player

Insert a CD. If there is already a CD in the player, activate it by turning the SOURCE knob or pressing the CD shortcut key.

### CD eject



If you press the button shown in the illustration, the CD player stops playing and the disc is ejected.

**NOTE!** For reasons of traffic safety, you have twelve seconds to handle the ejected disc. Otherwise, the CD is drawn back into the player and resumes with the most recently played track.

### Fast forward/reverse and change track



Press and hold down the right or left-hand arrow key to fast forward/reverse a track or the whole disc. Fast forward/reversing cannot be done using the steering

wheel keypad.

Briefly press the left or right-hand arrow key to go to the previous or next track. The steering wheel keypad can also be used for this. Track numbers are shown in the display.

The steering wheel keypad can also be used for this.

### Scanning

Scan plays the first ten seconds of each track.

Press the SCAN or EXIT button when you find a track you wish to listen to.

### Random



Press RND (random) to connect the random function. The system plays tracks from the disc in random order. "RND" is displayed as long as this function is activated.

### CD discs

Using CD discs burned at home could result in poor or non-existent sound. Music CD discs complying with the ISO 60908 standard provide the best sound quality.

### IMPORTANT!

Only use standard discs (12 cm in diameter). Do not use CDs with that have disc labels. The heat from the CD player could cause the label to come loose from the disc. The CD player could then be damaged.

## Internal CD changer HU-850

### Internal CD changer

HU-850 contains an internal 6-disc CD changer. Press the CD shortcut key or press the SOURCE knob to activate the CD player. The CD player resumes with the most recently played CD. Up to 6 discs can be inserted in the CD player. An empty slot in the player must be selected when inserting a disc. This is done by selecting from buttons 1-6. An available position is shown in the display. Make sure "LOAD DISC" is shown before inserting a new disc.

### CD eject



If you press the button shown in the illustration, the CD player stops playing and the disc is ejected.

**NOTE!** For reasons of traffic safety, you have twelve

seconds to handle the ejected disc.

Otherwise, the CD is drawn back into the player and resumes with the most recently played track.

### Selecting disc number

Use buttons 1-6 to select which disc is to be played. The disc and track numbers are shown in the display.

### Fast forward/reverse and change track



Press and hold down the right or left-hand arrow key to fast forward/reverse a track or the whole disc. Fast forward/reversing cannot be done using the steering wheel keypad.

Briefly press the left or right-hand arrow key to go to the previous or next track. The steering wheel keypad can also be used for this. Track numbers are shown in the display.

### Scanning

Scan plays the first ten seconds of each track.

Press the SCAN or EXIT button when you find a track you wish to listen to.

### Random



Press RND (random) to connect the random function. A randomly selected disc plays a randomly selected track. A new disc and track are then chosen the same way. "RND" is displayed as long as this function is activated.

### CD discs

Using CD discs burned at home could result in poor or non-existent sound. Music CD discs complying with the ISO 60908 standard provide the best sound quality.

#### **IMPORTANT!**

Only use standard discs (12 cm in diameter). Do not use CDs with that have disc labels. The heat from the CD player could cause the label to come loose from the disc. The CD player could then be damaged.

## External CD changer HU-450/650/850

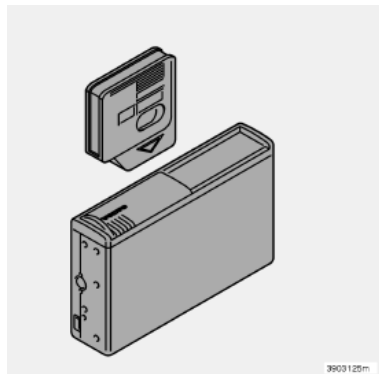

### CD changer

The external CD changer (option) is mounted behind the panel on the rear left-hand side of the cargo compartment.

Activate the CD changer mode by turning the SOURCE knob; the CD changer resumes playing the most recently played disc and track. If the CD player cartridge\* is empty, "LOAD CARTRIDGE" will be shown in the display.

Loading discs in the CD changer:

- Slide open the CD changer cover.
- Press the cartridge eject button on the changer.

- Pull out the CD cartridge and insert the discs.
- Reinsert the cartridge in the CD changer.

### Selecting discs

Select which disc is to be played by turning the PRESET/CD knob (HU-450) or using buttons 1-6 (HU-650/850). The disc and track numbers are shown in the display.

### Fast forward/reverse and change track



Press and hold down the right or left-hand arrow key to fast forward/reverse a track or the whole disc. Fast forward/reversing cannot be done using the steering wheel keypad.

Briefly press the left or right-hand arrow key to go to the previous or next track. The steering wheel keypad can also be used for this. Track numbers are shown in the display.

### Scanning

Scan plays the first ten seconds of each track.

Press the SCAN or EXIT button when you find a track you wish to listen to.

### Random



Press RND (HU-650 and 850) to activate the Random function. For radio HU-450, it is activated with the REV button. A randomly selected track is played from a randomly selected disc. A new track or disc is then selected the same way. "RND" is displayed while this function is active.

### CD discs

Using CD discs burned at home could result in poor or non-existent sound. Music CD discs complying with the ISO 60908 standard provide the best sound quality.

### IMPORTANT!

Only use standard discs (12 cm in diameter). Do not use CDs with that have disc labels. The heat from the CD player could cause the label to come loose from the disc. The CD player could then be damaged.

## Dolby Surround Pro Logic II HU-850

Dolby Surround Pro Logic II is a further refinement of the previous system and provides a significantly improved sound experience. This improvement is especially noticeable to rear seat passengers.

Dolby Surround Pro Logic II together with a centre speaker in the dashboard offers a sound experience very close to being there.

The normal left-right stereo channels are divided into left-centre-right. In addition, surround sound is produced by the rear speakers. Dolby Surround Pro Logic II works in CD mode.

3-channel stereo (3-CH ) is recommended for AM and FM radio transmissions.

Dolby Surround Pro Logic II is a registered trademark of Dolby Laboratories Licensing Corporation. Dolby Pro Logic II Surround System is licensed from Dolby Laboratories Licensing Corporation.

### Dolby Surround Pro Logic II Mode

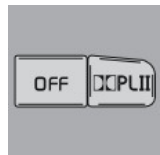

To select Dolby Surround Pro Logic II Mode, press "DOLBY PL II". "DOLBY PL II" is shown in the display. Press OFF to return to 2-channel stereo.

### 3-channel stereo

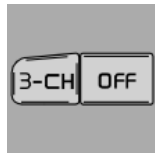

Select 3-channel stereo by pressing 3-CH; "3 ch" will be shown in the display. Resume 2-channel stereo function by pressing OFF.

### Centre Level

This function is used to set the level of the centre channel.

- Press SOURCE.
- Turn SOURCE, select ADVANCED MENU and press SOURCE.
- Turn SOURCE, select AUDIO SETTINGS and press SOURCE.
- Turn SOURCE, select CENTRE LEVEL and press SOURCE.
- Turn SOURCE, select level and press SOURCE.
- Press EXIT.

### Surround Level

This function is used to set the output level of the rear channels.

- Press SOURCE.
- Turn SOURCE, select ADVANCED MENU and press SOURCE.

- Turn SOURCE, select AUDIO SETTINGS and press SOURCE.
- Turn SOURCE, select SURROUND LEVEL and press SOURCE.
- Turn SOURCE, select level and press SOURCE.
- Press EXIT.

### Mid EQ Level

This function is used to fine-tune the sound from the speakers.

- Press SOURCE.
- Turn SOURCE, select ADVANCED MENU and press SOURCE.
- Turn SOURCE, select AUDIO SETTINGS and press SOURCE.
- Turn SOURCE, select MID EQ LEVEL and press SOURCE.
- Turn SOURCE, select level and press SOURCE.
- Press EXIT.

## Technical data

### HU-450

Output	4 x 25 W
Impedance	4 Ohm
Voltage required	12 V, negative ground

### Radio

Frequency	
U (FM)	87.5 – 108 MHz
M (AM)	522 – 1611 kHz
L (AM)	53 – 279 kHz

### HU-650

Output	4 x 25 W
Impedance	4 Ohm
Voltage required	12 V, negative ground
External amplifier (option)	4 x 50 W or 4 x 75 W

### Radio

Frequency	
U (FM)	87.5 – 108 MHz
M (AM)	522 – 1611 kHz
L (AM)	153 – 279 kHz

### HU-850

Output	1 x 25 W (centre loudspeaker)
Impedance	4 Ohm
Voltage required	12 V, negative ground
External amplifier	4 x 50 W or 4 x 75 W

HU-850 must be connected to an external amplifier.

### Radio

Frequency	
U (FM)	87.5 – 108 MHz
M (AM)	522 – 1611 kHz
L (AM)	153 – 279 kHz





---

## Telephone (option)

<b>Telephone system</b>	<b>214</b>
<b>Operating</b>	<b>216</b>
<b>Call options</b>	<b>217</b>
<b>Memory functions</b>	<b>221</b>
<b>Menu functions</b>	<b>222</b>
<b>Miscellaneous information</b>	<b>227</b>

# Telephone system

## General rules

- Put traffic safety first! If when driving you require to use the privacy handset in the armrest, park the car in a safe place first.
- Switch off the telephone when refuelling.
- Switch off the telephone in areas where blasting work is being carried out.
- Only allow authorised personnel service your telephone.

## Emergency calls

- Emergency calls to emergency services can be made without the ignition key or the SIM card.
- Press the ON/OFF button.
- Ring the emergency number that applies to your region (within EU: 112).
- Press the green button .

## Telephone system components

### 1. Keypad on centre console

All telephone functions can be controlled via the keypad in the centre console.

### 2. Steering wheel keypad

The majority of telephone functions can be controlled via the steering wheel keypad.

When the telephone is active, the keypad can only be used for telephone functions. Tele-

phone information is always shown in the display when the telephone is activated. The telephone must be deactivated in order to use the buttons for radio settings, page 216.

### 3. Display

The display will show menu functions, messages, telephone numbers, etc.

### 4. Privacy handset

The privacy handset can be used for private conversations when you do not wish to be disturbed.

### 5. SIM card

The SIM card is inserted below the keypad in the centre console.

Switch off the telephone whenever a SIM card is not in use. Otherwise, messages from other functions cannot be shown in the display.

### 6. Microphone

The microphone is integrated in the rearview mirror.

### 7. Loudspeaker

The speaker is integrated in the driver's seat head restraint.

### 8. Antenna

The antenna is mounted against the windscreen in front of the rearview mirror.

## Telephone system

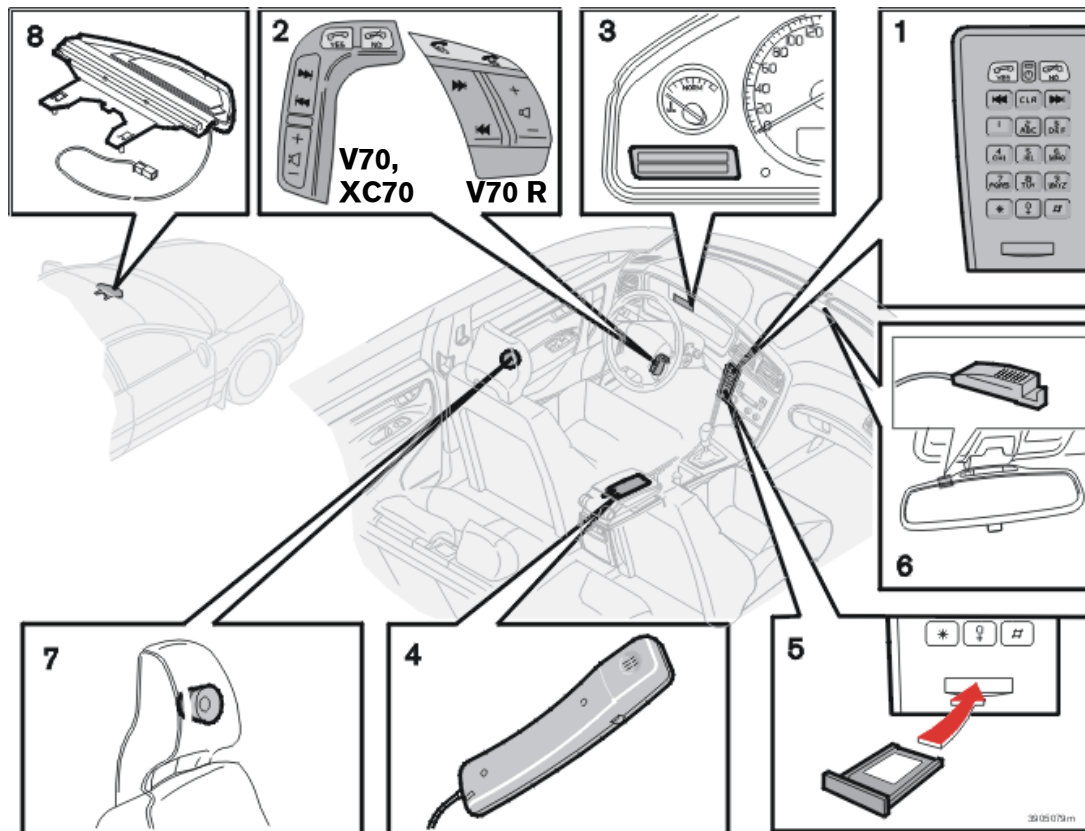

## Operating

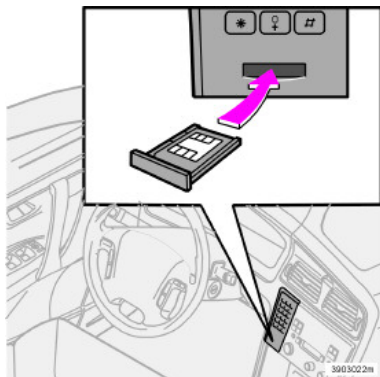

### SIM card

The telephone can only be used with a valid SIM card (Subscriber Identity Module). Your network operator supplies this card.

Always use the SIM card during telephone use; the name of your network operator will be displayed.

Switch off the telephone whenever a SIM card is not in use. Otherwise, messages from other functions cannot be displayed and the radio controls in the steering wheel keypad cannot be used.



### Switching the telephone on and off

To switch the telephone on: Turn the ignition key to position I. Press the button marked in the illustration.

To switch the telephone off: Press the same button for three seconds. If you switch off the car while the telephone is on, it will be on the next time you switch on the ignition.

Telephone calls cannot be received if the telephone is switched off.



### Active mode

The telephone must be in active mode for its functions to be available for use (does not apply to receiving calls). Activate the telephone by pressing  in the keypad in the centre console or in the steering wheel keypad.

Telephone information is shown continuously in the display when the telephone is activated.

Press  to deactivate the telephone.

## Call options

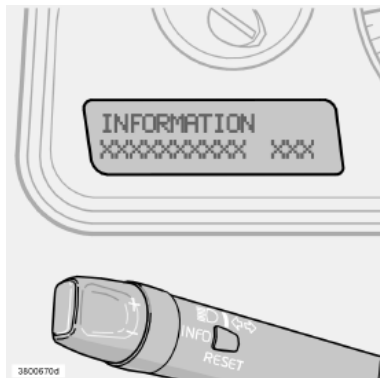



### Display

The display will show the function in use, for example menu selections, messages, telephone numbers or settings.



### Making and receiving calls

To call: dial the number and press  on the steering wheel or centre console keypad (or lift the handset).

To receive an incoming call: press  (or lift the privacy handset). You can also select Automatic Answer, refer to menu function 4.3.

The car audio system will be muted automatically while a telephone conversation is in progress. Refer to menu function 5.6.5 for information about audio system volume levels.



### Ending a call





To end a call, press  on one of the keypads or hang up the handset. The audio system resumes its previous mode.

## Call options



### Last number called

The telephone automatically stores the last telephone numbers/names called.

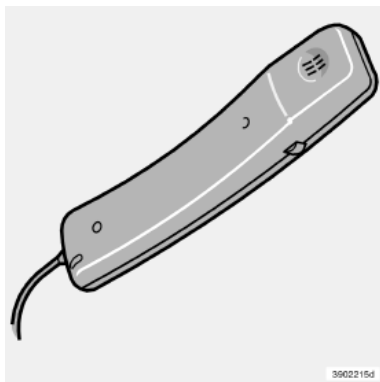

- Press  on one of the keypads.
- Use the arrows to scroll forward  or backward  through the last numbers called.
- Press  (or lift the privacy handset) to make the call.



### Privacy handset

If you wish to talk undisturbed, use the privacy handset.





- Lift the handset. Dial the number on the centre console keypad. Press  to call. Adjust the volume with the dial on the side of the handset.
- The call is ended when you replace the handset in its holder.

If you wish to switch to handsfree without ending the call: Press  and select Handsfree. Press  and put the handset down, page 217.

## Speed dial

### Storing speed dial numbers

A number stored in the telephone book can be linked to a speed dial button (1-9) as follows:

- Scroll with  to Edit memory (menu 3) and press .
- Scroll to Speed dial (Menu 3.4) and press .
- Choose the digit that is to be the speed dial number. Press  to confirm.
- Find the desired name or telephone number in the memory and press  to select it.

### Using speed dial

Press the desired speed dial button for about two seconds to make a call.

**NOTE!** Once you switch on the telephone, wait a moment before using speed dial. If you wish to use a speed dial number, Menu 4.5 must be activated, see page 225.

## Call options

### Functions during a call

The following functions are available during a call (scroll with the arrows and press YES to make a selection):

Secret mode/ Secret mode off	Secret mode
Hold/Don't hold	Choose whether or not the call is to be put on hold
Handset/ Handsfree	Use the handset or handsfree
Memory	Show stored numbers

The following functions are available when you have a current call and a parked call; scroll with the arrows and press YES to make a selection:



Secret mode/ Secret mode off	Secret mode
Handset/ Handsfree	Use the handset or handsfree
Memory	Show stored numbers
Three-way calling	Speak with both parties simultaneously (conference call)
Switch	Switch between the two calls

The following functions are available when you have selected Three-way calling and have two calls in progress (scroll with the arrows and press YES to make a selection):

Secret mode/ Secret mode off	Secret mode
Handset/ Handsfree	Use the handset or handsfree
Memory	Show stored numbers

### Call waiting

If you hear a tone in the speaker when the telephone is engaged followed by a two-tone signal, another party is placing a call to your phone. The two-tone signal will repeat until you answer the call or ringing ceases. When this occurs, you may accept or decline the call.

If you do not wish to take the call, press  or do nothing. If you do wish to take the call, press . Your current call will be put in "park mode". If you press , both calls will be terminated.

### SMS

A single two-tone signal indicates that you have received an SMS message.



### Call options



### Volume

Raise the volume with the (+) button in the steering wheel keypad. Lower the volume with the (-) button.

When the telephone is activated, the steering wheel keypad only controls the telephone functions.

If you wish to adjust radio settings using these buttons you must first deactivate the telephone, see page 216.

## Memory functions

Telephone numbers and names can be stored in either the telephone memory or the SIM card memory.

When you accept a telephone call from a party whose number is stored in the memory, their name will be shown in the display.

The telephone memory can store up to 255 names.

### Storing telephone numbers with names

- Press **1** and toggle to Edit memory (Menu 3). Press **YES**.
- Scroll to Enter item in memory (Menu 3.1) and press **YES**.
- Enter a number and press **YES**.
- Enter a name and press **YES**.
- Choose in which memory to save with **1** and press **YES**.

### Enter a name (or message)

Press the button with the relevant character: press once for the first character, twice for the second character and so on. Press 1 to enter a space.

<b>1</b>	space 1 - ? ! , . : ' ( )
<b>2</b> ABC	a b c 2 ä å à á â æ ç
<b>3</b> DEF	d e f 3 è é ê ë
<b>4</b> GHI	g h i 4 ï ï ï
<b>5</b> JKL	j k l 5
<b>6</b> MNO	m n o 6 ñ ò ó ô Ø
<b>7</b> PQRS	p q r s 7 ß
<b>8</b> TUV	t u v 8 ü ú ú û
<b>9</b> WXYZ	w x y z 9
<b>*</b>	if you enter two letters in a row from the same button, press * between them or wait a few seconds
<b>0</b> +	+ 0 @ * # & \$ £ / %
<b>#</b>	change between capital and lower case letters
<b>CLR</b>	delete the last letter or number entered. If you press for a long time, the enter number or text is deleted.



### Calling from the memory

- Press **1**.
- Choose from the following alternatives:
  - Press **YES** and scroll with the arrows until you find the desired name. Press the key of the first letter in the name (or enter the name) and press **YES**.
- Press **YES** to call the selected number.





### Menu functions

Use the menu function when checking functions, changing settings and programming new functions in your system. The various menu selections will be shown in the display.

#### Menu function

Press  to access the menu function.

The following applies in the menu function:

- A long press on  means you exit the menu function.
- A short press on  means that you retract, cancel or reject an alternative.
- A press on  means that you confirm or select, or that you scroll from a submenu to the next submenu.
- The right arrow  leads to the next side menu. The left arrow  leads to the previous side menu.



the menu system that have already been started.

The speed limiter can be disconnected using menu function 5.7.

#### Shortcuts

When you use the right-hand arrow  to enter the menu system, you can use numbers instead of the arrows and the green button

 to select the right menu on the main menu level (1, 2, 3, etc.), first submenu level (1.1, 2.1, 3.1, etc.) and the second submenu level (1.1.1, 2.1.1, etc.). The numbers are shown in the display together with the menu alternative.

#### Traffic safety

For reasons of safety, the menu system cannot be accessed at speeds in excess of 8 km/h. You may only complete activities in

## Menu functions

### Main menus/submenus

#### 1. Call register

- 1.1. Missed calls
- 1.2. Received calls
- 1.3. Dialed calls
- 1.4. Erase list
  - 1.4.1. All
  - 1.4.2. Missed
  - 1.4.3. Received
  - 1.4.4. Dialed
- 1.5. Call duration
  - 1.5.1. Last call
  - 1.5.2. Number of calls
  - 1.5.3. Total time
  - 1.5.4. Clear

#### 2. Messages

- 2.1. Read
- 2.2. Write
- 2.3. Voice message
- 2.4. Settings
  - 2.4.1. SMSC number
  - 2.4.2. Validity
  - 2.4.3. Type

#### 3. Edit memory

- 3.1. Enter item
- 3.2. Search
  - 3.2.1. Edit
  - 3.2.2. Erase
  - 3.2.3. Copy
  - 3.2.4. Move

- 3.3. Copy all
  - 3.3.1. SIM to phone
  - 3.3.2. Phone to SIM
- 3.4. Speed dial
- 3.5. Empty SIM
- 3.6. Empty memory
- 3.7. Status

#### 4. Call options

- 4.1. Transmit number
- 4.2. Call waiting
- 4.3. Automatic answer
- 4.4. Automatic redial
- 4.5. Speed dial
- 4.6. Call divert service
  - 4.6.1. All calls
  - 4.6.2. When busy
  - 4.6.3. When not answered
  - 4.6.4. Not available
  - 4.6.5. Fax calls
  - 4.6.6. Data calls
  - 4.6.7. Cancel all divers

#### 5. Settings

- 5.1. Factory settings
- 5.2. Network selection
- 5.3. Language
  - 5.3.1. English UK
  - 5.3.2. English US
  - 5.3.3. Svenska
  - 5.3.4. Dansk
  - 5.3.5. Suomi
  - 5.3.6. Deutsch

- 5.3.7. Nederlands
- 5.3.8. Français FR
- 5.3.9. Français CAN
- 5.3.10. Italiano
- 5.3.11. Español
- 5.3.12. Português P
- 5.3.13. Português BR

#### 5.4. SIM security

- 5.4.1. ON
- 5.4.2. OFF
- 5.4.3. AUTO

#### 5.5. Change codes

- 5.5.1. PIN code
- 5.5.2. Telephone code

#### 5.6. Volume

- 5.6.1. Ringer volume
- 5.6.2. Ringer tone
- 5.6.3. Button click
- 5.6.4. Speed volume
- 5.6.5. Radio Auto Suppression
- 5.6.6. New SMS

#### 5.7. Traffic safety

## Menu functions

### Menu options, description

#### 1. Call register

##### 1.1. Missed calls

A list of missed calls is shown here. You can choose to call, erase or store the number in the telephone or SIM card memory for later use.

##### 1.2. Received calls

A list of received calls is shown here. You can choose to call, erase or store the number in the telephone or SIM card memory for later use.

##### 1.3. Dialed calls

A list of dialled numbers is shown here. You can choose to call, erase or store the number in the telephone or SIM card memory for later use.

##### 1.4. Erase list

This option can be used to erase the list of menus 1.1, 1.2 and 1.3 as follows.

- 1.4.1. All
- 1.4.2. Missed
- 1.4.3. Received
- 1.4.4. Dialed

##### 1.5. Call duration

Here you can see the duration of all your calls or the most recent. You can also see the number of calls and clear the call timer.

- 1.5.1. Last call
- 1.5.2. Number of calls
- 1.5.3. Total time
- 1.5.4. Clear

Resetting the call timer requires the telephone code (see Menu 5.5).

#### 2. Messages

##### 2.1. Read

Here you can read received text messages. You can then choose to erase the message, forward it, change or save the entire message or parts of it.

##### 2.2. Write

You can write a text message using the keypad. Then choose to save or send it.

##### 2.3. Voice message

Listen to received messages.

##### 2.4. Settings

Enter the number (SMSC number) of the message centre to which you want your messages transferred. Specify how the message is to reach the addressee and how long it is to be stored in the message centre.

- 2.4.1. SMSC number
- 2.4.2. Validity
- 2.4.3. Type

Contact your service provider for information on these settings and for an SMSC number.

#### 3. Edit memory

##### 3.1. Enter item

You can store names and telephone numbers in the telephone or SIM card memory. See the section on memory functions for more information.

##### 3.2. Search

Changes in the memory can be made here.

- 3.2.1. Edit: Change data in the different memories.
- 3.2.2. Erase: Remove a saved name.
- 3.2.3. Copy: Copy a saved name.
- 3.2.4. Move: Transfer information between the memory of the telephone and the SIM card.

##### 3.3. Copy all:

Copy telephone numbers and names from the SIM card to the telephone memory.

- 3.3.1. From SIM to telephone memory
- 3.3.2. From telephone to SIM memory

##### 3.4. Speed dial

A number stored in the telephone book can be stored as a speed dial number.

##### 3.5. Empty SIM

The entire memory of the SIM card can be erased.

##### 3.6. Empty memory

The entire memory of the phone can be erased.

## Menu functions

### 3.7. Status

See how many places in the SIM card or telephone memory are occupied by names and numbers.

### 4. Call options

#### 4.1. Transmit number

Select whether or not your own number should be displayed to the person you call. Contact your network operator regarding permanently withheld numbers.

#### 4.2. Call waiting

Choose whether or not you want to be alerted during a phone call that there is another call coming in.

#### 4.3. Automatic answer

Chose to answer without using the keypad.

#### 4.4. Automatic redial

Choose to call a previously dialled number that was busy.

#### 4.5. Speed dial

Here you set whether or not speed dial is to be active. The function must be activated if you wish to dial using speed dial numbers.

#### 4.6. Call divert service

Here you can choose when and what type of calls are to be diverted to a specified telephone number.

4.6.1. All calls (this setting only applies during the call in progress).

4.6.2. When busy

4.6.3. When not answered

4.6.4. Not available

4.6.5. Fax calls

4.6.6. Data calls

4.6.7. Cancel all diverts

## 5. Settings

### 5.1. Factory settings

Function to return to the system's factory settings.

### 5.2. Network selection

Choose a network automatically or manually.

5.2.1. Auto

5.2.2. Manual

### 5.3. Language

Here you can choose which language the telephone is to display.

5.3.1. English UK

5.3.2. English US

5.3.3. Svenska

5.3.4. Dansk

5.3.5. Suomi

5.3.6. Deutsch

5.3.7. Nederlands

5.3.8. Français FR

5.3.9. Français CAN

5.3.10. Italiano

5.3.11. Español

5.3.12. Português P

5.3.13. Português BR

### 5.4. SIM security

Choose if the PIN code is to be on, off, or automatic.

5.4.1. ON

5.4.2. OFF

5.4.3. AUTO

### 5.5. Change codes

Change the PIN code or telephone code.

5.5.1. PIN code

5.5.2. Telephone code (use 1234 until you change to your own code). The telephone code is used to reset the call timer.

**NOTE!** Make a note of your code as save it in a safe place.

### 5.6. Volume

5.6.1. Ringer volume: Here you can choose the volume of the ringer for incoming calls.

5.6.2. Ring signal: You have eight different types of ring signals to choose from.

5.6.3. Button click: On or Off.

5.6.4. Speed volume: Choose whether the volume should be adjusted according to speed.

### Menu functions

- 5.6.5. Radio Auto Suppression: Here you choose whether the volume of the radio should remain the same during telephone calls.
- 5.6.6. New SMS: Select whether or not you wish the telephone to notify of new SMS messages with an audible signal.

#### **5.7. Traffic safety**

Here you can choose to disengage the speed limiter for the menu system, i.e. choose to use the menu system even while driving.

## Miscellaneous information

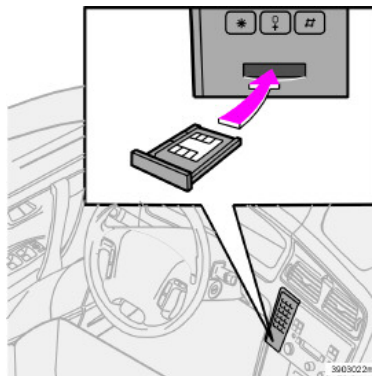

### Radio/Telephone

The four lower buttons on the steering wheel keypad are common to the audio system and telephone.

If you wish to control telephone functions with these buttons you must first activate the telephone, see page 216. If you wish to adjust radio settings using these buttons you must first deactivate the telephone.

Press  .

### Double SIM cards

Many network operators offer double SIM cards - one for your car and one for another telephone. A double SIM card allows you to have the same number for two different telephones. Ask your network operator about the offers available and the use of double SIM cards.

## Specifications

Output	2 W
SIM card	Small
Memory entries	255 <sup>1</sup>
SMS (Short Message Service)	Yes
Data/Fax	No
Dualband	Yes (900/ 1800)

1. The telephone memory contains 255 positions. The number of SIM card memory positions varies depending on your subscription.

### IMEI number

To block the telephone, you must provide your network operator with the telephone's IMEI number. This is a 15-digit serial number that is programmed in the phone. To display this number, press \*#06#. Make a note of this number and keep it in a safe place.



Telephone (option)

---

## Miscellaneous information

---

## Technical data

<b>Type designation</b>	<b>230</b>
<b>Dimensions and weights</b>	<b>231</b>
<b>Engine specifications</b>	<b>232</b>
<b>Engine oil</b>	<b>235</b>
<b>Other fluids and lubricants</b>	<b>238</b>
<b>Fuel</b>	<b>239</b>
<b>Catalytic converter</b>	<b>242</b>
<b>Electrical system</b>	<b>243</b>

## Type designation

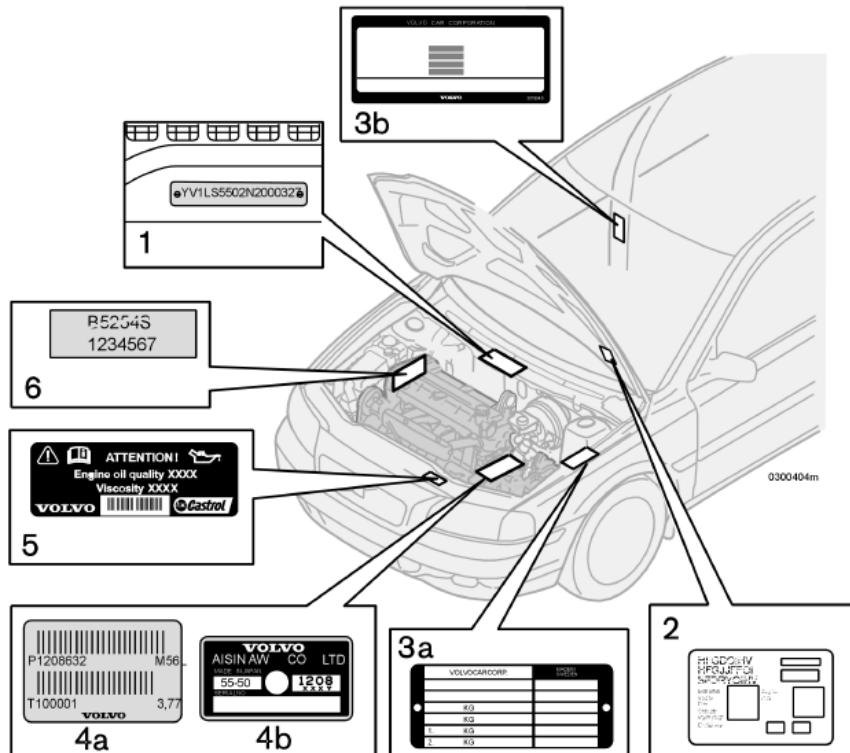

Whenever contacting your Volvo dealer and when ordering spare parts and accessories for your car, it makes things easier if you know your car's type designation, vehicle identification number and engine number.

1. Type and model year designation and vehicle identification number.
2. Decal for parking heater.
3. Type designation, vehicle identification number, maximum permissible weights, codes for colour and upholstery and type approval number.  
a: variant 1  
b: variant 2
4. Gearbox type designation and serial number  
a: Manual gearbox.  
b: Automatic gearbox AW.
5. Engine oil decal<sup>1</sup> specifies oil grade and viscosity.
6. Engine type designation, component and serial number.

1. Certain engine variants.

## Dimensions and weights

### Dimensions

**Length:** 472 cm (XC: 473 cm)

**Width:** 180 cm (XC: 186 cm)

**Height<sup>1</sup>:** 147-149 cm (AWD: 148-151 cm/  
XC: 155-156 cm/R: 145-149 cm)

**Wheelbase:** 276 cm

**Front track:** 156 cm (XC: 161 cm)

**Rear track:** 156 cm (XC: 155/R: 154 cm)

### Weights

The kerb weight includes the driver, the fuel tank 90 % full and all fluids. The weight of passengers and accessories, such as a towbar, towball load (when a trailer is hitched, see table), load carriers, and roof box etc. influence the payload and must not be included in the kerb weight. Permitted weight (in addition to driver) = Gross vehicle weight–Kerb weight.

#### **WARNING!**

The car's driving characteristics change depending on how heavily it is loaded and how the load is distributed.

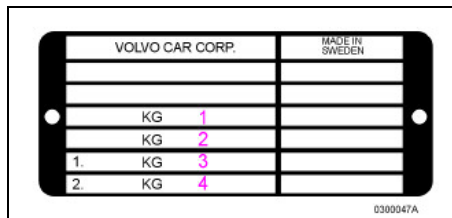

Variant 1

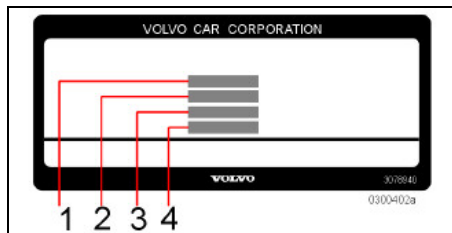

Variant 2

1. Max. total weight
2. Max. train weight (car+trailer)
3. Max. front axle load
4. Max. rear axle load

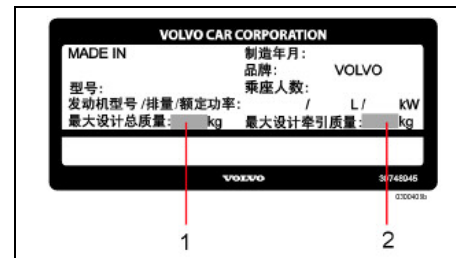

Only China

1. Max. total weight
2. Maximum trailer weight

**Maximum load:** See registration document.

**Maximum roof load:** 100 kg

#### Trailer with brakes

Maximum trailer weight:	Maximum towball load:
0-1200 kg	50 kg
1201-1800 kg	75 kg
B5204T5 Automatic 1600 kg	75 kg

#### Trailer without brakes

Maximum trailer weight: 750 kg

1. Depending on wheel and tyre size.

## Engine specifications

Engine type designation, component and serial number can be read on the engine, see page 230.

Specifications	Engine designation				
	<b>2.4 B5244S2</b>	<b>BI-FUEL (CNG) B5244SG</b>	<b>2.4 B5244S</b>	<b>2.0T B5204T5</b>	<b>2.5T B5254T2</b>
Output (kW/rps) (hp/rpm)	103/75	103/97	125/100	132/92	154/83
	140/4500	140/5800	170/6000	180/5500	210/5000
Torque (Nm/rps) (kpm/rpm)	220/55	192/75	225/75	240/31-83	320/25-75
	22.5/3300	19.6/4500	23.0/4500	24.5/1850- 5000	32.6/1500- 4500
No. of cylinders	5	5	5	5	5
Bore (mm)	83	83	83	81	83
Stroke (mm)	90	90	90	77	93.2
Swept volume (dm <sup>3</sup> or litres)	2.44	2.44	2.44	1.98	2.52
Compression ratio	10.3:1	10.3:1	10.3:1	9.5:1	9.0:1
<b>Spark plugs:</b>					
Electrode gap (mm)	1.2	1.2	1.2	0.7	0.7
Tightening torque (Nm)	30	30	30	30	30

## Engine specifications

Specifications	Engine designation		
	2.4 B5244T4 <sup>1</sup>	T5 B5244T5	R B5254T4
Output (kW/rps)	162/92	191/92	220/92 <sup>2</sup> 220/100 <sup>3</sup>
(hp/rpm)	220/5000	260/5500	300/5500 <sup>2</sup> 300/6000 <sup>3</sup>
Torque (Nm/rps)	350/35-67	350/35-83	400/33-88 <sup>2</sup> 350/31-100 <sup>3</sup>
AWD (kpm/rpm)	35.7/2100- 4000	35.7/2100- 5000	40.8/1950- 5250 <sup>2</sup> 35.7/1850- 6000 <sup>3</sup>
No. of cylinders	5	5	5
Bore (mm)	81	81	83
Stroke (mm)	93.2	93.2	93.2
Swept volume (dm <sup>3</sup> or litres)	2.4	2.4	2.52
Compression ratio	8.5:1	8.5:1	8.5:1
<b>Spark plugs:</b>			
Electrode gap (mm)	3x1.2	0.7	0.7
Tightening torque (Nm)	25	28	28

1. Thailand, Malaysia
2. Applies to manual gearbox M66C
3. Applies to automatic gearbox AW55-51

## Engine specifications

Specifications	Engine designation			
	D5 D5244T4	2.4D D5244T5	2.4D D5244T7	2.4D (7CV) D5244T6 <sup>1</sup>
Output (kW/rps)	136/67	120/67	92/67	90/67
(hp/rpm)	185/4000	163/4000	126/4000	122/4000
Torque (Nm/rps)	400/33-46	340/29-46	300/29-38	300/29-38
AWD (kpm/rpm)	40.8/2000- 2750	34.7/1750- 2750	30.6/1750- 2250	30.6/1750- 2250
AWD				
No. of cylinders	5	5	5	5
Bore (mm)	81	81	81	81
Stroke (mm)	93.2	93.2	93.2	93.2
Swept volume (dm <sup>3</sup> or litres)	2.40	2.40	2.40	2.40
Compression ratio	17.3:1	18.0:1	17.3:1	17.3:1
<b>Spark plugs:</b>				
Electrode gap (mm)	-	-	-	-
Tightening torque (Nm)	-	-	-	-

1. France

## Engine oil

### Adverse driving conditions

Check the oil level more frequently for long journeys:

- towing a caravan or trailer.
- in mountainous regions.
- at high speeds.
- in temperatures colder than  $-30\text{ }^{\circ}\text{C}$  or hotter than  $+40\text{ }^{\circ}\text{C}$ .
- shorter driving distances (shorter than 10 km) at low temperatures (under  $5\text{ }^{\circ}\text{C}$ ).

This may result in abnormally high oil temperature or oil consumption.

Choose a fully synthetic engine oil for adverse driving conditions. It provides extra protection for the engine.

Volvo recommends  oil products.

### IMPORTANT!

Always use the prescribed oil grade and viscosity.

If an oil other than that prescribed has been used, contact the local authorised Volvo workshop immediately for service.

Do not use oil additives. These can damage the engine.

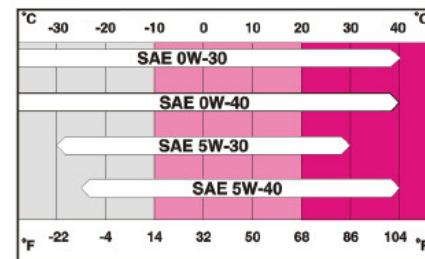

*Viscosity chart*



## Engine oil



*Oil decal*

When the oil decal shown alongside here is in the car's engine compartment, the following applies. See location on page 230.

**Oil grade: ACEA A1/B1**

**Viscosity: SAE 5W-30**

When driving under adverse conditions, use ACEA A5/B5 SAE 0W-30.

## Capacities

Engine variant		Volume between MIN - MAX (litres)	Volume <sup>1</sup> (litres)
Bi-fuel	B5244SG	1.2	5.8
R	B5254T4		5.5

## Engine oil



When the oil decal shown alongside here is in the car's engine compartment, the following applies. See location on page 230.

**Oil grade: ACEA A5/B5**

**Viscosity: SAE 0W-30**

*Oil decal*

### Capacities

Engine variant		Volume between MIN - MAX (litres)	Volume <sup>1</sup> (litres)
2.0T	B5204T5	1.2	5.5
2.4	B5244S		
	B5244S2		
2.4T	B5244T4 <sup>2</sup>		
T5	B5244T5		
2.5T	B5254T2		
D5	D5244T4	2.0	6.2
2.4D	D5244T5		
	D5244T7		
2.4 (7CV)	D5244T6 <sup>3</sup>		

1. Including filter change.
2. Thailand, Malaysia
3. France

## Other fluids and lubricants

### IMPORTANT!

The recommended transmission fluid must be used to prevent damage to the gearbox. Do not mix with any other transmission fluid. If the transmission is topped up with a different fluid, contact an authorised Volvo workshop for servicing.

Fluid	System	Volume	Recommended oil grade:
Gearbox oil	Manual 5 speed (M56/M58)	2.1 litres	Transmission fluid: MTF 97309
	Manual 6-speed (M66)	2.0 litres	
	Automatic gearbox (AW55-50, AW55-51)	7.2 litres	Transmission fluid JWS 3309
	Automatic gearbox (TF-80SC)	7.0 litres	
Coolant	Petrol engine without turbo	8.0 litres	Coolant with corrosion inhibitor mixed with water, see packaging. The thermostat starts opening at: 90 °C in petrol engines and at 82 °C in diesel engines.
	Petrol engine with turbo	9.0 litres	
	Diesel	12.5 litres	
Air conditioning		1000 g	Oil: PAG Refrigerant R134a (HFC134a)
Brake fluid		0.6 litres	DOT 4+
Power steering	System of which reservoir	0.9 litres 0.2 litres	Power steering fluid: WSS M2C204-A or equivalent product.
Washer fluid	without high-pressure washing	4.5 litres	Use a washer antifreeze recommended by Volvo, mixed with water for temperatures below freezing.
	with high-pressure washing	6.4 litres	

## Fuel

### Consumption and emissions

Engine		Gearbox	Consumption litre/100 km	Emissions of CO <sub>2</sub> (g/km)	Tank volume litres
2.4	B5244S2	Manual 5 speed (M56)	9.0	214	70
		Automatic gearbox (AW55-51)	9.7	231	
Bi-fuel	B5244SG	Manual 5 speed (M56)	9.0	215	30
		Automatic gearbox (AW55-51)	10.0	240	
2.4	B5244S	Manual 5 speed (M56)	9.2	220	70
		Automatic gearbox (AW55-51)	9.8	234	
2.0T	B5204T5	Manual 5 speed (M56)	9.1	217	70
		Automatic gearbox (AW55-51)	9.9	237	
2.5T	B5254T2	Manual 5 speed (M56)	9.2	219	70
		Automatic gearbox (AW55-51)	10.1	241	
	AWD	Manual 5-speed (M58)	9.9	237	72
		Automatic gearbox (AW55-51)	10.6	255	
	XC70	Manual 5-speed (M58)	10.2	244	72
		Automatic gearbox (AW55-51)	11.1	266	
2.4T	B5244T4 <sup>1</sup>	Automatic gearbox (AW55-51)	-	-	70
	AWD	Automatic gearbox (AW55-51)	-	-	72
	XC70	Automatic gearbox (AW55-51)	-	-	
T5	B5244T5	Manual 6-speed (M66)	9.5	226	70
		Automatic gearbox (AW55-51)	10.0	239	
V70 R	B5254T4	Manual 6-speed (M66)	10.7	256	68
		Automatic gearbox (TF-80SC)	11.1	264	
D5	D5244T4	Automatic gearbox (TF-80SC)	7.9	209	70
		Manual 6-speed (M66)	6.8	179	

**Fuel**

Engine		Gearbox	Consumption litre/100 km	Emissions of CO <sub>2</sub> (g/km)	Tank volume litres
D5 AWD	D5244T4	Automatic gearbox (TF-80SC)	8.3	219	68
		Manual 6-speed (M66)	7.3	194	
D5 XC70	D5244T4	Automatic gearbox (TF-80SC)	8.5	224	68
		Manual 6-speed (M66)	7.6	201	
2.4D	D5244T5	Automatic gearbox (TF-80SC)	7.9	209	70
		Manual 6-speed (M66)	6.8	179	
		Manual 5 speed (M56)	6.6	174	
2.4D	D5244T7	Manual 5 speed (M56)	6.5	172	
2.4D (7CV)	D5244T6 <sup>2</sup>	Manual 5 speed (M56)	6.5	172	

1. Thailand, Malaysia

2. France

## Fuel

### Fuel consumption and emissions of carbon dioxide

Official fuel consumption figures are based on a standard driving cycle in accordance with EU Directive 80/1268 comb. Fuel consumption figures may change if the car is equipped with extra equipment that affects the car's weight. The manner in which the car is driven and other non-technical factors can affect fuel consumption. Consumption is higher and power output lower for fuel with an octane rating of 91 RON.

### Petrol

Most engines can be run with octane ratings of 91, 95 and 98 RON.

- 91 RON must **not** be used in 4 cylinder engines.
- 95 RON can be used for normal driving.
- 98 RON is recommended for maximum effect and minimum fuel consumption.

When driving in temperatures above +38 °C, it is recommended to use fuel with the highest possible octane rating for optimum performance and fuel economy.

Petrol: Standard EN 228

Diesel: Standard EN 590

## Catalytic converter

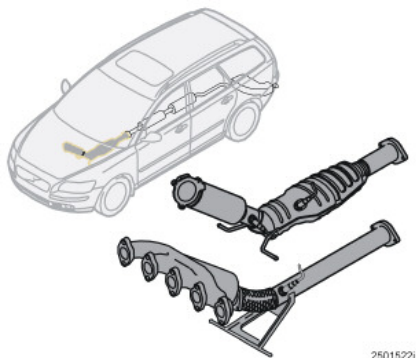

### General

The purpose of the catalytic converter is to purify exhaust gases. It is located in the flow of exhaust gasses close to the engine so that it quickly reaches operating temperature.

The catalytic converter consists of a monolith (ceramic or metal) with channels. The channel walls are lined with platinum/rhodium/palladium. These metals act as catalysts, i.e. they participate in and accelerate a chemical reaction without being used up themselves.

### Lambda-sond™ oxygen sensor

The Lambda-sond is part of a control system intended to reduce emissions and improve fuel economy.

An oxygen sensor monitors the oxygen content of the exhaust gases leaving the engine. This value is fed into an electronic system that continuously controls the injectors. The ratio of air to fuel is continuously adjusted. These adjustments create optimal conditions for efficient combustion, and together with the three-way catalytic converter reduce harmful emissions (hydrocarbons, carbon monoxide and nitrous oxides).

## Electrical system

### General

12 V system with a voltage-regulated alternator. Single pole system in which the chassis and engine block are used as conductors. The negative terminal is connected to the chassis.

The car is equipped with an extra ground lead to reduce the magnetic fields.

### Battery performance

Voltage	12 V	12 V	12 V
<b>Cold start capacity (CCA)</b>	520 A	600 A	800 <sup>1</sup> A
<b>Reserve capacity (RC)</b>	100 min	120 min	170 min

1. Cars equipped with diesel and parking heater.

If the battery is changed, replace it with a battery of the same cold start capacity and reserve capacity as the original (see the decal on the battery).

### Alternator

Max. current = 140 A

### Starter motor

Output = 1.4/2.2 kW



## Electrical system

### Bulbs

Lighting	Output W	Socket
1. Main beam	65	H9
2. Dipped beam	55	H7
3. Bi-Xenon	35	D2R
4. Fog lamp, front	55	H1
4. Fog lamp, front (V70 R)	55	H3
5. Front position lamps, front parking lamps, front side marker lamps, rear courtesy lighting	5	W 2.1 x 9.5d
6. Direction indicators, front/rear	21	BAU 15s
7. Direction indicators, side	5	W 2.1 x 9.5d
8. Brake lamp, reversing lamp	21	BA15s
9. Rear fog lamp	4	BAZ15d
10. Position lamps, rear,	5	BA15s
10. Side marker lamps, rear	10	BA15s
11. Number plate lighting, front courtesy lighting, cargo area lighting	5	SV8.5
12. Vanity mirror	1.2	SV5.5
Glovebox lighting	3	BA9

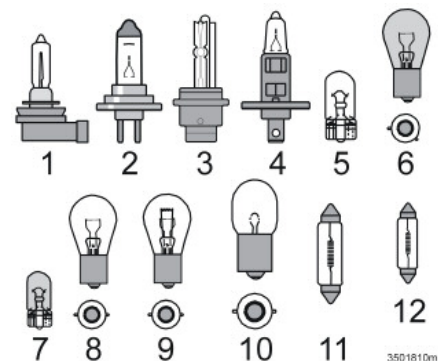

**A**

AC .....68  
 ABS, braking system ..... 121  
 Active chassis ..... 46, 48  
 Adaptive system ..... 118  
 Additional heater .....76  
 Air distribution, AC .....69  
 Air distribution, ECC .....71  
 Air quality system, ECC .....72  
 Airbags and inflatable curtains,  
 inspection .....25  
 Alarm .....107  
 Alternator ..... 243  
 Audio functions, HU-450/650/850 ..... 195  
 Audio HU-450, overview ..... 192  
 Audio HU-650, overview ..... 193  
 Audio HU-850, overview ..... 194  
 Audio, technical data .....211  
 Auto, ECC .....70  
 Automatic gearbox ..... 118  
 Automatic locking ..... 103  
 Auxiliary lamps .....47

**B**

Battery ..... 165, 174, 243  
 BLIS - Blind Spot Information  
 System .....46, 144  
 Bonnet ..... 167  
 Booster cushion, integrated .....31  
 Bulbs ..... 244

**C**

Carbon dioxide .....241  
 Cassette player, HU-450 .....206  
 Catalytic converter .....242  
 CD changer, external .....209  
 CD changer, internal, HU-850 .....208  
 CD player, HU-650 .....207  
 Child safety locks .....106  
 Child seat, fitting ..... 28, 32  
 Child seats and side airbags ..... 19  
 Cigarette lighter ..... 47  
 Clean inside and out .....3  
 Cleaning seatbelts .....159  
 Cleaning the upholstery .....159  
 Climate control ..... 66  
 Cold start .....118  
 Collision sensors ..... 21  
 Colour code, Paint .....160  
 Combined instrument panel ..... 40  
 Condensation ..... 66, 168  
 Courtesy lighting .....182  
 Cruise control ..... 54

**D**

Deadlocks ..... 47, 104  
 Defroster ..... 71  
 Detectors ..... 47  
 Diesel particle filter .....115  
 Dimensions .....231  
 Dipped beam ..... 49, 177

Direction indicators ..... 50, 178  
 Display, messages .....44  
 Door mirror defrosters .....69  
 Door mirrors ..... 47, 61  
 Door mirrors, defrosting .....48  
 DSTC ..... 46, 123

**E**

ECC .....66  
 Economical driving ..... 112  
 Electrical socket in the rear seat .....57  
 Electrical system ..... 243  
 Engine compartment ..... 167  
 Engine oil ..... 169, 236  
 Engine oil decal ..... 230  
 Engine specifications ..... 232  
 Environmental philosophy ..... 3  
 Expectant mothers .....11

**F**

Fan, AC .....69  
 Fan, ECC .....70  
 Floor mats .....86  
 Fog lamp ..... 49, 180  
 Front seats, heated .....48  
 Fuel consumption, current .....53  
 Fuel system ..... 168  
 Fuel, refuelling ..... 114  
 Functions during a call ..... 219  
 Fuses ..... 184

<b>G</b>	
Gear positions, six-speed .....	117
Gear selector inhibitor .....	118
Glovebox .....	86, 104
Gross vehicle weight .....	231
<b>H</b>	
Hazard warning flashers .....	48
Headlamp levelling .....	49
Headlamp pattern .....	139
Headlamp washer .....	51
Headlamp wipers .....	173
Headlamps .....	49, 176
Heated front seats .....	68
Heated rear window .....	69
Heating/Cooling, AC .....	68
Home safe lighting .....	50
HU-450, overview .....	192
HU-650, overview .....	193
HU-850, overview .....	194
<b>I</b>	
Ignition key .....	116
IMEI number .....	227
Immobiliser .....	100, 116
Important dialogue boxes .....	2
"Important!" texts .....	2
Indicator lamp .....	108
Indicator systems .....	41
Inflatable curtain .....	21
Information display .....	44
Instrument lighting .....	49
Instrument overview, left-hand drive .....	36
Instrument overview, right-hand drive .....	38
Integrated booster cushion .....	31
Interior .....	77
<b>K</b>	
Kerb weight .....	231
Keys .....	100
Kick-down .....	120
<b>L</b>	
Lambda-sond .....	242
Lighting .....	176
Lighting panel .....	49
Locking .....	103
Lock-up function .....	118
Lowering the backrest, front seat .....	78
Lubricants .....	238
<b>M</b>	
Main beam .....	49, 177
Main beam "flash" .....	50
Main beam, switching, flash .....	50
Manual climate control with air conditioning (AC) .....	68

<b>N</b>	
"Note" texts .....	2
Number plate lighting .....	182
<b>O</b>	
Oil filter .....	169
Oil grade .....	236
<b>P</b>	
PACOS .....	17
Paint, colour code .....	160
Panel vents .....	67
Parking assistance .....	47, 125
Parking brake .....	56
Parking heater .....	74
Parking heater, battery and fuel .....	75
Parking lamps .....	49, 178
Particle filter, diesel .....	115
Petrol grade .....	241
PI seek .....	201
Pinch protection, sunroof .....	64
Polishing and waxing .....	159
Position lamps .....	49, 178
Power windows .....	59
Privacy handset .....	218
<b>R</b>	
Radio functions .....	198
Radio functions, HU-450 .....	199

Radio functions, HU-650/850 ..... 200  
 Rain sensor .....51  
 Reading lamp .....81  
 Rear window, defrosting .....48  
 Rearview mirrors, interior .....61  
 Recirculation, AC .....69  
 Recirculation, ECC .....71  
 Recovery ..... 127  
 Refrigerant .....66  
 Relay/fuse box ..... 185  
 Remote control ..... 100  
 Remote control functions ..... 101  
 Remote control, battery replacement ..... 102  
 Rustproofing ..... 162

**S**

Safety systems, automatic gearbox ..... 118  
 Seat, power seat .....79  
 Seat, seating position .....78  
 Seatbelt reminder .....11  
 Seatbelts .....10  
 Service programme ..... 164  
 Side airbags .....19  
 Side direction indicators ..... 180  
 Side marker lamps ..... 179  
 SIM card ..... 216  
 SIM cards, double ..... 227  
 SIPS bag system .....20  
 Slippery driving conditions ..... 112  
 Speed dial ..... 218

Spots .....159  
 SRS system ..... 15  
 SRS, switch ..... 18  
 Stability system ..... 46  
 Standby mode, telephone .....216  
 Start assistance .....129  
 Starter motor .....243  
 STC ..... 46  
 Steering lock .....116  
 Steering wheel adjustment ..... 58  
 Storage spaces in the passenger compartment ..... 83  
 Storing radio stations ..... 199, 200  
 Sunroof ..... 63  
 Sunscreen, sunroof ..... 64  
 Switches in the centre console ..... 46  
 Symbols, warning and indicator ..... 41

**T**

Temperature, ECC ..... 70  
 Towball, removal .....135  
 Towbar .....132  
 Towing .....127  
 Towing eye .....127  
 Trailer weight .....231  
 Trip computer ..... 53  
 Tuning, radio .....198

Tyres  
     designation of dimensions ..... 148  
     direction of rotation ..... 150  
     driving characteristics ..... 148  
     recommended tyre pressure ..... 151  
     speed ratings ..... 148  
     tread wear indicators ..... 149

**U**

Unlocking ..... 103

**V**

Vanity mirror ..... 183  
 Vehicle data ..... 164  
 Viscosity ..... 236  
 Volume, telephone ..... 220  
 Volvo Cars and the environment ..... 3

**W**

Warning dialogue boxes ..... 2  
 Warning symbols .....41  
 "Warning!" texts ..... 2  
 Washer fluid ..... 171  
 Washing the car ..... 158  
 Waxing and polishing ..... 159  
 Weights ..... 231

Wheels	
changing .....	154
fitting .....	155
removal .....	154
Whiplash injury .....	22
WHIPS .....	22
WHIPS and child seat/booster	
cushion .....	22
Windscreen washer .....	51, 52
Windscreen wipers .....	51
Winter tyres .....	149



TP 8170 (English). AT 0540. Printed in Sweden, Elanders Infologistics Väst AB, Mölnlycke 2005

## Free Manuals Download Website

<http://myh66.com>

<http://usermanuals.us>

<http://www.somanuals.com>

<http://www.4manuals.cc>

<http://www.manual-lib.com>

<http://www.404manual.com>

<http://www.luxmanual.com>

<http://aubethermostatmanual.com>

Golf course search by state

<http://golfingnear.com>

Email search by domain

<http://emailbydomain.com>

Auto manuals search

<http://auto.somanuals.com>

TV manuals search

<http://tv.somanuals.com>