

WTI Part No. 13662
Rev. D

RSM Series

Remote Site Managers

Models Covered:

RSM-8
RSM-16
RSM-16DC
RSM-32
RSM-32DC

**For Firmware Version 2.16
and Higher**



User's Guide





Warnings and Cautions: Installation Instructions



Secure Racking

If Secure Racked units are installed in a closed or multi-unit rack assembly, they may require further evaluation by Certification Agencies. The following items must be considered.

1. The ambient within the rack may be greater than room ambient. Installation should be such that the amount of air flow required for safe operation is not compromised. The maximum temperature for the equipment in this environment is 45°C. Consideration should be given to the maximum rated ambient.
2. Installation should be such that a hazardous stability condition is not achieved due to uneven loading.

Input Supply

1. Check nameplate ratings to assure there is no overloading of supply circuits that could have an effect on overcurrent protection and supply wiring.
2. When installing 48 VDC rated equipment, it must be installed only per the following conditions:
 - A. Connect the equipment to a 48 VDC supply source that is electrically isolated from the alternating current source. The 48 VDC source is to be connected to a 48 VDC SELV source.
 - B. Input wiring to terminal block must be routed and secured in such a manner that it is protected from damage and stress. Do not route wiring past sharp edges or moving parts.
 - C. A readily accessible disconnect device, with a 3 mm minimum contact gap, shall be incorporated in the fixed wiring.

Grounding

Reliable earthing of this equipment must be maintained. Particular attention should be given to supply connections when connecting to power strips, rather than direct connections to the branch circuit.

No Serviceable Parts Inside; Authorized Service Personnel Only

Do not attempt to repair or service this device yourself. Internal components must be serviced by authorized personnel only.

- **Shock Hazard - Do Not Enter**
- **Lithium Battery**
CAUTION: Danger of explosion if battery is incorrectly replaced. Replace only with same or equivalent type recommended by the manufacturer. Discard used batteries according to the manufacturer's instructions.

Disconnect Power

If any of the following events are noted, immediately disconnect the unit from the outlet and contact qualified service personnel:

1. If the power cord becomes frayed or damaged.
2. If liquid has been spilled into the device or if the device has been exposed to rain or water.

Agency Approvals

FCC Part 15 Regulation

This equipment has been tested and found to comply with the limits for a Class A digital device, pursuant to part 15 of the FCC Rules. These limits are designed to provide reasonable protection against harmful interference when the equipment is operated in a commercial environment. This equipment generates, uses, and can radiate radio frequency energy and, if not installed and used in accordance with the instruction manual, may cause harmful interference to radio communications. Operation of this equipment in a residential area is likely to cause harmful interference in which case the user will be required to correct the interference at his own expense.

This device complies with part 15 of the FCC Rules. Operation is subject to the following two conditions: (1) This device may not cause harmful interference, and (2) this device must accept any interference received, including interference that may cause undesired operation

WARNING: *Changes or modifications to this unit not expressly approved by the party responsible for compliance could void the user's authority to operate the equipment*

EMC, Safety, and R&TTE Directive Compliance

The CE mark is affixed to this product to confirm compliance with the following European Community Directives:

- **Council Directive 89/336/EEC of 3 May 1989 on the approximation of the laws of Member States relating to electromagnetic compatibility;**
and
- **Council Directive 73/23/EEC of 19 February 1973 on the harmonization of the laws of Member States relating to electrical equipment designed for use within certain voltage limits;**
and
- **Council Directive 1999/5/EC of 9 March on radio equipment and telecommunications terminal equipment and the mutual recognition of their conformity.**

Industry Canada

This Class A digital apparatus complies with Canadian ICES-003.

Cet appareil numérique de la classe A est conforme à la norme NMB-003 du Canada.

This product meets the applicable Industry Canada technical specifications

The Ringer Equivalence Number is an indication of the maximum number of devices allowed to be connected to a telephone interface. The termination on an interface may consist of any combination of devices subject only to the requirement that the sum of the RENs of all the devices does not exceed five.

Table of Contents

1. Introduction	1-1
2. Unit Description	2-1
2.1. Front Panel	2-1
2.2. Back Panel	2-2
3. Getting Started	3-1
3.1. Quick Hardware Installation	3-1
3.1.1. Apply Power to the RSM	3-1
3.1.2. Connect your Control Device to the RSM	3-1
3.2. Communicating with the RSM	3-2
4. Hardware Installation	4-1
4.1. Connecting Power to the RSM Unit	4-1
4.1.1. AC Powered Units	4-1
4.1.2. DC Powered Units	4-1
4.2. Connecting the Network Cable	4-2
4.3. Connecting Devices to the RSM	4-2
5. Configuration	5-1
5.1. Communicating with the RSM Unit	5-1
5.1.1. The Text Interface	5-1
5.1.2. The Web Browser Interface	5-3
5.2. System SetUp Ports	5-4
5.3. Configuration Menus	5-4
5.4. Defining System Parameters	5-5
5.4.1. The Real Time Clock and Calendar	5-7
5.4.2. The Invalid Access Lockout Feature	5-8
5.4.3. The Audit Log	5-9
5.4.4. Callback Security	5-10
5.5. User Accounts	5-12
5.5.1. Supervisor Access	5-12
5.5.2. Port Access	5-12
5.6. Managing User Accounts	5-13
5.6.1. Viewing User Accounts	5-13
5.6.2. Adding User Accounts	5-14
5.6.3. Modifying User Accounts	5-16
5.6.4. Deleting User Accounts	5-16
5.7. RS232 Port Configuration	5-17
5.7.1. RS232 Port Modes	5-17
5.7.2. RS232 Port Configuration Menus	5-19
5.7.3. Configuring the Internal Modem	5-23
5.8. Network Configuration	5-24
5.8.1. Network Parameters	5-26
5.8.2. Network Port Parameters	5-27
5.8.3. IP Security	5-29
5.8.3.1. Adding IP Addresses to the Allow and Deny Lists	5-30
5.8.3.2. Linux Operators and Wild Cards	5-32
5.8.3.3. IP Security Examples	5-33
5.8.4. Static Route	5-34
5.8.5. Domain Name Server	5-35
5.8.6. SNMP Parameters	5-36

5. Configuration (continued)	
5.8.7. LDAP Parameters	5-38
5.8.7.1. Adding LDAP Groups	5-40
5.8.7.2. Viewing LDAP Groups	5-42
5.8.7.3. Modifying LDAP Groups	5-43
5.8.7.4. Deleting LDAP Groups	5-44
5.8.7.5. LDAP Kerberos Set Up	5-45
5.8.8. TACACS Parameters	5-47
5.8.9. RADIUS Parameters	5-49
5.9. Copying Parameters to Several RS-232 Ports (Text Interface Only)	5-51
5.10. Save User Selected Parameters	5-52
6. The Status Screens	6-1
6.1. The Port Status Screen (/S)	6-2
6.2. The Port Diagnostics Screen (/SD)	6-3
6.3. The Network Status Screen (/SN)	6-4
6.4. The Port Parameters Screens (/W)	6-5
7. Operation	7-1
7.1. Any-to-Any Mode	7-1
7.1.1. Port Connection and Disconnection	7-1
7.1.1.1. Connecting Ports	7-1
7.1.1.2. Disconnecting Ports	7-3
7.1.2. Defining Hunt Groups	7-5
7.2. Passive Mode	7-6
7.3. Buffer Mode	7-7
7.3.1. Reading Data from Buffer Mode Ports	7-7
7.3.2. Port Buffers	7-8
7.4. Modem Mode	7-9
8. Telnet & SSH Functions	8-1
8.1. Network Port Numbers	8-1
8.2. SSH Encryption	8-1
8.3. The Direct Connect Feature	8-2
8.3.1. Standard Telnet Protocol, SSH and Raw Socket	8-2
8.3.2. Configuration	8-2
8.3.3. Connecting to an RS232 Port using Direct Connect	8-4
8.3.4. Terminating a Direct Connect Session	8-6
9. The Syslog Feature	9-1
9.1. Configuration	9-1
9.2. Criteria for Generating a Syslog Message	9-2
9.3. Testing Syslog Configuration	9-3
10. SNMP Traps	10-1
10.1. Configuration	10-1
10.2. SNMP Trap Message	10-2
10.3. How and When SNMP Traps are Sent	10-2
10.4. Testing the SNMP Trap Function	10-3
11. Saving and Restoring Configuration Parameters	11-1
11.1. Sending Parameters to a File	11-1
11.2. Restoring Saved Parameters	11-2
12. Upgrading RSM Firmware	12-1
13. Command Reference Guide	13-1
13.1. Command Conventions	13-1
13.2. Command Summary	13-2
13.3. Command Set	13-3

Appendices:

A. RS232 Port Interface	Apx-1
B. Specifications	Apx-2
C. Customer Service	Apx-3
Index	Index-1

List of Figures

2.1.	Instrument Front Panel (Model RSM-8 Shown)	2-1
2.2.	Instrument Back Panel (Model RSM-8)	2-2
2.3.	Instrument Back Panel (Model RSM-16)	2-2
2.4.	Instrument Back Panel (Model RSM-32)	2-2
3.1.	The Port Status Screen - Text Interface (RSM-8 Shown)	3-3
3.2.	The Home Screen - Web Interface	3-3
4.1.	Terminal Block Assembly (DC Units Only)	4-1
5.1.	The Port Status Screen (Text Interface; RSM-8 Shown)	5-2
5.2.	The Home Screen (Web Browser Interface)	5-3
5.3.	The System Parameters Menu (Text Interface)	5-5
5.4.	The System Configuration Menu (Web Browser Interface)	5-5
5.5.	The Add User Menu (Text Interface; RSM-8 Shown)	5-14
5.6.	The Add User Menu (Web Browser Interface; RSM-8 Shown)	5-14
5.7.	Port Configuration Menu (Text Interface)	5-18
5.8.	Port Configuration Menu (Web Browser Interface)	5-18
5.9.	Network Parameters Menu (Supervisor Mode Only)	5-24
5.10.	Network Configuration Menu (Web Browser Interface)	5-24
5.11.	Network Parameters Menu (Web Browser Interface)	5-26
5.12.	Network Port Parameters Menu (Web Browser Interface)	5-27
5.13.	IP Security Menu (Text Interface)	5-29
5.14.	IP Security Menu (Web Browser Interface)	5-29
5.15.	Static Route Menu (Text Interface)	5-34
5.16.	Static Route Menu (Web Browser Interface)	5-34
5.17.	Nomain Name Server Menu (Text Interface)	5-35
5.18.	Domain Name Server Menu (Web Browser Interface)	5-35
5.19.	SNMP Access Menu (Text Interface)	5-36
5.20.	SNMP Trap Menu (Text Interface)	5-36
5.21.	SNMP Parameters Menu (Web Browser Interface)	5-36
5.22.	LDAP Parameters Menu (Text Interface)	5-38
5.23.	LDAP Parameters Menu (Web Browser Interface)	5-38
5.24.	LDAP Group Configuration (Text Interface)	5-40
5.25.	Add LDAP Group Menu (Text Interface; RSM-8 Shown)	5-41
5.26.	Add LDAP Group Menu (Web Browser Interface; RSM-8 Shown)	5-41
5.27.	View LDAP Group Menu (Text Interface; RSM-8 Shown)	5-42
5.28.	View LDAP Group Menu (Web Browser Interface; RSM-8 Shown)	5-42
5.29.	Modify LDAP Group Menu (Text Interface; RSM-8 Shown)	5-43
5.30.	Modify LDAP Group Menu (Web Browser Interface; RSM-8 Shown)	5-43
5.31.	Delete LDAP Group Menu (Web Browser Interface)	5-44
5.32.	LDAP Kerberos Set Up Menu (Text Interface)	5-45
5.33.	LDAP Kerberos Set Up Menu (Web Browser Interface)	5-45
5.34.	The TACACS Parameters Menu (Text Interface)	5-47
5.35.	The TACACS Parameters Menu (Web Browser Interface)	5-47
5.36.	The RADIUS Parameters Menu (Text Interface)	5-49
5.37.	The RADIUS Parameters Menu (Web Browser Interface)	5-49
5.38.	The Copy Port Parameters Menu	5-51
6.1.	Port Status Screen (Sample Data Shown - RSM-8 Unit Shown)	6-2
6.2.	Port Diagnostics Screen (RSM-8 Shown)	6-3
6.3.	Network Status Screen	6-4
6.4.	Port Parameters Screen (RS232 Port Shown)	6-5
6.5.	Port Parameters Screen (Network Port Shown)	6-5
9.1.	The Test Menu (Text Interface, Supervisor Mode Only)	9-3
A.1.	RS232 Port Interface	Apx-1

1. Introduction

The RSM-8, RSM-16, RSM-16DC, RSM-32 and RSM-32DC Remote Site Managers provide in-band and out-of-band access to RS-232 console ports and maintenance ports on UNIX servers, routers and any other network element that includes a serial console port. System administrators can access the RSM via TCP/IP network, using SSH or Telnet, or out-of-band via modem or local terminal. The RSM features two separate command interfaces; a convenient, user-friendly web browser interface, and a simple, command driven text interface.

Intelligent Port Selection

Each of the RSM's RS232 serial ports can be individually accessed by number, name or group via SSH or Telnet sessions. The RSM also allows direct connections using TCP port assignments. Each RSM serial port can be separately configured using simple menu driven commands to set the port password, data rate, flow control and other operating parameters.

The full matrix capability of the RSM allows you to easily connect any two ports on the switch, even when the ports are using different communications settings. Ports can also be connected or disconnected by a third party with supervisor rights, and system managers can swap various RS232 devices between ports at a remote location.

Security and Collocation Features

Secure Shell (SSHv2) encryption and address-specific IP security masks prevent unauthorized access to command and configuration functions. The RSM also provides two different levels of user security; the Supervisor level and the Non-Supervisor level. The Supervisor level, which is intended for use by system managers and other administrators, provides complete access to all RSM port connection / disconnection functions, operating features and configuration menus, and also allows access to any port on the switch. The Non-Supervisor level is ideal for collocation applications, since users are only permitted to view status and connect to the ports allowed by their password.

Capture Buffer

"Buffer Mode" allows individual ports to capture and store incoming data, such as error and status messages received from attached console ports. This "snapshot" of the last data received is stored in memory, and can be viewed, saved, or erased by the system operator at any time. Console messages can be stored in the RSM port buffers, and sent to a remote location via SYSLOG, or an SNMP message can be generated to alert administrators when new console messages are received.

Configuration Backup

Once you have configured the RSM to fit your application, parameters and options can be saved to an ASCII text file on your PC. This allows you to quickly restore user-selected parameters if unit configuration is accidentally altered or deleted. Saved parameters can also be uploaded to other RSM units. This allows rapid set-up when several units will be configured with identical or similar parameters.

RSM-8, RSM-16, RSM-16DC, RSM-32 and RSM-32DC Units

This User's Guide discusses five different models from our RSM product line: the RSM-8, RSM-16, RSM-16DC, RSM-32 and the RSM-32DC. Throughout this User's Guide, all of these units are referred to as the "RSM." Note however that these units differ as described below:

- **RSM-8:** 8 Serial Ports, 100 to 240 VAC, 50/60 Hz, 5 Watts
- **RSM-16:** 16 Serial Ports, 100 to 240 VAC, 50/60 Hz, 5 Watts
- **RSM-16DC:** 16 Serial Ports, -48 VDC
- **RSM-32:** 32 Serial Ports, 100 to 240 VAC, 50/60 Hz, 5 Watts
- **RSM-32DC:** 32 Serial Ports, -48 VDC.

Aside from the differences listed above, all other features function identically in all five models.

Typographic Conventions

^ (e.g. ^x)	Indicates a control character. For example, the text " ^x " (Control X) indicates the [Ctrl] key and the [X] key must be pressed simultaneously.
COURIER FONT	Indicates characters typed on the keyboard. For example, / E or / P 02.
[Bold Font]	Text set in bold face and enclosed in square brackets, indicates a specific key. For example, [Enter] or [Esc] .
< >	Indicates required keyboard entries: For Example: / P < n >.
[]	Indicates optional keyboard entries. For Example: / W [n].

2. Unit Description

2.1. Front Panel

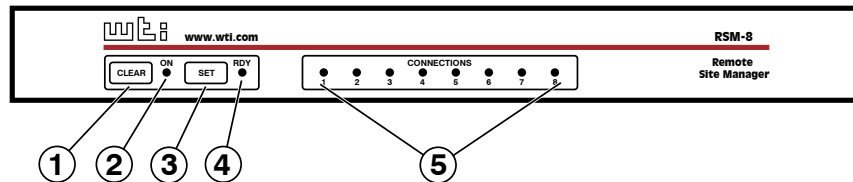

Figure 2.1: Instrument Front Panel (Model RSM-8 Shown)

- ① **CLEAR:** Restarts the RSM without changing user-selected parameter settings.
Note: When Clear is pressed, all ports will be disconnected.
- ② **ON:** Lights when AC Power is applied.
- ③ **SET:** Used to Initialize the RSM to default parameters. To initialize the RSM, press and hold the SET button for approximately five seconds.

Notes:

- During initialization, all port LEDs will flash ON three times.
 - After initialization, all command-selected parameters will be cleared, and the RSM will revert to the default parameters. The default "super" user account will also be restored.
- ④ **RDY:** (Ready) Flashes to indicate unit is operational.
 - ⑤ **ACTIVITY LEDs:** A series of LEDs, which light to indicate data activity at the corresponding port.
 - RSM-8 units include 8 Activity LEDs
 - RSM-16 and RSM-16DC units include 16 Activity LEDs
 - RSM-32 and RSM-32DC units include 32 Activity LEDs.

2.2. Back Panel

As shown in Figures 2.2, 2.3 and 2.4, the RSM Back Panel includes the following components:

- ① **Phone Line Port:** For connection to your external phone line.
- ② **Network Port:** An RJ45 Ethernet port for connection to your 10/100Base-T, TCP/IP network. Note that the RSM features a default IP address (192.168.168.168). This allows you to connect to the unit without first assigning an IP address. Note that the Network Port also includes two, small LED indicators for Link and Data Activity. For more information on Network Port configuration, please refer to Section 5.8.

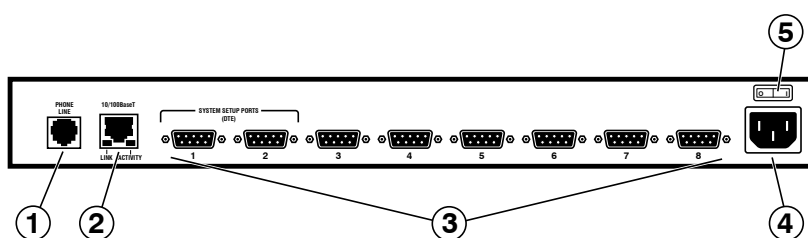

Figure 2.2: Instrument Back Panel (Model RSM-8)

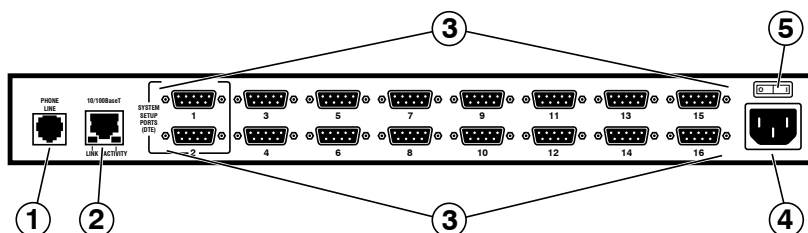

Figure 2.3: Instrument Back Panel (Model RSM-16)

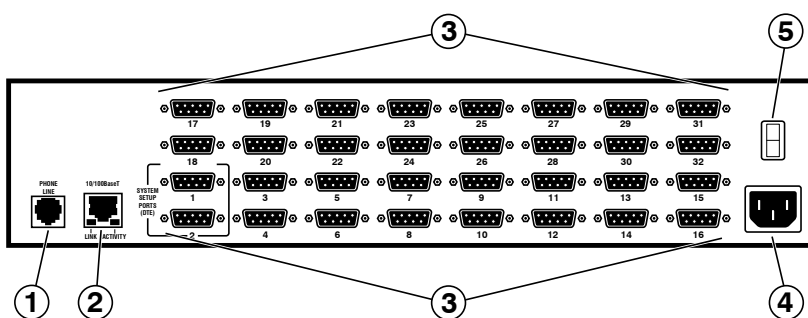

Figure 2.4: Instrument Back Panel (Model RSM-32)

- ③ **RS232 Serial Ports:** For connection to console ports on target devices. Standard DB9 connectors configured as DTE ports. The RS232 ports are similar to a serial port on a PC. When connecting a modem, use a standard serial cable. When connecting a PC or other DTE device use a null modem cable.
- RSM-8 units include 8 Serial Ports.
 - RSM-16 and RSM-16DC units include 16 Serial Ports.
 - RSM-32 and RSM-32DC units include 32 Serial Ports.
- ④ **Power Inlet:** An IEC-320-C14 inlet, for connection to your 100 to 240 VAC power supply. Note that RSM-16DC and RSM-32DC units (-48 VDC powered models) include a terminal block assembly (see Figure 4.1) in place of the power inlet. For more information, please refer to Section 4.1.
- ⑤ **Power On/Off Switch**

3. Getting Started

This section describes a simplified installation procedure for our RSM-8, RSM-16, RSM-16DC, RSM-32 and RSM-32DC models, which will allow you to communicate with the unit in order to demonstrate basic features and check for proper operation.

Note that this Quick Start Guide does not provide a detailed description of unit configuration, or discuss advanced operating features in detail. In order to take full advantage of the features provided by this unit, it is recommended that you should complete the entire Installation and Configuration sections after performing this Quick Start procedure.

3.1. Quick Hardware Installation

3.1.1. Apply Power to the RSM

Refer to the safety precautions listed at the beginning of this User's Guide and in Section 4, and then connect the unit to an appropriate power source. Note that RSM-8, RSM-16 and RSM-32 units are designed for 100 to 240 VAC, 50/60 Hz operation and feature an auto sensing power supply; while RSM-16DC and RSM-32DC models are designed for -48 VDC operation.

When power is applied to the RSM, the ON LED should light, and the RDY LED should begin to flash. Note however, that the boot up procedure may take up to two minutes; this delay is due to the time required to generate SSH keys.

3.1.2. Connect your Control Device to the RSM

The RSM can either be controlled via local PC Serial Port, modem, or TCP/IP network. In order to connect ports or select parameters, commands are issued to the RSM via either the Network Port, Modem or RS232 Setup Port. Note that it is not necessary to connect to both the Network and Setup Ports, and that the Setup Port can be connected to either a local PC or an external modem.

- **Network Port:** Connect your 10Base-T or 100Base-T network interface to the RSM 10/100Base-T Network port.
- **Console Port:** Use the supplied null modem cable to connect your PC COM port to the RSM Set-Up Port (RS232).
- **Modem:** Connect your phone line to the RSM's Phone Line (Modem) port.

3.2. Communicating with the RSM

When properly installed and configured, the RSM will allow command mode access via Telnet, Web Browser, SSH client, modem, or local PC. However, in order to ensure security, both Telnet and Web Browser access are disabled in the default state. To enable Telnet and/or Web Browser access, please refer to Section 5.8.

Notes:

- *Default RSM serial port parameters are set as follows: 9600 bps, RTS/CTS Handshaking, 8 Data Bits, One Stop Bit, No Parity. Although these parameters can be easily redefined, for this Quick Start procedure, it is recommended to configure your communications program to accept the default parameters.*
- *The RSM features a default IP Address (192.168.168.168) and a default Subnet Mask (255.255.255.0.) This allows network access to command mode, providing that you are contacting the RSM from a node on the same subnet. When attempting to access the RSM from a node that is not on the same subnet, please refer to Section 5.8 for further configuration instructions.*

1. **Access Command Mode:** The RSM includes two separate user interfaces; the Text Interface and the Web Browser Interface. The Text Interface is available via Local PC, SSH Client, Telnet, or Modem and can be used to both configure the RSM and create connections between ports. The Web Browser interface is only available via TCP/IP network, and can be used to configure the unit, but cannot create port connections.
 - a) **Via Local PC:** Start your communications program and then press **[Enter]**.
 - b) **Via SSH Client:** Start your SSH client, enter the default IP address (192.168.168.168) for the RSM and invoke the connect command.
 - c) **Via Web Browser:** Make certain that Web Browser access is enabled as described in Section 5.8. Start your JavaScript enabled Web Browser, enter the default RSM IP address (192.168.168.168) in the Web Browser address bar, and then press **[Enter]**.
 - d) **Via Telnet:** Make certain that Telnet access is enabled as described in Section 5.8.1. Start your Telnet client, and enter the RSM's default IP address (192.168.168.168).
 - e) **Via Modem:** Use your communications program to dial the number for the line connected to the RSM's Phone Line port.
2. **Username / Password Prompt:** A message will be displayed, which prompts you to enter your username (Login) and password.. The default username is "**super**" (all lower case, no quotes), and the default password is also "**super**". If a valid username and password are entered, the RSM will display either the Home Screen (Web Browser Interface) or the Port Status Screen (SSH, Telnet, or Modem) as shown in Figure 3.1 and Figure 3.2.

```

PORT STATUS:
Site ID: (undefined)                                02/07/2007 00:23:39 GMT (GMT+0000)

PORT | NAME | USERNAME | STATUS | MODE | BUFFER COUNT
-----|-----|-----|-----|-----|-----
01 | (undefined) | | Free | Any | 0
02 | (undefined) | | Free | Any | 0
03 | (undefined) | | Free | Pass | 0
04 | (undefined) | | Free | Pass | 0
05 | (undefined) | | Free | Pass | 0
06 | (undefined) | | Free | Pass | 0
07 | (undefined) | | Free | Pass | 0
08 | (undefined) | | Free | Pass | 0
09 | MODEM | | Free | Modem | 0

Enter /H for command menu.
RSM>

```

Figure 3.1: The Port Status Screen - Text Interface (RSM-8 Shown)

The screenshot shows the web interface for the NetReach Model RSM. At the top left is the WTI logo. Below it, the location is set to '(undefined)'. A navigation menu on the left includes 'Home', 'System Parameters', 'Serial Port', 'Network Configuration', and 'Users'. The main content area displays 'NetReach™ Model RSM' with the subtitle 'SSHv2 Remote Site Manager' and a 'Powered by Linux' logo. A central image shows the physical RSM hardware unit. Below the image, it says 'RSM Version: 2.16'. At the bottom, there is a copyright notice: '© 2007 Western Telematic Inc., 5 Sterling, Irvine, Ca. 92618 -- http://www.wti.com'.

Figure 3.2: The Home Screen - Web Interface

3. **Review Help Menu:** If you are communicating with the RSM via the text interface (SSH, Telnet or Modem), type `/H` and press **[Enter]** to display the Help Menu, which lists all available RSM commands. Note that the Help Menu is not available via the Web Browser Interface.
4. **Creating Connections Between Ports:** The RSM can perform two types of connections; Resident Connections and Third Party Connections. Note that Port Connection commands are only available via the Text Interface, and cannot be invoked via the Web Browser Interface.
 - a) **Resident Connection:** Your resident port (e.g. Port 1) issues a `/C` command to connect to a second port.
 - i. To connect Port 1 to Port 2, type `/c 2` **[Enter]**. While Port 1 is connected, the RSM will not recognize commands issued at Port 1. However, the unit will recognize a Resident Disconnect Sequence issued at Port 1 or Port 2.
 - ii. Issue the Resident Disconnect Sequence (Logoff Sequence); type `^x` (press **[Ctrl]** and **[X]** at the same time).

- b) **Third Party Connection:** Your resident port (e.g. Port 1) issues a /C command to create a connection between two other ports.
 - i. To connect Port 2 to Port 3, type /c 2 3 [Enter].
 - ii. While Ports 2 and 3 are connected, Port 1 will still recognize RSM commands. Type /s [Enter] to display the Port Status Screen. The "STATUS" column should now list Ports 2 and 3 as connected, and Port 1 as "Free".
 - iii. Issue a Third Party Disconnect command to disconnect Ports 2 and 3; type /D 2 [Enter]. The unit will display the "Are you Sure (y/n)?" prompt. Type y and press [Enter] to disconnect.
 - iv. Type /s [Enter] to display the Port Status Screen. The Status screen should now list Ports 2 and 3 as "Free".
5. **Exit Command Mode:** When you finish communicating with the unit via the text interface, it is important to always log off using the appropriate RSM command, rather than by simply closing your Telnet program. When you log off using the proper command, this ensures that the unit has completely exited from command mode, and is not waiting for the inactivity timeout to elapse before allowing additional connections. To exit command mode, type /x and press [Enter].

This completes the RSM Quick Start procedure. Prior to placing the unit into operation, it is recommended to refer to the remainder of this User's Guide for important information regarding advanced configuration capabilities and more detailed operation instructions. If you have further questions regarding the RSM unit, please contact WTI Customer Support as described in Appendix C.

4. Hardware Installation

4.1. Connecting Power to the RSM Unit

The RSM is available in both AC and DC powered versions. When connecting AC or DC power to the RSM, proceed as follows:



CAUTIONS:



- **Before attempting to install this unit, please review the warnings and cautions listed at the front of the user's guide.**
- **This device should only be operated with the type of power source indicated on the instrument nameplate. If you are not sure of the type of power service available, please contact your local power company.**
- **Reliable earthing (grounding) of this unit must be maintained. Particular attention should be given to supply connections when connecting to power strips, rather than directly to the branch circuit.**

4.1.1. AC Powered Units

Plug the power cable (supplied with the unit) into the receptacle on the RSM back panel. Then, connect the power cable to an appropriate, grounded outlet. The RSM features a self adjusting power supply that automatically adapts to power supplies between 90 and 250 VAC. Press the Power Switch ON. The ON LED should light and the RDY LED should begin to flash.

4.1.2. DC Powered Units

When connecting the RSM to your DC Power source, first remove the protective cover from the terminal block, attach the wires from the -48 VDC power source to the screw terminals, connect the ground line to the labeled ground screw, and then replace the protective cover.

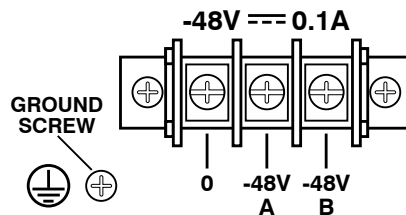

Figure 4.1: Terminal Block Assembly (DC Units Only)

4.2. Connecting the Network Cable

The Network Port is an RJ45, 10/100BaseT Ethernet Jack, for connection to a TCP/IP network. Note that the RSM features a default IP Address (192.168.168.168.) Providing that you are communicating with the unit from a node on the same subnet, this allows you to contact the RSM without first accessing command mode to assign an IP address.

When installing the RSM in a working network environment, it is recommended to assign the IP Address, Gateway Address, and Subnet Mask as described in Section 5.8.

4.3. Connecting Devices to the RSM

1. Determine which RSM port will be used for connection to the new device (e.g. Port 3).
2. Use an appropriate DB9 cable to connect the RS232 serial port on the device to a DB9 port on the RSM.
 - a) **External Modems and other DCE Devices:** Use a standard serial modem cable.
 - b) **PCs and other DTE Devices:** Use a null modem cable.
3. Access the RSM command mode and select communication parameters for each RSM port as described in Section 5.7.

5. Configuration

5.1. Communicating with the RSM Unit

In order to configure the RSM, you must first connect to the unit, and access command mode. Note that, the RSM offers two separate configuration interfaces; the Web Browser Interface and the Text Interface.

In addition, the RSM also offers three different methods for accessing command mode; via network, via modem, or via local console. The Web Browser interface is only available via network, and the Text Interface is available via network (SSH or Telnet), modem or local PC.

5.1.1. The Text Interface

The Text Interface consists of a series of simple ASCII text menus, which allow you to set options and define parameters by entering the number for the desired option using your keyboard, and then typing in the value for that option.

Since the Web Browser Interface and Telnet accessibility are both disabled in the default state, you will need to use the Text Interface to contact the unit via Local PC or SSH connection when setting up the unit for the first time. After you have accessed command mode using the Text Interface, you can then enable Web Access and Telnet Access in order to allow future communication with the unit via Web Browser or Telnet. You will not be able to contact the unit via Web Browser or Telnet until you have specifically enabled those options.

Once Telnet Access is enabled, you will then be able to use the Text Interface to communicate with the RSM via local PC, Telnet or SSH connection. You can also use the text interface to access command mode via the RSM's internal modem, or via an external modem installed at one of the RSM's RS232 serial ports.

In order to use the Text Interface, your installation must include:

- **Access via Network:** The RSM must be connected to your TCP/IP Network, and your PC must include a communications program (such as HyperTerminal.)
- **Access via Modem:** A phone line must be connected to the RSM's Phone Line port, and your PC must include a communications program.
- **Access via Local PC:** Your PC must be physically connected to one of the RSM's RS232 ports as described in Section 4.3, and your PC must include a communications program.

To access command mode via the Text Interface, proceed as follows:

Note: *Command mode cannot be accessed via a Buffer Mode Port, Passive Mode Port, or any port that is presently connected to another RSM port.*

1. Contact the RSM Unit:
 - a) **Via Local PC:** Start your communications program and press **[Enter]**. Wait for the connect message, then proceed to Step 2.
 - b) **Via Network:** The RSM includes a default IP address (192.168.168.168) and a default subnet mask (255.255.255.0.) This allows you to contact the unit from any network node on the same subnet, without first assigning an IP Address to the unit. For more information, please refer to Section 5.8.
 - i. **Via SSH Client:** Start your SSH client, and enter the RSM's IP Address. Invoke the connect command, wait for the connect message, then proceed to Step 2.
 - ii. **Via Telnet:** Start your Telnet Client, and then Telnet to the RSM's IP Address. Wait for the connect message, then proceed to Step 2.
- Note:** *When communicating with the unit for the first time, you will not be able to contact the unit via Telnet, until you have accessed command mode, via Local PC or SSH Client, and used the Network Parameters Menu (IN) to enable Telnet as described in Section 5.8.*
- c) **Via Modem:** Use your communications program to dial the number for the line connected to the RSM's Phone Line port.
2. **Login / Password Prompt:** A message will be displayed, which prompts you to enter a username (login name) and password. The default username is "super" (all lower case, no quotes), and the default password is also "super".

```

PORT STATUS:
Site ID: (undefined)                                02/07/2007 00:23:39 GMT (GMT+0000)

PORT | NAME | USERNAME | STATUS | MODE | BUFFER COUNT
-----+-----+-----+-----+-----+-----
01 | (undefined) | | Free | Any | 0
02 | (undefined) | | Free | Any | 0
03 | (undefined) | | Free | Pass | 0
04 | (undefined) | | Free | Pass | 0
05 | (undefined) | | Free | Pass | 0
06 | (undefined) | | Free | Pass | 0
07 | (undefined) | | Free | Pass | 0
08 | (undefined) | | Free | Pass | 0
09 | MODEM | | Free | Modem | 0

Enter /H for command menu.
RSM>
  
```

Figure 5.1: The Port Status Screen (Text Interface; RSM-8 Shown)

3. If a valid username and password are entered, the RSM will display the Port Status Screen, shown in Figure 5.1.

Note: *If the Telnet connection is refused, it is most likely due to one of the following reasons:*

- *The IP Security feature has denied the connection.*
- *You are attempting to use an account that permits Supervisor commands to connect to a port that does not permit Supervisor Commands.*

5.1.2. The Web Browser Interface

The Web Browser Interface consists of a series of web forms, which can be used to select configuration parameters and enable/disable RSM operating functions, by clicking on radio buttons and/or entering text into designated fields.

Notes:

- *The Web Browser Interface cannot be used to connect and disconnect ports; the Web Browser Interface is used only for configuration purposes.*
 - *In order to use the Web Browser Interface, Web Access must be enabled via the Text Interface Network Parameters Menu (N), the RSM must be connected to a TCP/IP network, and your PC must be equipped with a JavaScript enabled web browser.*
1. Start your JavaScript enabled Web Browser, key the RSM's IP address (default = 192.168.168.168) into the web browser's address bar, and press **[Enter]**.
 2. **Username / Password Prompt:** A message box will prompt you to enter your username and password. The default username is "super" (all lower case, no quotes), and the default password is also "super".
 3. If a valid username and password are entered, the RSM Home Screen will appear as shown in Figure 5.2.



Figure 5.2: The Home Screen (Web Browser Interface)

5.2. System SetUp Ports

Serial Ports 1 and 2 are reserved as SetUp Ports, and will always permit password protected access to Supervisor commands. Therefore, Ports 1 and 2 *cannot* be configured as Buffer Mode Port or Passive Mode Ports, because these port modes do not permit access to command mode. In addition, the Supervisor Mode *cannot* be disabled at Ports 1 and 2.

5.3. Configuration Menus

Although the Web Browser Interface and Text Interface provide two separate means for selecting parameters, both interfaces allow access to the same set of basic parameters, and parameters selected via one interface will also be applied to the other. To access the configuration menus, proceed as follows:

- **Text Interface:** Refer to the Help Screen (/H) and then enter the appropriate command to access the desired menu. When the configuration menu appears, key in the number for the parameter you wish to define, and follow the instructions in the resulting submenu.
- **Web Browser Interface:** Click the appropriate button on the left hand side of the Home Screen (Figure 5.2) to access the desired configuration menu. To change parameters, click in the desired field and key in the new value or select a value from the pull-down menu. To apply newly selected parameters, click on the "Change Parameters" button at the bottom of the menu or the "Set" button next to the field.

The following sections describe options and parameters that can be accessed via each of the configuration menus. Please note that essentially the same set of parameters and options are available to both the Web Browser Interface and Text Interface.

Note: *Configuration menus are only available when you have logged into command mode using a password and port that permit Supervisor Level commands.*

5.4. Defining System Parameters

The System Parameters menus are used to define the Site ID Message, set the system clock and calendar, and configure the Invalid Access Lockout feature and Callback feature.

```

SYSTEM PARAMETERS:

1. User Directory
2. Site-ID:
3. Real Time Clock:           01/09/2007 00:26:06
4. Invalid Access Lockout:    On
5. Audit Log:                 On - Without Syslog
6. Callback Security:         On - Callback (Without Password Prompt)
7. "/PW" Command:            Off

Enter: #<CR> to change,
      <ESC> exit ...

```

Figure 5.3: The System Parameters Menu (Text Interface)

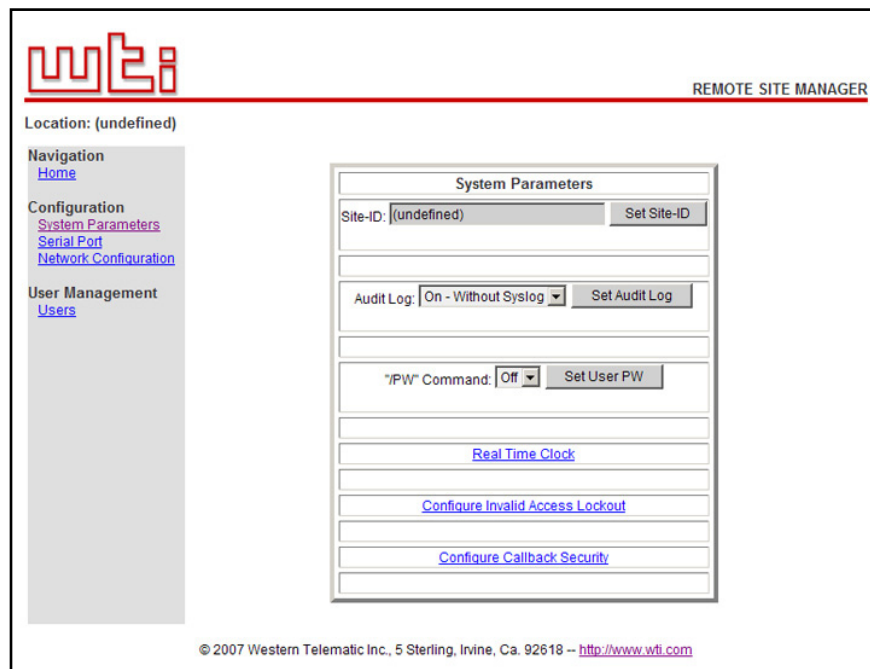

Figure 5.4: The System Configuration Menu (Web Browser Interface)

In the Text Interface, the System Parameters menu is also used to create and manage user accounts and passwords. Note however, that when you are communicating with the unit via the Web Browser Interface, accounts and passwords are managed and created via a separate menu that is accessed by clicking on the "Users" link on the left hand side of the menu.

- **Text Interface:** Type `/F` and press `[Enter]`. The System Parameters Menu will appear as shown in Figure 5.3.
- **Web Browser Interface:** Click the "System Properties" link on the left hand side of the RSM Home Screen. The System Parameters menu will be displayed as shown in Figure 5.4.

The System Parameters Menus are used to define the following:

- **User Directory:** This function is used to create, modify and delete user accounts and passwords. As discussed in Section 5.6, user accounts allow you to set the security level for each password as well as determine which ports a user will be allowed to access.

Note: *The "User Directory" option does not appear in the Web Browser Interface's System Parameters menu, and is instead, accessed via the "Users" link on the left hand side of each configuration menu.*
- **Site ID:** A text field, generally used to note the installation site or name for the RSM unit. (Up to 32 chars.; Default = undefined.)

Notes:

- *The Site ID cannot include double quotes.*
- *The Site ID will be cleared if the RSM is reset to default settings.*
- **Real Time Clock:** This prompt provides access to the Real Time Clock menu, which is used to set the clock and calendar, and to enable and configure the NTP (Network Time Protocol) feature as described in Section 5.4.1.
- **Invalid Access Lockout:** If desired, this feature can be used to automatically disable an RSM serial port after a user specified number of unsuccessful login attempts are made. For more information, please refer to Section 5.4.2.
- **Audit Log:** Enables and configures the Audit Log feature, as described in Section 5.4.3. (Default = On - Without Syslog.)
- **Callback Security:** Enables / configures the Callback Security Function as described in Section 5.4.4. In order for this feature to function, a Callback number must also be defined for each desired user account as described in Section 5.6.
- **"/PW" Command:** Enables/Disables the `/PW` (Change Password) command. When enabled, the `/PW` command can be issued at the text interface by any user account in order to change that account's password. When disabled, accounts that do not permit Supervisor commands will not be able to change passwords. (Default = Off.)

5.4.1. The Real Time Clock and Calendar

The Real Time Clock menu is used to set the RSM's internal clock and calendar. To access the Real Time Clock Menu, proceed as follows:

- **Text Interface:** Type `/F` and press **[Enter]**. The System Parameters menu will appear as shown in Figure 5.3. At the System Parameters menu, type 3 and press **[Enter]** to display the Real Time Clock menu.
- **Web Browser Interface:** Click on the "System Properties" link at the left hand side of the RSM Home Screen to display the System Parameters menu as shown in Figure 5.4. From the System Parameters Menu, click on the "Real Time Clock" link to access the Real Time Clock menu.

The configuration menu for the Real Time Clock offers the following options:

- **Date:** Sets the Month, Date, Year and day of the week for the RSM's real-time clock/calendar.
- **Time:** Sets the Hour, Minute and Second for the RSM's real time clock/calendar. Key in the time using the 24-hour (military) format.
- **Time Zone:** Sets the time zone, relative to Greenwich Mean Time. Note that the Time Zone setting will function differently, depending on whether or not the NTP feature is enabled and properly configured. (Default = GMT (No DST).)
 - ◆ **NTP Enabled:** The Time Zone setting is used to adjust the Greenwich Mean Time value (received from the NTP server) to determine the precise local time for the selected time zone.
 - ◆ **NTP Disabled:** If NTP is disabled, or if the RSM is not able to access the NTP server, then status screens and activity logs will list the selected Time Zone and current Real Time Clock value, but will not apply the correction factor to the displayed Real Time Clock value.
- **NTP Enable:** When enabled, the RSM will contact an NTP server (defined via the NTP IP Address prompts) once a day, and update its clock based on the NTP server time and selected Time Zone. (Default = Off.)

Notes:

- *The RSM will also contact the NTP server and update the time whenever you change NTP parameters.*
- *To command the RSM to immediately contact the NTP server at any time, make certain that the NTP feature is enabled and configured, then type `/F` and press **[Enter]**. When the System Parameters menu appears, press **[Esc]**. The RSM will save parameters and then attempt to contact the server, as specified by currently defined NTP parameters.*
- **Primary NTP Address:** Defines the IP address or domain name (up to 64 characters long) for the primary NTP server. (Default = undefined.)

- **Secondary NTP Address:** Defines the IP address or domain name (up to 64 characters long) for the secondary, fallback NTP Server. (Default = undefined.)
- **NTP Timeout:** The amount of time in seconds, that will elapse between each attempt to contact the NTP server. When the initial attempt is unsuccessful, the RSM will retry the connection four times. If neither the primary nor secondary NTP server responds, the RSM will wait 24 hours before attempting to contact the NTP server again. (Default = 3 Seconds.)

5.4.2. The Invalid Access Lockout Feature

When properly configured and enabled, the Invalid Access Lockout feature will watch all login attempts made at all RSM ports. If a given port exceeds the selected number of invalid attempts, then that port will be automatically disabled for a user-defined length of time. The Invalid Access Lockout feature uses three separate counters to track invalid access attempts:

- **Serial Port Counter:** Counts invalid access attempts at each individual serial port. If the number of invalid attempts at a given port exceeds the user-defined Lockout Attempts value, then that port will be locked.
- **Raw Socket Counter:** Counts invalid attempts to connect to a port via Raw Socket protocol. If the number of invalid attempts at a given port exceeds the user-defined Lockout Attempts value, then Raw Socket connections to that port will be locked.
- **Telnet, SSH and Web Browser Counter:** Counts all invalid attempts to access command mode via Telnet, SSH or Web Browser interface. If the number of cumulative invalid attempts exceeds the user-defined Lockout Attempts value, then the Network Port will be locked.

Note that when an Invalid Access Lockout occurs, you can either wait for the Lockout Duration period to elapse (after which, the RSM will automatically reactivate the port), or you can issue the /UL command (type /UL and press **[Enter]**) via the Text Interface to instantly unlock all RSM serial ports.

Notes:

- *Invalid Access Lockout parameters, defined via the System Parameters menu, will apply to all RSM serial ports.*
- *When a Port is locked, an external modem connected to that port will not answer.*
- *When a given RSM serial port is locked, the other RSM serial ports will remain unlocked, unless the Invalid Access Lockout feature has been triggered at those other ports.*
- *If any one of the RSM's logical network ports is locked, all other network connections to the unit will also be locked.*
- *All invalid access attempts at the RSM Network Port are cumulative (the count for invalid access attempts is determined by the total number of all invalid attempts at all 64 logical network ports.) If a valid login name/password is entered at any of the logical network ports, then the count for all RSM logical network ports will be restarted.*
- *A Port that has been locked by the Invalid Access Lockout feature will still respond to the ping command (providing that the ping command has not been disabled.)*

The Invalid Access menus allow you to select the following:

- **Lockout Enable:** Enables/Disables the Invalid Access Lockout feature. (Default = On.)
- **Lockout Attempts:** The number of invalid attempts required to activate the Invalid Access Lockout feature. (Default = 9.)
- **Lockout Duration:** The length of time ports will remain locked when an Invalid Access Lockout occurs. If the duration is set at "Infinite", then ports will remain locked until the /UL command is issued. (Default = 30 Minutes.)

5.4.3. The Audit Log

This feature allows you to create a record of command activity at all RSM ports. Audit Log records will include the time, date, username, and a brief description of each logged event (e.g., Connect, Login, etc.) The Audit Log is enabled and configured via the System Parameters Menus as described in Section 5.4.

The System Parameters Menu includes three different options for Audit Log configuration; Off (Audit Log disabled), "On with Syslog" and "On without Syslog." When "On with Syslog" is selected, each individual Audit Log record will be sent out to the user-defined Syslog IP Address as a Syslog message at the time that it is generated. The Syslog IP Address is defined via the Network Parameters Menu, as described in Section 5.8.

To read or erase the Audit Log, access command mode (via the Text Interface,) using an account and port that permit Supervisor commands, type `/A s`, press **[Enter]** (where `s` is an optional text string that you wish to search for,) and follow the instructions in the resulting submenu. When the `s` (search string) option is included, the `/A` command will return only those records that match the selected search string.

Notes:

- *The RSM dedicates a fixed amount of internal memory for Audit Log records, and if log records are allowed to accumulate until this memory is filled, memory will eventually "wrap around," and older records will be overwritten by newer records.*
- *The Audit Log cannot be viewed via the Web Browser Interface.*
- *When the `s` option is used to search for all records that contain a specific text string, the Delete function will still delete all Audit Log records; the Delete function is not limited to the records that are currently displayed on screen.*

5.4.4. Callback Security

The Callback function provides an additional layer of security when callers attempt to access command mode via modem. When this function is properly configured, modem users will not be granted immediate access to command mode upon entering a valid password; instead, the unit will disconnect, and dial a user-defined number before allowing access via that number. If desired, users may also be required to re-enter the password *after* the RSM dials back.

In order for Callback Security to function properly, you must first enable and configure the feature via the System Parameters menus as described in this section, and then define a callback number for each desired user account as described in Section 5.6. To configure and enable the Callback function, proceed as follows:

- **Text Interface:** Type `/F` and press **[Enter]** to access the System Parameters menu, then type `6` and press **[Enter]** to display the Callback Security Menu.
- **Web Browser Interface:** Click the "System Properties" link on the left hand side of the screen to access the System Configuration menu, then click the "Configure Callback Security" link to display the Callback Security Menu.

In both the Text Interface and Web Browser Interface, the Callback Security Menu offers the following options:

- **Callback Enable:** This prompt offers five different configuration options for the Callback Security feature: (Default = On - Callback (Without Password Prompt.)
 - ◆ **Off:** All Callback Security is disabled.
 - ◆ **On - Callback (Without Password Prompt):** Callbacks will be performed for user accounts that include a Callback Number, and the login prompt will *not* be displayed when the user's modem answers. If the account *does not* include a Callback Number, that user will be granted immediate access and a Callback will *not* be performed.
 - ◆ **On - Callback (With Password Prompt):** Callbacks will be performed for user accounts that include a Callback Number, and the login prompt *will* be displayed when the user's modem answers (accounts that include a Callback Number will be required to re-enter their username/password when their modem answers.) If the account *does not* include a Callback Number, then that user will be granted immediate access and a Callback will *not* be performed.

- ◆ **On - Callback ONLY (Without Password Prompt):** Callbacks will be performed for user accounts that include a Callback Number, and the username/password prompt will *not* be displayed when the user's modem answers. Accounts that *do not* include a Callback Number will *not* be able to access command mode via an RSM modem port.
- ◆ **On - Callback ONLY (With Password Prompt):** Callbacks will be performed for user accounts that include a Callback Number, and the username/password prompt *will* be displayed when the user's modem answers (users will be required to re-enter their username/password when their modem answers.) Accounts that *do not* include a Callback Number will *not* be able to access command mode via an RSM modem port.
- **Callback Attempts:** The number of times that the RSM will attempt to call the Callback number. (Default = 3 attempts.)
- **Callback Delay:** The amount of time that the RSM will wait between Callback attempts. (Default = 30 seconds.)

Notes:

- *After configuring and enabling Callback Security, you must then define a callback phone number for each desired user account (as described in Section 5.6) in order for this feature to function properly.*
- *When using the "On - Callback (With Password Prompt)" option, it is important to always define a callback number for each user account. Otherwise accounts that do not include a callback number will be allowed to immediately access command mode, and the callback function will not be performed.*

5.5. User Accounts

Prior to accessing command mode or establishing a Telnet Direct Connection, you will be prompted to enter a username (login) and password. The username and password entered at login determine which port(s) you will be allowed to connect and what type of commands you will be allowed to execute. Each username / password combination is defined within a "user account."

The RSM allows up to 128 user accounts; each account includes a username, password, security level, port access rights, and an optional callback number.

5.5.1. Supervisor Access

In order to protect access to important command functions, the RSM allows you to enable or disable Supervisor commands for specific accounts. Accounts that have Supervisor Access enabled, will be allowed access to all configuration menus, review all status screens, and connect to any RSM RS232 port.

When Supervisor Access is disabled, the account will be blocked from changing configuration parameters, access to status screens will be restricted, and the user will only be able to connect to ports specifically allowed by that account.

Note that in the default state, the RSM includes one predefined user account that provides access to Supervisor commands and allows connections with any RSM RS232 port. The default username for this account is "super" (lowercase, no quotation marks), and the password for the account is also "super".

Notes:

- *In order to ensure security, it is recommended that when initially setting up the unit, you should either change the username and password for the default "super" user account, or preferably, a new user account with Supervisor access should be created, and the "super" account should then be deleted.*
- *If the RSM is reset to default parameters, all user accounts will be cleared, and the default "super" account will be restored.*
- *If Supervisor commands are disabled at a given port, then accounts that permit Supervisor commands will not be able to access command mode via that port.*

In most cases, a password with Supervisor Access can be entered at any port, allowing the user to invoke Supervisor level commands. However, if you wish to completely deny a specific port's access to Supervisor commands (even *with* a password that normally permits them), the Port Parameters menus can disable Supervisor commands at ports 3 and above, and the Network Port. The Supervisor Mode *cannot* be disabled at Ports 1 and 2 (the System Setup Ports.) For a summary of commands and status screens available to Supervisors and non-Supervisors, please refer to Section 13.

5.5.2. Port Access

Each account can be granted access to a different selection of ports. Accounts *with* Supervisor access are always allowed to establish connections with all ports, but accounts *without* Supervisor Access can be restricted to a specific port or group of ports. Note also, that several accounts can be allowed access to the same port.

5.6. Managing User Accounts

The User Directory function is employed to create new accounts, display parameters for existing accounts, modify accounts and delete accounts. Up to 128 different user accounts can be created. The "User Directory" function is only available when you have logged into command mode using an account and port that permit Supervisor commands.

- **Text Interface:** Type **/F** and press **[Enter]** to access the System Parameters Menu. From the System Parameters Menu, type **1** and press **[Enter]** to access the User Directory.
- **Web Interface:** Click the "Users" link on the left hand side of the screen to access the User Directory management menus.

In both the Text Interface and the Web Browser Interface, the user configuration menu offers the following functions:

- **View User Directory:** Displays currently defined parameters for any RSM user account as described in Section 5.6.1.
- **Add Username:** Creates new user accounts, and allows you to assign a username, password, command level, port access rights, and callback number, as described in Section 5.6.2.
- **Modify User Directory:** This option is used to edit or change account information, as described in Section 5.6.3.
- **Delete User:** Clears user accounts, as described in Section 5.6.4.

5.6.1. Viewing User Accounts

The "View User Directory" option allows you to view details about each account, including the ports the account is allowed to access and whether or not the account is allowed to invoke Supervisor commands. The View User option will not display actual passwords, and instead, the password field will read either "defined" or "undefined." Note that the View User Accounts function is only available to users who have accessed command mode using a password that permits Supervisor Level commands. To view account details, proceed as follows:

- **Text Interface:** From the User Directory menu, type **1** and press **[Enter]**. The RSM will display a screen which lists all defined user accounts. Key in the name of the desired account and then press **[Enter]**.
- **Web Browser Interface:** From the User menu, click the "View/Modify User" link. The RSM will display a menu that allows you to select the desired user and directory function. Select the "View User" button, and then click on the down arrow, scroll to the desired username, select the username, and then click "Choose User."

```

ADD USERNAME TO DIRECTORY:

1. Username:
2. Password:          (undefined)
3. Supervisor Access: Off
4. Port Access:

  PORT#  PORT NAME      ACCESS  PORT#  PORT NAME      ACCESS
  -----
  1      (undefined)    Off     6      (undefined)    Off
  2      (undefined)    Off     7      (undefined)    Off
  3      (undefined)    Off     8      (undefined)    Off
  4      (undefined)    Off     9      MODEM           Off
  5      (undefined)    Off

5. Callback Phone #:

Enter: #<CR> to select,
      <ESC> to return to previous menu ...
    
```

Figure 5.5: The Add User Menu (Text Interface; RSM-8 Shown)

Figure 5.6: The Add User Menu (Web Browser Interface; RSM-8 Shown)

5.6.2. Adding User Accounts

The "Add Username" option allows you to create new accounts and assign usernames, passwords, command level, port access rights, and Callback Numbers to each account. Note that the Add User function is only available to users who have accessed command mode using a password that permits Supervisor Level commands.

Notes:

- On RSM-8 units, the internal modem port is Port 9.
- On RSM-16 units, the internal modem port is Port 17.
- On RSM-32 units, the internal modem port is Port 33.

To create new user accounts, proceed as follows:

- **Text Interface:** From the User Directory menu, type 2 and press **[Enter]**. The Add Username menu (Figure 5.5) will be displayed.
- **Web Browser Interface:** From the Edit User menu, click the "Add User" link. The RSM will display the Add User menu (Figure 5.6.)

The Add Username Menu can be used to define the following parameters for each new account:

- **Username:** Up to 32 characters long, and cannot include non-printable characters. Duplicate usernames are not allowed. (Default = undefined.)
- **Password:** Five to sixteen characters long, and cannot include non-printable characters. Note that passwords are case sensitive. (Default = undefined.)
- **Supervisor Access:** Determines whether the account is allowed to invoke Supervisor commands. (Default = Off.)
- **Port Access:** Determines which port(s) this account will be allowed to create connections with. (Default = All Ports Off.)
- **Callback Number:** Assigns a number that will be called when this user attempts to access command mode via modem at an RSM port, where the Callback Security Function has been enabled as described in Section 5.4.4. (Default = undefined.)

Notes:

- *If the Callback Number is not defined, then Callbacks will not be performed for this user.*
- *If the Callback Number is not defined for a given user, and the Callback Security feature is configured to use either of the "On - Callback" options, then this user will be granted immediate access to command mode via modem.*
- *If the Callback Number is not defined for a given user, and the Callback Security feature is configured to use the "On - Callback ONLY" option, then this user will not be able to access command mode via a Modem Mode port.*

5.6.3. Modifying User Accounts

The "Edit User Directory" function allows you to edit existing user accounts in order to modify passwords and usernames, or change port access or Supervisor Command capability. Note that the Edit/Modify User function is only available to users who have accessed command mode using a password that permits Supervisor Level commands. To modify a user account, proceed as follows:

- **Text Interface:** From the User Directory menu, type 3 and press **[Enter]**. The RSM will display a screen which lists all user accounts. Key in the name of the account you wish to modify, and press **[Enter]**.
- **Web Browser Interface:** From the User Configuration menu, click the "View/Modify User" link. The RSM will display a menu that allows you to select the user. Select the "Modify User" button, then click the down arrow, scroll to the name of the desired account, select the username, and then click "Choose User" to display the "Modify User" menu.

5.6.4. Deleting User Accounts

This function is used to delete individual user accounts. Note that the Delete User function is only available to users who have accessed command mode using a password that permits Supervisor Level commands. To delete an existing user account, proceed as follows:

- **Text Interface:** From the Users Directory menu, type 4 and press **[Enter]**. The RSM will display a screen which lists all currently defined accounts. Key in the name of the account you wish to delete and press **[Enter]**. The RSM will delete the specified account without further prompting.
- **Web Browser Interface:** From the User Configuration menu, click the "View/Modify Users" link. The RSM will display a menu that lists all currently defined accounts. Select the "Delete User" box, then click the down arrow, scroll to the account you wish to delete, select the account, and then click "Choose User." The RSM will display a screen that lists details for the specified account; click "Delete User" to confirm deletion.

Notes:

- *Deleted accounts cannot be automatically restored.*
- *The RSM allows you to delete the default "super" account, which is included to permit initial access to command mode. Before deleting the "super" account, make certain to create another account that permits Supervisor Access. If you do not retain at least one account with Supervisor Access, you will not be able to invoke supervisor level commands.*

5.7. RS232 Port Configuration

When responding to prompts, invoking commands, and selecting items from port configuration menus, note the following:

- Configuration menus are only available to accounts and ports that permit Supervisor commands.
- If you are configuring the RSM via modem, modem parameters will not be changed until after you exit command mode and disconnect from the RSM.

5.7.1. RS232 Port Modes

The RSM offers four different RS232 port operation modes:

- **Any-to-Any Mode:** Allows communication between connected ports and permits access to command mode. Any-to-Any Mode Ports can be connected to other Any-to-Any, Passive, Buffer or Modem Mode Ports by invoking the /C command. The Any-to-Any Mode is available to all ports and is the default Port Mode for Ports 1 and 2.
- **Passive Mode:** Allows communication between connected ports, but does *not* allow access to command mode. Passive Mode Ports can be connected by accessing command mode from a free Any-to-Any or Modem Mode port and invoking the /C command. Passive Mode is not available at Ports 1 and 2 or the Network Port, and is the default mode at Ports 3 and above.
- **Buffer Mode:** Allows storage of data received from connected devices. Collected data can be retrieved by accessing command mode from a free Any-to-Any or Modem Mode Port, and issuing the Read Buffer (/R) Command. Furthermore, Buffer Mode ports can also be configured to support the Syslog and SNMP Trap features, discussed in Sections 9 and 10. The Buffer Mode is not available at Ports 1 and 2 or the Network Port.
- **Modem Mode:** Allows communication between connected ports, permits access to command mode and simplifies connection to an external modem. Modem Mode ports can perform all functions normally available in Any-to-Any Mode, but Modem Mode also allows definition of a Hang-Up String, Reset String, and Initialization String. The Modem Mode is not available at the Network Port and is the default mode for the internal modem port (The Modem Port is Port 9 on RSM-8 units, Port 17 on RSM-16 and RSM-16DC units, and Port 33 on RSM-32 and RSM-32DC units.)

For more information on Port Modes, please refer to Section 7.

```

PORT PARAMETERS #03:

COMMUNICATION SETTING
1. Baud Rate:          9600
2. Bits/Parity:       8-None
3. Stop Bits:         1
4. Handshake:         RTS/CTS

PORT MODE PARAMETERS
21. Port Name:
22. Port Mode:        Passive
23. DTR Output:       Pulse
24. Buffer Params:    ---
25. Modem Params:    ---

GENERAL PARAMETERS
11. Supervisor Mode:  Permit
12. Logoff Char:     ^X
13. Sequence Disc:   One Char
14. Inact Timeout:   5 Min
15. Command Echo:    On
16. Accept Break:    On

NETWORK SERVICES
31. Direct Connect:  Off
    Telnet Port:     ---
    SSH Port:        ---
    Raw Port:        ---
32. Syslog:          ---
33. SNMP Trap Lv:   ---

Enter: "<" previous port,
       ">" next port,
       <ESC> exit ...
    
```

Figure 5.7: Port Configuration Menu (Text Interface)

The screenshot shows the WTI Remote Site Manager web browser interface. At the top left is the WTI logo, and at the top right is the text "REMOTE SITE MANAGER". Below the logo is the text "Location: (undefined)". On the left side, there is a navigation sidebar with sections for "Navigation" (Home), "Configuration" (System Parameters, Serial Port, Network Configuration), and "User Management" (Users). The main content area is titled "Serial Port 3 Configuration" and contains the following settings:

- Port Name: [text input]
- Baud Rate: 9600 [dropdown]
- Bits/Parity: 8-None [dropdown]
- Stop Bits: 1 [dropdown]
- Handshake Mode: RTS/CTS [dropdown]
- Port Mode: Passive [dropdown]
- Supervisor Mode: Permit [dropdown]
- Logoff Character: ^X [text input]
- Sequence Disconnect: One Character Only [dropdown]
- Inactivity Timeout: Off [dropdown]
- Command Echo: On [dropdown]
- Accept Break: On [dropdown]
- Direct Connect: Off [dropdown]
- Modem Reset String: ATZ [text input]
- Modem Init String: AT&C1&D2S0=1&B [text input]
- Modem Hang-Up String: [text input]
- Periodic Reset Interval: 15 [text input]
- DTR Output: Pulse upon Disconnect then go High [dropdown]
- Buffer DateTime: On [dropdown]
- Buffer Connect: Off [dropdown]
- Syslog: Off [dropdown]
- Facility: Local_0 [dropdown]
- Level: Emergency [dropdown]
- SNMP Trap Level: 0 [text input]

At the bottom of the configuration area is a button labeled "Change Serial Parameters". The footer of the page contains the copyright notice: "© 2007 Western Telematic Inc., 5 Sterling, Irvine, Ca. 92618 -- http://www.wti.com".

Figure 5.8: Port Configuration Menu (Web Browser Interface)

5.7.2. RS232 Port Configuration Menus

The Port Configuration Menus are used to select communications parameters and enable/disable options for each RS232 port.

- **Text Interface:** Type `/P n` and then press **[Enter]** (Where `n` is the number or name of the desired RS232 Serial Port.) The Port Parameters menu will be displayed as shown in Figure 5.7.
- **Web Browser Interface:** Click the "Serial Port" link on the left hand side of the screen to display the Port Selector Menu. From the Port Selector Menu, use the drop down menu to select the desired port and then click "Choose Port." The Port Parameters menu will be displayed as shown in Figure 5.8.

The Port Configuration menus allow the following parameters to be defined. Note that all of these parameters are available via both the Text Interface and Web Browser Interface, and that parameters selected via one interface are also applied to the other.

Communication Settings:

- **Port Name:** (Up to 16 characters, Default = undefined).

Notes:

- *Port Names cannot include non-printable characters, the forward slash character (/), backslash characters (\), double quotes ("), asterisks (*), or blank spaces.*
- *Port Names must begin with an alphabetic character; Port Names cannot begin with a number or punctuation character.*
- *A Port cannot be named "N1" through "N66", these names are reserved for the logical Network Ports.*
- *Port names are case-sensitive.*
- **Baud Rate:** Any standard rate from 300 bps to 115.2K bps. (Default = 9600 bps)
- **Bits/Parity:** (Default = 8-None).
- **Stop Bits:** (Default = 1).
- **Handshake Mode:** XON/XOFF, RTS/CTS (hardware), Both, or None. (Default = RTS/CTS).

General Parameters:

- **Supervisor Mode:** Permits/denies port access to supervisor commands. When enabled (Permit), the port will be allowed to invoke supervisor commands, providing the unit is accessed using an account that permits them. If disabled (Deny), the port may *not* invoke Supervisor commands. (Default = Permit).

Note: *If the Supervisor Mode is set to "Deny", then user accounts that permit Supervisor commands will not be allowed to access command mode via this port.*

- **Logoff Character:** The Logoff Character determines the command(s) or character(s) that must be issued at this port in order to disconnect from a second port. Note that the Logoff Character does not apply to Direct Connections. (Default = ^x)

Note: *When redefining the Logoff Character, select a character that does not normally occur in your data. This prevents the RSM from accidentally disconnecting ports in the middle of a transfer when a character that accidentally matches the Logoff Character is passed.*

- **Sequence Disconnect:** Enables/Disables and configures the Resident Disconnect command. This offers the option to disable the Sequence Disconnect, select a one character format or a three character format. (Default = One Character.)

Notes:

- *When a Resident Connection is initiated, the RSM will list the connected ports, and the command required in order to terminate the connection.*
- *The One Character Disconnect is intended for situations where the other port should **not** receive the disconnect command. When the Three Character format is selected, the disconnect sequence **will** be passed to the other port.*
- *When the Three Character format is selected, the Resident Disconnect Sequence will use the "[Enter]LLL[Enter]", format, where L is the selected Logoff Character.*
- **Inactivity Timeout:** Enables and selects the Timeout Period for this port. If enabled, the port will disconnect when no additional data activity is detected for the duration of the timeout period. When the port is set for Any-to-Any Mode, Passive Mode, or Buffer Mode, the default setting is "Off." When set for Modem Mode, the default setting is 5 minutes.

Notes:

- *The Inactivity Timeout value is also applied to Direct Connections.*
- *The Inactivity Timeout is also applied to non-connected ports that are left in command mode. If the timeout is enabled, and no additional activity is detected, an unconnected port will exit command mode when the Timeout Disconnect expires.*
- **Command Echo:** Enables or Disables command echo at this port. (Default = On.)
- **Accept Break:** Determines whether the port will accept breaks received from the attached device, and pass them along to a connected port. When enabled, breaks received at this port will be passed to any port this port is connected to. When disabled, breaks will be refused at this port. (Default = On.)

Port Mode Parameters:

- **Port Mode:** The operation mode for this port. Ports 1 and 2 *cannot* be configured as Passive or Buffer Mode ports, and the internal modem port is always configured for Modem Mode. (Port 1 and 2, Default = Any-to-Any Mode; Serial Ports 3 and above, Default = Passive Mode; Internal Modem Port, Default = Modem Mode.)

Depending on the Port Mode selected, the RSM will also display the additional prompts listed in this section. In the Text Interface, these parameters are accessible via a submenu, which will only be active when the appropriate port mode is selected, and in the Web Browser Interface, fields will be "grayed out" unless the corresponding port mode is selected.

- **Any-to-Any Mode / Passive Mode:** Allows the following Mode-specific parameter to be defined:
 - ◆ **DTR Output:** Determines how DTR will react when the port disconnects. DTR can be held low, held high, or pulsed for 0.5 seconds and then held high. (Default = Pulse.)
 - **Modem Mode:** Allows the following mode-specific parameters to be defined:
 - ◆ **Reset String:** Redefines the modem reset string. The Reset String can be sent prior to the Initialization string. (Default = **ATZ**.)
 - ◆ **Initialization String:** Defines a command string that can be sent to initialize a modem to settings required by your application. (Default = **AT&C1&D2S0=1&B1&H1&R2**)
 - ◆ **Hang-Up String:** Although the RSM will pulse the DTR line to hang-up an attached modem, the Hang-Up string is often useful for controlling modems that do not use the DTR line. (Default = undefined.)
 - ◆ **Periodic Reset Value:** Determines how often the Reset String will be sent to the modem at this port.
- Note:** *When communicating with the RSM via modem, these parameters will not be changed until after you exit command mode and disconnect.*
- **Buffer Mode:** Allows the following mode-specific parameters to be defined:
 - ◆ **Buffer DateTime:** Enables/Disables the Time/Date stamp for buffered data. When enabled, the RSM will add a time/date stamp whenever five seconds elapse between data items received. (Default = On.)
 - ◆ **Buffer Connect:** When enabled, the RSM will continue to Buffer captured data while you are connected to the Buffer Mode port. (Default = Off.)

Network Services:

- **Direct Connect:** Direct Connect allows users to access the RSM and automatically create a connection between the Network Port and a specific RS232 port by including the appropriate Telnet port number in the connect command (e.g. Port 5 = 2105). For more information, please refer to Section 8.3. As described below, the Direct Connect feature offers three options. (Default = Off.)
 - ◆ **Off:** Telnet users will *not* be able to employ the Direct Connect feature to connect to this port.
 - ◆ **On - No Password:** Telnet users *will* be able to employ the Direct Connect feature to connect to this port without entering a password.
 - ◆ **On - Password:** Telnet and SSH users will be able to use Direct Connect to connect to this port, but will be required to enter a password before the connection is established.

Note: *If "On - Password" is selected, and Supervisor commands are disabled at the Network Port, then only accounts that do not permit Supervisor commands will be allowed to establish a direct connection via the Network Port. If Supervisor commands are disabled at a given port, then that port will not allow access by accounts that permit Supervisor commands.*

When the Port Parameters menu is accessed via the Text Interface, the menu also lists both Direct Connect port numbers for this port (port numbers are not listed in the Web Browser Interface.)

- ◆ **Telnet Port:** The Telnet port number employed to create a Direct Connection to this port using standard Telnet protocol.
- ◆ **SSH Port:** When Direct Connect (Item 13) is set at "On - Password", this line will display the Telnet port number used to create a Direct Connection to this port using SSH protocol. For more information, please refer to Section 8.3.
- ◆ **Raw Port:** The Telnet port number that is used to create a Direct Connection to this port using Raw Socket protocol.
- **Syslog:** The Syslog feature is used to create records of each buffer event. As event records are created, they are sent to a Syslog Daemon, at an IP address defined via the Network Parameters menu. For more information, please refer to Section 9. The Syslog feature offers three possible settings. (Default = Off)
 - ◆ **Off:** Syslog disabled. (Default)
 - ◆ **On - Not Connected:** Messages will only be generated when a user is *not* connected to a buffer port (either by /C or direct connect.) This prevents information captured from the attached device from being put into Syslog messages while a user is connected to a buffer port.
 - ◆ **On - Always:** *All* captured information will be sent out via Syslog message; whether a user is connected or not.

Notes:

- *Syslog is only available at Buffer Mode Ports.*
- *This option is not available to RS232 Ports 1 and 2, because Ports 1 and 2 cannot be configured as Buffer Mode Ports.*

The Port Parameters menu also offers two additional items used to set the priority of Syslog messages generated by this port:

- ◆ **Facility:** The facility under which this port will log messages. (Default = Local_0.)
- ◆ **Level:** The severity (or priority) of messages generated by this port. (Default = Emergency.)
- **SNMP Trap Level:** Enables/disables the SNMP Trap function and sets the byte level that will generate traps at this port. If set to "0" (zero), then SNMP Traps are disabled at this port.

If this value is set between 1 and 32,767, then the SNMP Trap function is enabled, and traps will be sent to the SNMP Managers whenever the buffer for this port reaches the specified level. For more information, please refer to Section 10. (Default = Off.)

Note:

- *The SNMP Trap feature only applies to Buffer Mode Ports.*
- *This option is not available to RS232 Ports 1 or 2. This is because Ports 1 and 2 are reserved as SetUp Ports, and cannot be configured as Buffer Mode Ports.*

5.7.3. Configuring the Internal Modem

The RSM's internal modem can be configured via the Text Interface or Web Browser Interface. The configuration menu for the internal modem is identical to the configuration menus for the RS232 Serial Ports, except that the Port Mode for the Modem Port is always set at "Modem Mode" and the Any-to-Any Mode, Buffer Mode and Passive Mode are not available. To access the Modem Port configuration menu, proceed as follows:

- **Text Interface:** Use the /P command to access the Modem Port Configuration Menu:
 - ◆ **RSM-8 Units:** Type /P 9 and press [Enter].
 - ◆ **RSM-16 and RSM-16DC Units:** Type /P 17 and press [Enter].
 - ◆ **RSM-32 and RSM-32DC Units:** Type /P 33 and press [Enter].
- **Web Browser Interface:** Click on the Serial Port link on the left hand side of the screen to display the Port Selector Menu. Use the Port Selector Menu, to select the Modem Port as follows:
 - ◆ **RSM-8 Units:** Click on the down arrow to display the drop down menu, highlight port 9 and then click on the "Select Port" button.
 - ◆ **RSM-16 and RSM-16DC Units:** Click on the down arrow to display the drop down menu, highlight port 17 and then click on the "Select Port" button.
 - ◆ **RSM-32 ad RSM-32DC Units:** Click on the down arrow to display the drop down menu, highlight port 33 and then click on the "Select Port" button.

For a description of the various parameters that can be configured via the Modem Port Configuration Menu, please refer to Section 5.7.2.

5.8. Network Configuration

The Network Parameters Menus are used to select parameters and options for the Network Port and also allow you to implement IP Security features, which can restrict access based on the user's IP Address.

Although the Web Browser Interface and Text Interface allow definition of essentially the same parameters, parameters are arranged differently in the two interfaces. In the Text Interface, most network parameters are defined via one menu. But in the Web Browser Interface, network parameters are divided between eight separate submenus as described in this section.

```

NETWORK PARAMETERS:

COMMUNICATION SETTING
1. IP Address:      192.168.168.168
2. Subnet Mask:    255.255.255.0
3. Gateway Addr:  (undefined)
4. DHCP:          Off
5. IP Security:    Off
6. Static Route:  Off
7. DNS Servers:   (undefined)

SERVERS AND CLIENTS
21. Telnet Access: On
22. SSH Access:   On
23. Web Access:   On
24. SYSLOG Addr:  (undefined)
25. SNMP Access:  Off
26. SNMP Trap:    Off
27. LDAP:         Off
28. TACACS:       Off
29. RADIUS:       Off
30. PING Access:  On
31. Raw Socket Access: Off

GENERAL PARAMETERS
11. Supervisor Mode: Permit
12. Logoff Char:     ^X
13. Sequence Disc:  One Char
14. Inact Timeout:  5 Min
15. Command Echo:   On
16. Accept Break:   On

Enter: #<CR> to change,
      <ESC> exit ...

```

Figure 5.9: Network Parameters Menu (Supervisor Mode Only)

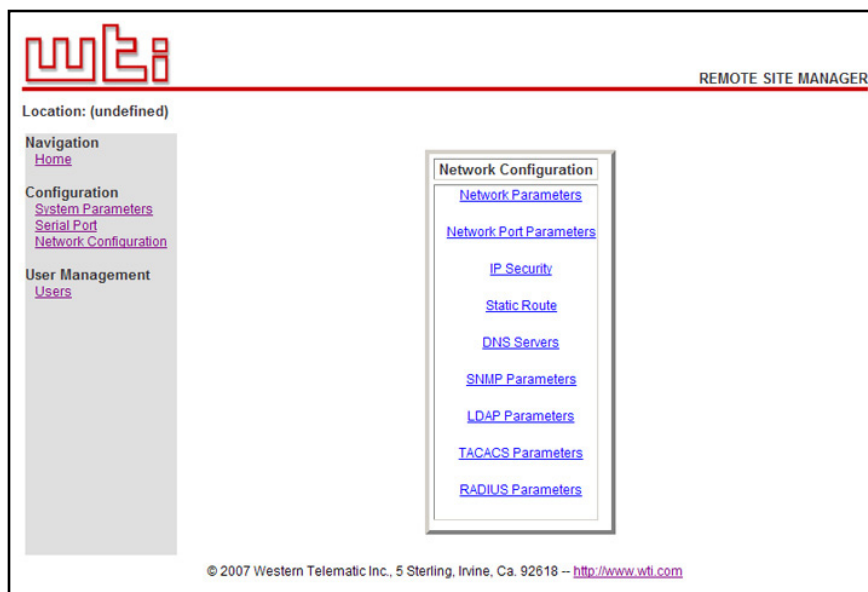

Figure 5.10: Network Configuration Menu (Web Browser Interface)

To access the Network Parameters Menus, proceed as follows:

- **Text Interface:** Type `/N` and press **[Enter]**. The Network Parameters Menu shown in Figure 5.9 will be displayed.
- **Web Browser Interface:** Click on the "Network Configuration" link on the left hand side of the screen. The RSM will display the Network Configuration menu shown in Figure 5.10, which allows you to access the various submenus used to configure the network port.

Notes:

- *Settings for network parameters depend on the configuration of your network. Please contact your network administrator for appropriate settings.*
- *The Network Parameters Menu selects parameters for all 16 logical Network Ports.*
- *When a new IP Address is selected, or the status of the DHCP feature is changed, the unit will disconnect and reconfigure itself with the new values when you exit the Network Parameters Menu. When configuring the unit via Web or Telnet, make certain your DHCP server is set up to assign a known, fixed IP address in order to simplify reconnection to the unit after the new address has been assigned.*
- *The Network Parameters menu is only available when you have logged into command mode using an account and port that permit Supervisor commands.*

The Network Parameters menu allows you to define the parameters that are discussed in the following sections. Note that although the descriptions of network parameters are arranged according to the Web Browser Interface, in the Text Interface, all parameters (except IP Security configuration) are included in one menu.

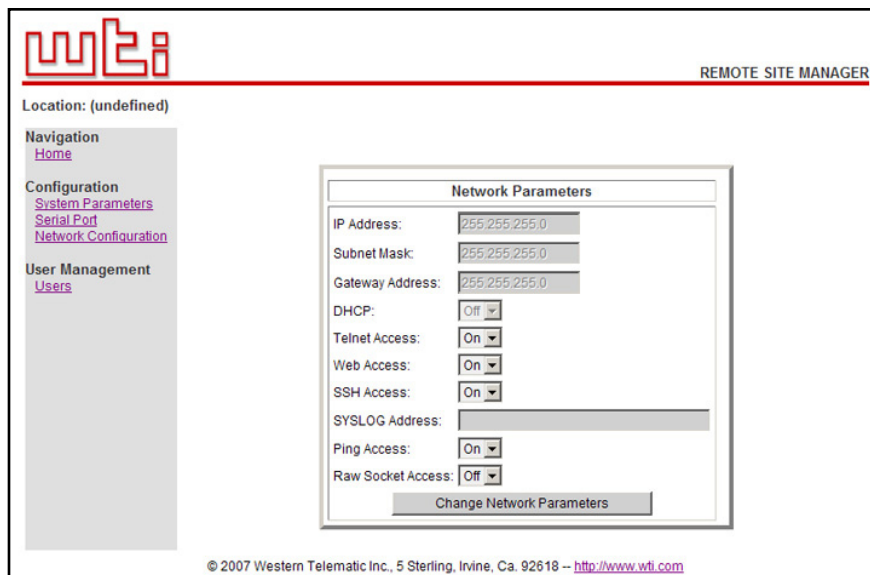

Figure 5.11: Network Parameters Menu (Web Browser Interface)

5.8.1. Network Parameters

In the Text Interface, these parameters are accessed via the Network Configuration menu (Figure 5.9.) In the Web Browser Interface, these parameters can be found by first clicking the "Network Configuration" link, and then Clicking the "Network Parameters" link to display the Network Parameters menu (Figure 5.11.)

- **IP Address:** (Default = 192.168.168.168.)
- **Subnet Mask:** (Default = 255.255.255.0.)
- **Gateway Address:** (Default = undefined.)
- **DHCP:** Enables/Disables Dynamic Host Configuration Protocol. When this option is "On", the RSM will perform a DHCP request. Note that the MAC address for the RSM is listed on the Network Status Screen. (Default = Off.)

Note: Before configuring this feature via Telnet or Web, make certain your DHCP server is set up to assign a known, fixed IP address. You will need this new IP address in order to reestablish a network connection with the RSM unit.
- **Telnet Access:** Enables/disables Telnet access. When Telnet Access is "Off," users will not be allowed to establish a Telnet connection to the unit. (Default = On.)
- **Web Access:** Enables/disables the Web Browser Interface. When disabled, users will not be allowed to contact the unit via the Web Browser Interface. (Default = Off.)
- **SSH Access:** Enables/disables SSH communication. (Default = On.)
- **SYSLOG Address:** The IP Address or domain name (up to 64 characters) for the Syslog Daemon that will receive log records generated by the RSM. For more information, please refer to Section 9. (Default = 0.0.0.0.)
- **Ping Access:** Enables/Disables response to the ping command. When Disabled, the RSM will not respond to Ping commands. (Default = On.)
- **Raw Socket Access:** Enables/Disables Raw Socket Protocol access to the Network Port via Direct Connect. (Default = Off.)

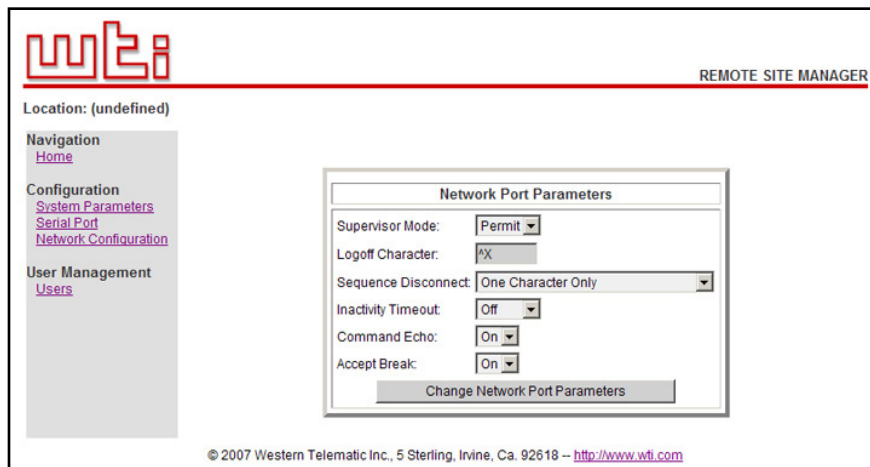

Figure 5.12: Network Port Parameters Menu (Web Browser Interface)

5.8.2. Network Port Parameters

In the Text Interface, these parameters are found in the main Network Configuration menu (Figure 5.9.) In the Web Browser Interface, these parameters are found by first clicking the "Network Configuration" link, and then clicking the "Network Port Parameters" link to display the Network Port Configuration Menu (Figure 5.12.)

- **Supervisor Mode:** Permits/denies access to Supervisor commands. If disabled, the Network port is *not* allowed to invoke Supervisor commands. (Default = Permit.)

Note: *When Supervisor Mode for the Network Port is set to "Deny," accounts that permit Supervisor commands will not be allowed to access command mode via network.*

- **Logoff Character:** Defines the Logoff Character for this port. This determines which command(s) must be issued at this port in order to disconnect from a second port. The Logoff Character does not apply to Telnet Direct Connections. (Default = ^x ([Ctrl] plus [X]).)
- **Sequence Disconnect:** Enables/Disables and configures the Resident Disconnect command. Offers the option to either disable the Sequence Disconnect, or select a one character, or three character command format. (Default = One Character).

Notes:

- *The One Character Disconnect is intended for situations where the destination port should **not** receive the disconnect command. When the Three Character format is selected, the disconnect sequence **will** pass through to the destination port prior to breaking the connection.*
- *When Three Character format is selected, the Resident Disconnect uses the format "[Enter]LLL[Enter]", where L is the selected Logoff Character.*

- **Inactivity Timeout:** Enables and selects the Inactivity Timeout period for the Network Port. If enabled, and the port does not receive or transmit data for the specified time period, the port will disconnect. (Default = 5 Minutes).

Note: *The Inactivity Timeout value is also applied to Direct Connections.*

- **Command Echo:** Enables or Disables the command echo for the Network Port. (Default = On).
- **Accept Break:** Determines whether the port will accept breaks received from the attached device, and pass them along to a connected port. When enabled, breaks received at this port will be passed to any port this port is connected to, and sent to the device connected to the other port. When disabled, breaks will be refused at this port. (Default = On.)

```

IP SECURITY:

CLIENT LIST FOR "hosts.allow" FILE:
1.
2.
3.
4.
5.
6.
7.
8.

CLIENT LIST FOR "hosts.deny" FILE:
9.
10.
11.
12.
13.
14.
15.
16.

Enter: #<CR> to select menu,
      <ESC> for previous menu ...
    
```

Figure 5.13: IP Security Menu (Text Interface)

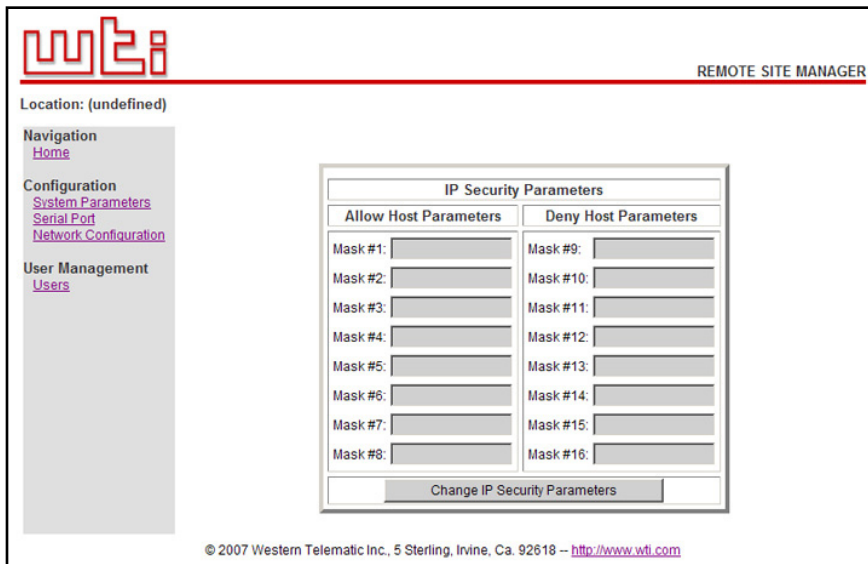

Figure 5.14: IP Security Menu (Web Browser Interface)

5.8.3. IP Security

The RSM can restrict unauthorized IP addresses from establishing an inbound Telnet connection to the unit. This allows the user to grant Telnet access to only a specific group of IP addresses, or block a particular IP address. In the default state, the RSM accepts incoming IP connections from all hosts.

In the Text Interface, IP Security parameters are defined via item 5 in the Network Configuration menu (Figure 5.9.) In the Web Browser Interface, these parameters are found by clicking the "Network Configuration" link, and then Clicking the "IP Security" link. In the default state, IP Security is disabled.

The IP Security Function employs a TCP Wrapper program which allows the use of standard, Linux operators, wild cards and net/mask pairs to create a host based access control list.

As shown in Figures 5.13 and 5.14, the IP Security configuration menus include "hosts.allow" and "hosts.deny" client lists. Basically, when setting up IP Security, you must enter IP addresses for hosts you wish to allow in the Allow list, and addresses for hosts you wish to deny in the Deny list. Since Linux operators, wild cards and net/mask pairs are allowed, these lists can indicate specific addresses, or a range of addresses to be allowed or denied.

When the IP Security feature is properly enabled, and a client attempts to connect, the RSM will perform the following checks:

1. If the client's IP address is found in the "hosts.allow" list, the client will be granted immediate access. Once an IP address is found in the Allow list, the RSM will not check the Deny list, and will assume you wish to allow that address to connect.
2. If the client's IP address is not found in the Allow list, the RSM will then proceed to check the Deny list.
3. If the client's IP Address *is* found in the Deny list, the client *will not* be allowed to connect.
4. If the client's IP Address *is not* found in the Deny list, the client *will* be allowed to connect, even if the address was not found in the Allow list.

Notes:

- *If the RSM finds an IP Address in the Allow list, it will not check the Deny list, and will allow the client to connect.*
- *If both the Allow and Deny lists are left blank, then the IP Security feature will be disabled, and all IP Addresses will be allowed to connect (providing that the proper password and/or SSH key is supplied.)*
- *When the Allow and Deny lists are defined, the user is only allowed to specify the Client List; the Daemon List and Shell Command cannot be defined.*

5.8.3.1. Adding IP Addresses to the Allow and Deny Lists

To add an IP Address to the Allow or Deny list, and begin configuring the IP Security feature, proceed as follows.

Notes:

- *Both the Allow and Deny list can include Linux operators, wild cards, and net/mask pairs.*
- *In some cases, it is not necessary to enter all four "digits" of the IP Address. For example, if you wish to allow access to all IP addresses that begin with "192," then you would only need to enter "192."*
- *The IP Security Configuration menu is only available when the Supervisor Mode is active.*

1. Access the IP Security Configuration Menu.
 - a) **Text Interface:** Type `/N [Enter]` to display the Network Configuration Menu. From the Network Configuration Menu, type `5 [Enter]` to display the screen shown in Figure 5.13.
 - b) **Web Browser Interface:** Click on "Network Configuration" on the left hand side of the screen. When the Network Configuration menu appears, click on "IP Security" to display the screen shown in Figure 5.14.
2. **Allow List:** Enter the IP Address(es) for the clients that you wish to allow. Note that if an IP Address is found in the Allow list, the client will be allowed to connect, and the RSM will not check the Deny list.
 - a) **Text Interface:** Note the number for the first empty field in the Allow list, then type that number at the command prompt, press `[Enter]`, and then follow the instructions in the resulting submenu.
 - b) **Web Browser Interface:** Place the cursor in the first empty field in the parameters menu, then key in the desired IP Address, operators, wild cards, and/or net/mask pairs.
3. **Deny List:** Enter the IP Address(es) for the clients that you wish to deny. Note that if the client's IP Address is not found in the Deny List, that client will be allowed to connect. Use the same procedure for entering IP Addresses described in Step 2 above.

5.8.3.2. Linux Operators and Wild Cards

In addition to merely entering a specific IP address or partial IP address in the Allow or Deny list, you may also use any standard Linux operator or wild card. In most cases, the only operator used is "EXCEPT" and the only wild card used is "ALL," but more experienced Linux users may note that other operators and wild cards may also be used.

EXCEPT:

This operator creates an exception in either the "allow" list or "deny" list.

For example, if the Allow list includes a line which reads "192. EXCEPT 192.255.255.6," then all IP address that begin with "192." will be allowed; except 192.255.255.6 (providing that this address appears in the Deny list.)

ALL:

The ALL wild card indicates that all IP Addresses should be allowed or denied. When ALL is included in the Allow list, all IP addresses will be allowed to connect; conversely, if ALL is included in the Deny list, all IP Addresses will be denied (except for IP addresses listed in the Allow list.)

For example, if the Deny list includes a line which reads "ALL EXCEPT 168.255.192.192," then all IP addresses except 168.255.192.192 will be denied (except for IP addresses that are listed in the Allow list.)

Net/Mask Pairs:

An expression of the form "n.n.n.n/m.m.m.m" is interpreted as a "net/mask" pair. A host address is matched if "net" is equal to the bitwise AND of the address and the "mask."

For example, the net/mask pattern "131.155.72.0/255.255.254.0" matches every address in the range "131.155.72.0" through "131.155.73.255."

5.8.3.3. IP Security Examples

1. **Mostly Closed:** Access is denied by default and the only clients allowed, are those explicitly listed in the Allow list. To deny access to all clients except 192.255.255.192 and 168.112.112.05, the Allow and Deny lists would be defined as follows:
 - Allow List:
 1. 192.255.255.192
 2. 168.112.112.05
 - Deny List:
 1. ALL
2. **Mostly Open:** Access is granted by default, and the only clients denied access, are those explicitly listed in the Deny list, and as exceptions in the Allow list. To allow access to all clients except 192.255.255.192 and 168.112.112.05, the Allow and Deny lists would be defined as follows:
 - Allow List:
 1. ALL EXCEPT 192.255.255.192, 168.112.112.05
 - Deny List:
 1. 192.255.255.192, 168.112.112.05

Notes:

- *When defining a line in the Allow or Deny list that includes several IP addresses, each individual address is separated by either a space, a comma, or a comma and a space as shown in Example 2 above.*
- *Take care when using the "ALL" wild card. When ALL is included in the Allow list, it should always include an EXCEPT operator in order to allow the unit to proceed to the Deny list and determine any addresses you wish to deny.*

```

STATIC ROUTES:

1.
2.
3.
4.
5.
6.
7.
8.

Enter: #<CR> to select menu,
      <ESC> for previous menu ...

```

Figure 5.15: Static Route Menu (Text Interface)

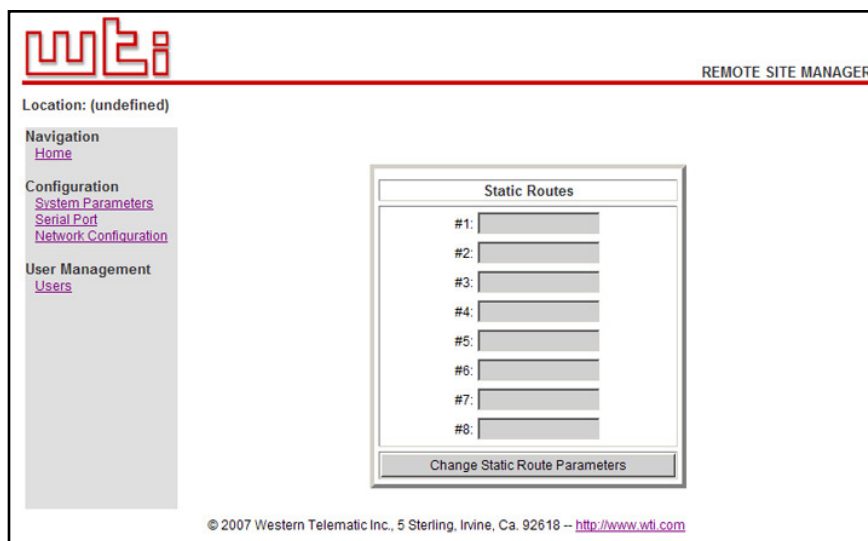

Figure 5.16: Static Route Menu (Web Browser Interface)

5.8.4. Static Route

The Static Route menu allows you to type in Linux routing commands that will be automatically executed each time that the unit powers up or reboots. In the Text Interface, the Static Route menu is accessed via item 6 in the Network Configuration menu. In the Web Browser Interface, the Static Route menu is accessed by first clicking the Network Configuration link and then clicking the Static Route link.

To access the Static Route Menus, proceed as follows:

- **Text Interface:** Type `/N` and press **[Enter]** to display the Network Parameters Menu (Figure 5.9.) At the Network Parameters Menu, type 6 and press **[Enter]**. The Static Route Menu should appear as shown in Figure 5.15.
- **Web Browser Interface:** Click on the "Network Configuration" link on the left hand side of the RSM Home screen to display the Network Configuration menu (Figure 5.10). From the Network Configuration Menu, Click the Static Route link to display the menu shown in Figure 5.16.

```

DNS SERVER IP ADDRESSES:

1.
2.
3.
4.

Enter: #<CR> to select menu,
      <ESC> for previous menu ...

```

Figure 5.17: Nomain Name Server Menu (Text Interface)

Figure 5.18: Domain Name Server Menu (Web Browser Interface)

5.8.5. Domain Name Server

The Domain Name Server menu is used to select IP addresses for the Domain Name Servers. When web and network addresses are entered, the Domain Name Server interprets the domain name (e.g., www.wti.com), and translates it into an IP address. Note that if you don't define at least one DNS server, then IP addresses must be used, rather than domain names.

To access the Domain Name Server Menu, proceed as follows:

- **Text Interface:** Type `/n` and press **[Enter]** to display the Network Parameters Menu (Figure 5.9.) At the Network Parameters Menu, type `7` and press **[Enter]**. The Static Route Menu should appear as shown in Figure 5.17.
- **Web Browser Interface:** Click on the "Network Configuration" link on the left hand side of the RSM Home screen to display the Network Configuration menu (Figure 5.10). From the Network Configuration Menu, Click the Domain Name Server link to display the menu shown in Figure 5.18.

```

SNMP ACCESS:

1. Enable:           Off
2. Contact:         (undefined)
3. Location:        (undefined)
4. Community:      public

Enter: #<CR> to change,
      <ESC> for previous menu ...

```

Figure 5.19: SNMP Access Menu (Text Interface)

```

SNMP TRAP:

Note: The SNMP trap feature is enabled by defining at least one manager.

1. Manager 1:       (undefined)
2. Manager 2:       (undefined)
3. Community:      public

Enter: #<CR> to change,
      <ESC> for previous menu ...

```

Figure 5.20: SNMP Trap Menu (Text Interface)

Figure 5.21: SNMP Parameters Menu (Web Browser Interface)

5.8.6. SNMP Parameters

These menus are used to select parameters that will be used when an SNMP trap is generated. To define or change SNMP parameters, proceed as follows:

- **Text Interface:** Type /N and press **[Enter]** to display the Network Parameters Menu (Figure 5.9.) At the Network Parameters Menu, type 25 and press **[Enter]** to display the SNMP Access Menu (Figure 5.19,) or type 26 and press **[Enter]** to display the SNMP Trap Menu (Figure 5.20.)
- **Web Browser Interface:** Click on the "Network Configuration" link on the left hand side of the RSM Home screen to display the Network Configuration menu (Figure 5.10). From the Network Configuration Menu, Click the SNMP Parameters link to display the menu shown in Figure 5.21.

In the Text Interface SNMP parameters are defined via two separate menus, The SNMP Access Menu and the SNMP Trap Menu. In the Web Browser Interface, all SNMP parameters are defined via a single menu. Both the Text Interface and Web Browser Interface allow the following parameters to be defined:

- **Enable:** Enables/disables SNMP Polling. (Default = Off.)
Note: *This item only applies to external SNMP polling of the RSM; it does not effect the ability of the RSM to send SNMP traps.*
- **SNMP Contact:** (Default = undefined.)
- **SNMP Location:** (Default = undefined.)
- **SNMP Community:** (Default = Public.)
- **SNMP Manager 1:** The IP Address for the first SNMP Manager. For more information, please refer to Section 10. (Default = Undefined.)
Note: *In order to enable the SNMP Trap feature, you must define at least one SNMP Manager.*
- **SNMP Manager 2:** (Default = Undefined.)
- **Trap Community:** (Default = Public.)

```

LDAP:

1.  Enable:                Off
2.  LDAP Port:             389
3.  Primary Host:         (undefined)
4.  Secondary Host:       (undefined)
5.  Bind Type:            Simple
6.  Search Bind DN:      (undefined)
7.  Search Bind Password: (undefined)
8.  User Search Base DN: (undefined)
9.  User Search Filter:  (undefined)
10. Group Membership Attribute: (undefined)
11. Group Membership Value Type: DN
12. Fallback:            Off
13. LDAP Group Setup

Enter: #<CR> to change,
      <ESC> for previous menu ...

```

Figure 5.22: LDAP Parameters Menu (Text Interface)

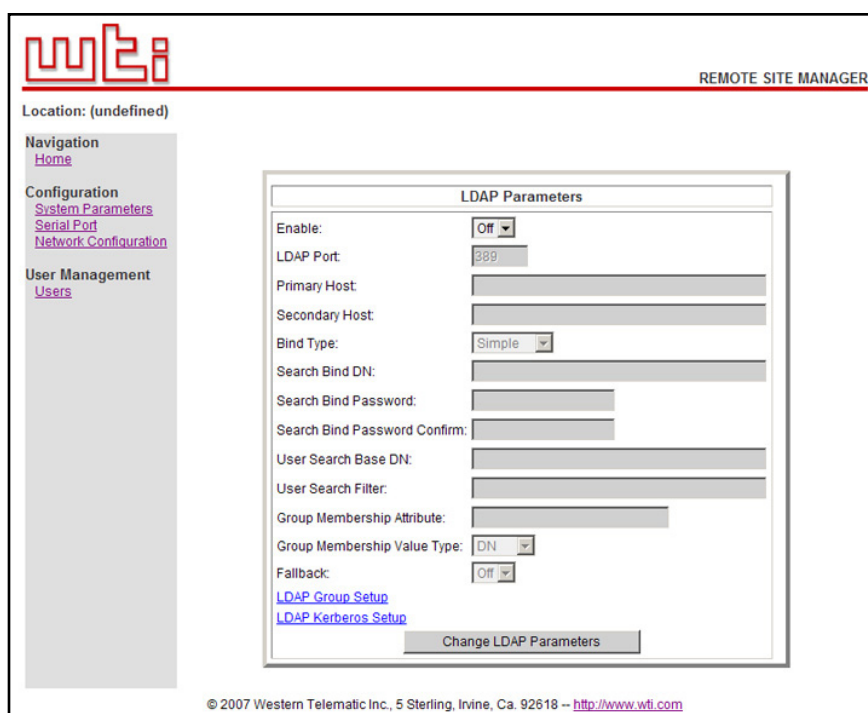

Figure 5.23: LDAP Parameters Menu (Web Browser Interface)

5.8.7. LDAP Parameters

The RSM supports LDAP (Lightweight Directory Access Protocol,) which allows authentication via the "Active Directory" network Directory Service. When LDAP is enabled and properly configured, command access rights can be granted to new users without the need to define individual new accounts at each RSM unit, and existing users can also be removed without the need to delete the account from each RSM unit.

This type of authentication also allows administrators to assign users to LDAP groups, and then specify which ports the members of each group will be allowed to access at each RSM unit.

In order to apply the LDAP feature, you must first define User Names and associated Passwords and group membership via your LDAP server, and then access the RSM command mode to enable and configure the LDAP settings and define port access rights and command access rights for each group that you have specified at the LDAP server.

To access the LDAP Parameters menu, access the command mode using a port and password that permit access to Supervisor Level commands and then proceed as follows:

- **Text Interface:** Type `/n` and press **[Enter]** to display the Network Parameters Menu (Figure 5.9.) At the Network Parameters Menu, type 27 and press **[Enter]** to display the LDAP parameters menu (Figure 5.22.)
- **Web Browser Interface:** At the Home Screen, click on the Network Configuration link to display the Network Configure menu (Figure 5.10,) and then click on the LDAP Parameters link to display the LDAP Parameters menu (Figure 5.23.)

Notes:

- *Port access rights are not defined at the LDAP server. They are defined via the LDAP Group configuration menu on each RSM unit and are specific to that RSM unit alone.*
- *When LDAP is enabled and properly configured, LDAP authentication will supersede any passwords and access rights that have been defined via the RSM user directory.*
- *If no LDAP groups are defined on a given RSM unit, then access rights will be determined as specified by the "default" LDAP group.*
- *The "default" LDAP group cannot be deleted.*

The LDAP Parameters Menu (Figure 5.22 or Figure 5.23) allows you to define the following parameters:

- **Enable:** Enables/disables LDAP authentication. (Default = Off.)
- **LDAP Port:** Defines the port that will be used to communicate with the LDAP server. (Default = 389.)
- **Primary Host:** Defines the IP address or domain name (up to 64 characters) for the primary LDAP server. (Default = undefined.)
- **Secondary Host:** Defines the IP address or domain name (up to 64 characters) for the secondary (fallback) LDAP server. (Default = undefined.)
- **Bind Type:** Sets the LDAP bind request password type. Note that in the Text Interface, when the Bind Type is set to "Kerberos" LDAP menu will include an additional prompt (item 14) that is used to select Kerberos parameters as described in Section 5.8.7.5. In the Web Interface, the link to the kerberos parameters menu is located at the bottom of the LDAP Parameters Menu. (Default = Simple.)
- **Search Bind DN:** Selects the user name who is allowed to search the LDAP directory. (Default = undefined.)
- **Search Bind Password:** Sets the Password for the user who is allowed to search the LDAP directory. (Default = undefined.)

- **User Search Base DN:** Sets the directory location for user searches. (Default = undefined.)
- **User Search Filter:** Selects the attribute that lists the user name. Note that this attribute should always end with "=%s" (no quotes.) (Default = undefined.)
- **Group Membership Attribute:** Selects the attribute that list group membership(s). (Default = undefined.)
- **Group Membership Value Type:** (Default = DN.)
- **Fallback:** Enables/Disables the LDAP fallback feature. When enabled, the RSM will revert to it's own internal user directory (see Section 5.5) if no defined users are found via the LDAP server. In this case, port access rights will then be granted as specified in the default LDAP group. (Default = Off.)

5.8.7.1. Adding LDAP Groups

Once you have defined several users and passwords via your LDAP server, and assigned those users to LDAP Groups, you must then grant command and port access rights to each LDAP Group at each individual RSM unit.

To add LDAP groups to your RSM unit, access the command mode using a port and password that permit access to Supervisor Level commands, and then proceed as follows:

- **Text Interface:** Type `/n` and press **[Enter]** to display the Network Parameters Menu (Figure 5.9.) At the Network Parameters Menu, type 27 and press **[Enter]** to display the LDAP parameters menu (Figure 5.22), then type 13 and press **[Enter]** to display the LDAP Group Menu (Figure 5.24.) At the LDAP Group Menu, type 2 and press **[Enter]** to display the Add LDAP Group menu (Figure 5.25.)
- **Web Browser Interface:** At the RSM Home Screen, click on the Network Configuration link to display the Network Configure menu (Figure 5.10,) and then click on the LDAP Parameters link to display the LDAP Parameters menu (Figure 5.23.) At the LDAP Parameters menu, click on the LDAP Group Configuration link to display the LDAP Group Configuration menu, then click the Add LDAP Group link to display the Add LDAP Group menu (Figure 5.26.)

```
LDAP GROUP:

1. View LDAP Groups
2. Add LDAP Group
3. Modify LDAP Group
4. Delete LDAP Group

Enter: #<CR> to select,
      <ESC> for previous menu ...
```

Figure 5.24: LDAP Group Configuration (Text Interface)

```

ADD LDAP GROUP:

1. LDAP Group
2. Access Level:
3. Port Access:
User

PORT#  PORT NAME      ACCESS  PORT#  PORT NAME      ACCESS
-----
1      (undefined)      Off     6      (undefined)      Off
2      (undefined)      Off     7      (undefined)      Off
3      (undefined)      Off     8      (undefined)      Off
4      (undefined)      Off     9      MODEM             Off
5      (undefined)      Off

Enter: #<CR> to select,
      <ESC> to return to previous menu ...

```

Figure 5.25: Add LDAP Group Menu (Text Interface; RSM-8 Shown)

Figure 5.26: Add LDAP Group Menu (Web Browser Interface; RSM-8 Shown)

The Add LDAP Group menus allow the following parameters to be defined:

- **LDAP Group:** Note that this name must match the LDAP Group names that you have assigned to users at your LDAP server. (Default = undefined.)
- **Access Level:** Sets the command mode and port access level. When this feature is "On", members of this group will be allowed to access Supervisor Level commands and access all ports; when the feature is "Off", group members will not be allowed to access Supervisor Level commands and will be restricted to the ports that are specifically allowed for this group. (Default = Off.)
- **Port Access:** This prompt is used to determine which ports the user will be allowed to create connections with. (Default = All Ports Off.)

Notes:

- On RSM-8 units, the internal modem port is Port 9.
- On RSM-16 units, the internal modem port is Port 17.
- On RSM-32 units, the internal modem port is Port 33.

```

VIEW LDAP GROUP DETAILS:

1. LDAP Group           default
2. Access Level:       Admin
3. Port Access:

  PORT#  PORT NAME      ACCESS  PORT#  PORT NAME      ACCESS
  -----
  1      (undefined)      On      6      (undefined)      On
  2      (undefined)      On      7      (undefined)      On
  3      (undefined)      On      8      (undefined)      On
  4      (undefined)      On      9      MODEM             On
  5      (undefined)      On

Enter: <CR> or <ESC> to return to previous menu...

```

Figure 5.27: View LDAP Group Menu (Text Interface; RSM-8 Shown)

Location: (undefined)

Navigation
[Home](#)

Configuration
[System Parameters](#)
[Serial Port](#)
[Network Configuration](#)

User Management
[Users](#)

© 2007 Western Telematic Inc., 5 Sterling, Irvine, Ca. 92618 -- <http://www.wti.com>

Figure 5.28: View LDAP Group Menu (Web Browser Interface; RSM-8 Shown)

5.8.7.2 Viewing LDAP Groups

If you want to examine an existing LDAP group definition on an RSM unit, the "View LDAP Groups" function can be used to review the group's Access Level and Port Access Settings. To view an existing LDAP group, proceed as follows:

- **Text Interface:** Type `/N` and press **[Enter]** to display the Network Parameters Menu (Figure 5.9.) At the Network Parameters Menu, type 27 and press **[Enter]** to display the LDAP parameters menu (Figure 5.22), then type 13 and press **[Enter]** to display the LDAP Group Menu (Figure 5.24), then type 1 and press **[Enter]**. The RSM will prompt you to select the desired group; key in the name of the group and press **[Enter]**, the RSM will display the View LDAP Group screen (Figure 5.27.)
- **Web Browser Interface:** At the RSM Home Screen, click on the "Network Configuration" link to display the Network Configure menu (Figure 5.10,) and then click on the "LDAP Parameters" link to display the LDAP Parameters menu (Figure 5.23.) At the LDAP Parameters menu, click on the "LDAP Group Configuration" link to display the LDAP Group Configuration menu, then click the "View/Modify LDAP Group" link to display the Choose LDAP Group menu; use the drop down menu to select the desired group, select "View LDAP Group" and then click the "Choose LDAP Group" button to display the screen shown in Figure 5.28.

```

MODIFY LDAP GROUP DETAILS:

1. LDAP Group          default
2. Access Level:      Admin
3. Port Access:

  PORT#  PORT NAME      ACCESS  PORT#  PORT NAME      ACCESS
  -----
  1      (undefined)      On      6      (undefined)      On
  2      (undefined)      On      7      (undefined)      On
  3      (undefined)      On      8      (undefined)      On
  4      (undefined)      On      9      MODEM             On
  5      (undefined)      On

Enter: #<CR> to select,
      <ESC> to return to previous menu ...

```

Figure 5.29: Modify LDAP Group Menu (Text Interface; RSM-8 Shown)

REMOTE SITE MANAGER

Location: (undefined)

Navigation
[Home](#)

Configuration
[System Parameters](#)
[Serial Port](#)
[Network Configuration](#)

User Management
[Users](#)

Modify LDAP Group

LDAP Group: default

Access Level: On

Port 1 Access: On

Port 2 Access: On

Port 3 Access: On

Port 4 Access: On

Port 5 Access: On

Port 6 Access: On

Port 7 Access: On

Port 8 Access: On

Port 9 Access: On

Modify LDAP Group

© 2007 Western Telematic Inc., 5 Sterling, Irvine, Ca. 92618 -- <http://www.wti.com>

Figure 5.30: Modify LDAP Group Menu (Web Browser Interface; RSM-8 Shown)

5.8.7.3. Modifying LDAP Groups

If you want to modify an existing LDAP Group in order to change command access rights or port access rights, the "Modify LDAP Group" function can be used to edit group parameters. To Modify an existing LDAP Group, proceed as follows:

- Text Interface:** Type /N and press [Enter] to display the Network Parameters Menu (Figure 5.9.) At the Network Parameters Menu, type 27 and press [Enter] to display the LDAP parameters menu (Figure 5.22), then type 13 and press [Enter] to display the LDAP Group Menu (Figure 5.24), then type 3 and press [Enter]. The RSM will prompt you to select the desired group; key in the name of the group and press [Enter], the RSM will display the Modify LDAP Group screen (Figure 5.29.)
- Web Browser Interface:** At the RSM Home Screen, click on the "Network Configuration" link to display the Network Configure menu (Figure 5.10,) and then click on the "LDAP Parameters" link to display the LDAP Parameters menu (Figure 5.23.) At the LDAP Parameters menu, click on the "LDAP Group Configuration" link to display the LDAP Group Configuration menu, then click the "View/Modify LDAP Group" link to display the Choose LDAP Group menu; use the drop down menu to select the desired group, select "Modify LDAP Group" and then click the "Choose LDAP Group" button to display the screen shown in Figure 5.30.

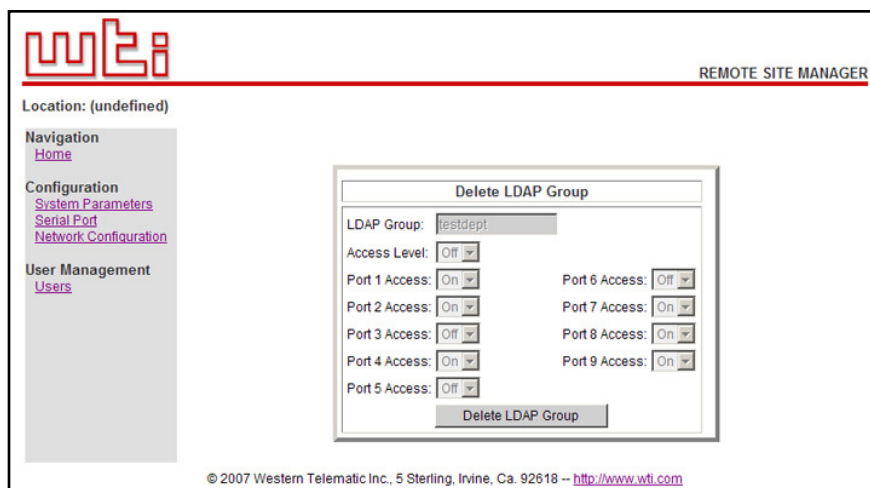

Figure 5.31: Delete LDAP Group Menu (Web Browser Interface)

5.8.7.4. Deleting LDAP Groups

The Delete LDAP Group function is used to delete LDAP Groups that are no longer in use. To delete an existing LDAP Group, proceed as follows:

- Text Interface:** Type /N and press **[Enter]** to display the Network Parameters Menu (Figure 5.9.) At the Network Parameters Menu, type 27 and press **[Enter]** to display the LDAP parameters menu (Figure 5.22), then type 13 and press **[Enter]** to display the LDAP Group Menu (Figure 5.24), then type 4 and press **[Enter]**. The RSM will prompt you to select the desired group; key in the name of the group and press **[Enter]**, the RSM will delete the specified LDAP Group immediately.
- Web Browser Interface:** At the RSM Home Screen, click on the "Network Configuration" link to display the Network Configure menu (Figure 5.10,) and then click on the "LDAP Parameters" link to display the LDAP Parameters menu (Figure 5.23.) At the LDAP Parameters menu, click on the "LDAP Group Configuration" link to display the LDAP Group Configuration menu, then click the "View/Modify LDAP Group" link to display the Choose LDAP Group menu; use the drop down menu to select the desired group, select "Delete LDAP Group" and then click the "Choose LDAP Group" button to display the screen shown in Figure 5.31. If the Delete LDAP Group menu shows the desired group, then click the "Delete LDAP Group" button to immediately delete the group.

```

LDAP KERBEROS SETUP

1. Port : 88
2. Realm :

KDC (KDC1 - KDC5)
3.
4.
5.
6.
7.

Domain Realm (Domain Realm1 - Domain Realm5)
8.
9.
10.
11.
12.

Enter: #<CR> to select,
      <ESC> for previous menu ...
    
```

Figure 5.32: LDAP Kerberos Set Up Menu (Text Interface)

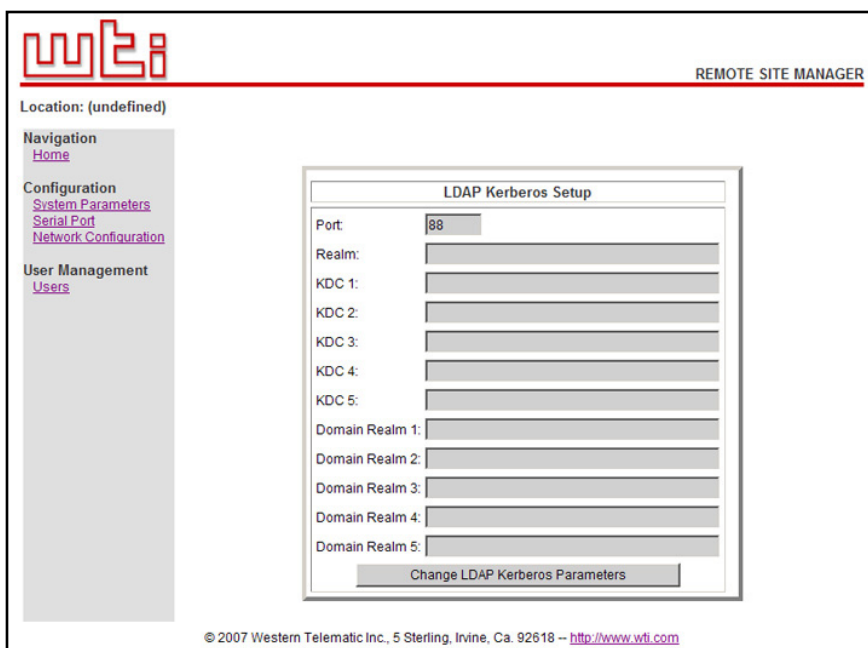

Figure 5.33: LDAP Kerberos Set Up Menu (Web Browser Interface)

5.8.7.5. LDAP Kerberos Set Up

Kerberos is a network authentication protocol, which provides a secure means of identity verification for users who are communicating via an insecure network.

To access the LDAP Kerberos Set Up menu, access the command mode using a port and password that permit access to Supervisor Level commands and then proceed as follows:

- **Text Interface:** Type `/N` and press **[Enter]** to display the Network Parameters Menu (Figure 5.9.) At the Network Parameters Menu, type `27` and press **[Enter]** to display the LDAP Parameters menu (Figure 5.22.) At the LDAP Parameters Menu, type `5` and press **[Enter]** and then use the resulting submenu to set the Bind Type to Kerberos. Next, return to the LDAP Parameters menu. Note that the LDAP Parameters Menu now includes a prompt which is used to select Kerberos parameters. Type `14` and press **[Enter]** to display the Kerberos Set Up menu as shown in Figure 5.32.
- **Web Browser Interface:** At the Home Screen, click on the Network Configuration link to display the Network Configure menu (Figure 5.10,) and then click on the LDAP Parameters link to display the LDAP Parameters menu (Figure 5.23.) At the LDAP Parameters menu, click on the LDAP Kerberos Setup link to display the LDAP Kerberos Setup menu as shown in Figure 5.33.

The LDAP Kerberos Setup menu allows you to define the following parameters:

- **Port:** (Default = 88.)
- **Realm:** (Default = Undefined.)
- **Key Distribution Centers (KDC1 through KDC5):** (Default = Undefined.)
- **Domain Realms 1 through 5:** (Default = Undefined.)

```

TACACS:

1. Enable:                Off
2. Primary address:      (undefined)
3. Secondary address:    (undefined)
4. Secret Word:         (undefined)
5. Fallback Timer:      3 Sec
6. Fallback Local:      Off
7. Authentication Port: 49

Enter: #<CR> to change,
      <ESC> for previous menu ...

```

Figure 5.34: The TACACS Parameters Menu (Text Interface)

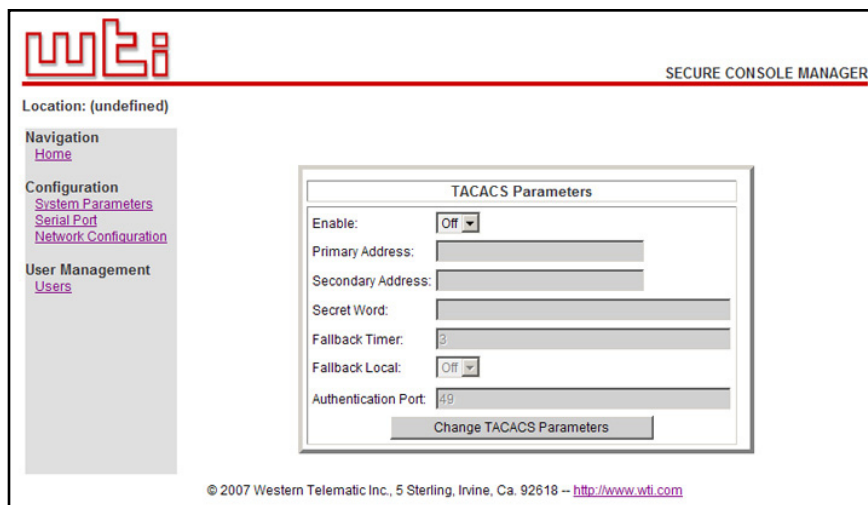

Figure 5.35: The TACACS Parameters Menu (Web Browser Interface)

5.8.8. TACACS Parameters

To access the TACACS Configuration Menus, proceed as follows:

- **Text Interface:** Type `/N` and press **[Enter]** to access the Network Configuration Menu. From the Network Configuration Menu, type `28` and press **[Enter]** to display the TACACS Configuration Menu (Figure 5.34.)
- **Web Browser Interface:** Click on the "Network Configuration" link to display the menu shown in Figure 5.10, then click the "TACACS Parameters" link to display the TACACS Configuration Menu (Figure 5.35.)

The TACACS Configuration Menus offer the following options:

- **Enable:** Enables/disables the TACACS feature at the Network Port. (Default = Off.)
- **Primary Address:** Defines the IP address or domain name (up to 64 characters) for your primary TACACS server. (Default = undefined.)
- **Secondary Address:** Defines the IP address or domain name (up to 64 characters) for your secondary, fallback TACACS server (if present.) (Default = undefined.)

- **Secret Word:** Defines the shared TACACS Secret Word for both TACACS servers. (Default = undefined.)
- **Fallback Timer:** Determines how long the RSM will continue to attempt to contact the primary TACACS Server before falling back to the secondary TACACS Server. (Default = 3 Seconds.)
- **Fallback Local:** Determines whether or not the RSM will fallback to its own password/username directory when an authentication attempt fails. When enabled, the RSM will first attempt to authenticate the password by checking the TACACS Server; if this fails, the RSM will then attempt to authenticate the password by checking its own internal username directory. (Default = Off.)
- **Authentication Port:** The port number for the TACACS function. (Default = 49.)

```

RADIUS:

1. Enable:                Off
2. Primary Address:      (undefined)
3. Primary Secret Word:  (undefined)
4. Secondary Address:    (undefined)
5. Secondary Secret Word: (undefined)
6. Fallback Timer:       3 Sec
7. Fallback Local:       Off
8. Authentication Port:  1812
9. Accounting Port:      1813

Enter: #<CR> to change,
      <ESC> for previous menu ...

```

Figure 5.36: The RADIUS Parameters Menu (Text Interface)

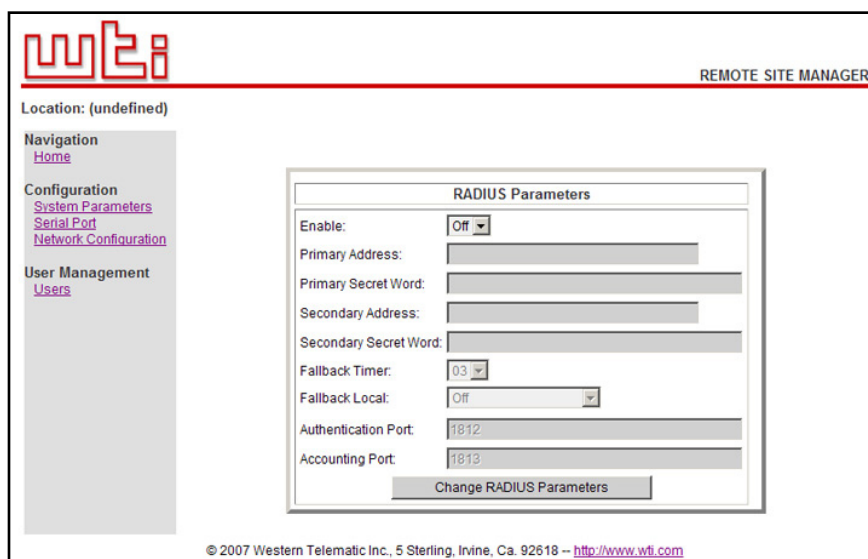

Figure 5.37: The RADIUS Parameters Menu (Web Browser Interface)

5.8.9. RADIUS Parameters

To access the RADIUS Configuration Menus, proceed as follows:

- **Text Interface:** Type `/N` and press **[Enter]** to access the Network Configuration Menu. From the Network Configuration Menu, type `29` and press **[Enter]** to display the RADIUS Configuration Menu (Figure 5.36.)
- **Web Browser Interface:** Click on the "Network Configuration" link to display the menu shown in Figure 5.10, then click the "RADIUS Parameters" link to display the RADIUS Configuration Menu (Figure 5.37.)

The RADIUS Configuration Menus offer the following options:

- **Enable:** Enables/disables the RADIUS feature at the Network Port. (Default = Off.)
- **Primary Address** Defines the IP address or domain name (up to 64 characters long) for your primary RADIUS server. (Default = undefined.)
- **Primary Secret Word:** Defines the RADIUS Secret Word for the primary RADIUS server. (Default = undefined.)

- **Secondary Address:** Defines the IP address or domain name (up to 64 characters long) for your secondary, fallback RADIUS server (if present.) (Default = undefined.)
- **Secondary Secret Word:** Defines the RADIUS Secret Word for the secondary RADIUS server. (Default = undefined.)
- **Fallback Timer:** Determines how long the RSM will continue to attempt to contact the primary RADIUS Server before falling back to the secondary RADIUS Server. (Default = 3 Seconds.)
- **Fallback Local:** Determines whether or not the RSM will fallback to its own password/username directory when an authentication attempt fails. When enabled, the RSM will first attempt to authenticate the password by checking the RADIUS Server; if this fails, the RSM will then attempt to authenticate the password by checking its own internal username directory. This parameter offers three options:
 - ◆ **Off:** Fallback Local is disabled (Default.)
 - ◆ **On (All Failures):** Fallback Local is enabled, and the unit will fallback to its own internal user directory when it cannot contact the Radius Server, or when a password or username does not match the Radius Server.
 - ◆ **On (Transport Failure):** Fallback Local is enabled, but the unit will only fallback to its own internal user directory when it cannot contact the Radius Server.
- **Authentication Port:** The Authentication Port number for the RADIUS function. (Default = 1812.)
- **Accounting Port:** The Accounting Port number for the RADIUS function. (Default = 1813.)

```

COPY PORT PARAMETERS:

COMMUNICATION SETTING          PORT MODE PARAMETERS
1. Baud Rate:                  21. Port Name:
2. Bits/Parity:                22. Port Mode:
3. Stop Bits:                  23. DTR Output:
4. Handshake:                  24. Buffer Params:    ---
                               25. Modem Params:      ---

GENERAL PARAMETERS             NETWORK SERVICES
11. Supervisor Mode:          31. Direct Connect:
12. Logoff Char:
13. Sequence Disc:
14. Inact Timeout:
15. Command Echo:            32. Syslog:          ---
16. Accept Break:           33. SNMP Trap Lv:   ---

Enter: #<CR> to define parameter.
      Port 1 and internal modem port restricted values NOT changed,
      -<CR> to remove all values set,      X<CR> to exit WITHOUT copy,
      <ESC> to copy to ports and exit ...

```

Figure 5.38: The Copy Port Parameters Menu

5.9. Copying Parameters to Several RS-232 Ports (Text Interface Only)

When the /CP command (Copy Port Parameters) is invoked, the unit will display a menu which allows you to select parameters, and copy them to all or several RS-232 ports. The Copy Port Parameters menu can set all parameters for the specified port(s), or define only a select group of parameters for a specific group of ports.

Notes:

- The /CP command is not available via the Web Browser Interface.
- The /CP command will not copy parameters to the Network Port or Internal Modem Port.
- The /CP command is only available to accounts and ports that permit Supervisor commands.
- The /CP command cannot be used to set Ports 1 or 2 to Passive or Buffer Mode, or to disable the Supervisor Mode at Ports 1 or 2.

To copy parameters to all or several RS-232 ports, proceed as follows:

1. Use the Text Interface to enter command mode via an account and port that permit access to Supervisor commands.

2. Invoke the `/CP` command at the command prompt; the menu shown in Figure 5.38 will be displayed. The following options are available:
 - a) **Copy to All Ports:** Type `/CP [Enter]`.
 - b) **Copy to a Range of Ports:** Type `/CP m-n [Enter]`. Where `m` and `n` are port numbers that specify the desired range. For example, to copy parameters to ports 3 through 7, type `/CP 3-7` and press `[Enter]`.
 - c) **Copy to Several Ports:** Type `/CP m,n,x [Enter]`. Where `m`, `n` and `x` are the numbers of the desired ports. For example, to copy parameters to ports 3, 5, and 7, type `/CP 3,5,7 [Enter]`.
 - d) **Combination:** To invoke the `/CP` command in a manner where a range of ports is specified, along with several ports outside the range, type `/CP m,n,x-z [Enter]`. Where `m`, `n`, `x`, and `z` are port numbers. For example to copy parameters to ports 3 and 5 *plus* ports 7 through 9, type `/CP 3,5,7-9 [Enter]`.
3. **Selecting Parameters:** To select parameters to be copied, key in the number for the desired parameter, press `[Enter]`, then follow the instructions in the submenu.

Note: *The /CP command will only copy the parameters currently displayed by the Copy Port Parameters menu.*
4. **Clear Menu:** After defining several parameters, if you wish to clear the `/CP` menu and start again, type `-` (dash) and press `[Enter]`, the menu will be reset.
5. **Exit Without Copy:** To exit from the Copy Parameters menu *without* copying selected parameters, type `x [Enter]`. The RSM will return to the command prompt.
6. **Copy Parameters:** When you have finished selecting parameters, press `[Esc]` to copy the selected parameters.

5.10. Save User Selected Parameters

Although this step is optional, it is strongly recommended to save all user-defined parameters to an ASCII file as described in Section 11. This will allow quick recovery in the event of accidental deletion or reconfiguration of port parameters.

6. The Status Screens

The Status Screens display connection status and communication parameters for the RS232 ports and the Network Port. There are four different status screens; The Port Status Screen (/S), the Port Diagnostics Screen (/SD), the Network Status Screen (/SN), and the Port Parameters Screens (/W).

Note: *The status screens discussed in this section are only available via the Text Interface. The status screens cannot be accessed via the Web Browser Interface.*

```

PORT STATUS:
Site ID: (undefined)                                02/07/2007 00:33:38 GMT (GMT+0000)

PORT | NAME | USERNAME | STATUS | MODE | BUFFER COUNT
-----|-----|-----|-----|-----|-----
01 | (undefined) | | Free | Any | 0
02 | (undefined) | | Free | Any | 0
03 | (undefined) | | Free | Pass | 0
04 | (undefined) | | Free | Pass | 0
05 | (undefined) | | Free | Pass | 0
06 | (undefined) | | Free | Pass | 0
07 | (undefined) | | Free | Pass | 0
08 | (undefined) | | Free | Pass | 0
09 | MODEM | | Free | Modem | 0

Enter /H for command menu.
RSM>

```

Figure 6.1: Port Status Screen (Sample Data Shown - RSM-8 Unit Shown)

6.1. The Port Status Screen (/S)

The Port Status Screen lists the general status of the RSM's sixteen RS-232 ports. To display the Port Status Screen, access the Text Interface command mode and type `/s` [Enter], the screen will appear as shown in Figure 6.1.

Note that the screen format will vary, depending upon whether the user account permits or denies access to Supervisor commands. If the username entered at login does not allow Supervisor commands, then the Port Status Screen will only display the status of the ports allowed by that account.

The Port Status Screen lists the following items:

- **Port:** The Port Number.

Notes:

- *On RSM-8 units, the internal modem port is Port 9.*
- *On RSM-16 units, the internal modem port is Port 17.*
- *On RSM-32 units, the internal modem port is Port 33.*
- **Name:** The user-defined name for each port.
- **Username:** The username that was entered in order to access command mode via this port.
- **Status:** The connect status of each port.
 - ◆ If the port is connected to an RS232 port, this column will list the number of the other RSM port in "c-*nn*" format, where "*nn*" is the number of the RSM port connected to this port (for example, "c-07".)
 - ◆ If the connected port is listed as "**Nn**" (where "*n*" is a number), this indicates that the RSM RS232 port is connected to the Network port. The numbers indicate which of the available Telnet sessions is being used (for example, "c-N5".)
- **Mode:** The user-selected Port Mode.
- **Buffer Count:** The amount of data (in bytes) stored in the buffer for this port.

```

PORT DIAGNOSTICS:
Site ID: (undefined)                                02/07/2007 00:34:51 GMT (GMT+0000)

PORT | NAME | STATUS | BAUD | COM | HS | MODE | BUF | CTS
-----+-----+-----+-----+-----+-----+-----+-----+-----
01 | (undefined) | Free | 9600 | 8N1 | RTS | Any | 0 | H
02 | (undefined) | Free | 9600 | 8N1 | RTS | Any | 0 | L
03 | (undefined) | Free | 9600 | 8N1 | RTS | Pass | 0 | L
04 | (undefined) | Free | 9600 | 8N1 | RTS | Pass | 0 | L
05 | (undefined) | Free | 9600 | 8N1 | RTS | Pass | 0 | L
06 | (undefined) | Free | 9600 | 8N1 | RTS | Pass | 0 | L
07 | (undefined) | Free | 9600 | 8N1 | RTS | Pass | 0 | L
08 | (undefined) | Free | 9600 | 8N1 | RTS | Pass | 0 | L
09 | MODEM | Free | 57.6K | 8N1 | RTS | Modem | 0 | H

Enter /H for command menu.
RSM>

```

Figure 6.2: Port Diagnostics Screen (RSM-8 Shown)

6.2. The Port Diagnostics Screen (/SD)

The Port Diagnostics Screen provides more detailed information about each port. To display the Port Diagnostics Screen, access the Text Interface command mode and type `/SD [Enter]`, the screen will appear as shown in Figure 6.2.

Note that the screen format will vary, depending upon whether your account permits or denies access to Supervisor commands. If the username entered at login does not allow Supervisor commands, then the Port Diagnostics Screen will only display the status of the ports allowed by that account. Ports that are not assigned to the account will not be displayed.

The Port Diagnostics Screen lists the following items:

- **Port:** The Port Number. If this column contains a plus sign (+) next to the port number, this indicates that the port is allowed to invoke Supervisor commands, providing the user account allows access to these commands.
- **Name:** The user-defined name for each port.
- **Status:** The connect status for each port.
 - ◆ When the port is connected, this column will list the number of the other port connected to this port. If the column contains an asterisk, this indicates the port has accessed command mode.
 - ◆ If the connected port is listed as "**Nn**" (where "**n**" is a number), this indicates that the RS232 port is connected to the Network port. The numbers indicate which of the available Telnet sessions is being used (for example, "**C-06**".)
- **Baud:** The baud rate selected for each port.
- **COM:** The Data Bits, Parity, and Stop Bits selected for each port. For example, "**8N1**" indicates Eight data bits, No parity, and One stop bit.
- **HS:** The handshaking (flow control) mode for each port.
- **Mode:** The user-selected Port Mode.
- **BUF:** The amount of data (in bytes) currently stored in the buffer for this port.
- **CTS:** The High/Low status of the CTS line at the RS232 interface.

NETWORK STATUS:				MAC Address: 00-09-9b-00-b7-fa			
PORT	TCP PORT	STATUS	USERNAME	PORT	TCP PORT	STATUS	USERNAME
N1	23	Active	super	N17		Free	
N2	23	Active	super	N18		Free	
N3		Free		N19		Free	
N4		Free		N20		Free	
N5		Free		N21		Free	
N6		Free		N22		Free	
N7		Free		N23		Free	
N8		Free		N24		Free	
N9		Free		N25		Free	
N10		Free		N26		Free	
N11		Free		N27		Free	
N12		Free		N28		Free	
N13		Free		N29		Free	
N14		Free		N30		Free	
N15		Free		N31		Free	
N16		Free		N32		Free	

Enter <CR> to show more, <ESC> to quit...

Figure 6.3: Network Status Screen

6.3. The Network Status Screen (/SN)

This screen lists current conditions for the Network Port. To display the Network Status Screen, type `/SN` and press **[Enter]**. The Network Status Screen is only available when you have logged in using an account and port that permit Supervisor commands.

Note that the RSM will allow up to sixty four simultaneous inbound TCP connections, and that the Network Status Screen will report the current status of all sixty four TCP ports. The first screen shown will list ports N1 through N32; to display additional ports, press **[Enter]**.

As shown in Figure 6.3, the Network Status Screen lists the following:

- **MAC Address:** The permanent physical address assigned to the Network Card.
- **Port:** The Network Port Number for each logical TCP Port. For more information, please refer to Section 8.1.
- **TCP Port:** The logical TCP port number to which each Telnet session is connected. Normally, when a Telnet session has been established, this field will list port number 23, however, if the Direct Connect feature has been used to establish a connection, the TCP Port number will be listed as described in Section 8.3.3.
- **Status:** The status for each TCP port.
 - ◆ If the Status Column reads "Active," this indicates the port has accessed command mode.
 - ◆ If this Telnet session is connected to an RS232 Port, this column will read "C-*nn*," where "*nn*" indicates the connected port for each Telnet session.
- **Username:** The username that was entered at this port in order to access command mode.

```

PORT PARAMETERS #03:

COMMUNICATION SETTING
1. Baud Rate:          9600
2. Bits/Parity:       8-None
3. Stop Bits:         1
4. Handshake:         RTS/CTS

PORT MODE PARAMETERS
21. Port Name:
22. Port Mode:        Passive
23. DTR Output:       Pulse
24. Buffer Params:    ---
25. Modem Params:     ---

GENERAL PARAMETERS
11. Supervisor Mode:  Permit
12. Logoff Char:      ^X
13. Sequence Disc:   One Char
14. Inact Timeout:    5 Min
15. Command Echo:    On
16. Accept Break:    On

NETWORK SERVICES
31. Direct Connect:  Off
    Telnet Port:     ---
    SSH Port:        ---
    Raw Port:        ---
32. Syslog:          ---
33. SNMP Trap Lv:   ---

RSM>

```

Figure 6.4: Port Parameters Screen (RS232 Port Shown)

```

NETWORK PARAMETERS:

COMMUNICATION SETTING
1. IP Address:        192.168.100.48
2. Subnet Mask:       255.255.255.0
3. Gateway Addr:     (undefined)
4. DHCP:              Off
5. IP Security:       Off
6. Static Route:      Off
7. DNS Servers:      (undefined)

SERVERS AND CLIENTS
21. Telnet Access:    On
22. SSH Access:       On
23. Web Access:       On
24. SYSLOG Addr:     (undefined)
25. SNMP Access:     Off
26. SNMP Trap:       Off
27. LDAP:             Off
28. TACACS:           Off
29. RADIUS:           Off
30. PING Access:      On
31. Raw Socket Access: Off

GENERAL PARAMETERS
11. Supervisor Mode:  Permit
12. Logoff Char:      ^X
13. Sequence Disc:   One Char
14. Inact Timeout:    5 Min
15. Command Echo:    On
16. Accept Break:    On

RSM>

```

Figure 6.5: Port Parameters Screen (Network Port Shown)

6.4. The Port Parameters Screens (/W)

The /W (Who) command displays more detailed information about an individual RSM port. Rather than listing general connection information for all ports, the Port Parameters screen lists all defined parameters for a specific port.

The Port Parameters Screens are available to accounts that permit Supervisor commands and accounts that do not permit Supervisor commands. Note however, that if your account that does not permit Supervisor commands, the RSM will only display information for the port from which you have logged in.

The /W command can be applied to either an RS232 Port or the Network Port. Figure 6.4 shows the screen displayed when the /W command is applied to an RS232 Port, and Figure 6.5 shows the screen displayed when an account that permits Supervisor commands applies the /W command to the Network Port.

The /W command uses the following format:

/w xx [Enter]

Where **xx** is the desired port number. If the /W command is invoked at a serial port, by a user with access to Supervisor Level commands, then the letter "n" can be entered as the command argument to display parameters for the Network Port.

Note: *When command mode is accessed via the Network Port using an account that does not permit Supervisor commands, the /W command will only display the Sequence Disconnect, Logoff Character, and the status of the Accept Break item.*

7. Operation

This section discusses the procedures for connecting and disconnecting ports, and describes the various port modes.

Note: *The Web Browser Interface cannot be used to connect or disconnect ports. In order to connect or disconnect ports, you must access command mode via the Text Interface.*

7.1. Any-to-Any Mode

Any-to-Any Mode Ports can be connected to other Any-to-Any, Passive, Buffer, or Modem Mode ports by accessing command mode via the Text Interface and issuing the /C Command. All ports can be configured for +Any-to-Any Mode, and it is also the default mode for Ports 1 and 2.

7.1.1. Port Connection and Disconnection

The RSM allows communication between devices without the requirement that both ports use the same communication parameters.

7.1.1.1. Connecting Ports

Two different types of connections can be made between RSM ports; Resident Connections and Third Party Connections.

- **Resident Connections:** Your resident port issues a /C command to connect to a second port. For example, Port 4 issues the /C command to connect to Port 5.
- **Third Party Connections:** (Supervisor Only) Your resident port issues a /C command to create a connection between two *other* ports. For example, Port 1 is your resident port, and Port 1 issues a command to connect Port 2 to Port 3.

Notes:

- *Third Party Connections can only be initiated by accounts and ports that permit Supervisor commands.*
- *The RS232 Ports cannot employ the /C command to initiate a connection to the Network Port.*
- *If your account does not permit Supervisor commands, you will only be able to connect to ports allowed by your account. Accounts with Supervisor access are allowed to connect to all RS232 ports.*

To Connect ports, proceed as follows:

1. Access command mode via the Text Interface.
2. Invoke the /C command to connect the desired ports.
 - a) **Resident Connect:** To connect your resident port to another port, type /C **xx** [Enter]. Where **xx** is the number or name of the port you want to connect. The RSM will display the numbers of the connected ports, along with the command required in order to disconnect the two ports.
Example: To connect your resident port to Port 8, type /C 8 [Enter].
 - b) **Third Party Connect:** (Supervisors Only) To connect any two ports (other than your resident port), type /C **xx xx** [Enter]. Where **xx** and **xx** are two port names or numbers. The RSM will display the numbers of the two connected ports.
Example: To connect Port 5 to Port 6, access command mode at a third port that permits Supervisor commands (using an account that also permits supervisor commands), and invoke the following command: /C 5 6 [Enter].

Notes:

- **Resident Connections:** *RS232 Ports are not allowed to initiate a Resident Connection to the Network Port.*
- **Third Party Connections:** *RS232 Ports are not allowed to connect another port to the network port. For example, Port 1 is not allowed to connect Port 3 to the Network Port.*

When the /C command specifies the port name, it is only necessary to enter enough letters to differentiate the desired port from other ports. Type an asterisk (*) to represent the remaining characters in the port name. For example, to connect your resident port to a port named "SALES", the connect command can be invoked as /C **s***, providing no other port names begin with the letter "S".

7.1.1.2. Disconnecting Ports

There are three different methods for disconnecting ports, the Resident Disconnect, the Third Party Disconnect, and the No Activity Timeout. Providing the Timeout feature is enabled, a No Activity Timeout will disconnect resident ports or third party ports.

Note: The "DTR Output" option in the Port Parameters menu determines how DTR will react when the port disconnects. DTR can be held low, held high, or pulsed and then held high.

1. **Resident Disconnect:** Disconnects your resident port from another port. For example, if you are communicating via Port 3, and Port 3 is connected to Port 4, a Resident Disconnect is used to disassociate the two ports. The RSM offers two different disconnect command formats; the One Character Format and the Three Character Format (for more information, please refer to Section 5.7.2.):

Note: The Resident Disconnect methods discussed here cannot be used to terminate a Telnet Direct Connection. For more information, please refer to Section 8.3.4.

- a) **One Character (Default):** Enter the logoff character once (Default = [Ctrl] plus [X]). It is not necessary to enter a carriage return before or after the logoff character.
 - b) **Three Characters:** Uses the "[Enter]LLL[Enter]" format, where L is the logoff character. For example, if the logoff character is "+", then the disconnect sequence is [Enter]+++[Enter].
 - c) If the default disconnect command is not compatible with your application, both the command format and logoff character can be redefined via the Port Configuration menus, as described in Section 5.7.2.
2. **Third Party Disconnect:** (Supervisors Only) The /D command is issued from your resident port to disconnect two other ports. For example, if your Resident Port is Port 1, a Third Party Disconnect is used to disconnect Ports 3 and 4.

Note: The Third Party Disconnect method can be used to terminate a Telnet Direct Connection. For more information, please refer to Section 8.3.4.

- a) The /D command uses the format: /D xx xx [Enter], where xx and xx are the numbers of the ports you wish to disconnect.
- b) The /D (Disconnect) command can only be invoked by accounts and ports that permit Supervisor commands.

- c) The /D command can specify both connected ports, or either of the two ports. For example, if Port 1 is your resident port, any of the following commands can be used to disconnect Port 3 from Port 4:

/D 3 4 [Enter]

or

/D 3 [Enter]

or

/D 4 [Enter]

- d) The /D command can also disconnect a remote user from the Network Port. This is useful in cases where a user has unsuccessfully disconnected via Telnet, and you can't wait for the RSM to timeout in order to free up the TCP port. To disconnect a TCP port, type /D **Nn** and then press [Enter]. Where **Nn** is one of the RSM's logical TCP ports (e.g. /D **N2** [Enter]).
3. **No Activity Timeout:** Providing the Timeout feature is enabled at either connected port, the No Activity Timeout can disconnect Resident Ports, or Third Party Ports.

Note: *The No Activity Timeout also applies to Telnet Direct Connections. For more information, please refer to Section 8.3.*

- a) **RS232 Ports:** To select the timeout period for RS232 Ports, access the Port Configuration Menu for the desired port as described in Section 5.7.2.
- b) **Network Port:** To select the timeout period for the Network Port, access the Network Port Configuration Menu as described in Section 5.8.
- c) When the Timeout Feature is enabled, the port will automatically disconnect if no data is received during the defined Timeout Period.

Notes:

- *When two connected ports time out, both ports will exit command mode after disconnecting.*
- *The Timeout value also applies to unconnected ports that are left in command mode. When an unconnected port is left in command mode, and no additional activity is detected, the port will automatically exit command mode when its timeout value elapses.*

7.1.2. Defining Hunt Groups

A Hunt Group creates a situation where the RSM will scan a group of similarly named ports and connect to the first available port in the group. Hunt Groups are created by assigning identical or similar names to two or more ports. Hunt Groups can be defined using Any-to-Any, Passive, Buffer, or Modem Mode Ports. Note that the Network Port *cannot* be included in Hunt Groups.

1. Access command mode using a port and account that permit Supervisor commands.
2. Access the Port Configuration Menu for the desired Port(s) as described in Section 5.7.2.
3. From the Port Configuration Menu, define the Port Name.
4. Repeat steps 2 and 3 to assign identical names to the other ports in the Hunt Group. For example, a series of ports in a group could all be named "SERVER".
5. To connect to the next available port in the hunt group, invoke the /C command using the port name to specify the desired group. For example, /C SERVER [Enter].
6. Your port will be connected to the first available port in the group. If all ports are presently connected, the RSM will respond with the "BUSY" message.
7. It is only necessary to enter enough letters of the port name to differentiate Hunt Group ports from other ports. Type an asterisk (*) to represent the remaining characters in the name. For example, to connect to the first available port in a group of ports named "SALES1", "SALES2", and "SALES3", the connect command can be invoked as /C s* [Enter], providing no other port names begin with the letter "S".

Notes:

- *If the Hunt Group method is used by a port or account that does not permit Supervisor commands, the /C command will only connect to the ports allowed by that user account.*
- *Hunt Group port names must be unique. Otherwise, ports with similar names will also be included in the Hunt Group.*

Hunt Group Example 1:

1. Ports 1 and 2 are Modem Mode ports, and modems are installed at both ports. Port 1 is named "MODEM1" and Port 2 is named "MODEM2".
2. Your resident port is Port 4. To connect to the first available Modem, type /C MODEM* [Enter].

Hunt Group Example 2:

1. Ports 3, 4, and 5 are Any-to-Any Mode ports. All three ports are named "SERVER".
2. Your resident port is Port 1. If you want to connect Port 2 to the first available server, type /C 2 SERVER [Enter].

7.2. Passive Mode

Passive Mode Ports function the same as Any-to-Any Mode Ports, but do not allow access to command mode. A Passive Mode Port can communicate with other ports, but cannot enter command mode, and therefore cannot redefine parameters, display status, or connect or disconnect ports. The Passive Mode is the default at Serial Ports 3 and above.

Passive Mode Ports can be connected by accessing command mode from a free Any-to-Any or Modem Mode Port, and invoking the Third Party Connect or Resident Connect Command as described in Section 7.1.1. Passive Mode ports will not buffer data, except during baud rate conversion.

Note: *In order to ensure Supervisor access to important command functions, the Passive Mode is not available to Port 1 (the SetUp Port.)*

7.3. Buffer Mode

The Buffer Mode allows collection of data from various devices without the requirement that all devices use the same communication parameters (e.g. baud rate, parity, etc.). In addition, Buffer Mode ports can also be configured to support the SYSLOG and SNMP Trap functions, as described in Sections 9 and 10.

Notes:

- *Buffer Mode Ports cannot access command mode.*
- *Buffer Mode is not available to Port 1 (the SetUp Port) or the Network Port.*

7.3.1. Reading Data from Buffer Mode Ports

To check port buffers for stored data, access command mode via the text interface, using an account and port that permit Supervisor commands, and type `/s [Enter]` to display the Port Status Screen. The "Buffer Count" column in the Port Status Screen indicates how much data is currently being stored for each port.

To retrieve data from buffer memory, go to a free Any-to-Any or Modem Mode Port, then issue the `/R xx [Enter]`. Where `xx` is the number of the port buffer to be read.

Notes:

- *In order to read data from a given port, your account must allow access to that port.*
- *When the `/R` command is invoked, the counter for the SNMP Trap function will also be reset.*

If the buffer contains data, the RSM will display a prompt that offers the following options:

- **Display One Screen:** To send data one screen at a time, press `[Enter]`. Each time `[Enter]` is pressed, the next screen is sent.
- **Display All Data:** To send all data currently stored in the buffer, type 1 and press `[Enter]`.
- **Erase Data on Screen:** To erase the data currently displayed on-screen, type 2 and press `[Enter]`.
- **Erase all Data:** (Supervisor Only) To erase all data currently stored in the buffer, type 3 and press `[Enter]`.
- **Exit:** To exit from Read Buffer mode, press `[Esc]`.

Note: *Only one user can read from a port buffer at a time. If a second user attempts to read from a port that is already being read, an error message will be sent.*

To clear data from any port buffer (with or without reading it first), access command mode via the text interface, using an account and port that permit Supervisor commands, then issue the /E (Erase Buffer) command using the following format:

/E xx [Enter]

Where **xx** is the number of the port buffer to be cleared.

Note: *The /E command cannot erase data from a port buffer that is currently being read by another port.*

7.3.2. Port Buffers

The Status Screen lists the amount of Buffer Memory currently used by each port. The RSM uses buffer memory in two different ways, depending on the user-selected port mode.

- **Any-to-Any, Passive, and Modem Mode Ports:** When two ports are communicating at dissimilar baud rates, the buffer memory prevents data overflow at the slower port.
- **Buffer Mode Ports:** Stores data received from connected devices. The user issues a Read Buffer command (/R) from an Any-to-Any or Modem Mode port to retrieve data.

If the Status Screen indicates an accumulation of data, the /E (Erase Buffer) command can be invoked to clear the buffer.

Note: *When a Buffer Mode port is reconfigured as an Any-to-Any, Passive, or Modem Mode port, any data stored in the buffer prior to changing the port mode will be lost.*

7.4. Modem Mode

The Modem Mode provides features specifically related to modem communication. A Modem Mode Port can perform all functions normally available in Any-to-Any Mode. The Modem Mode is available to all RSM ports except the Network Port, and is the default port mode at the Internal Modem port.

When Modem Mode is selected, the Port Configuration menu will display three additional prompts, which allow you to re-define the modem reset string, initialization string, and hang-up string.

When a call is received, the unit will prompt the caller to enter a username and password. The RSM allows three attempts to enter a valid username and password. If a valid username and password is not entered within three attempts, or if the user does not respond to the login prompt within 30 seconds, the modem will disconnect.

Notes:

- *When a Modem Mode port exits command mode, or the DCD line is lost while command mode is active, the RSM will pulse DTR to the modem. The unit will then send the user-defined modem command strings to make certain the modem is properly disconnected and reinitialized.*
- *When an external modem is installed at an RSM port, other ports can use the modem for calling out. To call out, invoke the /C command to connect to the port, then access the modem as you normally would.*
- *If desired, the Invalid Access Lockout feature can provide additional security for Modem Mode ports. When properly configured, the Invalid Access Lockout will automatically shut down a port whenever that port exceeds the user defined number of invalid access attempts. For more information, please refer to Section 5.4.2.*

8. Telnet & SSH Functions

8.1. Network Port Numbers

Whenever an inbound Telnet or SSH session connects to an RSM RS232 Port, the Port Status Screen and Port Diagnostics Screen will indicate that the RS232 port is presently connected to Port "Nn" (where "N" indicates a network connection, and "n" is a number that lists the logical Network Port being used; for example, "N11".) This "Nn" number is referred to as the logical Network Port Number.

8.2. SSH Encryption

In addition to standard Telnet protocol, the RSM also supports SSH connections, which provide secure, encrypted access via network. In order to communicate with the RSM using SSH protocol, your network node must include an appropriate SSH client.

Note that when the /K (Send SSH Key) command is invoked, the RSM can also provide you with a public SSH key, which can be used to streamline connection to the RSM when using SSH protocol.

Although you can establish an SSH connection to the unit *without* the public key, the public key provides validation for the RSM, and once this key is supplied to the SSH client, the client will no longer display a warning indicating that the RSM is not a recognized user when the client attempts to establish a connection.

The /K command uses the following format:

/K <k> [Enter]

Where **k** is an argument that determines which type of public key will be displayed, and the **k** argument offers the following options:

1. SSH1
2. SSH2 RSA
3. SSH2 DSA

For example, to obtain the public SSH key for an SSH2 RSA client, type /K 2 and then press [Enter].

Note: *Although the RSM does not support SSH1, the /K 1 command will still return a key for SSH1.*

8.3. The Direct Connect Feature

The Direct Connect feature allows you to initiate a Telnet, SSH or Raw Socket session with the RSM and make an immediate connection to a specific RS232 Port of your choice, without first being presented with the command interface. This allows you to connect to a TCP port that is mapped directly to one of the RSM's RS232 Serial Ports.

Direct Connect employs unique, pre-assigned TCP port numbers for each RS232 Port. The user connects to the port of choice by including the associated TCP port number in the Telnet or SSH connect command line.

The Direct Connect feature can be individually configured at each RS232 Port and can be used to connect to Any-to-Any, Passive, Buffer, or Modem Mode ports.

8.3.1. Standard Telnet Protocol, SSH and Raw Socket

The Direct Connect feature allows you to establish port connections using either Standard Telnet Protocol, SSH encryption or Raw Socket. When Standard Telnet Protocol is used, the RSM will respond to all IACs.

When configuring a port to allow Direct Connections using SSH protocol, note that the Direct Connect option (Port Configuration Menu, Item 31), must be set to "On - Password" as described in Section 8.3.2.

When configuring a port to allow Direct Connections using either Standard Telnet or Raw Socket Mode, note that the Direct Connect option (Port Configuration Menu, Item 31) may be set to either "On - Password" or "On - No Password".

8.3.2. Configuration

The Direct Connect Function is configured on a per port basis using the Port Configuration Menus (/P nn), item 13, "Direct Connect". The following options are available:

1. **Direct Connect OFF:** Direct Connect disabled at this port. (Default)
2. **Direct Connect ON - NO PASSWORD:** The Direct Connect feature is enabled at this port, but no password is required in order to connect to the port.
 - a) When the Telnet connection is established, the user is immediately connected directly to the specified port, and the client is notified at the TCP level.
 - b) This option is intended for situations where security is provided by the attached device.

Note: *The SSH Direct Connection function is disabled when the "On - No Password" option is selected.*

3. **Direct Connect ON - PASSWORD:** The Direct Connect feature is enabled at this port, but a password must be entered before a Direct Connection is established.
 - a) Upon login, the RSM will prompt for a username and password. If a valid username/password is entered, the RSM will return a message which confirms the connection and lists the name and number of the port (providing the user account allows access to the target port.)
 - b) If a valid username / password is not entered in 30 seconds or three attempts, the port will timeout and disconnect.

Notes:

- *If you intend to use SSH to establish direct connections to the RSM, the "Direct Connect ON - PASSWORD" option must be selected.*
- *If Supervisor commands are disabled at the Network Port, then accounts that permit Supervisor commands will not be able to initiate a Direct Connection.*
- *If Supervisor commands are enabled at the Network Port, then accounts with Supervisor access and accounts without Supervisor access will both be allowed to establish Direct Connections.*
- *If your user account does not permit access to the target port, the connection will be refused.*

8.3.3. Connecting to an RS232 Port using Direct Connect

Direct Connect TCP port numbers are as follows:

1. **Standard Telnet Direct Connection (with Password):**
 - a) **RSM-8:**
 - Serial Ports: TCP port numbers 2101 through 2108.
 - Internal Modem Port: TCP port number 2109.
 - b) **RSM-16 & RSM-16DC:**
 - Serial Ports: TCP port numbers 2101 through 2116.
 - Internal Modem Port: TCP port number 2117.
 - c) **RSM-32 & RSM-32DC:**
 - Serial Ports: TCP port numbers 2101 through 2132.
 - Internal Modem Port: TCP port number 2133.
2. **Standard Telnet Direct Connection (without Password):**
 - a) **RSM-8:**
 - Serial Ports: TCP port numbers 2301 through 2308.
 - Internal Modem Port: TCP port number 2309.
 - b) **RSM-16 & RSM-16DC:**
 - Serial Ports: TCP port numbers 2301 through 2316.
 - Internal Modem Port: TCP port number 2317.
 - c) **RSM-32 & RSM-32DC:**
 - Serial Ports: TCP port numbers 2301 through 2332.
 - Internal Modem Port: TCP port number 2333.
3. **SSH Direct Connection (with Password):**
 - a) **RSM-8:**
 - Serial Ports: TCP port numbers 2201 through 2208.
 - Internal Modem Port: TCP port number 2209.
 - b) **RSM-16 & RSM-16DC:**
 - Serial Ports: TCP port numbers 2201 through 2216.
 - Internal Modem Port: TCP port number 2217.
 - c) **RSM-32 & RSM-32DC:**
 - Serial Ports: TCP port numbers 2201 through 2232.
 - Internal Modem Port: TCP port number 2233.

4. **Raw Socket Direct Connection (with Password):**
 - a) **RSM-8:**
 - Serial Ports: TCP port numbers 3101 through 3108.
 - Internal Modem Port: TCP port number 3109.
 - b) **RSM-16 & RSM-16DC:**
 - Serial Ports: TCP port numbers 3101 through 3116.
 - Internal Modem Port: TCP port number 3117.
 - c) **RSM-32 & RSM-32DC:**
 - Serial Ports: TCP port numbers 3101 through 3132.
 - Internal Modem Port: TCP port number 3133.
5. **Raw Socket Direct Connection (without Password):**
 - a) **RSM-8:**
 - Serial Ports: TCP port numbers 3301 through 3308.
 - Internal Modem Port: TCP port number 3309.
 - b) **RSM-16 & RSM-16DC:**
 - Serial Ports: TCP port numbers 3301 through 3316.
 - Internal Modem Port: TCP port number 3317.
 - c) **RSM-32 & RSM-32DC:**
 - Serial Ports: TCP port numbers 3301 through 3332.
 - Internal Modem Port: TCP port number 3333.

When establishing a Direct Connection, the correct TCP port number must be used. If conditions are acceptable (e.g. Target Port must be free and properly configured), an immediate connection will be made, with one possible exception; password entry may first be required depending on configuration settings.

Note: *When a Direct Connect attempt fails because the Port is busy, the call is rejected at the TCP level.*

Connection Example

1. Assume that Port 8 is configured as described in Section 8.3.2. If the RSM's IP address is "1.2.3.4", and you wish to establish a standard Telnet protocol connection with port 8 (TCP Port Number 2108), then on a UNIX system, the connect command would be invoked as follows:

```
$ telnet 1.2.3.4 2108 [Enter]
```

2. The RSM will first send the site ID, Port Number, Port Name, and Telnet Port number, and then once a connection is established, the "Connected" message will be sent.

8.3.4. Terminating a Direct Connect Session

To terminate a Direct Connect session, use the client program's "disconnect" feature. The following will occur immediately upon a client initiated disconnect:

1. The Network port is disconnected from the RS232 Port.
2. The Network session is terminated.
3. The RS232 Port is put to sleep.

Notes:

- *The Sequence Disconnect Command, which is defined via the Port Configuration menus, cannot be used to terminate a Direct Connection.*
- *Any RSM port that allows Supervisor commands can terminate a direct connection at another port by issuing the /D command as described in Section 7.1.1.*
- *Acknowledgment of data received by the RSM network port does not automatically indicate that the data has been completely sent out the serial port. Data may still be queued in RSM buffers. Any data queued at the time of a client initiated disconnect is discarded, and is not passed to the attached device.*

9. The Syslog Feature

The Syslog feature can create time-stamped log records of each buffer event. As these event records are created, they are sent to a Syslog Daemon, located at an IP address defined via the Network Parameters menu.

Note:

- *The Syslog Function is only available to Buffer Mode ports.*
- *This option is not available to RS232 Port 1, which is reserved as a System SetUp Port, and therefore cannot be configured as a Buffer Mode Port.*

9.1. Configuration

The Syslog function is individually configured for each RSM RS232 Port. If you wish to employ this feature, it must be enabled at each desired port using the Port Parameters menus. You must also set the real-time clock and calendar via the System Parameters Menu, and define the IP address for the Syslog Daemon via the Network Port Configuration menu.

To configure the Syslog function, please proceed as follows:

1. Access command mode. Note that the following configuration menus are only available to accounts and ports that permit Supervisor commands.
2. **System Parameters Menu:** Type /F [Enter] to access the System Parameters Menu. Set the following parameters:
 - a) **Set Clock and Calendar:** Use the Systems Parameters menu to set the Real Time Clock and Calendar and/or configure and enable the NTP server feature. If desired, the RSM can time stamp each Syslog message that is sent, as described in Step 4.
3. **Port Parameters Menu:** Access the Port Parameters Menu for the desired port as described in Section 5.7.2, and then set the following parameters:
 - a) **Port Mode:** Set the Port Mode to "Buffer."
 - b) **Syslog Function:** Enable the Syslog Function. The Syslog Function allows you to select either "On - Not Connected" (messages are only sent when a user is *not* connected to the Buffer port) or "On - Always" (all captured data is sent, whether a user is connected to the Buffer port or not.)
 - c) **Syslog Facility and Level:** If desired, set the Facility and Level (priority) for messages sent by this port.

4. **Network Parameters Menu:** Access the Network Parameters Menu as described in Section 5.8, then set the following parameters:
 - a) **Syslog IP Address:** Determine the IP address for the device that will run the Syslog Daemon, then use the Network Port Configuration menu to define the IP Address for the Syslog Daemon.
 - b) **Syslog Date-Time:** If desired, you may wish to enable automatic time/date stamping of all Syslog messages generated by the RSM. This is often useful if your Syslog Daemon does not perform time/date stamping itself.
5. **Syslog Daemon:** In order to capture messages sent by the RSM, a computer must be running a Syslog Daemon (set to UDP Port 514) at the IP address specified in Step 4 above.

9.2. Criteria for Generating a Syslog Message

Once the RSM is properly configured, Syslog messages will be generated as follows:

1. **Data Terminated by NULL Character:** Syslog will generate a message whenever a properly configured Buffer Mode Port receives data or text terminated by a NULL character (0x00). The message sent to the Syslog Daemon will contain header information and the event (buffered data or text) captured by the RSM. Note that the event written to the buffer port will also be retained.

If a Buffer Mode Port receives data or text that is *not* terminated by a NULL character, it will *not* be sent out as a Syslog message, but will be retained by the buffer, providing the maximum Syslog message size (described in item 2 below) is not exceeded. This prevents the RSM from sending spurious characters that do not represent actual text or data.
2. **Maximum Syslog Message Size Reached:** Syslog messages are limited to 1024 bytes (including the header). Therefore, if data or text in the buffer exceeds this limit, the queued message will be sent immediately, and the rest of the data will be accumulated and forwarded in another, subsequent message; either when a NULL is detected, or when the accumulated data (plus header) again reaches 1024 bytes.
3. **Audit Log:** If the System Parameters menu has been used to set the Audit Log feature for the "On - with Syslog" option, then a Syslog message will be sent each time that an Audit Log record is generated. Audit Log records will be generated whenever a user connects or disconnects from a port, whenever a user enters or exits from command mode, and whenever a user session is disconnected due to a time out.
4. The Port Parameters Menus are used to enable/disable the Syslog feature at each port, and also to determine whether or not messages will be sent while a user is connected to the port. As described in Section 5.7.2, the Syslog feature can be set to either send all information captured by the port, or to stop sending messages when a user is connected to that port.

```
TEST NETWORK OPTIONS:

1. SNMP Trap Test Manager 1
2. SNMP Trap Test Manager 2
3. Syslog Test
4. Ping

Enter: #<CR> to select,
      <ESC> to exit ...
```

Figure 9.1: The Test Menu (Text Interface, Supervisor Mode Only)

9.3. Testing Syslog Configuration

After you have configured the RSM as described in Section 9.1, the `/TEST` command can be used to make certain that the function is properly set up. To test the Syslog function, access the RSM command mode via the text interface, then type `/TEST` and press **[Enter]** to display the Test Menu shown in Figure 9.1.

When the Syslog Test feature is selected, the RSM will attempt to send a test Syslog message, using the current Syslog configuration. If the test message is not received by your Syslog Daemon, review the procedure outlined in Section 9.1 to make certain the RSM and the Syslog Daemon are properly configured.

In addition to providing a means to test the Syslog and SNMP Trap features, the Test Menu also includes a Ping command option, which can be used in a manner similar to the DOS ping command to check to make certain that the unit is communicating properly. Note that in order for the Ping command to function with domain names, you must first configure Domain Name Server parameters as described in Section 5.8.5.

10. SNMP Traps

SNMP is an acronym for "Simple Network Management Protocol". The SNMP Trap function allows Buffer Mode Ports to send a message to two different SNMP Managers, indicating the amount of data currently stored in buffer memory.

Note:

- *The SNMP Trap function is only available to Buffer Mode Ports.*
- *This option is not available to RS232 Port 1, which is reserved as a "System SetUp Port", and therefore, cannot be configured as a Buffer Mode Port.*
- *The SNMP feature cannot be configured via the SNMP Manager.*
- *SNMP reading ability is limited to the System Group.*
- *The SNMP feature includes the ability to be polled by an SNMP Manager.*
- *When the /R command is invoked, the counter for the SNMP Trap function will automatically be reset.*

10.1. Configuration:

The SNMP Trap function is individually configurable for RS232 Ports 2 and above. If you wish to employ this feature it must be enabled at each desired port. To configure the SNMP Trap function, proceed as follows:

1. Access command mode using an account and port that permit Supervisor commands.
2. **Port Parameters Menu:** Access the Port Parameters Menu for the desired port as described in Section 5.7.2, and then set the following parameters:
 - a) **Port Mode:** Set the Port Mode to "Buffer".
 - b) **SNMP Trap Level:** Enable the SNMP Trap function and select the byte level. The byte level determines the number of bytes the buffer must contain in order to cause an SNMP trap to be sent. Note that when the byte level is set to "0" (zero), the SNMP Trap function is disabled.

3. **Network Parameters Menu:** Access the Network Parameters Menu as described in Section 5.8. Set the following:
 - a) **Enable:** SNMP Access must be enabled in order for SNMP traps to function.
 - b) **SNMP Contact:** (Optional.)
 - c) **SNMP Location:** (Optional.)
 - d) **SNMP Community:** Consult your network administrator, and then use the Network Parameters menu to set the SNMP Community.
 - e) **SNMP Managers 1 and 2:** Consult your network administrator to determine the IP address(es) for the SNMP Manager(s), then use the Network Parameters menu to set the IP address for each SNMP Manager. Note that it is not necessary to define both SNMP Managers.
 - f) **Trap Community:** Consult your network administrator, and then use the Network Parameters menus to set the Trap Community.

10.2. SNMP Trap Message

The trap messages which are sent to the SNMP Managers will appear as follows:

```
RSM Port Buffer. RSM Site ID: [site id], Port: [port number], [byte level]
byte trigger level reached.
```

10.3. How and When SNMP Traps are Sent

1. When the buffer port reaches the trigger level, SNMP Traps are immediately sent to each defined SNMP manager. SNMP uses the UDP protocol (an "unreliable" protocol). Successful manager receipt of traps are assisted by the following:
 - a) The RSM verifies that the ARP table is updated completely before sending a trap to each manager defined.
 - b) The user may choose to use the 2nd manager as a "backup" in the event that the 1st manager fails.
2. When an SNMP trap is sent to a manager for a particular port, the RSM also sets a one hour timer for that port:
 - a) If, during the hour, the buffer *never* drops below the trap level, then SNMP Traps are resent and the timer is reset.
 - b) If, during the hour, the buffer *does* drop below the trap level, the timer is immediately cleared. No more traps will be sent unless the buffer level once again exceeds the trap trigger level.

10.4. Testing the SNMP Trap Function

After you have finished setting up the SNMP Trap function, it is recommended to test the configuration to ensure that it is working correctly. To test configuration of the SNMP Trap function, proceed as follows:

1. Configure the SNMP Trap function as described in Section 10.1.
2. Access the Text Interface command mode using an account and port that permit Supervisor commands, then invoke the `/TEST` command at the RSM command prompt. Note that the `/TEST` Command is only available in Supervisor Mode.
3. Select Item 1 or 2 to send an SNMP test trap to Manager 1 or 2, respectively. It is possible that the ARP table will not be properly setup. If this occurs a message to that effect is displayed and the RSM immediately refreshes the ARP table. Repeat steps 2 and 3 to try again.

For more information on the `/TEST` command and the Test Menu, please refer to Section 9.3.

11. Saving and Restoring Configuration Parameters

Once the RSM is properly configured, parameters can be downloaded and saved as an ASCII text file. Later, if the configuration is accidentally altered, the saved parameters can be uploaded to automatically reconfigure the unit without the need to manually assign each parameter.

Saved parameters can also be uploaded to other RSM units, allowing rapid set-up when several units will be configured with the same parameters.

The "Save Parameters" procedure can be performed from any terminal emulation program (e.g. HyperTerminal, TeraTerm, etc.), that allows downloading of ASCII files.

Note: *The Save and Restore features described in this section are only available via the Text Interface.*

11.1. Sending Parameters to a File

1. Start your terminal emulation program (e.g. HyperTerminal) and access the Text Interface command mode using an account and port that permit Supervisor commands.
2. When the command prompt appears, type `/U` and press **[Enter]**. The RSM will prompt you to configure your terminal emulation program to receive an ASCII download.
 - a) Set your terminal emulation program to receive an ASCII download, and the specify a name for a file that will receive the saved parameters (e.g. RSM.PAR).
 - b) Disable the Line Wrap function for your terminal emulation program. This will prevent command lines from being broken in two during transmission.
3. When the terminal emulation program is ready to receive the file, return to the RSM's Save Parameter File menu, and press **[Enter]** to proceed. RSM parameters will be saved on your hard drive in the file specified in Step 2 above.
4. The RSM will send a series of ASCII command lines which specify currently selected parameters. The last line of the file should end with a `/G-00` command. When the download is complete, press **[Enter]** to return to the command prompt.

11.2. Restoring Saved Parameters

This section describes the procedure for using your terminal emulation program to send saved parameters to the RSM.

1. Start your terminal emulation program and access the RSM's Text Interface command mode using an account and port that permit Supervisor commands.
2. Configure your terminal emulation program to upload an ASCII text file.
3. Upload the ASCII text file with the saved RSM parameters. If necessary, key in the file name and directory path.
4. Your terminal emulation program will send the ASCII text file to the RSM. When the terminal program is finished with the upload, make certain to terminate the Upload mode.

Note: *If the RSM detects an error in the file, it will respond with the "Invalid Parameter" message. If an error message is received, carefully check the contents of the parameters file, correct the problem, and then repeat the Upload procedure.*

5. If the parameter upload is successful, the RSM will send a confirmation message, and then return to the command prompt. Type `/s` and press **[Enter]**, the Status Screen will be displayed. Check the Status Screen to make certain the unit has been configured with the saved parameters.

12. Upgrading RSM Firmware

When new, improved versions of the RSM firmware become available, the "Upgrade Firmware" function can be used to update the unit. Updates can be uploaded via FTP or SFTP protocols.

Notes:

- *The FTP/SFTP servers can only be started via the Text Interface.*
 - *All other ports will remain active during the firmware upgrade procedure.*
 - *If the upgrade includes new parameters or features not included in the previous firmware version, these new parameters will be set to their default values.*
1. Obtain the update file. Firmware modifications can either be mailed to the customer on a CDR, or downloaded from WTI. Place the upgrade CDR in your disk drive or copy the file to your hard drive.
 2. Access Text Interface command mode via Serial Port, Telnet or SSH client session, using a username/password and port that permit Supervisor commands.
 3. When the command prompt appears, type `/UF` and then press **[Enter]**. The RSM will display a screen which offers the following options:
 - a) **Start FTP/SFTP Servers and Save Parameters:** To proceed with the upgrade, while retaining user-defined parameters, type 1 and press **[Enter]**. All existing parameter settings will be restored when the upgrade is complete.
 - b) **Start FTP/SFTP Servers and Default Parameters:** To proceed with the upgrade, and reset parameters to default settings, type 2 and press **[Enter]**. When the upgrade is complete, all parameters will be set to default values.
 - c) **Abort Upload:** To cancel the upgrade and return to the command prompt, type 3 and press **[Enter]**.

Note that if either option 1 or option 2 are selected, the RSM will start the receiving servers and wait for an FTP/SFTP client to make a connection and upload a valid firmware binary image.
 4. To proceed with the upgrade, select either option 1 or option 2. The RSM will display a message that indicates that the unit is waiting for data. Leave the current Telnet/SSH client session connected at this time.

5. Open your FTP/SFTP application and login to the RSM unit, using a username and password that permit access to Supervisor Level commands.
6. Transfer the binary format upgrade file to the RSM.
7. After the file transfer is complete, the RSM will install the upgrade file and then reboot itself and break all port connections. Note that it will take approximately 7 to 10 minutes to complete the installation process. The unit will remain accessible until it reboots.
 - a) Some FTP/SFTP applications may not automatically close when the file transfer is complete. If this is the case, you may close your FTP/SFTP client manually after it indicates that the file has been successfully transferred.
 - b) When the upgrade process is complete, the RSM will send a message to all currently connected network sessions, indicating that the RSM is going down for a reboot.

Note: *Do not power down the RSM unit while it is in the process of installing the upgrade file. This can damage the unit's operating system.*

8. If you have accessed the RSM via the Network Port, in order to start the FTP/SFTP servers, the RSM will break the network connection when the system is reinitialized.
 - If you initially selected "Start FTP/SFTP Servers and Save Parameters", you may then reestablish a connection with the RSM using your former IP address.
 - If you initially selected "Start FTP/SFTP Servers and Default Parameters", you must then login using the RSM's default IP address (Default = 192.168.168.168) or access command mode via Serial Port 1 or 2 or via Modem.

When firmware upgrades are available, WTI will provide the necessary files via download or mailed CDR. At that time, an updated Users Guide or addendum will also be available.

13. Command Reference Guide

13.1. Command Conventions

Most commands described in this section conform to the following conventions:

- **Text Interface:** Commands discussed in this section, can only be invoked via the Text Interface. These commands *cannot* be invoked via the Web Browser Interface.
- **Slash Character:** Most RSM commands begin with the Slash Character (/).
- **Apply Command to All Ports:** When an asterisk is entered as the argument of the /D (Disconnect) or /E commands (Erase Buffer) the command will be applied to all ports. For example, to erase all port buffers, type /E * [Enter].
- **Port Name Wild Card:** It is not always necessary to enter the entire port name. Port names can be abbreviated in command lines by entering the first character(s) of the name followed by an asterisk (*). For example, a port named "SERVER" can be specified as "s*". Note however, that this command would also be applied to any other port name that begins with an "S".
- **Suppress "Sure?" Prompt:** When the /D (Disconnect) or /E (Erase Buffer) commands are invoked, the /Y option can be included to override the "Sure?" prompt. For example, to disconnect Port 8 without displaying the Sure prompt, type /D/Y 8 [Enter].
- **Enter Key:** Most commands are invoked by pressing [Enter].
- **Connected Ports:** When two ports are connected, most RSM commands will not be recognized by either of the connected ports. The only exception is the Resident Disconnect Sequence (Default = ^x ([Ctrl] plus [X]).)
- **Configuration Menus:** To exit from a configuration menu, press [Esc]. The only exception to this rule is the Copy Parameters Menu (/CP), and in that case the [Esc] key is used to confirm the copy operation.

13.2. Command Summary

Function	Command Syntax	Command Availability	
		Supervisor	Non-Super.
Resident Disconnect ¹	^X	X	X
Display Audit Log	/A [search text] [Enter]	X	
Connect	/C <x> [x] [Enter]	X	X ²
Copy RS232 Port Parameters	/CP [Enter] /CP [x,y,z] [Enter] /CP [x-z] [Enter]	X	
Third Party Disconnect ³	/D[/Y] <x> [x] [Enter] /D[/Y] * [Enter] /D Nn [Enter]⁴	X	
Erase Buffer	/E[/Y] <x> [x] [Enter] /E[/Y] * [Enter]	X	
Set System Parameters	/F [Enter]	X	
Help Menu	/H [Enter]	X	X
Reboot System (Default)	/I [Enter]	X	
Display Site ID	/J [Enter]	X	X
Send SSH Keys	/K <k> [Enter]	X	
Set Network Port Parameters	/N [Enter]	X	
Set Serial Port Parameters	/P <x> [Enter]	X	
Set Password ⁵	/PW [Enter]	X	X
Read Buffer	/R <n> [Enter]	X	X
Display Port Status	/S [Enter]	X ⁶	X ⁶
Display Port Diagnostics	/SD [Enter]	X ⁶	X ⁶
Display Network Status	/SN [Enter]	X	
Test Network Options	/TEST [Enter]	X	
Send Parameter File	/U [Enter]	X	
Upgrade Firmware	/UF [Enter]	X	
Unlock Port (Invalid Access)	/UL [Enter]	X	
Display Port Parameters (Who)	/W [n] [Enter]	X	X ⁷
Exit Command Mode	/X [Enter]	X	X

- 1** Resident Disconnect: Disconnects your resident port from another port. The disconnect sequence can be redefined via the Port Configuration Menus.
- 2** A User Port cannot perform a Third Party Connect.
- 3** Third Party Disconnect: Disconnects two or more nonresident ports. Must be issued from a third port with Supervisor command capability.
- 4** Disconnects a TCP Port, where **Nn** is the desired RSM TCP Port.
- 5** If desired, The **/PW** can be disabled via the System Parameters Menu.
- 6** Supervisor Mode displays parameters for all ports; User Mode only displays parameters for ports allowed by the Port Password.
- 7** A port or account that does not permit Supervisor commands cannot view parameters for other ports.

13.3. Command Set

This Section provides information on all Text Interface commands, sorted alphabetically by command.

^X Resident Disconnect Sequence

The Resident Disconnect Sequence is used to disconnect your resident port from another port as described in Section 5.7. Although the default Resident Disconnect Sequence is **^x** (**[Ctrl]** plus **[X]**), the command can be redefined via the Port Configuration Menus as described in Section 5.7.2.

Note: *The Resident Disconnect Sequence cannot terminate a Direct Connection. For more information, please refer to Section 8.*

Availability: Supervisor / Non-Supervisor

Format (Default): **^x**

Response:

Verbose: The RSM will send the "Disconnected" message, followed by the Port Status Screen.

Terse: 3

/A Audit Log

Reads the contents of the Audit Log, and displays them on a screen which includes command options that can be used to erase the Audit Log. The Audit log provides a record of command activity at all RSM ports. For more information, please refer to Section 5.4.3.

Availability: Supervisor Only

Format: **/A [search] [Enter]**

Where the **search** option defines a text string. When the search option is included, the **/A** command will display all Audit Log Records that contain the specified text.

Note: *The Audit Log's Delete function will delete all stored records; the Delete operation will not be limited to only the records displayed by the search option.*

Response: Displays the Audit Log screen.

/C Connect

Establishes a bidirectional connection between two ports. For more information, see Section 7.1. There are two types of connections:

- **Resident Connect:** If the /C command specifies only one port, your resident port will be connected to the specified port.
- **Third Party Connect:** If the /C command specifies two ports, the unit will connect the two ports indicated. Third Party Connections can only be initiated by ports and accounts that permit Supervisor commands.

Notes:

- *If your user account does not permit Supervisor commands, you will only be allowed to connect to ports specifically allowed by that account.*
- *If the user account permits Supervisor commands, you are allowed to connect to any port.*
- *RS232 Ports are not allowed to create a Third Party connection to the Network Port. For example, Port 1 cannot connect Port 3 to the Network Port.*

Availability: Supervisor / Non-Supervisor

Format: /C <x> [x] [Enter]

Where **x** is the number or name of the port(s) to be connected.

Response:

Verbose: "Connected xx." When a Resident Connection is initiated, the RSM will also display the Resident Disconnect Sequence.

Terse: 1

/CP Copy RS232 Port Parameters

Allows quick set-up when several RS232 ports will be configured with similar parameters. When the /CP command is invoked, the RSM will display a menu that can be used to copy parameters to RS232 ports. For more information and other command options, please refer to Section 5.9.

Availability: Supervisor Only

Format: /CP [Enter]

Response: Displays Copy Parameters Menu.

/D Third Party Disconnect

Invoke the /D command at your resident port to disconnect two other ports. Note that the /D command cannot disconnect your resident port.

Availability: Supervisor Only

Format: /D[/Y] <x> [x] [Enter]

Where:

- /Y (Optional) suppresses the "Sure?" prompt.
- x Is the number or name of the port(s) to be disconnected. To disconnect all ports, enter an asterisk. To disconnect a Telnet session, enter the "Nn" format Network Port Number.

Response:

Verbose: "Are you Sure (y/n)?", if Y, unit will respond with "Disconnected".

Terse: 5, if Y, unit will respond with 3.

Example: To disconnect Port 2 from Port 3 without the "Sure?" prompt, access the Command Mode from a third port with Supervisor Level command capability and type:

/D/Y 2 [Enter] or /D/Y 3 [Enter]

/E Erase Buffer

Erases data from the buffer for a specified port(s). Note that erased data cannot be recovered.

Availability: Supervisor / Non-Supervisor

Format: /E[/Y] <x> [x] [Enter]

Where:

- x Is the number or name of the port buffer(s) to be cleared. To erase buffers for all ports, enter an asterisk.
- /Y (Optional) Suppresses the "SURE? (Y/N)" prompt.

Response:

Verbose: "Are You Sure (y/n)?", if Y, unit responds with "OK".

Terse: 5, if Y, the unit will respond with 0.

Example: To clear the buffer for Port 3, access the Command Mode from a port and account that permit Supervisor commands, and type /E 3 [Enter].

/F Set System Parameters

Displays a menu which is used to define the Site ID message, create user accounts, set the system clock, and configure and enable the Invalid Access Lockout feature. Note that all functions provided by the /F command are also available via the Web Browser Interface in the "System Parameters" menu. For more information, refer to Section 5.4.

Availability: Supervisor Only

Format: /F [Enter]

Response: Displays System Parameters Menu.

/H Help

Displays a Help Screen, which lists all available Text Interface commands along with a brief description of each command.

Availability: Supervisor / Non-Supervisor

Format: /H [Enter]

Response: Displays Help Screen.

/I Reboot System (Default)

Reinitializes the unit with default parameters. When the /I command is invoked, the unit will offer four reboot options:

- Reboot Only (Do Not Keep Parameters)
- Reboot and Default (Keep IP Parameters)
- Reboot and Default (Reset All Parameters)
- Reboot and Default (Reset All Parameters, but Keep SSH Keys)

Availability: Supervisor Only

Format: /I [Enter]

Response: Prompts for reboot option.

/J Display Site ID

Displays the Site I.D. message.

Availability: Supervisor / Non-Supervisor

Format: /J [Enter]

Response: Displays Site I.D. Message.

/K Send SSH Key

Instructs the RSM to provide you with a public SSH key for validation purposes. This public key can then be provided to your SSH client, in order to prevent the SSH client from warning you that the user is not recognized when you attempt to create an SSH connection. For more information, please refer to Section 8.2.

Availability: Supervisor Only

Format: /K k [Enter]

Where k is a required argument, which indicates the key type. The k argument provides the following options: 1 (SSH1), 2 (SSH2 RSA), 3 (SSH2 DSA.)

Response: Sends public key.

/N Set Network Port Parameters

Displays a menu which is used to select parameters for the Network Port. Also allows access to the IP Security function, which can restrict network access by unauthorized IP addresses. Note that all of the functions provided by the /N command are also available via the Web Browser Interface in the "Network Configuration" menu. For more information, please refer to Section 5.8.

Availability: Supervisor Only

Format: /N [Enter]

Response: Displays Network Parameters Menu.

/P Set RS232 Port Parameters

Displays a series of menus used to select options and parameters for the RS232 ports. Note that all functions provided by the /P command are also available via the Web Browser Interface in the "Serial Port" menu. Section 5.7.2 describes the procedure for defining port parameters.

Availability: Supervisor Only

Format: /P [x] [Enter]

Where x is the number or name of the port to be configured. If the port number/name is not specified, the RSM will display the configuration menu for your resident port.

Response: The Port Parameters Menu is displayed.

/PW Change Password

When enabled, the /PW command can be invoked by a user/account in order to change their own password. Note that the /PW command can be enabled/disabled via the System Parameters command as described in Section 5.4, and that once a given password has been changed, accounts with Supervisor Level access can still employ the "Modify User" function to change the password.

Availability: Supervisor / Non-Supervisor

Format: /PW [Enter]

Response: Displays the Change Password Menu.

/R Read Buffer

Reads from Buffer Mode ports as described in Section 7.3.1. Note that when the /R command is invoked, the counter for the SNMP Traps function will also be reset.

Availability: Supervisor / Non-Supervisor

Format: /R <n> [Enter]

Where n is the number or name of the port buffer to be read.

Response: The Read Buffer Menu is displayed.

/S Display Port Status

Displays the Port Status Screen (Figure 6.1), which summarizes conditions and parameters for all ports. For more information, please refer to Section 6.1.

Availability: Supervisor / Non-Supervisor

Format: /s [Enter]

Response: Displays Port Status Screen.

/SD Display Port Diagnostics

Provides detailed information regarding the status of each port. When this command is issued by an account that does not permit Supervisor commands, the resulting screen will only display parameters for the ports allowed by the account. For more information, please refer to Section 6.2.

Availability: Supervisor / Non-Supervisor

Format: /SD [Enter]

Response: Displays Port Diagnostics Screen.

/SN Display Network Status

Displays the Network Status Screen, which lists current conditions and parameters for the Network Port. For more information, please refer to Section 6.3.

Availability: Supervisor Only

Format: /SN [Enter]

Response: Displays Network Status Screen

/TEST Test Network Parameters

Displays a menu which is used to test configuration of the Syslog and SNMP Trap functions and can also be used to invoke a Ping Command. For more information, please refer to Section 9.3 and 10.4.

Notes:

- *In order for the ping command to function with domain names, Domain Name Server parameters must be defined as described in Section 5.8.5.*
- *The Test Menu's Ping command is not effected by the status of the Network Parameters Menu's Ping Access function.*

Availability: Supervisor Only.

Format: /TEST [Enter]

Response: Displays Syslog / SNMP Trap Test Menu.

/U Save Parameters

Sends RSM configuration parameters to an ASCII text file as described in Section 11.

Availability: Supervisor Only

Format: /U [Enter]

Response: The RSM will send a series of command lines.

/UF Upgrade Firmware

When new versions of the RSM firmware become available, this command is used to update existing firmware as described in Section 12. This command will only function at the Network Port and at Port One (the Setup Port.)

Availability: Supervisor Only

Format: /UF [Enter]

Response: The RSM will display a menu which offers the options to retain existing parameters, default parameters, or abort.

/UL Unlock Port (Invalid Access Lockout)

Manually overrides the RSM's Invalid Access Lockout feature. Normally, when a user-defined number of unsuccessful password attempts are detected at a given port, the Invalid Access Lockout feature will shut down that port for a user specified time period in order to prevent further access attempts. When the /UL command is invoked, the RSM will immediately unlock all ports that are currently in the locked state.

Availability: Supervisor Only.

Format: /UL [Enter]

Response: The RSM will unlock all RSM RS232 Ports.

/W Display Port Parameters (Who)

Displays configuration information for an individual port, but does not allow the user to change parameters. Accounts that do not permit Supervisor commands can only display parameters for their resident port. For more information, please refer to Section 6.4.

Availability: Supervisor / Non-Supervisor

Format: /w [**x**] [Enter]

Where **x** is the port number or name. To display parameters for the Network Port, enter an "N". If the "**x**" argument is omitted, parameters for your resident port will be displayed.

Response: Displays port parameters.

Example: To display parameters for a port named "SERVER", access the Command Mode from a port and account that permits Supervisor commands, and type /w SERVER [Enter].

/X Exit Command Mode

Exits command mode. When issued at the Net Port, also ends the Telnet session. Note that exiting from command mode will not terminate port connections.

- **Any-to-Any Mode:** Exits command mode.
- **Modem Mode:** Disconnects and resets modem, hang-up message is sent, hardware line to modem drops for 500 ms, and reset message is sent.

Availability: Supervisor / Non-Supervisor

Format: /x [Enter]

Response: Disconnected.

Appendix A. RS232 Port Interface

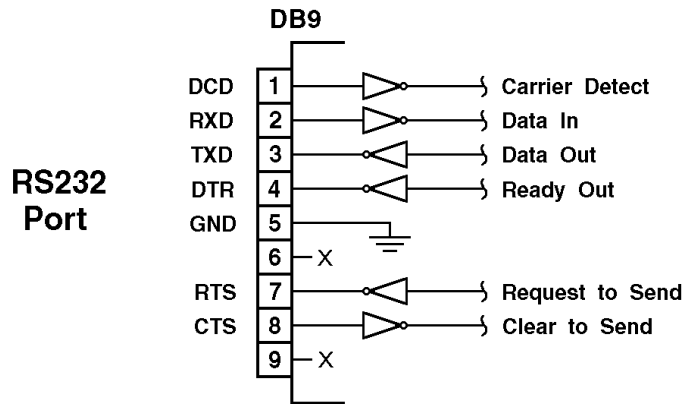

Figure A.1: RS232 Port Interface

DCD and DTR hardware lines function as follows:

1. **When connected:**

- a) If either port is set for Modem Mode, the DTR output at either port reflects the DCD input at the other end.
- b) If *neither* port is set for Modem Mode, DTR output is held high (active).

2. **When not connected:**

- a) If the port is set for Modem Mode, upon disconnect DTR output is pulsed for 0.5 seconds and then held high.
- b) If the port is *not* set for Modem Mode, DTR output is controlled by the DTR Output option (Serial Port Parameters Menu, Option 23). Upon disconnect, Option 23 allows DTR output to be held low, held high, or pulsed for 0.5 seconds and then held high.

Appendix B. Specifications

Network Interface: 10/100Base-T Ethernet, RJ45, multi-session Telnet.

RS232 Port Interface:

Connectors:

- **Model RSM-8:** Eight (8) DB9 connectors (DTE pinout.)
- **Models RSM-16 & RSM-16DC:** Sixteen (16) DB9 connectors (DTE pinout.)
- **Models RSM-32 & RSM-32DC:** Thirty Two (32) DB9 connectors (DTE pinout.)

Coding: 7/8 bits, Even, Odd, No Parity, 1, 2 Stop Bits.

Flow Control: XON/XOFF, RTS/CTS, Both, or None.

Data Rate: 300 to 115.2K bps (all standard rates).

Inactivity Timeout: No activity timeout disconnects port/modem sessions.
Off, 5, 15, 30, 90 minutes.

Memory: Stores Parameters and captured data. 256K per port.

Break: Send Break or Inhibit Break

Site ID: 32 Characters.

Port Name: 16 Characters per port.

Username & Passwords: 16 characters each (case sensitive.) Up to 128 pairs, definable port and system access.

LEDs: Power On, Ready, Data Activity for each RS232 Serial Port.

Physical / Environmental:

Power:

- **AC Version:** IEC-320 Inlet, 100 to 240 VAC, 50/60 Hz, 5 Watts
- **DC Version:** Terminal Strip (#6-32), -48 VDC, 0.2 Amp Max.

Size:

- **Models RSM-8, RSM-16 & RSM-16DC:**
 - Height:** 1.75" (4.4 cm), 1 Rack Unit.
 - Width:** 19.00" (48.3 cm)
 - Depth:** 6.50" (16.5 cm) Rack Mounts Included.
- **Models RSM-32 and RSM-32DC:**
 - Height:** 3.5" (8.8 cm), 2 Rack Units.
 - Width:** 19.00" (48.3 cm)
 - Depth:** 8.75" (22.2 cm) Rack Mounts Included.

Shipping Weight:

- **Models RSM-8, RSM-16 & RSM-16DC:** 6 lbs. (2.7 Kg.)
- **Models RSM-32 & RSM-32DC:** 12 Lbs. (5.5 Kg.)

Operating Temperature: 32°F to 122°F (0°C to 50°C)

Storage Temperature: -4°F to 128°F (-20°C to 70°C)

Humidity: 10 to 90% RH, Non-Condensing

Venting: Side vents are used to dissipate heat generated within the unit. When mounting the unit in an equipment rack, make certain to allow adequate clearance for venting.

Appendix C. Customer Service

Customer Service hours are from 8:00 AM to 5:00 PM, PST, Monday through Friday. When calling, please be prepared to give the name and make of the unit, its serial number and a description of its symptoms. If the unit should need to be returned for factory repair it must be accompanied by a Return Authorization number from Customer Service.

WTI Customer Service
5 Sterling
Irvine, California 92618

Local Phone: (949) 586-9950
Toll Free Service Line: 1-888-280-7227
Service Fax: (949) 457-8138

Email: service@wti.com

Trademark and Copyright Information

WTI and Western Telematic are trademarks of Western Telematic Inc.. All other product names mentioned in this publication are trademarks or registered trademarks of their respective companies.

Information and descriptions contained herein are the property of Western Telematic Inc.. Such information and descriptions may not be copied, disseminated, or distributed without the express written consent of Western Telematic Inc..

© Copyright Western Telematic Inc. 2007.
Printed in the United States of America.

December, 2007
Part Number: 13662, Revision: D

Trademarks Used in this Manual

HyperTerminal is a registered trademark of Hilgraeve, Inc.
ProComm and ProComm Plus are registered trademarks of
Datastorm Technologies, Inc.

Index

A		Configuration	5-1 to 5-44
Accept Break		Restoring	11-2
Network Port	5-28	Saving	11-1, 13-9
Serial Port	5-20	Configuration Menus	5-4
Access Level	5-41	Confirmation Prompt	13-1
Accounting Port	5-50	Connecting Ports	7-1 to 7-2, 13-4
Activity LEDs	2-1	Copying Parameters	5-51 to 5-52, 13-4
AC Powered Units	4-1	Customer Service	Apx-3
Add User	5-15	D	
Allow List	5-31	Date	5-7
Any-to-Any Mode	5-17, 7-1 to 7-6	DC Powered Units	4-1
Audit Log	5-6, 5-9, 13-3	Default System	13-6
Authentication Port		Delete User	5-16
RADIUS	5-50	Deny List	5-31
TACACS	5-48	DHCP	5-26
B		Dialback Number	5-15
Back Panel	2-2	Dialback Security	5-6, 5-10 to 5-11
Baud Rate		Dialback Attempts	5-11
Serial Port	5-19	Dialback Delay	5-11
Bind Type	5-39	Direct Connect	5-22, 5-26, 8-2 to 8-4
Bits		Configuration	8-2 to 8-3
Serial Port	5-19	Connection to Serial Ports	8-4
Buffer		Disconnection	8-6
Erase	13-5	Port Numbers	5-22, 8-4
Read	13-8	Disconnecting Ports	7-3, 13-3
Buffer Connect	5-21	Display Port Parameters	13-10
Buffer Date/Time	5-21	Display Port Status	13-8
Buffer Mode	5-17, 7-7 to 7-8	DTR Output	5-21
C		E	
Callback	5-10 to 5-11	Edit User	5-16
Callback Attempts	5-11	Encryption	
Callback Delay	5-11	SSH	8-1
Callback Number	5-15	Erase Buffer	13-5
Callback Security	5-6, 5-10 to 5-11	Ethernet Port	4-2
Callback Attempts	5-11	Exit Command Mode	13-10
Callback Delay	5-11	External Modem	4-2, 5-17
Change Password	5-6, 13-8	F	
Clear Button	2-1	Facility	5-23
Clock and Calendar	5-6, 5-7 to 5-8	Fallback	
Command Availability	13-2	LDAP	5-40
Command Echo		Fallback Local	
Network Port	5-28	RADIUS	5-50
Serial Port	5-20	TACACS	5-48
Command Mode		Fallback Timer	
Access	5-1 to 5-4	RADIUS	5-50
Exit	13-10	TACACS	5-48
Command Reference Guide	13-1 to 13-10	Firmware Upgrade	12-1 to 12-2, 13-9
Command Set	13-3 to 13-10	Front Panel	2-1
Command Summary	13-2	FTP Upgrade	12-1, 12-1 to 12-2, 13-9

G			
Gateway Address		5-26	
General Parameters		5-5 to 5-7	
Group Membership Attribute		5-40	
Group Membership Value Type		5-40	
H			
Handshake Mode			
Serial Port		5-19	
Hang-Up String		5-21	
Hardware Installation		4-1 to 4-2	
Help Menu		13-6	
Hunt Groups		7-5 to 7-6	
I			
Inactivity Timeout		7-4	
Network Port		5-28	
Serial Port		5-20	
Initialization		2-1	
Initialization String		5-21	
Installation		4-1	
Internal Modem		5-23	
Invalid Access Lockout		5-6, 5-8, 13-9	
IP Address			
Network Port		5-26	
RADIUS		5-49	
Syslog		5-26	
TACACS		5-47	
IP Security		5-29, 5-29 to 5-32	
K			
KDC		5-46	
Kerberos		5-45 to 5-46	
L			
LDAP			
Bind Type		5-39	
Fallback		5-40	
Group Membership Attribute		5-40	
Group Membership Value Type		5-40	
Kerberos		5-45 to 5-46	
LDAP Port		5-39	
Parameters		5-38 to 5-43	
Primary Host		5-39	
Search Bind DN		5-39	
Search Bind Password		5-39	
Secondary Host		5-39	
User Search Base DN		5-40	
User Search Filter		5-40	
LDAP Groups		5-40 to 5-44	
Access Level		5-41	
Deleting		5-44	
Modifying		5-43	
Port Access		5-41	
Viewing		5-42	
LED Indicators		2-1	
Level			
Syslog		5-23	
M			
Linux Operators		5-32	
Linux Routing Commands		5-34	
Lockout Attempts		5-9	
Lockout Duration		5-9	
Login Procedure		5-2	
Logoff Character		7-3	
Network Port		5-27	
Serial Port		5-20	
N			
Modem Mode		5-17, 7-9	
Hang-Up String		5-21	
Initialization String		5-21	
Periodic Reset Value		5-21	
Reset String		5-21	
Modem Port		2-2, 5-17, 5-23	
Modify User		5-16	
N			
Net/Mask Pairs		5-32	
Network Parameters		5-26, 13-7	
Network Port		2-2, 4-2, 5-26	
Accept Break		5-28	
Command Echo		5-28	
DHCP		5-26	
Gateway Address		5-26	
Inactivity Timeout		5-28	
IP Address		5-26	
Logoff Character		5-27	
Ping Access		5-26	
Raw Socket Access		5-26	
Sequence Disconnect		5-27	
SSH Access		5-26	
Subnet Mask		5-26	
Supervisor Mode		5-27	
Syslog IP Address		5-26	
Telnet Access		5-26	
Web Access		5-26	
Network Port Configuration		5-24 to 5-37	
Network Port Numbers		8-1	
Network Port Parameters		5-27 to 5-28	
Network Status Screen		6-4 to 6-5, 13-8	
NTP Address		5-7	
NTP Server		5-7	
NTP Timeout		5-8	
O			
ON Indicator		2-1	
Operation		7-1 to 7-9	

Syslog	5-9, 5-22, 9-1 to 9-3		
Configuration	9-1 to 9-2		
Facility	5-23		
Level	5-23		
Message Criteria	9-2		
Syslog IP Address	5-26		
Testing Configuration	9-3		
System Parameters	5-5 to 5-7, 13-6		
T			
TACACS Parameters	5-47		
Technical Support	Apx-3		
Telnet Access	5-26		
Telnet Functions	8-1 to 8-4		
Telnet Port	5-22		
Terminal Block Assembly	4-1		
Test Menu	9-3, 10-3, 13-9		
Test Network Parameters	13-9		
Text Interface	5-1 to 5-3, 13-1 to 13-10		
Third Party Connections	7-1 to 7-2		
Third Party Disconnect	7-3, 13-5		
Time	5-7		
Timeout	7-4		
Time Zone	5-7		
Trap Community	5-37		
U			
Unlocking Ports		5-8, 13-9	
Upgrading Firmware		12-1 to 12-2, 13-9	
Username		5-15	
User Directory		5-6, 5-12 to 5-17	
Add User		5-15	
Delete User		5-16	
Edit User		5-16	
View Users		5-13	
User Search Base DN		5-40	
User Search Filter		5-40	
V			
View Users		5-13	
W			
Web Access		5-26	
Web Browser Interface		5-3 to 5-4	
Who Command		6-5 to 6-6, 13-10	
X			
XON/XOFF		5-19	

Free Manuals Download Website

<http://myh66.com>

<http://usermanuals.us>

<http://www.somanuals.com>

<http://www.4manuals.cc>

<http://www.manual-lib.com>

<http://www.404manual.com>

<http://www.luxmanual.com>

<http://aubethermostatmanual.com>

Golf course search by state

<http://golfingnear.com>

Email search by domain

<http://emailbydomain.com>

Auto manuals search

<http://auto.somanuals.com>

TV manuals search

<http://tv.somanuals.com>