



**USER'S MANUAL**  
MANUEL DE L'UTILISATEUR  
MANUAL DEL USUARIO

**CW50T9XW**

# CONTENTS

1	<b>SAFETY PRECAUTION</b>		1
2	<b>IMPORTANT SAFETY INSTRUCTION</b>		2
3	<b>ACCESSORIES</b>		3
4	<b>GETTING STARTED</b>		3
5	<b>CONTROL REFERENCE GUIDE</b>	Remote Control	4
		Front View	5
		Back View	5
		Side View	6
6	<b>CONNECTIONS</b>	Antenna Connection	7
		AV Connection	7
		Y Pb Pr Connection	8
		HDMI Connection	8
		VGA Connection	9
		Headphone Connection	9
		Power Cord Connection	9
		Coax(SPDI) Connection	10
7	<b>WALL MOUNT INSTALLATION</b>		11
8	<b>INITIAL SETUP</b>	Putting The Unit On A Proper Place	12
		Turning The Unit On For The First Time	12
9	<b>TV SETUP</b>	Source selection	14
		Main menu	14
		Picture Menu	16
		Sound Menu	20
		Channel Menu	22
		Parental Control	25
		Setup Menu	29
		Other Menu	31

## CONTENTS

10	<b>DISPLAY MODE</b>	PC Formats Video Formats	32 33
11	<b>SPECIFICATION</b>		34
12	<b>TROUBLE- SHOOTING GUIDE</b>	TV Symptom	35

**SAFETY CLASS :This is an IEC safety class I product  
and it must be grounded for safety.**

# SAFETY PRECAUTION

- \* CAUTION MARKING WAS LOCATED AT THE REAR OF THE APPARATUS. **PLACEMENT INFORMATION**



WARNING: TO REDUCE THE RISK OF ELECTRIC SHOCK, DO NOT REMOVE COVER (OR BACK) NO USER SERVICEABLE PARTS INSIDE. REFER SERVICING TO QUALIFIED SERVICE PERSONNEL.

 The lightning flash with arrowhead symbol, within an equilateral triangle, is intended to alert the user to the presence of uninsulated "dangerous voltage" within the product's enclosure that may be of sufficient magnitude to constitute a risk of electric shock to persons.

 The exclamation point within an equilateral triangle is intended to alert the user to the presence of important operating and maintenance (servicing) instructions in the literature accompanying the appliance.

## CAUTION

- DANGER OF EXPLOSION IF BATTERY IS INCORRECTLY REPLACED. REPLACE ONLY WITH THE SAME OR EQUIVALENT TYPE.
- USE OF CONTROLS OR ADJUSTMENTS OR PERFORMANCE OF PROCEDURES OTHER THAN THOSE SPECIFIED MAY RESULT IN HAZARDOUS RADIATION EXPOSURE.

## WARNING:

- TO REDUCE THE RISK OF FIRE OR ELECTRIC SHOCK, DO NOT EXPOSE THIS APPLIANCE TO RAIN OR MOISTURE.
- TO REVENT FIRE OR SHOCK HAZARD, DO NOT EXPOSE THIS UNIT TO RAIN OR MOISTURE. DO NOT PLACE OBJECTS FILLED WITH LIQUIDS ON OR NEAR THIS UNIT.
- SHOULD ANY TROUBLE OCCUR, DISCONNECT THE AC POWER CORD AND REFER SERVICING TO A QUALIFIED TECHNICIAN.

- Do not use this unit in places that are extremely hot, cold, dusty or humid.
- Do not restrict the airflow of this unit by placing it somewhere with poor airflow, by covering it with a cloth, by placing it on bedding or carpeting.

## SAFETY INFORMATION

- When connecting or disconnecting the AC power cord, grip the plug and not the cord itself. Pulling the cord may damage it and create a hazard.
- When you are not going to use the unit for a long period of time, disconnect the AC power cord.

## RATING PLATE LOCATION

The rating plate is located on the rear of the unit.

## FCC STATEMENTS

NOTE: This unit has been tested and found to comply with the limits for a Class B digital device, pursuant to Part 15 of the FCC Rules. These limits are designed to provide reasonable protection against harmful interference in a residential installation.

This unit generates, uses and can radiate radio frequency energy and, if not installed and used in accordance with the instructions, may cause harmful interference to radio communication. However, there is no guarantee that interference will not occur in a particular installation. If this unit does cause harmful interference to radio or television reception, which can be determined by turning the unit off and on, the user is encouraged to try to correct the interference by one or more of the following measures:

- Reorient or relocate the receiving antenna.
- Increase the separation between the unit and receiver.
- Connect the unit into an outlet on a circuit different from that to which the receiver is connected.
- Consult the dealer or an experienced radio/TV technician for help.

## WARNING:

Changes or modifications to this unit not expressly approved by the party responsible for compliance could void the user authority to operate the unit.



## IMPORTANT SAFETY INSTRUCTIONS

- 1) Read these instructions.
- 2) Keep these instructions.
- 3) Heed all warnings.
- 4) Follow all instructions.
- 5) Do not use this apparatus near water.
- 6) Clean only with a dry cloth.
- 7) Do not block any ventilation openings.  
Install in accordance with the manufacturer's instructions.
- 8) Do not install near any heat sources such as radiators, heat registers, stoves, or other apparatus (including amplifiers) that produce heat.
- 9) Do not defeat the safety purpose of the polarized or grounding-type plug.  
A polarized plug has two blades with one wider than the other.  
A grounding type plug has two blades and a third grounding prong.  
The wide blade or the third prong is provided for your safety.  
If the provided plug does not fit into your wall outlet, consult an electrician for replacement of the obsolete outlet.
- 10) Protect the power cord from being walked on or pinched particularly at plugs, convenience receptacles, and the point where they exit from the apparatus.
- 11) Only use attachments / accessories specified by the manufacturer.
- 12) Use only with the cart, stand, tripod, bracket, or table specified by the manufacturer, or sold with the apparatus.  
When a cart is used, use caution when moving the cart / apparatus combination to avoid injury from tip-over.
- 13) Unplug this apparatus during lightning Storms or when unused for long periods of time.
- 14) Refer all servicing to qualified service personnel. Servicing is required when the apparatus has been damaged in any way, such as the power cord or plug is damaged, liquid has been spilled or objects have fallen into the apparatus, the apparatus has been exposed to rain or moisture, does not operate normally, or has been dropped.
- 15) To prevent electric shock, ensure the grounding pin on the AC cord power plug is securely connected.



# ACCESSORIES

Please check and identify the supplied accessories.

Remote control .....	x 1
Battery(AAA).....	x 2
Warranty Card .....	x 1
Instruction Manual .....	x 1
Base stand and 6 screws .....	x 1
Screw driver .....	x 1

# GETTING STARTED

## Installing Batteries to the Remote Control

Please insert two AAA batteries into the remote control. Make sure that you match the (+) and (-) symbols on the batteries with the (+) and (-) symbols inside the battery compartment. Afterwards, re-attach the battery cover.



Please note:

- Only use AAA batteries.
- Do not mix new and old batteries. This may result in cracking or leakage that may pose a fire risk or lead to personal injury.
- Inserting the batteries incorrectly may also result in cracking or leakage that may pose a fire risk or lead to personal injury.
- Dispose the batteries in accordance with local laws and regulations.
- Keep the batteries away from children and pets.
- If the remote control is not used for a long time, remove the batteries.
- Keep the remote control away from moisture, sunlight, and high temperatures.



### WARNING :

Do not dispose batteries in a fire. Batteries may explode or leak.  
Batteries shall not be exposed to excessive heat such as sunshine, fire or the like.

# CONTROL REFERENCE GUIDE

## REMOTE CONTROL



1. **POWER** Turns the TV on or off.
2. **SOURCE** Press this button to cycle through the INPUT source.
3. **CC** Cycles between different closed captioning modes.
4. **MTS** Selects stereo, mono, or second audio programming.
5. **AUTO** Press this button to autoadjust the screen size on PC mode.
6. **NUMBER BUTTONS (0-9)** Press 0-9 to select a TV channel directly when you are watching TV. The channel will change after 2 seconds.
7. **(-)** Inserts the dash for selecting digital channels directly.
8. **R** Returns to the previous channel.
9. **Temp** This button is for select for the color temperature.
10. **INFO** Shows the display info.
11. **▲/▼/◀/▶/ENTER** These directional buttons allow you to move around in the TV's menu. Press the ENTER button when you want to select a particular option.
12. **MENU** Brings up the main TV menu on the screen.
13. **EXIT** Exit the main TV menu on the screen.
14. **VOL(+)/VOL(-)** Press the VOL buttons to increase or decrease the sound level.
15. **ASPECT** Press this button to change the picture's cropping method.
16. **MUTE** Turns the sound off from the TV. To un-mute either press VOL(+) or press the MUTE button again
17. **SLEEP** Turns the TV off in a specific set of time dependent on your selection.
18. **FAVORITE** Gives you your list of favorite channels.
19. **ADD/DEL** Adds or Deletes current channel from the favorite list.
20. **FAV(-)** Press this button to change to the previous favorite channel.
21. **FAV(+)** Press this button to change to the next favorite channel.
22. **PICTURE** Selects various preset picture settings.
23. **SOUND** - Selects various preset sound settings.
24. **TV** This button select the source TV.
25. **HDMI** This button select the source from HDMI1 to HDMI3.

# CONTROL REFERENCE GUIDE

## FRONT VIEW

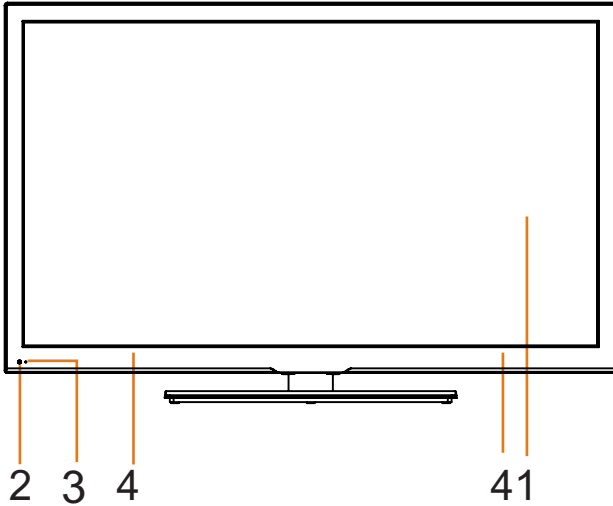

- 1. Color Screen
- 2. Remote Sensor  
Do not block this sensor or the remote control will not work.
- 3. Standby Indicator  
Indicates whether the unit is ON or in STANDBY (OFF) mode.  
Light in red: The unit is in STANDBY.  
Light in blue: The unit is turned ON.
- 4. Speakers

## BACK VIEW

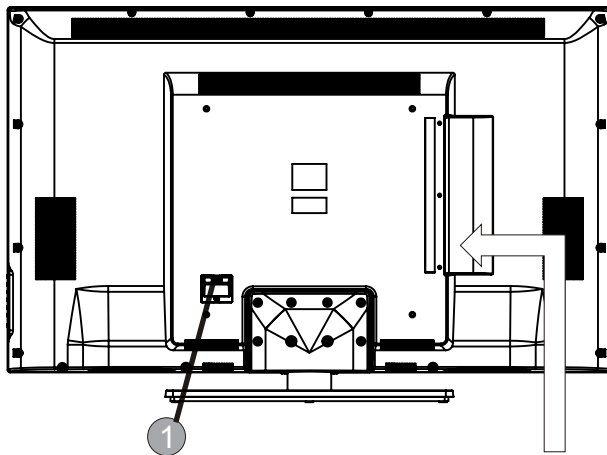

- 1. Power cord
- 2. Coax OUT Jack
- 3. TV ANTENNA Terminal
- 4. VGA IN Jack
- 5. PC AUDIO IN Jack
- 6. HDMI IN Jack
- 7. Service Port
- 8. COMPONENT IN Jack
- 9. AV (VIDEO/AUDIO R/L) IN
- 10. AUDIO OUT Jack  
(Audio out- This connection is for sending out analog audio signal to the 2nd equipment. Red is for Right Channel, white is for Left Channel.)
- 11. Headphone Jack

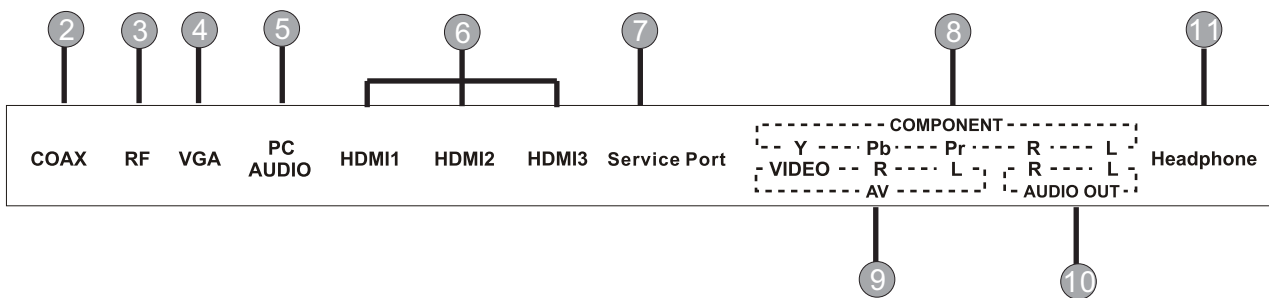

# CONTROL REFERENCE GUIDE

## SIDE VIEW

- 1 ——— VOL+
- 2 ——— VOL-
- 3 ——— CH+
- 4 ——— CH-
- 5 ——— MENU
- 6 ——— SOURCE
- 7 ——— STANDBY

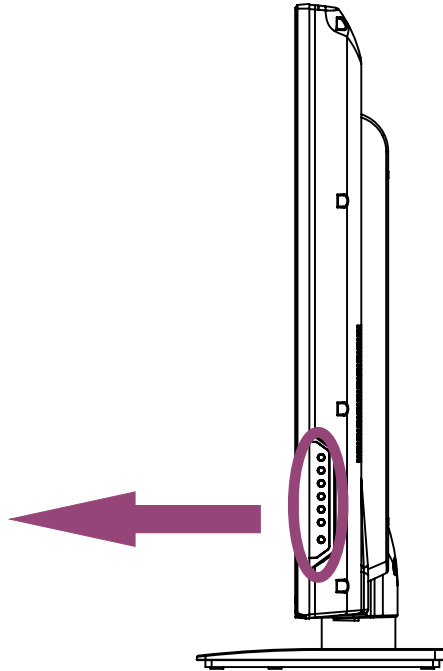

- 1. VOL+ Button  
Press to adjust the volume up.
- 2. VOL- Button  
Press to adjust the volume down.
- 3. CH+ Button  
Press to change the TV channels and up highlight selections on the menu screen.
- 4. CH- Button  
Press to change the TV channels and down highlight selections on the menu screen.
- 5. Menu Button  
Press to display the on-screen TV menu.
- 6. SOURCE Button  
Press to select the input source of the TV.
- 7. STANDBY Button  
Press to turn the unit on and off.

# CONNECTIONS

## CONNECTING A TV ANTENNA / CABLE / SATELLITE

To view television channels correctly, a signal must be received from one of the following sources:

- An indoor or outdoor aerial antenna
- A cable system
- A satellite system

### NOTE

For receiving over-the-air TV broadcasts, we recommend that you use an external fixed antenna. Should you require the use of a temporary antenna, please ensure that you purchase an antenna with sufficient ability to receive in weak signal areas. Only when you are in close proximity to a transmitter will a temporary antenna reproduce a signal as strongly as a fixed antenna.

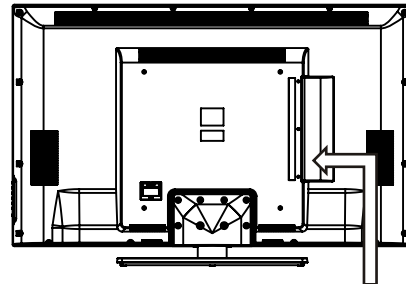

Satellite, cable or TV antenna cable to TV ANTENNA terminal (cable not included)

## CONNECTING AN A/V DEVICE

To connect to other equipment such as a VCR, camcorder, satellite system or cable, etc.

## CONNECTING DEVICES WITH A COMPOSITE (YELLOW RCA-TYPE) VIDEO OUTPUT

To connect A/V devices such as a VCR, video game system or camcorder.

### Connecting to a VCR / Video Game System / Camcorder

Connect the AUDIO / VIDEO cable (not included) as shown.

Make sure you connect the cable from the other equipment ( **AUDIO** and **VIDEO OUT** ) to this unit (AV in)

### NOTE

Please refer to the user manual for the other equipment for more information.

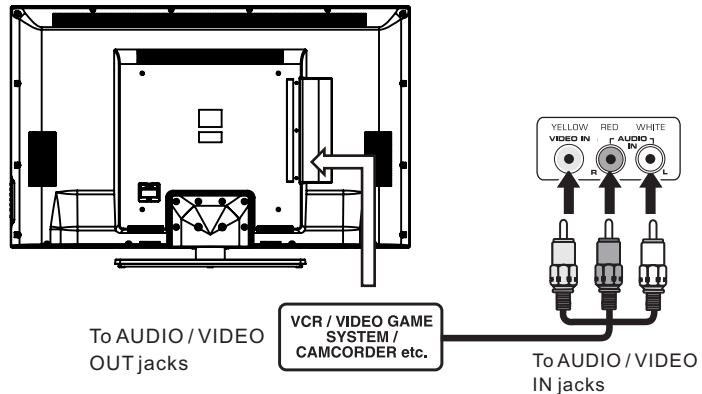

# CONNECTIONS

## CONNECTING A HIGH-DEFINITION (HD) SOURCE USING COMPONENT CONNECTION

High-Definition (HD) Devices with component video output must be connected to the YPbPr input. Connect the component video cable and audio cable (not included) as shown. Make sure you connect the component video cable and audio cable from the other equipment (COMPONENT OUT and AUDIO OUT) to the unit COMPONENT IN.

### NOTE

When connecting a DVD player to the television, the picture resolution is solely dependent upon the resolution supported by the DVD player attached. DVD player resolutions vary from 480i to 1080p, and this television can support DVD players up to a maximum resolution of 1080p.

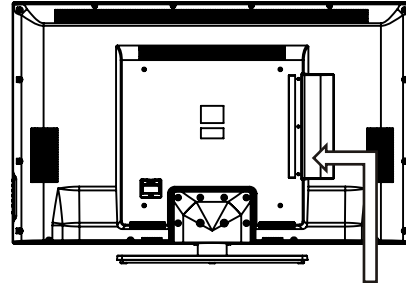

\* May require a subscription for receiving HD channels, check with your cable/satellite service provider for details.

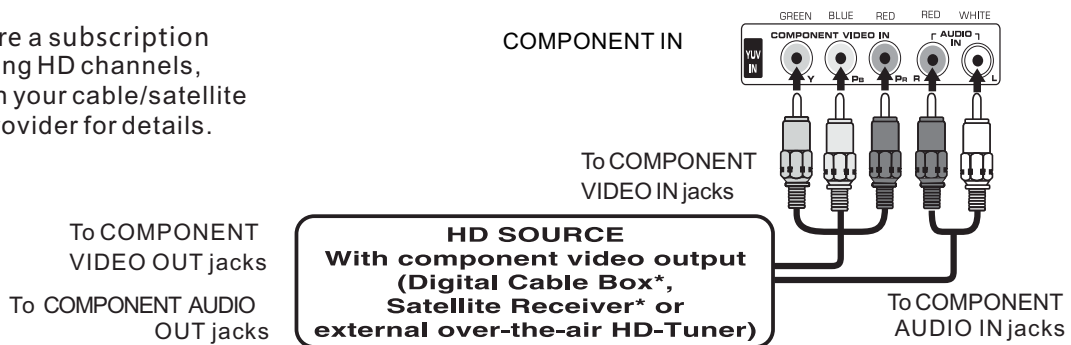

## CONNECTING A HIGH-DEFINITION (HD) SOURCE USING HDMI CONNECTION

HDMI (High Definition Multimedia Interface) supports both video and audio on a single digital connection for use with DVD players, DTV, set-top boxes and other digital AV devices. HDMI was developed to provide the technologies of High Bandwidth Digital Content Protection (HDCP) as well as Digital Visual Interface (DVI) in one specification. HDCP is used to protect digital content transmitted and received by DVI-compliant or HDMI-compliant displays. HDMI has the capability to support standard, enhanced or high-definition video plus standard to multi-channel surround-sound audio. HDMI features include uncompressed digital video, a bandwidth of up to 2.2 gigabytes per second (with HDTV signals), one connector (instead of several cables and connectors), and communication between the AV source and AV devices such as DTVs.

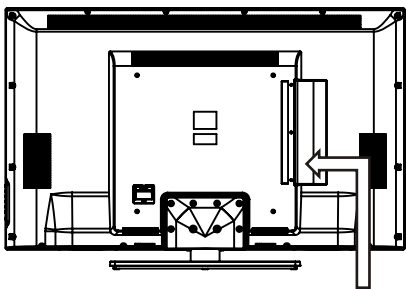

Connect the HDMI cable (not included) as shown: Make sure you connect the cable from the source equipment (HDMI OUT) to this unit (HDMI IN).

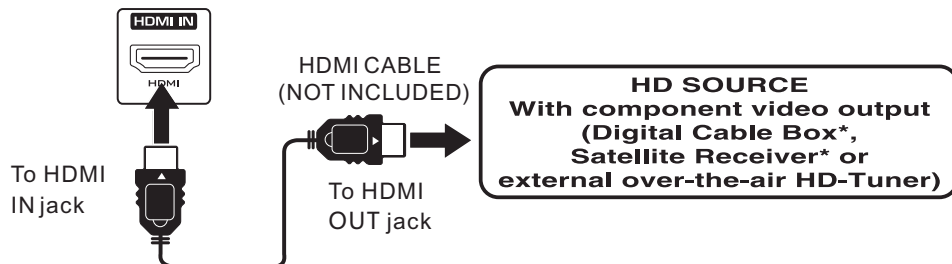

# CONNECTIONS

## CONNECTING A PC

Connect the 15-pin D-SUB PC/VGA connector from your computer to the 15-pin D-SUB PC/VGA input on this unit using a monitor cable and an audio cable (not included) as shown.

Make sure you connect the cable from the computer (VGA and AUDIO - PC OUT ) to this unit (VGA and AUDIO - PC IN ).

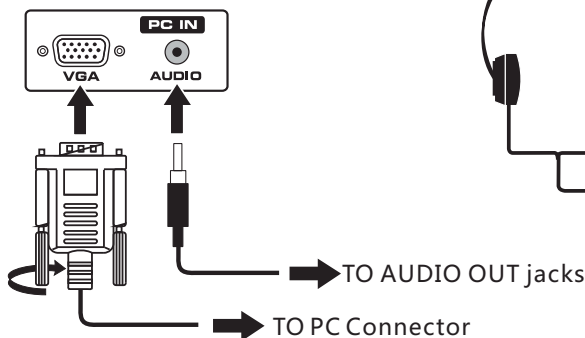
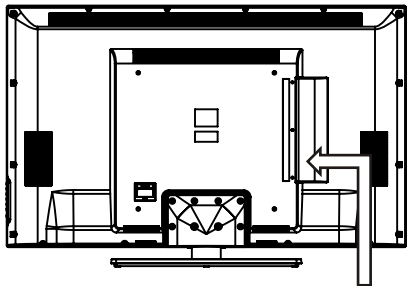

## CONNECTING HEADPHONES

- Turn down the volume before connecting headphones to the unit, then adjust the volume to your desired level.
- When headphones are connected, no sound will come from the front speakers.

### NOTE

Avoiding listening to sound at high Levels for prolonged period of time. This may be harmful to you and may cause hearing loss.

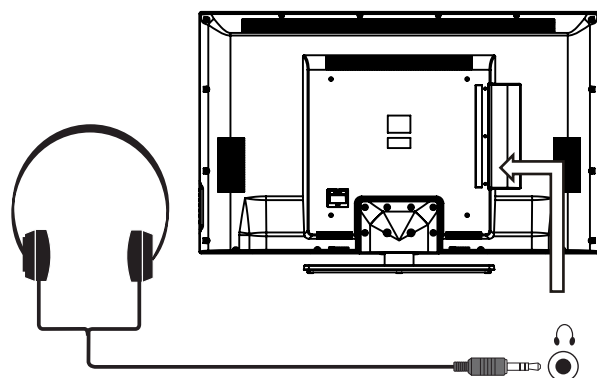

Headphones  
(1/8" [ 3.5mm ] diameter plug)  
NOT INCLUDED

## CONNECTING THE POWER CORD

You can power on your TV unit before you make sure the power cord is inserted well. At the same time, please check that the rated voltage of your unit matches your local Voltage.

### NOTE

- Insert the power plug fully into the socket outlet. (If the power plug is loose, it could generate heat and cause fire.)
- Ensure that the power plug is easily accessible.
- Ensure the earth pin on the power plug is securely connected to prevent electrical shock.
- An apparatus with CLASS I construction shall be connected to a power socket outlet with a protective grounding connection.
- Do not touch the power plug with a wet hand. (This may cause electrical shock)
- Do not use any power cord other than that provided with this TV. ( This may cause fire or electrical shock.)
- Do not damage the power cord. (A damaged cord may cause fire or electrical shock)
- Do not move the TV with the cord plugged in the socket outlet.
- Do not place a heavy object on the cord or place the cord near a high-temperature object.
- Do not twist the cord, bend it excessively, or stretch it.
- Do not pull on the cord. Hold onto the power plug body when disconnecting cord.
- Do not use a damaged power plug or socket outlet.

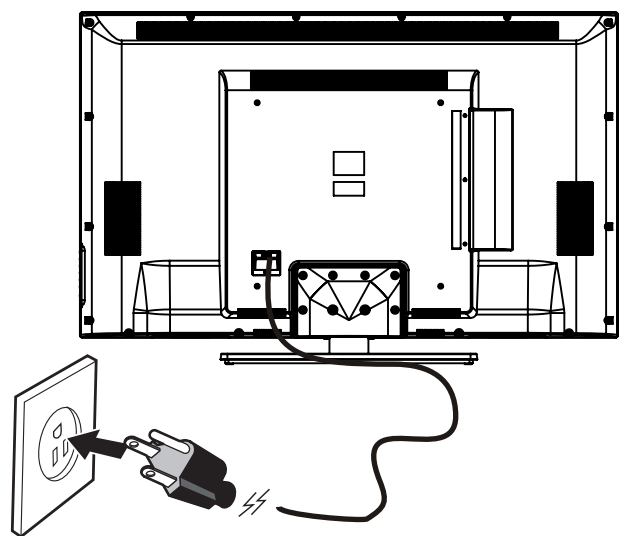

To AC wall outlet



# CONNECTIONS

## Connection to a Home Theater Audio System

### For BEST audio performance

Connecting to a Home Theater System  
Dolby Digital can deliver optimal 2 channel stereo or surround sound with five discrete full range channels plus a sixth channel for a subwoofer.

Enjoy optimal sound reproduction from your system with a Dolby Digital amplifier that incorporates a digital coaxial input. Connect an optional digital cable directly to the television's Coax audio output to listen through all inputs except VGA.

(The VGA does not support digital audio)

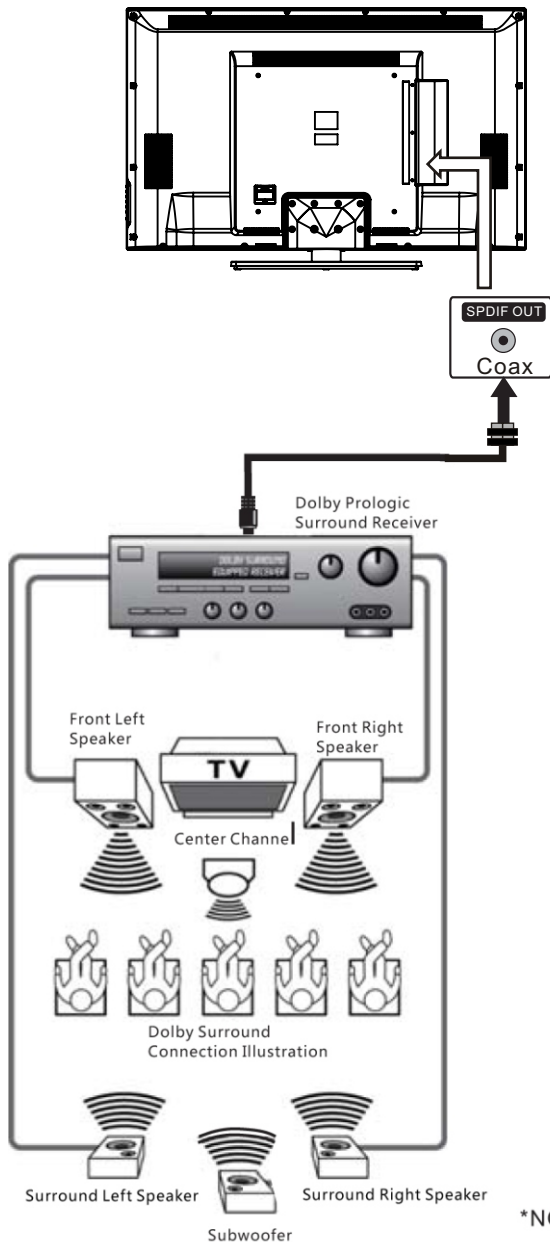

optional digital cable

### How To Setup Digital Output

Press the MENU button on the remote control  
Press the right ► arrow button to select SOUND  
and Press ENTER to enter the submenu.  
Press the down ▼ arrow button to highlight  
Digital Audio Output and press ◀▶ to  
change setting from PCM, Raw or Off.

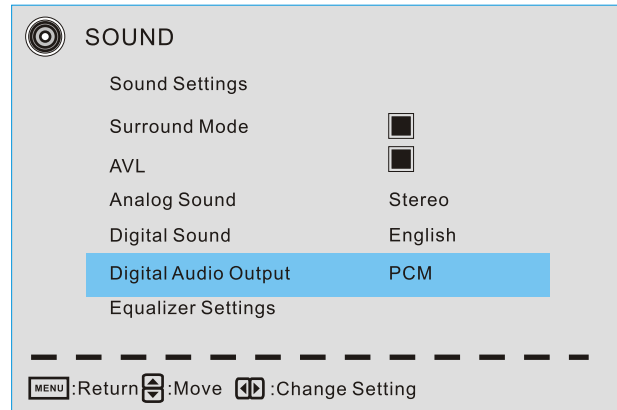

\*NOTE: Refer to the User Manual from your home theater equipment for recommended audio settings.

# WALL MOUNT INSTALLATION

## INSTALLING / REMOVING THE BASE STAND

**WARNING :** The LCD Display is very fragile, and must be protected at all times when removing the base Stand.

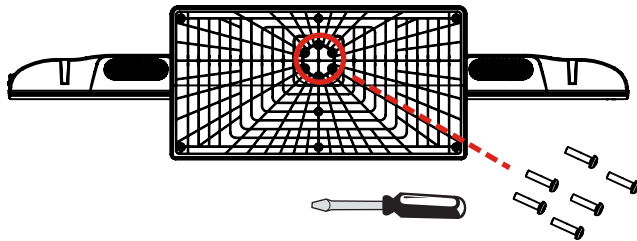

Place the stand on the TV, insert and tighten the screws (found in the accessories box) in the circled area with the screwdriver provided.

Be sure that no hard or sharp object or anything that could scratch or damage the LCD display comes into contact with it. Do NOT exert pressure on the front of the unit at any time because the screen could crack.

1. Disconnect all cables or cords connected to the unit.
2. Lay the unit down on a flat surface with the back side facing up. Please make sure to place a soft cushioned material (such as a pillow or thick piece of foam) beneath the screen.
3. To remove the base stand, loosen screws off the holes then pull downwards to release the base stand.

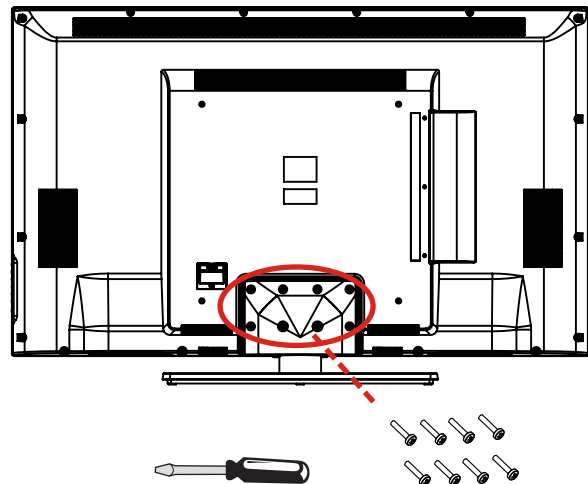

## MOUNTING ON THE WALL

This unit is VESA-compliant, and is designed to be wall-mounted with a VESA-compliant 16" x 16" (400mm x 400mm) mounting kit designed for flat-panel TVs (not supplied). Mount this unit according to the instructions included in the mounting kit. Length of screw should not exceed 14 mm.

### NOTE

Remove the base stand before mounting the unit on the wall.

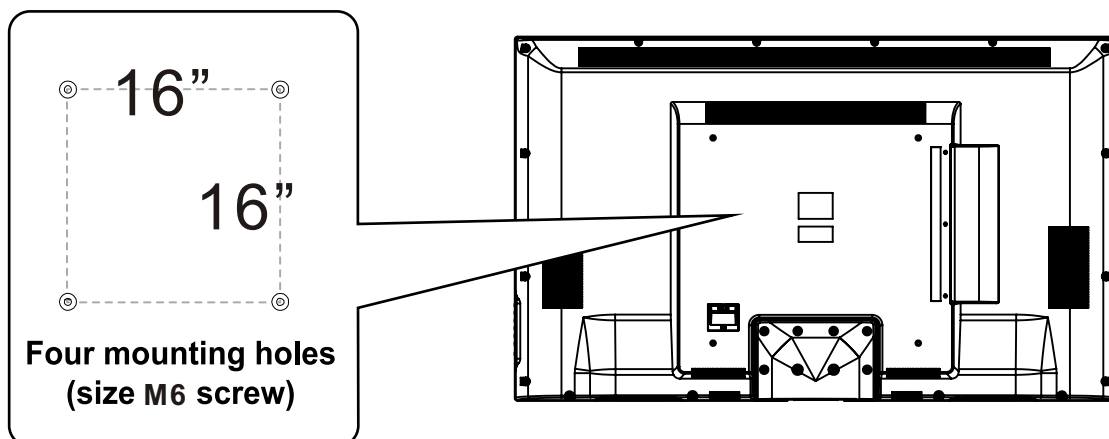

# INITIAL SETUP

## PUTTING THE UNIT ON A PROPER PLACE

When you turn on your television set for the first time, be sure to place it on a solid stable surface.

To avoid danger, do not expose the TV to water, or a heat source (e.g. lamp, candle, radiator).

Do not obstruct the ventilation grid at the rear and be sure to leave sufficient gaps around the unit.

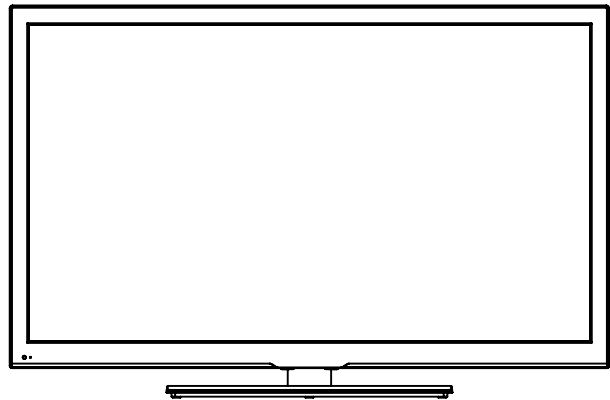

## TURNING THE UNIT ON FOR THE FIRST TIME

After you have initially connected your TV antenna or cable, turn the television ON.

A guide will display to help you set up your TV.

Follow this guide to help you set up your TV. Use the Up and Down arrows on your remote control and select the Language you want to use for menus and message screens.

**Select Language**

Follow this guide to help you set up your TV. Use the Up and Down arrows on your remote control and select the Language you want to use for menus and message screens.

English	Enter
French	Enter
Spanish	Enter

-----

:Move : Press to Execute

Use the left or right key to select on you time zone.

**Time Zone**

Use the left or right key to select on you time zone.

Time Zone	Atlantic
-----------	----------

Next

-----

:Return :Move :Change Setting

Use the up/down key arrows on you remote control to select power on mode.

Home optimizes the video setting for ENERGY STAR® qualification.

Retail optimizes the video setting for use on a retail showroom floor or demo environment

**Power On Mode**

Use the up/down key arrows on you remote control to select power on mode.

Home optimizes the video setting for ENERGY STAR® qualification.

Retail optimizes the video setting for use on a retail showroom floor or demo environment

Home
Retail

-----

:Return :Move : Press to Execute

# INITIAL SETUP

What Connection are you using? For optimal video quality  
We Recommend HDMI or Component Input.

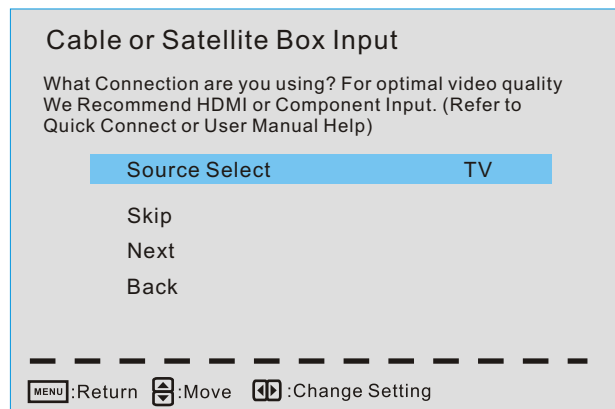
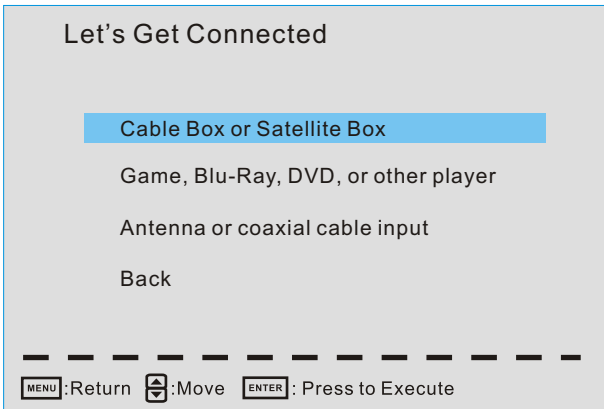

Press left or right button to select the Source and down button to select Next, press ENTER button to start scan the programme.  
It will take a few minutes.

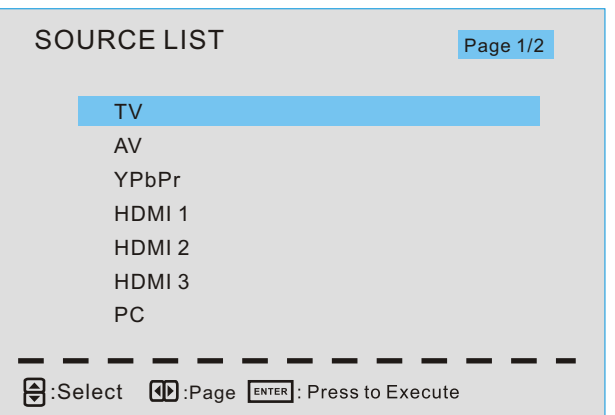
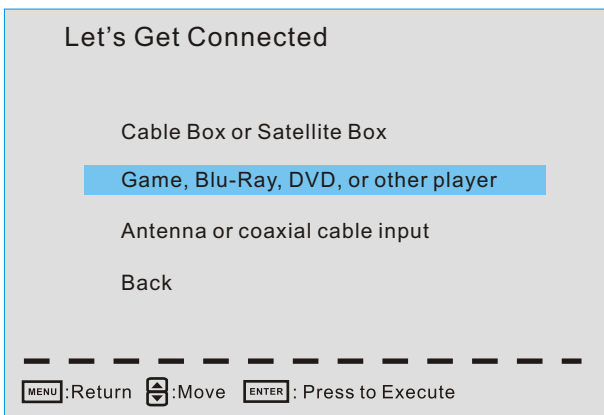

When you connect the Player, you can select this function to select the Input Source.

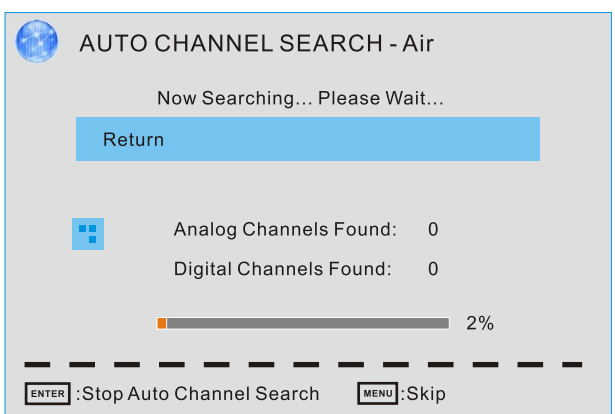
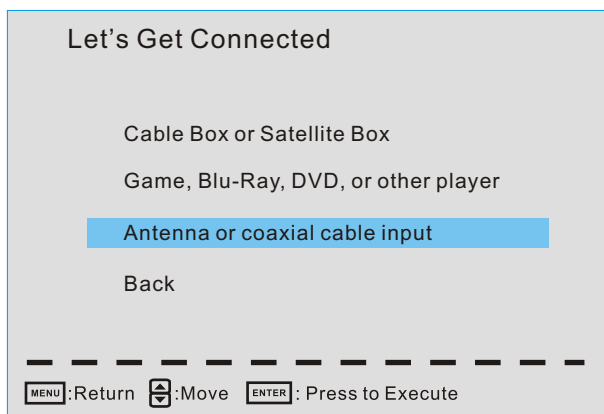

When you connect the Antenna, you can choose this function and select the channel scan type.  
After that, you can choose **Antenna[ATSC]** and then it will search analog channels first, then digital channels.

Please confirm your antenna type is **Air** or **Cable**.  
Wrong setting of Signal Type maybe cause finding no channel.

# INITIAL SETUP

## SOURCE SELECTION

1. Press the **SOURCE** button on the remote control.
2. Use the ▲ or ▼ button to select the options (TV,AV,YPbPr, HDMI1,HDMI2,HDMI3,PC)

and select any of them using the ► button or the **ENTER** button.

(The screen will change to your desired source).

Note:

Before watching please make sure all necessary cables and devices are connected.

Source Select
TV
AV
YPbPr
HDMI1
HDMI2
HDMI3
PC

## Main MENU

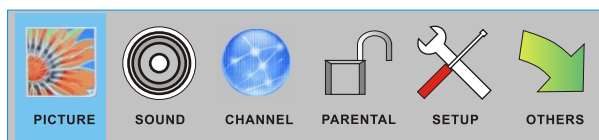

Press MENU to display the main menu or return to the previous menu or close the main menu.

Press ◀/▶ to high light the desired menu icon, and press ENTER to select.

If no buttons are pressed, the menu will close automatically after about 10 seconds.

## Main Menu Description

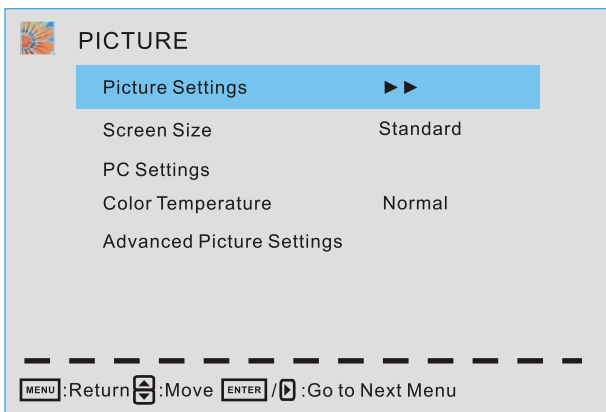

## Picture Menu

Adjust your picture settings.  
The operations are slightly different among different source.

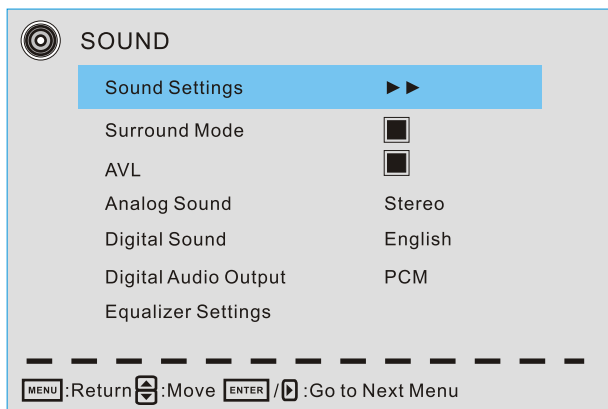

## Sound Menu

Adjust the sound settings.

# TV SETUP



## Channel Menu

Customize your channel settings.

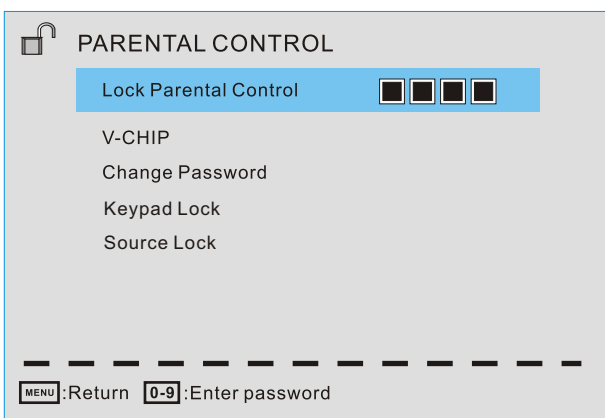

## Parental Control Menu

Set program rating control and input source keypad lock function.

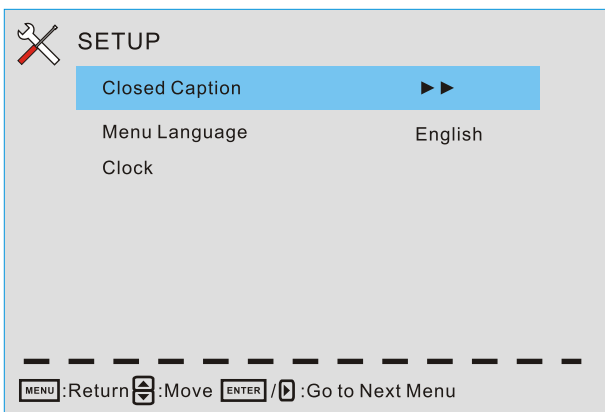

## Setup Menu

Select closed caption options, language and time.

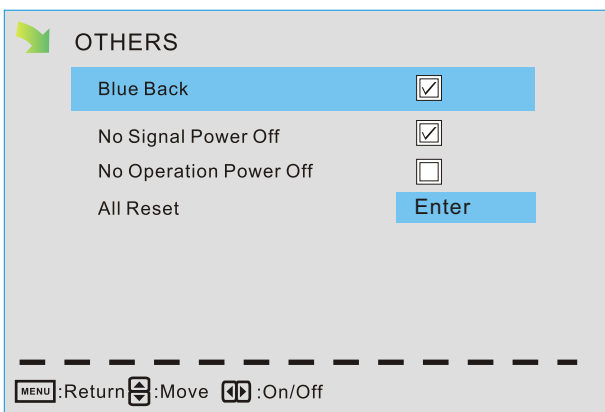

## Other Menu

Set the OSD blue background, whether auto power off if no signal or no operation, clear all user settings, etc.

# TV SETUP

## Picture Menu

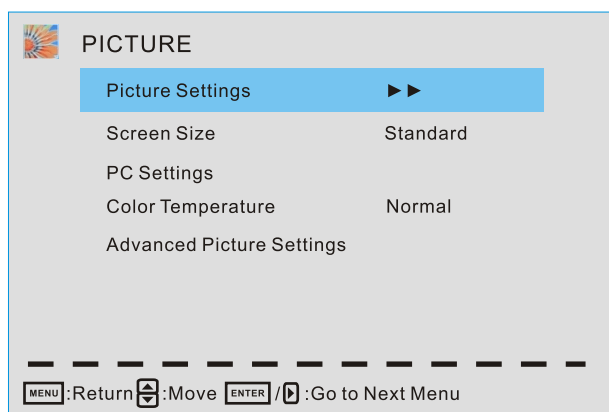

Press ▲/▼ to highlight one of the following options, then press ENTER or ► to enter next submenu to adjust it. Press EXIT to clear on-screen menu or MENU back to the previous menu.

## Picture Settings

Adjust the picture quality including brightness, contrast, color, tint, sharpness.

## Screen Size

Press ◀/▶ to select the display aspect ratio till the picture is fit onto the screen. The operations are different according to different input source.

## PC Settings

The item is available only for PC DB15 input mode.

## Color Temperature

Press ◀/▶ to select the color temperature that you feel comfortable.

**Cool** Gives white colors a blue tint.

**Normal** Gives white colors a neutral tint.

**Warm** Gives white colors a red tint.

## Advanced Picture Settings

The Item is some special picture feature.

# TV SETUP

## Picture Settings

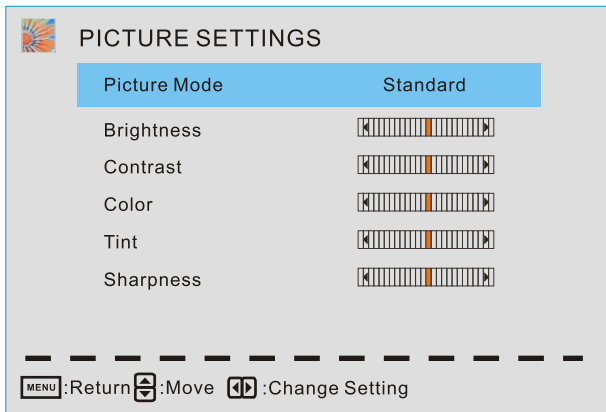

When Picture Mode is set to User, the following setting can be manually adjusted.  
Press **PMODE** shortcut button on the remote control to select picture mode directly.

### Picture Mode

Highlight the item and Press ◀/▶ to select Standard/ Movie/ User/ Dynamic.

**Standard** Produces a highly defined image in a normally lit room.

**Movie** Produces a highly defined image in gentle lit room.

**User** Select to customize picture setting.

**Dynamic** Produces a highly defined image in a bright lit room.

Highlight the item and press ▶, and a process bar appears, then press ◀/▶ to adjust the value.

Tint is available when analog TV or NTSC-system AV.

Press **MENU** to back the Picture Settings menu.

### Brightness

Adjust darkness of black sections in the picture.

### Contrast

Adjust the white level of the picture.

### Color

Adjust the color intensity of the picture.

### Tint

Adjust the hue( Red, Green, Blue) of the picture.

### Sharpness

Object edges are enhanced for picture detail.



# TV SETUP

## PC Settings

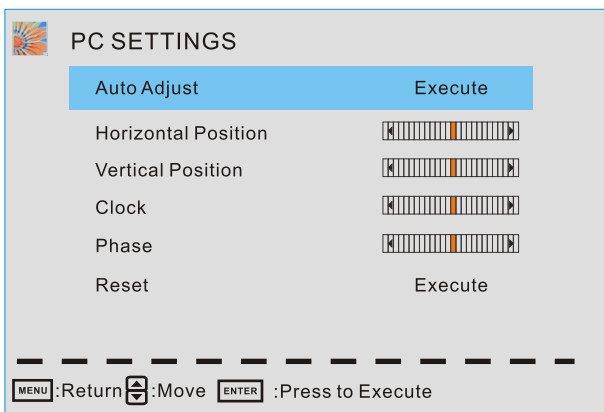

PC Settings Menu is available only in PC DB15 mode.

Press ▲/▼ to highlight one of the following options, then press ENTER to select it.

### Auto Adjust

Automatically adjust Clock, Phase, H-Position and V-position settings.

### Horizontal Position

Shift the screen slightly to left or right.

### Vertical Position

Shift the screen slightly up or down.

### Clock

Adjust the DB 15 Picture signal sampling clock rate.

### Phase

Adjust the DB 15 Picture signal sampling phase. It maybe affect the definition. Wrong value maybe result the interference.

### Reset

Reset the parameters of current menu to default value.

# TV SETUP

## Advanced Picture Settings

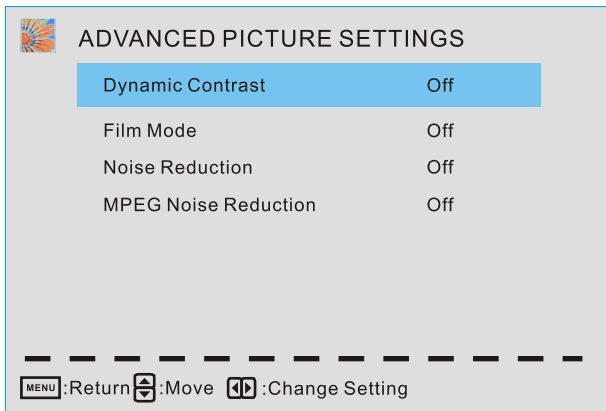

Press ▲/▼ to highlight the item and press ENTER or ► to display the submenu as following.

### **Dynamic Contrast** Off/ On

The system will adjust the luminance curve by analyzing the picture content dynamically.

### **Film Mode** Off/ On

For the 2:2 or :2 format signal of cinema, enable special pixel process to reduce the flick of moving area.

### **Noise Reduction** Off/ Low/ Medium/ High

You can clear up analog TV signal by reducing the dot noise. This feature is not available at PC source.

### **MPEG Noise Reduction** Off/ Low/ Medium/ High

Similar with the Noise Reduction, you can set to reduce the block noise.

# TV SETUP

## Sound Menu

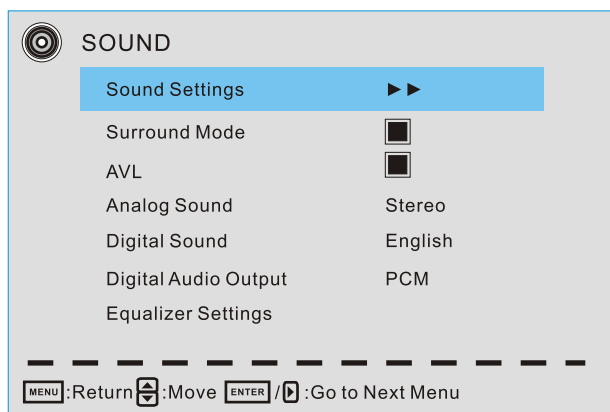

### Sound Settings

Set the sound mode, and Bass/ Treble/ Balance.

### Surround Mode

Set to enjoy the virtual surround sound. Press **ENTER** to set or cancel.

### AVL

Auto Volume Level. Press **ENTER** to set or cancel. When AVL is set on, it will limit the sound being heard when sudden changes in volume occur during commercial breaks or channel changes.

Usually be enabled at night.

### Analog Sound

Available at analog TV channels, SAP/ Stereo/ Mono

Set the preferred sound track of analog channels. Stereo and SAP exist on some channels. Generally SAP is a second language sound or help the people with hearing impair.

### Digital Sound

Available at digital TV channels, English/ French/ Spanish

Set the preferred sound track of digital channels, French and Spanish exist on some channels.

### Digital Audio Output PCM/ Raw/ Off

Set the audio output type of coax or optical terminal. Raw means output the original format of audio stream. PCM can be matched with most AV amplifiers.

### Equalizer Settings

Adjust the curve of 7 bands equalizer.

# TV SETUP

## Sound Settings

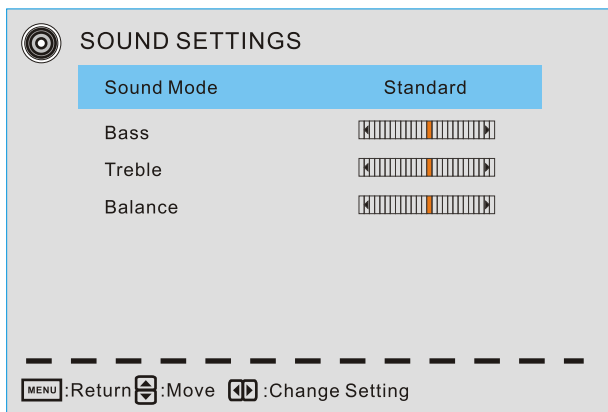

**Sound Mode** Standard/ Soft/ User/ Dynamic

Only in User mode, the following items can be adjusted.

### Bass

Adjust the low frequency band response.

### Treble

Adjust the high frequency band response.

### Balance

Adjust the level of sound coming from the left or right speaker.

### Adjust the Bass/ Treble/ Balance

- 1.Set sound mode to User.
- 2.Highlight the item and press ► to display the submenu, the press ◀/▶ to adjust the value.

# TV SETUP

## Equalizer Settings

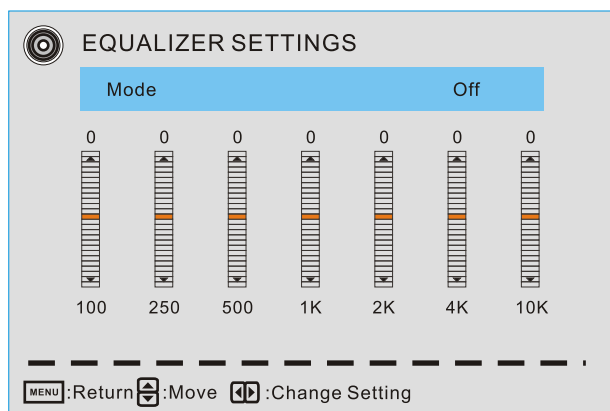

**Mode** Off/ Rock/ Pop/ Jazz/ User( only in User mode, the following can be manually adjusted.)

### Adjust Equalizer Settings

Based on your favorites about which frequency band need to be adjusted, make small adjustment with certain frequency band at a time. Suggest NOT making too large changes.

- 1.Set mode to User.
- 2.Press ▼ to select the first( 100Hz) item, then press ◀/▶ to select the band to be turned.
- 3.Press ▲/▼ to adjust the value.

## Channel Menu

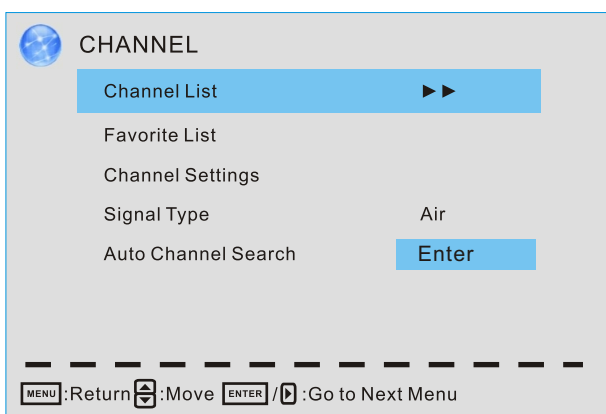

Note: The menu is available only at TV source.

# TV SETUP

## Channel List

You can view all the channels and choose one quickly.

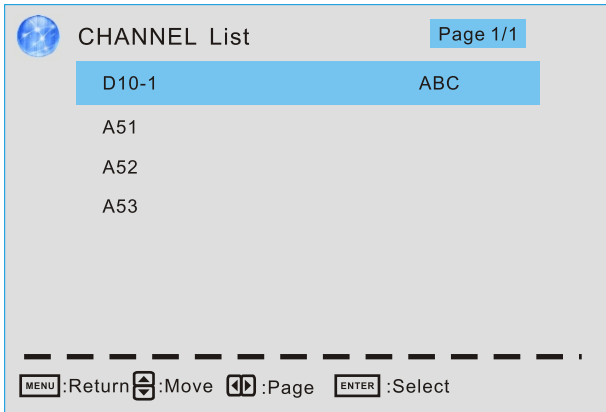

“ABC”: Label of the Channel.

Press ▲/▼ to highlight a channel and press ENTER to view it.

## Favorite List

All of you favorite channels are listed in this menu, and you can choose them quickly.

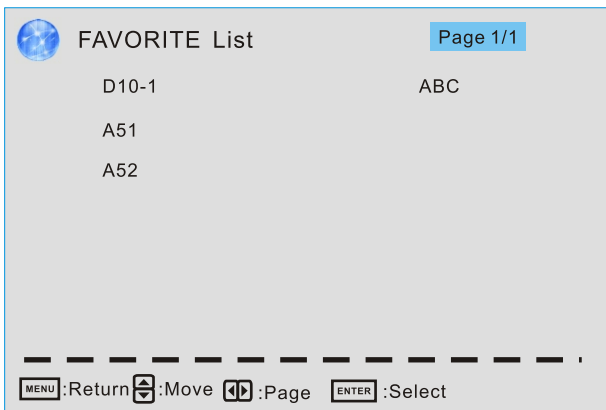

## Channel Setting

Set the favorite channels, skipped channels, label of channels.

## Signal Type

Set to Air or Cable according to your antenna source.

# TV SETUP

## Auto Channel Search

Highlight and press ENTER to start the auto searching.

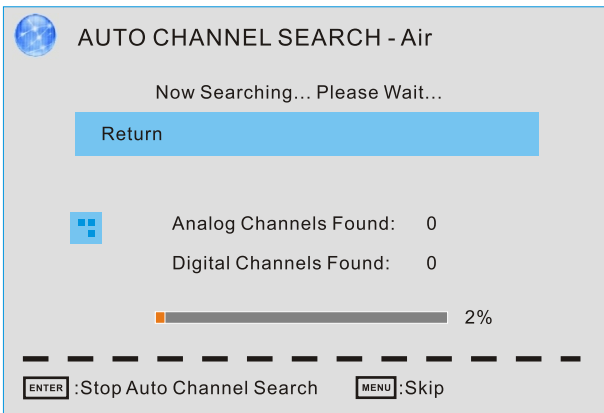

It will search analog channels first, then digital channels.

Before execute auto channel search, please confirm your antenna type is Air or Cable.

Wrong setting of Signal Type maybe cause finding no channel.

## Channel Settings

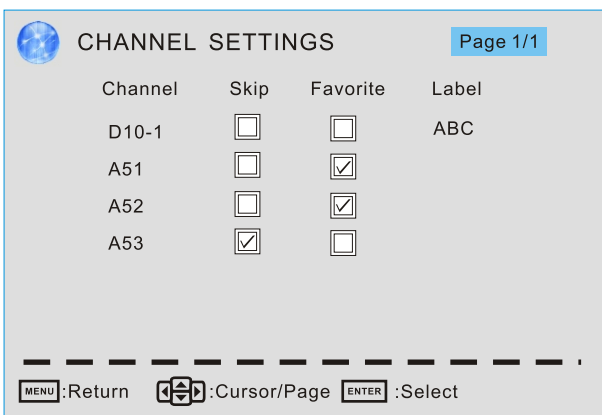

### Skip

Set the channel to be skipped when using CH+/CH- to view channels.

### Favorite

Set the channel to your favorite list.

### Label

Rename label of the channel.

## Change the settings

### Skip & Favorite

1. Press ▲/▼ to select the channel you want to set.
2. Press ◀/▶ to highlight corresponding item, and press ENTER to set or cancel.

### Label

1. Press ▲/▼ to select the channel and ENTER to enter the edit state.
2. Press ▲/▼ to select the character, press ◀/▶ to move the cursor. Total seven letters.

# TV SETUP

## Parental Control

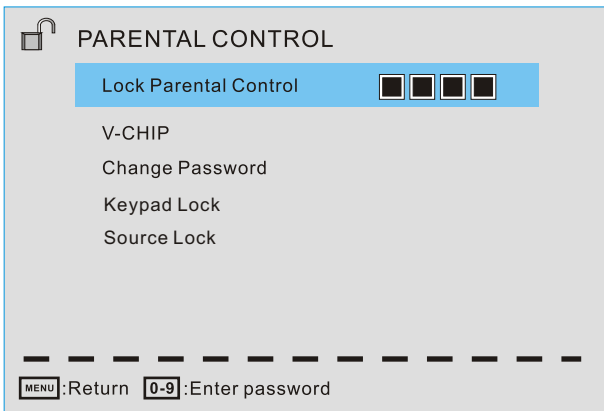

Note: The default user password is "0000", and if forget what you set, try"1470".

### Lock Parental Control

The following items are only available if the password input is correct.

**V-CHIP** Include below settings:

#### US V-Chip

Rating system used at USA.

#### Canada V-Chip

Rating system used at Canada.

#### Block UnRated Show

Control whether lock the program that have not any valid rating flag.

#### Downloadable Rating

Control the RRT5 setting which are valid only at some digital cable channels.

#### Clear Downloadable Data

Select to clear the previous downloadable rating data.

### Change Password

Enter a 4-digital number you want to set.

### Keypad Lock

Select to Lock or unlock the keypad.

### Source Lock

Select the Source Lock or unlock.



# TV SETUP

## US V-CHIP

For the United States, the rating setting basically include the following options:  
Movie Rating, TV Rating.

### Moive Rating

This system defines the rating control which come from MPAA rules

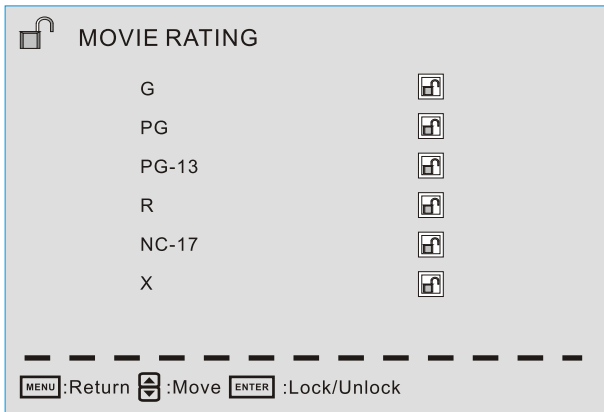

Rating	Define
G	General audience. All ages admitted.
PG	Parental guidance suggested . Some material may not be suitable for child ren.
PG-13	Parents strongly cautioned. Some material may be inappropriate for children under 13.
R	Restricted. Children under 17 require accompanying parent or adult guardian.
NC-17	No one 17 and under admitted
X	Adult audience only.

# TV SETUP

## TV Rating

The TV rating compose of two aspects: age-based and content-based.

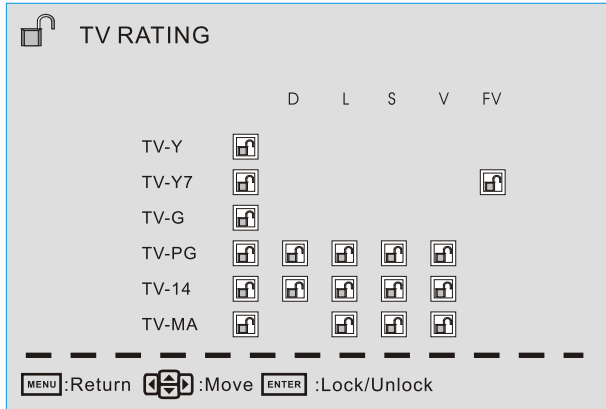

Content	Define
FV	Fantasy violence
D	Suggestive dialogue
L	Strong language
S	Sexual situations
V	Violence

Age	Define
TV-Y	General audience
TV-Y7	Parental guidance suggested
TV-G	Parents strongly cautioned
TV-PG	Retricted
TV-14	No one 17 and under admitted
TV-MA	Adult audience only

Note: The content ratings will increase depending on the level of the age-based rating. For example, a program with a TV-PG V(violence) rating may contain moderate violence, while a TV-14 V(violence)rating may contain intense violence. So locking a higher level option will automatically cause locking the option that has more sensitive level.

# TV SETUP

## Canada V-CHIP

For Canada, the rating setting include the following options: English rating, French Rating.

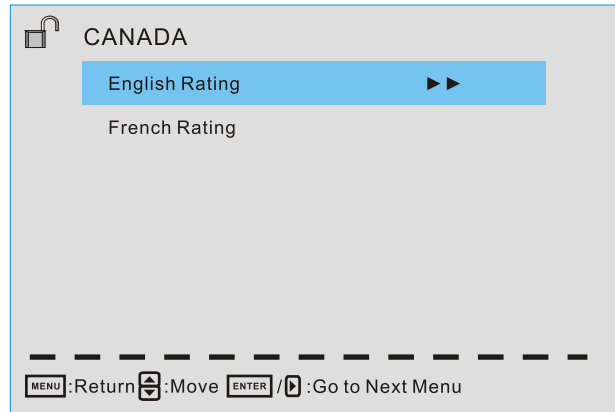

## English Rating

These ratings are for programs which are using English rating system.

Rating	Defined as
C	Children
C8+	Children 8 years and older
G	General programming
PG	Parental guidance
14+	Viewers 14 and older
18+	Adult programming

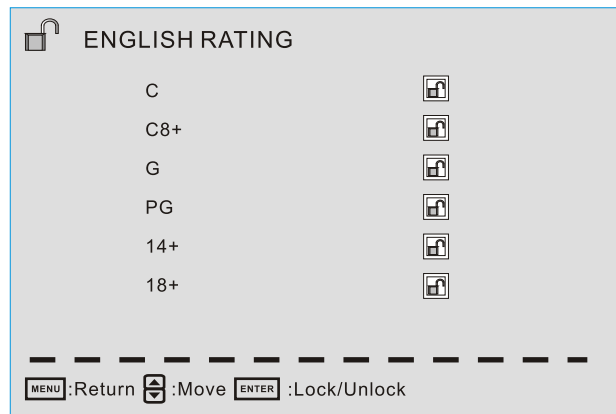

## French Rating

These ratings are for programs which are using French rating system.

Rating	Defined as
G	General
8 ans+	Not recommended for younger children
13 ans+	Not recommended for children under age 13
16 ans+	Not recommended for ages under 16
18 ans+	This program is restricted to adults

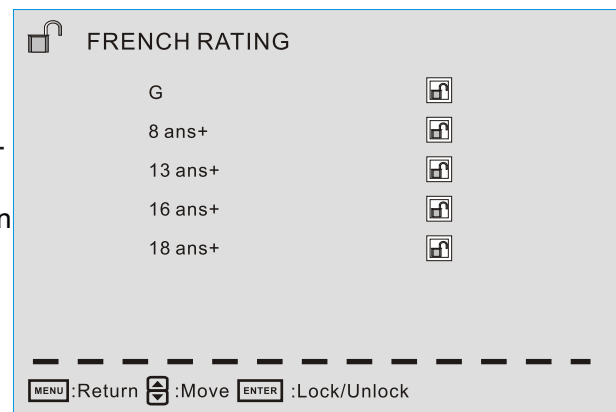

# TV SETUP

## Change Password

At first you should enter the correct old password then enter new password twice.

If you lost your password, try to enter "1470".

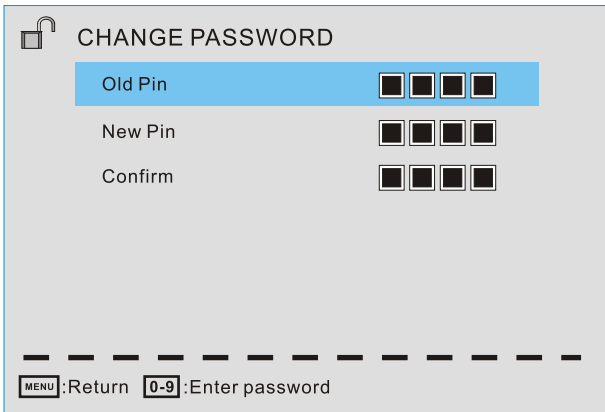

## Setup Menu

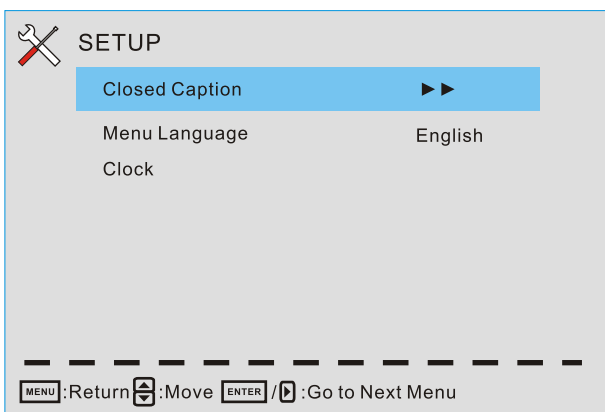

## Closed Caption(CC)

### Menu Language

Set the menu language. English/French/Spanish.

### Clock

Set the Time Zone/ Auto Clock/ Setup Time/ Day of week/ Daylight Saving Time.

## Caption Display

Display or hide the CC .

## Analog Caption Type

Select from closed-caption modes for analog programs.

## Digital Caption Type

Applies only to digital channels with closed caption.

## Digital CC Preset Default/Custom

If set to Custom, Digital CC Style is available.

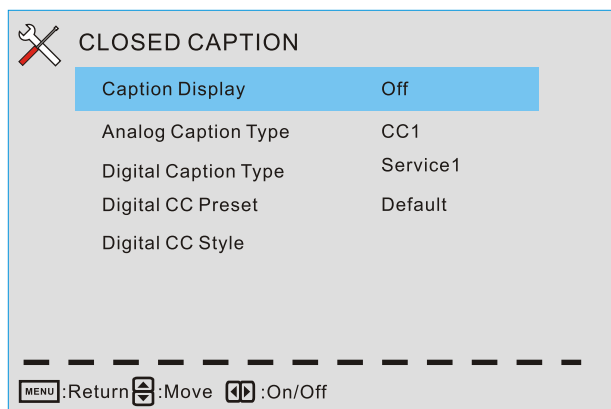

# TV SETUP

## Digital CC Style

This menu is valid only for digital closed caption of digital channels.

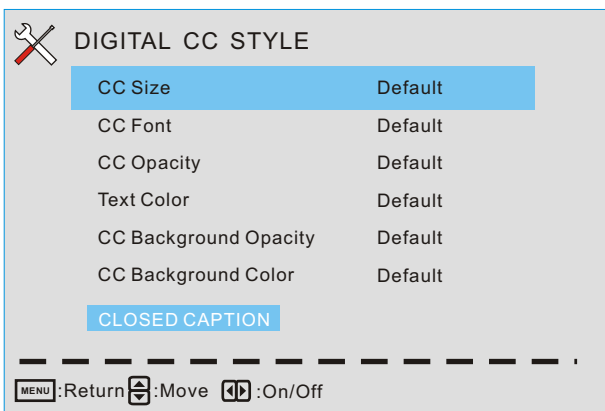

CC Size Small/Standard/Large/Default

CC Font Style 0~7, Default

CC Opacity Default/Solid/Flashing/Translucent/Transparent/Default.

Text Color Black/White/Red/Green/Blue/Yellow/Magenta/Cyan/Default.

CC Background Opacity Solid/Flashing/Translucent/Transparent/Default.

CC Background Color Black/White/Red/Green/Blue/Yellow/Magenta/Cyan/Default.

## Clock

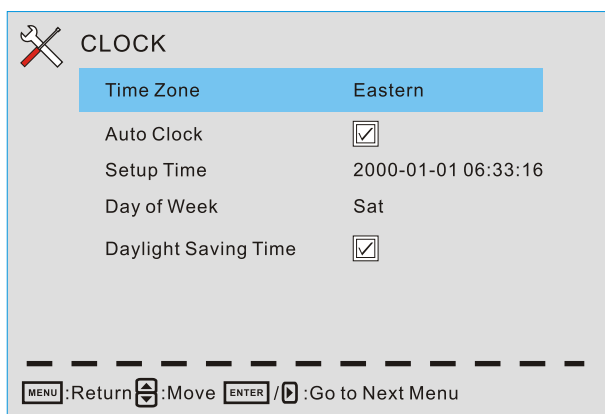

**Time Zone** Hawaii/Alaska/Pacific/Central/Mountain/Eastern/Samoa/Newfoundland/Atlantic  
Set the time zone.

### Auto Clock

If set it to ON, the TV will sync the local clock according to the DTV broadcasting time automatically. Otherwise you can set the time manually.

### Setup Time

Set Auto Clock to Off, then you can set the time manually.

Note: In the case of loss of power, the clock setting will be lost

### Day of Week

The TV will calculate current day of week according to the time.

### Daylight Saving Time

When Auto Clock set to ON, this item is available to enable daylight saving option or not.

# TV SETUP

## Ohters Menu

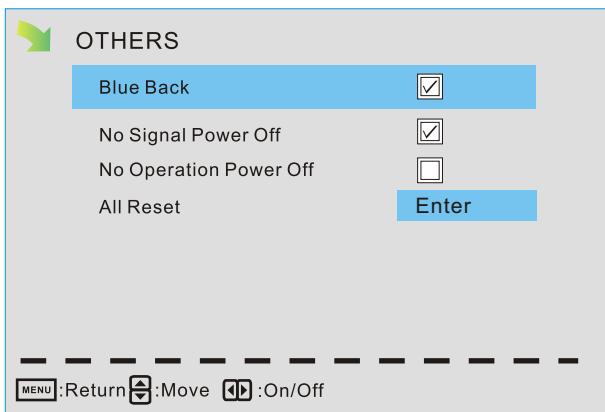

### Blue Back

Set the screen background color blue or not when no valid signal input. When analog TV input and has no signal, snow noise will display if this option is cleared.

### No Signal Power Off

If it is set, TV will automatically enter standby after 10 minutes without signal input.

### No Operation Power Off

If it is set, TV will automatically enter standby after 3 hours without any operation.

### All Reset

When you highlight the item, the system will note you that "Attention! If [All Reset] was executed, TV system is reset" , and if you are sure to reset, press ENTER to reset .

### Audio Only

When you highlight the item, the system will note you that "Attention! Hold on power key 3 second to restore video", and if you are sure not need to view (backlight is turned off), press ENTER to confirm. As the attention, if you want to wake up the video, please hold on the power button for 3 seconds.

## DISPLAY MODE

### PC FORMATS

SUPPORTED PC INPUT MODE			
Resolution	Horizontal Scanning Frequency (KHz)	Vertical Scanning Frequency (Hz)	Format
640 X 480	31.5	60.0	DOS
800 X 600	35.1	56.2	VESA
800 X 600	37.9	60.0	VESA
1024 X 768	48.4	60.0	VESA
1360 X 768	47.7	60.0	VESA
1920 x 1080	66.6	60.0	VESA

**NOTE:**

This product does not support the display mode not listed above. In order to achieve the best display effect, please select the above-listed 6 display modes input signal.

Because of the difference of display drivers output signal (especially non-standard signal output), the display image may appear little disturbance which can be adjusted on the PC menu.

To prolong this unit's service life, please set your computer to power management mode.

## DISPLAY MODE

### VIDEO FORMATS

SUPPORTED COMPONENT / HDMI INPUT MODE			
Resolution	Horizontal Scanning Frequency ( KHz )	Vertical Scanning Frequency (Hz)	Format
720 x 480	31. 47	59. 94	480 i
720 x 480	15. 734	59. 94	480 p
1280 x 720	37. 5	50	720 p
1280 x 720	45	60	720 p
1920 x 1080	31. 25	50	1080 i
1920 x 1080	33. 75	60	1080 i
1920 x 1080	27	24	1080 p
1920 x 1080	56. 25	50	1080 p
1920 x 1080	67. 50	60	1080 p

**NOTE:**

The above listed formats are also related to the AV devices you are about to connect. Before you connect this unit with others please read all instructions carefully and make sure all necessary cables are connected.

This unit may be incompatible with some other formats which are not meet the above conditions.



# SPECIFICATION

Model Description		50"LCD TV
Panel	Panel Type	LCD Panel
	Diagonal Size	50 inches
	Screen Format	16:9
	Resolution	1920 x1080
	Brightness	350 nit
	Contrast	4000:1
	View Angle	178(H)/178(V)
	Response Time	8 ms
	Maximum Color	16. 7M colors
	Refresh Rate	60Hz
Systems	Color System	ATSC/QAM/NTSC
	Sound System	M
	Audio System	MTS
	Sound Output	L/R Speaker: 10 W + 10W
Input / Output Jacks	RF Input	75 ohm external terminal
	HDMI Input	Video: 480i, 480p, 720p, 1080i, 1080p. Audio: Two channel linear PCM 32, 44.1 and 48kHz, 16, 20 and 24 bits
	PC-RGB Input	D-sub 15pin G: 0.7Vp-p, 75ohms B: 0.7Vp-p, 75ohms R: 0.7Vp-p, 75ohms
	Composite Video Input	1.0 Vp-p, 75ohms RCA
	Component/Y Pb Pr Input	RCA Y: 1.0 Vp-p, 75ohms, 0.3V negative sync Pb: 0.7Vp-p, 75ohms Pr: 0.7Vp-p, 75ohms
	Sound Input	Component AUDIO: For Component Audio input AV AUDIO: For CVBS Audio input PC AUDIO: For PC RGB Audio input 500mV rms, Impedance: 20k ohms
Power	Power Requirement	100-240V~ 50/60Hz
	Power consumption	200W

This manual is only for your reference.  
Specifications are subject to update without prior notice.

## TROUBLESHOOTING GUIDE

### SYMPTOM

### CAUSE (AND REMEDY )

TV

Bad Picture (snow, multiple images distortion, blurry)

- Check the location of the antenna and adjust it if necessary.
- Make sure the antenna cable is firmly connected.
- Make sure all input cables are firmly connected.

No sound.

- Increase the volume.
- Check whether the mute function has been activated on the Remote Control.

Black and White picture.

- Check the PICTURE setting within the PICTURE menu.
- Check to make sure the program you are watching is broadcast in Color and not Black & White.

No picture or sound.

- Make sure the unit is plugged in and turned on.
- Make sure that the ATV mode is selected.
- Try a new channel to check for possible station trouble.
- Make sure the antenna is connected properly.
- Increase the volume.
- Make sure the antenna or audio/video source device is working properly.
- Make sure all cables are firmly connected.
- Check for local interference.

Colored patches of picture.

- Make sure there are no unshielded electrical devices nearby that are causing interference.
- Turn the TV off for 30 minutes, then try it again.

Panel function key does not respond correctly.

- Under the influence of electrostatic phenomenon, the product may malfunction and require user power reset.
- Unplug and re-plug the AC power cord.

The display monitor's panel goes hot.

- LCD TV takes inside light phosphor. It may increase the temperature of the screen in some occasions. It's not a defect.

Unusual dots

- Black dots and Bright points may appear on the LCD screen. This is a structural property of the LCD panel and is not a defect.

Stripes on screen

- Adjust the impulse phase may decrease stripes. RGB in

The top of the monitor gets hot.

- It may occur during long-time working. It's not a defect.

Unable to select a certain channel.

- The channel may be skipped. Choose this channel by directly selecting the buttons from the remote control.

Disorder display at power on.

- This may be caused because of a very short interval between POWER OFF and ON.
- Unplug the power and restart.



[www.westinghousedigital.com](http://www.westinghousedigital.com)



S/N: \_\_\_\_\_



Westinghouse Digital, LLC  
Orange, CA

SE-UM-5001-1201

## Free Manuals Download Website

<http://myh66.com>

<http://usermanuals.us>

<http://www.somanuals.com>

<http://www.4manuals.cc>

<http://www.manual-lib.com>

<http://www.404manual.com>

<http://www.luxmanual.com>

<http://aubethermostatmanual.com>

Golf course search by state

<http://golfingnear.com>

Email search by domain

<http://emailbydomain.com>

Auto manuals search

<http://auto.somanuals.com>

TV manuals search

<http://tv.somanuals.com>