



**USER'S MANUAL**  
*MANUEL DE L'UTILISATEUR*  
*MANUAL DEL USUARIO*

**LD-3260**

## TABLE OF CONTENTS

TABLE OF CONTENTS .....	i
DIGITAL TELEVISION TRANSITION NOTICE .....	1
IMPORTANT INFORMATION .....	2
Warnings .....	2
NOTICES .....	3
FCC COMPLIANCE STATEMENT .....	4
IMPORTANT SAFETY INSTRUCTIONS .....	5
Circuit Overload .....	6
Power Cord Protection .....	6
Ventilation .....	6
WARNINGS AND PRECAUTIONS .....	7
ANTENNA INSTALLATION SAFETY .....	8
Lightning .....	8
Power lines .....	8
CLEANING THE LED TV .....	9
Dolby-Digital Notice .....	9
SRS Trademark Information: .....	9
PACKAGE CONTENTS .....	10
CONTROL PANEL .....	11
TERMINALS .....	12
REMOTE CONTROL .....	13
REMOTE CONTROL OPERATION .....	14
INSTALLING THE REMOTE CONTROL BATTERIES ..	14
REMOTE CONTROL TRANSMISSION RANGE .....	14
LED TV BASE .....	15
INSTALLING THE LED TV BASE .....	15
REMOVING THE LED TV BASE .....	16
ANTENNA CONNECTION .....	17
OUTDOOR ANTENNA CONNECTION .....	17
CABLE TV (CTV/DTV) CONNECTION .....	17
EXTERNAL DEVICE CONNECTIONS .....	18
POWER CONNECTION .....	20

CONNECTING AC POWER .....	20
INITIAL SETUP .....	20
WESTINGHOUSE HDTV SETUP .....	21
WESTINGHOUSE HDTV SETUP - THROUGH CABLE/ SATELLITE BOX .....	22
WESTINGHOUSE HDTV SETUP - NOT THROUGH CABLE/ SATELLITE BOX.....	25
BASIC OPERATIONS .....	28
TURNING THE POWER ON AND OFF .....	28
ADJUSTING THE VOLUME .....	28
CHANGING CHANNELS .....	29
SELECTING THE INPUT SOURCE .....	29
ADJUSTING THE DISPLAY FORMAT .....	30
ADJUSTING THE LED BACKLIGHT .....	30
SETUP MENUS .....	31
SETUP MENU OPERATION .....	31
PICTURE .....	32
AUDIO .....	36
VIEW MODE .....	40
VIEW MODE (VGA) .....	40
TV PROGRAM .....	42
SETTINGS .....	46
WALL MOUNT OPTION .....	57
WALL MOUNT INSTALLATION REMINDERS .....	57
TROUBLESHOOTING .....	58



## **DIGITAL TELEVISION TRANSITION NOTICE**

This device contains a digital television tuner, so it should receive digital over the air TV programming, with a suitable antenna, after the end of full-power analog TV broadcasting in the United States on June 12, 2009. The nationwide switch to digital television broadcasting will be complete on June 12, 2009, but your local television stations may switch sooner. After the switch, analog-only television sets that receive TV programming through an antenna will need a converter box to continue to receive over-the-air TV. Watch your local stations to find out when they will turn off their analog signal and switch to digital-only broadcasting.

For more information, call the FCC at 1-888-CALL-FCC (1-888-225-5322) or see [www.DTV.gov](http://www.DTV.gov). For information on the TV Converter program, and on government coupons that may be used toward the purchase of one, see [www.dtv2009.gov](http://www.dtv2009.gov), or call the NTIA at 1-888-DTV-2009.

## IMPORTANT INFORMATION

### Warnings

To reduce the risk of fire or electric shock:

- Do not expose this product to rain or moisture.
- Do not remove the rear cover. There are no user-serviceable parts inside. Refer all servicing requirements to qualified service personnel.
- The plug should be connected to a mains socket outlet with a protective earthing connection.



The lightning flash with arrowhead inside an equilateral triangle symbol is intended to alert the user to the presence of uninsulated dangerous voltage within the product's enclosure that may be of sufficient magnitude to constitute a risk of electric shock.



The exclamation inside an equilateral triangle symbol is intended to alert the user to related operating and maintenance instructions in the user documentation accompanying the product.

#### **WARNING!**

This device must be operated with the original power supply.

#### **WARNING!**

To prevent injury, this apparatus must be securely attached to the floor/wall in accordance with the installation instructions.

#### **CAUTION:**

The power supply outlet should be located near the LED TV and should be easily accessible.

Always use the appropriate AC cord that is certified for your specific country. Some examples are listed below:

- USA – UL
- Canada – CSA
- Japan – Electric Appliance Control Act

**NOTICES**

Important Notices Concerning Power Cord Selection

The specific power cord for this LED TV is enclosed and has been selected according to the country of destination. Use the enclosed power cord to prevent electric shock. Observe the following guidelines if it is necessary to replace the original cord set, or if there is no cord set enclosed. The female receptacle of the cord set must meet IEC-60320 requirements and should look like Figure A1 below:



For the United States and Canada

In the United States and Canada the male plug is a NEMA5-15 style (Figure A2), UL-listed, and CSA-labeled. For LED TVs that are to be placed on a desk or table, type SVT or SJT cord sets may be used. For LED TVs that are to be placed directly on the floor, only SJT type cord sets may be used. The cord set must be selected according to the current rating for the LED TV. Consult the table below for the selection criteria of power cords used in the United States and Canada.

Cord Type	Size of Conductor in Cord	Maximum Unit Current Rating
SJT	18 AWG	10 Amps
	16 AWG	12 Amps
	14 AWG	12 Amps
SVT	18 AWG	10 Amps
	17 AWG	12 Amps

## **FCC COMPLIANCE STATEMENT**

This equipment has been tested and complies with the limits for a Class B digital device, pursuant to part 15 of the FCC Rules. These limits are designed to provide reasonable protection against harmful interference in a residential installation. This equipment generates, uses, and can radiate radio frequency energy, and may cause harmful interference to radio communications if not installed and used in accordance with the instructions. However, there is no guarantee that interference will not occur in a particular installation. If this equipment does cause harmful interference to radio or television reception, which can be determined by turning the equipment off and on, the user is encouraged to try to correct the interference by one or more of the following measures:

- Reorient or relocate the receiving antenna.
- Increase the distance between the LED TV and the receiver.
- Connect the LED TV to an outlet on a circuit separate from to which the receiver is connected.
- If the interference persists even after performing the above measures, consult the Westinghouse Service Center or an experienced radio/TV technician for assistance.

### **FCC Warning**

To assure continued FCC compliance, use a grounded power supply cord and the provided shielded video interface cable with bonded ferrite cores. If a BNC cable is used, use only a shielded BNC (5) cable. Also, any unauthorized changes or modifications not expressly approved by the manufacturer will void the user's authority to operate this device.



## IMPORTANT SAFETY INSTRUCTIONS

Make sure to note and follow all warnings and instructions marked on the LED TV. Observe the following safety instructions.

- Read these instructions.
- Keep these instructions.
- Heed all warnings.
- Follow all instructions.
- Do not use this apparatus near water.
- Clean only with dry cloth.
- Do not block any ventilation openings. Install in accordance with the manufacturer's instructions.
- Do not install near any heat sources such as radiators, heat registers, stoves, or other apparatus (including amplifiers) that produce heat.
- Do not defeat the safety purpose of the polarized or grounding-type plug. A polarized plug has two blades with one wider than the other. A grounding type plug has two blades and a third grounding prong. The wide blade or the third prong are provided for your safety. If the provided plug does not fit into your outlet, consult an electrician for replacement of the obsolete outlet.
- Protect the power cord from being walked on or pinched particularly at plugs, convenience receptacles, and the point where they exit from the apparatus.
- Only use attachments/accessories specified by the manufacturer.
- Use only with the cart, stand, tripod, bracket, or table specified by the manufacturer, or sold with the apparatus. When a cart is used, use caution when moving the cart/apparatus combination to avoid injury from tip-over.



- Unplug this apparatus during lightning storms or when unused for long periods of time.
- Refer all servicing to qualified service personnel. Servicing is required when the apparatus has been damaged in any way, such as power-supply cord or plug is damaged, liquid has been spilled or objects have fallen into the apparatus, the apparatus has been exposed to rain or moisture, does not operate normally, or has been dropped.

## IMPORTANT INFORMATION

---

### Circuit Overload

Do not overload wall outlets, extension cords, or power strips. This can result in a fire or electronic shock.

### Power Cord Protection

Power supply cords should be routed so that they are not likely to be walked on or pinched by items placed upon or against them. Periodically inspect the cords for damage. Install the LED TV near a wall socket outlet where the power cord can be readily accessed.

### Ventilation

The slots and openings on the cabinet are provided for necessary ventilation. To ensure reliable operation of the LED TV and to protect it from overheating, these slots and openings must never be blocked or covered.



Never cover the slots and openings with a cloth or other materials.

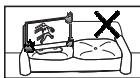

Do not block the openings by placing the LED TV on a bed, sofa, rug or other similar surface.



Do not place the LED TV in a built-in installation such as a bookcase or a rack unless proper ventilation is provided or the manufacturer's instructions have been adhered to.

## WARNINGS AND PRECAUTIONS

- Do not orient the LED TV towards direct sunlight to reduce glare.
- If the LED TV will not be used for a long period of time, unplug the unit and remove the batteries from the remote control.
- Avoid touching the display screen by hand or any object.
- Never remove the rear cover. The LED TV interior contains high-voltage parts. You may be seriously injured if you touch them.
- Always handle the LED TV with caution when moving it.
- Do not install the LED TV in airtight compartments, or in areas where it can be exposed to water or high temperature.
- Ensure that the area around the LED TV is clean and free of moisture.
- Do not place anything on the LED TV that can hinder heat dissipation.
- Do not place naked flame sources, such as lighted candles, on or near the LED TV.
- Do not place anything on the LED TV that can cause liquid to splash on it (e.g. flower vase).
- Do not place heavy objects on the LED TV, audio/video cables, or power cord.
- If the LED TV emits smoke, abnormal noise, or a strange odor, immediately turn it off and contact the Westinghouse Service Center by:
  - Logging on to [www.wde.com](http://www.wde.com).
  - Contacting the Westinghouse Customer Service at (800) 701-0680.
  - E-mailing us at [service@wde.com](mailto:service@wde.com).

## ANTENNA INSTALLATION SAFETY

### Outdoor Antenna Grounding

If an outside antenna or cable system is connected to the LED TV, be sure the antenna or cable system is grounded to prevent voltage surges and built-up static charges. Article 810 of the National Electrical Code, ANS/NFPA 70, provides information on proper grounding of the mast and supporting structure, grounding of the lead-in wire to an antenna discharge unit, connection to grounding electrodes, and requirements for the grounding electrode.

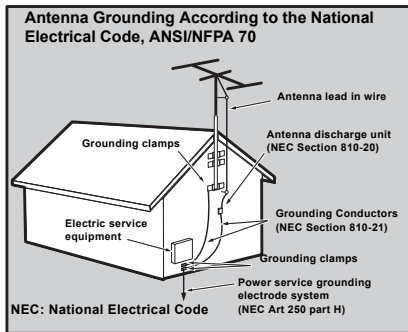

### Lightning

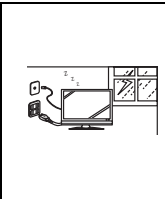

For added protection for the LED TV during a lightning storm, or when it is left unattended and unused for long periods of time, unplug it from the wall outlet and disconnect the antenna or cable system. **DO NOT** disconnect the antenna or the power cord during a heavy storm—lightning may strike while you are holding the cable cord, causing serious injury. Turn off the LED TV and wait for the weather to improve.

### Power lines

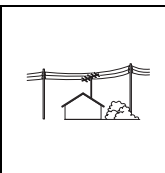

An outside antenna system should not be located in the vicinity of overhead power lines or other electric light or power circuits, or where it can fall into such power lines or circuits. When installing an outside antenna system, extreme care should be taken to keep from touching such power lines or circuits as contact with them might be fatal.

## CLEANING THE LED TV



- Make sure the LED TV is turned off and the power cord is disconnected from the power outlet.
- Never spray or pour any liquid directly onto the screen or the case.

### To clean the screen:

- 1 Wipe the screen with a clean, soft, lint-free cloth. This removes dust and other particles.
- 2 If it is still not clean, apply a small amount of non-ammonia, non-alcohol based glass cleaner onto a clean, soft, lint-free cloth, and wipe the screen.

### To clean the case:

- 1 Wipe the case with a soft, dry cloth.
- 2 If it is still not clean, apply a small amount of non-ammonia, non-alcohol based, mild non-abrasive detergent onto a clean, soft, lint-free cloth, then wipe the surface.

## Dolby-Digital Notice



Manufactured under license from Dolby Laboratories. Dolby and the double-D symbol are registered trademarks of Dolby Laboratories.

### **SRS Trademark Information:**

- TruSurround HD, SRS and the  symbol are trademarks of SRS Labs, Inc.
- TruSurround HD technology is incorporated under license from SRS Labs, Inc.

SRS TruSurround HD™ creates a truly immersive surround sound experience with rich bass and clear dialog from only two speakers.



---

## IMPORTANT INFORMATION

### Open Source License

This product includes software code developed by third parties, and may include software code that is subject to open source software license such as the GNU General Public License (GPL) or the GNU Lesser General Public License (LGPL).







Open source licenses ensure users' freedom to run, copy, distribute, study, change and improve the software. Any such open source code is subject to the copyrights of one or more authors.

The terms of the GPL and LGPL, and access to any GPL Code, LGPL Code, or other open source code used in this product, are available to you at: <http://westinghousedigital.com/compliance/>.

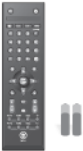
Any open source software used in this product and licensed under the GPL, LGPL, or other open source license is distributed WITHOUT ANY WARRANTY and WITHOUT ANY SUPPORT by Westinghouse Digital.

---

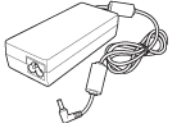
## PACKAGE CONTENTS

32" LED TV Unit	Remote Control (with 2x AAA batteries)
	
LED TV Base	User Manual
	
Power Cord	Warranty Card
	
AC Adapter	Screws for Base
	<p>M4x18 *4pcs      M5x16 *1pc</p>   <p>Cover neck      Base</p>

## CONTROL PANEL

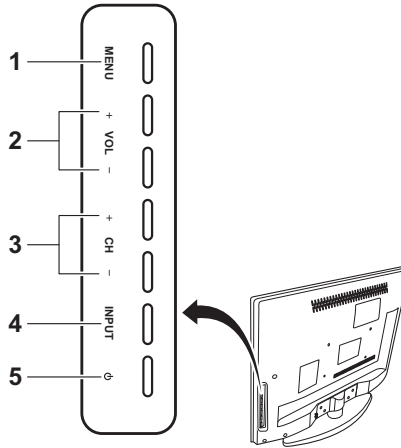

Item	Description
1. MENU	Displays the LED TV setup screen.
2. Volume +/-	<ul style="list-style-type: none"> <li>Adjusts the volume during playback.</li> <li>Selects an item on a menu screen.</li> </ul>
3. Channel +/-	<ul style="list-style-type: none"> <li>Switches the channel during TV viewing.</li> <li>Selects an item on a menu screen.</li> </ul>
4. INPUT	<ul style="list-style-type: none"> <li>Selects the video input source.</li> <li>Executes a command on a menu screen.</li> </ul>
5. Power	Toggles the power on and off.



## TERMINALS

English

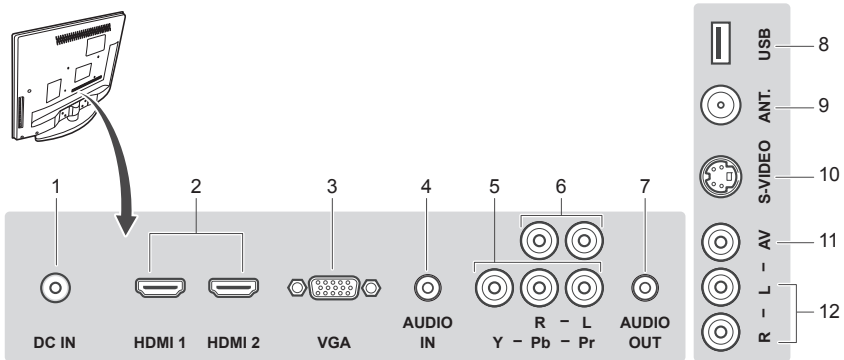

Item	Function
1. DC in	Connects the AC adapter from this outlet to a power source.
2. HDMI 1/2	Connects to an external AV device such as a VCR, DVD player, set-top box, or game system.
3. VGA	Connects to a computer or other device with a VGA output using a 15-pin VGA cable.
4. Audio in	Connects to the audio out port of a computer.
5. Component input (Video)	Connect to an external AV device such as a VCR, DVD player, set-top box, or game system.
6. Component input (Audio)	Connect to an external AV device such as a VCR, DVD player, set-top box, or game system.
7. Audio out	Connect to an audio output device.
8. USB Service port	For service only.
9. TV tuner	Connects the LED TV to an antenna or cable service.
10. S-Video input	Connect to an external AV device such as a VCR, DVD player, set-top box, or game system.
11. Composite input (Video)	Connect to an external AV device such as a VCR, DVD player, set-top box, or game system.
12. Composite input (Audio)	Connect to an external AV device such as a VCR, DVD player, set-top box, or game system.

# REMOTE CONTROL

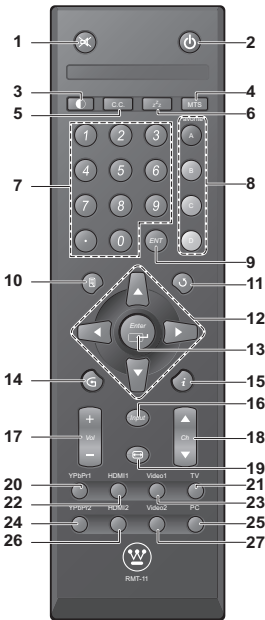

Item	Description
1. Mute	Mutes the sound. Press again to toggle the sound back on.
2. Power	Toggles the TV power on or off.
3. Backlight	Adjusts the LED screen backlight.
4. MTS	Toggles the Multichannel Television Sound options.
5. CC	Toggles the closed caption display on or off.
6. Sleep <b>z</b> <b>z</b>	Sets the sleep timer for the LED TV to turn off automatically.
7. Channel keys	Use to key in the channel number.
8. Favorite	Switches to the favorite channels (for details on how to save a new favorite channel, see page 29).
9. Enter <b>ENT</b>	Executes a channel entry.
10. Menu	Accesses the LED TV setup menus.
11. Return	Switches to the last selected channel.
12. Arrow keys	Navigate through the on-screen menus.
13. Enter	Executes a command.
14. G	Displays the Electronic Program Guide (EPG). It contains the program information for the channel you're watching.
15. Info <b>i</b>	Displays the input source or channel information as well as the system date and time.
16. Input	Selects the video input source.
17. Vol +/-	Adjusts the system volume.
18. Ch	Switches to other TV channels.
19. Aspect ratio	Selects the video display format.
20. YPbPr1	Selects VGA-Component as the input source.
21. TV	Selects TV or HDTV as the input source.
22. HDMI1	Selects HDMI1 as the input source.
23. Video1	Selects the Composite AV device as the input source.
24. YPbPr2	Not supported.
25. PC	Selects VGA as the input source.
26. HDMI2	Selects HDMI2 as the input source
27. Video2	Not supported.

## REMOTE CONTROL OPERATION

### INSTALLING THE REMOTE CONTROL BATTERIES

**CAUTIONS:**

- Only use AAA batteries.
- Do not mix new and old batteries. This may result in cracking or leakage, which may pose a fire risk or lead to personal injury.
- Insert batteries according to the (+) and (-) markings. Inserting the batteries incorrectly may result in cracking or leakage, which may pose a risk of fire or lead to physical injury.
- Dispose of used batteries in accordance with local laws and regulations.
- Keep batteries away from children and pets.
- When the remote control will not to be used for an extended period, remove the batteries.

- 1 Remove the battery cover.
- 2 Insert the batteries. Make sure the (+) and (-) marks on the batteries match those inside the compartment.
- 3 Re-attach the battery cover.

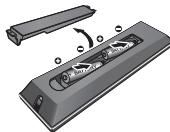

### REMOTE CONTROL TRANSMISSION RANGE

Transmission range depends upon the reception angle. The range of coverage is 20° horizontal/vertical at a distance of 10 feet from the LED TV.

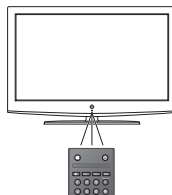

## LED TV BASE

**CAUTION:**

The LED TV unit may be too heavy for one person to lift. If this is the case, make sure to ask for assistance in handling the LED TV to prevent physical injury and/or damage to the unit.

### INSTALLING THE LED TV BASE

- 1 Open the LED TV carton box.
- 2 Remove the LED TV base.
- 3 Remove the plastic bag.
- 4 Remove the two top carton stabilizers from the LED TV.
- 5 Remove the protective plastic covering the LED TV.
- 6 Grasp the two sides of the LED TV and then pull it out of the carton box.
- 7 Remove the two bottom carton stabilizers from the LED TV.
- 8 Lay the LED TV on a clear, flat, and stable surface.
- 9 Align the base to the bottom side of the LED TV and use four M4 x 18 screws to secure it.

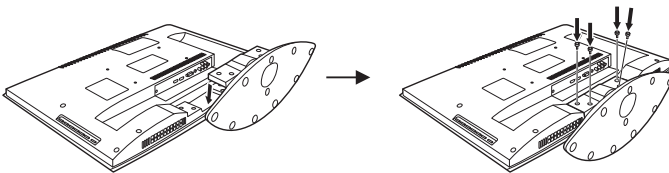

- 10 Carefully orient the LED TV in an upright position.

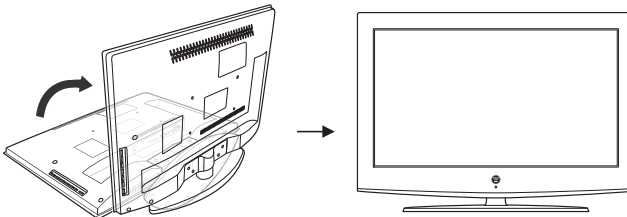

- 11 Use one M5 x 16 screw to fix the stand base and LED TV on the desk.

## REMOVING THE LED TV BASE

If you intend to repack the LED TV unit (for shipping or storage) or you want to change the installation to a wall mount option, you must first remove the LED TV base.

- 1 Turn off the LED TV and all connected devices.
- 2 Disconnect the power cord from the LED TV.
- 3 Disconnect all signal cables from the I/O port terminals.
- 4 Remove the M5 x 16 screw securing the base to the desk.
- 5 Lay the LED TV on a clear, flat, and stable surface.

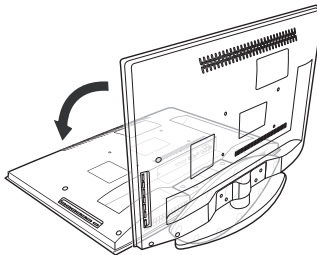

- 6 Remove the screws securing the base to the LED TV.
- 7 Detach the base from LED TV.

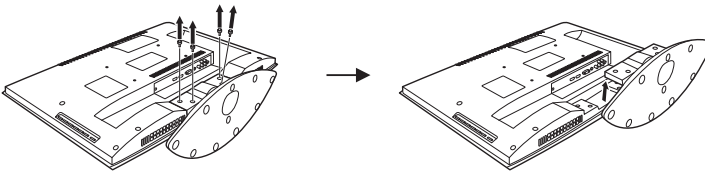

- 8 Pack the screws you removed in step 5 together with the LED TV base for future reassembly.

## ANTENNA CONNECTION

### OUTDOOR ANTENNA CONNECTION

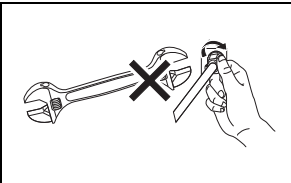
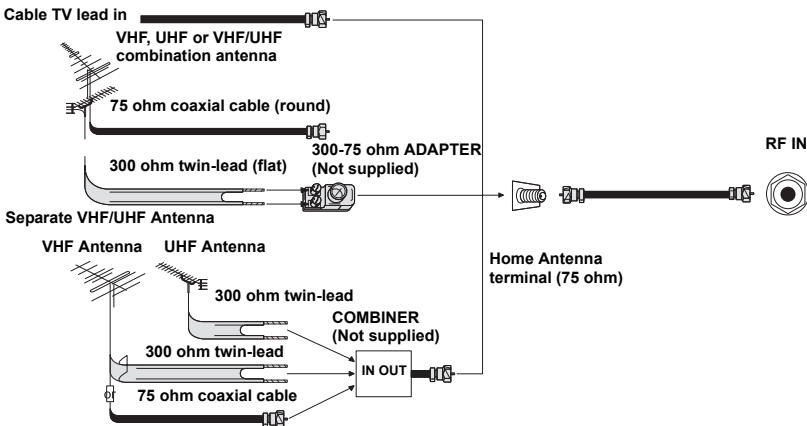

**NOTE:**

The F-type connector should be finger-tightened only. When connecting the RF cable to the LED TV, do not tighten F-type connector with any tool. If tools are used, it may cause damage to the LED TV (e.g. breaking of internal circuit).

### CABLE TV (CTV/DTV) CONNECTION

The unit has a TV tuner (75 ohm coaxial cable connector) located on the rear I/O panel for easy cable hookup. When connecting the 75 ohm coaxial cable to the unit, screw the 75 ohm cable to the TV tuner. Some cable TV companies offer premium pay channels. Since the signals of these channels are scrambled, a cable TV converter/descrambler is usually provided to the subscriber by the cable TV company. This converter/descrambler is necessary for normal viewing of the scrambled channels. (Set your TV to channel 3 or 4. Typically one of these channels is used. If a channel is unknown, consult your cable TV company.) For more specific instructions on installing cable TV, consult your cable TV company. One possible method of utilizing the converter/descrambler provided by your cable TV company is explained below.

## EXTERNAL DEVICE CONNECTIONS

- A position on the RF switch (not supplied) – You can view all unscrambled channels by using the TV's channel keys.
- B position on the RF switch (not supplied) – You can view the scrambled channels via the converter/descrambler by using the converter's channel keys.

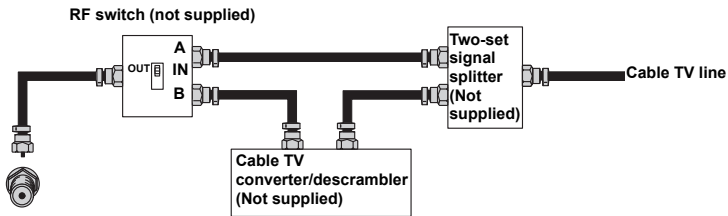

## EXTERNAL DEVICE CONNECTIONS

### IMPORTANT:

- Turn off the LED TV first before connecting an external device to prevent any possible damage or physical injury.
- For more information about external device connections, see the operation manual of the external device you wish to connect to the LED TV.
- Make sure that the correct cables are connected to each terminal. Improper cable connections may cause damage to the LED TV.

You can enjoy picture and sound by connecting various audio-video devices to the terminals located on the rear and side I/O panels of the LED TV.

- TV cable input – You can use a commercially available audio/video cable.
- Component (YPbPr) input – Picture can be displayed only when a 480i, 480P, 720P or 1080i signal is received.
- HDMI input – Picture can be displayed only when a 640 x 480, 480P, 720P or 1080i signal is received. When you connect to the HDMI terminal with a DVI-HDMI conversion cable, there is a possibility that the picture may not display correctly.
- Audio output – You can output audio signals from the LED TV set through the analog audio out and SPDIF terminals.

## EXTERNAL DEVICE CONNECTIONS

The following diagram shows the external device connections.

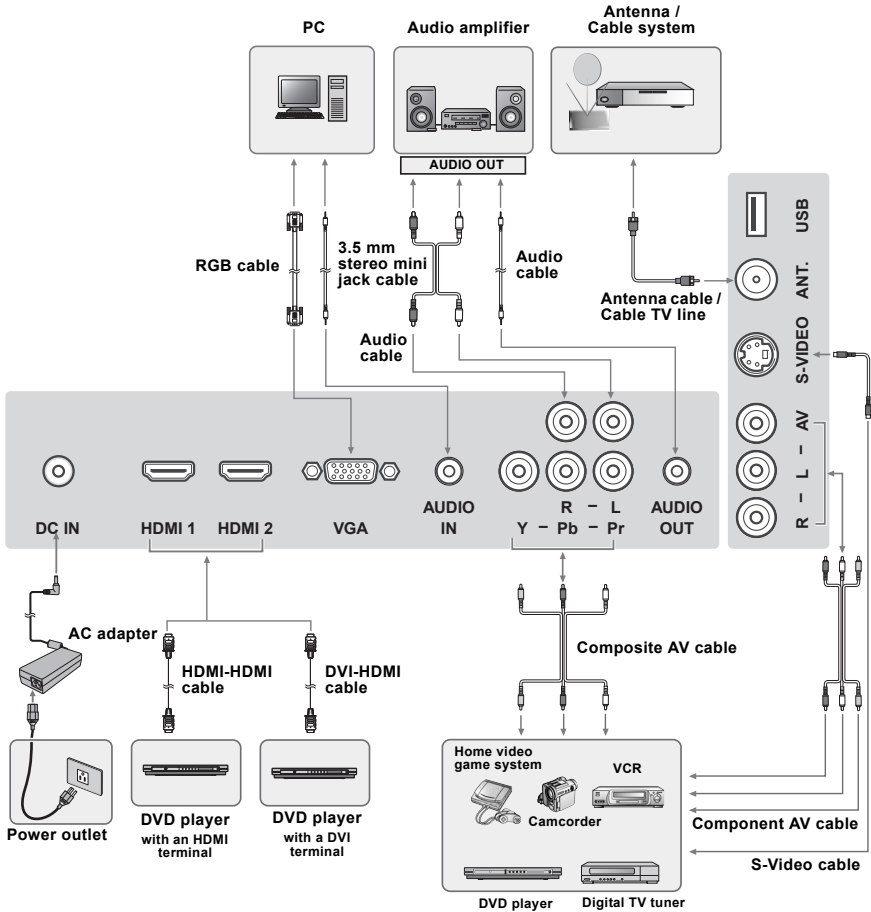



## POWER CONNECTION

### CONNECTING AC POWER

**IMPORTANT:**

The LED TV is designed to be powered via an AC adapter. Use **ONLY** the AC adapter included in the package. Turn off all connected devices before plugging the AC adapter into the power outlet.

Connect the power cord of the AC adapter to the LED TV then to a proper AC outlet.

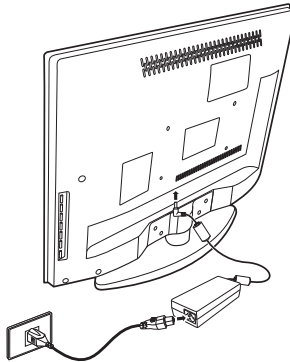

### INITIAL SETUP

Press  on the control panel or on the remote control to turn on the LED TV. Select the desired language and select **Yes** to use the SetupWizard. The SetupWizard will guide you on how to set up the LED TV's operational settings.

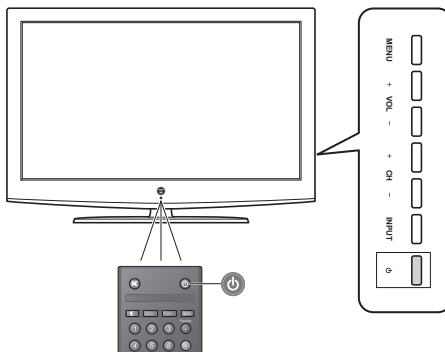

## WESTINGHOUSE HDTV SETUP

<p><b>Select Language</b></p> <p>Follow this guide to help you set up your TV. Use the Up and Down arrows on your remote control and select the Language you want to use for menus and message screens.</p> <p>English French Spanish</p> <p>▲▼ ◀▶ Select Enter: Confirm</p>	<p><b>Select Language</b></p> <p>Use the up and down arrows on your HDTV control panel or remote control to select the language to be used for menus and messages. Press Enter to continue.</p>
<p><b>Time Zone</b></p> <p>Use The up and Down arrows and press Select on your Time Zone</p> <p>Samoa (UTC-11) Hawaii (UTC-10) Alaska (UTC-9) Pacific (UTC-8) Mountain (UTC-7) Central (UTC-6)</p> <p>GO BACK</p> <p>▲▼ ◀▶ Select Enter: Confirm</p>	<p><b>Time Zone</b></p> <p>Use the up and down arrows on your HDTV control panel or remote control to select your local time zone. Press Enter to continue. Press Go Back to return to the previous screen.</p>
<p><b>Setup Wizard</b></p> <p>Please follow the Setup Wizard to scan and store channels. You can perform the scan later if you choose to skip</p> <p>Enter Skip</p> <p>GO BACK</p> <p>▲▼ ◀▶ Select Enter: Confirm</p>	<p><b>Setup Wizard</b></p> <p>The Setup Wizard will help guide you through scanning channels or accessing your connected set-top-box. Press Enter to start the Setup Wizard or Skip to exit to the source list with available input options. Press Go Back to return to the previous screen.</p>
<p><b>Channel Scan</b></p> <p>Please choose what type of device to set up? If you want to set up a DVD, Game Console or Computer please choose other and select what connection you are using.</p> <p>Antenna Cable Satellite Other</p> <p>GO BACK</p> <p>▲▼ ◀▶ Select Enter: Confirm</p>	<p><b>Channel Scan - Antenna</b></p> <p>Select Antenna and press enter on your remote control to activate the ATSC tuner and scan over-the-air ATSC channels. This LED HDTV is not capable of converting an ATSC signal until activated by the owner. Press Go Back to return to the previous screen.</p>

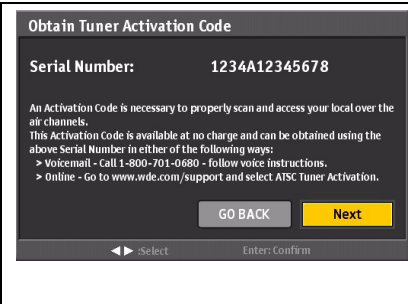

**Obtain ATSC Tuner Activation Code**  
 It is only necessary to activate the ATSC Tuner if you plan to scan for and view over-the-air ATSC broadcast content. To obtain code and activate the ATSC tuner chose an activation method from the options listed on your screen. Options will be from one to all of the following methods: Toll Free Phone Number, Website, or Text Message. Provide the activation service the Serial Number shown on your screen. Press Next to continue activation. Press Go Back to return to the previous screen.



**Enter Activation Code**  
 Using the remote control keypad enter the activation code provided by the ATSC Tuner Activation service. Press Go Back to return to the previous screen.

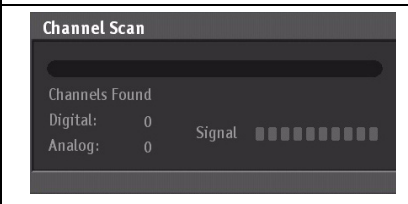

**Channel Scan in progress**  
 After successful ATSC Tuner Activation you will see a channel scan progress bar. This will show all analog and digital channels found during the scan as well as the signal strength of each. When the scan is complete you will be able to watch your local TV programming.

**WESTINGHOUSE HDTV SETUP - THROUGH CABLE/ SATELLITE BOX**



**Select Language**  
 Use the up and down arrows on your HDTV control panel or remote control to select the language to be used for menus and messages. Press Enter to continue.

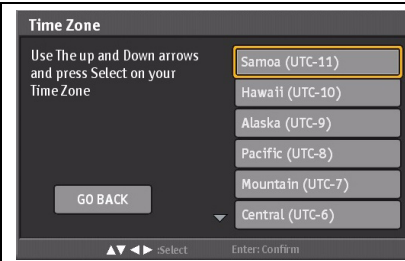

**Time Zone**

Use the up and down arrows on your HDTV control panel or remote control to select your local time zone. Press Enter to continue. Press Go Back to return to the previous screen.



**Setup Wizard**

The Setup Wizard will help guide you through scanning channels or accessing your connected set-top-box. Press Enter to start the Setup Wizard or Skip to exit to the source list with available input options. Press Go Back to return to the previous screen.

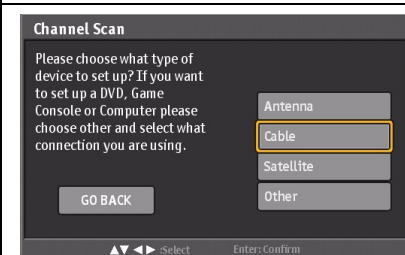

**Channel Scan - Cable/Satellite**

Select Cable/Satellite and press enter on your remote control to activate the ATSC tuner and scan cable/satellite ATSC channels. This LED HDTV is not capable of converting an ATSC signal until activated by the owner. Press Go Back to return to the previous screen.

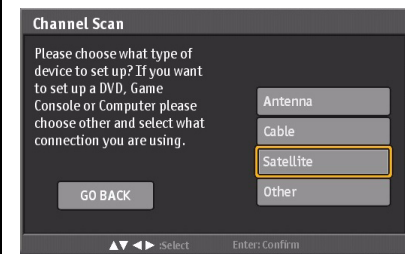

## POWER CONNECTION

English



### Cable/Satellite Select

Select "Yes" and then press Enter to continue. Press Go Back to return to the previous screen.

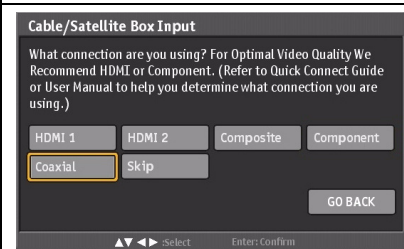

### Cable/Satellite Box Input

Select "Coaxial" and then press Enter to continue. Press Go Back to return to the previous screen.

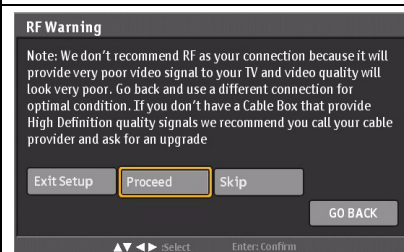

### RF Warning

Select "Proceed" and then press Enter to continue. Press Go Back to return to the previous screen.

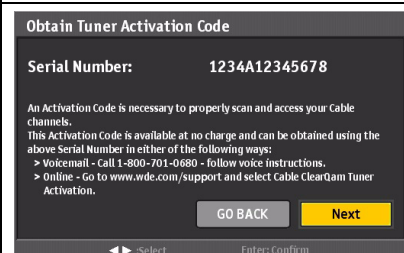

### Obtain ATSC Tuner Activation Code

It is only necessary to activate the ATSC Tuner if you plan to scan for and view cable/satellite ATSC content. To obtain code and activate the ATSC tuner chose an activation method from the options listed on your screen. Options will be from one to all of the following methods: Toll Free Phone Number, Website, or Text Message. Provide the activation service the Serial Number shown on your screen. Press Next to continue activation. Press Go Back to return to the previous screen.



**Enter Activation Code**

Using the remote control keypad enter the activation code provided by the ATSC Tuner Activation service. Press Go Back to return to the previous screen.

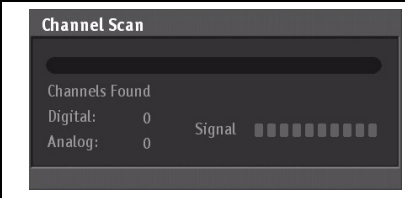

**Channel Scan in progress**

After successful ATSC Tuner Activation you will see a channel scan progress bar. This will show all analog and digital channels found during the scan as well as the signal strength of each. When the scan is complete you will be able to watch your local TV programming.

**WESTINGHOUSE HDTV SETUP - NOT THROUGH CABLE/ SATELLITE BOX**



**Select Language**

Use the up and down arrows on your HDTV control panel or remote control to select the language to be used for menus and messages. Press Enter to continue.

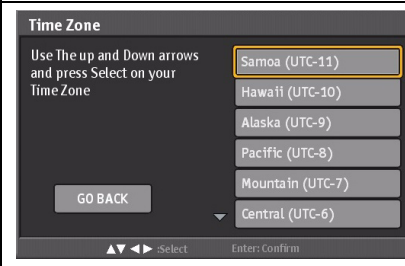

**Time Zone**

Use the up and down arrows on your HDTV control panel or remote control to select your local time zone. Press Enter to continue. Press Go Back to return to the previous screen.



**Setup Wizard**  
The Setup Wizard will help guide you through scanning channels or accessing your connected set-top-box. Press Enter to start the Setup Wizard or Skip to exit to the source list with available input options. Press Go Back to return to the previous screen.

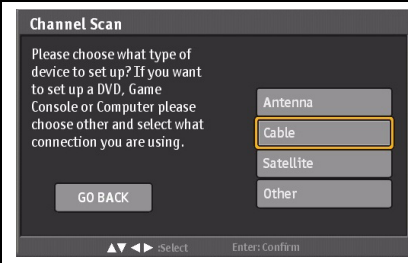

**Channel Scan - Cable/Satellite**  
Select Cable and press enter on your remote control to activate the ATSC tuner and scan cable/satellite ATSC channels. This LED HDTV is not capable of converting an ATSC signal until activated by the owner. Press Go Back to return to the previous screen.

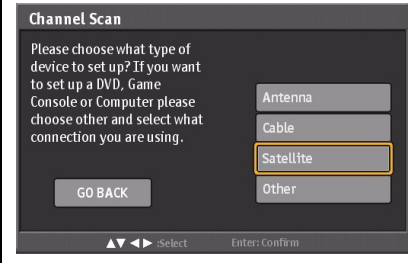

**Channel Scan - Cable/Satellite**  
Select Cable and press enter on your remote control to activate the ATSC tuner and scan cable/satellite ATSC channels. This LED HDTV is not capable of converting an ATSC signal until activated by the owner. Press Go Back to return to the previous screen.



**Cable/Satellite Select**  
Select "No" and then press Enter to continue. Press Go Back to return to the previous screen.

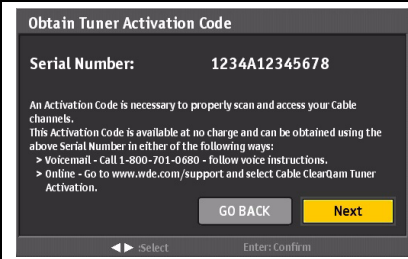

**Obtain ATSC Tuner Activation Code**  
 It is only necessary to activate the ATSC Tuner if you plan to scan for and view cable/satellite ATSC content. To obtain code and activate the ATSC tuner chose an activation method from the options listed on your screen. Options will be from one to all of the following methods: Toll Free Phone Number, Website, or Text Message. Provide the activation service the Serial Number shown on your screen. Press Next to continue activation.  
 Press Go Back to return to the previous screen.



**Enter Activation Code**  
 Using the remote control keypad enter the activation code provided by the ATSC Tuner Activation service.  
 Press Go Back to return to the previous screen.

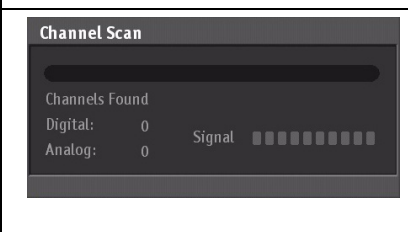

**Channel Scan in progress**  
 After successful ATSC Tuner Activation you will see a channel scan progress bar. This will show all analog and digital channels found during the scan as well as the signal strength of each. When the scan is complete you will be able to watch your local TV programming.



## BASIC OPERATIONS

### TURNING THE POWER ON AND OFF

#### Turning on the power

Press  on the control panel or on the remote control to turn on the LED TV.

#### Turning off the power

Press  on the control panel or on the remote control to turn off the LED TV. The LED behavior will depend on the enabled Power settings.

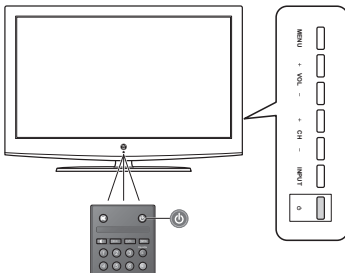

LED indicator	Operation
Turns from none to red.	Turn the power on.
Turns from red to none.	Turn the power off.

#### NOTES:

- If you are not going to use the TV for a long time, be sure to disconnect the power cord from the wall outlet and remove the batteries from the remote control.
- In standby mode, a small amount of electricity is still consumed even when the power is turned off.

### ADJUSTING THE VOLUME

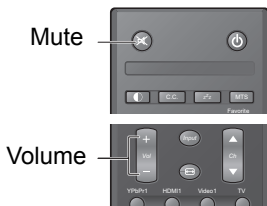

#### Volume

Press **Vol+** to increase the volume; press **Vol-** to decrease the volume.

#### Mute

Press  to turn off the sound. The mute icon appears on the screen. Press again to turn on the sound.

## CHANGING CHANNELS

Follow the instructions below to change channels.

### Using the Ch ▲ / ▼ Buttons



#### Browse channels

To browse through the available channels, press **Ch ▲ / ▼** on the remote control or on the control panel.

### Using the Channel Keys



#### Selecting channel

To change to a certain channel, key in the channel number using the channel keys and press **ENT**.

#### Selecting digital channel

To select a digital channel, key in the digital channel number using the channel keys and the • key, then press **ENT**.

### Using the Favorite Keys



#### Selecting favorite channels

To select a favorite channel, press the **Favorite** button (A, B, C, or D) corresponding to the preferred channel.

#### Saving a channel as a favorite

- 1 Switch to the channel you want to add as a favorite.
- 2 Press and hold the **Favorite** button which you want to add the current channel to for 3 seconds.
- 3 The Channel Saved message appears to confirm the new favorite channel item.

## SELECTING THE INPUT SOURCE

There are two ways to select the video input source.

### Using the Individual Input Keys



#### TV, PC, Video, YPbPr, HDMI Keys

Press any of the following remote control keys to change the input source: **TV, PC, Video1, Video 2, YPbPr1, HDMI1, or HDMI2.**

## Using the Input Key



### Select source using Input Key

- 1 Press **Input**.
- 2 A list of supported video sources is displayed.
- 3 Press **◀ / ▶** to select the preferred source.
- 4 Press **↵** to switch to the selected input source.

## ADJUSTING THE DISPLAY FORMAT

The input source can sometimes affect the way images are displayed on-screen. You can adjust the display format to view the image properly.



### Format Options

Press **Format** repeatedly to toggle the display format. As you toggle each option on, the actual display will change accordingly. The available options are:

- **Standard**: Picture is displayed in its original size.
- **Fill**: Picture is displayed to cover the entire screen.
- **Overscan**: Picture is scaled down to fit the display area.
- **1:1 Mode**: Matches the incoming resolution exactly to the pixels without any scaling.

## ADJUSTING THE LED BACKLIGHT

Different viewing conditions can affect the quality of the display. You can adjust the LED backlight to suit the current viewing condition.



### Backlight options

Press **Backlight** repeatedly to toggle the Backlight mode. The available options are: **Bright Room**, **Medium Room**, and **Dark Room**.

## SETUP MENUS

### SETUP MENU OPERATION

Use the setup menus to configure the various operational settings of the LED TV.







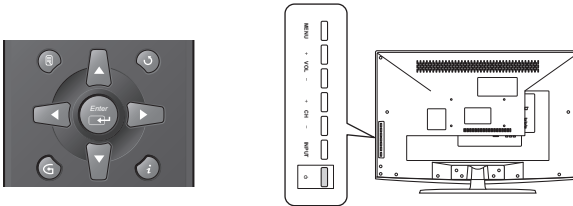

#### Displaying the setup menu screen

Press  on the remote control or **MENU** on the control panel to display the setup menu screen.

#### Navigating the setup menu screen

Use the buttons on the remote control or on the control panel to navigate through the menu screens.



Action	Remote Control	Control Panel
Displays or closes the menu bar.		<b>MENU</b>
<ul style="list-style-type: none"> <li>Select and display a primary menu.</li> <li>Adjust sub-menu options.</li> </ul>	 /  then 	<b>Volume +/-</b> then <b>INPUT</b>
<ul style="list-style-type: none"> <li>Select and display a sub-menu.</li> <li>Select a sub-menu or a sub-menu option.</li> </ul>	 /  then 	<b>Channel +/-</b> then <b>INPUT</b>
<ul style="list-style-type: none"> <li>Returns to the primary menu tab from a sub-menu screen.</li> <li>Returns to the previous screen.</li> </ul>		<b>MENU</b>
Applies the selected menu setting.		<b>INPUT</b>

## PICTURE

Use the Picture sub-menus to configure the display quality.



Press  on the remote control or **MENU** on the control panel to display the setup menu screen then select **Picture** to display the Picture sub-menu. The following options are available: Brightness, Contrast, Saturation, Video Presets, Sharpness, Color Temperature, Hue, and Reset.

### **Brightness**

Use Brightness to adjust the luminance level.



#### Adjusting Brightness



- 1 Use the ◀ / ▶ keys to select **Brightness** and press .
- 2 Press the ◀ / ▶ keys on the remote control to adjust the brightness level.
- 3 Press  to save and exit the screen.

### **Contrast**

Use Contrast to adjust the brightness to darkness ratio.



#### Adjusting Contrast

- 1 Use the ◀ / ▶ keys to select **Contrast** and press .
- 2 Press the ◀ / ▶ keys on the remote control to adjust the contrast level.
- 3 Press  to save and exit the screen.

## Saturation

Use Saturation to adjust the color intensity.



### Adjusting Saturation

- 1 Use the ◀ / ▶ keys to select **Saturation** and press .
- 2 Press the ◀ / ▶ keys on the remote control to adjust the saturation level.
- 3 Press to save and exit the screen.

## Video Presets



Use this sub-menu to select one of four preset view options optimized for different viewing conditions.



The following options are available:

- **Showroom:** Uses increased color and sharpness for a vibrant picture display.
- **Movie:** Images are displayed as accurately near to its original recording condition.
- **Game:** Uses increased brightness and response time level for enjoying video games.
- **Sports:** Uses high contrast display for clear-cut images ideal for viewing sports events.
- **Custom:** Uses the customized settings.

### Adjusting Video Presets



- 1 Use the ◀ / ▶ keys to select **Video Presets** and press .
- 2 Press the ◀ / ▶ keys on the remote control to select the desired option.
- 3 Press  to save and exit the screen.

### **Sharpness**

Use Sharpness to adjust the sharpness or softness of the display.



### Adjusting Sharpness

- 1 Use the ◀ / ▶ keys to select **Sharpness** and press .
- 2 Press the ◀ / ▶ keys on the remote control to adjust the sharpness level.
- 3 Press  to save and exit the screen.

### **Color Temperature**



Use Color Temperature to adjust the level of white balance in the display.



Three settings are available:

- **Warm:** Pictures appear more reddish.
- **Neutral:** Pictures appear more white.
- **Cool:** Pictures appear with a bluish tint.



**Adjusting Color Temperature**

- 1 Use the ◀ / ▶ keys to select **Color Temperature** and press .
- 2 Press the ◀ / ▶ keys on the remote control to select the desired option.
- 3 Press  to save and exit the screen.

**Hue**

Use Hue to adjust the balance of the red, green, and blue colors in the display.

**Adjusting Hue**

- 1 Use the ◀ / ▶ keys to select **Hue** and press .
- 2 Press the ◀ / ▶ keys on the remote control to adjust the hue level.
- 3 Press  to save and exit the screen.

**Reset**

Select **Yes** on this sub-menu to reset all display-related settings.

**NOTE:**

The configuration settings for the Picture sub-menus will only be applied to the current input source.



## AUDIO

Use the Audio sub-menus to configure the audio quality. These settings apply to the LED TV speakers only. Any connected audio devices are not affected.



Press  on the remote control or **MENU** on the control panel to display the setup menu screen then select **Audio** to display the Audio sub-menu. The following options are available: Bass, Treble, Balance, DRC, Audio Presets, TruSurround HD, and Reset.

### Bass

Use Bass to calibrate low-pitched sounds.



#### Adjusting Bass



- 1 Use the ◀ / ▶ keys to select **Bass** and press .
- 2 Press the ◀ / ▶ keys on the remote control to adjust the bass level.
- 3 Press  to save and exit the screen.

### Treble

Use Treble to calibrate high-pitched sounds.



#### Adjusting Treble

- 1 Use the ◀ / ▶ keys to select **Treble** and press .
- 2 Press the ◀ / ▶ keys on the remote control to adjust the treble level.
- 3 Press  to save and exit the screen.

## Balance

Use Balance to adjust the sound balance between the L/R speakers.



### Adjusting Balance

- 1 Use the ◀ / ▶ keys to select **Balance** and press .
- 2 Press the ◀ / ▶ keys on the remote control to adjust the balance level.
- 3 Press to save and exit the screen.

## DRC

Use this sub-menu to toggle the DRC Line mode and RF mode.

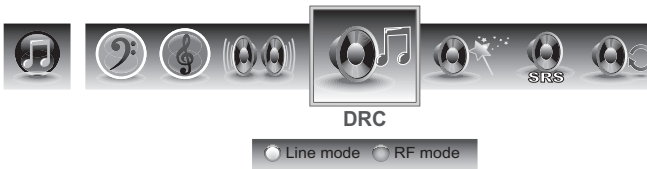

### Adjusting DRC

- 1 Use the ◀ / ▶ keys to select **DRC** and press .
- 2 Press the ◀ / ▶ keys on the remote control to select **Line mode** or **RF mode**.
- 3 Press to save and exit the screen.

## Audio Presets



Use this sub-menu to select one of four preset audio options optimized for different sounding conditions.



The following options are available:

- **Rock:** Sets the equalizer to the Rock mode.
- **POP:** Sets the equalizer to the POP mode.
- **Classical:** Sets the equalizer to the Classical mode.
- **Flat:** Sets the equalizer to the Flat mode.
- **Custom:** Uses the customized settings.

### Adjusting Audio Presets



- 1 Use the ◀ / ▶ keys to select **Audio Presets** and press .
- 2 Press the ◀ / ▶ keys on the remote control to select the desired option.
- 3 Press  to save and exit the screen.

## TruSurround HD

Use this sub-menu to toggle the TruSurround HD on and off.



**Adjusting TruSurround HD**

- 1 Use the ◀ / ▶ keys to select **TruSurround HD** and press .
- 2 Press the ◀ / ▶ keys on the remote control to select **ON** or **OFF**.
- 3 Press  to save and exit the screen.

**Reset**

Select **Yes** on this sub-menu to reset all audio-related settings.



## VIEW MODE

Use the View Mode sub-menu to select the aspect ratio of the display.

Press  on the remote control or **MENU** on the control panel to display the setup menu screen then select **View Mode** to display the View Mode sub-menu. The following options are available: Standard, Fill, Overscan, and 1:1 Mode.

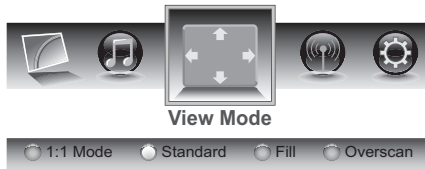

### **Standard**

Picture is displayed in its original size.

### **Fill**

Picture is displayed to cover the entire screen.





### **Overscan**

Picture is scaled down to fit the display area.

### **1:1 Mode**

Matches the incoming resolution exactly to the pixels without any scaling.

#### Adjusting View Mode

- 1 Press the  /  keys on the remote control to select the desired option.
- 2 Press  or  to save and exit the screen.

## VIEW MODE (VGA)

Select **VGA** as your input source and use the View Mode sub-menu to adjust the display in VGA mode.

Press  on the remote control or **MENU** on the control panel to display the setup menu screen then select **View Mode** to display the View Mode sub-menu. The following options are available: Aspect Ratio, H. Position, V. Position, Fine Tune, and Auto Sync.

### Aspect Ratio

Use this sub-menu to select the display's aspect ratio in the following options:

- **1:1 Mode:** Matches the incoming resolution exactly to the pixels without any scaling.
- **Standard:** Picture is displayed in its original size.
- **Fill:** Picture is displayed to cover the entire screen.

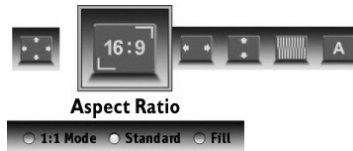

### H. Position

Use this sub-menu to adjust the horizontal position of the display.



### V. Position

Use this sub-menu to adjust the vertical position of the display.

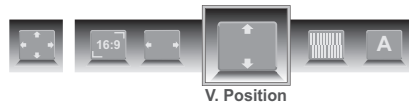

### Fine Tune

Use this sub-menu to fine tune the display.



### Auto Sync

Use this sub-menu to synchronize the display automatically.



## TV PROGRAM

Use the TV Program sub-menus to manage the channel list, language sound, and to scan for available TV channels in your area.







Press  on the remote control or **MENU** on the control panel to display the setup menu screen then select **TV Program** to display the TV Program sub-menu. The following options are available: Skip List, Channel Edit, MTS, Auto Search, and Manual Add.

### Skip List

Use Skip List to select the channels you want to skip.



### Adding Channels to Skip List

- 1 Use the  /  keys to select **Skip List** and press . The Channel Skip List screen appears.
- 2 Use the  /  keys to select the desired channel.
- 3 Press  repeatedly to check (add to the Skip list) or uncheck (clear to the Skip list) the channels.
- 4 Repeat steps 2 and 3 to add more channels.
- 5 Press  to save and exit the screen.

## Channel Edit

Use Channel Edit to assign a name to a channel.



### Editing Channel Names

- 1 Use the ◀ / ▶ keys to select **Channel Edit** and press **↵**. The Channel Name Edit screen appears.
- 2 Use the ▲ / ▼ keys to select the desired channel and press **↵** to open the Edit Name screen.
- 3 Use the ▲ / ▼ / ◀ / ▶ keys to move the cursor to the desired symbol and press the **↵** button to enter.
  - Select **Shift** to toggle different symbol tables: uppercase and lowercase letters, numerals, and special symbols.
  - Select **Back** to backspace.
  - Select **Clear** to delete all typed text.
- 4 Select **Accept** when finished.
- 5 Repeat steps 2, 3, and 4 to add more channels.
- 6 Press **⏏** to save and exit the screen.



## MTS



Use MTS to select multichannel television sound.



The following options are available:

- **Mono:** Allows mono output (useful when stereo is noisy or inconsistent).
- **Stereo:** Allows stereo sound for superior TV viewing experience.
- **SAP:** Allows second audio program from the speakers while watching a scene in the original program.

### Adjusting MTS

- 1 Use the ◀ / ▶ keys to select **MTS** and press .
- 2 Press the ◀ / ▶ keys on the remote control to select the desired option.
- 3 Press  to save and exit the screen.

## Auto Search

Select **Auto Search** and press . Two options are available:

- **Cable:** Choose this setting if you are receiving TV channels with a CATV (cable TV).
- **AIR:** Choose this setting if you are receiving TV channels with an antenna (over the air).

Auto Search automatically creates a list of receivable channels for the selected source.

## Manual Add

Use Manual Add to add channels manually.

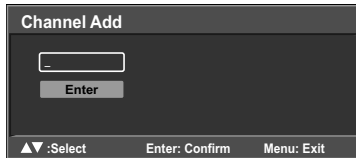

### Adding Channels Manually

- 1 Use the ◀ / ▶ keys to select **Manual Add** and press **↵**. The Channel Add screen appears.
- 2 Use the Channel keys on the remote control to enter the channel number and select **Enter**. Wait a few moment for the TV to search for the channel.
- 3 When the channel is found, you can select **Add** to add to channel.

## SETTINGS

Use the Settings sub-menus to configure the LED TV operational setup and view the current firmware version.



Press  on the remote control or **MENU** on the control panel to display the setup menu screen then select **Settings** to display the Settings sub-menu. The following options are available: Date and Time, Closed Captions, Parental Control, OSD Timeout, OSD Language, Power settings, Reset All, and Version.

### *Date and Time*

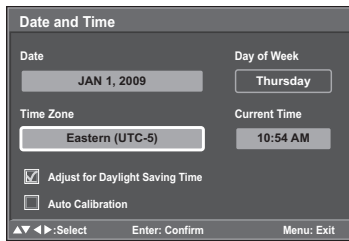

Use Date and Time to adjust the current date and time.



#### Adjusting Auto Calibration

- 1 Use the ◀ / ▶ keys to select **Date and Time** and press .
- 2 Press  repeatedly to check (enable) or uncheck (disable) **Auto Calibration**.
- 3 Press  to save and exit the screen.
  - Enable this option to view the system's current time.
  - Both **Date** and **Current Time** are unavailable for adjustments when **Auto Calibration** is enabled.

#### Adjusting Time Zone

- 1 Use the ◀ / ▶ keys to select **Date and Time** and press .
- 2 Use the ▲ / ▼ keys to select **Time Zone** and press .
- 3 Use the ▲ / ▼ keys to select the desired Time Zone: **Samoa, Hawaii, Alaska, Pacific, Mountain, Central, Eastern, Atlantic,** or **Newfoundland**.
- 4 Press  to save and exit the screen.

### Adjusting Date and Time

- 1 Use the ◀ / ▶ keys to select **Date and Time** and press **↵**.
- 2 Use the ▲ / ▼ keys to select **Date** or **Current Time** and press **↵**.
- 3 Use the ◀ / ▶ keys to select a date or time segment.
- 4 Use the ▲ / ▼ keys to adjust the value.
- 5 Press **⏏** to save and exit the screen.

### Adjusting Daylight Saving

- 1 Use the ◀ / ▶ keys to select **Date and Time** and press **↵**.
- 2 Press **↵** repeatedly to check (enable) or uncheck (disable) **Adjust for Daylight Saving Time**.
- 3 Press **⏏** to save and exit the screen.

## **Closed Captions**

Use Closed Captions to configure the settings for closed captioning in TV programs.

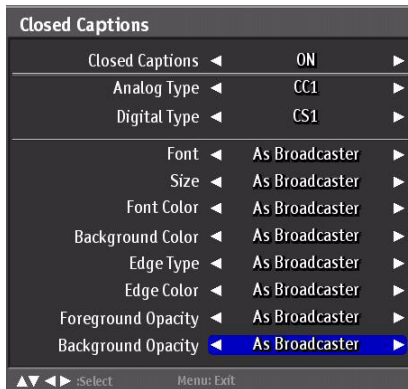

The following options are available:

- **Closed Captions:** Can be set to **ON** or **OFF**.
- **Analog Type:** Can be set to **CC1, CC2, CC3, CC4, T1, T2, T3, or T4**.
- **Digital Type:** Can be set to **CS1, CS2, CS3, CS4, CS5, or CS6**.

- **Font:** Can be set to **As Broadcaster, Style 1, Style 2, Style 3, Style 4, Style 5, Style 6,** or **Style 7.**
- **Size:** Can be set to **As Broadcaster, Small, Medium,** or **Large.**
- **Font Color:** Can be set to **As Broadcaster, Black, White, Green, Blue, Red, Cyan, Yellow,** or **Magenta.**
- **Background Color:** Can be set to **As Broadcaster, Black, White, Green, Blue, Red, Cyan, Yellow,** or **Magenta.**
- **Edge Type:** Can be set to **As Broadcaster, None, Raised, Depressed, Uniform, Shadow Left,** or **Shadow Right.**
- **Edge Color:** Can be set to **As Broadcaster, Black, White, Green, Blue, Red, Cyan, Yellow,** or **Magenta.**
- **Foreground Opacity:** Can be set to **As Broadcaster, Solid, Translucent, Transparent,** or **Flashing.**
- **Background Opacity:** Can be set to **As Broadcaster, Solid, Translucent, Transparent,** or **Flashing.**

### Adjusting Closed Captions Settings

- 1 Use the ◀ / ▶ keys to select **Closed Captions** and press ↵.
- 2 Use the ▲ / ▼ keys to select the desired Closed Captions option.
- 3 Use the ◀ / ▶ keys to adjust the value.
- 4 Press ⏹ to save and exit the screen.

## **Parental Control**

Use Parental Control to block channels and change the password. You must enter a six-digit password to use the Parental Control. The factory password is 999999.



After you enter the correct password, the **Parental Control** menu is shown. By default, only the **Rating** and **Change Password** submenu are displayed. To display the hidden submenu, set **Rating** to **ON**.

The following options are available:

- **Rating:** Select **ON/OFF** to hide or display the hidden submenu.
- **Block Unrated:** Select **ON/OFF** to block/unlock all unrated programs.

**Adjusting Rating and Block Unrated**

- 1 Use the ◀ / ▶ keys to select **Rating** or **Block Unrated** and press **OK**.
- 2 Use the ◀ / ▶ keys to select **ON** or **OFF**.
- 3 Press **⏏** to save and exit the screen.

- **TV Rating:** Use this sub-menu to customize US TV Rating programs.

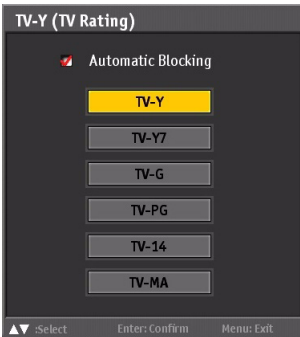

Rating	Description
TV-Y	Suitable for young children.
TV-Y7	May not be suitable for children under 7.
TV-G	Suitable for all audiences.
TV-PG	Parental guidance suggested.
TV-14	Parental guidance suggested for children under 14.
TV-MA	Suitable for mature audiences only; may be unsuitable for children under 17.
FV	Fantasy violence, combative situations.
D	Suggestive dialogue.
L	L Coarse language.
S	Sexual situations.
V	Violence.

**Adjusting TV Rating**

- 1 Use the ◀ / ▶ keys to select **TV Rating** and press **↵**.
  - 2 Use the ▲ / ▼ / ◀ / ▶ keys to select the desired rating and press **↵** repeatedly to block or unblock. You can also select **Lock All** to block all or **Unlock All** to unblock all.
  - 3 Press **⏏** to save and exit the screen.
- **MPAA Rating:** Use this sub-menu to select the ratings of allowable movies.

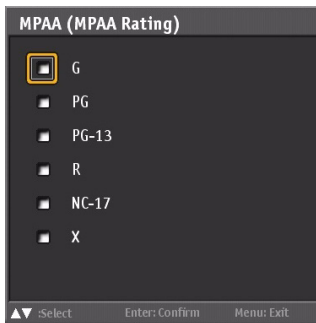

Rating	Description
G	Contains nothing most parents will consider offensive for even their youngest children to see or hear; suitable for young children.
PG	May contain some material parents might not like to expose to their young children-material that will clearly need to be examined or inquired about before children are allowed to view the film.
PG-13	May contain some scenes of drug use; use of one of the harsher sexually-derived words may be heard. May be inappropriate for preteens.
R	May contain some adult material. Parents are urged to learn more about the film before letting their children view it.
NC-17	May contain explicit sex scenes, an accumulation of sexually-oriented language, and/or scenes of excessive violence. Suitable for adult audiences only. Rating does not signify that the film is obscene or pornographic.
X	Contains extreme violence or explicit sex; suitable for adult audiences only.

**Adjusting MPAA Rating**

- 1 Use the ◀ / ▶ keys to select **MPAA Rating** and press **↵**.
  - 2 Use the ▲ / ▼ / ◀ / ▶ keys to select the desired rating and press **↵** repeatedly to block or unblock.
  - 3 Press **⏏** to save and exit the screen.
- **Canada English:** Use this sub-menu to select the classification categories (based on Canadian ratings) of allowable TV programs and movies.

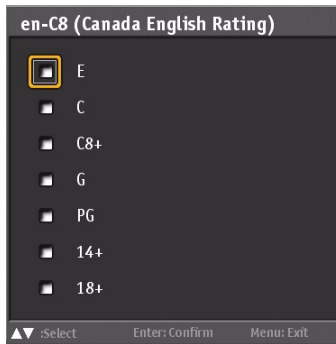

Rating	Description
E	Exempt shows
C	Suitable for viewing by children of all ages.
C8+	Not suitable for children under 8 years of age.
G	Suitable for general audiences.
PG	Parental guidance advised.
14+	Suitable for people 14 years of age or older.
18+	Suitable for people 18 years of age or older.

**Adjusting Canada English Rating**

- 1 Use the ◀ / ▶ keys to select **Canada English Rating** and press **↵**.



- 2 Use the ▲ / ▼ / ◀ / ▶ keys to select the desired rating and press **↵** repeatedly to block or unblock.
  - 3 Press **⏏** to save and exit the screen.
- **Canada French:** Use this sub-menu to select the ratings of allowable TV programs and movies. These ratings are based on the classification categories determined by La Régie du cinéma du Québec.



Rating	Description
E	Exempt shows
G	For general audiences.
8 ans +	Not suitable for children under 8 years of age.
13 ans+	Not suitable for persons under 13 years of age.
16 ans+	Not suitable for persons under 16 years of age.
18 ans+	Not suitable for persons under 18 years of age.

### Adjusting Canada French Rating

- 1 Use the ◀ / ▶ keys to select **Canada French Rating** and press **↵**.
- 2 Use the ▲ / ▼ / ◀ / ▶ keys to select the desired rating and press **↵** repeatedly to block or unblock.
- 3 Press **⏏** to save and exit the screen.

- **Channel Block:** Channel Block allows you to block channels.

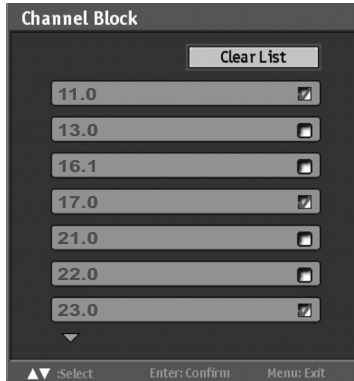

**Adjusting Channel Block**

- 1 Use the ◀ / ▶ keys to select **Channel Block** and press .
  - 2 Use the ▲ / ▼ keys to select the desired channel and press repeatedly to block or unblock.
  - 3 Press to save and exit the screen.
- **Change Password:** Change Password allows you to change your current password.

**Changing Password**

- 1 Use the ◀ / ▶ keys to select **Change Password** and press .
- 2 Use the Channel keys to enter the current password and press .
- 3 Use the Channel keys to enter the new password and press .
- 4 Use the Channel keys to enter the new password again for confirmation and press .
- 5 Press to save and exit the screen.

## OSD Timeout

Use OSD Timeout to adjust the OSD duration on the screen: 10 sec, 20 sec, or 30 sec.



### Adjusting OSD Timeout

- 1 Use the ◀ / ▶ keys to select **OSD Timeout** and press **↵**.
- 2 Press the ◀ / ▶ keys on the remote control to select **10 sec**, **20 sec**, or **30 sec**.
- 3 Press **⏏** to save and exit the screen.

## OSD Language

Use OSD Language to select the language to display on the screen: English, French, or Spanish.



### Adjusting OSD Language

- 1 Use the ◀ / ▶ keys to select **OSD Language** and press **↵**.
- 2 Press the ◀ / ▶ keys on the remote control to select **English**, **French** or **Spanish**.
- 3 Press **⏏** to save and exit the screen.

## Power Settings

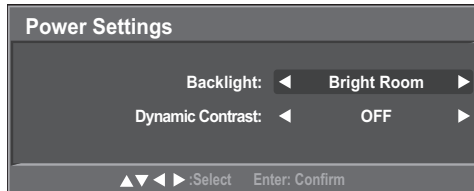

Use this sub-menu to configure power-related settings for the LED TV.



The following options are available:

- **Backlight:** Use this setting to select the backlight mode: Bright Room, Medium Room, or Dark Room.
- **Dynamic Contrast:** Use this setting to enable or disable Dynamic Contrast.

### Adjusting Power Settings

- 1 Use the ◀ / ▶ keys to select **Power Settings** and press .
- 2 Use the ▲ / ▼ keys to select a desired option.
- 3 Use the ◀ / ▶ keys to adjust the value.
- 4 Press  to save and exit the screen.

## Reset All

Select **Yes** on this sub-menu to reset all LED TV operational settings. Do this only if any of the following conditions occurs:

- The system fails to respond to the remote control (ensure that the remote control batteries are still working and you are within the transmission range).
- The new configuration settings cause unexpected results.
- You forget the system PIN.



## Version

Use this sub-menu to view the LED TV's serial number and firmware version.



## WALL MOUNT OPTION

The LED TV has been fitted with VESA FPMPMI compliant mounting holes. These 200 x 100 mm mounting holes allow the unit to be mounted on a wall. Use the four M4 x L10 mm screws to wall mount the LED TV.

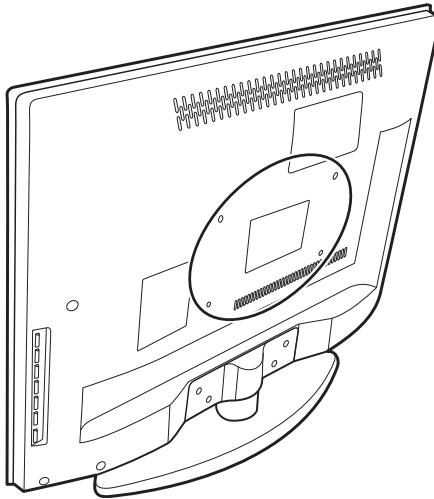

### WALL MOUNT INSTALLATION REMINDERS



- Remove the LED TV base first before mounting the unit on a wall.
- It is the user's responsibility to use a UL listed wall mount unit rated to support the weight of this LED TV.
- Please consult qualified contractors for wall mount installation.

**CAUTION:**

The incomplete or improper mounting of this unit to a wall may cause it to fall down resulting to property damage and/or potentially serious injury.

## TROUBLESHOOTING

Problem	Corrective Action
No power	<ul style="list-style-type: none"> <li>• Make sure the power indicator is illuminated blue.</li> <li>• Make sure the power cord is securely connected to the AC-in jack and is plugged into a functional AC outlet. You may want to plug in another electrical device to the power outlet to verify that it is supplying the proper voltage.</li> </ul>
Power is suddenly turned off.	Make sure the sleep timer is turned off.
Forgotten PIN	Use Reset All in Settings menu to reset your password.
Remote control does not work.	<ul style="list-style-type: none"> <li>• Press only one button at a time.</li> <li>• Make sure the batteries are properly inserted.</li> <li>• The batteries may already be drained out. Replace batteries with new ones.</li> </ul>
Remote control code cannot be detected by a universal remote.	<ul style="list-style-type: none"> <li>• Purchase a separate learning remote control.</li> <li>• Go to <a href="http://www.wde.com">www.wde.com</a> for a list of remote codes.</li> </ul>
No picture	<ul style="list-style-type: none"> <li>• Make sure the video input cable is properly connected to the correct terminal, and that the correct input mode is enabled. To illustrate, when a VGA cable is connected to display a computer screen, the PC input mode must be enabled.</li> <li>• Verify that the antenna is properly connected and that the preferred channel is enabled in the channel list. Press and select Channels/Channel List.</li> <li>• Adjust the display settings.</li> </ul>

Problem	Corrective Action
No picture or the No Signal message appears when a VGA cable is connected.	<ul style="list-style-type: none"> <li>• Make sure the VGA cable is properly connected to the LED TV's VGA port.</li> <li>• Decrease the video resolution setting on the computer and try again.</li> <li>• Adjust the display settings.</li> </ul>
Picture is cut off or appear in a sidebar screen.	Press  to adjust the Aspect ratio.
Poor image quality in TV mode (cutoff picture, snowy images).	<ul style="list-style-type: none"> <li>• Check your antenna connection. If necessary, rotate the antenna and wait up to ten seconds for a signal.</li> <li>• Reduce signal splitters and excessively long cables.</li> <li>• Replace poor antenna cables and/or connectors to improve signal quality.</li> <li>• Press  to adjust the Aspect ratio.</li> <li>• Adjust the Noise Reduction setting in Picture menu.</li> <li>• In HDMI mode, make sure the external device is compatible with the LED TV.</li> </ul>
Wrong, abnormal or missing colors	<ul style="list-style-type: none"> <li>• If any colors (red, green or blue) are missing, check the video cable to make sure it is securely connected. Loose or broken pins in the cable connector could cause an improper connection.</li> <li>• Adjust the Hue, Saturation and Color Temperature settings in Picture menu.</li> <li>• Connect the TV to another computer and check if the problem is with the computer screen.</li> </ul>



Problem	Corrective Action
No sound	<ul style="list-style-type: none"> <li>• Make sure the audio input cable is properly connected to the correct terminal, and that the correct input mode is enabled.</li> <li>• The volume may be muted, press or Vol+ key to turn on the volume.</li> <li>• Adjust the Bass, Treble, and Balance settings in Audio menu.</li> <li>• If you are using the TV speakers, make sure the TV Speakers option is set to On in Audio menu.</li> <li>• If you are using an external audio device, press and select Audio to make sure the TV Speakers option is set to Off in Audio menu.</li> </ul>
<p><b>NOTES:</b>                      If the problem condition persists even after performing the recommended corrective actions, contact us by:</p> <ul style="list-style-type: none"> <li>• Logging on to <a href="http://www.wde.com">www.wde.com</a></li> <li>• Contacting the Westinghouse Customer Service at (800) 701-0680 or e-mail us at <a href="mailto:service@wde.com">service@wde.com</a></li> </ul>	



[www.westinghousedigital.com](http://www.westinghousedigital.com)

## Free Manuals Download Website

<http://myh66.com>

<http://usermanuals.us>

<http://www.somanuals.com>

<http://www.4manuals.cc>

<http://www.manual-lib.com>

<http://www.404manual.com>

<http://www.luxmanual.com>

<http://aubethermostatmanual.com>

Golf course search by state

<http://golfingnear.com>

Email search by domain

<http://emailbydomain.com>

Auto manuals search

<http://auto.somanuals.com>

TV manuals search

<http://tv.somanuals.com>