



Westinghouse

# **USER'S MANUAL**

*MANUEL DE L'UTILISATEUR*

*MANUAL DEL USUARIO*

---

**TX-42F430S**

**TX-47F430S**

**TX-52H480S**

1080p HDTV

*TVHD 1080p*

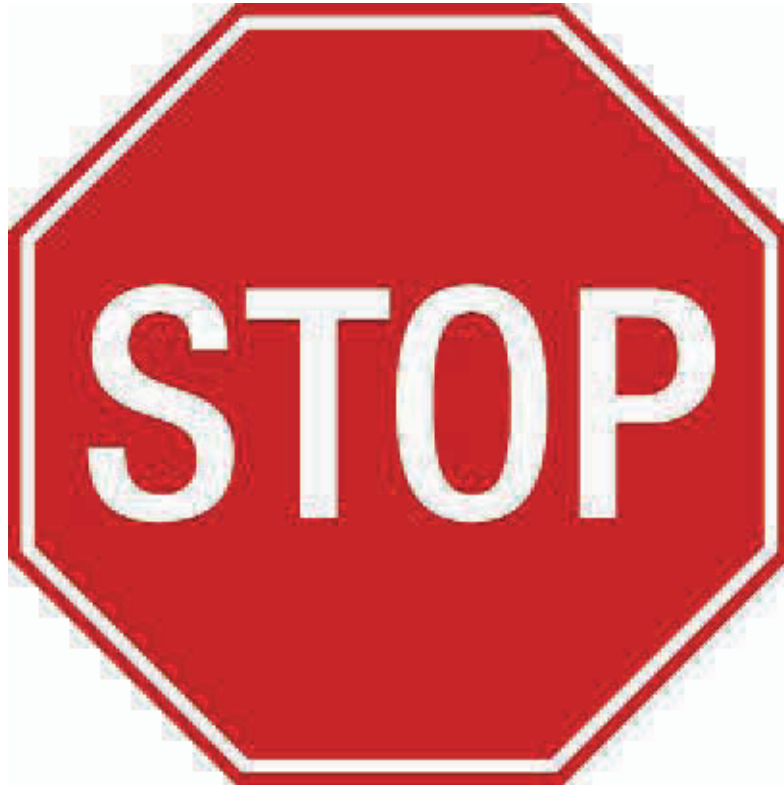

If you have any questions or concerns,  
Please call our toll free number  
1-866-287-5555

**Owner's Record**

The model and serial numbers are located on the back of the TV. Keep a record of the numbers in the spaces provided below. Refer to them whenever you call upon your Westinghouse Digital dealer regarding this product.

**Model No.** \_\_\_\_\_

**Serial No.** \_\_\_\_\_

# CONTENTS

## WELCOME

- Package Contents
- Contacting Westinghouse Digital

## **1. PRODUCT SAFETY**

- Important Notice Concerning Power Cord Selection
- FCC Compliance Statement
- Product Safety Instructions
  - Other Notices
- Antenna Installation Safety
  - Outdoor Antenna Grounding
  - Lightning
  - Power Lines

## **2. INTRODUCTION: THE BASICS**

- Digital Television (DTV)
- High Definition Television (HDTV)
- About the Digital Television Picture
- About Digital Channels
- The Electronic Program Guide (EPG)

## **CONTROLS AND CONNECTIONS**

- Front View
- Side-Mounted Controls
- Rear Right/Left Spine-Mounted Connectors
  - Quick Reference: HDTV Connections
- Inserting Remote Control Batteries
  - Precautions
- Remote Control Features

## **3. HDTV/ACCESSORY SETUP**

- Connecting Your HDTV
  - Power
  - Choose Your TV Source
  - Determining Available Channels
  - Set Your Time Zone
- Connecting Your Personal Computer
  - Computer Settings
  - Connection Types
  - Power
- Connecting Other Accessories
  - DVD or Game System
  - Video Cassette Recorder (VCR)
  - Cable or Satellite Receiver
  - Audio Equipment

#### **4. HDTV OPERATION**

##### **About the On Screen Display (OSD)**

OSD Menus & Features

—Video Menu

    Calibration Menu

    Color Temperature

—Display Menu

—TV Menu

    Add or delete additional TV Channels

    About Parental Controls

    Channel Locks

    US MPA Rating

**US TV Ratings & Content**

    Canadian English

    Canadian French

—PC (VGA only) Menu

—Audio Menu

—Power Menu

—Settings Menu

—Input Menu

#### **5. APPENDIX**

47-inch High Definition LCD TV Specifications

42-inch High Definition LCD TV Specifications

52-inch High Definition LCD TV Specifications

Troubleshooting

Cleaning the High Definition LCD TV

Wall mount and Base removal on the HD LCD TVs

Safety bracket Options

## WELCOME

*Congratulations on the purchase of your High Definition LCD TV—and thank you for choosing Westinghouse. This User Manual was created to ensure simple, safe setup and use of all the features offered by your new HDTV.*

## Package Contents

In addition to your new Westinghouse FHDTV and this User Manual, you'll also find the following:

- Quick Setup Guide
- Remote control
- 2 AAA batteries
- AC power cord
- Warranty card





## Contacting Westinghouse Digital

If you still have questions or require assistance after reading the Quick Setup

Guide and the instructions in this User Manual, please contact Westinghouse Customer Service at 1-866-287-5555, or visit our Web site at [www.westinghousedigital.com](http://www.westinghousedigital.com).

***Don't forget to complete and return your Warranty card or use our online Product Registration feature. Your Westinghouse HDTV is warranted for defects in materials or workmanship for a period of one year from original date of purchase.***

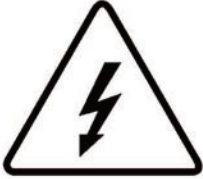
**Explanations of required symbols :**

SYMBOL	SYMBOL DEFINITION
 SA 1965	<b>DANGEROUS VOLTAGE :</b> The lightning flash with arrowhead symbol, within an equilateral triangle, is intended to alert the user to the presence of uninsulated "dangerous voltage" within the product's enclosure that may be of sufficient magnitude to constitute a risk of electrical shock to persons.
 SA 1966	<b>INSTRUCTIONS :</b> The exclamation point with an equilateral triangle is intended to alert the user to the presence of important operating and maintenance ( servicing ) instructions in the literature accompanying the appliance.

**PLEASE READ FIRST:**

**1. PRODUCT SAFETY**

**WARNING:** This device must be operated with the original power supply, part number DPS-210 EP 2 C.

**CAUTION:** The power supply outlet should be located near High Definition LCD TV and should be easily accessible. Always use the appropriate AC cord that is certified for your specific country. Some examples are listed below:

- |                 |  |
|-----------------|--|
| USA.....UL      | Switzerland ..... SEV                      |
| Canada.....CSA  | Britain ..... BASE/BS                      |
| Germany.....VDE | Japan ..... Electric Appliance Control Act |

**IMPORTANT NOTICE CONCERNING POWER CORD SELECTION**

The specific power cord for this High Definition LCD TV is enclosed and has been selected according to the country of destination and must be used to prevent electric shock. Use the following guidelines if it is necessary to replace the original cord set, or if the cord set is not enclosed. The female receptacle of the cord set must meet IEC-60320 requirements and should look like Figure A1 below:



**For the United States and Canada**

In the United States and Canada the male plug is a NEMA5-15 style (Figure A2), UL Listed, and CSA Labeled. For High Definition LCD TVs that are placed on a desk or table, type SVT or SJT cord sets may be used. For High Definition LCD TVs placed directly on the floor, only SJT type cord sets may be used. The cord set must be selected according to the current rating for the High Definition LCD TV. Please consult the table below for the selection criteria for power cords used in the United States and Canada.

Cord Type	Size of Conductors in Cord	Maximum Current Rating of Unit
SJT	18 AWG	10 Amps
	16 AWG	12 Amps
	14 AWG	12 Amps
SVT	18 AWG	10 Amps
	17 AWG	12 Amps

**FCC Compliance Statement**

This equipment has been tested and complies with the limits for a Class B digital device, pursuant to part 15 of the FCC Rules. These limits are designed to provide reasonable protection against harmful interference in a residential installation. This equipment generates, uses, and can radiate radio frequency energy, and may cause harmful interference to radio communications if not installed and used in accordance with the instructions. However, there is no guarantee that interference will not occur in a particular installation. If this equipment does cause harmful interference to radio or television reception, which can be determined by turning the equipment off and on, the user is encouraged to try to correct the interference by one or more of the following measures:

- Reorient or relocate the receiving antenna.
- Increase the separation between the High Definition LCD TV and receiver.

- Connect the equipment into an outlet on a circuit different from that to which the receiver is connected.
- Consult the Westinghouse Service Center or an experienced radio/TV technician for assistance.

**FCC Warning**

**To assure continued FCC compliance, the user must use a grounded power supply cord and the provided shielded video interface cable with bonded ferrite cores. If a BNC cable is used, use only a shielded BNC (5) cable. Also, any unauthorized changes or modifications not expressly approved by Westinghouse Digital will void the user's authority to operate this device.**



## 1. PRODUCT SAFETY

Follow and obey all warnings and instructions marked on the High Definition LCD TV. For your safety, please read all of the following safety and operating instructions before you operate the High Definition LCD TV—and keep this User's Manual for future reference.

### Important Safety Instructions

1. Never use your HDTV near water.
2. Clean only with dry cloth.
3. Never block any ventilation openings; install in accordance with the manufacturer's instructions.
4. Do not install near any heat sources such as radiators, heat registers, stoves or any other equipment (including amplifiers) that produce heat.
5. Take care to maintain the safety purpose of the polarized or grounding type plug. A polarized plug has two blades with one wider than the other. A grounding type plug has two blades and a third grounding prong. The wide blade or the third prong are provided for your safety; therefore, if the provided plug does not fit into your outlet, do not alter the plug in any way to fit; consult an electrician for replacement of the obsolete outlet.
6. Ensure the power cord is protected from being walked on or pinched, particularly at plugs, convenience receptacles and the point where they exit from the apparatus.
7. Only use attachments/accessories specified by the manufacturer.
8. Use only with the cart, stand, tripod, bracket, or table specified by the manufacturer, or sold with the apparatus. When a cart is used, use caution when moving the cart/apparatus combination to avoid the potential for injuries caused by tipping over.
9. Unplug this apparatus during lightning storms or when unused for long periods of time.
10. Refer all servicing to qualified service personnel. Servicing is required when the apparatus has been damaged in any way, such as: damage to the power supply cord or plug; liquid has been spilled into—or objects have fallen onto—the apparatus; the apparatus has been exposed to rain or moisture and does not operate normally, or it has been dropped.



### **Other Notices**

- Avoid exposing the High Definition LCD TV to direct sunlight or high temperatures.
- Avoid exposing the High Definition LCD TV to moisture or high humidity.
- Do not attempt repairs yourself. Your warranty does not cover repairs or attempted repairs by anyone not authorized by the manufacturer.
- If your High Definition LCD TV will not be used for a long period of time, unplug your HDTV and remove the batteries from the remote control.
- Only use attachments/accessories specified by the manufacturer.
- Avoid touching the screen. Skin oils are difficult to remove.
- Never remove the rear cover. Your High Definition LCD TV contains high-voltage parts. You may be seriously injured if you touch them.
- Always handle your LCD display with care when moving it.
- If the High Definition LCD TV emits smoke, abnormal noise, or a strange odor, immediately turn it off and contact the Westinghouse Service Center.

## 1. PRODUCT SAFETY

### Antenna Installation Safety

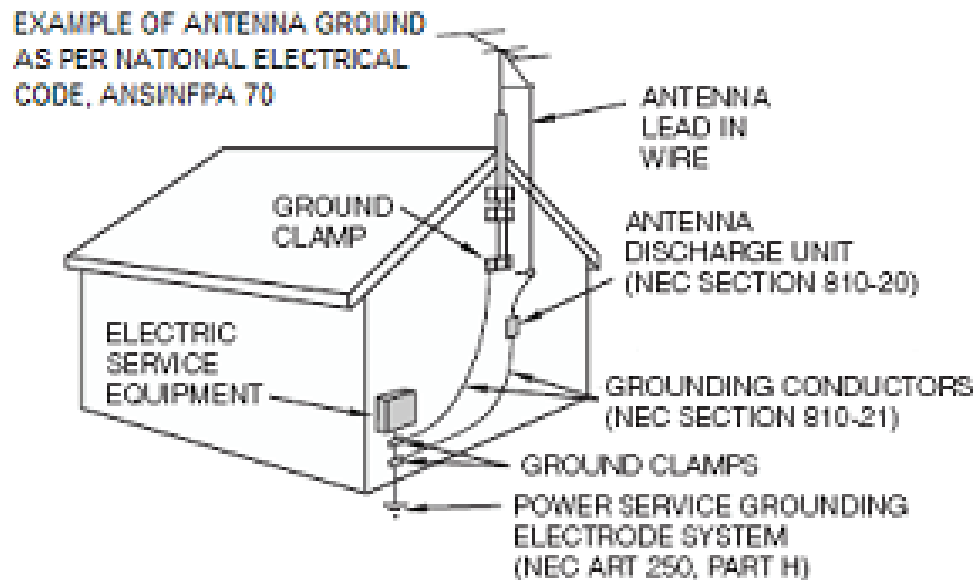

#### Outdoor Antenna Grounding

If an outside antenna or cable system is connected to the High Definition LCD TV, be sure the antenna or cable system is grounded to prevent voltage surges and built-up static charges. Article 810 of the National Electrical Code, ANS/NFPA 70, provides information on proper grounding of the mast and supporting structure, grounding of the lead-in wire to an antenna discharge unit, connection to grounding electrodes, and requirements for the grounding electrode.

#### Lightning

For added protection for the High Definition LCD TV during a lightning storm, or when it is left unattended and unused for long periods of time, unplug it from the wall outlet and disconnect the antenna or cable system. This will prevent damage to the High Definition LCD TV due to lightning and power-line surges. Do not disconnect the antenna or the power cord during a heavy storm—lightning may strike while you are holding the cable cord, causing serious injury. Turn off your High Definition LCD TV and wait for the weather to improve.

#### Power Lines

An outside antenna system should not be located in the vicinity of overhead power lines or other electric light or power circuits. When installing an outside antenna system, extreme care should be taken to keep from touching such power lines or circuits.

## **2. INTRODUCTION: THE BASICS**

### **Digital Television (DTV)**

Television broadcasting is changing. By February of 2009, traditional analog TV transmissions (the standard since TV's inception) will cease to exist, in compliance with a federal mandate requiring all U.S. television stations to convert from analog to the new digital television (DTV) standards.

In contrast to the magnetic waves used for analog transmission (also known as NTSC, short for National Television Standards Committee), DTV transmits images and sound as data, using ones and zeroes, the same digital code computers use. As a result of this increased efficiency, DTV offers an array of benefits including dramatic improvements to picture and sound quality. In addition, DTV allows the same number of stations to broadcast using fewer channels, freeing parts of the broadcast spectrum for other uses, such as public safety and wireless services

*NOTE: DTV should not be confused with digital cable or digital satellite systems. While these systems receive digital signals, the signals are converted to analog for display on channel 3 or 4 of an analog TV.*

### **High Definition Television (HDTV)**

The most common DTV formats are Standard Definition Television (SDTV) and High Definition Television (HDTV). Of the two, HDTV delivers digital broadcasting's highest resolution and picture quality. HDTV also uses a "widescreen format," which refers to the aspect ratio (screen width vs. height) of the image. To put this in perspective, analog television uses a 4 x 3 aspect ratio; HDTV's aspect ratio is 16 x 9, creating a more cinematic-like viewing experience. Plus HDTV increases the number of horizontal scan lines on the screen, enabling it to render greater picture detail. And, while HDTV uses approximately the same bandwidth, it transmits approximately six times more information, further enhancing video and audio clarity.

## **2. INTRODUCTION: THE BASICS**

### **About the Digital Television Picture**

Your new Westinghouse High Definition LCD TV has a built-in HDTV/NTSC tuner, meaning it can receive both analog and digital broadcasts from your antenna, cable or satellite service. But because not all broadcasters have converted to the new DTV standards, it's important to understand some fundamentals of the digital television picture.

The elements that make up onscreen images are pixels. The more pixels, the more detail, because the number of pixels determines picture resolution—and HDTV offers the highest pixel count and best resolution available. HDTV resolution is available in both 720p and 1080i formats. The "p" and "i" refer to the scanning method used to deliver the lines of resolution on the screen.

Progressive "p" scanning means that pixels on the screen are refreshed simultaneously, with each scan showing every line for a complete picture at 1/60<sup>th</sup> of a second. Interlaced "i" scanning refreshes pixels by alternating first, by showing every odd line, then following with the even lines—for a complete picture at 1/30<sup>th</sup> of a second.

True high definition image quality is possible only with a true high definition display—and a 720p or 1080i signal coming into your HDTV. Lower resolution images from analog broadcasts or VHS recordings, for example, may result in disappointing picture quality as they simply don't have enough detail to display well in high-definition. If you have cable or satellite service, you'll want to check with your provider to determine which packages include stations broadcasting in high definition, and if you need a different box or tuner to receive HDTV signals. You may also find the "Aspect Ratio" feature found in the On Screen Display Menu's "Display" option helpful in adjusting your picture. And, as more and more broadcasters change to a digital signal, you will be able to view all of your programming choices in stunning high definition—and the luxury of your personal home theater experience.

## 2. INTRODUCTION: THE BASICS

### About Digital Channels

Currently, all broadcasters have an analog TV channel and a digital TV channel. The digital bandwidth has the capability of accommodating more than one program stream because each broadcaster's assigned digital channel carries a 19.39-megabit-per-second (Mbps) digital data stream. This allows the broadcaster the option of broadcasting a single program or dividing the digital data stream into multiple programming streams. These streams include the "major" channel specific to a broadcasting station, as well as any additional programming streams on the bandwidth, which are referred to as "minor channels" or "sub-channels," each broadcasting a different program. As a result, the numbering system for digital channels is different than that of traditional analog TV.

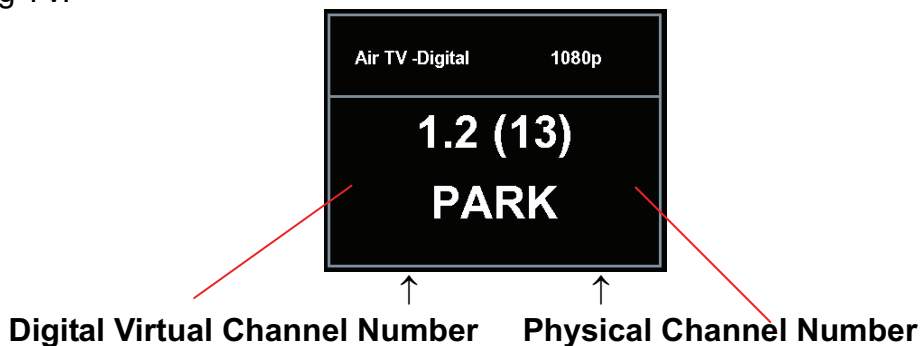

Here's how it works:

- The number in parentheses to the right is the actual physical channel number of the transmitter used to broadcast the network programming in your region
- Each physical channel is mapped to one or more digital channel numbers, known as "virtual channels," and represented by a number, followed by a dot and then another number; for example, 7.1, 7.2, etc. (the old analog channel is always referenced to minor channel "0", as in 7.0, while 7.1 would represent the new digital television channel)
  - The first number is the major channel used for all channels of a particular broadcasting station
  - The number following the dot is the minor channel number assigned to each broadcaster's additional programming streams; digital television stations may have only one virtual channel, or as many as six

**There are several ways to input digital television channels:**

<u>User Input (double-digit channels)</u>	→	<u>Channel Displayed</u>
11 . 3	→	Channel 11 . 3
113	→	Channel 11 . 3
<u>User input (single-digit channels)</u>	→	<u>Channel Displayed</u>
052	→	Channel 5 . 2
5.2 + Ent	→	Channel 5 . 2

## 2. INTRODUCTION: The Basics

### The Electronic Program Guide (EPG)

Your Westinghouse High Definition LCD TV features an on-screen interactive Electronic Program Guide (EPG) that allows you to review program information, as well as navigate through current and future programming options by channel or genre to plan viewing and recording.

To access the EPG, push the “Guide” button on the lower left side of your remote, scroll the “EPG” feature in the On Screen Display’s (OSD) TV menu. You have the option of looking at:

- “Present EPG”—includes current channel, program name and description, along with programming titles, start and end times for all available minor channels from the same broadcaster
- “Daily EPG”—includes current programming name and description, plus upcoming programming titles with start and end times

The EPG also provides:

- Date and time information
- Power use and signal quality

Use the arrow keys and channel up/down buttons on your remote control to scroll through the EPG; press the remote’s “ENTER” button to select a sub-section of the EPG, or press the “LAST CHANNEL” button to return to the last section visited.

5-1 KPIX-HD		Dec 2, 2006, 12:02:00
5-1	67-1	
START	END	EVENT TITLE
09:00	11:30	College Basketball
11:30	15:00	College Football
18:00	19:00	CBS 5 Eyewitness News Special Edition
19:00	20:00	Without a Trace
20:00	21:00	Glamour Women of the Year 2006
21:00	22:00	Crimetime Saturday
ABSTRACT		
College Basketball		
U/D: Move    ENTER: To Abstract    PAGE U/D: Page    EXIT: To Channel		

## 2. INTRODUCTION: CONTROLS AND CONNECTIONS

### Front View

Use buttons on the right front side of your HDTV (or remote control on remote control) for On Screen Display (OSD), volume adjustment, channel selection, source, and turning power on or off.

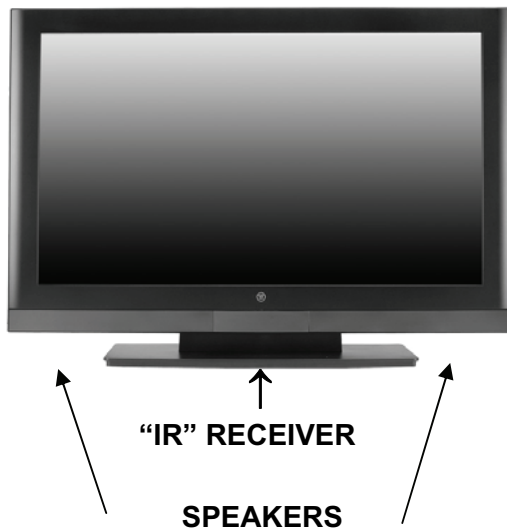

#### ← LED INDICATOR/ CONTROLS

1. **Menu**  
OSD menu ON/OFF
2. **Volume +/-**  
Increase/decrease sound or adjust selected features in OSD menus
3. **Channel ▼/▲**  
Scroll up/down through channels or OSD menus
4. **Source**  
Select Active Video source or a highlighted feature in OSD menus
5. **Power**  
ON/OFF Power button



### Side-Mounted Control

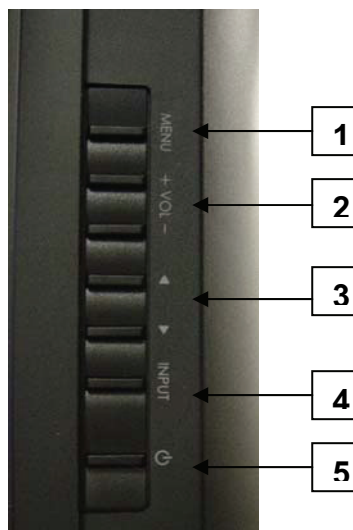

## 2. INTRODUCTION: CONTROLS AND CONNECTIONS

### Rear Right/Left Spine-Mounted Connectors

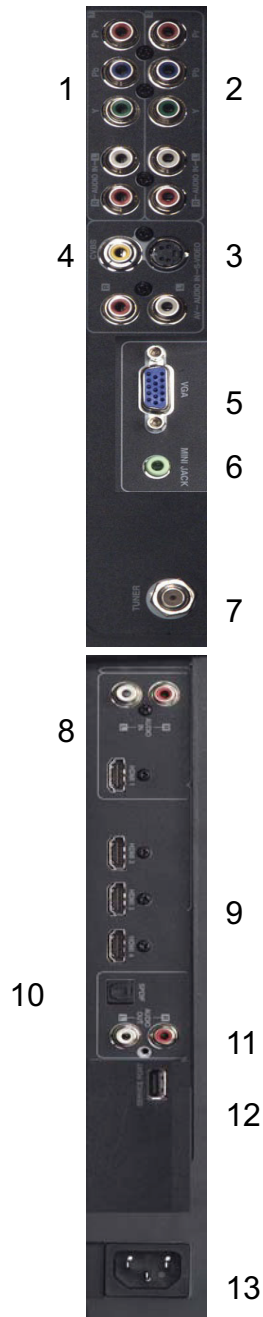

#### RIGHT SIDE CONNECTORS

1. **YPbPr1/Audio 1 (Right/Left)**  
Connect external video device like DVD or game system
2. **YPbPr2/Audio 2 (Right/Left)**  
Connect an external video device like a DVD or gaming system
3. **S-Video**  
Connect external video device like a VCR (Audio Right/Left supports S-Video or AV input)
4. **AV Video/Audio (Right/Left)**  
Connect an external video device like a VCR (Audio Right/Left supports S-Video or AV input)
5. **VGA**  
Connect personal computer using a 15-pin VGA cable
6. **Mini Jack** Connect personal computer using a 3.5mm mini-jack cable from PC's Audio Out **ANT (RF-input)**
7. Connect antenna or cable service

#### LEFT SIDE CONNECTORS

8. **HDMI 1 /Audio1 (Right/Left)**  
Connect external HDMI device like a DVD, cable/satellite receiver or personal computer; for analog Audio use, select Audio menu in On Screen Display (OSD) and use remote's left/right arrows to change HDMI to Analog
9. **HDMI 2-3-4**  
Connect external HDMI device like a DVD, cable/satellite receiver or personal computer
10. **SPDIF**  
Digital Audio out connection
11. **Audio Out (Right/Left)**  
Connect an external audio amplifier
12. **USB**  
Service port for FW updated and Maintenance
13. **AC-IN (Power)**  
Connect to power source via supplied power cord

See pages 19 for more information about connecting cable/satellite receivers, game consoles, VCR and DVD player/recorders, audio devices and your personal computer.



*sidebar:*

### **Quick Reference: HDTV Connection**

#### **YPbPr**

The “Y” stands for the luminance of the signal; Pb and Pr refer to the color difference signals (“b” for blue, “r” for red). Provides improved color bandwidth over S-Video or composite video connections.

#### **DVI-HDCP (Digital Visual Interface/High-bandwidth Digital Content Protection)**

Provides superior level of digital video quality, typically used in cable/satellite receivers or DVD players. (Not Available)

#### **HDMI (High Definition Multimedia Interface)**

Provide superior level of digital video quality; includes DVD, cable/satellite receivers or personal computers

#### **S-Video Input**

The “S(uper)-Video” connection provides enhanced picture clarity for selected accessory sources such as a digital broadcast satellite service, video games, DVD and VHS. ***Accessory source must have S-Video output jack.***

## 2. INTRODUCTION: Controls and Connections

### Inserting Remote Control Batteries

1. Remove the battery compartment cover
2. Insert the batteries corresponding to the (+) and (-) marks inside the battery compartment
3. Reattach cover



#### **Precautions:**

- Only use AAA batteries
- Don't mix new and old batteries, which can result in cracking or leakage and may pose a risk for fire or personal injury
- Make sure you Insert batteries according to (+) and (-) markings; incorrect battery installation can result in cracking or leakage and may pose a risk for fire or personal injury
- Always dispose of used batteries in accordance with local laws and regulations
- Keep all batteries away from children and pets
- Remove batteries when the remote control will not be used for an extended period of time

## 2. INTRODUCTION: CONTROLS AND CONNECTIONS

### Remote Control Features

1. **POWER**  
Switch the power On/Off
2. **PIP**  
Display sub picture On/Off (not available)
3. **MUTE**  
Turn the sound On/Off
4. **SWAP**  
Switch between PIP and Main Picture (not available)
5. **BACKLIGHT**  
Shortcut to adjust backlight adjustment
6. **CC**  
Turn Closed Caption On/Off
7. **SLEEP**  
Set sleep timer
8. **FAVORITE CHANNEL A / B / C**  
Jump to favorite channels (Hold button for 3 seconds to program favorite channel).
9. **CHANNEL NUMBER KEYS**  
Select specific channels
10. **DOT**  
To input dash when selecting specific channels
11. **ENT**  
Complete channel selection
12. **INPUT**  
Display MP input menu (see page 30)
13. **VOL - / +**  
Volume Up/Down adjustment
14. **SCALING**  
Set video display format to "STANDARD" or "FILL"
15. **CH ▼ / ▲**  
TV Channel Up/Down adjustment
16. **MENU**  
Turn OSD Menu On/Off
17. **LAST CHANNEL**  
Switch to previous channel
18. **▼ / ▲ / ◀ / ▶**  
Navigate within OSD Menu
19. **ENTER**  
Make a selection
20. **EPG**  
Display Electronic Program Guide
21. **INFO**  
Display the source and channel information
22. **YPbPr1**  
Switch to YPbPr1 source
23. **PC**  
Switch to VGA source
24. **HDMI**  
Switch to HDMI sources
25. **TV**  
Switch to TV source
26. **YPbPr2**  
Switch to YPbPr2 source
27. **AV**  
Switch to AV sources
28. **S-VIDEO**  
Switch to S-Video sources
29. **DVI**  
Switch to DVI source (not available)

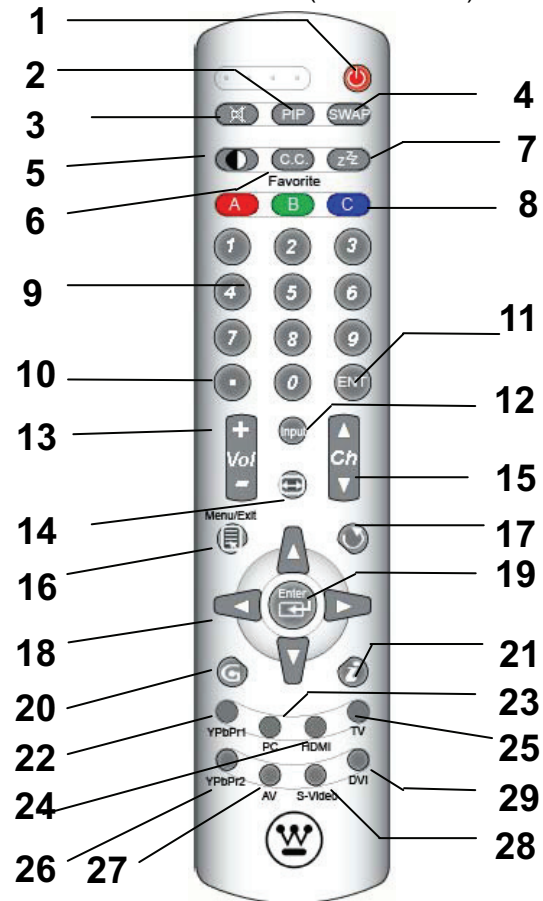

### 3. HDTV/ACCESSORY SETUP

Now that you're familiar with the basics of digital television and the various controls and connections for your HDTV, you're ready to enjoy its superb picture quality and sound, along with the ultimate convenience of connecting your game consoles, VCR, DVD, audio devices or personal computer.

*NOTE: If you have already performed the steps in the Quick Setup Guide, skip to the instructions specific to the accessory you want to connect.*

#### Connecting Your HDTV

##### Power

- Connect the supplied AC power cord to your HDTV's "AC In" jack and to a properly grounded AC outlet
  - If you're using an antenna or your cable service, connect the antenna or cable (not supplied) to the "Antenna" connector
  - If you're using a satellite receiver, connect to either the "HDMI" connector (see page 15 for connector descriptions and locations)
- Press the Power button on either the remote control or the side-mounted control panel to turn your HDTV on (**it will take a few seconds to power up**)



**Choose Your TV Source** Press the "Menu" button on your remote or the side panel to access the On Screen Display (OSD)

- Use the right/left arrow buttons to scroll across to the "TV" menu
- Use the up/down arrow keys to select "Tuner Source"
- Use the arrow keys to select your signal source "Air/Cable/IRC/HRC"
  - If you use a rooftop or indoor antenna, select "Air"
  - If you use a cable service, select "Cable," "IRC" or "HRC" (depending on the frequency used by your cable service)



*NOTE: When using a DVI or HDMI connection, the cable box or satellite receiver needs to be restarted to complete HDCP authentication.*

### Determining Available Channels

- When connected to an antenna, cable or other RF (radio frequency) source, you'll need to run "Autoscan"—available in the "TV" menu of the OSD (see page 26 for more information)—in order for all available channels to be received

—Use the up/down arrow keys to scroll below "Tuner" to "Auto Scan"  
 —Press "Enter" to start scanning for channels (**identification of all analog and digital channels may take several minutes**)

*NOTE: Depending on your area, some channels shown may not be available for viewing.*

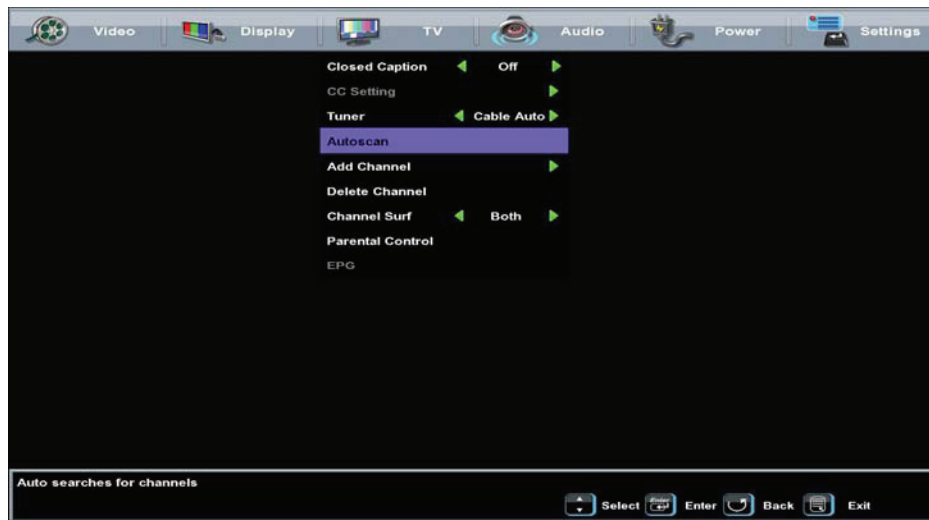

- First Time connected to RF the system will automatically select the Autoscan function.*

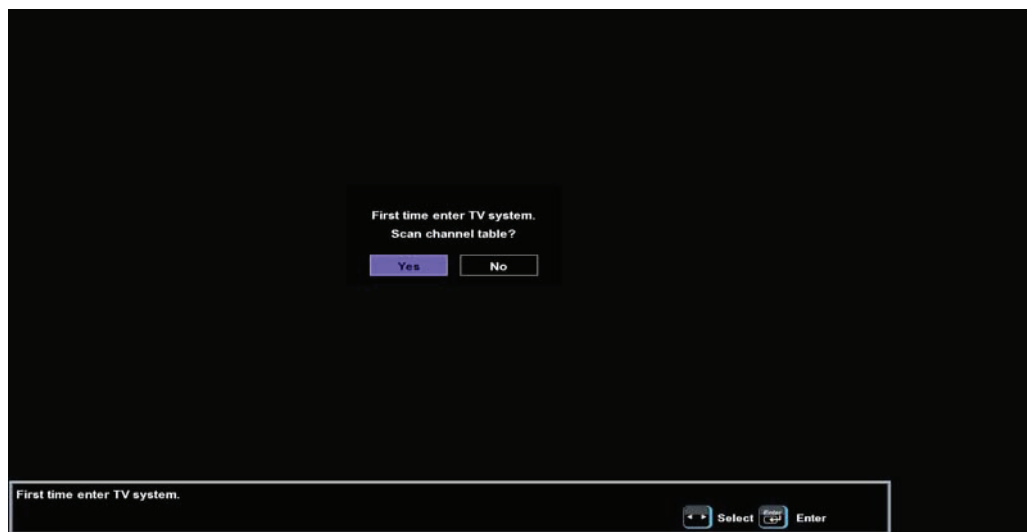

## Set Your Time Zone

- Scroll right to the “Settings” menu
  - Use the up/down buttons to select “Time Zone”
  - Select your local time zone, which allows you to receive HDTV programming information
  - Exit the OSD

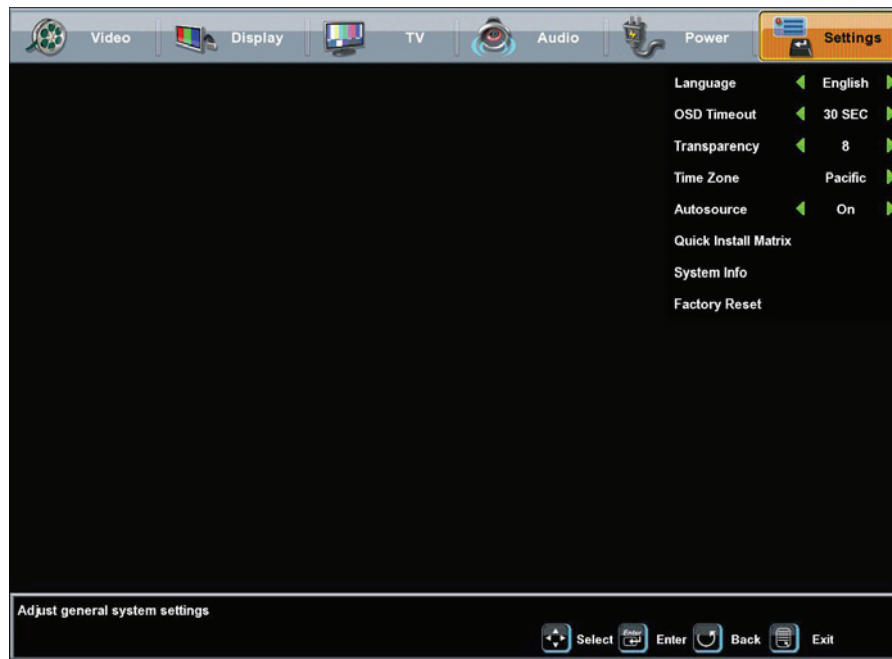

### **3. HDTV/ACCESSORY SETUP**

#### **Connecting Your Personal Computer**

*Before making any connections, make sure all equipment is turned off.*

##### **Computer Settings**

- For optimal picture quality, set your computer's timing mode to VESA™ (Video Electronics Standards Association) 1920 x1080 at 60Hz
- Refer to your computer's graphic card User Guide for directions to set this timing mode (many computers show 1024x768 as an alternative resolution)

##### **Connection Types**

- **VGA Connection**
  - Connect a 15-pin analog VGA cable (not supplied) from your computer's "VGA OUT" port to the HDTV's "VGA IN" port
  - Connect a stereo mini cable from your computer's "AUDIO OUT" port to the HDTV's "AUDIO IN" port



##### **Power**

- Turn on your HDTV (wait a few seconds for it to power up)
- Turn on your computer
  - The HDTV will automatically adjust to the computer's resolution

### 3. HDTV/ACCESSORY SETUP

#### Connecting Other Accessories

Following are the recommended connections to ensure optimal enjoyment of your accessory equipment with your HDTV.

*Before making any connections, make sure all equipment is turned off.*

The image shows a 'Quick Connect Guide for LCD HDTVs' with three numbered steps and a 'Quick Connection Reference' table.

**Step 1: Verify Box Contents**  
Power cable, remote control, two batteries, user manual and warranty card.  
**Identify Connections**  
Please see chart to the right to determine video quality.  
**Base Removal**  
See instructions in the user manual.

**Step 2: Connect external source devices**  
Indicate devices used in the tables column.  
**Connect RF Antennas**  
If using a cable or laptop box, skip channel scan.  
**Power on TV**  
Connect power cable to wall outlet. Press power button on keypad or remote.  
**Follow On-Screen Setup Menu**

**Step 3: Power on external source devices**  
Press input button on remote. Use input list to select source device.  
**Setup and verify external source devices**  
Enjoy your new Westinghouse TV! \*The DVD remote models insert DVD and go!

**Quick Connection Reference Table:**

SK Series	SOURCE DEVICES								
	Connector Type	TV Input	View-Find	Cable/Satellite	DVD	Game	VHS	PC	Notes
HDMI	HDMI	16:9	Best	Best	Best	Best	16:9	16:9	
YPb/Pr + LP Audio	YPb/Pr	16:9	Better	Better	Better	Better	16:9	16:9	
VCRD + LP Audio	VCRD	16:9	Good	Good	Good	Good	16:9		
S-VIDEO + LP Audio	S-VIDEO	16:9	Good	Good	Good	Best	16:9		
YCbCr + Audio Mini Jack	YCbCr	16:9	16:9	16:9	16:9	16:9	16:9	Best	
AVT	AVT	Best	16:9	16:9	16:9	16:9	16:9	16:9	

**Customer Service:** 866-287-5555  
**Wall Mounts:** Go to [www.westco.com](http://www.westco.com) to see which Westinghouse mounts are compatible with your LCD TV.  
**Go to [www.westco.com](http://www.westco.com) to check out the complete line of Westinghouse LCD products.**

#### DVD or Game System

- Connect your DVD player or gaming system using following input connectors
- the HDTV's HDMI ports HDMI1 to 4 (HDMI cable not supplied) and corresponding Audio (Right/Left) connectors if you use the HDMI1 connector and analog Audio  
—For analog audio use with HDMI, open the On Screen Display (OSD), select the "Audio" menu and use the left/right arrows to change "HDMI" to "Analog"
- or YPb/Pr1 and Audio1 (Right/Left) **or** YPb/Pr2 and Audio2 (Right/Left) connectors on the HDTV to (cable not supplied)

#### Video Cassette Recorder (VCR)

- Use the S-Video connector on your HDTV to connect your VCR (S-Video four-pin cable with round connector not supplied)

#### Cable or Satellite Receiver

- Connect your cable or satellite receiver using HDTV's HDMI port (HDMI cable not supplied)
- or YPb/Pr1 and Audio1 (Right/Left) **or** YPb/Pr2 and Audio2 (Right/Left) connectors on the HDTV to (cable not supplied)

#### Audio Equipment

- Use your HDTV's "Audio Out" port to connect to an external audio amplifier (cable not supplied)



## 4. HDTV OPERATION



### About the On Screen Display (OSD)

Your HDTV's On Screen Display (OSD) conveniently integrates all functions required for setup and operation. There are two ways you can access the OSD—either by pressing the remote control's "Menu" button (located just below the volume controls on the left side of the remote), or by pressing the "Menu" button on the HDTV's

right-side control panel. You can select amongst any of the seven menus by using your remote's

◀/▶ buttons. Similarly, each of the menus includes sub-menus, which can be selected by using the remote's ▼/▲ buttons.



1. Press  on the remote control to display the Menu screen.
2. Press ▲ / ▼ to select the desired menu item.
3. Press *Enter* to select the menu item.
4. Press  to exit.

## 4. HDTV OPERATION

### OSD Menus and Features

#### Video Menu

The “Video” menu allows you to adjust the properties of the image you see on the screen by adjusting the display’s brightness, contrast, color intensity and hue, picture clarity and sharpness. You can also adjust the backlight’s intensity and, if necessary, restore the factory default video settings.

You have the option to select any of the 5 preset Video modes for individual preferences.

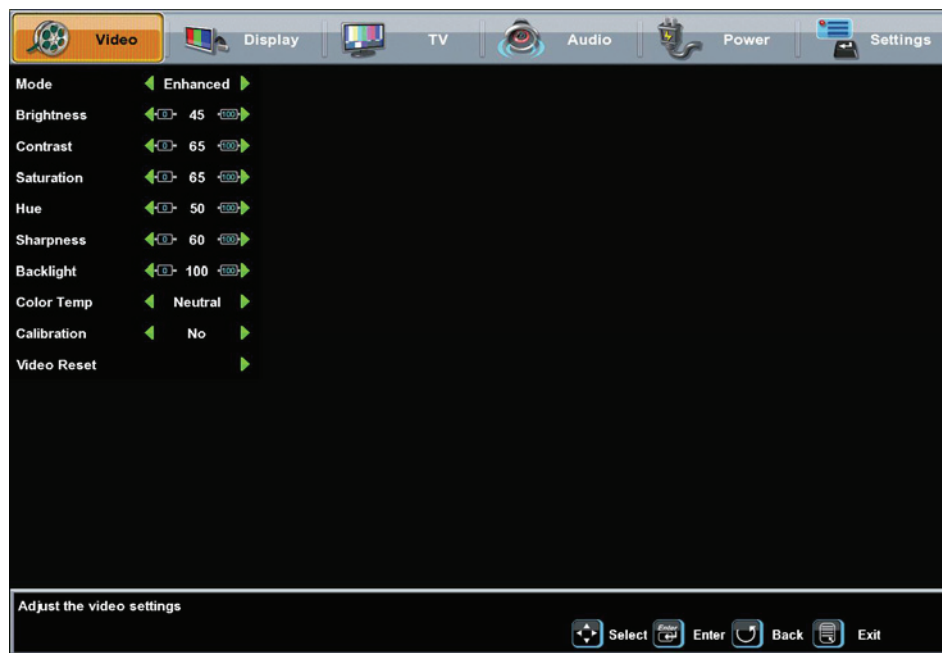

Video Menu Features	Adjustment Descriptions
<b>Mode</b>	Select from 5 different Video modes, (User, Movie, Sports, Game, Enhanced)
<b>Brightness</b>	Black level Adjustment
<b>Contrast</b>	White level Adjustment
<b>Color</b>	Intensity of color
<b>Hue</b>	Red/Green level Adjustment
<b>Sharpness</b>	Picture clarity
<b>Backlight</b>	Intensity of HDTV lamp illumination
<b>Color Temp</b>	Select from 3 different color temp
<b>Calibration</b>	Open up the Calibration Menu for advanced Video adjustments
<b>Video Reset</b>	Resets video settings to factory default

## 4. HDTV OPERATION

### Calibration Menu

The “Calibration” menu integrates advanced choices that allow you to optimize your HDTV experience, especially for Video setting and individual color adjustments.

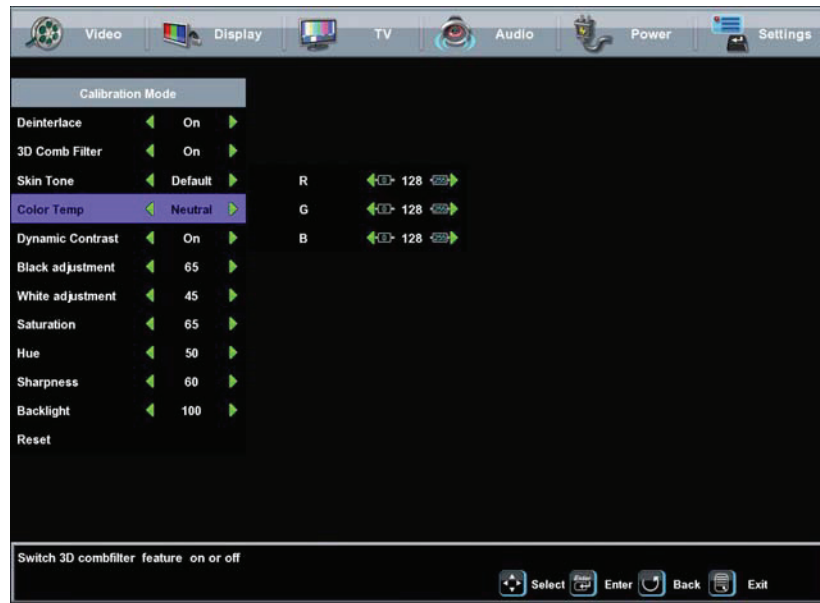

Settings Menu Features	Function Descriptions
<b>Deinterlace</b>	Turns on/off Deinterlace.
<b>3D Comb Filter</b>	Turns on/off 3D Comb Filter. In on mode, the picture quality is better.
<b>Skin Tone</b>	Allow you to adjust the Skin tone
<b>Color Temp</b>	Allow you to select between 3 different color temperatures, Warm, Neutral and Cool
<b>Dynamic Contrast</b>	Enhance dynamically the Black and White levels depending on the displayed picture or video
<b>Black Adjustment</b>	Allow you to adjust the Black levels
<b>White Adjustment</b>	Allow you to adjust the White levels
<b>Saturation</b>	Allow you to adjust Intensity of color
<b>Hue</b>	Allow you to adjust Red/green levels
<b>Sharpness</b>	Allow you to adjust Picture clarity
<b>Backlight</b>	Intensity of HDTV lamp illumination
<b>Reset</b>	Resets video settings to factory default

## 4. HDTV OPERATION

### Color Temperature

The section Color Temp in the “Calibration” menu allow you to adjust each color temperature (Warm, Neutral, Cool) individually.

In case of miss adjustment it can be Reset to factory default.

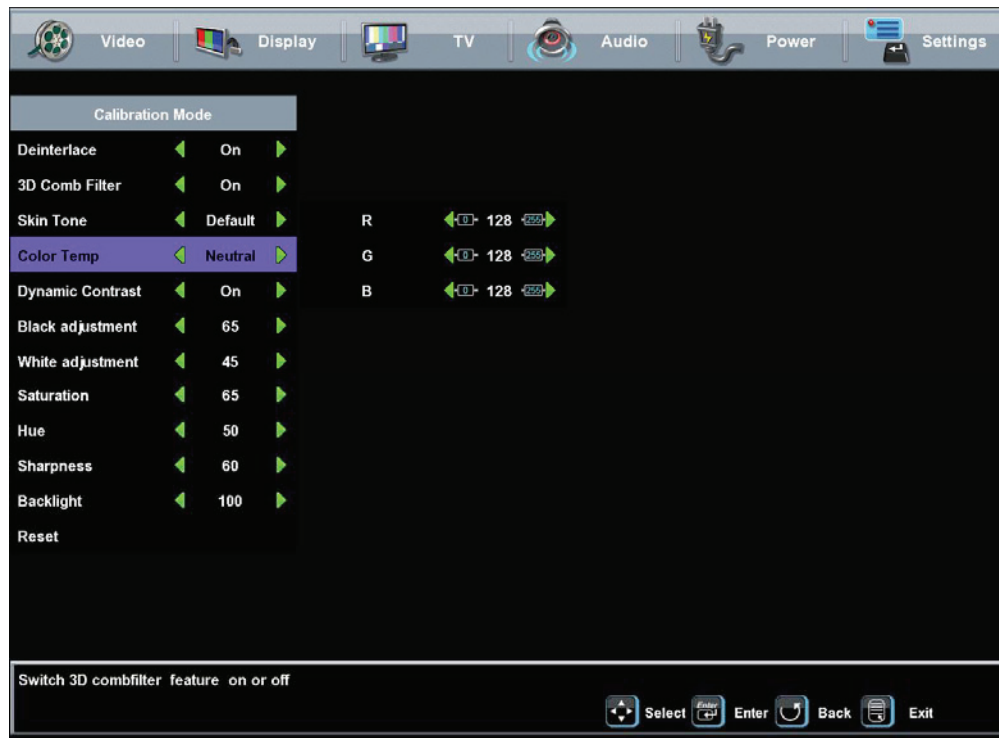

## 4. HDTV OPERATION

### Display Menu

The “Display” menu allows you to control the appearance of the image you see on the screen, based on the selected source input (see picture below)

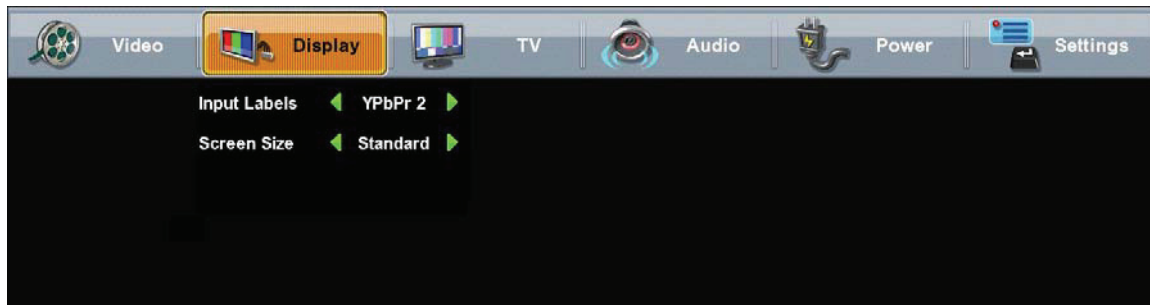

Display Menu Features	Adjustment Descriptions
<b>Input Label</b>	Allows current source input to be changed to one of the labels in the input label list; if the label is already used by another source, the label will be reset to the default label
<b>Screen Size</b>	Adjusts ratio between picture width and picture height (16:9 pictures will be displayed in original format): <ul style="list-style-type: none"> <li>• Standard—conventional format used for viewing 4:3 programs in their normal format</li> <li>• Fill—format that horizontally stretches 4:3 pictures to the edge of the screen (some programs will be broadcasted with black or gray bars on the top and bottom or sides of the picture)</li> <li>• Overscan</li> </ul>

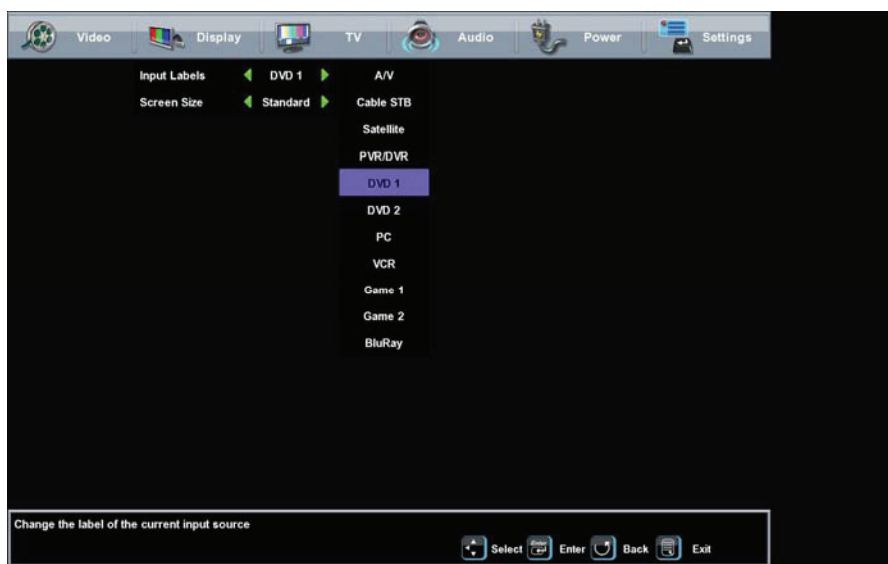

## 4. HDTV OPERATION

### TV Menu

The “TV” menu provides a broad array of functions you’ll use during setup, as well as customizing various features such as closed captioning, favorite channels and parental controls.

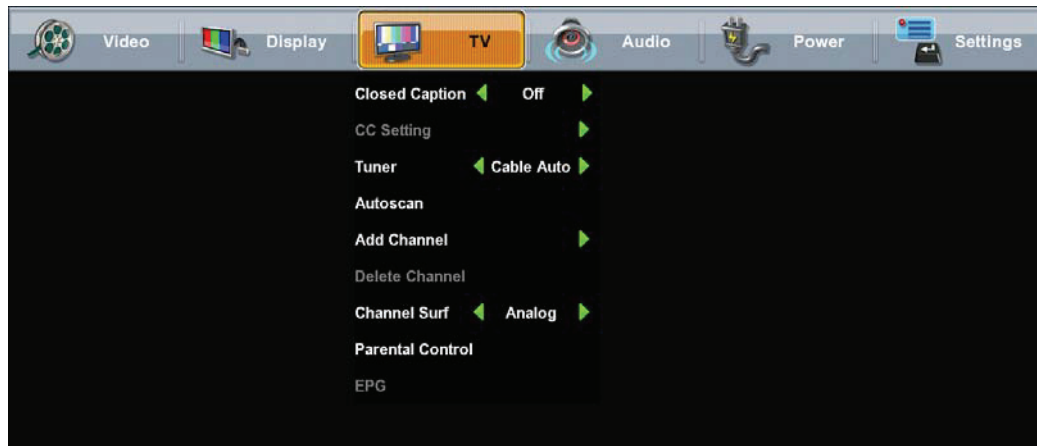

TV Menu Features	Feature/Sub-Menu Descriptions
<b>Closed Caption</b>	Allows you to turn closed captioning of audio on or off, select analog or digital modes, or personalize the captioning style; user-define style sub-menus provide choices for font, size, style, plus text and background colors and opacity
<b>CC Setting</b>	Changes Setting for closed captioning such as font etc.
<b>Tuner Source</b>	Select your signal source: Air, Cable Auto, Cable, HRC or IRC
<b>Auto Scan</b>	Select for automatic scanning of the tuner’s range of frequencies for all viewable channels available
<b>Add/Delete Channel</b>	Allows you to manually add or delete a channel from the current list of viewable channels available
<b>Channel Surf</b>	Allows you to select between Analog, Digital or Both TV channels which will be scanned during the Auto Scan
<b>Parental Controls*</b>	Displays the parental control menu for password-controlled channels and content; sub-menus include lock-outs according to ratings, channels and content
<b>EPG</b>	Choice of Present EPG, Daily EPG Update the EPG functions

*\*For additional information on Parental Control functions, please see “About Parental Controls,” page 31.*

## 4. HDTV OPERATION

### Add or delete additional TV Channels

---

Use the OSD to access the TV Menu Feature

#### Select Add Channel

Add a channel by enter the physical channel number or a range.

#### Select Delete Channel

Delete a channel from the current list of viewable channels available

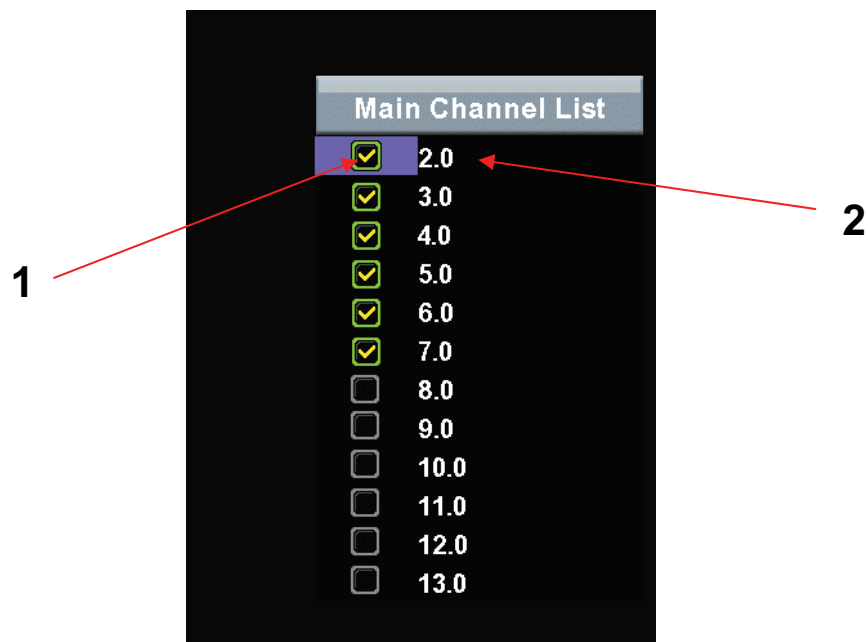

#### 1. Channel Number

- Scroll to highlight a channel number from the list of available channels and press Enter to delete the channel. The OSD Menu has to be fully exit in order to delete the channel

#### 2. Channel Skip

- Highlight channel number and press Enter to switch to the selected Channel.

## 4. HDTV OPERATION

### About Parental Controls

The Parental Controls feature allows you to block TV programs based on various ratings systems, as well as to lock out the HDTV's right side-mounted controls. The first time you enter the "Parental Control" menu, you will be taken to the password sub-menu to set up your four-digit password, which is required for using this feature. You will be prompted to enter your selected password any time you wish to lock or unlock selected programming ratings or channels.

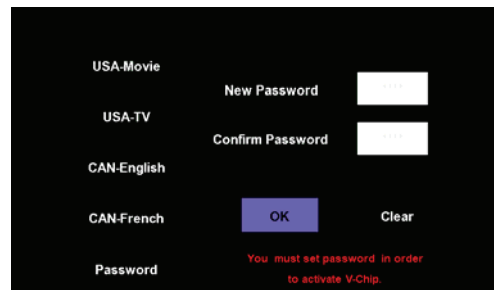
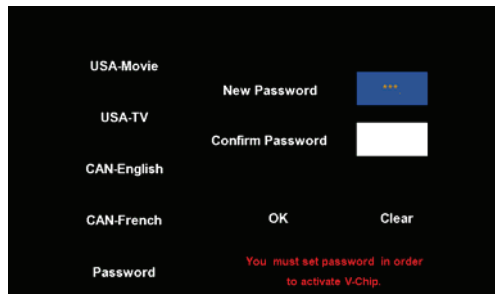



## 4. HDTV OPERATION

### Parental Controls

#### Channel Locks



Parental Control Menu Features	Descriptions & Definitions
<b>Lock Channel</b>	Lock or unlock the HDTV's right side-mounted controls
<b>US MPAA Rating</b>	Lock or unlock programming according to MPAA rating:
<b>US TV Rating</b>	Lock or unlock programming according to TV rating and/or content
<b>CA English Rating</b>	Lock or unlock programming according to Canadian English Ratings
<b>CA French Rating</b>	Lock or unlock programming according to Canadian French Ratings
<b>Password</b>	Select a new parental controls password

#### US MPAA Rating

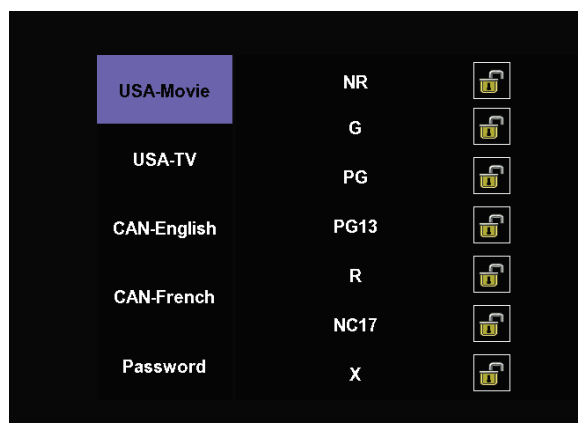

US MPAA Ratings & Content Sub-Menu	
Rating	Definitions
<b>NR</b>	NR (Not available)
<b>G</b>	G (General audience)
<b>PG</b>	PG (Parental guidance suggested)
<b>PG 13</b>	PG-13 (Parents strongly cautioned)
<b>R</b>	R (Restricted)
<b>NC 17</b>	NC 17 (No one 17 or under admitted)
<b>X</b>	X (Adult audience only)

## 4. HDTV OPERATION

### Parental Controls

#### US TV Ratings & Content

This sub-menu allows you to block programming according to US TV Ratings as well as content type.

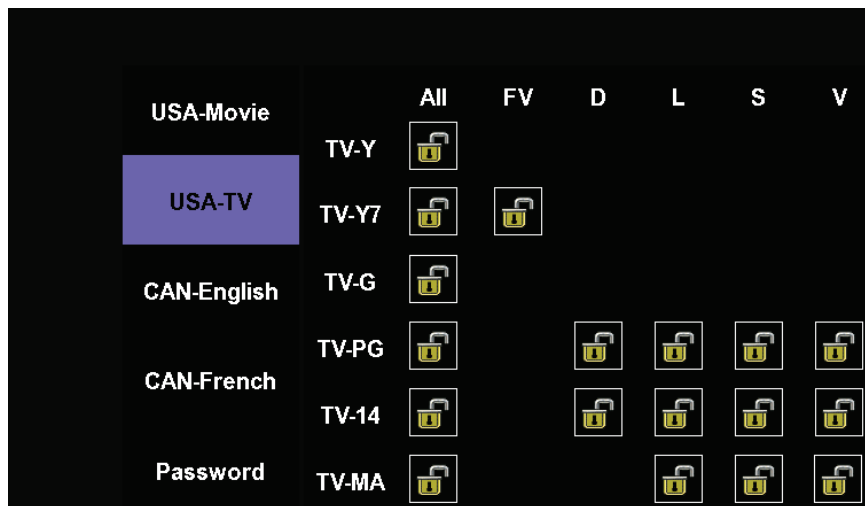

US TV Ratings & Content Sub-Menu	
Rating	Definitions
<b>TV Y</b>	All children
<b>TV Y7</b>	Directed to older children
<b>TV G</b>	General audience
<b>TV PG</b>	Parental guidance suggested
<b>TV 14</b>	Parents strongly cautioned
<b>TV MA</b>	Mature audience only
Content	Definitions
<b>All</b>	All Content
<b>FV</b>	Fantasy Violence
<b>D</b>	Sexually Suggestive Dialog
<b>L</b>	Adult Language
<b>S</b>	Sexual Situations
<b>V</b>	Violence

## 4. HDTV OPERATION

### Parental Controls

#### Canadian English

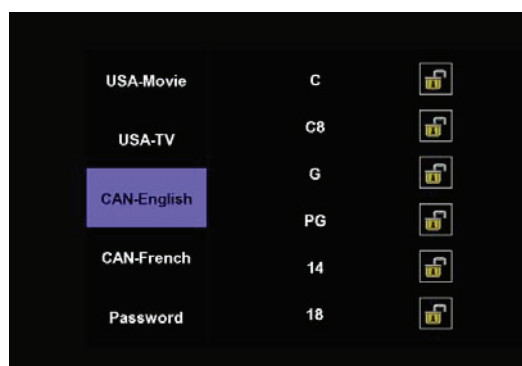

#### Canadian French

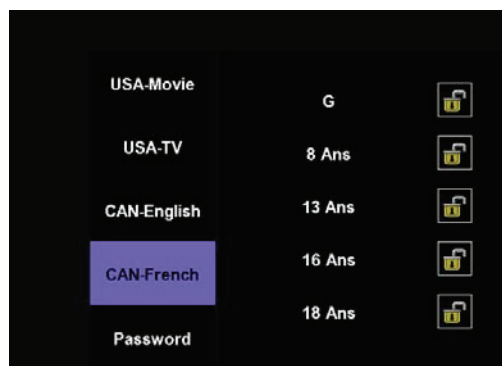

CA/FR Ratings Menus	Ratings Explanations		
	<b>C</b>	Children	<b>G</b>
<b>C8</b>	Children over 8 years	<b>8Ano</b>	General but inadvisable for young children
<b>G</b>	General	<b>13Ano</b>	Over 13 years
<b>PG</b>	Parental Guidance	<b>16Ano</b>	Over 16 years
<b>14</b>	Over 14 years	<b>18Ano</b>	Over 18 years
<b>18</b>	Adults		

## 4. HDTV OPERATION

### PC (VGA only) Menu

The "PC" menu lets you adjust image and phasing.



PC Menu Features	Adjustment Descriptions
<b>Auto Adjustment</b>	Automatically re-centers image to middle of screen by synchronizing both vertical and horizontal refresh rate and resolution
<b>Clock Adjust</b>	Manually adjust the Clock control to eliminate horizontal streaking
<b>Phase Adjust</b>	Manually adjust the Phase control to eliminate Noise
<b>Position</b>	Manually adjust vertical and horizontal position of the screen image

## 4. HDTV OPERATION

### Audio Menu

The “Audio” menu let you precisely configure your audio preferences to optimize your listening experience.

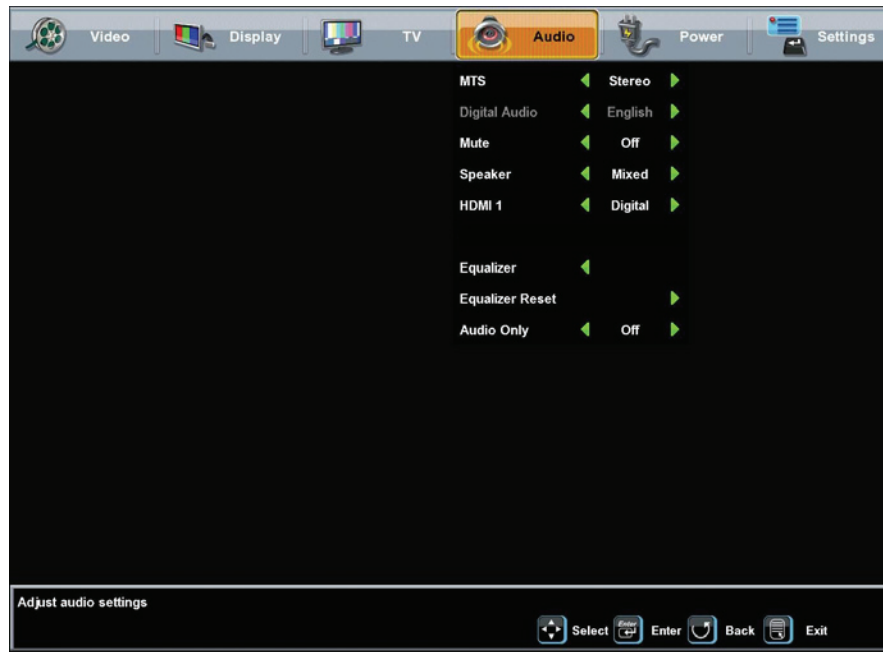

Audio Menu Features	Adjustment Descriptions
<b>Audio Only</b>	Enables to listen to Audio only, the picture (Backlight) will be turned off and can be reactivate with any button of the Remote Control
<b>MTS</b>	Choose from three different MTS (Multi-Channel Television Sound) settings: <ul style="list-style-type: none"> <li>• Mono</li> <li>• Stereo</li> <li>• SAP</li> </ul>
<b>Digital Audio</b>	Enables language selection for digital channels
<b>Mute</b>	Turn audio on/off
<b>Speaker</b>	Turn internal speaker on/off or have both on (Mixed)
<b>HDMI</b>	Switch the HDMI audio input source to either: <ul style="list-style-type: none"> <li>• Analog—RCA audio input</li> <li>• Digital—HDMI cable integrated audio input</li> </ul>
<b>Equalizer</b>	Choose from eight different Audio settings: <ul style="list-style-type: none"> <li>• User, Speech, Jazz, Classic, Rocks, Electronic, Bass ,Vocal.</li> </ul>
<b>Equalizer Reset</b>	Allow you to reset each Audio mode separately to factory setting

## 4. HDTV OPERATION

### Equalizer Menu

The “Equalizer ” menu let you individually configure your audio preferences to optimize your listening experience.

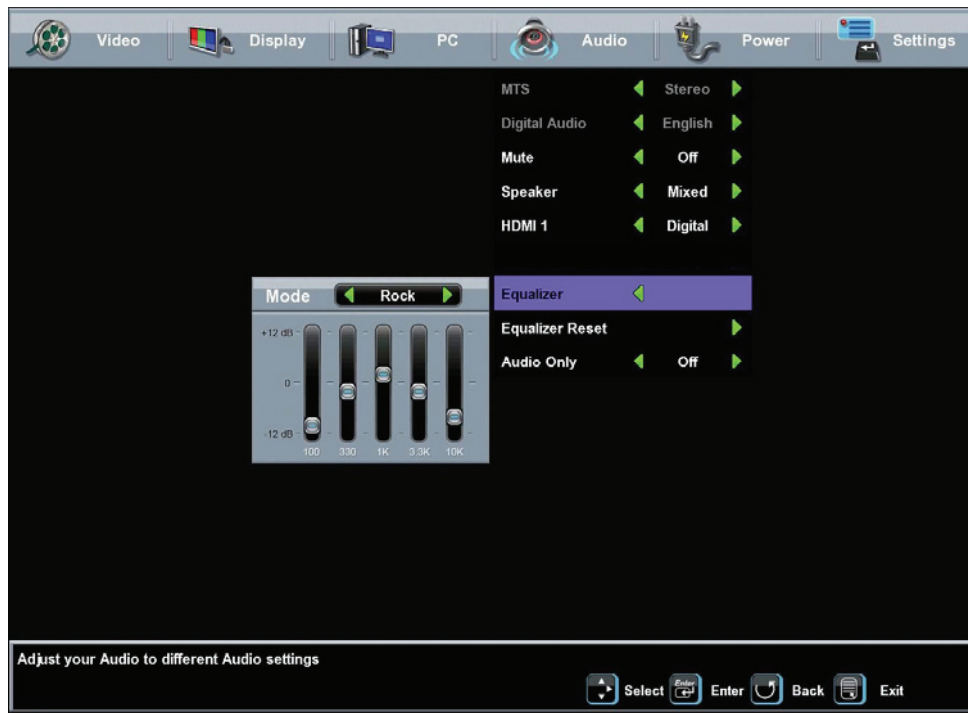

Equalizer Menu Features	Adjustment Descriptions
<b>User</b>	Allow you to adjust the preset mode according to your preference and listening experience.
<b>Rock</b>	Allow you to adjust the preset mode according to your preference and listening experience.
<b>Vocal</b>	Allow you to adjust the preset mode according to your preference and listening experience.
<b>Bass</b>	Allow you to adjust the preset mode according to your preference and listening experience.
<b>Speech</b>	Allow you to adjust the preset mode according to your preference and listening experience.
<b>Jazz</b>	Allow you to adjust the preset mode according to your preference and listening experience.
<b>Electronic</b>	Allow you to adjust the preset mode according to your preference and listening experience.
<b>Classic</b>	Allow you to adjust the preset mode according to your preference and listening experience.

## 4. HDTV OPERATION

### Power Menu

The “Power” menu allows you to manage various power-related functions to simplify your viewing experience and save power.

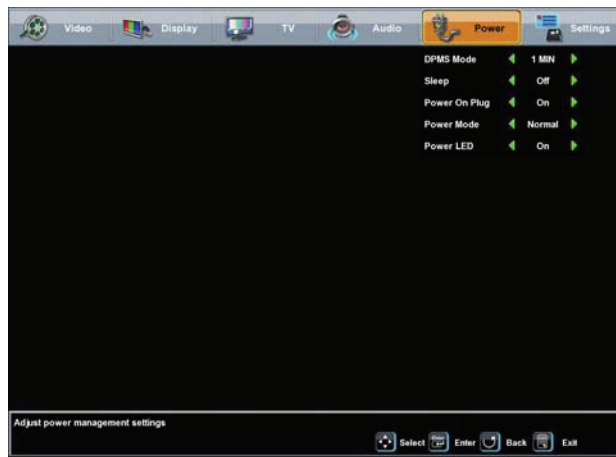

Power Menu Features	Feature Descriptions
<b>DPMS Mode</b>	Lets you turn the DPMS (Display Power Management Signaling) On/Off; when “On,” the display goes into Standby mode if there’s no incoming signal from the selected input for 1-, 5- or 10-Minute intervals
<b>Sleep</b>	Sets the High Definition LCD TV to turn off after a specified amount of time: <ul style="list-style-type: none"> <li>• Off</li> <li>• 15 minutes</li> <li>• 30 minutes</li> <li>• 45 minutes</li> <li>• 60 minutes</li> </ul> <p>NOTE: The HDTV will take a few seconds to return from Sleep mode.</p>
<b>Power On Plug</b>	Enables/disables feature that allows your HDTV to automatically turn back when power is restored
<b>Power Mode</b>	Sets the power boot up mode: <ul style="list-style-type: none"> <li>• E. Saver—takes longer to come back from Standby but requires less power</li> <li>• Normal—faster return from Standby but requires more power</li> </ul>
<b>LED</b>	Turns the HDTV’s LED on and off

## 4. HDTV OPERATION

### Settings Menu

The “Setting” menu integrates still more choices that allow you to optimize your HDTV experience, from language selection to pertinent system and installation information.

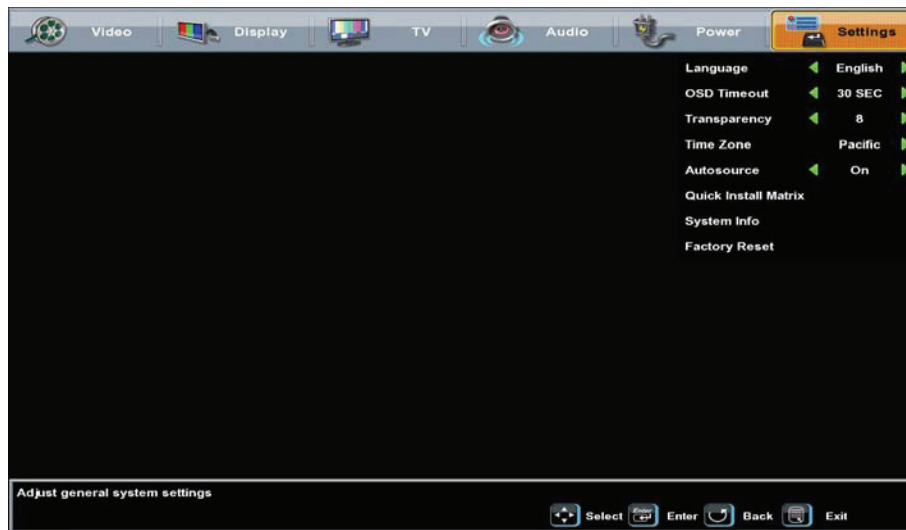

Settings Menu Features	Function Descriptions
<b>Language</b>	Select the OSD language from the following: <ul style="list-style-type: none"> <li>• English</li> <li>• Spanish</li> <li>• French</li> </ul>
<b>OSD Timeout</b>	Select On/Off for the OSD to leave the screen; when “On,” the OSD will time out in one of three selected time frames: <ul style="list-style-type: none"> <li>• 5 seconds</li> <li>• 10 seconds</li> <li>• 30 seconds</li> </ul>
<b>Transparency</b>	Adjust the transparency level of the OSD
<b>Time Zone</b>	Set the High Definition LCD TV to your local time zone
<b>Autosource™</b>	Turns Autosource detection On/Off. In On mode Autosource can detect a new source which is plugged in the TV and switch input source setting of your HDTV to the source automatically.
<b>Quick Install Matrix</b>	Displays the Quick Install Matrix for referencing connections
<b>System Info</b>	Access system information like FW revision
<b>Factory Reset</b>	Resets all of the HDTV’s OSD menu settings (except parental controls and scanned TV channels) back to the factory default settings



## 4. HDTV OPERATION

### Input Menu

To change the Main Picture source, press the Input button on the remote to display the Main Picture (MP) input menu. When the input menu is open, press the Input button again to switch to the next input or use the up/down arrows to scroll through the inputs and the press enter to switch to the highlighted input. The input menu will timeout after 5 seconds and switch to the input that is currently highlighted.

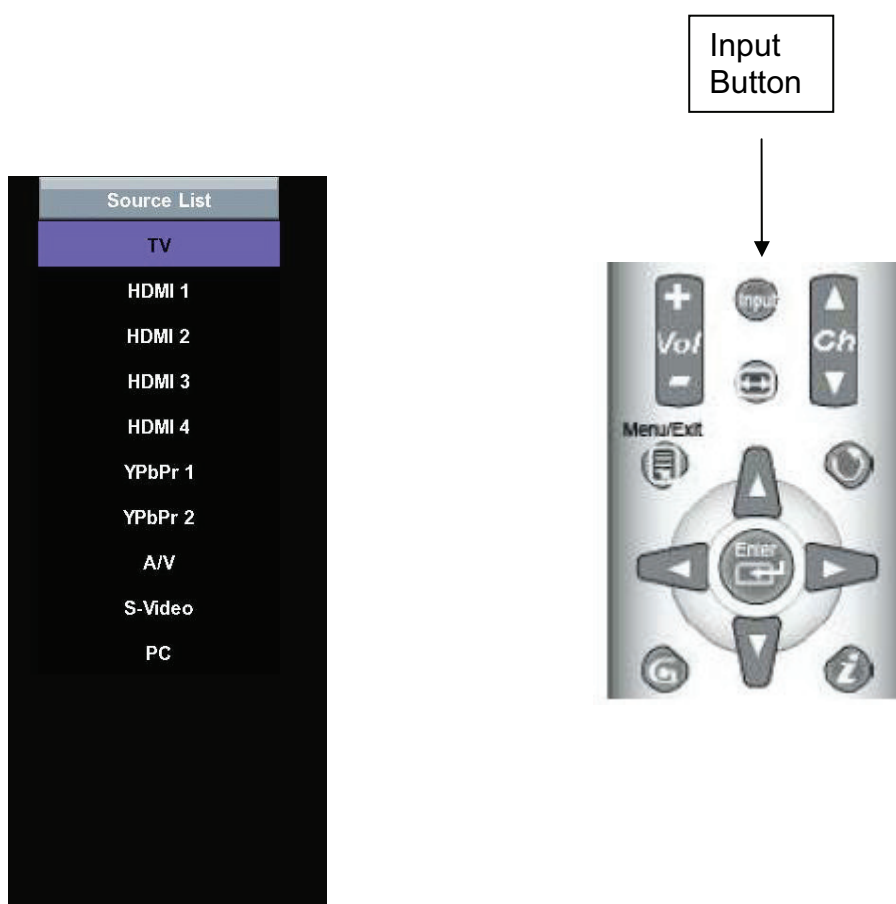



## 5.APPENDIX: 47-inch High Definition LCD TV Specifications

<b>Model Name</b>	TX-47F430S	
<b>Panel</b>	Type	47" TFT (Thin Film Transistor), Active Matrix LCD, 1920 x 1080 vertical stripe; anti-glare coating
	Color	<b>16.7 million colors</b>
	<b>Aspect Ratio</b>	<b>16:9</b>
<b>Viewing Angles</b>	176° H) / 176° (V)	
<b>Input Signal</b>	Video/Audio	RGB( Analog * 1 (75 ohms, 0.7 Vp-p)/Mini-Stereo *1 - H/V separated (TTL) for PC HDMI-HDCP * 4 / RCA (L/R) * 1 - fh: 30-80 kHz, fv: 50-75 Hz NTSC TV system NTSC / HDTV * 1 Component Video * 2 / RCA (L/R) Stereo * 2 Composite * 1 / S-Video * 1 / RCA (L/R) stereo * 1
<b>Output Signal</b>	<b>RCA (L/R)/SPDIF</b>	
<b>HDTV Compatibility</b>	480i, 480p, 720p, 1080i, 1080p	
<b>PC Compatible</b>	Recommended	1920 x1080@ 60Hz
	Supported	1024 x 768 @ 75 Hz                      800 x 600 @ 60, 75 Hz 1024 x 768 @ 60Hz 1280 x800 @ 60Hz                      640 x 480 @ 60, 75 Hz
<b>Speaker Output</b>	15W (x2 Channels)	
<b>Power</b>	Voltage	100~264 VAC, 50/60Hz, 6.0A. universal
<b>Temperature</b>	Operating	15 to + 35° C (Hum < 75%)
	Storage	-10 to +50° C (Hum < 35%)
Humidity (Relative)	Operating	20 to 80% non-condensing
	Storage	20 to 90% non-condensing.
Altitude	Operating	0 to 2,000 m
	Storage	0 to 12,000m
<b>Dimensions</b>	Physical	46.1", 1170 mm (W) x 32.3", 820 mm (H) x 9.3", 235mm (D) (with Base)
		46.1", 1170 mm(W) x 29.5", 749mm x 5.5", 140 mm (w/out Base)
<b>Weight</b>	Net / Gross	37.85kg / 31.8 kg
		83.4lbs. (with Base); 70 lbs. (w/out Base)
<b>Regulations</b>	UL/C-UL, FCC-B	
<b>Power Consumption</b>	On	<350W Typical (Blue LED)
<b>Modes</b>	Active Off	<1W (Amber LED) in E-Mode and <42W (Amber LED) Normal Mode
<b>Warning:</b> Do not set the graphics card in your computer to exceed these refresh rates; doing so may result in permanent damage to the High Definition LCD TV.		
<b>Note:</b> Product Specifications are subject to change without notice.		



## **5. APPENDIX: Troubleshooting**

### **No Power**

- Make sure power cord is securely connected to the “AC In” jack on the back of the High Definition LCD TV.
- Make sure AC power cord is securely connected to the AC socket.
- Plug another electrical device (such as a radio) to the power outlet to verify that the outlet is supplying the proper voltage.
- When set to E. Saver, the TV will take longer to turn on. Change the Power menu setting to Normal to improve power on time.

### **Power is suddenly turned off**

- Check if Sleep Timer is set. If so, turn it off.
- Check if Inactivity Off is set. If so, turn it off.

### **Remote Control Does Not Work**

- Press only one button at a time.
- Make sure batteries are inserted correctly.
- Replace batteries with new ones if necessary.

### **Remote Control Code Not Found in a “Universal” Remote**

- Purchase a separate “learning” remote control.
- Go to [www.westinghousedigital.com](http://www.westinghousedigital.com) for a list of remote codes.

### **Image Quality Issues**

- For the best TV image quality, “Standard Definition” TV content should be viewed in 4:3 format.

### **No Picture**

- Check the video connection.
- Make sure the video cable connected to the High Definition LCD TV is tightly secured to the video output port on the back of the computer. If the other end of the video cable is not attached permanently to the High Definition LCD TV, secure it tightly.
- Adjust brightness and contrast.
- If you are using a Macintosh computer older than G3, you need a Macintosh adapter.
- Make sure that the input source you are connected to corresponds to the source on the High Definition LCD TV.
- Verify that the antenna is properly connected.

### **No Picture when I connect VGA cable or “No Input Signal”**

- Check VGA cable connection.
- Lower the video resolution on the computer and try again.

## **5. APPENDIX: Troubleshooting**

### **Picture is cut off/with sidebar screen.**

- Use “Auto Adjust”.
- Make sure the aspect ratio is set correctly.

### **Blocky images appear in TV mode.**

- Check your antenna connection. If necessary, rotate the antenna and wait up to 10 seconds for signal.
- Reduce signal splitters and excessively long cables.
- Replace poor antenna cables and/or connectors to improve signal quality.

### **Wrong or Abnormal Colors**

- If any colors (red, green or blue) are missing, check the video cable to make sure it’s securely connected. Loose or broken pins in the cable connector could cause an improper connection.
- Connect the High Definition LCD TV to another computer.

### **Snow Appears on Screen**

- Check your antenna connection. If necessary, rotate the antenna and wait up to 10 seconds for signal.
- Check the TV/CATV selection.
- Make sure the external device is HDCP compliant.

### **AUDIO Interconnection Issues**

- Remember—S-Video and Composite AV1 share the same audio source.

### **There’s No Sound**

- Check the audio connection.
- If MUTE appears on the screen, press the “MUTE” button on the remote control to turn the function off.
- Check the audio settings to see if the HDTV audio is set to SAP or minimum.
- Press the Volume + (Up) key on the remote control.

### **Parental Control Password is “LOST”**

- While rare, if this should happen, select “PASSWORD EDIT” and enter “0000” to reset the password.

### **Where Can I Find More Help?**

- Log on to: [www.westinghousedigital.com](http://www.westinghousedigital.com)
- Contact Westinghouse Customer Service at (866) 287-5555 or write us at [service@westinghousedigital.com](mailto:service@westinghousedigital.com)

## **5. APPENDIX: Cleaning the High Definition LCD TV**

- **MAKE SURE THE HIGH DEFINITION LCD TV IS TURNED OFF**
- **NEVER SPRAY OR POUR ANY LIQUID DIRECTLY ONTO THE SCREEN OR CASE**

### **To clean the screen:**

1. Wipe the screen with a clean, soft lint-free cloth. This removes dust and other particles.
2. If still not clean, apply a small amount of non-ammonia, non-alcohol based glass cleaner onto a clean, soft lint-free cloth and wipe the screen.

### **To clean the case:**

1. Use a soft, dry cloth.
2. If still not clean, apply a small amount of non-ammonia, non-alcohol based, mild non-abrasive detergent onto a clean, soft lint-free cloth, then wipe the surface.

### **Disclaimer**

Westinghouse Digital does not recommend the use of any ammonia or alcohol-based cleaners on the High Definition LCD TV screen or case. Some chemical cleaners have been reported to damage the screen and or High Definition LCD TV case. Westinghouse Digital will not be liable for damage resulting from use of any ammonia or alcohol-based cleaners.

## **5. APPENDIX: Wall mount and Base removal for the 42"/47"HD LCD TV**

The TV has been fitted with two sets of VESA mounting holes. The holes are spaced 75 mm and 100 mm equally apart for the 42" product and 100 mm and 200 mm equally apart for the 47" product. These mounting location are provided strictly as an option to the user for wall mounting.

It is the responsibility of the user to use a UL Listed Wall Mount Unit rated to support the weight of this TV. Please consult authorized service personnel for the installation of this Unit. Incomplete or inadequate mounting of the unit to the wall may cause it to fall down, resulting in potentially serious injury.



- Lay the LCDTV with front bezel down on a soft and clear area. Please make sure that there is no any foreign objects on the surface to avoid any scratch or damage of the LCD panel

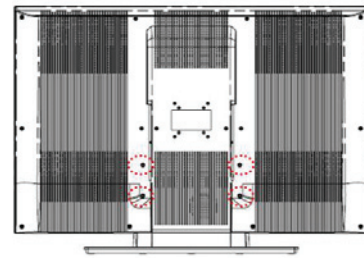

The base is fixed with 4 points of

- Remove the four screws as shown in Step -2

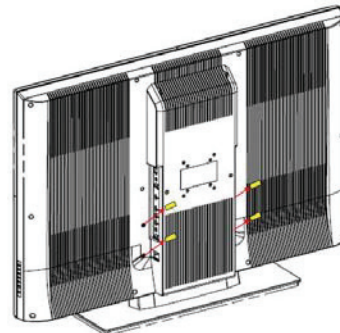

- Remove the base from LCD TV as shown in Step-3

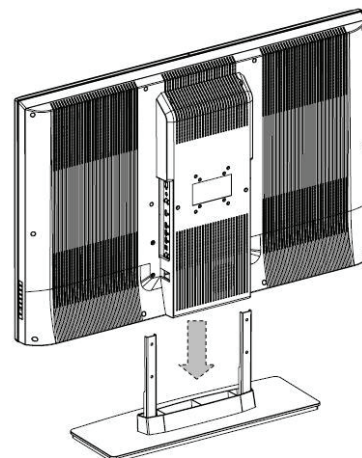

Pull down the base



## **5. APPENDIX: Wall mount and Base removal for the 52" HD LCD TV**

The TV has been fitted with two sets of VESA mounting holes. The holes are spaced 100 mm and 200 mm equally apart for the 52" product. These mounting location are provided strictly as an option to the user for wall mounting.

It is the responsibility of the user to use a UL Listed Wall Mount Unit rated to support the weight of this TV. Please consult authorized service personnel for the installation of this Unit. Incomplete or inadequate mounting of the unit to the wall may cause it to fall down, resulting in potentially serious injury.



- Lay the LCDTV with front bezel down on a soft and clear area. Please make sure that there is no any foreign objects on the surface to avoid any scratch or damage of the LCD panel



- Remove the four screws as shown in Step -2

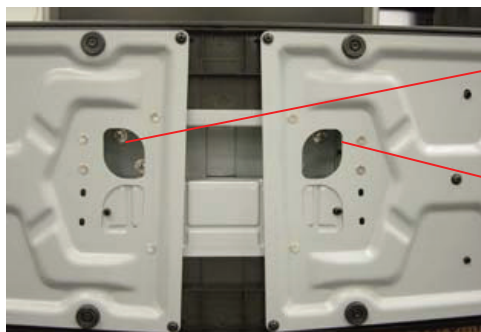

- Remove the base from LCD TV as shown in Step-3



## 5. APPENDIX: Safety bracket Options

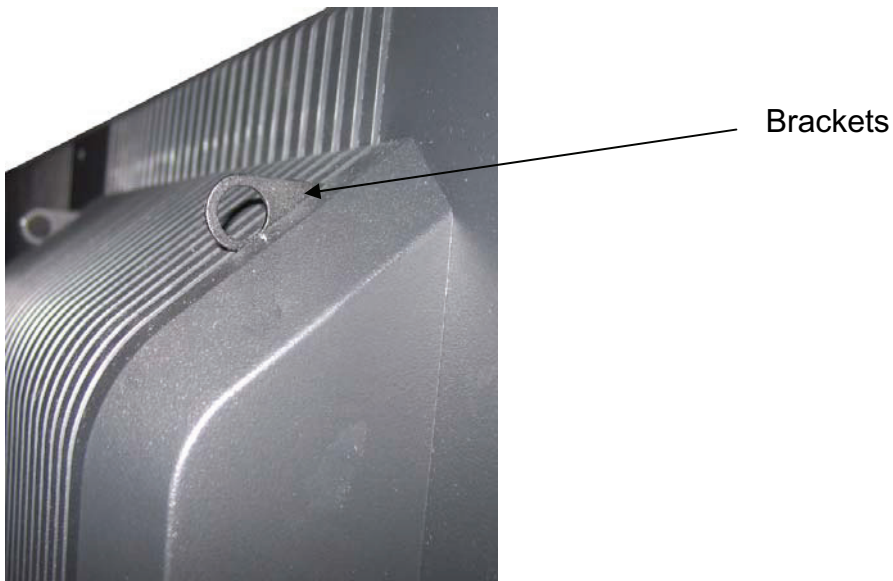

### Anti-tip over option:

This TV has two small metal brackets on the back side of the TV. These two brackets have a circular cut out in the center. The brackets are to serve as an "anti-tipover" option and/or theft deterrent.

If used as an "anti-tip over" aid, it is the responsibility of the user to securely anchor the brackets to a surface that can support the weight of the TV. (Note: at no time do we advocate using these brackets to support the entire weight of the TV.) These brackets must be used in conjunction with TV's provided base. The brackets are to be used as an additional safety precaution option.

### Theft deterrent option:

If used as a theft deterrent, much like the "anti-tipover" application, the brackets can aid in anchoring the TV.



**[www.wde.com](http://www.wde.com)**

## Free Manuals Download Website

<http://myh66.com>

<http://usermanuals.us>

<http://www.somanuals.com>

<http://www.4manuals.cc>

<http://www.manual-lib.com>

<http://www.404manual.com>

<http://www.luxmanual.com>

<http://aubethermostatmanual.com>

Golf course search by state

<http://golfingnear.com>

Email search by domain

<http://emailbydomain.com>

Auto manuals search

<http://auto.somanuals.com>

TV manuals search

<http://tv.somanuals.com>