



USER'S MANUAL
MANUEL DE L'UTILISATEUR
MANUAL DEL USUARIO

VR-5585DFZ

TABLE OF CONTENTS

1	IMPORTANT INFORMATION	2
2	HOW TO INSTALL THE STAND	4
3	PREFACE	5
4	SAFETY PRECAUTIONS	5
5	CARTON CONTENTS	7
6	OVERVIEW	8
7	INSTALLATION	<ul style="list-style-type: none"> Power Cord Connection 9 Antenna Connection 9 AV Connection 10 YPbPr(component) Connection 10 VGA(PC) Connection 11 COAX Connection 11 HDMI Connection 12 Service Port Function 12
8	REMOTE CONTROL	<ul style="list-style-type: none"> Remote control instructions in TV mode 13 Remote control setup 14
9	MENU OPERATION	<ul style="list-style-type: none"> Setup Wizard 15 Select Input Source 17 Basic Operation 17 Picture Menu 18 Sound Menu 21 Channel Menu 23 Parental Control 25 Setup Menu 28 Other Menu 31 Picture Menu 32
10	TROUBLESHOOTING	35
11	SPECIFICATIONS	36

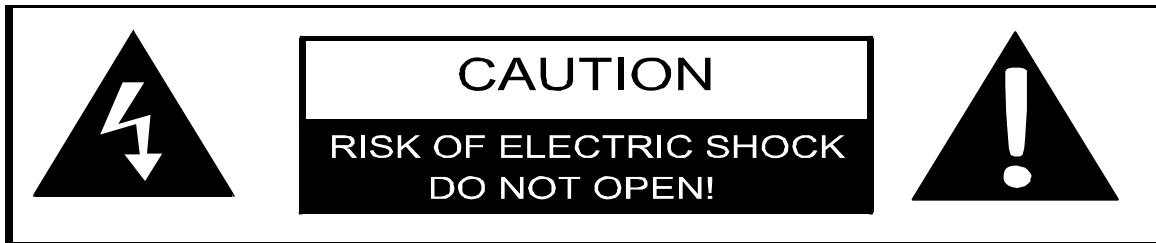

The lightning flash with arrowhead symbol, within an equilateral triangle, is intended to alert the user to the presence of un-insulated dangerous voltage within the products enclosure that may be of sufficient magnitude to constitute a risk of electric to persons.



The exclamation point within an equilateral triangle is intended to alert the user to the presence of important operating and maintenance (servicing) instructions in the literature accompanying the appliance.

CAUTION: USE OF ANY CONTROLS, ADJUSTMENTS, OR PROCEDURES OTHER THAN THOSE SPECIFIED HEREIN MAY RESULT IN HAZARDOUS RADIATION EXPOSURE.

CAUTION: These servicing instructions are for use by qualified service personnel only. To reduce the risk of electric shock, do not perform any servicing other than that contained in the operating instructions unless you are qualified to do so.

Refer to service manual for servicing instructions.

Important Safety Instructions

Note:

1. Read these instructions.
2. Keep these instructions.
3. Heed all warnings.
4. Follow all instructions.
5. Do not use near water.
6. Clean only with dry cloth.
7. Do not block any ventilation openings. Install in accordance with the manufacturer's instructions.
8. Do not install near any heat sources such as radiators, heat registers, stoves, or other apparatus (including amplifiers) that produce heat.
9. Do not defeat the safety purpose of the polarized or grounding-type plug. A polarized plug has two blades with one wider than the other. A grounding type plug has two blades and a third grounding prong. The wide blade or the third prong are provided for your safety. If the provided plug does not fit into your outlet, consult an electrician for replacement of the obsolete outlet.

10. Protect the power cord from being walked on or pinched particularly at plugs, convenience receptacles, and the point where they exit from the apparatus.
11. Only use attachments / accessories specified by the manufacturer.
12. Use only with the cart, stand, tripod, bracket, or table specified by the manufacturer, or sold with the apparatus.
When a cart is used, use caution when moving the cart / apparatus combination to avoid injury from tip-over.



13. Unplug this apparatus during lightning storms or when unused for long periods of time.
14. Refer all servicing to qualified service personnel. Servicing is required when the apparatus has been damaged in any way, such as power-supply cord or plug is damaged, liquid has been spilled or objects have fallen into the apparatus, the apparatus has been exposed to rain or moisture, does not operate normally, or has been dropped.
15. Apparatus shall not be exposed to dripping or splashing and that no objects filled with liquids, such as vases, shall be placed on the apparatus.
16. **WARNING:** To reduce the risk of fire or electric shock, do not expose this apparatus to rain or moisture.
17. Mains plug or appliance coupler is used as the disconnect device, shall be readily operable.

How to install the stand!

English

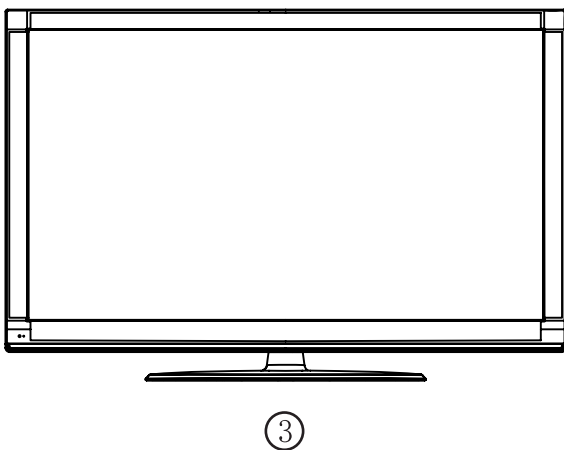
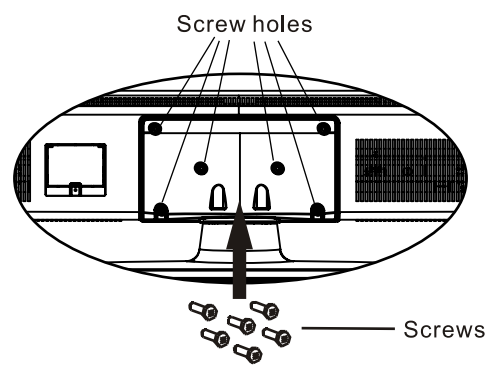
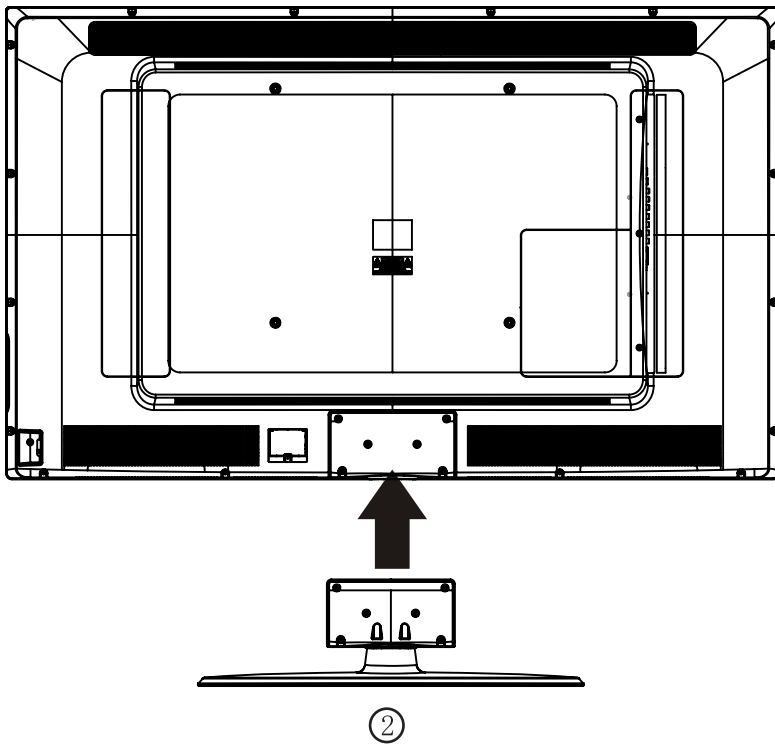
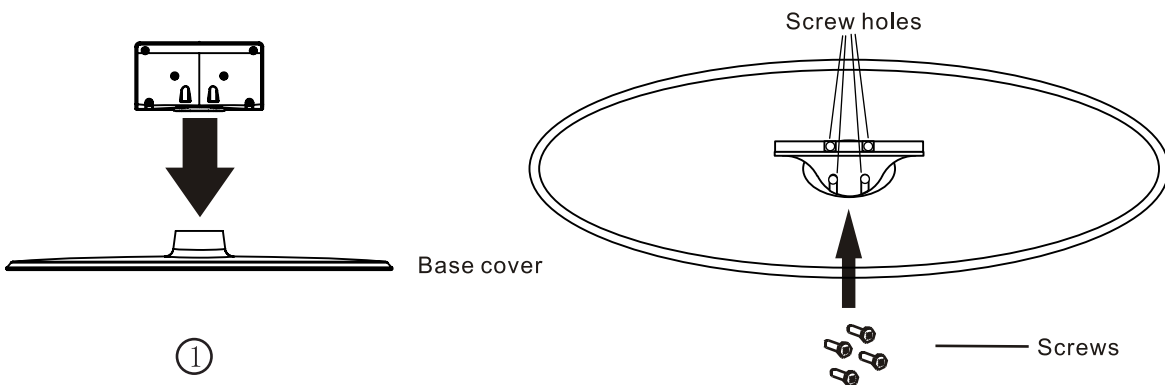

3. PREFACE

Thank you for buying this TV! Please read this manual thoroughly before operating the TV. Make sure the TV was not damaged in transit. If the TV is damaged, do not install it and contact the Westinghouse Customer Service.

4. SAFETY PRECAUTIONS



Put the TV on a stable surface.

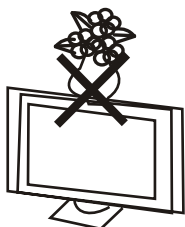

Do not place any material on the TV.

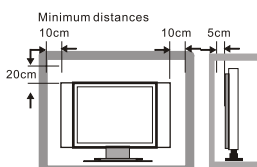

Do not use the TV with fixtures other than those provided or suggested by the manufacturer.

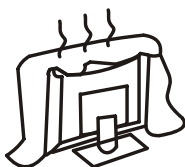

Do not block or cover the ventilation openings on the TV. If you have a wall mount, check that it is steady.



Power cord and cables must be properly routed and protected to prevent people from stepping on them and causing the TV to fall.

SAFETY PRECAUTIONS

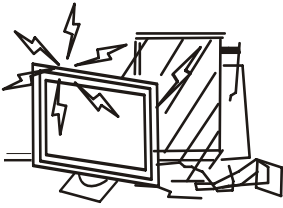

Keep the TV dry and away from humidity.

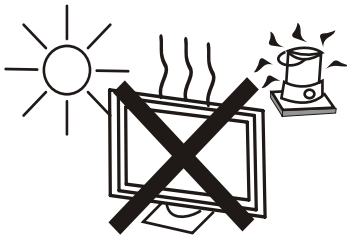

Keep the TV away from heat sources.

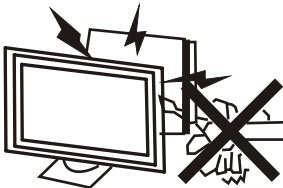

Unplug the TV before cleaning it. Do not use solvent or liquid to clean the TV.

Only clean the TV with a soft and dry cloth.

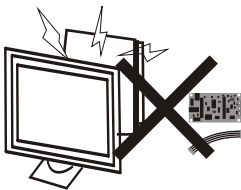

In case of troubleshooting, do not use spare parts other than those suggested by the manufacturer. Using inadequate spare parts can lead to electric shocks, short-circuits, fire or other incidents.



Unplug the TV during lightning storms or when unused for long periods of time.

5. CARTON CONTENTS

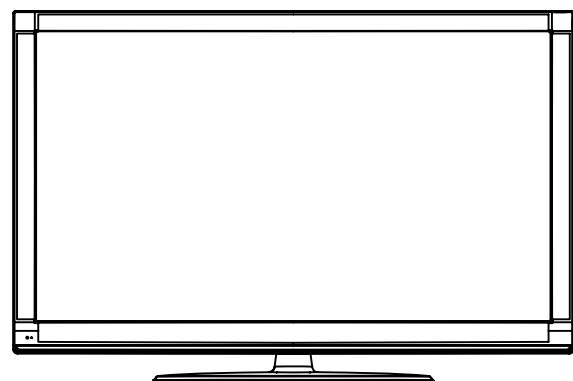

LCD TV SET



Remote Control

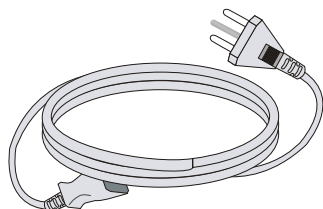

Power Cable

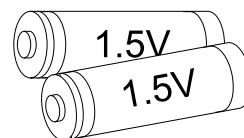

AAA Batteries

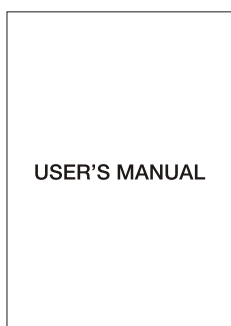

USER'S MANUAL

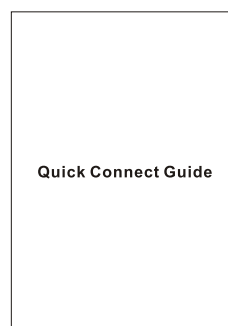

Quick Connect Guide

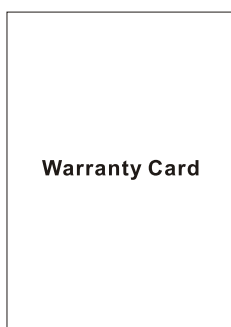

Warranty Card

English

6. OVERVIEW

Front View

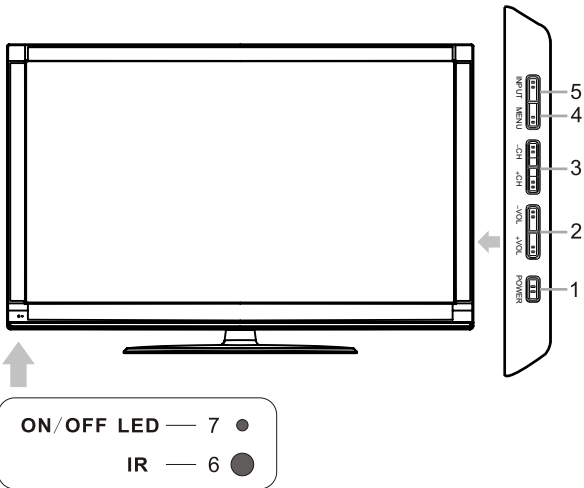

1. Press “POWER” button to turn the TV on or off.
2. Press “VOL+” or “VOL-” to increase or decrease the volume.
3. Press “CH+” or “CH-” to scan through channels.
4. Press “MENU” to bring up the main menu on the screen.
5. Press “INPUT” to select the input source.
6. REMOTE SENSOR: infrared sensor for the remote control.
7. POWER INDICATOR: Blue when TV is powered on. Red when TV is powered off. No color when power switch is turned off.

English

Back View and Control Connections

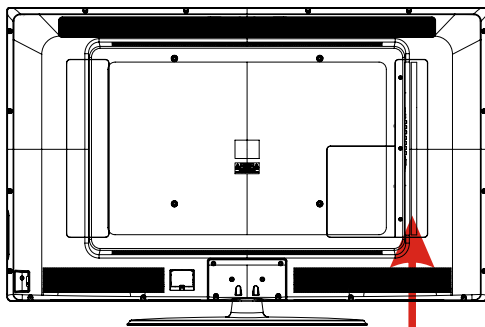

1. AC IN and POWER SWITCH: Main power input.
2. HDMI1/HDMI2/HDMI3: Connect the HDMI output jack of DVD.
3. PC AUDIO: Connect the Audio output jack of PC.
4. VGA (PC) : Connect the PC-RGB output jack of PC.
5. YPbPr1/YPbPr2: Connect the YPbPr output jack of DVD or VCR.
6. Y-L/R1, Y-L/R2(Shared audio with AV IN): For YPbPr audio.
7. VIDEO: Connect the Video input jack of DVD or VCR.
L/R: For VIDEO audio.
8. AUDIO OUT: Connect to the audio equipment.
9. Ω : Connect the headphone.
10. TUNER: Connect the antenna.
11. USB SERVICE: USB Port for Factory Use Only.
12. COAX out: Connect the COAX receiver.

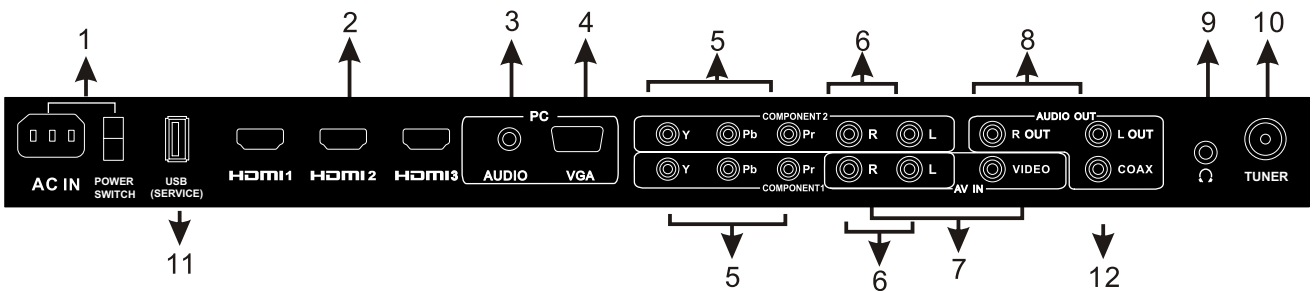

7. INSTALLATION

Power Cord Connection

- Connect the power cord into AC IN as shown below.
- Make sure the power switch is turned on, which is located at the back of the TV.

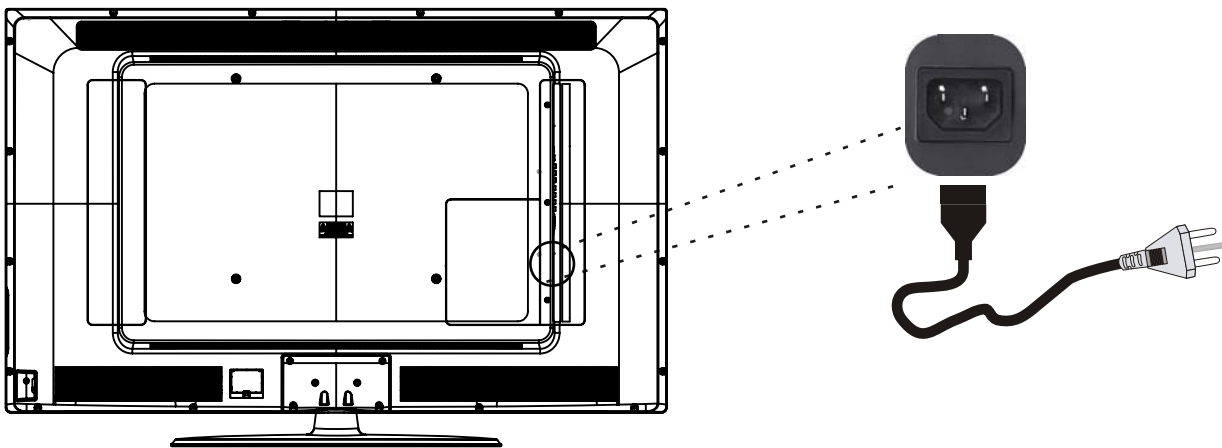

Antenna Connection

To ensure good picture and sound, TV antenna system needs to be installed. The antenna system as shown can be sourced from TV equipment shops, which will provide service for correct installation and connection. After installation, insert the 75-ohm antenna plug into the antenna jack as shown.

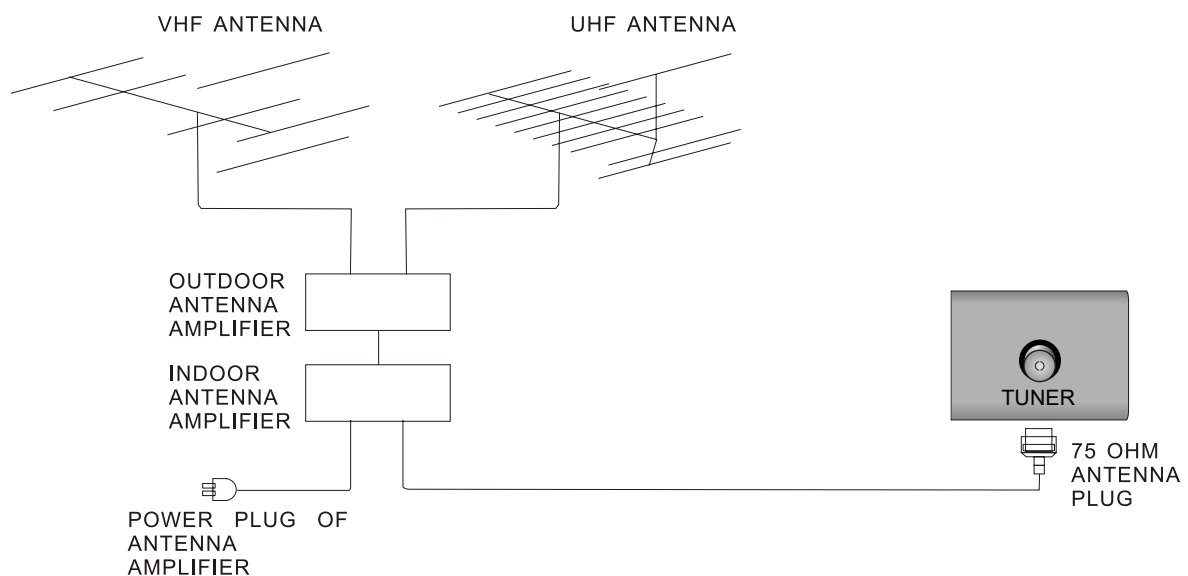

AV Connection

Connect the VIDEO and AUDIO output jack of a DVD or VCR to the AV jacks on the set using a RCA cable. Match the jack colors: Video is yellow, Audio left is white, and Audio right is red. Select the AV input source using the INPUT button on the remote control.

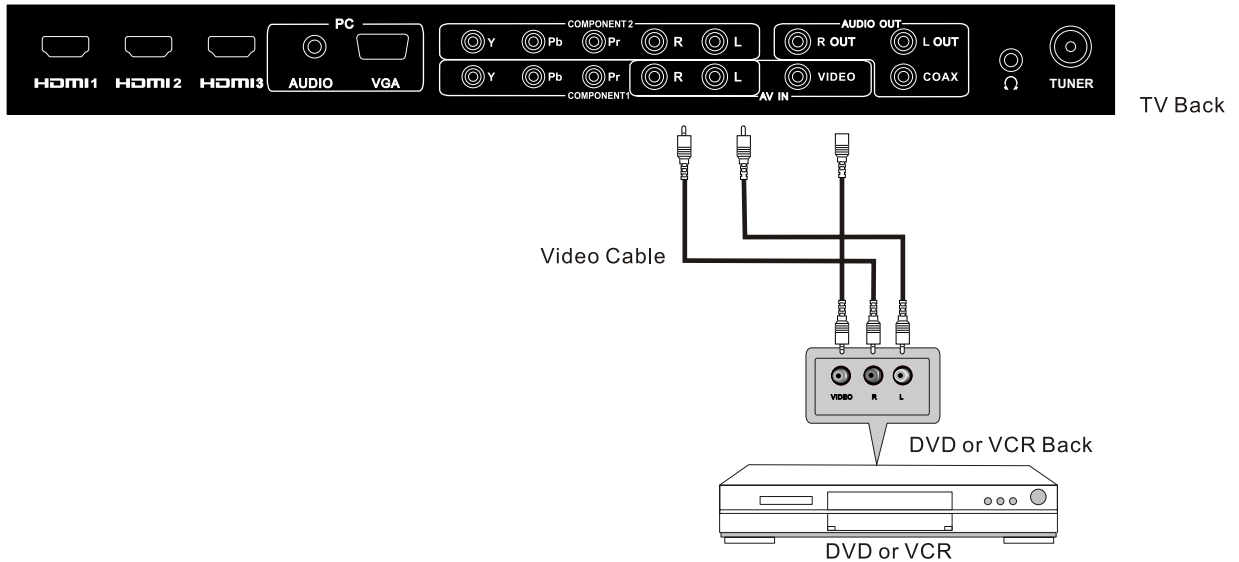

YPbPr(Component) Connection

Connect the YPbPr output of a DVD or VCR to the YPbPr input on the TV. The picture quality is improved; compared to connecting a regular VCR to the video input. Connect the Audio output of a DVD or VCR to the Audio input jacks on the set using a RCA cable. Match the jacks colors: Y is green, Pb is blue, Pr is red, Audio left is white and Audio right in red. Select component input source using the INPUT button on the remote control.

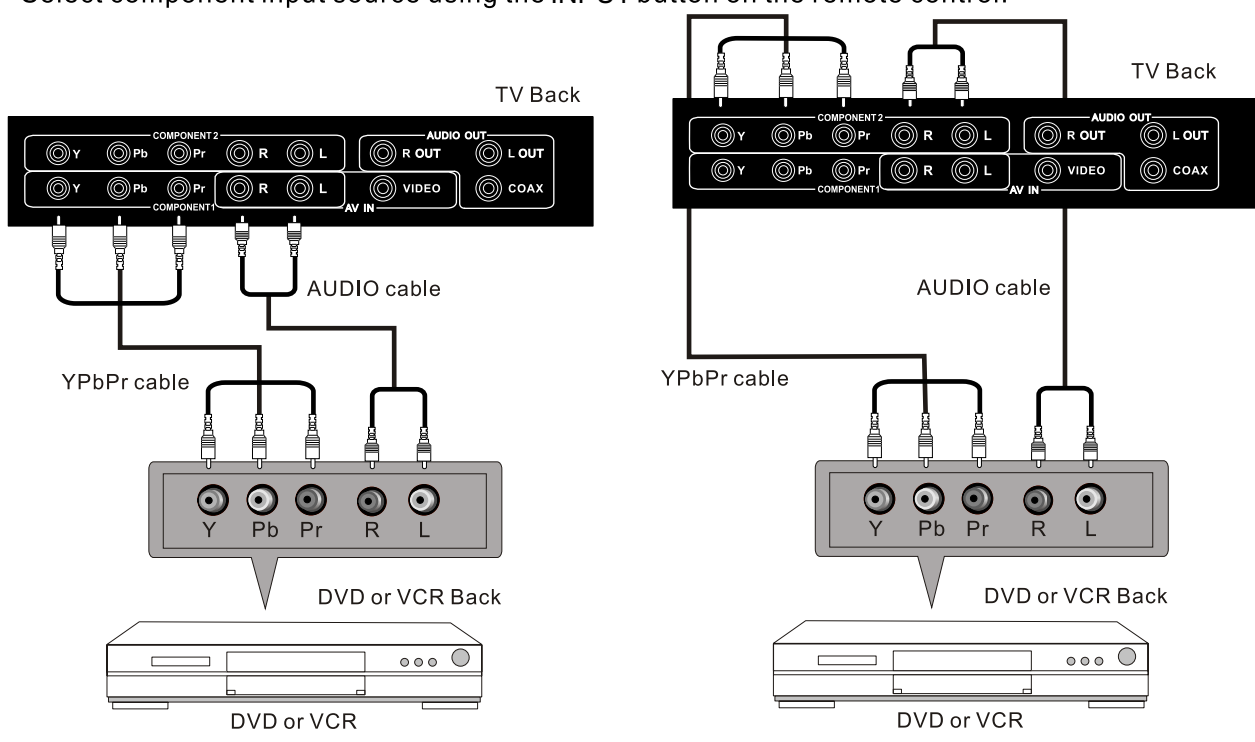

VGA(PC) Connection

Connect the RGB output of a PC to the VGA(PC) jack on the TV. Connect the AUDIO output of a PC to the PC AUDIO jack on the TV. Select the PC input source with the INPUT button on the remote control.

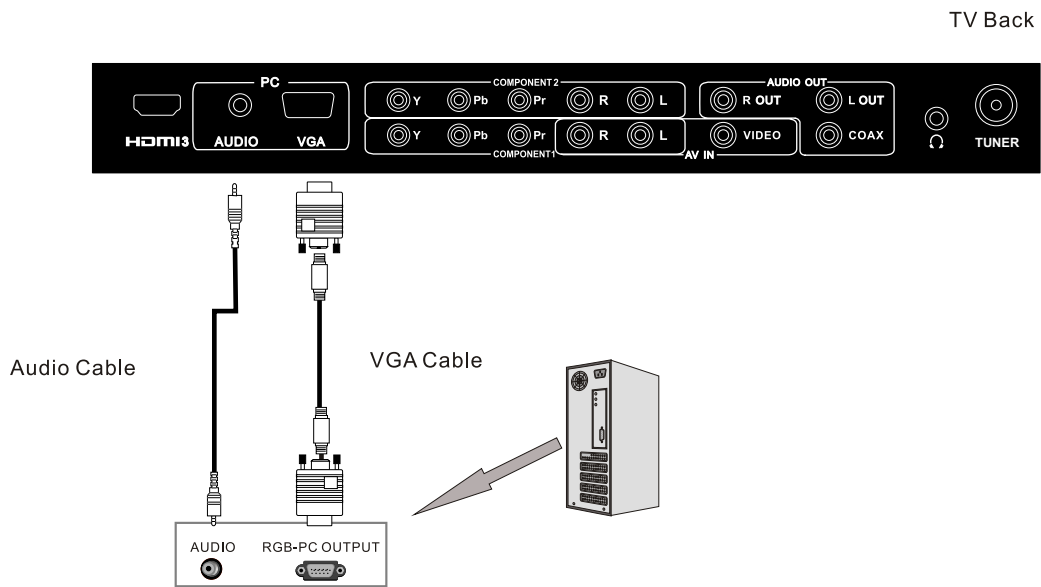

COAX Connection

Connect to Audio Amplifier device to the COAX output jack on the TV.

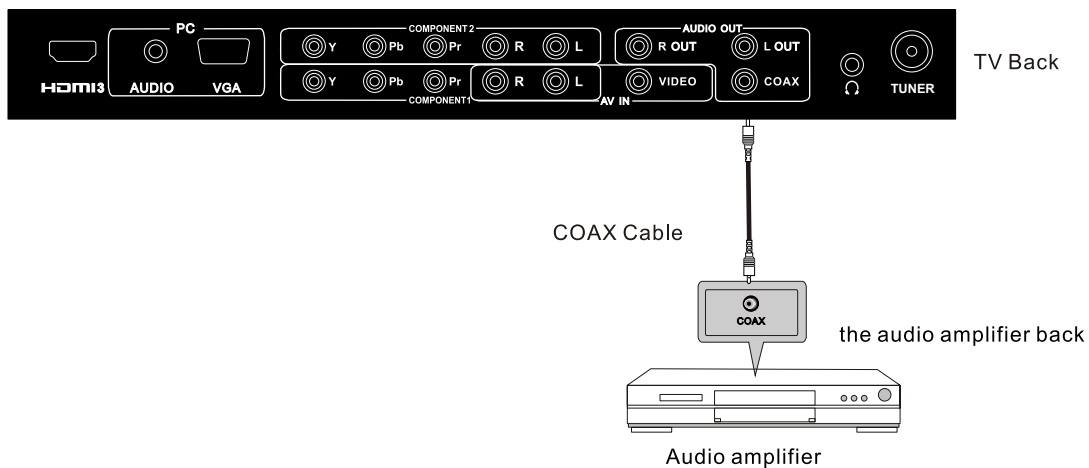

INSTALLATION

HDMI Connection

HDMI plug which replaces the HDMI connection allows transfer of all audio/video/control signals through one cable only. These signals are transferred in digital.

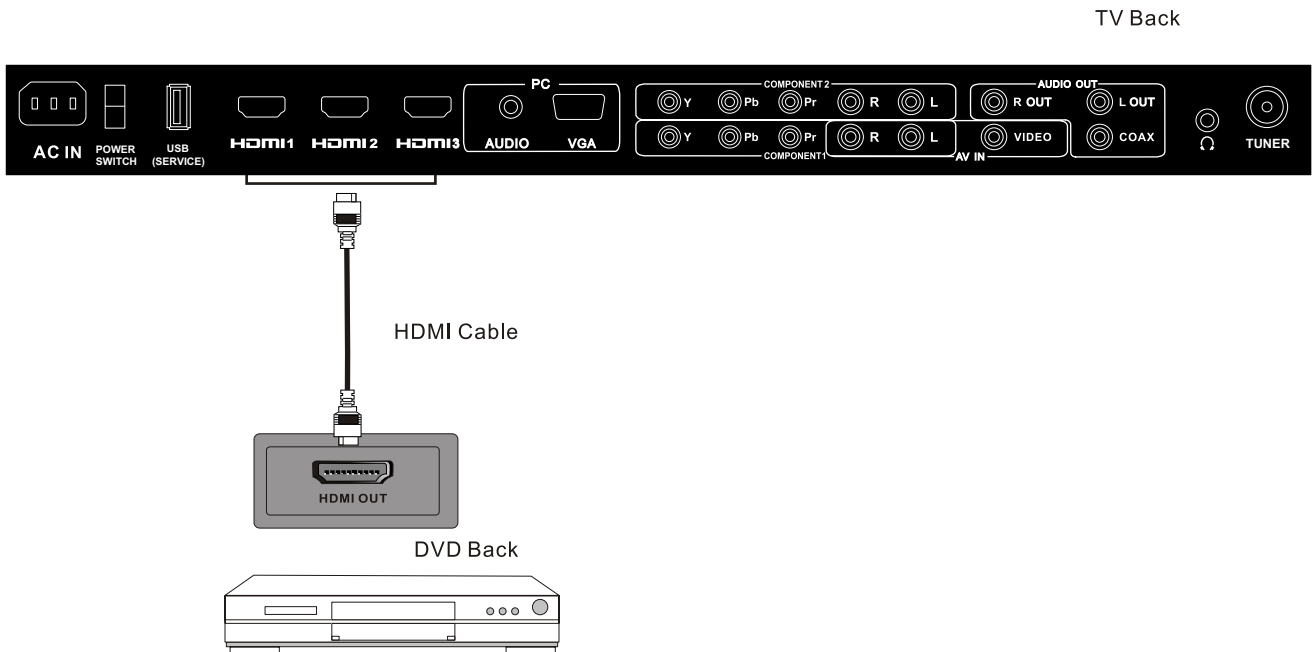

Service Port Function

Service port: (For factory use only)



8. REMOTE CONTROL

Remote control instructions in TV mode



POWER

Turn the LCD TV ON or OFF.

INPUT

Press INPUT to display the OSD input source, press ▲ ▼ to select an input source, and then press OK to confirm.

NUMBER BUTTONS

Press 0-9 to directly change the TV channel.

-

Press this button to enter a program number for multiple program channel such as 2-1, etc.



Return to the previous channel viewed.

PICTURE

Select the picture mode

SOUND

Select the sound mode

SLEEP

Set the Sleep Timer.

DISPLAY

Displays the source and channel information.

MENU

Displays the main TV menu.

EXIT

Exit the main TV menu.

MUTE

Press to mute the sound. Press again or press VOL+ to un-mute the TV.

VOL+/VOL-

Press to increase / decrease the sound level.

CH+/CH-

Press to scan through channels.

THUMBSTICK(▲ / ▼ / ◀ / ▶ / OK)

Allows you to navigate the on-screen menus and adjust the system settings to your preference.

CC

Press to set the closed caption.

MTS

Press to adjust between available audio channel.

ASPECT

Press to select Aspect Ratio.

FAV

Press to display the TV favourite program list.

Remote control setup

1. Open the cover.
2. Uses AAA size batteries. When inserting the batteries, make sure correct polarities "+" and "-" marks on the batteries line up correctly with compartment markings.
3. Replace the battery cover.

To prevent battery leakage which may result in bodily injury or damage to the remote:

1. Install all batteries correctly, and as marked on the remote control.
2. Do not mix batteries: (OLD and NEW or CARBON and ALKALINE, etc)
Remove batteries when the remote is not used for a long period of time.



9. MENU OPERATION

SETUP WIZARD

Select Language



Time zone

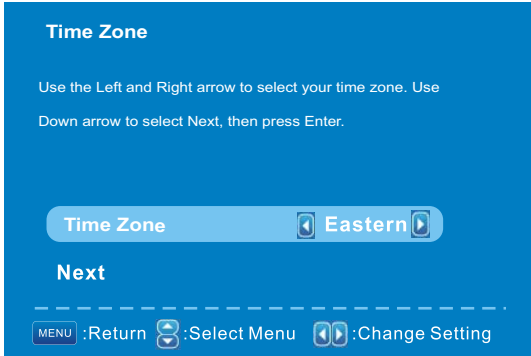

Setup Wizard

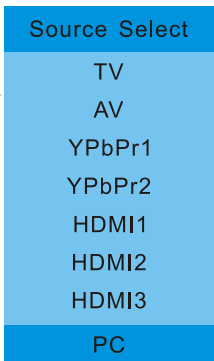
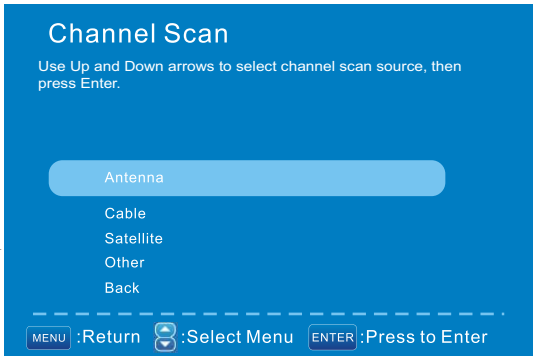
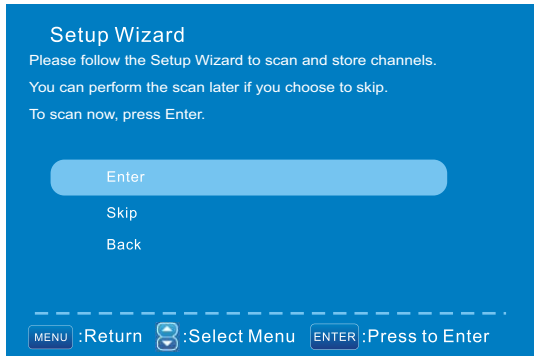

English

Channel Scan

English

Channel Scan
Use Up and Down arrows to select channel scan source, then press Enter.

- Antenna
- Cable
- Satellite
- Other
- Back

MENU :Return :Select Menu ENTER :Press to Enter

Antenna

**Cable/
Satellite**

AUTO CHANNEL SEARCH - Air
Now Searching... Please Wait

Return

Analog Channels Found: 0
Digital Channels Found: 0

0%

Cable or Satellite Select
Are you Using a Cable/Satellite Box to connect your TV?
Use Up and Down arrows to make selection, then press Enter.

- Yes
- No
- Skip
- Back

MENU :Return :Select Menu ENTER :Press to Enter

Scan Stopped
You have stopped the channel scan before it could be complete, Do you wish to adjust your RF Input source and repeat the scan, or watch TV with the channels that have been found!

- Repeat
- Watch TV

:Select Menu ENTER :Press to Enter

Cable or Satellite Box Input
Use the Left and Right arrows to select the input source of your cable/satellite box. Use Down arrow to select Next, then press Enter.

Source Select TV

- Skip
- Next
- Back

MENU :Return :Select Menu :Change Setting

No Channels Found
The Setup Wizard didn't find any channels. Check your antenna or cable connections, You may select an improper RF Input Source, Check you setup and try again.

- Repeat
- Skip

:Select Menu ENTER :Press to Enter

RF Warning
RF (TV Tuner input) is not recommended due to its poor quality analog signal. Use Down arrow to select Back and choose a higher quality input source. If you do not have a high definition output, contact your cable/satellite provider for additional information. Or, press Enter to proceed.

- Proceed
- Skip
- Back

MENU :Return :Select Menu ENTER :Press to Enter

SELECT INPUT SOURCE



- Press **INPUT** button to display the input source list.
- Press **▼/▲** button to select the input source you want to watch.
- Press **OK** button to enter the selected source.

BASIC OPERATION

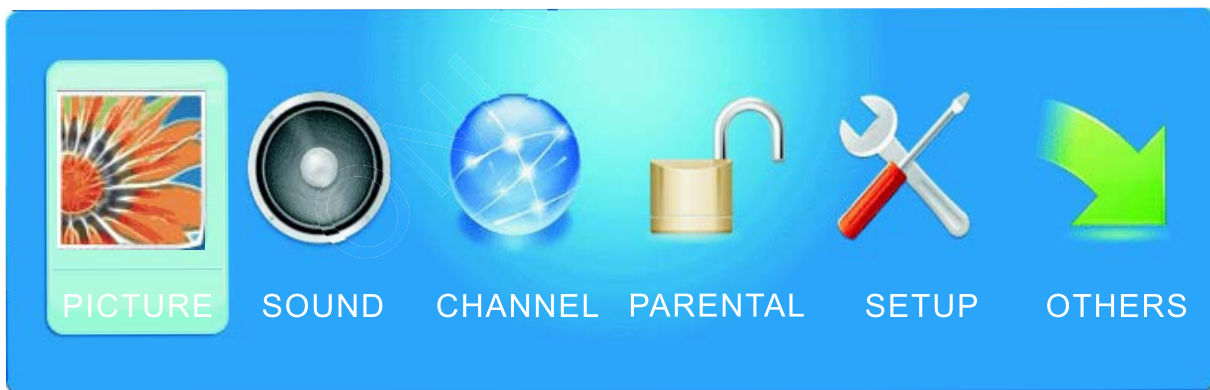

- Press **MENU** button to display the MAIN OSD MENU.
- Press **◀/▶** button to select the MENU you want.
- Press **OK** button to enter the sub menu.
- Press **▼/▲** button to select the option and then press **◀/▶** to adjust the value in the sub menu.
- You can press **MENU** button to go back to the upper menu or **EXIT** button to close the OSD.

For TV Mode:

PICTURE MENU

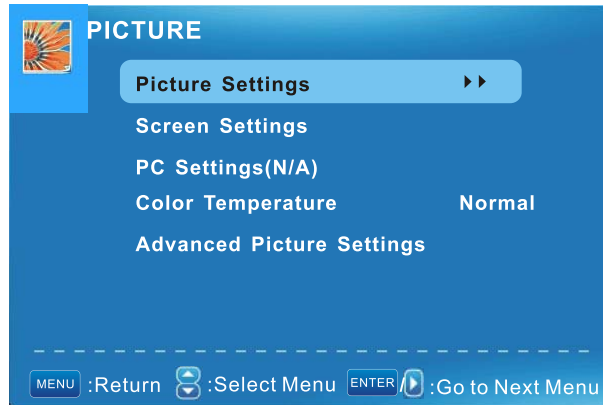

Picture Settings

1. Press **OK** when the Picture Settings item is highlighted. Then you will go to the sub-menu as following.
2. Press **▼/▲** to select the desired menu item. Press **ENTER** to proceed if necessary.
3. Press **◀/▶** to the desired level.
4. When you have changed the settings, you can exit from the menu by pressing **MENU**.

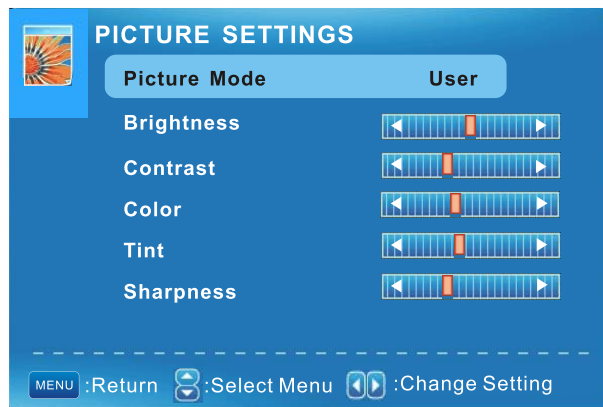

Picture Mode

Press **▼/▲** button to select Picture Mode, then press **◀/▶** button to adjust. Only in the User mode, the detail options as following can be adjusted. Available picture mode: User, Dynamic, Standard, Movie .

Brightness

Press **▼/▲** button to select Brightness, then press **◀/▶** button to adjust.



Contrast

Press **▼/▲** button to select Contrast, then press **◀/▶** button to adjust.



Color

Press ▼/▲ button to select Color, then press ◀/▶ button to adjust.

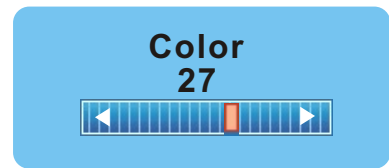

Sharpness

Press ▼/▲ button to select Sharpness, then press ◀/▶ button to adjust.

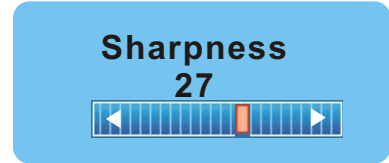

Tint

Press ▼/▲ button to select Tint, then press ◀/▶ button to adjust.

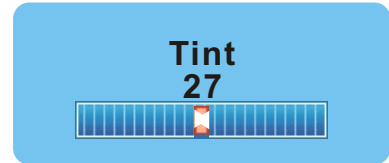

Screen Settings

1. Press ENTER when the Screen Settings item is highlighted. Then you will go to the sub-menu as following.
2. Press to select the desired menu item. Press ENTER to proceed if necessary ▼/▲.
3. Press ◀/▶ to adjust the item to the desired level.
4. When you have changed the settings, you can exit from the menu by pressing MENU.

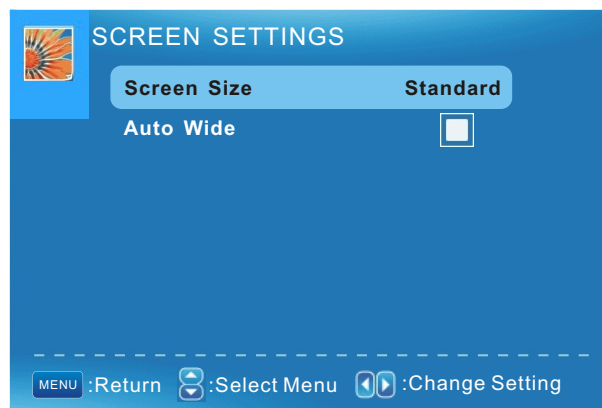

Screen Size

Press ▼/▲ button to select Screen Size, then press ◀/▶ button to adjust. Available Screen Size: Standard, Fill, Over, Scan.

Auto Wide

Press ▼/▲ button to select the item Auto Wide, then press ENTER button to adjust. It can set the picture to fit the screen automatically. When the Auto Wide is selected, the symbol will show as:

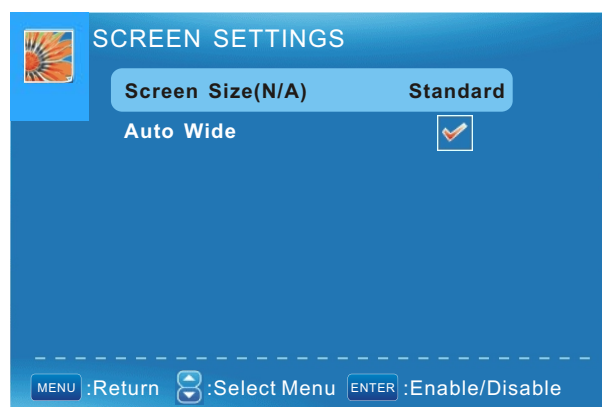

Color Temperature

Press ENTER when the Color Temperature item is highlighted. Then press ◀/▶ button to adjust. Available color temperature: Cool, Normal, Warm.

Color Temperature
Warm

Advanced Picture Settings

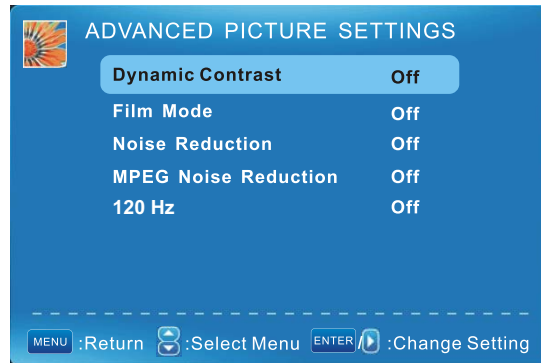

Dynamic Contrast

Press ▼/▲ button to select the ◀/▶ button to adjust. It can adjust the contrast corresponding to the input signal in order to improve the picture quality displayed. Available Mode: On/Off.

Dynamic Contrast
Off

Film Mode

Press ▼/▲ button to select the item Film Mode, then press ◀/▶ button to adjust. It handles 3:2 pull down and 2:2 pull down. Available Film Mode: On/Off.

Film Mode
Off

Noise Reduction

Press ▼/▲ button to select the item Noise Reduction, then press ◀/▶ button to adjust. Available Noise Reduction: Off, Low, Medium, High.

Noise Reduction
Off

MPEG Noise Reduction

Press ▼/▲ button to select the item MPEG Noise Reduction, then press ◀/▶ button to adjust. It can improve the quality of the pictures by reducing the block noise. Available MPEG Noise Reduction: Off, Low, Medium, High.

MPEG Noise Reduction
Off

120 Hz

Press ▼/▲ button to select the item 120 Hz, then press ◀/▶ button to adjust. Available 120 Hz: Off, Low, High.

120 Hz
Off

SOUND MENU

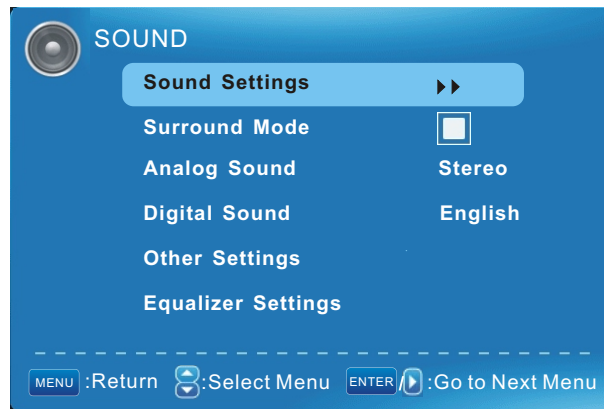

Sound Settings

1. Press ENTER when the Sound Settings item is highlighted. Then you will go to the sub-menu as following.
2. Press ▼/▲ to select the desired menu item. Press ENTER to proceed if necessary.
3. Press ◀/▶ to the desired level.
4. When you have changed the settings, you can exit from the menu by pressing MENU.

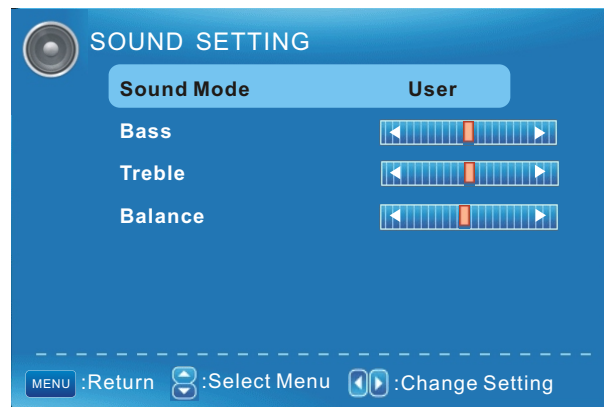

Sound Mode

Press ▼/▲ button to select the item Sound Mode, then press ◀/▶ button to adjust. Only in the User mode, the detail options as following can be adjusted. Available Sound Mode: User, Dynamic, Standard, Soft.

Bass

Press ▼/▲ button to select the item Bass, then press ◀/▶ button to adjust.

Treble

Press ▼/▲ button to select the item Treble, then press ◀/▶ button to adjust.

Balance

Press ▼/▲ button to select the item Balance, then press ◀/▶ button to adjust.

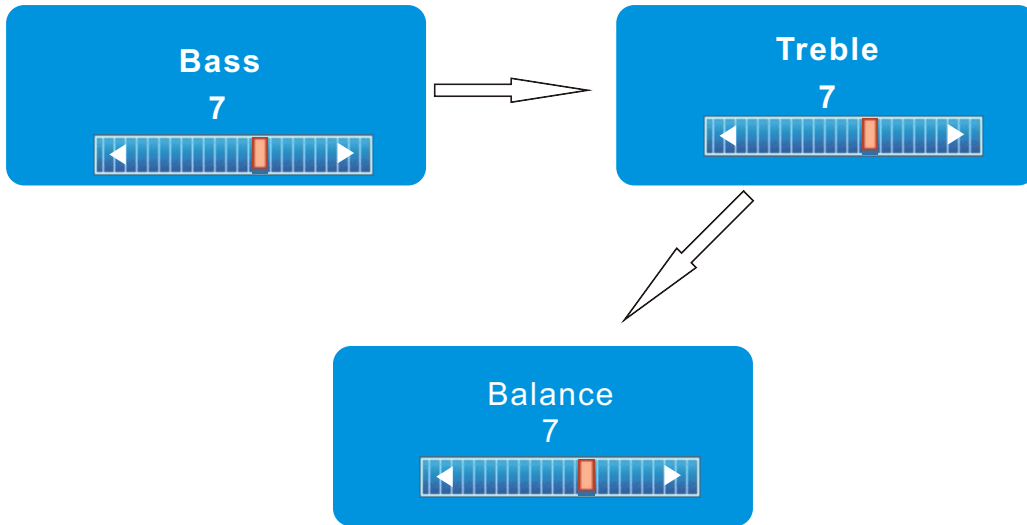

Surround Mode

Press ▼/▲ button to select the item Surround Mode, then press OK button to adjust. It can set the picture to fit the screen automatically. When the Auto Wide is selected, the symbol will show as following:



Analog Sound

Press ▼/▲ button to select the item Preferred Analog Sound, then press ◀/▶ button to select the prefer audio when switching to an analog channel. Available Analog Sound: Stereo, Mono, SAP.

Digital Sound

Press ▼/▲ button to select the item Preferred Digital Sound, then press ◀/▶ button to select the prefer audio when switching to a digital channel. Available Digital Sound: English, French, Spanish.

Other Settings

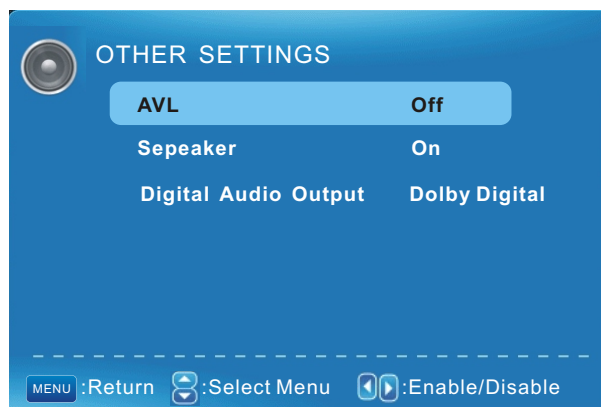

AVL

Press ▼/▲ button to select the item AVL, then press ◀/▶ button to select ON or OFF. Auto Volume Level can set the volume automatically adjust corresponding to the input audio.

Speaker

Press ▼/▲ button to select the item Speaker, then press ◀/▶ button to select ON or OFF. If set to Off, the speaker will be mute.

Digital Audio Output

Press ▼/▲ button to select the item Digital Audio Output, then press ◀/▶ button to select the desired digital audio output. Available digital audio output: Dolby Digital, Off, PCM.

Equalizer Settings

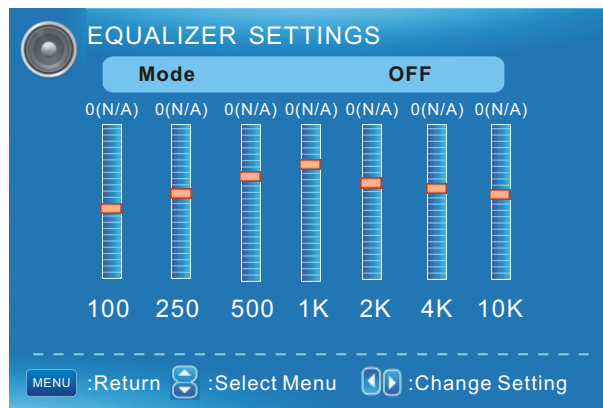

Equalizer Mode

Press ▼/▲ button to select the item Equalizer Mode, then press ◀/▶ button to select the desired mode. Available Equalizer Mode: OFF, ROCK, POP, JAZZ, User.

CHANNEL MENU

Note: This menu is only shown when the input source is TV.



Channel List

Press ▼/▲ button to select Channel List, then press OK button to scan the Channel List. If you select the option “In Channel List” On, the channel label will display in the list.



Favorite List

Press ▼/▲ button to select Favorite List, then press OK button to scan the Favorite Channel List.



Channel Setting

Press ▼/▲ button to select Manual Channel Setting, then press OK button to set the value in the sub menu.

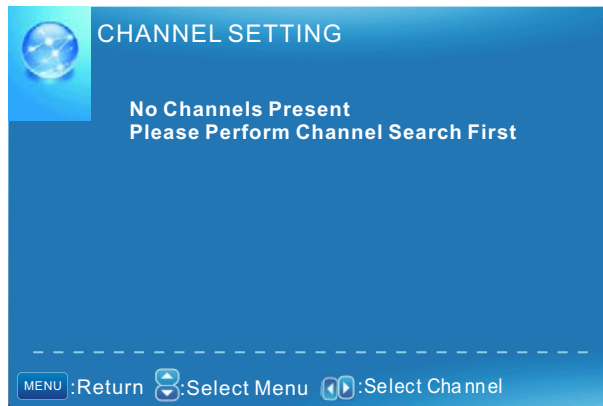

Signal Type

Press ▼/▲ button to select Signal Type, then press ◀/▶ button to select the type you want to set. There are two selections: Air and Cable.

Auto Channel Search

Press ▼/▲ button to select Auto Channel Search, then press OK button to search channel. A Channel Search Menu will appear as below.



PARENTAL CONTROL

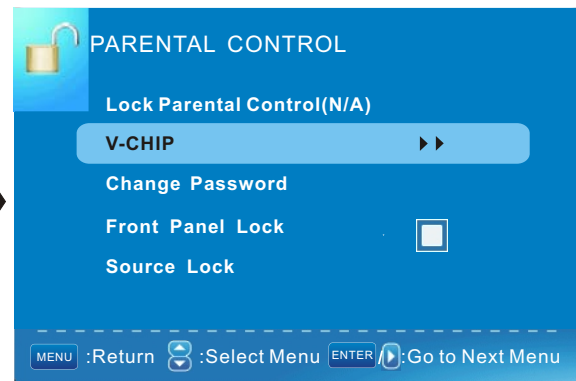

Input password to enter, default password is "0000".

V-CHIP

Press ▼/▲ button to select V-CHIP, then press OK button to adjust. A sub menu will appear as below.



US V-CHIP

Press ▼/▲ button to select US V-CHIP, then press OK button to adjust. A sub menu will appear as below.



Movie Rating

Press ▼/▲ button to select Movie Rating, then press OK button to adjust. A sub menu will appear as below.

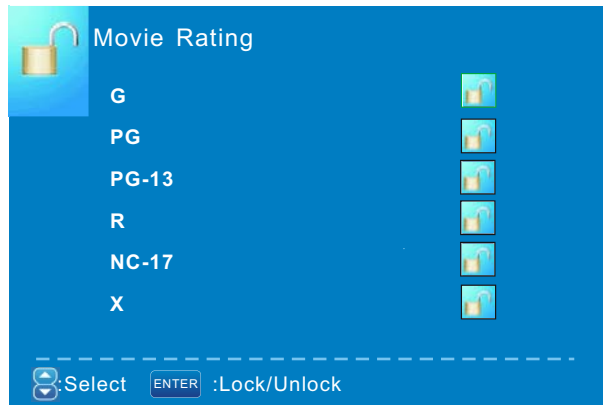

Press ▼/▲ button to select Rating, then press OK button to lock.

TV Rating

Press ▼/▲ button to select TV Rating, then press OK button to adjust. A sub menu will appear as below.

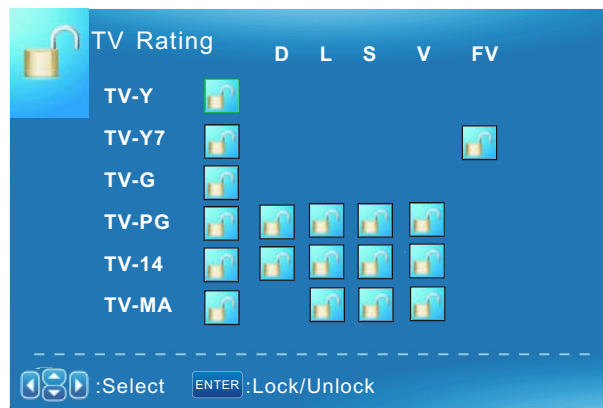

Press ▼/▲/◀/▶ button to select Rating, then press OK button to lock.

CANADA V-CHIP

Press ▼/▲ button to select US V-CHIP, then press OK button to adjust. A sub menu will appear as below.

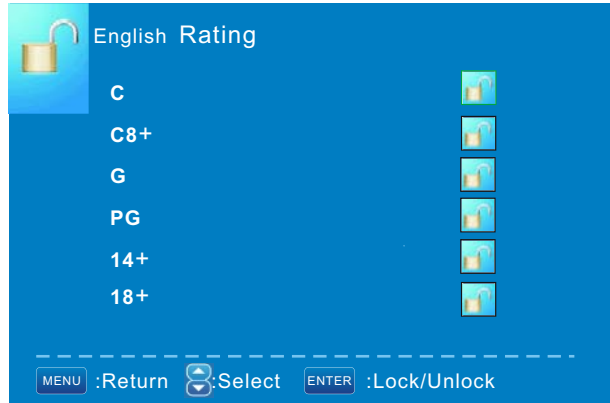

English

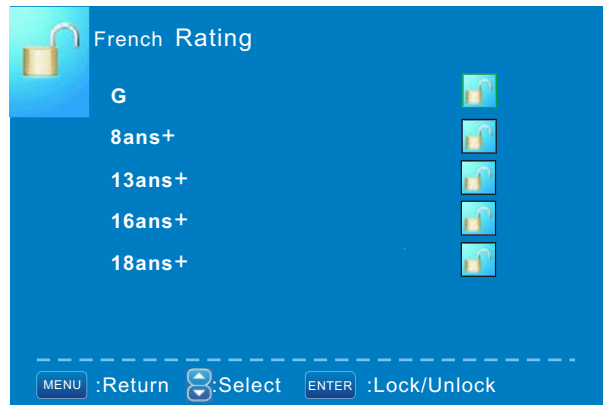

The operation of CANADA V-CHIP is the same as the operation of US V-CHIP.

Block UnRated Show

Press ◀ / ▶ button to select Block UnRated Show, then press OK button to set the rating locked.

Downloadable Rating

Press ▼ / ▲ button to select Downloadable Rating, then press OK button to set the rating. If the DTV program doesn't have this rating information, this option will be in gray.

Clear Downloadable Date

Press ▼ / ▲ button to select Clear Downloadable Data, then press OK button to set the rating. Note: The above two operation only valid when playing the downloadable data stream. The operations are the same as US V-CHIP.

CHANGE PASSWORD

Press ▼ / ▲ button to select Change Password, then press OK button to adjust the value. A Sub Menu Will appear as below. If the password is changed, all of the passwords in the menu will be changed at the same time.

MENU OPERATION

Note: If you forget your password, you can use "1470" to enter any menu locked.

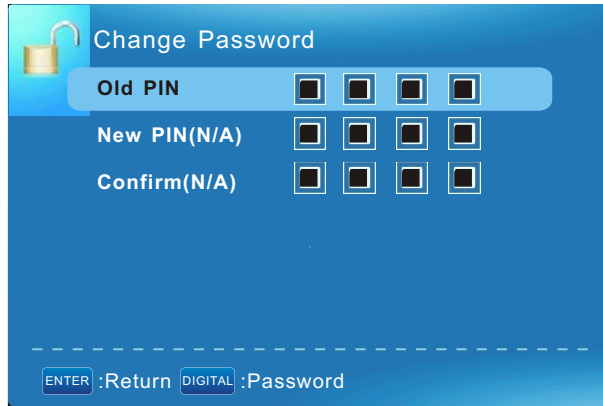

Source Lock

Press ▼/▲ button to select Source Lock, then press OK button to enter the sub menu.
Press ▼/▲ button to select Source, then press OK button to set the Source Lock .
You can't enter the locked source if you set the Source lock.



Setup Menu



Closed Caption

Press ▼/▲ button to select the item Closed Caption, then press ◀/▶ button to adjust.

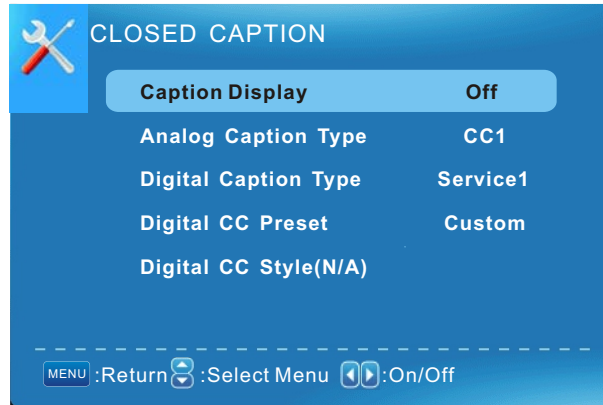

Caption Display

Press ▼/▲ button to select Caption Display, then press ◀/▶ button to select ON or OFF.

Analog Caption Type

Press ▼/▲ button to select Analog Caption Type, then press ◀/▶ button to select the type. Available type: CC1, CC2, CC3, CC4, TEXT1, TEXT2, TEXT3, TEXT4.

Digital Caption Type

Press ▼/▲ button to select Digital Caption Type, then press ◀/▶ button to select the type. Available type: Service1~6.

Digital CC Preset

Press ▼/▲ button to select Digital CC Preset, then press ◀/▶ button to select Default or Custom.

Digital CC Style

This menu is only shown when the Digital CC Preset is selected Custom.

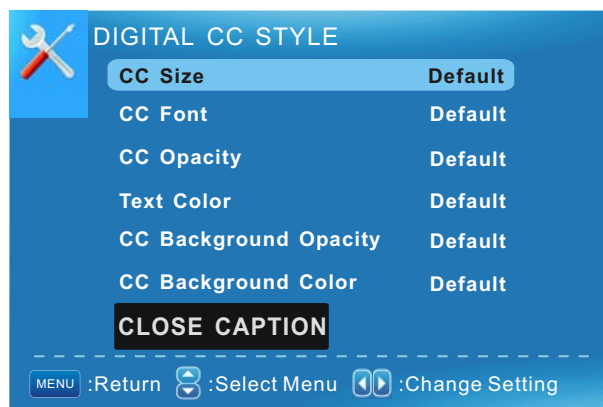

MENU OPERATION

CC Size

Press ▼/▲ button to select CC Size, then press ◀/▶ button to set. Available Size: Default, Small, Standard, Large.

CC Font

Press ▼/▲ button to select , then press ◀/▶ button to select the Font. Available type: Default, Style0~7.

CC Opacity

Press ▼/▲ button to select CC Opacity, then press ◀/▶ button to select the Opacity. Available Opacity: Default, Solid, Flashing, Translucent, Transparent.

Text Color

Press ▼/▲ button to select Text Color, then press ◀/▶ button to select the color. Available Color: Default, Black, White, Red, Green, Blue, Yellow, Magenta, Cyan.

CC Background Opacity

Press ▼/▲ button to select CC Background Opacity, then press ◀/▶ button to select the Opacity. Available Opacity: Default, Solid, Flashing, Translucent, Transparent.

CC Background Color

Press ▼/▲ button to select CC Background Color, then press ◀/▶ button to select the Color. Available Color: Default, Black, White, Red, Green, Blue, Yellow, Magenta, Cyan.

Menu Language

Press ▼/▲ button to select the item Menu Language, then press ◀/▶ button to adjust. Available Language: English, French, Spanish.

Clock

Press ▼/▲ button to select the Clock, then press OK to edit.



Time Zone

Press ▼/▲ button to select Timer Zone, then press ◀/▶ button to set. Available Size: Central, Mountain, Pacific, Alaska, Hawaii, Samoa, Newfoundland, Atlantic, Eastern.

Auto Clock

Press ▼/▲ button to select Auto Clock, then press ◀/▶ button to set it On or Off. If you set it On, it will adjust the time corresponding the DTV time automatically.

Setup Time

Press ▼/▲ button to select Setup Time, then press ◀/▶ button to adjust the time and use the ENTER button to go to the next option.

Day Of Week

This option displays the Day Of Week corresponding to the setup time.

OTHERS MENU



Blue Back

Press ▼/▲ button to select Blue Background, then press OK button to select, so when there is no signal, the background is blue.

No Signal Power Off

Press ▼/▲ button to select No Signal Power Off, then press OK button to select it On or Off.

When set it On and there is no signal input for 10 minutes, it will turn off the TV and the LED light turns red.

No Operation Power Off

Press ▼/▲ button to select No Operation Power Off, then press OK button to select it On or Off.

When set On and there is no operation input by 3 hours, it will turns off the panel and the LED light turns red.

All Reset

Press ▼/▲ button to select All Reset. Enter the Reset password "0000", then press OK button to execute reset. When you select All Reset item, a dialogue box will appear as following:

Attention!
If you want to reset the TV
please Enter password to execute.

For AV/YPbPr1/YPbPr2/HDMI1/HDMI2/HDMI3 Modes:

1. PICTURE menu and description are the same as that for TV source.
2. SOUND menu and description are the same as that for TV.
But the settings for Analog Sound and Digital Sound are invalid in these sources.
3. PARENTAL menu and description are the same as that for TV source.
4. SETUP menu and description are the same as that for TV source.
But the setting for Closed Caption is invalid in HDMI source.
5. OTHER menu and description are the same as that for TV source.
6. CHANNEL menu and description are invalid in these sources .

PICTURE MENU

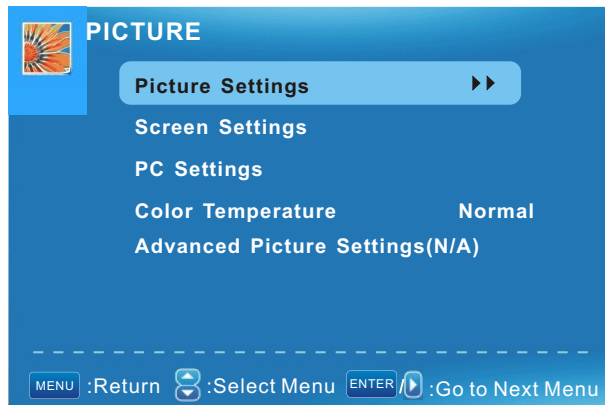

Picture Settings

1. Press ENTER when the Picture Settings item is highlighted. Then you will go to the sub-menu as following.
2. Press ▼/▲ to select the desired menu item. Press ENTER to proceed if necessary.
3. Press ◀/▶ to adjust the item to the desired level.
4. When you have changed the settings, you can exit from the menu by pressing MENU.

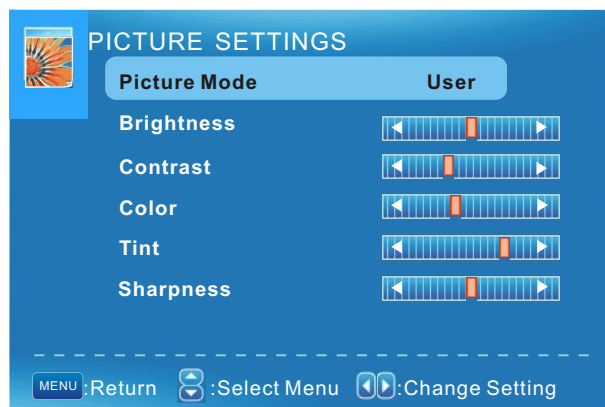

Picture Mode

Press ▼/▲ button to select Picture Mode, then press ◀/▶ button to adjust.
 Available picture mode: Movie, User, Dynamic, Standard.

Brightness

Press ▼/▲ button to select Brightness, then press ◀/▶ button to adjust.

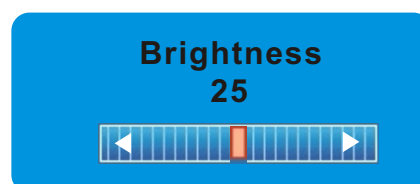

Contrast

Press ▼/▲ button to select Contrast, then press ◀/▶ button to adjust.

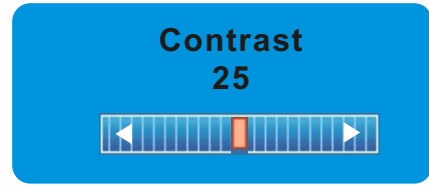

Color

Press ▼/▲ button to select Color, then press ◀/▶ button to adjust.

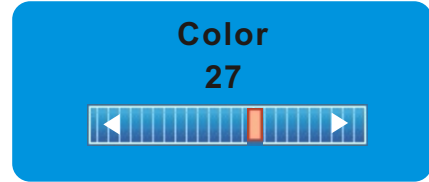

Sharpness

Press ▼/▲ button to select Sharpness, then press ◀/▶ button to adjust.

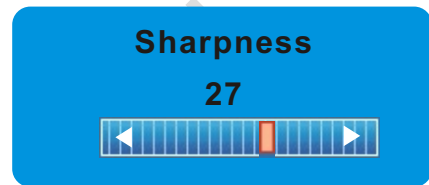

Tint

This option can not be adjusted.

Screen Settings

1. Press ENTER when the Screen Settings item is highlighted. Then you will go to the sub-menu as following.
2. Press ▼/▲ to select the desired menu item. Press ENTER to proceed if necessary.
3. Press ◀/▶ to adjust the item to the desired level.
4. When you have changed the settings, you can exit from the menu by pressing MENU.

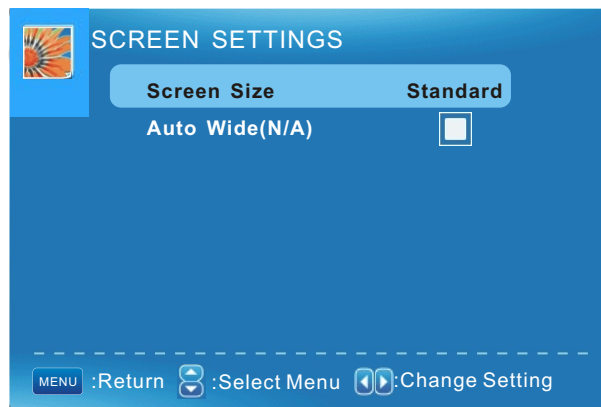

Screen Size

Press ▼/▲ button to select Screen Size, then press ◀/▶ button to adjust. Available Screen Size: Standard.

Auto Wide

Auto Wide item is invalid in PC source.

PC Setting

1. Press ENTER when the PC Settings item is highlighted. Then you will go the sub-menu as following.
2. Press ▼/▲ to select the desired menu item. Press ENTER to proceed if necessary .
3. Press ◀/▶ to adjust the item to the desired level.
4. When you have changed the settings, you can exit from the menu by pressing MENU.

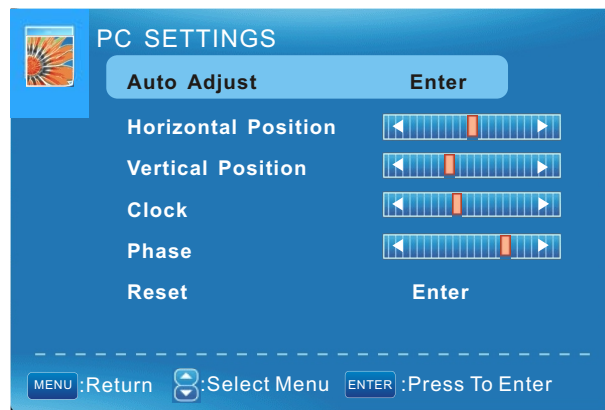

Auto Adjust

Press ▼/▲ button to select Auto Adjust, then press OK button to start auto adjusting.

Horizontal Position

Press ▼/▲ button to select Horizontal Position, then press ◀/▶ button to adjust.

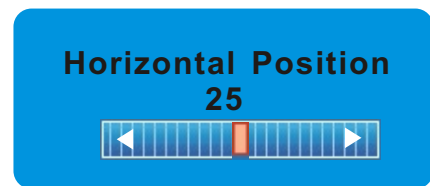

Vertical Position

Press ▼/▲ button to select Vertical Position, then press ◀/▶ button to adjust.

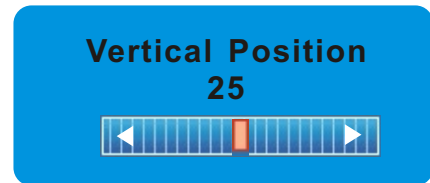

Clock

Press ▼/▲ button to select Clock, then press ◀/▶ button to adjust.

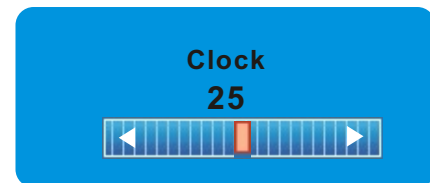

Phase

Press ▼/▲ button to select Phase, then press ◀/▶ button to adjust.

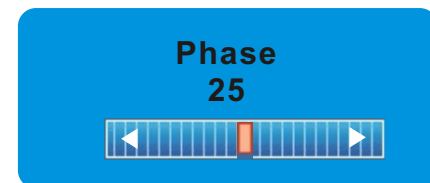

Reset

Press ▼/▲ button to select Reset, then press OK button to reset the options above.

- 1. SOUND menu and description are the same as that for TV. but the settings for Analog Sound and Digital Sound are invalid in PC source.
- 2. PARENTAL menu and descriptions are the same as that for TV source.
- 3. SETUP menu and description are the same as that for TV source. But the setting for Closed Caption is invalid in PC source.
- 4. OTHER menu and description are the same as that for TV source.
- 5. CHANNEL menu and description are invalid in PC source.

Note: The operation and description of the hot key is programmable on your remote control.

10. Troubleshooting

Please check if you can solve problems by troubleshooting yourself.

Troubleshooting	Control
No signal	Please check that all cables are correctly plugged in.
No color shades	Adjust the contrast, the color and the brightness.
Stain on the screen	May be the result from a lighting signal from car, motor, neon light and other electrical devices or appliances.
Double or multiple display image	May be the result of an electrical wave disturb from other TV, Computer and Game machine or Radio.
Snow on the screen	The cables of the antenna are not correctly plugged in.
The remote control does not work	Please check the batteries order and alignment. Check that the IR of the remote control is not hidden by something.
"Zip" made noise on TV cover	Even if the display image is correct, the noise may come from an unsteady fixation of the panel.
No sound	Make sure that you have not press the MUTE button of the panel or of the remote control.

11. SPECIFICATIONS

This manual is only for your reference, any change to the design and specification will not be advised.

Screen Size		55 Inch
Display Type		TFT LCD
Resolution(Pixel)		1920 X 1080
Aspect Ratio		16:9
Power Supply		AC100-240V~ 50/60Hz
Power Consumption		260W
TV System		ATSC/NTSC
Video Input Format		PAL/NTSC
Audio Output Power		L / R 2X8W
SUPPORT	TUNER	YES
	AV-IN	YES
	YPbPr - IN	YES
	HDMI - IN	YES
	VGA(PC) - IN	YES
	VGA(PC) AUDIO - IN	YES
	SCART - IN	--
	SCART - OUT	--
	EARPHONE - OUT	YES
	S-VIDEO - IN	--
	COAXIAL - OUT	YES
	COMMON INTERFACE	--
	USB	Service Port Only
	IPOD	--
DVD	Disc Physical Format	--
	DVD Video Output Format	--
Dimensions	w / Stand (LxWxH-mm)	1321 x 330 x 875 mm
	w / o Stand (LxWxH-mm)	1321 x 120 x 807 mm
Weight	Net (Kgs)	36.4
	Gross (Kgs)	43.9



www.westinghousedigital.com

Free Manuals Download Website

<http://myh66.com>

<http://usermanuals.us>

<http://www.somanuals.com>

<http://www.4manuals.cc>

<http://www.manual-lib.com>

<http://www.404manual.com>

<http://www.luxmanual.com>

<http://aubethermostatmanual.com>

Golf course search by state

<http://golfingnear.com>

Email search by domain

<http://emailbydomain.com>

Auto manuals search

<http://auto.somanuals.com>

TV manuals search

<http://tv.somanuals.com>