

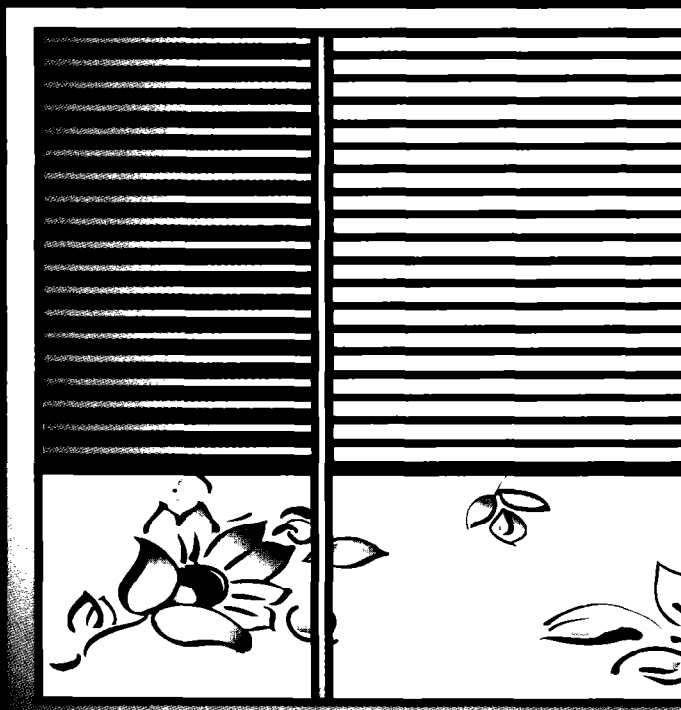

Owner's

M A N U A L

C O O L I M P R E S S I O N



A Note to You	2
Important Safety Instructions	3
Parts and Features	4
Operating Your Air Conditioner	6
Personalizing the Front Panel	13
Caring for Your Air Conditioner	14
Installing Your Air Conditioner	16
Troubleshooting	20
Obtaining Service	20

ROOM AIR CONDITIONERS

6/95

N/T
1180867

A Note to You

Thank you for buying a WHIRLPOOL* appliance.

You have purchased a quality, *world-class* home appliance. Years of engineering experience went into its manufacture. To ensure you operate and care for your appliance properly, we have developed this Owner's Manual. It is full of valuable information on how to operate and maintain your appliance properly and safely. Please read it carefully.

Your safety is important to us.

This guide contains safety symbols and statements. Please pay special attention to these symbols and follow any instructions given. Here is a brief explanation of the use of each symbol.

WARNING

This symbol alerts you to such dangers as fire, electrical shock, burns, and personal injury.

 **15 A** This symbol represents the rated current of appropriate fuse-link in amperes.

 This symbol represents the EARTHING TERMINAL.

Please complete this section.

If you ever have a question concerning this appliance, or if you need service, first see "Obtaining Service" on page 20. If service is required, you will need to know your appliance's complete model and serial number. You can find this information on the model and serial number label (see diagram on page 4). For your convenience, we included a place below for you to record these numbers, the purchase date from the sales slip, and your dealer's name and telephone number. Keep this book and the sales slip together in a safe place for future reference.

Model Number _____

Dealer Name _____

Serial Number _____

Dealer Address _____

Purchase Date _____

Dealer Phone _____

Important Safety Instructions

⚠ WARNING

To reduce the risk of fire, electrical shock, or personal injury when using your air conditioner, follow these basic safety precautions:

- Read all instructions before using your air conditioner.
 - Complete the installation requirements as described in "Installing Your Air Conditioner" on pages 16-19.
 - Do not allow children to operate or play with the air conditioner.
 - Do not operate the air conditioner with the front panel removed.
 - Never clean air conditioner parts with flammable fluids. The fumes can create a fire hazard or explosion.
- FOR YOUR SAFETY •
- DO NOT STORE OR USE GASOLINE OR OTHER FLAMMABLE VAPOURS AND LIQUIDS IN THE VICINITY OF THIS OR ANY OTHER APPLIANCE. THE FUMES CAN CREATE A FIRE HAZARD OR EXPLOSION.

– SAVE THESE INSTRUCTIONS –

Consumer responsibilities

Please:

- The steps on pages 16-19 must be performed by a qualified installer.
- Be sure the air conditioner is the correct voltage and size for the area you want to cool/heat.
- Be sure the air conditioner is installed in accordance with all national electrical codes and wiring regulations.
- Use the air conditioner only for the uses described in this manual.
- Be sure the air conditioner is not used by anyone unable to operate it properly.
- Maintain the air conditioner properly.
- If power cord is damaged, be sure it is replaced or repaired by an authorized service technician.

Also, please DO NOT use sharp instruments, flammable fluids, or abrasive cleaners. These can damage the surface of the air conditioner.

Parts and Features

This section contains captioned illustrations of your air conditioner. Please use them to become familiar with where the parts and features are located and what they look like.

Air conditioner

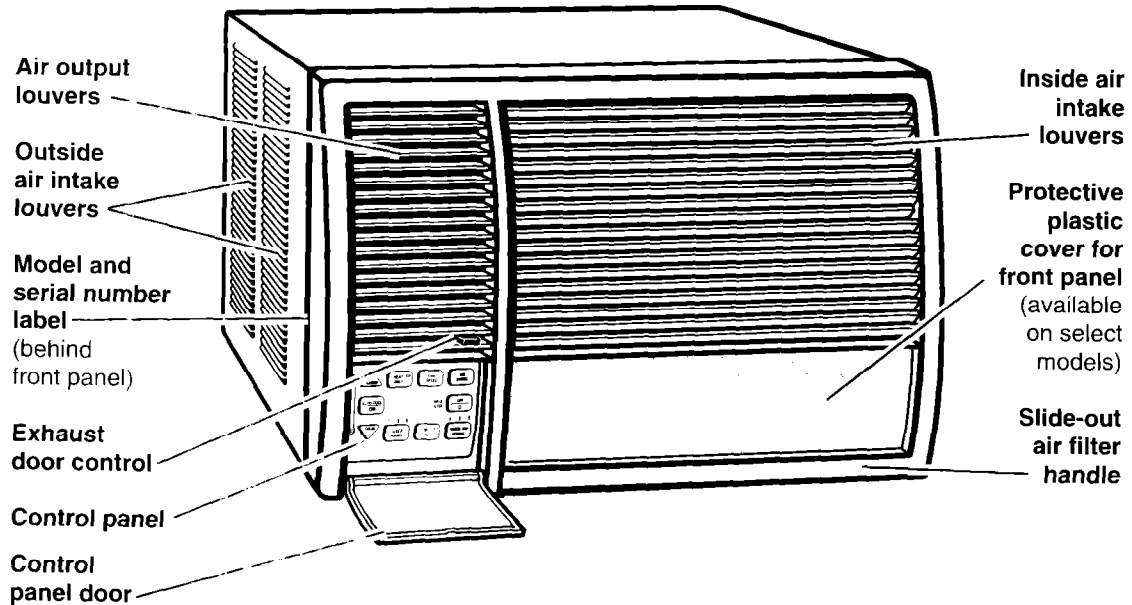

Control panel on unit

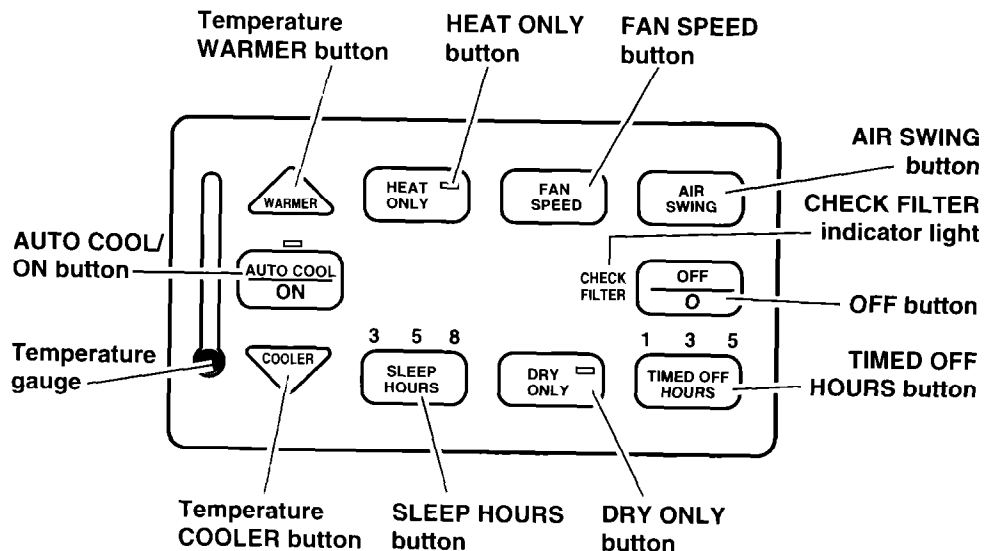

Deluxe remote control (included with select models)

This remote control is also available as an accessory on some models.

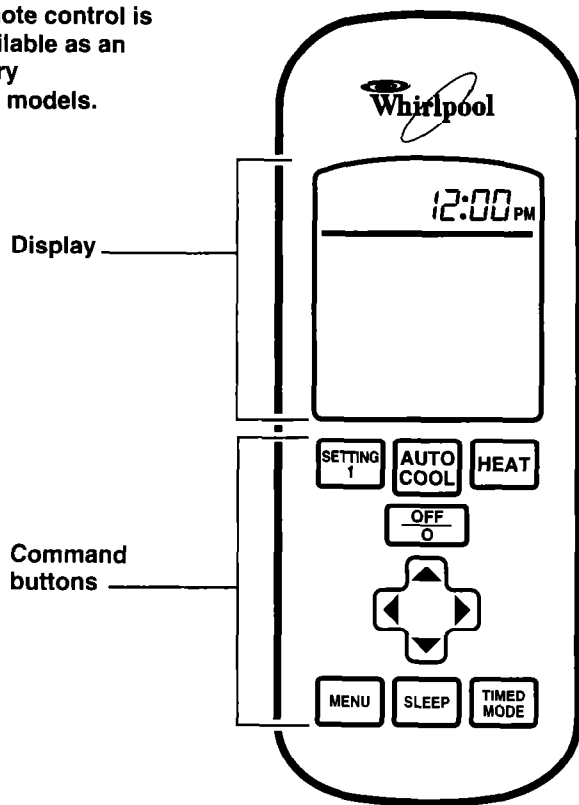

Operating Your Air Conditioner

In This Section

	Page		Page
Using the AUTO COOL Cycle	6	Using the SLEEP HOURS Cycle	10
Modifying the temperature	7	Using the TIMED OFF HOURS Cycle	11
Modifying the fan speed	7	Using the CHECK FILTER light	11
Using the AIR SWING feature	7	Modifying the air direction	12
Turning the unit off	8	Using the exhaust door	12
Using the HEAT ONLY Cycle	8	Using the remote control	12
Using the DRY ONLY Cycle	9		

Operating your air conditioner properly is essential to obtain the best possible results. This section tells you about each cycle and how to operate it.

IMPORTANT: After turning the unit off, wait approximately 3 minutes before turning it back on. If you don't wait approximately 3 minutes, the air conditioner will try to start, but turn itself off until the compressor is ready to start again.

DO NOT disconnect the air conditioner from its electrical supply. **DO NOT** use an electrical outlet that can be turned off with a switch. When the air conditioner is disconnected from its electrical supply (including power outages) all programming reverts back to the factory-preset information. However, the air conditioner will "relearn" your preferences.

Using the AUTO COOL Cycle

(Single-Button Cooling)

The AUTO COOL Cycle is designed to provide you with the comfort you desire by continually "learning" your preferences. Once the Cycle "learns" what temperature(s) you desire, it automatically chooses a fan speed when turned on and cools the room as quickly as possible.

NOTE: You can modify the fan speed and temperature when using the AUTO COOL Cycle, if desired. See "Modifying the fan speed" or "Modifying the temperature" on page 7.

To activate the AUTO COOL Cycle:

- Press the AUTO COOL/ON Button.

NOTE: When the cycle is active, the indicator light on the AUTO COOL/ON Button will be lit.

AUTO COOL BURST

AUTO COOL BURST cools the room for 15 minutes before allowing the room to rise to your prelearned temperature. This cycle is especially useful if you are hot from exercise or it is very hot in the room.

To activate AUTO COOL BURST:

- Press the AUTO COOL/ON Button twice.



Modifying the temperature

Although the AUTO COOL Cycle has an initial factory-preset cooling temperature, you may decide the room is too cool or too warm. When you change the temperature from the factory-preset, the air conditioner uses fuzzy logic (computerized "learning") to remember your preferences. Over time, the unit "learns" exactly what conditions make you most comfortable.

To modify the temperature:

- Press the WARMER Button to raise the temperature of the outgoing air.
- Press the COOLER Button to lower the temperature of the incoming air.

NOTE: Each press alters the temperature approximately 1°C.



Modifying the fan speed

Although the AUTO COOL Cycle automatically chooses the proper fan speed to cool the room, you may desire to increase or decrease the amount of air blowing into the room.

To modify the fan speed:

- Press the FAN SPEED Button.
- NOTE:** Each press of the FAN SPEED Button advances the fan speed through the cycle:

HI → MED → LOW → HI



Using the AIR SWING feature

The AIR SWING feature tells your air conditioner to move the air output louvers side-to-side and swing the cooled air through the room.

To activate the AIR SWING feature:

- Press the AIR SWING Button.

To deactivate the AIR SWING feature:

- Press the AIR SWING Button again.



Turning the unit off

To turn the unit off, simply press the OFF Button. This stops any currently-operating cycle and the unit completely shuts off.

NOTE: When turning unit off from the AUTO COOL Cycle, the air conditioner remembers any changes you made during the AUTO COOL Cycle and adjusts the cycle the next time you operate it.

IMPORTANT: After turning the unit off, wait approximately 3 minutes before turning it back on. If you don't wait 3 minutes, the air conditioner will try to start, but turn itself off until the compressor is ready to start again.

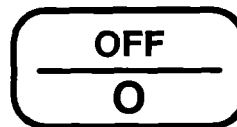

Using the HEAT ONLY Cycle

The HEAT ONLY Cycle allows your air conditioner to operate as a heater.

NOTE: Your air conditioner might turn off or not provide heating if the outside temperature is too low. This is normal and the unit will start to operate again after the outside temperature rises. The HEAT ONLY light might flash; press the HEAT ONLY button again to restore operation.

The automatic defrost cycle will turn off the fan, temperature indicators, and air swing for several minutes to de-ice the coils so that the unit can operate efficiently.

To activate the HEAT ONLY Cycle:

- Press the HEAT ONLY Button.

NOTE: When the cycle is active, the indicator light on the HEAT ONLY Button will be lit. When you first press the HEAT ONLY Button, the automatic defrost cycle might turn on.



To modify the fan speed:

- Press the FAN SPEED Button while the fan is running.

NOTE: Each press advances the fan speed:

LOW → HI → MED → LOW



To modify the temperature:

- Press the WARMER Button to raise the temperature of the room.



- Press the COOLER Button to lower the temperature of the room.



NOTE: Each press alters the temperature approximately 1°C.

To deactivate the HEAT ONLY Cycle:

You can deactivate the HEAT ONLY Cycle two ways:

- Press the OFF Button.
- OR**
- Activate another cycle (for example: AUTO COOL).

Using the DRY ONLY Cycle

The DRY ONLY Cycle allows your air conditioner to operate as a dehumidifier. It removes excess moisture from the room air without providing much cooling. The cycle is preset to operate most efficiently at LOW fan speed.

To activate the DRY ONLY Cycle:

- Press the DRY ONLY Button.
- NOTE:** When the cycle is active, the indicator light on the DRY ONLY Button will be lit.



To modify the fan speed:

- Press the FAN SPEED Button.
- NOTE:** Each press advances the fan speed:

LOW → HI → MED → LOW



To deactivate the DRY ONLY Cycle:

You can deactivate the DRY ONLY Cycle two ways:

- Press the OFF Button.
- OR**
- Activate another cycle (for example: AUTO COOL).

Using the SLEEP HOURS Cycle

The SLEEP HOURS Cycle allows your air conditioner to optimize your comfort while you're sleeping. The cycle allows the temperature of the room air to rise gradually until it reaches approximately 2°C above the set point temperature.

NOTE: The SLEEP Cycle can be set for cooling only.

Example shown for an 8-hour SLEEP HOURS Cycle with unit running in the AUTO COOL Cycle.

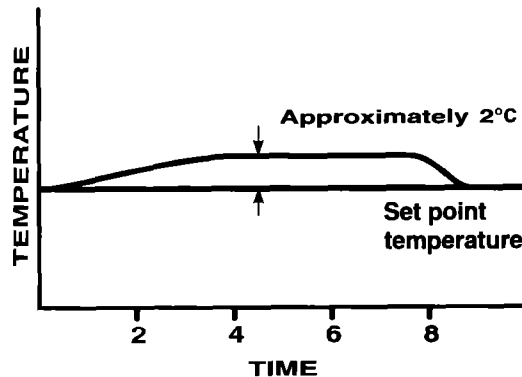

To activate the SLEEP HOURS Cycle:

- Press the SLEEP HOURS Button until the number for the desired time period is lit. The numbers above the SLEEP HOURS Button indicate the number of hours set for the cycle:

8 hours → 5 hours → 3 hours → OFF

IMPORTANT: If, at any time during the SLEEP HOURS Cycle, you are too cold or too warm, simply press the WARMER or COOLER Button. The unit “learns” to adjust to your preferences automatically. Therefore, the next time you activate the SLEEP HOURS Cycle, the air conditioner remembers your previous adjustment and modifies the temperature so you will not be too cold or too warm again.

After the SLEEP HOURS Cycle is complete, the unit initially cools the room (back to the set point temperature) then reverts back to the previously set cycle (AUTO COOL, OFF, etc.).



Using the TIMED OFF HOURS Cycle

The TIMED OFF HOURS Cycle allows you to program the air conditioner to turn itself off after a set period of time. Once the cycle is activated, the unit continues in the current operating cycle until the TIMED OFF HOURS Cycle is complete. Then the unit turns itself off.

EXAMPLE: If you are using the AUTO COOL Cycle and want to program the air conditioner to turn itself off in 3 hours, press the TIMED OFF HOURS Button until the 3 is lit above the button. The air conditioner will continue to operate in the AUTO COOL Cycle for another 3 hours, then turn itself off.

To activate the TIMED OFF HOURS Cycle:

- Press the TIMED OFF HOURS Button until the number for the desired time period is lit. The numbers above the button indicate the number of hours set for the cycle.

1 hour → 3 hours → 5 hours → OFF

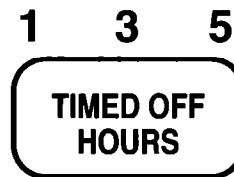

Using the CHECK FILTER light

The CHECK FILTER Indicator Light comes on approximately every 100 hours of operation. This light alerts you to check the air filter to see if it needs cleaning. If it does, see “Caring for the slide-out air filter” on page 15.



To deactivate the CHECK FILTER light:

- Press the OFF Button twice.

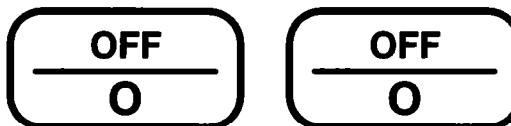

Modifying the air direction

The air output louvers, at the left side of the air conditioner's front panel, control the direction of the cooled air. The louvers may be adjusted up or down. To adjust the air left or right, you must activate the AIR SWING feature.

To activate the AIR SWING feature:

- Press the AIR SWING Button.

To deactivate the AIR SWING feature:

- Press the AIR SWING Button again.

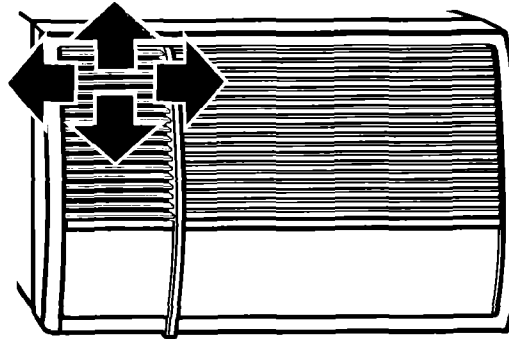

Using the exhaust door

The exhaust door allows the air conditioner to draw stale or smoky air from the room. Pull to open exhaust door or push to close.

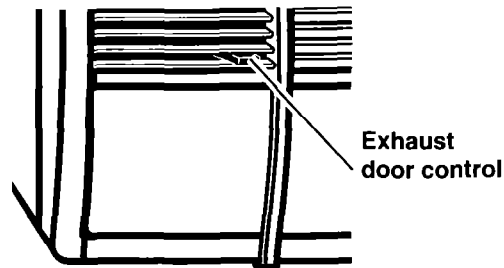

Using the remote control

The remote control must be used within a certain distance from the air conditioner. The following illustrations show the approximate areas in which the remote control will operate properly.

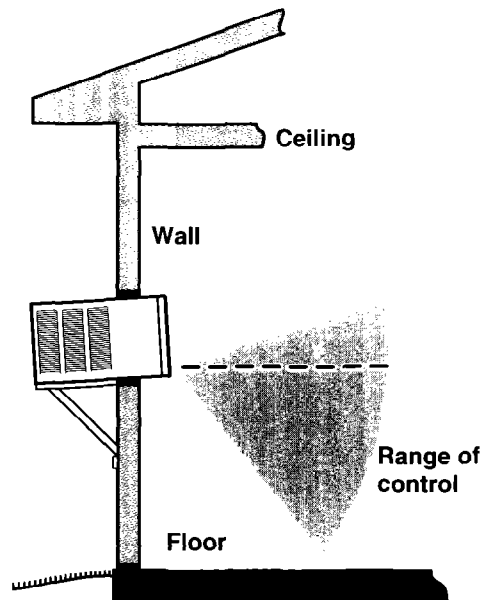
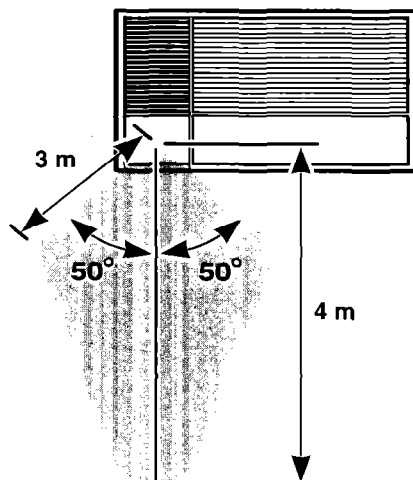

Personalizing the Front Panel

(available on select models)

The appearance of the front panel can be customized to suit your tastes or to match the room. The panel has two clear, protective plastic covers that you can remove. Then, place wallpaper, fabric, pictures, etc., in the open areas and replace the protective covers.

Removing the protective covers

1. Place the flat edge of a screwdriver into the 1 mm gap between the protective cover and the front panel.
2. Carefully pry off the protective cover.
3. Repeat for second protective cover.

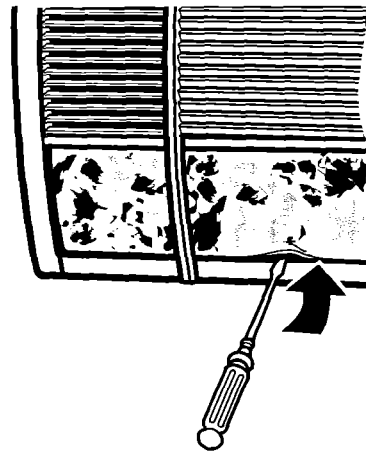

Replacing the protective covers

1. Insert tabs on one side of the protective cover into the tabs in the corresponding side of the front panel.
2. Snap the other side of the cover into place.
3. Repeat for second protective cover.

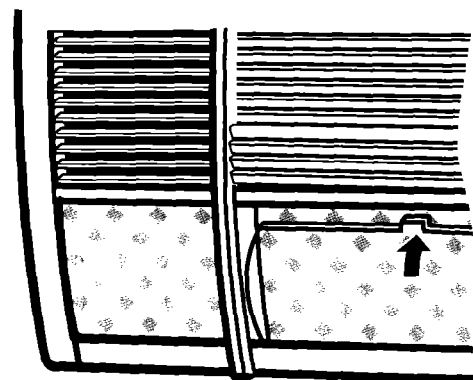

Caring for Your Air Conditioner

In This Section

	Page	Page	
Caring for the control panel	14	Caring for the slide-out air filter	15
Caring for the front panel, etc.	14	Performing annual coil cleaning	15

Proper maintenance of your air conditioner ensures longer life and lower operating costs. This section tells you how to clean your air conditioner and perform general maintenance. You can always call an authorized Whirlpool* service company for annual service.

Caring for the control panel

- Wipe clean with a soft, damp cloth. Make sure the cloth is not dripping wet.

The control panel door

If the control panel door pops out of place, it pops back into place easily.

1. Place the left door pin into the hole on the left side of the door opening.
2. Flex the door slightly.
3. Snap the right door pin into place.

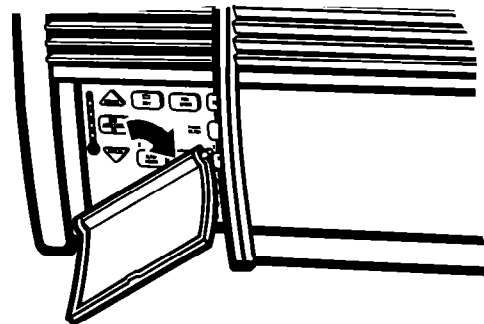

Caring for the front panel, etc.

Perform basic cleaning of the front panel by wiping it with a soft, dry cloth.

NOTE: Do not use abrasive or harsh cleaners on the front panel, especially on the protective plastic cover.

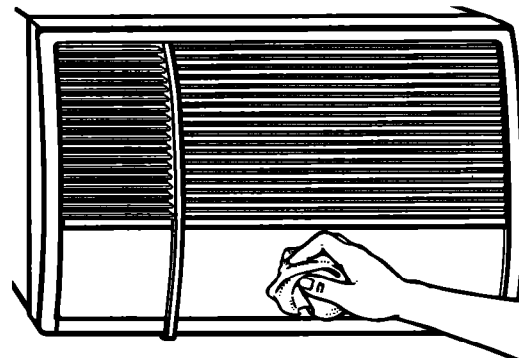

Caring for the slide-out air filter

The air filter helps remove dust, lint, and other particles from the air. The air filter is cleanable. Check the air filter every time you see the CHECK FILTER Indicator Light on the control panel.

1. Grasp the bottom edge of the front panel with both hands, as shown. There are 2 finger notches in the front panel behind the filter handle.
2. Slide the air filter forward and down until it releases from the front panel.
3. Clean the air filter using a vacuum cleaner.

OR

If it is very dirty, wash the filter with warm water and a mild detergent.

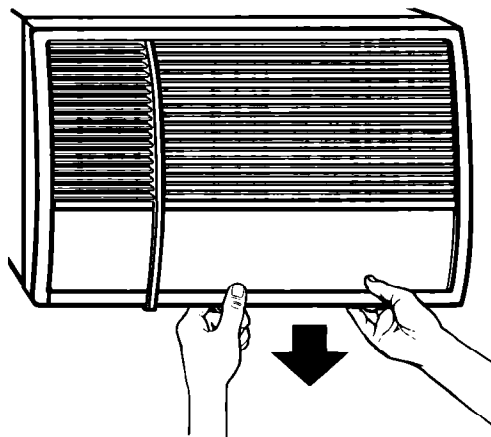

4. Slide filter up into the slot until filter is completely fitted.

NOTE: You may need to clean the air filter more often if it is subjected to heavy dust, dirt, etc.

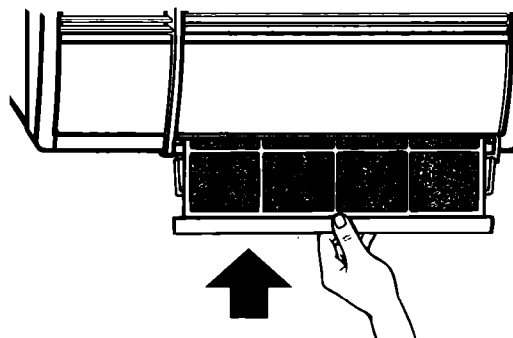

Performing annual coil cleaning

The coils in your air conditioner need to be cleaned annually to prolong the air conditioner's life and its cooling efficiency. As air moves over the coils, they collect dirt, sand, leaves, insects, algae, and other airborne particles.

Contact an authorized service company to perform this annual maintenance.

Installing Your Air Conditioner

In This Section	Page	Page	
General information	16	Installation procedure	18

General information

Location

Your air conditioner will work well in any location. However, the preferred location for the unit is on a wall out of direct sunlight. The location should also provide:

- Adequate support for the weight of the unit.
- An electrical outlet within reach of the power supply cord.
- Free movement of air to the room(s) to be cooled.
- Free movement of air to the air intake louvers (inside and outside).

The power supply cord can be fed through either side of the front panel.



Electrical outlet must be available within reach of the power supply cord. **DO NOT** use an extension cord.

Clearance

- Keep outside air intake louvers clear.

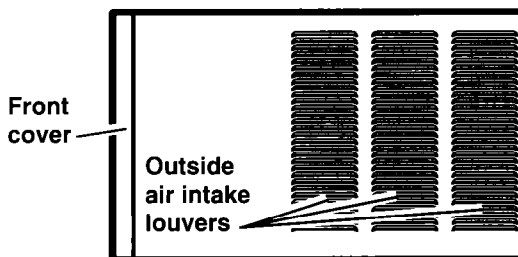

- If the wall is too thick, cut the wall back on a 45° angle if possible.

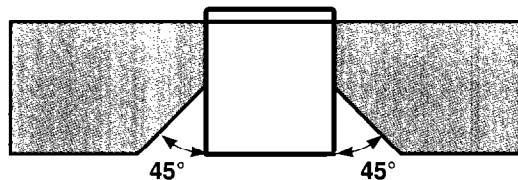

- Allow sufficient clearance around the sides and rear of the unit.

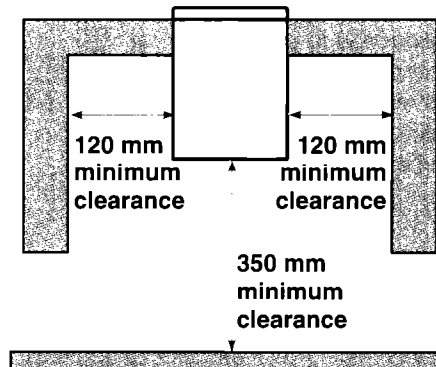

INSTALLING YOUR AIR CONDITIONER

- Provide adequate drainage.

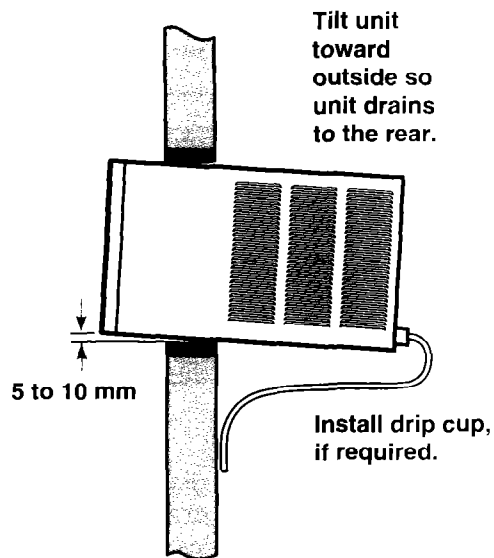

- Provide adequate clearance so the air filter can be removed from the bottom of the front panel.

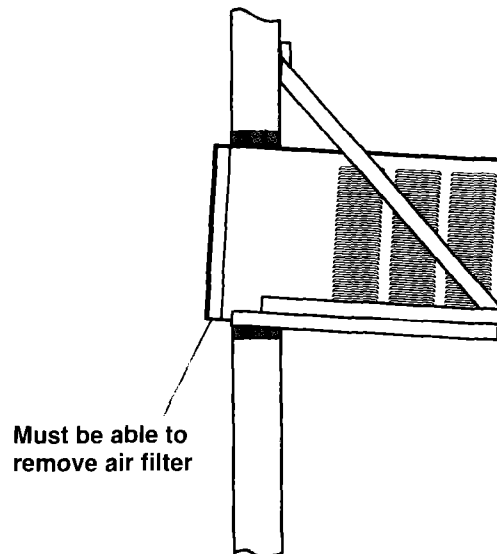

- Provide additional support for unit if required.

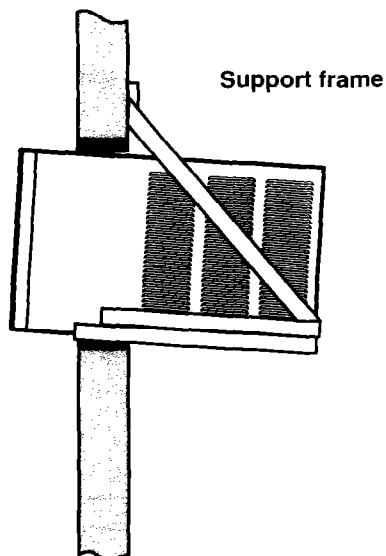

Electrical requirements

Check the model and serial number label to determine the electrical requirements of your unit. ALL units must use a time delay fuse or circuit breaker.

Grounding method

Your air conditioner is equipped with a power supply cord containing a 3-prong grounding plug. To minimize possible electrical shock hazard, the power supply cord must be plugged into a mating 3-prong, grounding-type wall receptacle, which is grounded in accordance with all applicable codes. If a mating wall receptacle is not available, it is the personal responsibility and obligation of the customer to have a properly grounded 3-prong wall receptacle installed by a qualified electrician.

Installation procedure

1. Remove the front panel. Remove tape (if any). Lift panel and take it off the cabinet.

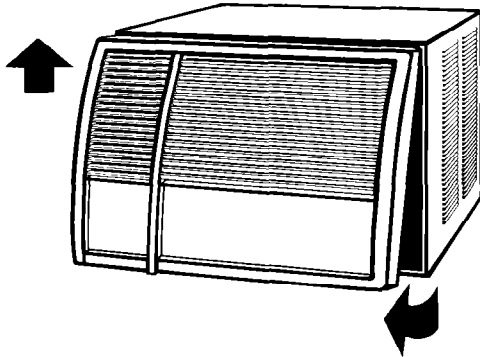

2. Remove the shipping brackets (2). Remove the cabinet ground screw (1) and disconnect the green and yellow grounding wire.

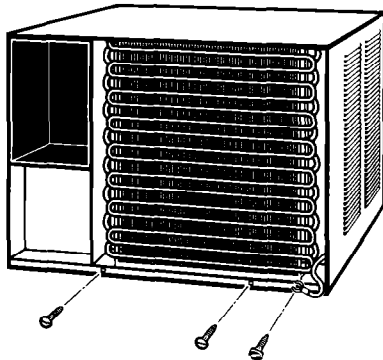

3. Remove the rear shipping screws (2).

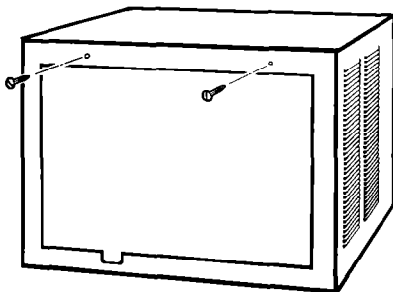

4. Slide the chassis out of the cabinet.

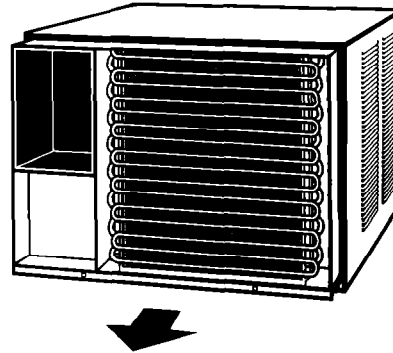

5. Install the drain plug and drain cup (accessory parts) to rear of cabinet. Slide drain cup down into rear support between grooves in cup.

NOTE: Attach drain plug and drain cup assemblies and attach hose before sliding unit into cabinet.

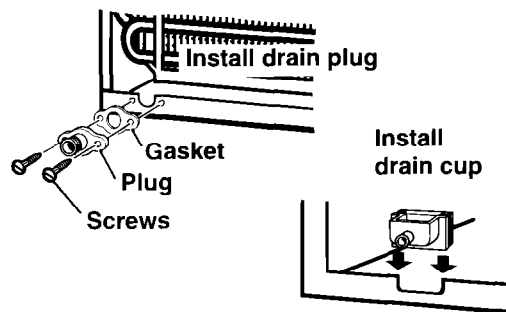

6. Fix the cabinet to the support frame.

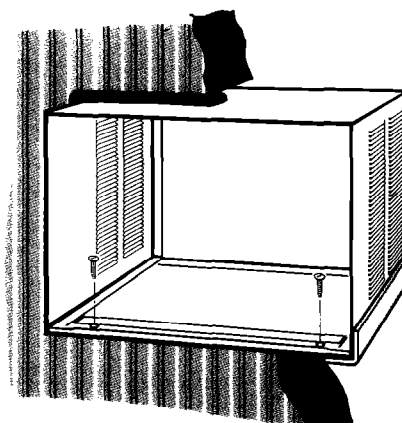

INSTALLING YOUR AIR CONDITIONER

7. Slide the chassis into the cabinet. Install the cabinet seal (accessory part) between the cabinet and the frame/wall.

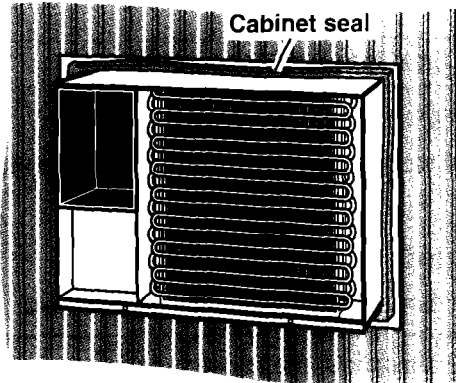

8. Reinstall the shipping bracket and attach with screws (2).

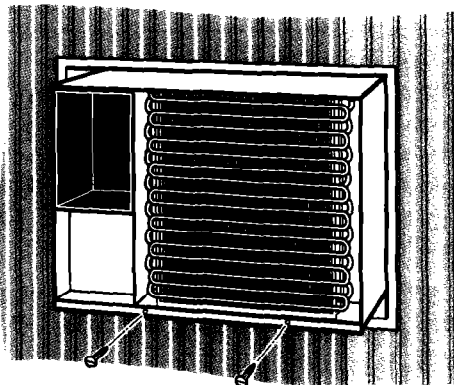

9. Reconnect the green and yellow grounding wire.

⚠ WARNING

Electrical Shock Hazard

Connect ground wire when unit is in cabinet.

Failure to do so will result in electrical shock.

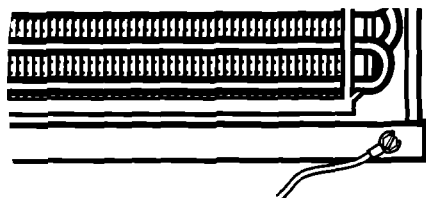

10. Remove slide-out filter from front panel. Replace the front panel. Insert tabs into slots on the top flange of the cabinet. Rotate the front panel downward until it fits snugly between cabinet side flanges. Secure front panel with 2 round-head screws (accessory parts). Replace slide-out air filter.

NOTE: Make sure the Exhaust Door Control lever is between the frame and the first air discharge louver before securing front panel with screws.

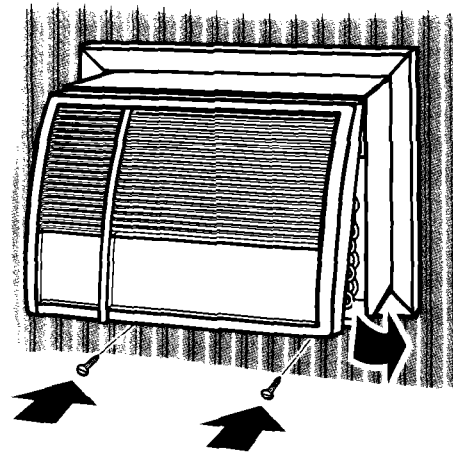

Troubleshooting

Performance problems often result from little things you can find and fix yourself, without tools of any kind. Check the chart below for problems you can fix. It could save you the cost of a service call.

PROBLEM	POSSIBLE SOLUTION
Unit won't run	<p>Make sure unit is plugged into a live circuit with proper voltage.</p> <p>Check if a household fuse has blown or the circuit breaker tripped.</p> <p>Make sure unit is turned on.</p> <p>See if the local power has failed.</p> <p>Wait at least 3 minutes after turning unit off before trying to restart.</p>
Unit blows household fuses or trips circuit breakers	<p>Check if a household fuse has blown or the circuit breaker tripped.</p> <p>Make sure an extension cord is not being used.</p> <p>Make sure unit is plugged into a live circuit with proper voltage.</p> <p>Wait at least 3 minutes after turning unit off before trying to restart.</p>
Unit stops/starts unexpectedly	<p>(Deluxe Remote Control models only.) Check if Delay Start or Delay Stop is programmed. See Deluxe Remote Control Owner's Manual for more information on these TIMED MODE operations.</p>
Unit stops/starts unexpectedly; temperature indicators off; fan, air swing, and temperature won't adjust	<p>(HEAT Cycle automatic defrost mode) The air conditioner might turn off or not provide heating if the outside temperature is below 5°C. The unit will start to operate again after the outside temperature rises.</p> <p>The automatic defrost cycle will turn off the fan for several minutes to de-ice the coils. The unit will restart after de-icing the coils.</p>
Unit stops/starts unexpectedly	<p>Whenever the air conditioner is disconnected from its power supply (even power outages), all programming reverts back to the factory-preset information. The unit will "relearn" your preferences.</p>
HEAT ONLY light is flashing	<p>The air conditioner might turn off if the outside temperature is below 5°C. After the outside temperature rises, the HEAT ONLY light may flash. Press the HEAT ONLY button to restore operation.</p>

Obtaining Service

If the problem is not due to an item listed in the chart above ...

Contact the dealer from whom you purchased the unit, an authorized Whirlpool® service company, or refer to the guarantee booklet included with your product.



Printed on recycled paper –
10% post-consumer waste
50% recovered materials

Free Manuals Download Website

<http://myh66.com>

<http://usermanuals.us>

<http://www.somanuals.com>

<http://www.4manuals.cc>

<http://www.manual-lib.com>

<http://www.404manual.com>

<http://www.luxmanual.com>

<http://aubethermostatmanual.com>

Golf course search by state

<http://golfingnear.com>

Email search by domain

<http://emailbydomain.com>

Auto manuals search

<http://auto.somanuals.com>

TV manuals search

<http://tv.somanuals.com>