

use & care guide

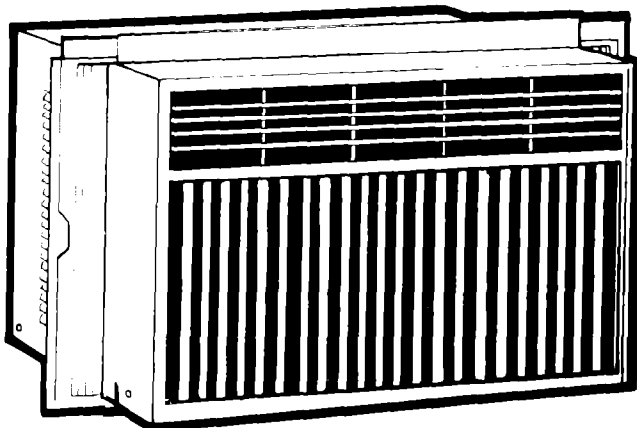

AIR CONDITIONER

Models ACP552XT
ACP602XT
AC0802XS
AC1052XS

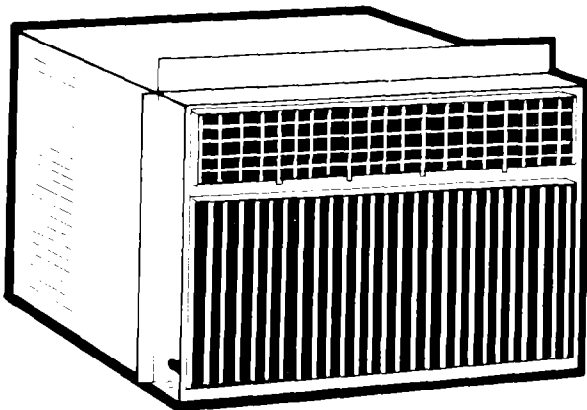

Freezers, Ice Makers, Dishwashers, Built-In Ovens and Surface Units, Ranges, Microwave Ovens, Trash Compactors, Room Air Conditioners, Dehumidifiers, Automatic Washers, Clothes Dryers, Freez

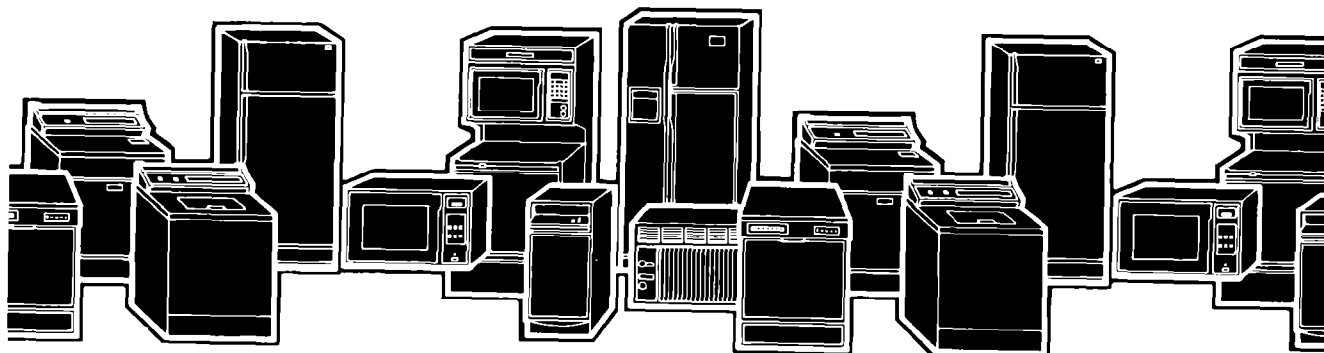

Contents

	Page		Page
BEFORE YOU USE YOUR AIR CONDITIONER	2	Cleaning Filter	5
Energy Saving Tips	3	Annual Maintenance	5
HOW TO START & USE YOUR AIR CONDITIONER	3	Do-It-Yourself Maintenance	5
To Start Your Air Conditioner	3	Oiling The Fan Motor	6
Using Exhaust Vent Control	4	IF YOU NEED SERVICE OR ASSISTANCE	7
Changing Air Direction	5	1. Before Calling For Assistance	7
Cleaning and Caring for Your Air Conditioner	4	2. If You Need Assistance	7
Cleaning Front Panel	4	3. If You Need Service	7
		4. If You Have A Problem	7
		5. If You Need FSP® Replacement Parts	7

©1989 Whirlpool Corporation

Copy your Model and Serial Numbers here...

When you need service or call with a question, have this information ready.

1. Complete Model and Serial Numbers.

To find Model and Serial Numbers remove the front panel (see page 4). The numbers are located on a label attached to the evaporator coil cover near the top of the unit.

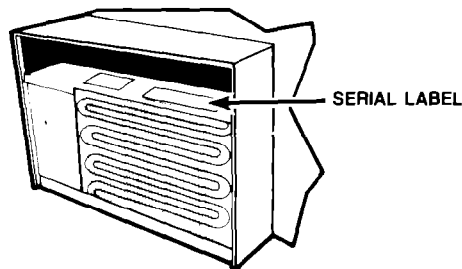

2. Purchase date from sales slip.

Copy this information in the spaces below. Keep this book, your INSTALLATION INSTRUCTIONS, and your sales slip together in a handy place.

Model Number

Serial Number

Purchase Date

Service Company Name and Telephone Number

BEFORE YOU USE YOUR AIR CONDITIONER

Read and carefully follow the "INSTALLATION INSTRUCTIONS" included with your air conditioner.

It is your responsibility to make sure that your air conditioner:

- Has been properly installed.
- Is the right size for the area you want to cool.
- Has been properly connected to electrical supply and grounded. (See INSTALLATION INSTRUCTIONS.)
- Is properly used only for the job for which it was designed.
- Is not used by anyone unable to operate it properly.
- Is properly maintained.

To remove the Consumer Buy Guide label and energy rating label lift one edge and pull straight off.

To remove any remaining glue:

1. Rub briskly with thumb to make a ball, then remove.
-OR-
2. Soak area with a liquid hand dishwashing detergent before removing glue as described in step 1.

Do not use rubbing alcohol or flammable toxic solvents, such as acetone, gasoline, carbon tetrachloride, etc. These can damage the material. Do not use a sharp instrument or any harsh or abrasive cleaners.

Energy Saving Tips

- Improve home insulation (seal doors, windows, and close fireplace flue).
- Close blinds or drapes on sunny side of house. Add window awnings.
- Keep air filter clean. Don't block air flow with drapes or furniture.
- Ventilate attic (high temperature levels add to normal cooling load).
- Try not to use heat producing appliances during the hottest part of the day. Turn lights, radios, televisions, and other appliances off when not needed.
- Keep heat registers and cool air returns closed or blocked off so cooled air won't escape.
- Use a vent fan in areas in cooking, laundry or bathing areas to pull out extra heat and moisture near its source.

HOW TO START AND USE YOUR AIR CONDITIONER

⚠ WARNING

Electrical Shock Hazard

Be sure air conditioner control is set to UNIT OFF before plugging in the unit. Do not use an extension cord. Plug unit only into a grounded electrical outlet. Failure to do so could result in personal injury.

To Start Your Air Conditioner

1. Set the **EXHAUST VENT CONTROL** to CLOSED for best cooling results.
2. Set the **FAN SPEED CONTROL** to the desired setting.

QUIET COOL for sleeping comfort
REGULAR COOL for normal cooling
MAX COOL for maximum cooling
FAN ONLY for air circulation only

EXHAUST VENT CONTROL

FAN SPEED CONTROL

THERMOSTAT



⚠ CAUTION

If you turn your air conditioner off, wait at least two minutes before turning it back on or you may blow a fuse or circuit breaker.

3. Turn **THERMOSTAT CONTROL** to the mid (Number 6) setting. You can adjust the air conditioner's cooling performance by resetting the thermostat control to a higher number for maximum cooling. Lower the thermostat for less cooling. You will need to experiment to find the setting which suits you best.

When lowering the thermostat control setting, the compressor (motor) may shut off. When the compressor is turned off with either the fan speed control or the thermostat control, wait 2-3 minutes before restarting the air conditioner or turning the compressor back on.

Using the Exhaust Vent Control

This control setting can be used to draw stale smoky air from the room, or to circulate air in the room without cooling.

1. To exhaust room air

Set control to **OPEN**. Set FAN SPEED CONTROL to desired setting. Set the fan control to **FAN ONLY** if no cooling is desired.



NOTE: Make sure the Exhaust Vent control is returned to the **CLOSED** setting when cooling or room air circulation is desired.

2. To circulate room air

Set control to **CLOSED**. Set FAN SPEED CONTROL to **FAN ONLY** if no cooling is desired.



Changing Air Direction

The louvers in the grille area at the top of the air conditioner control the direction of the cooled air.

The tabs at the top of the grille can be moved to the right, left or straight ahead. Move the tabs in the direction in which you want the air to flow.

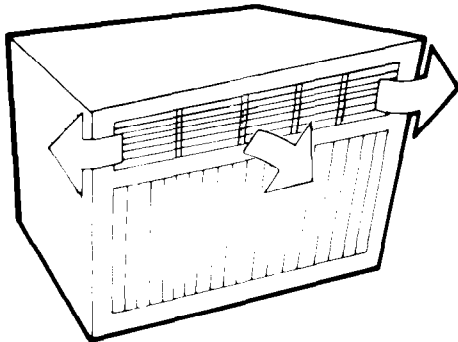

Cleaning and Caring for Your Air Conditioner

Proper use and care of your air conditioner will help insure longer life and lower operating costs. Follow these instructions carefully or call your dealer for an annual checkup.

Cleaning Front Panel

⚠ WARNING

Electrical Shock Hazard
Disconnect from electrical supply before cleaning unit. Failure to do so could result in personal injury.

1. Remove the front panel from unit for cleaning. Press down at top edge of the front as shown below.
2. When the front moves away from top of cabinet, pull top of front toward you.

3. Lift up and away from the bottom spring clips.

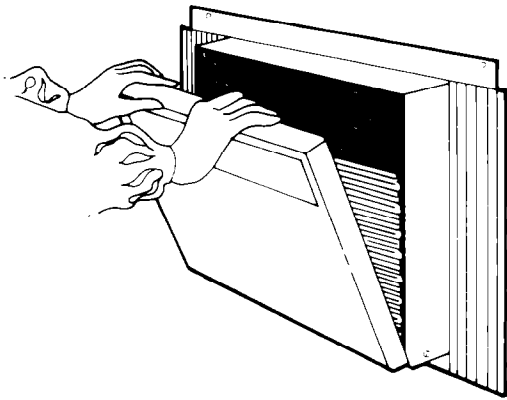

4. Remove and clean filter. (Follow instructions under "Cleaning Air Conditioner Filter.")
5. Clean front panel using a soft cloth with warm water and mild soap or detergent. Rinse and dry.
6. Wipe control panel clean with a soft dry cloth.
7. Replace front panel.

CAUTION

Do not use cleaning fluids, solvents, abrasive cleaners, or strong detergents. They may damage the parts.

Cleaning Air Conditioner Filter

The filter is cleanable. A clean filter helps remove dust, lint and other particles from the air. Check every two weeks to see if filter needs cleaning.

1. Remove front panel from unit. (Follow instructions under "Cleaning of Front Panel".) Remove filter from plastic front frame, by removing elastic band which holds it in place.

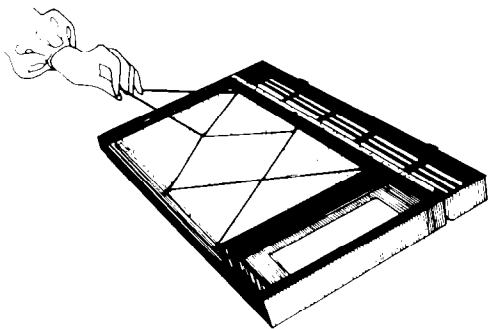

2. Clean filter, using a vacuum cleaner.

-OR-

3. If very dirty, wash filter with warm water and mild detergent. Air dry thoroughly before replacing.
4. Replace elastic band.

Annual Maintenance for Your Air Conditioner

Your air conditioner needs annual maintenance to help insure steady, top performance throughout the year.

Call the service company recommended by your dealer to:

- Inspect and clean the coils and condensate water passages.
- Check fan and oil the fan motor.

(The compressor is sealed and needs no oiling.)

Expense of annual inspection is customer's responsibility.

Do-It-Yourself Maintenance

If you are familiar with electrical appliances you can do the cleaning and maintenance yourself. If you decide to go ahead, follow these steps.

WARNING

Electrical Shock Hazard

Disconnect power cord from receptacle before performing any maintenance. Be sure no liquid gets into the motor, electrical control box or compressor electrical terminals. Failure to follow the above precautions could result in personal injury.

1. Remove unit from window.
2. Remove front panel. (See page 4)
3. Remove side curtains. Slide curtains out to fullest width. From the back side, remove the phillips head screws (A) which attach the curtains to the cabinet.
4. Remove slotted/hex head screws (B) holding top channel.
5. Remove slotted/hex head screws (C) on the sides of the cabinet.

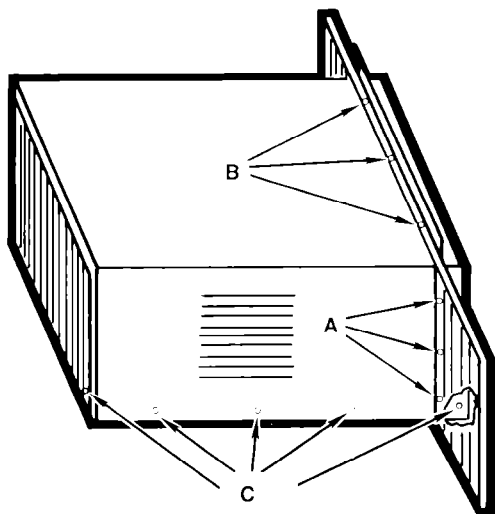

NOTE: Number of screws may vary with model

6. Holding the cabinet on both sides, carefully lift it off the unit.
7. Wrap the motor, electrical control box and compressor terminals box in plastic film and **make sure no water or other liquid gets inside any of these parts.** It would damage insulation and cause serious mechanical problems.

⚠ WARNING

Personal Injury Hazard

The metal fins on the coils are sharp. Handle the air conditioner with care. Failure to do so could result in personal injury.

8. Carefully clean and hose out the base, coils and condensate pans. Clean at least once a year, or more often if the condenser coils and pans collect dirt, sand, leaves, insects or algae. Also, clean if you detect an odor coming from the air conditioner. (A good time to oil the motor is when you already have the cabinet open. See instructions that follows.)
9. Remove plastic film from motor and electrical parts.
10. Replace unit in cabinet.
11. Reattach ground wire. Replace control plate and knobs.
12. Replace front panel.

NOTE: It is best to wait 24 hours before starting the unit again. This allows all areas to dry out. (The water from rainfall or from normal operation does not harm these components.)

Oiling the Fan Motor

⚠ WARNING

Electrical Shock Hazard

Disconnect power cord from receptacle before oiling motor. Failure to do so could result in personal injury.

1. Remove unit from cabinet. (Follow instructions under "Do-It-Yourself Maintenance.")
2. Oil the fan motor following instructions on the fan motor. To add oil, pull out the oil hole plug at each end of the motor. Use SAE number 20 non-detergent oil or an easy to use one-ounce capsule of specially recommended oil can be ordered from your dealer. (Part no. 10943).

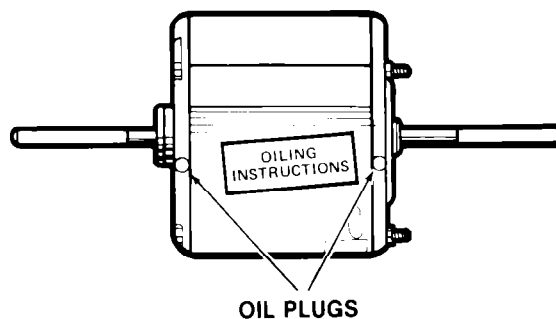

3. Replace the plugs to keep dirt from motor bearings.
4. Replace unit in cabinet.

If you need service or assistance, we suggest you follow these five steps:

1. Before calling for assistance

Performance problems often result from little things you can find and fix yourself without tools of any kind.

Air conditioner won't run

1. Is unit plugged into a live circuit with proper voltage?
2. Is switch turned on?
3. Is thermostat set correctly?
4. Have you checked your home's main fuses or circuit breaker box?
5. Has the time-delay fuse blown?
6. Has the local power failed?

Unit blows fuses:

1. Are time-delay fuses being used?
2. Is an extension cord being used? (**Do not use an extension cord to run your air conditioner.**)
3. Are you waiting two minutes after turning cooling circuit off before trying to restart unit?

Unit turns on and off, or does not cool room:

1. Is filter clean?
2. Are coils clean (both evaporator [inside] and condenser [outside])?
3. Is there excessive moisture or heat (open vessel cooking, showers, etc.)?
4. Try setting fan to higher speed.
5. Try setting thermostat to a cooler setting.

Operating sounds:

1. When your room air conditioner is **operating normally**, you will hear sounds such as:
 - Droplets of water hitting the condenser, causing a "pinging" or "clicking" sound. Water droplets help to cool the condenser.
 - Air movement from the fan, especially on high fan speed setting.
 - Clicks from the thermostat cycle.
2. Sounds also may be caused by house construction - such as vibration of the unit due to wall construction or unsteady window mounting area.

2. If you need assistance*...

CALL Whirlpool COOL-LINE® service assistance telephone number. Dial free from anywhere in the U.S.:

1-800-253-1301

and talk with one of our trained Consultants. The consultant can instruct you in how to obtain satisfactory operation from your appliance or, if service is necessary, recommend a qualified service company in your area.

3. If you need service*...



Whirlpool has a nationwide network of franchised TECH-CARE® Service Companies. TECH-CARE service technicians are trained to fulfill the product warranty and provide after-warranty service, anywhere in the United States. To locate TECH-CARE service in

your area. Call our COOL-LINE service assistance telephone number (see Step 2) or look in your telephone directory Yellow Pages under

APPLIANCES - HOUSEHOLD — MAJOR - SERVICE & REPAIR	ELECTRICAL APPLIANCES — MAJOR - REPAIRING & PARTS
OR	
<small>WHIRLPOOL APPLIANCES FRANCHISED TECH-CARE SERVICE SERVICE COMPANIES XYZ SERVICE CO 123 Maple</small>	<small>WHIRLPOOL APPLIANCES FRANCHISED TECH-CARE SERVICE SERVICE COMPANIES XYZ SERVICE CO 123 Maple</small>
OR	
WASHING MACHINES, DRYERS & IRONERS - SERVICING	
<small>WHIRLPOOL APPLIANCES FRANCHISED TECH-CARE SERVICE SERVICE COMPANIES XYZ SERVICE CO 123 Maple</small>	

4. If you have a problem*...

Call our COOL-LINE service assistance telephone number (see Step 2) and talk with one of our Consultants, or if you prefer, write to:

Mr. Donald Skinner
 Director of Customer Relations
 Whirlpool Corporation
 2000 M-63
 Benton Harbor, MI 49022

5. If you need FSP® replacement parts*...

FSP is a registered trademark of Whirlpool Corporation for quality parts. Look for this symbol of quality whenever you need a replacement part for your Whirlpool appliance. FSP replacement parts will fit right and work right, because they are made to the same exacting specifications used to build every new Whirlpool appliance.

To locate FSP replacement parts in your area, refer to Step 3 above or call the Whirlpool COOL-LINE service assistance number in Step 2.

*If you must call or write, please provide: **model number, serial number, date of purchase**, and a **complete description of the problem**. This information is needed in order to better respond to your request for assistance.

WHIRLPOOL ROOM AIR CONDITIONER WARRANTY

AC001

LENGTH OF WARRANTY	WHIRLPOOL WILL PAY FOR						
FULL ONE-YEAR WARRANTY From Date of Purchase	FSP® replacement parts and repair labor to correct defects in materials or workmanship.						
FULL FIVE-YEAR WARRANTY From Date of Purchase	FSP replacement parts and repair labor to correct defects in materials or workmanship in the sealed refrigeration system. These parts are: <table style="margin-left: 20px; border: none;"> <tr> <td style="padding-right: 20px;">1. Compressor</td> <td>4. Drier-Strainer</td> </tr> <tr> <td>2. Evaporator</td> <td>5. Connecting tubing</td> </tr> <tr> <td>3. Condenser</td> <td></td> </tr> </table>	1. Compressor	4. Drier-Strainer	2. Evaporator	5. Connecting tubing	3. Condenser	
1. Compressor	4. Drier-Strainer						
2. Evaporator	5. Connecting tubing						
3. Condenser							
WHIRLPOOL WILL NOT PAY FOR							
<table style="border: none;"> <tr> <td style="vertical-align: top; padding-right: 10px;"> A. Service calls to: <ol style="list-style-type: none"> 1. Correct the installation of the air conditioner. 2. Instruct you how to use the air conditioner. 3. Replace house fuses or correct house wiring. 4. Clean or replace air filter. </td> <td style="vertical-align: top; padding-right: 10px;"> B. Pick up and delivery. This product is designed to be repaired in the home. </td> <td style="vertical-align: top; padding-right: 10px;"> C. Damage to the air conditioner caused by accident, misuse, fire, flood, acts of God or use of products not approved by Whirlpool. </td> <td style="vertical-align: top;"> D. The removal and reinstallation of the air conditioner if it is installed in an overhead or other inaccessible location or not installed in accordance with published installation instructions. </td> </tr> </table>		A. Service calls to: <ol style="list-style-type: none"> 1. Correct the installation of the air conditioner. 2. Instruct you how to use the air conditioner. 3. Replace house fuses or correct house wiring. 4. Clean or replace air filter. 	B. Pick up and delivery. This product is designed to be repaired in the home.	C. Damage to the air conditioner caused by accident, misuse, fire, flood, acts of God or use of products not approved by Whirlpool.	D. The removal and reinstallation of the air conditioner if it is installed in an overhead or other inaccessible location or not installed in accordance with published installation instructions.		
A. Service calls to: <ol style="list-style-type: none"> 1. Correct the installation of the air conditioner. 2. Instruct you how to use the air conditioner. 3. Replace house fuses or correct house wiring. 4. Clean or replace air filter. 	B. Pick up and delivery. This product is designed to be repaired in the home.	C. Damage to the air conditioner caused by accident, misuse, fire, flood, acts of God or use of products not approved by Whirlpool.	D. The removal and reinstallation of the air conditioner if it is installed in an overhead or other inaccessible location or not installed in accordance with published installation instructions.				

Service under the full warranties must be provided by a franchised TECH-CARE® service company.

WHIRLPOOL CORPORATION SHALL NOT BE LIABLE FOR INCIDENTAL OR CONSEQUENTIAL DAMAGES. Some states do not allow the exclusion or limitation of incidental or consequential damages so this limitation or exclusion may not apply to you. This warranty gives you specific legal rights, and you may also have other rights which vary from state to state.

Outside the United States, a different warranty may apply. For details, please contact your franchised Whirlpool distributor or military exchange.



Free Manuals Download Website

<http://myh66.com>

<http://usermanuals.us>

<http://www.somanuals.com>

<http://www.4manuals.cc>

<http://www.manual-lib.com>

<http://www.404manual.com>

<http://www.luxmanual.com>

<http://aubethermostatmanual.com>

Golf course search by state

<http://golfingnear.com>

Email search by domain

<http://emailbydomain.com>

Auto manuals search

<http://auto.somanuals.com>

TV manuals search

<http://tv.somanuals.com>